

Peplink Balance Multi-WAN Routers

Model 20/30/210/310/380/580/710/1350

User Manual

Firmware 5.3

July 2011



Copyright & Trademarks Specifications are subject to change without prior notice. Copyright © 2011 Peplink International Ltd. All Rights Reserved. Peplink and the Peplink logo are trademarks of Peplink International Ltd. Other brands or products mentioned may be trademarks or registered trademarks of their respective owners.

Table of Contents

| | | |
|-----------|--|-----------|
| 1 | INTRODUCTION AND SCOPE | 5 |
| 2 | GLOSSARY | 6 |
| 3 | PRODUCT COMPARISON CHART | 7 |
| 4 | PRODUCT FEATURES | 11 |
| 4.1 | Supported Network Features | 11 |
| 4.2 | Other Supported Features | 12 |
| 5 | PACKAGE CONTENTS | 13 |
| 5.1 | Peplink Balance 20 / 30 | 13 |
| 5.2 | Peplink Balance 210 / 310 | 13 |
| 5.3 | Peplink Balance 380 / 580 / 710 / 1350 | 13 |
| 6 | PEPLINK BALANCE OVERVIEW | 14 |
| 6.1 | Peplink Balance 20 | 14 |
| 6.2 | Peplink Balance 30 | 16 |
| 6.3 | Peplink Balance 210 | 18 |
| 6.4 | Peplink Balance 310 | 20 |
| 6.5 | Peplink Balance 380 | 22 |
| 6.6 | Peplink Balance 580 | 25 |
| 6.7 | Peplink Balance 710 | 28 |
| 6.8 | Peplink Balance 1350 | 31 |
| 7 | INSTALLATION | 34 |
| 7.1 | Preparation | 34 |
| 7.2 | Constructing the Network | 34 |
| 7.3 | Configuring the Network Environment | 35 |
| 8 | BASIC CONFIGURATION | 36 |
| 8.1 | Connecting to Web Admin Interface | 36 |
| 8.2 | Configuration with Setup Wizard | 37 |
| 8.3 | Advanced Setup | 40 |
| 9 | CONFIGURATION OF LAN INTERFACE | 41 |
| 10 | DROP-IN MODE | 45 |
| 11 | CONFIGURATION OF WAN INTERFACE(S) | 48 |
| 11.1 | Connection Method(s) | 50 |
| 11.2 | Physical Interface Settings | 59 |
| 11.3 | WAN Health Check | 60 |
| 11.4 | Bandwidth Allowance Monitor | 63 |
| 11.5 | Additional Public IP Settings | 64 |
| 11.6 | Dynamic DNS Settings | 65 |
| 12 | SITE-TO-SITE VPN | 66 |

| | | |
|-----------|--|------------|
| 12.1 | Site-to-Site VPN Settings | 66 |
| 12.2 | Peplink Balance Behind NAT Router | 69 |
| 12.3 | VPN Status | 70 |
| 13 | MANAGEMENT OF OUTBOUND TRAFFIC TO WAN | 71 |
| 13.1 | Outbound Policy | 72 |
| 13.2 | Custom Rules For Outbound Policy | 73 |
| 14 | INBOUND ACCESS | 79 |
| 14.1 | Definition of Port Forwarding | 79 |
| 14.2 | Definition of Servers on LAN | 81 |
| 14.3 | Inbound Access Services | 82 |
| 14.4 | UPnP / NAT-PMP Settings | 84 |
| 14.5 | Definition of DNS Records | 85 |
| 14.6 | Reverse Lookup Zones | 96 |
| 14.7 | DNS Record Import Wizard | 99 |
| 15 | NAT MAPPINGS | 101 |
| 16 | WLAN CONTROLLER | 103 |
| 16.1 | WLAN Information | 103 |
| 16.2 | AP Management | 106 |
| 16.3 | Wireless Networks | 107 |
| 16.4 | Captive Portal Management | 111 |
| 16.5 | AP Profile | 118 |
| 17 | QOS | 121 |
| 17.1 | User Groups | 121 |
| 17.2 | Bandwidth Control | 122 |
| 17.3 | Application | 123 |
| 18 | FIREWALL | 125 |
| 18.1 | Outbound and Inbound Firewall | 125 |
| 18.2 | Web Blocking | 130 |
| 19 | MISCELLANEOUS SETTINGS | 131 |
| 19.1 | High Availability | 131 |
| 19.2 | PPTP Server | 134 |
| 19.3 | Service Forwarding | 136 |
| 19.4 | Service Passthrough | 138 |
| 20 | SYSTEM SETTINGS | 139 |
| 20.1 | Admin Security | 139 |
| 20.2 | Firmware Upgrade | 143 |
| 20.3 | Time | 144 |
| 20.4 | Email Notification | 145 |
| 20.5 | Remote Syslog | 147 |
| 20.6 | SNMP | 148 |
| 20.7 | Reporting Server | 150 |
| 20.8 | Configuration | 152 |

| | | |
|-----------|--|------------|
| 20.9 | Reboot..... | 153 |
| 20.10 | Ping Test..... | 154 |
| 20.11 | Traceroute Test..... | 155 |
| 20.12 | VPN Test..... | 155 |
| 21 | STATUS | 156 |
| 21.1 | Device | 156 |
| 21.2 | Active Sessions..... | 157 |
| 21.3 | Client List | 157 |
| 21.4 | Access Point | 158 |
| 21.5 | WINS Client..... | 158 |
| 21.6 | Site-to-Site VPN..... | 158 |
| 21.7 | UPnP / NAT-PMP..... | 160 |
| 21.8 | Event Log..... | 161 |
| 21.9 | Bandwidth | 162 |
| | APPENDIX A. RESTORATION OF FACTORY DEFAULTS..... | 165 |
| | APPENDIX B. ROUTING UNDER DHCP, STATIC IP, AND PPPOE..... | 166 |
| B.1 | Routing via Network Address Translation (NAT)..... | 166 |
| B.2 | Routing via IP Forwarding | 167 |
| | APPENDIX C. CASE STUDIES | 168 |
| C.1 | Performance Optimization | 168 |
| C.2 | Maintaining the Same IP Address throughout a Session..... | 170 |
| C.3 | Bypassing the Firewall to Access Hosts on LAN..... | 171 |
| C.4 | Inbound Access Restriction | 172 |
| C.5 | Outbound Access Restriction | 173 |
| | APPENDIX D. TROUBLESHOOTING | 174 |
| | APPENDIX E. PRODUCT SPECIFICATIONS | 176 |
| E.1 | Peplink Balance 20 and 30..... | 176 |
| E.2 | Peplink Balance 210 and 310..... | 177 |
| E.3 | Peplink Balance 380..... | 178 |
| E.4 | Peplink Balance 580..... | 179 |
| E.5 | Peplink Balance 710..... | 180 |
| E.6 | Peplink Balance 1350..... | 181 |

1 Introduction and Scope

The Peplink Balance series provides link aggregation and load balancing across up to thirteen WAN connections.

The Peplink Balance 20/30 provides a cost-effective solution suitable for power users and home offices.

The Peplink Balance 210/310 provides advanced features for small business.

The Peplink Balance 380, 580, 710 and 1350, with a suite of advanced enterprise-class features, make ideal single-box solutions for medium to large-sized business environments, and allow service providers to enable highly available multi-network services.

This manual applies to the following Peplink Balance products:

- Peplink Balance 20/30 (firmware version v5.3.x) ****Will be available in June 2011**
- Peplink Balance 210/310 (firmware version v5.3.x)
- Peplink Balance 380 (firmware version v5.3.x)
- Peplink Balance 580 (firmware version v5.3.x)
- Peplink Balance 710 (firmware version v5.3.x)
- Peplink Balance 1350 (firmware version v5.3.x)

The manual presents how-to set up Peplink Balance, and provides a collection of case studies involving advanced features of Peplink Balance.

Important Note to Users Upgrading from Firmware 4.7 or below

If your current firmware version is 4.7 or below, please upgrade to Firmware 4.8.2 first before upgrading to Firmware 5.3.

Important Note to Users of Peplink Balance 30 (Classic Edition)

Firmware 5.0 or above is NOT applicable to Peplink Balance 30 (Classic Edition). For more information of identifying the generation of your Peplink Balance 30, please visit our knowledge base at <http://www.peplink.com/index.php?view=faq&id=231&path=16>.

2 Glossary

The following terms, acronyms, and abbreviations are frequently used in this manual:

| Term | Definition |
|--------------------|--|
| 3G | 3rd Generation family of standards for wireless communications |
| DHCP | Dynamic Host Configuration Protocol |
| DNS | Domain Name System |
| EVDO | Evolution-Data Optimized |
| HSDPA | High-Speed Downlink Packet Access |
| GRE | Generic Routing Encapsulation |
| HTTP | Hyper-Text Transfer Protocol |
| ICMP | Internet Control Message Protocol |
| IP | Internet Protocol |
| LAN | Local Area Network |
| MAC Address | Media Access Control Address |
| MTU | Maximum Transmission Unit |
| MSS | Maximum Segment Size |
| NAT | Network Address Translation |
| PPPoE | Point to Point Protocol over Ethernet |
| QoS | Quality of Service |
| SNMP | Simple Network Management Protocol |
| TCP | Transmission Control Protocol |
| UDP | User Datagram Protocol |
| VPN | Virtual Private Network |
| VRRP | Virtual Router Redundancy Protocol |
| WAN | Wide Area Network |
| WINS | Windows Internet Name Service |
| WLAN | Wireless Local Area Network |
| 210+ | Refer to Peplink Balance 210/310/380/580/710/1350 |
| 380+ | Refer to Peplink Balance 380/580/710/1350 |

3 Product Comparison Chart

| Features | 20 | 30 | 210 | 310 | 380 | 580 | 710 | 1350 |
|----------------------------|----------------------|------|----------------|------|-------------------|----------|------------------|------------|
| Customer Group | Home and Home Office | | Small Business | | Mid-Size Business | | Large Enterprise | |
| Capacity | | | | | | | | |
| WAN Ports / Internet Links | 2 | 3 | 2 | 3 | 3 (GbE) | 5 (GbE) | 7 (3x GbE) | 13 (GbE) |
| Recommended Users | 1-25 | 1-25 | 1-50 | 1-50 | 50-500 | 300-1000 | 500-2000+ | 1000-5000+ |
| Router Throughput | 50M | 50M | 50M | 50M | 170M | 250M | 350M | 1500M |
| Core Functionality | | | | | | | | |
| Load Balancing & Failover | Yes | Yes | Yes | Yes | Yes | Yes | Yes | Yes |
| Load Balancing Algorithms | 5 | 5 | 7 | 7 | 7 | 7 | 7 | 7 |
| • Weighted | Yes | Yes | Yes | Yes | Yes | Yes | Yes | Yes |
| • Enforced | Yes | Yes | Yes | Yes | Yes | Yes | Yes | Yes |
| • Persistence | Yes | Yes | Yes | Yes | Yes | Yes | Yes | Yes |
| • Priority | Yes | Yes | Yes | Yes | Yes | Yes | Yes | Yes |
| • Overflow | Yes | Yes | Yes | Yes | Yes | Yes | Yes | Yes |
| • Least Used | X | X | Yes | Yes | Yes | Yes | Yes | Yes |
| • Lowest Latency | X | X | Yes | Yes | Yes | Yes | Yes | Yes |
| Drop-In Mode | X | X | Yes | Yes | Yes | Yes | Yes | Yes |
| Inbound Load Balancing | X | X | Yes | Yes | Yes | Yes | Yes | Yes |

| | | | | | | | | | |
|--|-----|-----|-----|-----|-----|-----|------|------|--|
| 3G Modem Support | Yes | Yes | X | X | Yes | Yes | Yes | Yes | |
| VPN Functionality | | | | | | | | | |
| Site to Site VPN Bonding | X | X | Yes | Yes | Yes | Yes | Yes | Yes | |
| Number of S2S VPN Peers | X | X | 2 | 2 | 20 | 50 | 300 | 800 | |
| Bonded VPN Throughput | X | X | 30M | 30M | 60M | 80M | 150M | 350M | |
| PPTP VPN Server | X | X | Yes | Yes | Yes | Yes | Yes | Yes | |
| Recommended PPTP VPN Users | X | X | 15 | 15 | 50 | 100 | 200 | 500 | |
| RADIUS / LDAP support for PPTP | X | X | X | X | Yes | Yes | Yes | Yes | |
| WLAN Control Functionality | | | | | | | | | |
| Manage Pepwave AP One | X | X | X | X | Yes | Yes | Yes | Yes | |
| Access Point Configuration | X | X | X | X | Yes | Yes | Yes | Yes | |
| Number of AP Support | X | X | X | X | 50 | 100 | 250 | 500 | |
| Advanced QoS Functionality | | | | | | | | | |
| Bandwidth Usage Monitor | X | X | Yes | Yes | Yes | Yes | Yes | Yes | |
| QoS for VoIP and E-Commerce | Yes | Yes | Yes | Yes | Yes | Yes | Yes | Yes | |
| Application Prioritization | X | X | Yes | Yes | Yes | Yes | Yes | Yes | |
| Application Prioritization by User Group | X | X | X | X | Yes | Yes | Yes | Yes | |
| User Group Bandwidth Reservation | X | X | X | X | Yes | Yes | Yes | Yes | |

| | | | | | | | | |
|---------------------------------|-----|-----|-----|-----|-----|-----|-----|-----|
| Individual Bandwidth Limit | X | X | X | X | Yes | Yes | Yes | Yes |
| Networking Functionality | | | | | | | | |
| NAT and IP Forwarding | Yes | Yes | Yes | Yes | Yes | Yes | Yes | Yes |
| Configurable Static Routes | Yes | Yes | Yes | Yes | Yes | Yes | Yes | Yes |
| Port Forwarding | Yes | Yes | Yes | Yes | Yes | Yes | Yes | Yes |
| Many to One, One to One NAT | Yes | Yes | Yes | Yes | Yes | Yes | Yes | Yes |
| UPnP, NAT-PMP | Yes | Yes | Yes | Yes | Yes | Yes | Yes | Yes |
| WINS Server | Yes | Yes | Yes | Yes | Yes | Yes | Yes | Yes |
| Dynamic DNS | Yes | Yes | Yes | Yes | Yes | Yes | Yes | Yes |
| Web Blocking | X | X | X | X | Yes | Yes | Yes | Yes |
| Device Management Functionality | | | | | | | | |
| Web Administrative Interface | Yes | Yes | Yes | Yes | Yes | Yes | Yes | Yes |
| Email Notification | Yes | Yes | Yes | Yes | Yes | Yes | Yes | Yes |
| Client List | Yes | Yes | Yes | Yes | Yes | Yes | Yes | Yes |
| Bandwidth Usage Statistics | Yes | Yes | Yes | Yes | Yes | Yes | Yes | Yes |
| Web Reporting Services | Yes | Yes | Yes | Yes | Yes | Yes | Yes | Yes |
| Email Notification | Yes | Yes | Yes | Yes | Yes | Yes | Yes | Yes |
| Syslog | Yes | Yes | Yes | Yes | Yes | Yes | Yes | Yes |
| SNMP v1, v2c and v3 | Yes | Yes | Yes | Yes | Yes | Yes | Yes | Yes |

| Hardware Features | | | | | | | | |
|-----------------------|--------------------------|----------------------------|--------------------|--------------------|--------------------|--------------------|--------------------|--------------------|
| LAN Ports | 4 | 4 | 4 | 4 | 1 (GbE) | 1 (GbE) | 1 (GbE) | 1 (GbE) |
| Power Input | 100V to 240V AC | 100V to 240V AC | 100V to 240V AC | 100V to 240V AC | 100V to 240V AC | 100V to 240V AC | 100V to 240V AC | 100V to 240V AC |
| Power Consumption | 15W | 15W | 15W | 15W | 50W | 50W | 70W | 70W |
| 1U Rackmount | X | X | Yes | Yes | Yes | Yes | Yes | Yes |
| High Availability | X | X | Yes | Yes | Yes | Yes | Yes | Yes |
| LAN Bypass | X | X | X | X | X | Yes | X | Yes |
| Dimension (H x W x D) | 3.5cm x 26cm x 13.3cm | 4.4cm x 29.3cm x 15.9cm | | 1U x 27.0cm | 1U x 27.8cm | 1U x 37.9cm | 1U x 39.8cm | |
| Weight | 1.0kg | 1.0kg | 1.2kg | 1.2kg | 3.5kg | 5.5kg | 5.5kg | 6.5kg |

4 Product Features

Peplink Balance Series products enable all LAN users to share broadband Internet connections, and provide advanced features to enhance Internet access. The following is the list of supported features:

4.1 Supported Network Features

4.1.1 WAN

- Multiple public IP support (DHCP, PPPoE, Static IP Address, or GRE)
- 10/100 Mbps Connection in Full/Half Duplex
- 1000 Mbps Connection in Full/Half Duplex **(Available on Peplink Balance 380+)**
- USB Mobile Connection* **(Available on Peplink Balance 20/30, 380+)**
*Remark: Only one USB modem can be connected.
- Drop-in Mode on selectable WAN port with MAC address passthrough **(Available on Peplink Balance 210+)**
- Network Address Translation (NAT) / Port Address Translation (PAT)
- Inbound and Outbound NAT mapping
- IPsec NAT-T and PPTP packet passthrough
- Multiple static IP addresses per WAN Connection
- MAC address clone
- Customizable MTU and MSS values
- WAN connection health check
- Dynamic DNS (Supported service providers: changeip.com, dyndns.org, no-ip.org and tzo.com)

4.1.2 LAN

- DHCP server on LAN
- Static routing rules
- Local DNS

4.1.3 VPN (Available on Peplink Balance 210+)

- Secure Site-to-Site VPN
- VPN load balancing and failover among selected WAN connections
- Site-to-Site VPN bandwidth bonding
- Ability to route Internet traffic to a remote VPN peer
- Optional pre-shared key setting
- Authenticate PPTP clients by RADIUS and LDAP servers **(Available on Peplink Balance 380+)**
- Site-to-Site VPN Throughput, Ping and Traceroute Test **(Available on Peplink Balance 210+)**PPTP server
- PPTP and IPsec passthrough

4.1.4 Inbound Traffic Management

- TCP/UDP traffic redirection to dedicated LAN server(s)
- Inbound link load balancing by means of DNS **(Available on Peplink Balance 210+)**

4.1.5 Outbound Policy

- Link load distribution per TCP/UDP service
- Persistent routing for specified source and/or destination IP addresses per TCP/UDP service
- Prioritize and route traffic to VPN tunnels with Priority and Enforced algorithms

4.1.6 WLAN Controller

- Configure and manage Pepwave AP devices
- Review the status of connected AP

4.1.7 QoS (Available on Peplink Balance 210+)

- Quality of Service for different applications and custom protocols
- User Group classification for different service levels (**Available on Peplink Balance 380+**)
- Bandwidth usage control and monitoring on group- and user- level (**Available on Peplink Balance 380+**)
- Application Prioritization for custom protocols and DSL optimization

4.1.8 Firewall

- Outbound (LAN to WAN) firewall rules
- Inbound (WAN to LAN) firewall rules per WAN connection
- Intrusion detection and prevention
- Specification of NAT mappings
- Web Blocking (**Available on Peplink Balance 380+**)

4.2 Other Supported Features

- Easy-to-use web-based administration interface
- HTTP and HTTPS support for Web Administration Interface
- Configurable web administration port and administrator password
- Read-only user for Web Admin
- Authentication and Accounting by RADIUS server for Web Admin
- Firmware upgrades, configuration backups, Ping, and Traceroute via Web Administration Interface
- Remote web based configuration (via WAN and LAN interfaces)
- Remote reporting to Peplink Balance reporting server
- Real-Time, Daily and Monthly Bandwidth Usage reports and charts
- Hardware High Availability via VRRP, with automatic configuration synchronization (**Available on Peplink Balance 210+**)
- Hardware backup via LAN bypass (**Available on Peplink Balance 580 and 1350**)
- Built-in WINS server
- Time server synchronization
- SNMP
- Email notification
- Syslog
- SIP passthrough
- PPTP packet passthrough
- Event Log
- Active Sessions
- Client List
- WINS Client List
- UPnP / NAT-PMP

5 Package Contents

The contents of Peplink Balance product packages are as follows:

5.1 Peplink Balance 20 / 30

- Peplink Balance 20 / 30
- Power adapter
- Information slip

5.2 Peplink Balance 210 / 310

- Peplink Balance 210 / 310
- Power adapter
- Information slip
- Rackmount kit

5.3 Peplink Balance 380 / 580 / 710 / 1350

- Peplink Balance 380 / 580 / 710 / 1350
- Power cord
- Information slip
- Rackmount kit

6 Peplink Balance Overview

6.1 Peplink Balance 20

6.1.1 Front Panel Appearance

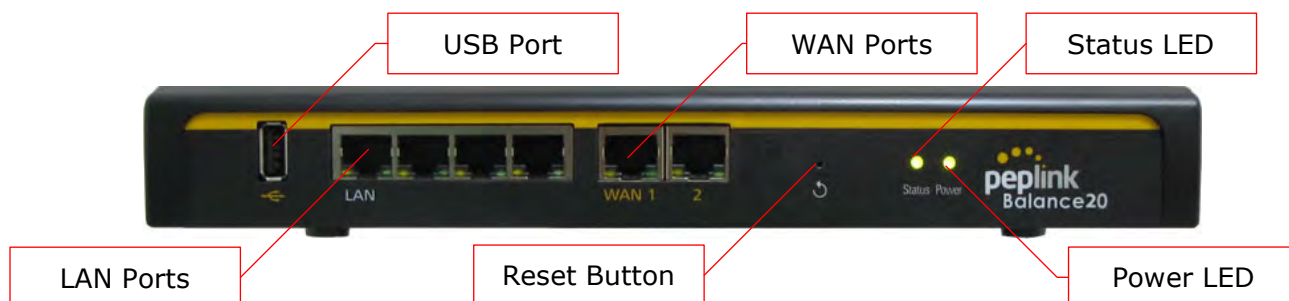

6.1.2 LED Indicators

The statuses indicated by the Front Panel LEDs are as follows:

| Power and Status Indicators | |
|-----------------------------|---------------------------|
| Power | OFF – Power off |
| | Green – Power on |
| Status | OFF – System initializing |
| | Red – Booting up or busy |
| | Green – Ready state |

| LAN and WAN Ports | |
|-------------------|---|
| Green LED | ON – 100 Mbps |
| | OFF – 10 Mbps |
| Yellow LED | Solid – Port is connected without traffic |
| | Blinking – Data is transferring |
| | OFF – Port is not connected |
| Port Type | Auto MDI/MDI-X ports |

| USB Port | |
|------------------|--|
| USB Ports | For connecting a USB based mobile modem. |

6.1.3 Rear Panel Appearance

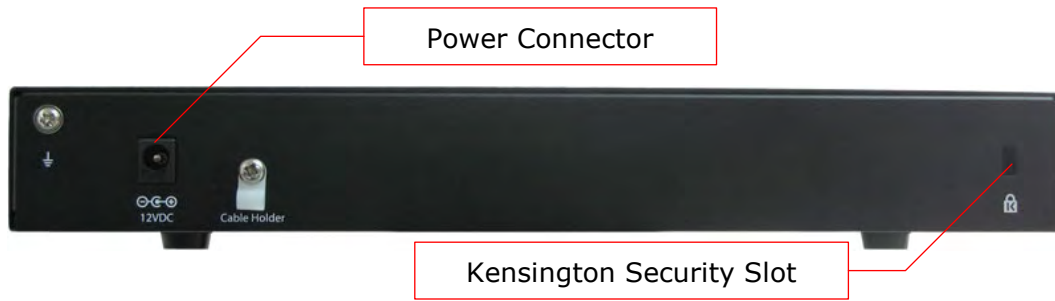

6.1.4 Unit Base Appearance



6.2 Peplink Balance 30

6.2.1 Front Panel Appearance

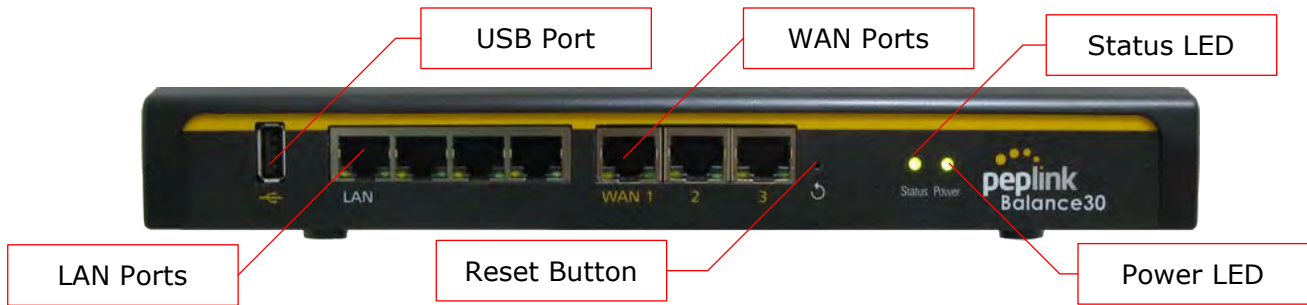

6.2.2 LED Indicators

The statuses indicated by the Front Panel LEDs are as follows:

| Power and Status Indicators | |
|-----------------------------|---------------------------|
| Power | OFF – Power off |
| | Green – Power on |
| Status | OFF – System initializing |
| | Red – Booting up or busy |
| | Green – Ready state |

| LAN and WAN Ports | |
|-------------------|---|
| Green LED | ON – 100 Mbps |
| | OFF – 10 Mbps |
| Yellow LED | Solid – Port is connected without traffic |
| | Blinking – Data is transferring |
| | OFF – Port is not connected |
| Port Type | Auto MDI/MDI-X ports |

| USB Port | |
|------------------|--|
| USB Ports | For connecting a USB based mobile modem. |

6.2.3 Rear Panel Appearance

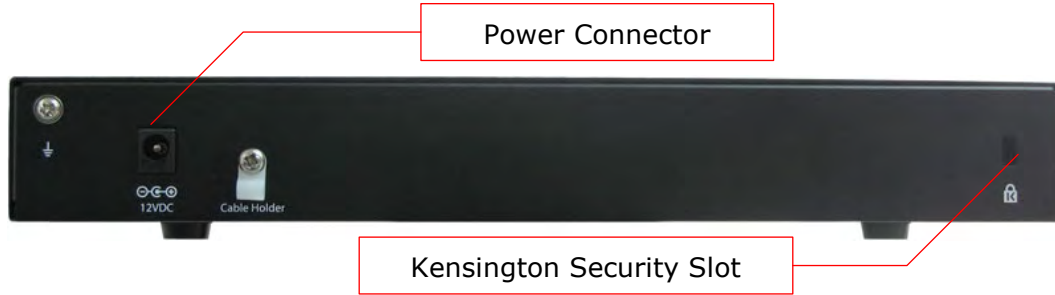

6.2.4 Unit Base Appearance



6.3 Peplink Balance 210

6.3.1 Front Panel Appearance

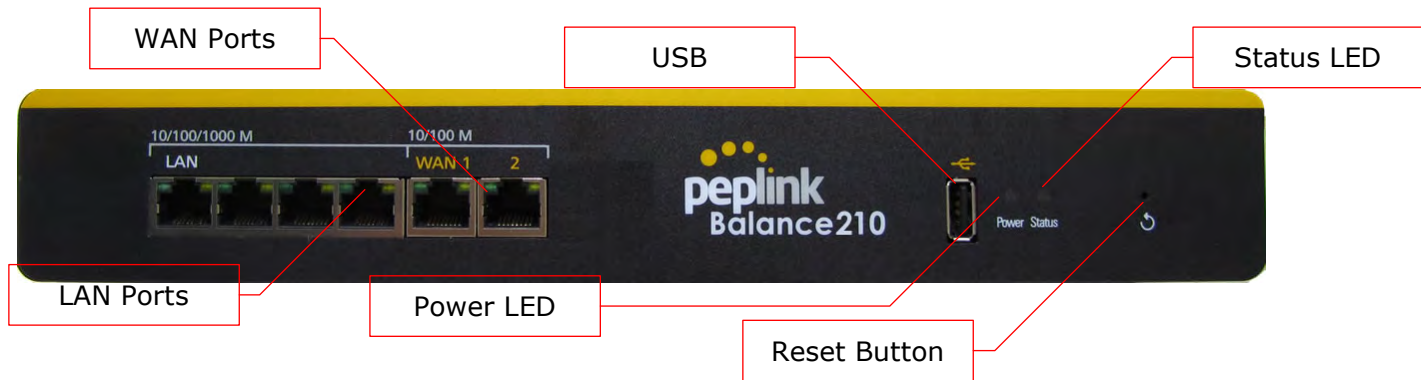

6.3.2 LED Indicators

The statuses indicated by the Front Panel LEDs are as follows:

| Power and Status Indicators | |
|-----------------------------|---------------------------|
| Power | OFF – Power off |
| | Green – Power on |
| Status | OFF – System initializing |
| | Red – Booting up or busy |
| | Green – Ready state |

| LAN and WAN Ports | |
|-------------------|---|
| Green LED | ON – 100 Mbps |
| | OFF – 10 Mbps |
| Yellow LED | Solid – Port is connected without traffic |
| | Blinking – Data is transferring |
| | OFF – Port is not connected |
| Port Type | Auto MDI/MDI-X ports |

6.3.3 Rear Panel Appearance

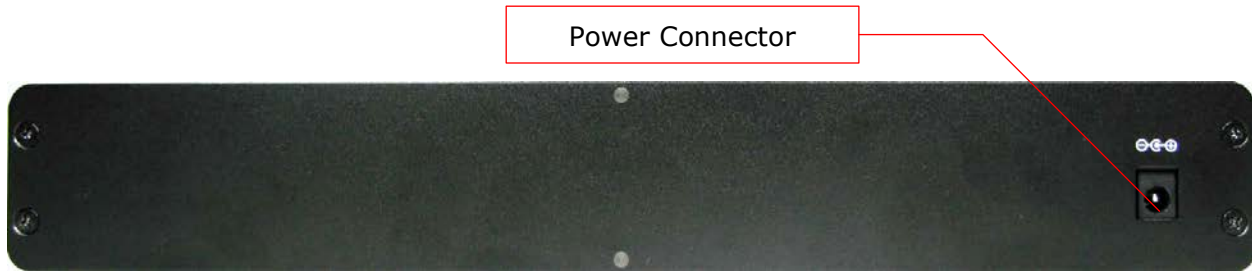

6.3.4 Unit Base Appearance



Serial Number and
LAN MAC Address

6.4 Peplink Balance 310

6.4.1 Front Panel Appearance

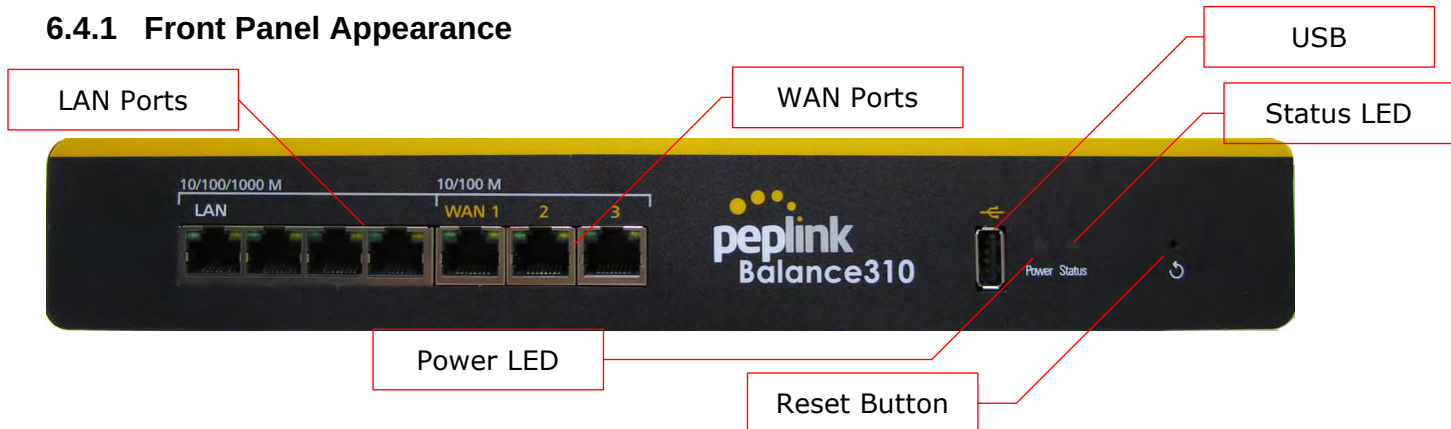

6.4.2 LED Indicators

The statuses indicated by the Front Panel LEDs are as follows:

| Power and Status Indicators | |
|-----------------------------|---------------------------|
| Power | OFF – Power off |
| | Green – Power on |
| Status | OFF – System initializing |
| | Red – Booting up or busy |
| | Green – Ready state |

| LAN and WAN Ports | |
|-------------------|---|
| Green LED | ON – 100 Mbps |
| | OFF – 10 Mbps |
| Yellow LED | Solid – Port is connected without traffic |
| | Blinking – Data is transferring |
| | OFF – Port is not connected |
| Port Type | Auto MDI/MDI-X ports |

6.4.3 Rear Panel Appearance

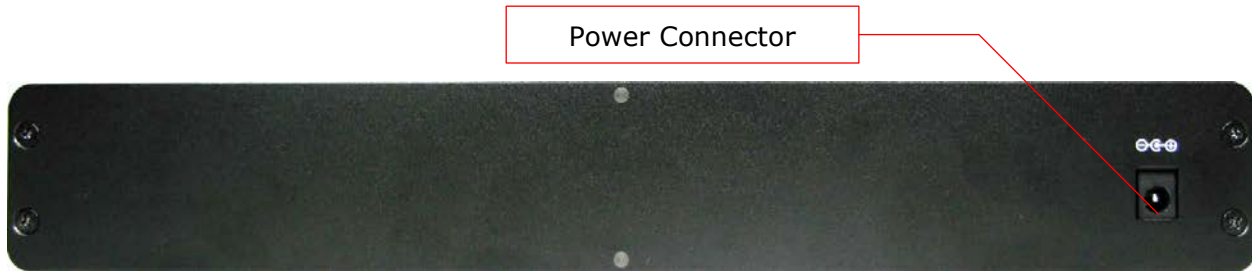

6.4.4 Unit Base Appearance



6.5 Peplink Balance 380

6.5.1 Front Panel Appearance

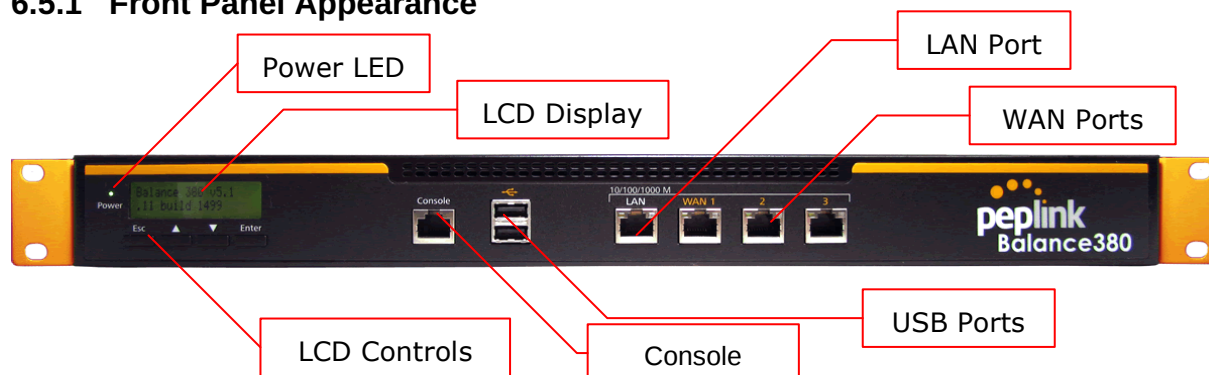

6.5.2 LED Indicators

The statuses indicated by the Front Panel LEDs are as follows:

| Power and Status Indicators | |
|-----------------------------|------------------|
| Power LED | OFF – Power off |
| | Green – Power on |

| Console and USB Ports | |
|-----------------------|--|
| Console Port | Reserved for engineering Use |
| USB Ports | For connecting a USB based mobile modem. |

| LAN Port, WAN 1 – 3 Ports | |
|---------------------------|---|
| Right LED | Orange – 1000 Mbps |
| | Green – 100 Mbps |
| | OFF – 10 Mbps |
| Left LED | Solid – Port is connected without traffic |
| | Blinking – Data is transferring |
| | OFF – Port is not connected |
| Port Type | Auto MDI/MDI-X ports |

6.5.3 LCD Display Menu



- > HA State: Master/Slave
 - > LAN IP
 - > VIP
- > System Status
 - > System
 - > Firmware ver. (shows firmware version)
 - > Serial number (shows serial number)
 - > System time (shows current time)
 - > System up time (shows system uptime since last reboot)
 - > CPU load (shows current CPU loading, 0-100%)
 - > LAN
 - > Status (shows LAN port physical status)
 - > IP address (shows LAN IP address)
 - > Subnet mask (shows LAN subnet mask)
 - > Link status (shows Connected/Disconnected, IP address list)
 - > WAN1
 - > WAN2
 - > WAN3
 - > VPN status (shows Connected/Disconnected)
 - > VPN Profile 1
 - > VPN Profile 2
 - > ...
 - > VPN Profile n
 - > Link usage
 - > Throughput in (shows transfer rate in Kbps)
 - > WAN1
 - > WAN2
 - > WAN3
 - > Throughput out (shows transfer rate in Kbps)
 - > WAN1
 - > WAN2
 - > WAN3
 - > Data Transfer'd (shows volume transferred since last reboot in MB)
 - > WAN1
 - > WAN2
 - > WAN3
- > Maintenance
 - > Reboot (to reboot the unit)
 - > Factory default (to restore factory defaults)
 - > Reboot? (Yes/No)
 - > Factory default? (Yes/No)
- > LAN config
 - > Port speed (shows port speed: Auto, 10baseT-FD, 10baseT-HD, 100baseTx-FD, 100baseTx-HD, 1000baseTx-FD)
 - > LAN
 - > WAN1
 - > WAN2
 - > WAN3

6.5.4 Rear Panel Appearance

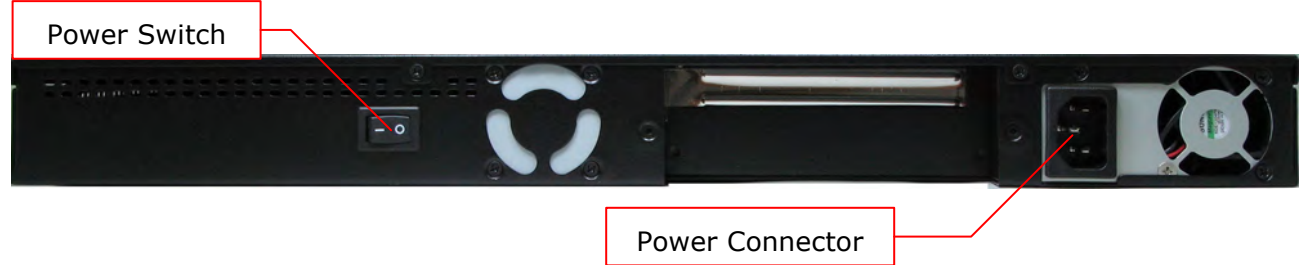

| Connector Ports | |
|------------------------|-------------------|
| Power Connector | AC input 110/220V |

| Switch | |
|---------------------|--|
| Power Switch | To hold pressing the key for 4 seconds will power down the unit When the unit is powered off, press it will power on the unit |

6.5.5 Unit Label Appearance

Peplink Balance 380

Product Code: BPL-380



Serial: 1824-6144-F2A7

LAN MAC: 10-56-CA-03-DF-30

Default Access Username: admin
http://192.168.1.1 Password: admin

Made in Taiwan







<http://www.peplink.com>

Serial Number and LAN MAC Address

6.6 Peplink Balance 580

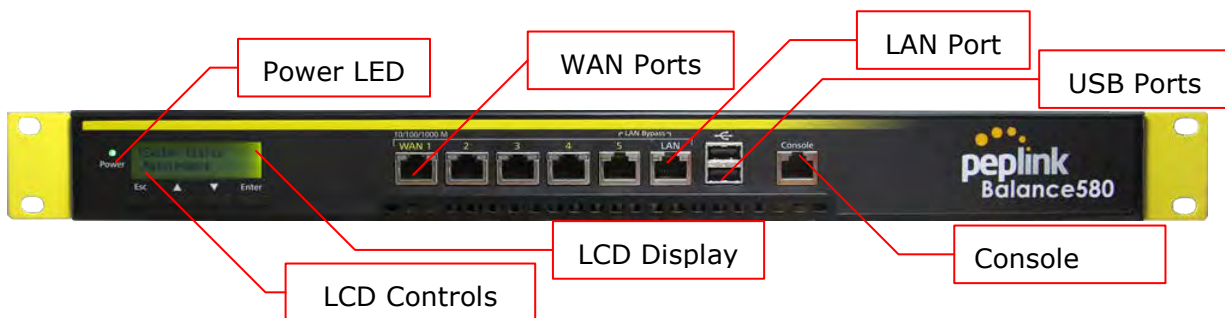
6.6.1 Front Panel Appearance



6.6.2 LED Indicators

The statuses indicated by the Front Panel LEDs are as follows:

| Power and Status Indicators | |
|-----------------------------|------------------|
| Power LED | OFF – Power off |
| | Green – Power on |

| Console and USB Ports | |
|-----------------------|--|
| Console Port | Reserved for engineering Use |
| USB Ports | For connecting a USB based mobile modem. |

| LAN Port, WAN 1 – 5 Ports | |
|---------------------------|---|
| Right LED | Orange – 1000 Mbps |
| | Green – 100 Mbps |
| | OFF – 10 Mbps |
| Left LED | Solid – Port is connected without traffic |
| | Blinking – Data is transferring |
| | OFF – Port is not connected |
| Port Type | Auto MDI/MDI-X ports |

6.6.3 LCD Display Menu



- > HA State:Master/Slave
 - > LAN IP
 - > VIP
- > System Status
 - > System
 - > Firmware ver. (shows firmware version)
 - > Serial number (shows serial number)
 - > System time (shows current time)
 - > System up time (shows system uptime since last reboot)
 - > CPU load (shows current CPU loading, 0-100%)
 - > LAN
 - > Status (shows LAN port physical status)
 - > IP address (shows LAN IP address)
 - > Subnet mask (shows LAN subnet mask)
 - > Link status
 - > WAN1
 - > WAN2
 - > ...
 - > WAN5
 - > VPN status (shows Connected/Disconnected)
 - > VPN Profile 1
 - > VPN Profile 2
 - > ...
 - > VPN Profile n
 - > Link usage
 - > Throughput in (shows transfer rate in Kbps)
 - > WAN1
 - > WAN2
 - > ...
 - > WAN5
 - > Throughput out (shows transfer rate in Kbps)
 - > WAN1
 - > WAN2
 - > ...
 - > WAN5
 - > Data Transfer'd (shows volume transferred since last reboot in MB)
 - > WAN1
 - > WAN2
 - > ...
 - > WAN5
- > Maintenance
 - > Reboot > Reboot? (Yes/No) (to reboot the unit)
 - > Factory default > Factory default? (Yes/No) (to restore factory defaults)
- > LAN config
 - > Port speed (shows port speed: Auto, 10baseT-FD, 10baseT-HD, 100baseTx-FD, 100baseTx-HD, 1000baseTx-FD)
 - > LAN
 - > WAN1
 - > WAN2
 - > ...
 - > WAN5

6.6.4 Rear Panel Appearance

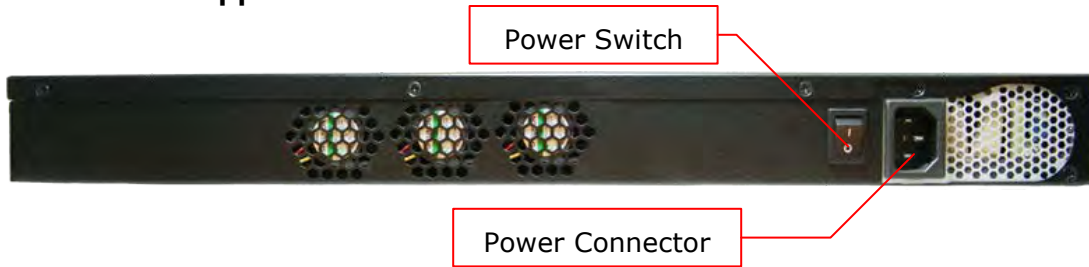

| Connector Ports | |
|------------------------|-------------------|
| Power Connector | AC input 110/220V |

| Switch | |
|---------------------|--|
| Power Switch | To hold pressing the key for 4 seconds will power down the unit When the unit is powered off, press it will power on the unit |

6.6.5 Unit Label Appearance

Peplink Balance 580

Product Code: BPL-580

Serial: 1824-61DE-6B04

LAN MAC: 10-56-CA-03-E6-68

| | |
|-----------------------|-----------------|
| Default Access | Username: admin |
| http://192.168.1.1 | Password: admin |

Made in Taiwan



peplink

FC CE

<http://www.peplink.com>

Serial Number and LAN MAC Address

6.7 Peplink Balance 710

6.7.1 Front Panel Appearance

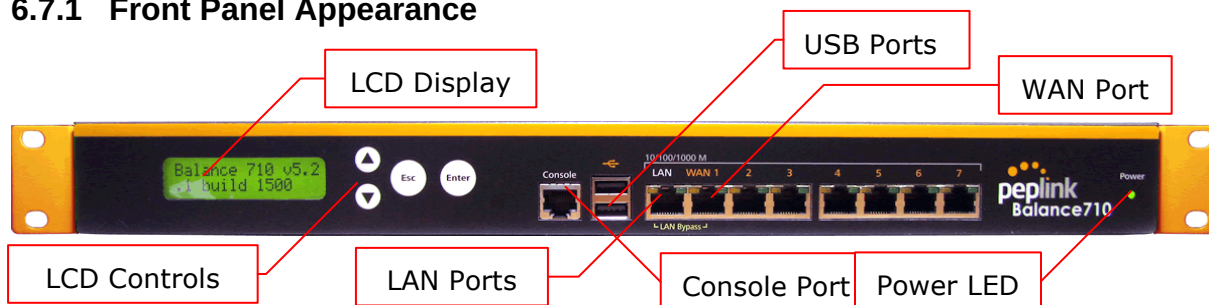

Status indicated in the Front Panel is as follows:

| LED Indicator | |
|------------------|-----------------------|
| Power LED | OFF – Power off |
| | ON (Green) – Power on |

| Console & USB Ports | |
|---------------------|--|
| Console Port | Reserved for engineering Use |
| USB Ports | For connecting a USB based mobile modem. |

| LAN Port, WAN 1 – 3 Ports (Gigabit Ethernet) | |
|--|---|
| Green LED | ON – 1000 Mbps |
| | OFF – 100/10 Mbps |
| Yellow LED | Solid – Port is connected without traffic |
| | Blinking – Data is transferring |
| | OFF – Port is not connected |
| Port Type | Auto MDI/MDI-X ports |

| WAN Ports 4 to 7 (Fast Ethernet) | |
|----------------------------------|---|
| Green LED | ON – 100 Mbps |
| | OFF – 10 Mbps |
| Yellow LED | Solid – Port is connected without traffic |
| | Blinking – Data is transferring |
| | OFF – Port is not connected |
| Port Type | MDI ports |

6.7.2 LCD Display Menu

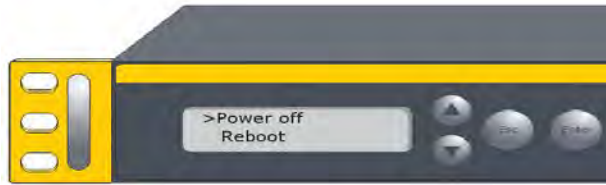

- > HA State:Master/Slave
 - > LAN IP
 - > VIP
- > System Status
 - > System
 - > Firmware ver. (shows firmware version)
 - > Serial number (shows serial number)
 - > System time (shows current time)
 - > System up time (shows system uptime since last reboot)
 - > CPU load (shows current CPU loading, 0-100%)
 - > LAN
 - > Status (shows LAN port physical status)
 - > IP address (shows LAN IP address)
 - > Subnet mask (shows LAN subnet mask)
 - > Link status
 - > WAN1
 - > WAN2
 - > ...
 - > WAN7
 - > VPN status (shows Connected/Disconnected)
 - > VPN Profile 1
 - > VPN Profile 2
 - > ...
 - > VPN Profile n
 - > Link usage
 - > Throughput in (shows transfer rate in Kbps)
 - > WAN1
 - > WAN2
 - > ...
 - > WAN7
 - > Throughput out (shows transfer rate in Kbps)
 - > WAN1
 - > WAN2
 - > ...
 - > WAN7
 - > Data Transfer'd (shows volume transferred since last reboot in MB)
 - > WAN1
 - > WAN2
 - > ...
 - > WAN7
- > Maintenance
 - > Reboot > Reboot? (Yes/No) (to reboot the unit)
 - > Factory default > Factory default? (Yes/No) (to restore factory defaults)
- > LAN config
 - > Port speed (shows port speed: Auto, 10baseT-FD, 10baseT-HD, 100baseTx-FD, 100baseTx-HD, 1000baseTx-FD)
 - > LAN
 - > WAN1
 - > WAN2
 - > ...
 - > WAN7

6.7.3 Rear Panel Appearance

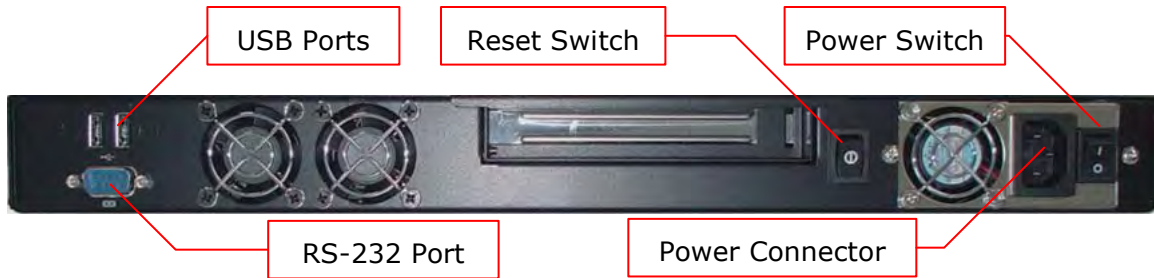

| Connector Ports | |
|------------------------|--|
| RS-232 Port | Reserved for engineering use |
| USB Ports | For connecting a USB based mobile modem. |
| Power Connector | AC input 110/220V |

| Switches | |
|---------------------|--|
| Power Switch | To hold pressing the key for 4 seconds will power down the unit When the unit is powered off, press it will power on the unit |
| Reset Switch | Press and release once to reset the system |



6.7.4 Unit Label Appearance

Peplink Balance 710
 Product Code: BPL-710
 Serial: 182C-1033-7C51
 LAN MAC: 10-56-CA-60-13-30

Default Access Username: admin
 http://192.168.1.1 Password: admin

Made in Taiwan





<http://www.peplink.com>

Serial Number and LAN MAC Address

6.8 Peplink Balance 1350

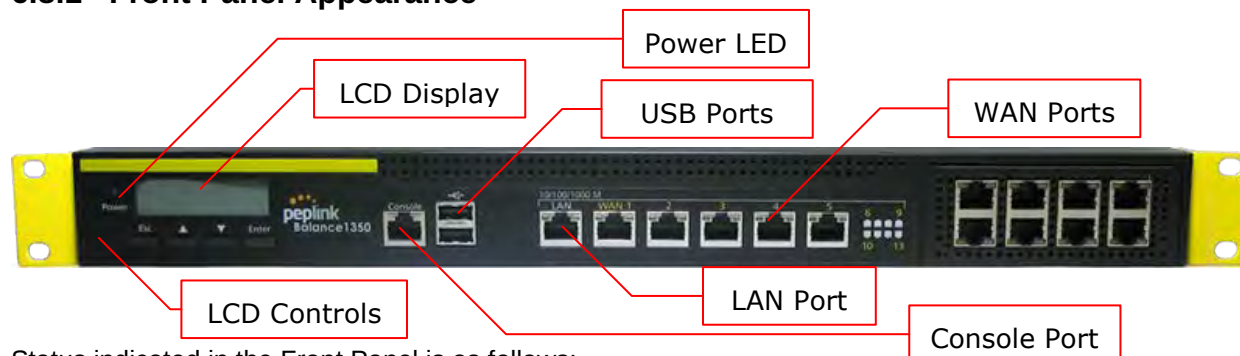
6.8.1 Front Panel Appearance



Status indicated in the Front Panel is as follows:

| LED Indicator | |
|------------------|-----------------------|
| Power LED | OFF – Power off |
| | ON (Green) – Power on |

| Console & USB Ports | |
|---------------------|--|
| Console Port | Reserved for engineering Use |
| USB Ports | For connecting a USB based mobile modem. |

| LAN Port, WAN 1 – 13 Ports | |
|----------------------------|---|
| Right LED | Orange – 1000 Mbps |
| | Green – 100 Mbps |
| | OFF – 10 Mbps |
| Left LED | Solid – Port is connected without traffic |
| | Blinking – Data is transferring |
| | OFF – Port is not connected |
| Port Type | Auto MDI/MDI-X ports |

6.8.2 LCD Display Menu

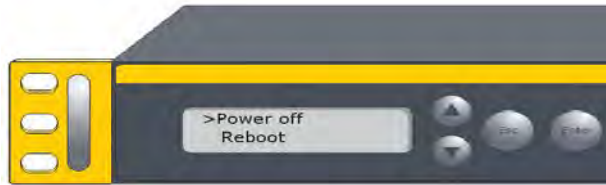

- > HA State: Master/Slave
 - > LAN IP
 - > VIP
- > System Status
 - > System
 - > Firmware ver. (shows firmware version)
 - > Serial number (shows serial number)
 - > System time (shows current time)
 - > System up time (shows system uptime since last reboot)
 - > CPU load (shows current CPU loading, 0-100%)
 - > LAN
 - > Status (shows LAN port physical status)
 - > IP address (shows LAN IP address)
 - > Subnet mask (shows LAN subnet mask)
 - > Link status
 - > WAN1
 - > WAN2
 - > ...
 - > WAN13
 - > VPN status (shows Connected/Disconnected)
 - > VPN Profile 1
 - > VPN Profile 2
 - > ...
 - > VPN Profile n
 - > Link usage
 - > Throughput in (shows transfer rate in Kbps)
 - > WAN1
 - > WAN2
 - > ...
 - > WAN13
 - > Throughput out (shows transfer rate in Kbps)
 - > WAN1
 - > WAN2
 - > ...
 - > WAN13
 - > Data Transfer'd (shows volume transferred since last reboot in MB)
 - > WAN1
 - > WAN2
 - > ...
 - > WAN13
- > Maintenance
 - > Reboot > Reboot? (Yes/No) (to reboot the unit)
 - > Factory default > Factory default? (Yes/No) (to restore factory defaults)
- > LAN config
 - > Port speed (shows port speed: Auto, 10baseT-FD, 10baseT-HD, 100baseTx-FD, 100baseTx-HD, 1000baseTx-FD)
 - > LAN
 - > WAN1
 - > WAN2
 - > ...
 - > WAN13

6.8.3 Rear Panel Appearance

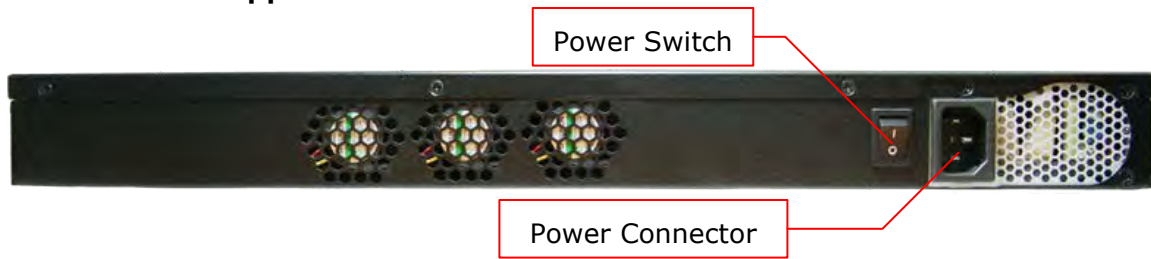

| Connector Ports | |
|------------------------|--|
| RS-232 Port | Reserved for engineering use |
| USB Ports | For connecting a USB based mobile modem. |
| Power Connector | AC input 110/220V |

| Switches | |
|---------------------|--|
| Power Switch | To hold pressing the key for 4 seconds will power down the unit When the unit is powered off, press it will power on the unit |
| Reset Switch | Press and release once to reset the system |

6.8.4 Unit Label Appearance

Peplink Balance 1350 

Product Code: BPL-135

Serial: 182C-1065-2932

LAN MAC: 10-56-CA-60-16-50

Default Access Username: admin
http://192.168.1.1 Password: admin

Made in Taiwan



<http://www.peplink.com>

Serial Number and LAN MAC Address

7 Installation

Connecting the Network with Peplink Balance:

7.1 Preparation

Before installing Peplink Balance, please prepare the following:

- At least one Internet/WAN access account.
- For each network connection, one 10/100BaseT UTP cable with RJ45 connector, or one 1000BaseT Cat5E UTP cable for the Gigabit port on the Balance 580/710/1350, or one USB modem for the USB WAN port on Balance 380/580/710/1350.
- A computer with TCP/IP network protocol and a web browser installed. Supported browsers include Microsoft Internet Explorer 7 or above, Mozilla Firefox 3.0 or above, Apple Safari 3.1.1 or above, and Google Chrome 2.0 or above.

7.2 Constructing the Network

At the high level, construct the network according to the following steps:

1. With an Ethernet cable, connect a computer to one of the LAN ports on the Peplink Balance. For Peplink Balance 20, 30, 210 and 310, repeat with different cables for up to 4 computers to be connected.
2. With another Ethernet cable, connect the WAN/broadband modem to one of the WAN ports on the Peplink Balance. Repeat using different cables to connect up to 2, 3, 5, 7 or 13 WAN/broadband connections with the Peplink Balance 20, 30, 210, 310, 380, 580, 710 and 1350, respectively, or connect a USB modem to the USB WAN port on the Peplink Balance 20/30/380/580/710/1350.
3. For Peplink Balance 20, 30, 210 and 310, connect the provided power adapter to the power connector on the Peplink Balance, and then plug the power adapter into a power outlet. For Peplink Balance 380, 580, 710 and 1350, connect the provided power cord to the AC power connector on the Peplink Balance, and then plug the power cord into a power outlet.

The following figure schematically illustrates the configuration that results:

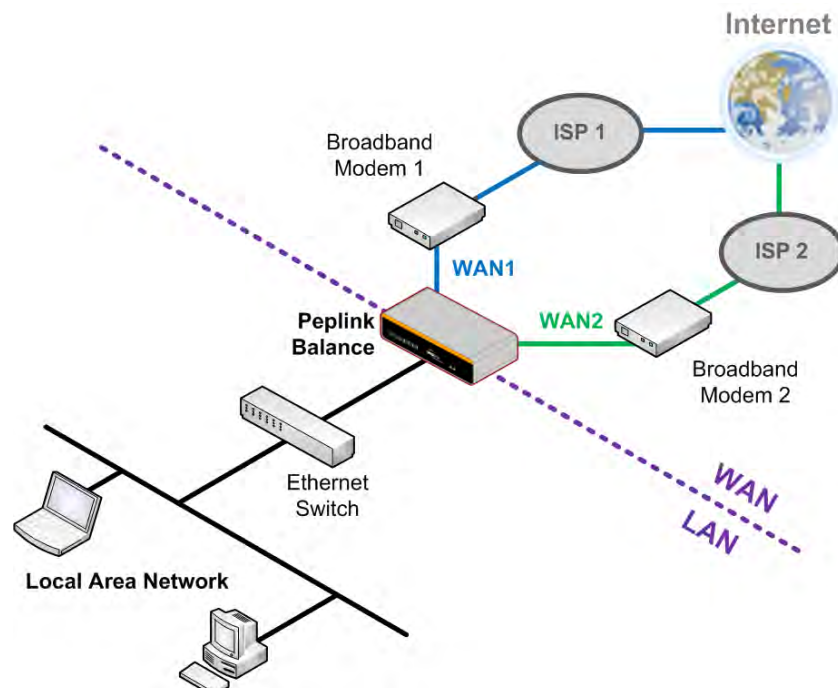

7.3 Configuring the Network Environment

To ensure that Peplink Balance works properly in the LAN environment and can access the Internet via the WAN connections, please refer to the following setup procedures:

- LAN Configuration
For basic configuration, refer to Section 8, **Basic Configuration**.
For advanced configuration, refer to Section 9, **Configuration of LAN Interface**.
- WAN Configuration
For basic configuration, refer to Section 8, **Basic Configuration**.
For advanced configuration, refer to Section 11, **Configuration of WAN Interface(s)**.

8 Basic Configuration

8.1 Connecting to Web Admin Interface

1. Start a web browser on a computer that is connected with Peplink Balance through LAN.
2. To connect to Web Admin of Peplink Balance, enter the following LAN IP address in the address field of the web browser:

http://192.168.1.1

(This is the default LAN IP address of Peplink Balance.)

3. Enter the following to access the Web Admin Interface.

User Name: admin

Password: admin

(This is the default Admin User login of Peplink Balance. The Admin and Read-only User Password can be changed at **System > Admin Security** of the Web Admin Interface.)

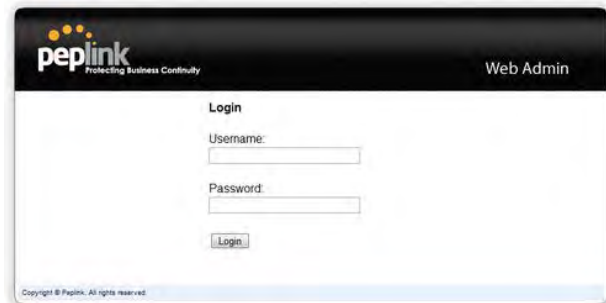

4. After successful login, the **Dashboard** of Web Admin Interface will be displayed. It looks similar to the following:

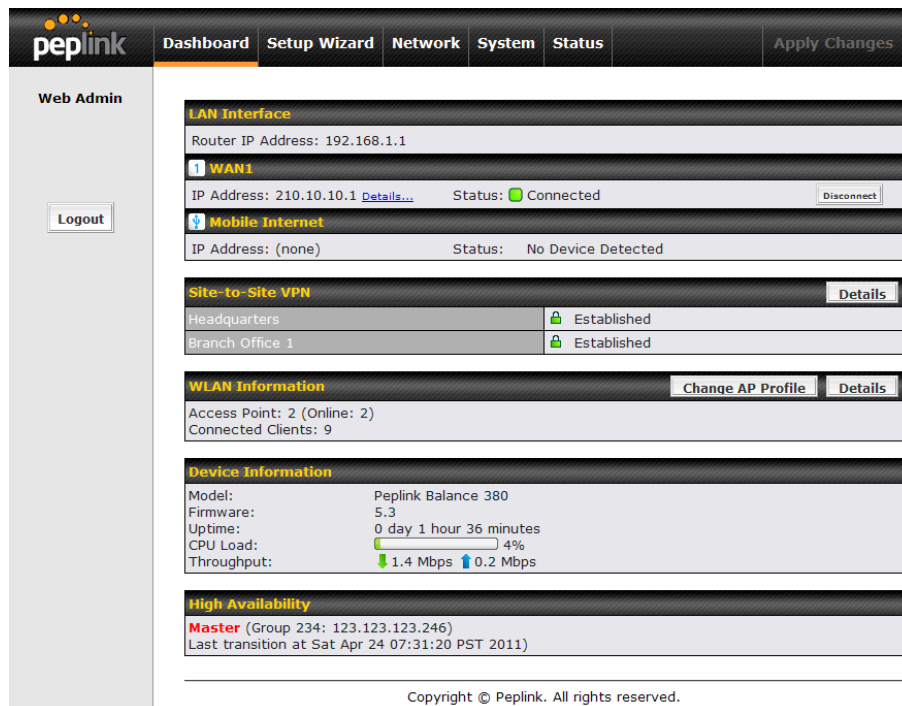

Important Note

The **Save** button causes the changes to be saved. Configuration changes (e.g. WAN, LAN, Admin settings, etc.) take effect after clicking the **Apply Changes** button on each page's top right hand corner.

8.2 Configuration with Setup Wizard

The Setup Wizard of Peplink Balance simplifies the task of configuring WAN connection(s) by guiding the configuration process step by step.

To begin, click **Setup Wizard** after connecting to Web Admin Interface.



Click **Next** to begin.

Setup Wizard > WAN Setup > Step 1

Welcome to Setup Wizard!

The Setup Wizard will guide you through the WAN port(s) configuration step by step. This wizard is designed to simplify the process in configuring your device and connecting it to the Internet.

Click *Next* to begin.

Select **YES** if you want to set up Drop-in mode in Setup Wizard.

(Note: Drop-in mode is available on Peplink Balance 210+.)

Setup Wizard > WAN Setup > Step 2

| Drop-in Mode ? | |
|--|---|
| Do you want to setup drop-in mode? | <input checked="" type="radio"/> Yes <input type="radio"/> No |
| Which WAN port do you want to enable drop-in mode? | WAN 1 ▾ |

Click on the appropriate check box(es) to select the WAN connection(s) to be configured. If you have chosen to configure Drop-in mode in Setup Wizard, the box of WAN port that is to be configured in Drop-in mode will be checked by default.

Setup Wizard > WAN Setup > Step 3

Choose the WAN port(s) to be configured.

| WAN Ports ? | |
|--------------------------|-------------------------------------|
| WAN 1 (Drop-in) | <input checked="" type="checkbox"/> |
| WAN 2 | <input type="checkbox"/> |
| WAN 3 | <input type="checkbox"/> |
| Mobile Internet | <input type="checkbox"/> |

Note

Mobile Internet connection is available on Peplink Balance 20/30, 380+.

If **Drop-in mode** is going to be configured, Setup Wizard will move on to Drop-in Settings.

Setup Wizard > WAN Setup > Step 4

Enter the parameters of Drop-in Settings for WAN 1.

| Drop-in Settings | |
|--------------------|--|
| IP Address | <input type="text"/> |
| Subnet Mask | 255.255.255.0 (/24) ▼ |
| Default Gateway | <input type="text"/> |
| DNS Servers | DNS server 1: <input type="text"/> DNS server 2: <input type="text"/> |
| Upload Bandwidth | 100 <input type="text"/> Mbps ▼ |
| Download Bandwidth | 100 <input type="text"/> Mbps ▼ |

Select the connection type for WAN connection(s) from the following screen:

Setup Wizard > WAN Setup > Step 3

Choose a connection method for WAN1.

| Connection Method | |
|-------------------|----------------------------------|
| Method | Select |
| Static IP | <input type="radio"/> |
| DHCP | <input checked="" type="radio"/> |
| PPPoE | <input type="radio"/> |
| Disable | <input type="radio"/> |

Depending on the selection of connection type, further configuration may be needed. For example, PPPoE and Static IP require additional settings for the selected WAN port. Please refer to **Section 10, Configuration of WAN Interface(s)** for details on setting up DHCP, Static IP and PPPoE.

If **Mobile Internet Connection** is checked, Setup Wizard will move on to Operator settings.

Setup Wizard > WAN Setup > Step 3

Select whether Operator Settings for Mobile Internet will be automatically detected or customized.

| Operator Settings (for HSPA/EDGE/GPRS only) | |
|---|----------------------------------|
| Settings | Select |
| Auto | <input type="radio"/> |
| Custom | <input checked="" type="radio"/> |

If **Custom Mobile Operator Settings** is selected, APN parameters are required to be entered. Some service providers may charge a fee for connecting to a different APN. Please consult the service provider for the correct settings.

Setup Wizard > WAN Setup > Step 4

Enter the parameters of Mobile Operator Settings for Mobile Internet.

| Mobile Operator Settings | |
|--------------------------|----------------------|
| APN | <input type="text"/> |
| Login ID | <input type="text"/> |
| Password | <input type="text"/> |
| Dial Number | <input type="text"/> |

Click on the appropriate check box(es) to select the preferred WAN connection(s). Connection(s) not selected in this step will be used as back up only. Click **Next >>** to continue.

Setup Wizard > WAN Setup > Step 6

Choose the preferred WAN Port(s) that is to be used as primary connection. The port(s) not selected in this step will only be used when none of the connection of the preferred port is up.

| Preferred WAN Port Selection | |
|------------------------------|-------------------------------------|
| Port | Preferred |
| WAN 1 | <input checked="" type="checkbox"/> |
| WAN 2 | <input checked="" type="checkbox"/> |
| WAN 3 | <input checked="" type="checkbox"/> |
| Mobile Internet | <input type="checkbox"/> |

Choose the time zone of your Country/Region. Check the box **Show all** to display all time zone options.

Setup Wizard > WAN Setup > Step 6

Choose time zone of your Country / Region.

| Time Zone Settings | |
|--------------------|--|
| Time Zone | (GMT-08:00) Pacific Time (US & Canada) |
| | <input checked="" type="checkbox"/> Show all |

Check in the following screen to make sure all settings have been configured correctly, and then click **Save Settings** to confirm.

Setup Wizard > WAN Setup > Final Step

Confirm the WAN connection(s) configuration below. Click *Back* to modify the configuration settings in previous steps. Click *Save Settings* when you are done.

| Summary of WAN Connection(s) Configuration | |
|--|--|
| 2. WAN2 | |
| Enable | No |
| 4. Mobile Internet | |
| Connection Method | PPP |
| Operator Settings | Auto |
| Preferred WAN Connection(s) | |
| Connections | 1. WAN1 3. WAN3 |
| Time Zone Settings | |
| Time Zone | (GMT-08:00) Pacific Time (US & Canada) |

<< Back

Save Settings

Cancel

After finishing the last step in the Setup Wizard, please click **Apply Changes** on the page header to allow the configuration changes to take effect.

8.3 Advanced Setup

Advanced settings can be configured from the **Network** menu.

WAN connections can be configured by entering the corresponding WAN connection information at: **Network > Interfaces > WAN**

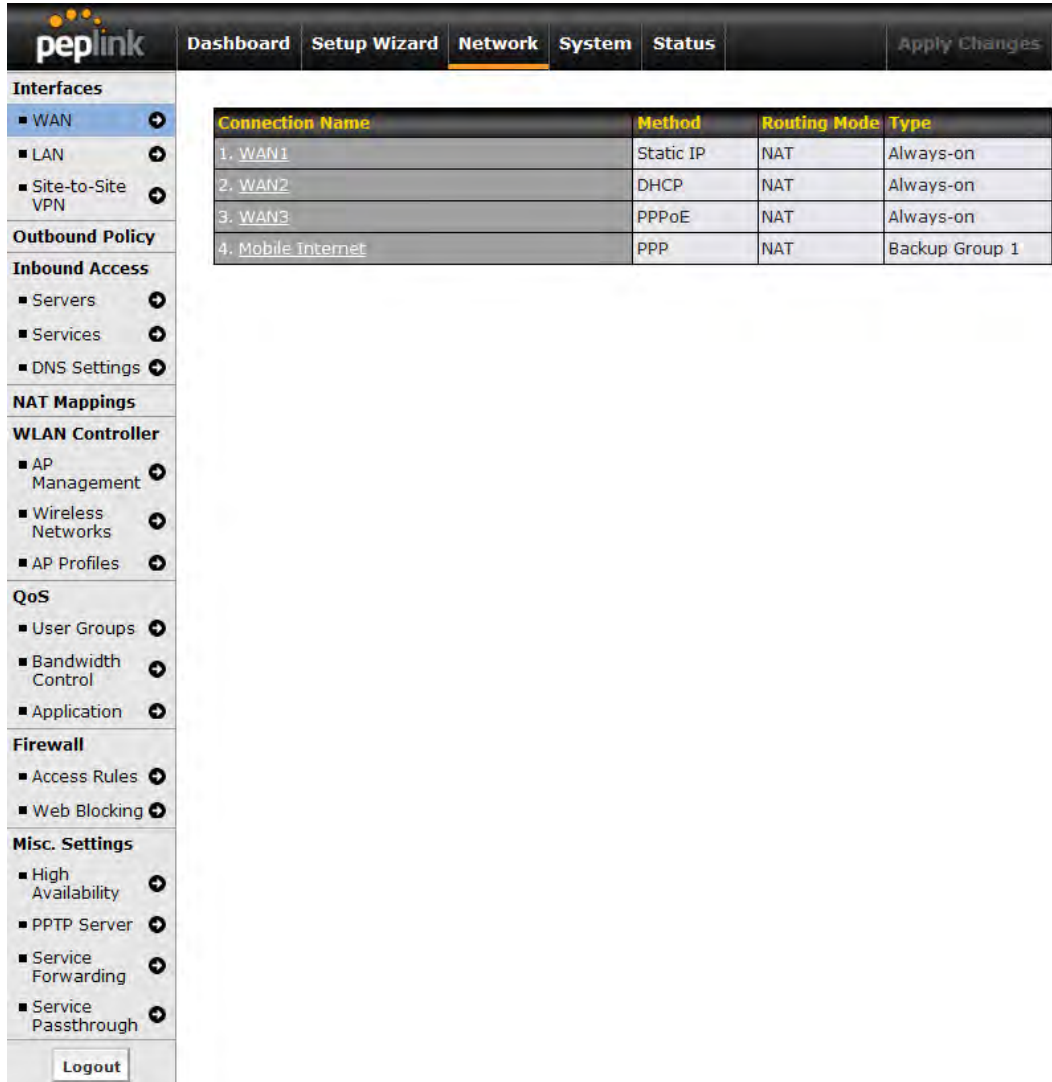

| Connection Name | Method | Routing Mode | Type |
|------------------------------------|-----------|--------------|----------------|
| 1. WAN1 | Static IP | NAT | Always-on |
| 2. WAN2 | DHCP | NAT | Always-on |
| 3. WAN3 | PPPoE | NAT | Always-on |
| 4. Mobile Internet | PPP | NAT | Backup Group 1 |

Tip

Please refer to **Section 11, Configuration of WAN Interface(s)**, for details on setting up DHCP, Static IP, PPPoE, GRE, and Mobile Internet Connection.

9 Configuration of LAN Interface



The LAN Interface settings are located at: *Network > Interfaces > LAN*

| IP Settings | |
|---------------|---|
| IP Address * | 192.168.1.2 |
| Subnet Mask * | 255.255.0.0 (/16) |
| Speed | 100Mbps Full Duplex <input checked="" type="checkbox"/> Advertise Speed |

| Drop-In Mode Settings | |
|---|--|
| Enable | <input checked="" type="checkbox"/> |
| WAN for Drop-In Mode | WAN 1 |
| WAN Default Gateway | 192.168.1.1 <input checked="" type="checkbox"/> I have other host(s) on WAN segment Host IP Address(es) 192.168.1.123 [Down Arrow] <input type="text"/> <input type="text"/> <input type="button" value="Delete"/> |
| WAN DNS Servers | DNS server 1: <input type="text"/> DNS server 2: <input type="text"/> |
| NOTE: The DHCP Server Settings will be overwritten. The following WAN 1 settings will be overwritten: Enable, Connection Method, Routing Mode, Connection Type, MTU, Health Check, Additional Public IP, and Dynamic DNS Settings. The PPTP Server will be disabled. Tip: please review the DNS Forwarding setting under the Service Forwarding section. | |

| DHCP Server Settings | | | | | | | | | | | | | |
|------------------------------------|--|---------------|-------------|-------------------------|-------------------|------------------------------------|---------------|----------------------------------|--|--|----------------------------------|--|--|
| DHCP Server | <input checked="" type="checkbox"/> Enable | | | | | | | | | | | | |
| IP Range | 192.168.1.10 - 192.168.1.250 | | | | | | | | | | | | |
| Subnet Mask | 255.255.255.0 (/24) | | | | | | | | | | | | |
| Lease Time | 1 Days 0 Hours 0 Mins 0 Seconds | | | | | | | | | | | | |
| DNS Servers | <input type="checkbox"/> Assign DNS server automatically DNS server 1: <input type="text"/> DNS server 2: <input type="text"/> | | | | | | | | | | | | |
| WINS Servers | <input checked="" type="checkbox"/> Assign WINS server <input type="radio"/> Built-in <input checked="" type="radio"/> External WINS server 1: <input type="text"/> WINS server 2: <input type="text"/> | | | | | | | | | | | | |
| Extended DHCP Option | <table border="1"> <thead> <tr> <th>Option</th> <th>Value</th> </tr> </thead> <tbody> <tr> <td colspan="2" style="text-align: center;">No Extended DHCP Option</td> </tr> <tr> <td colspan="2" style="text-align: center;"><input type="button" value="Add"/></td> </tr> </tbody> </table> | Option | Value | No Extended DHCP Option | | <input type="button" value="Add"/> | | | | | | | |
| Option | Value | | | | | | | | | | | | |
| No Extended DHCP Option | | | | | | | | | | | | | |
| <input type="button" value="Add"/> | | | | | | | | | | | | | |
| DHCP Reservation | <table border="1"> <thead> <tr> <th>Name</th> <th>MAC Address</th> <th>Static IP</th> </tr> </thead> <tbody> <tr> <td>Manager's desktop</td> <td>00:11:aa:22:bb:33</td> <td>192.168.1.100</td> </tr> <tr> <td colspan="3" style="text-align: right;"><input type="button" value="X"/></td> </tr> <tr> <td colspan="3" style="text-align: right;"><input type="button" value="+"/></td> </tr> </tbody> </table> | Name | MAC Address | Static IP | Manager's desktop | 00:11:aa:22:bb:33 | 192.168.1.100 | <input type="button" value="X"/> | | | <input type="button" value="+"/> | | |
| Name | MAC Address | Static IP | | | | | | | | | | | |
| Manager's desktop | 00:11:aa:22:bb:33 | 192.168.1.100 | | | | | | | | | | | |
| <input type="button" value="X"/> | | | | | | | | | | | | | |
| <input type="button" value="+"/> | | | | | | | | | | | | | |

| Static Route Settings | | | | | | | | | | |
|----------------------------------|--|----------------------|-------------|---------|----------------------|----------------------|----------------------|----------------------------------|--|--|
| Static Route | <table border="1"> <thead> <tr> <th>Destination Network</th> <th>Subnet Mask</th> <th>Gateway</th> </tr> </thead> <tbody> <tr> <td><input type="text"/></td> <td><input type="text"/></td> <td><input type="text"/></td> </tr> <tr> <td colspan="3" style="text-align: right;"><input type="button" value="+"/></td> </tr> </tbody> </table> | Destination Network | Subnet Mask | Gateway | <input type="text"/> | <input type="text"/> | <input type="text"/> | <input type="button" value="+"/> | | |
| Destination Network | Subnet Mask | Gateway | | | | | | | | |
| <input type="text"/> | <input type="text"/> | <input type="text"/> | | | | | | | | |
| <input type="button" value="+"/> | | | | | | | | | | |



| WINS Server Settings | | | |
|---------------------------------|---|-------------------------------------|----------------------|
| Enable | | <input type="checkbox"/> | |
| DNS Proxy Settings | | | |
| Enable | | <input checked="" type="checkbox"/> | |
| DNS Caching |  | <input type="checkbox"/> | |
| Use Google DNS Server as Backup |  | <input type="checkbox"/> | |
| Local DNS Records |  | Host Name | IP Address |
| | | <input type="text"/> | <input type="text"/> |
| | | <input type="button" value="+"/> | |

* Required



| LAN Settings | |
|-------------------------------------|--|
| IP Address & Subnet Mask | The IP address of Peplink Balance on LAN |
| Speed | <p>This setting specifies the speed of the LAN Ethernet Port. By default, Auto is selected and the appropriate data speed is automatically detected by Peplink Balance.</p> <p>In the event of negotiation issues, the port speed can be manually specified to circumvent the issues. You can also choose whether or not to advertise the speed to the peer by selecting the Advertise Speed checkbox.</p> |

| Drop-in Mode Settings (Available on Peplink Balance 210+) | |
|--|---|
| Enable | Drop-in Mode eases the installation of Peplink Balance on a live network between the existing Firewall and Router, such that no configuration changes are required on existing equipment. Check the box to enable the Drop-in Mode feature. Please refer to Section 10 Drop-in Mode for details. |
| WAN for Drop-In Mode | Select the WAN port to be used for Drop-in mode. If the WAN port for LAN Bypass is selected, High Availability feature will be disabled automatically. |
| WAN Default Gateway | Enter the WAN router's IP address in this field. If there are more hosts other than the router on the WAN segment, check the box I have other host(s) on WAN segment and enter the IP address of the hosts that needs to access LAN devices or to be accessed by others. |
| WAN DNS Servers | Enter the selected WAN's corresponding DNS server IP addresses. |

| DHCP Server Settings | |
|----------------------|--|
| DHCP Server | <p>When this setting is enabled, the DHCP server of Peplink Balance automatically assigns an IP address to each computer that is connected via LAN and is configured to obtain an IP address via DHCP.</p> <p>Peplink Balance's DHCP server can prevent IP address collision on LAN.</p> |

| | |
|-----------------------------------|--|
| IP Range & Subnet Mask | This setting allocates a range of IP address that will be assigned to LAN computers by the DHCP server of Peplink Balance. |
| Lease Time | This setting specifies the length of time throughout which an IP address of a DHCP client remains valid. Upon expiration of the Lease Time, the assigned IP address will no longer be valid and the renewal of the IP address assignment will be required. |
| DNS Servers | This option allows you to input the DNS server addresses to be offered to the DHCP clients. If Assign DNS server automatically is selected, the Peplink Balance's built-in DNS server address (i.e. LAN IP address) will be offered. |
| WINS Server | <p>This option allows you to specify the Windows Internet Name Service (WINS) server. You may choose to use the built-in WINS server or external WINS servers. When this unit is Site-to-Site VPN connected, other VPN peers can share this unit's built-in WINS server by entering this unit's LAN IP address in their DHCP WINS Servers setting. Therefore, all PC clients in the VPN can resolve the NetBIOS names of other clients in remote peers.</p> <p>If you have enabled this option, a list of WINS clients will be displayed at Status > WINS Clients.</p> |
| Extended DHCP Option | <p>In addition to standard DHCP options (e.g. DNS server address, gateway address, subnet mask), you can specify the value of additional Extended DHCP Options defined in RFC 2132. In this case, you can pass additional configuration information to LAN hosts.</p> <p>To define an Extended DHCP Option, click the Add button, choose the option that you want to define and enter its value. For values that are in IP address list format, you can enter one IP address per line in the provided text area input control. Each option is allowed to be defined once only.</p> |
| DHCP Reservation | <p>This setting reserves the assignment of fixed IP addresses for a list of computers on the LAN. The computers to be assigned fixed IP addresses on the LAN are identified by their MAC addresses.</p> <p>The fixed IP address assignment is displayed as a cross-reference list between the computers' Name, MAC addresses and fixed IP addresses.</p> <p>The field Name (an optional field) is for you to define a name to represent the device. MAC addresses should be in the format of 00:AA:BB:CC:DD:EE</p> <p>Press  to create a new record. Press  to remove a record.</p> <p>Reserved clients information can be imported from the Client List, located at Status > Client List. For more details, please refer to section 20.3</p> |

Static Route Settings

| | |
|---------------------|--|
| Static Route | <p>This table is for defining static routing rules for the LAN segment.</p> <p>A static route consists of the network address, subnet mask, and gateway address. The address and subnet mask values are in the format of w.x.y.z</p> <p>The local LAN subnet and subnets behind the LAN will be advertised to the VPN. Remote routes sent over the VPN will also be accepted. Any VPN member will be able to route to the local subnets.</p> <p>Press  to create a new route. Press  to remove a route.</p> |
|---------------------|--|

WINS Server Settings

Enable Check the box to enable the WINS Server. A list of WINS clients will be displayed at **Status > WINS Clients**.

DNS Proxy Settings

Enable A check box to enable to DNS Proxy feature.

DNS Caching



This field is to enable DNS caching on the built-in DNS proxy server. When the option is enabled, queried DNS replies will be cached until the records' TTL has been reached. This feature can help improve the DNS lookup time by storing all received DNS results for a faster DNS response time. However, it cannot return the most updated result for those frequently updated DNS records.
By default, it is **disabled**.

Use Google DNS Server as Backup

When this option is **enabled**, the DNS proxy server will forward DNS requests to [Google's Public DNS Servers](#) in the case if all WAN connections' DNS servers become unavailable.
By default, it is **disabled**.

Local DNS Records

This table is for defining custom local DNS records.
A static local DNS record consists of a Host Name and an IP Address. When looking up the Host Name from the LAN to LAN IP of Peplink Balance, the corresponding IP Address will be returned.

Press  to create a new record. Press  to remove a record.

10 Drop-in Mode

Drop-in Mode (or transparent bridging mode) eases the installation of Peplink Balance on a live network between the firewall and router, such that changes to the settings of existing equipment are not required.

Drop-in Mode is **NOT** applicable to Balance 20 and 30.

The following diagram illustrates the Drop-in Mode setup:

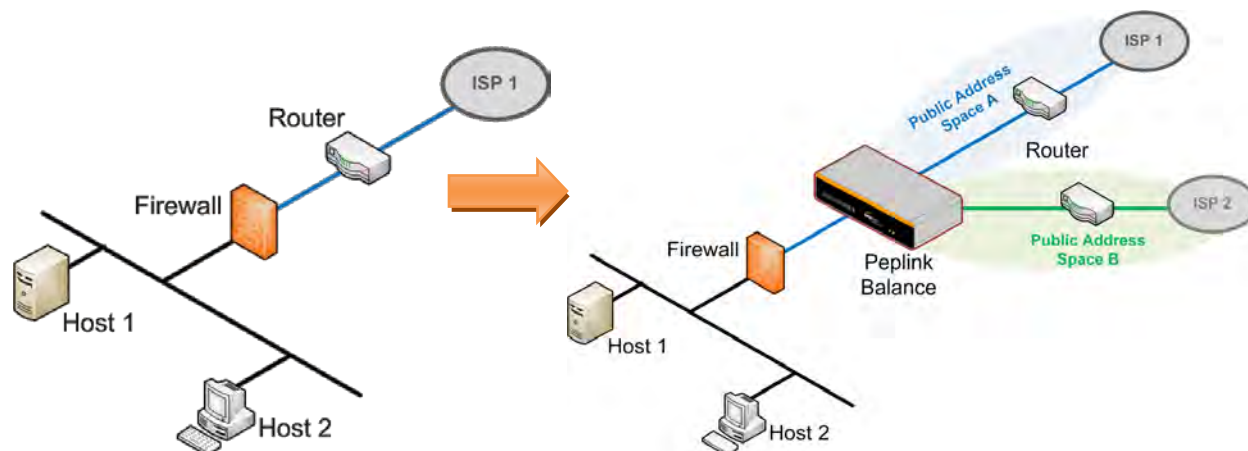

Check the box to **Enable** the Drop-in Mode. After enabling this feature and selecting the WAN for Drop-in mode, various settings including the WAN's connection method and IP address will be automatically updated.

When Drop-in Mode is enabled, the LAN and the WAN for Drop-in Mode ports will be bridged. Traffic going in between the LAN hosts and WAN router will be forwarded to each other. In this case, the hosts on both sides will not notice any IP or MAC address change.

After successfully setting up Peplink Balance as part of the network via Drop-in Mode, a Peplink Balance 210 will accommodate one additional WAN connection; 310 or 380 will accommodate two, 580 will accommodate four, 710 will accommodate six, and 1350 will accommodate twelve additional WAN connections respectively.

IMPORTANT NOTE for customers using Drop-in Mode and going to upgrade from firmware 4.8.2 or below to 5.0+

MAC address passthrough for Drop-in Mode is implemented in firmware 5.0. If Drop-in Mode is enabled when user is upgrading from previous firmware version, the ARP tables on the hosts on LAN and WAN segments have to be flushed once or the hosts have to be rebooted. Otherwise, hosts on one side may not be able to reach hosts on the other side of Peplink Balance until the old ARP records expire. Units without enabling Drop-in Mode are not affected.

NOTE

PPTP server will be disabled under Drop-in Mode.

To enable Drop-in Mode, perform the following steps.

| IP Settings | |
|---------------|---|
| IP Address * | 210.10.10.5 |
| Subnet Mask * | 255.255.255.0 (/24) |
| Speed | 100Mbps Full Duplex <input checked="" type="checkbox"/> Advertise Speed |

| Drop-In Mode Settings | |
|-----------------------|---|
| Enable | <input checked="" type="checkbox"/> |
| WAN for Drop-In Mode | WAN 1 |
| WAN Default Gateway | 210.10.10.1 <input checked="" type="checkbox"/> I have other host(s) on WAN segment Host IP Address(es) 210.10.10.4 - <input type="text"/> 210.10.10.3 210.10.10.4 <input type="button" value="Delete"/> |
| WAN DNS Servers | DNS server 1: 10.1.1.1 DNS server 2: <input type="text"/> |

NOTE: The DHCP Server Settings will be overwritten.

The following WAN 1 settings will be overwritten: Enable, Connection Method, Routing Mode, Connection Type, MTU, Health Check, Additional Public IP, and Dynamic DNS Settings.

The PPTP Server will be disabled.

Tip: please review the DNS Forwarding setting under the Service Forwarding section.

1. Check the **Enable** box under Drop-in Mode located at: **Network > Interfaces > LAN**. (After checking the **Enable** box, most network settings for WAN1 will be hidden from Web Administration Interface.)
2. Put the IP address of the WAN1 router in the **WAN Default Gateway** field. Ensure that the Peplink Balance IP subnet is the same as the Firewall's WAN port and the Router's LAN port.
3. If there are hosts other than the router existing on the WAN segment of Peplink Balance, check the **I have other host(s) on WAN segment** box, enter the IP address(es) of the host(s), and then click the down-arrow to add the hosts.

The following diagram illustrates:

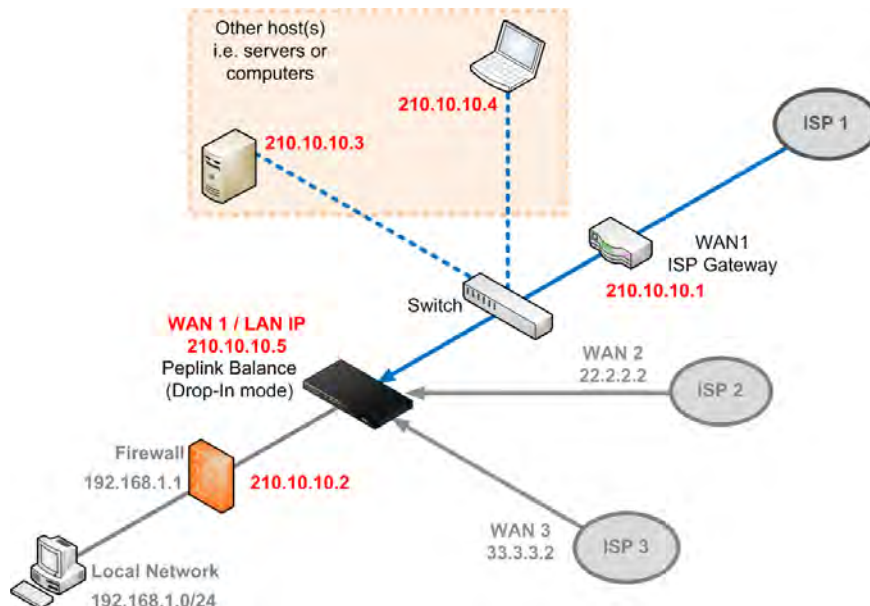

Important Note

Starting from firmware version 5.0, Drop-in mode can be configured on any WAN ports. Please be noted that still only one WAN port can be configured in Drop-in mode.

If you have selected the LAN Bypass port (which is currently available on WAN1 of Balance 1350 and WAN5 of Balance 580) as the WAN for Drop-in Mode, High Availability feature will be DISABLED automatically.

Tip

Want to know more about Drop-in mode? Visit our [YouTube Channel](#) for video tutorials!

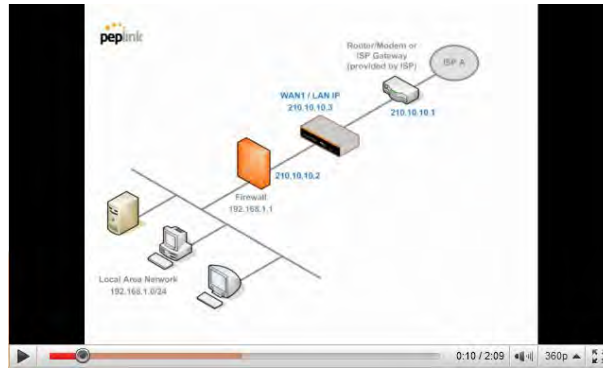

<http://www.youtube.com/PeplinkChannel#p/u/9/xHTLcCXsgTc>

11 Configuration of WAN Interface(s)

The WAN interface settings are located at: **Network > Interfaces > WAN**

By clicking a connection name, connection settings of that WAN can be modified.

The connection method and details are determined by, and can be obtained from, the ISP.

| Connection Settings | |
|-----------------------|--|
| WAN Connection Name * | WAN1 |
| Enable | <input checked="" type="radio"/> Yes <input type="radio"/> No |
| Connection Method | <input type="radio"/> DHCP <input type="radio"/> Static IP <input type="radio"/> PPPoE <input type="radio"/> GRE <input type="radio"/> Mobile Internet Connection Click here to edit Connection settings |
| Routing Mode | <input checked="" type="radio"/> NAT <input type="radio"/> IP Forwarding |
| Connection Type | <input type="radio"/> Always-on <input checked="" type="radio"/> Backup Priority <input type="radio"/> Group 1 (Highest) <input type="radio"/> Group 2 <input type="radio"/> Group 3 (Lowest) |
| Reply to ICMP PING | <input checked="" type="checkbox"/> Enable <input type="checkbox"/> Disable |
| Upload Bandwidth * | 100 Mbps |
| Download Bandwidth * | 100 Mbps |

| Connection Settings | | | | | | | | | | | | | |
|----------------------------|--|-------------------|--|-------------------|--------------------|---|-------------------|--|--|---------|--|--|------------------|
| WAN Connection Name | This field is for defining a name to represent this WAN connection. | | | | | | | | | | | | |
| Enable | This field is for choosing whether to enable this WAN connection. | | | | | | | | | | | | |
| Connection Method | <p>This option allows you to select the connection method for this WAN connection. Available options are:</p> <ol style="list-style-type: none"> DHCP Static IP PPPoE GRE Mobile Internet Connection (available on Peplink Balance 20/30, 380+) <p>See Sections 11.1.1, 11.1.2, 11.1.3, 11.1.4, 11.1.5 for configuration details of each connection method.</p> | | | | | | | | | | | | |
| Routing Mode | This field shows that NAT (Network Address Translation) will be applied to the traffic routing over this WAN connection. IP Forwarding is also available when you click the link in the help text. For further details, please refer to Appendix B, Routing under DHCP, Static IP, and PPPoE . | | | | | | | | | | | | |
| Connection Type | <p>This setting specifies the utilization of the WAN connection. The selection of Always-on results in the WAN connection to be used whenever it is available. If Backup Priority and a priority group are selected, the WAN connection is treated as a backup connection and is used only in the absence of available Always-on WAN connection(s) and higher priority backup connection(s).</p> <table border="1"> <tbody> <tr> <td>Connection Type</td> <td><input type="radio"/> Always-on <input checked="" type="radio"/> Backup Priority</td> <td>Group 1 (Highest)</td> </tr> <tr> <td>Reply to ICMP PING</td> <td><input checked="" type="checkbox"/> Enable <input type="checkbox"/> Disable</td> <td>Group 1 (Highest)</td> </tr> <tr> <td></td> <td></td> <td>Group 2</td> </tr> <tr> <td></td> <td></td> <td>Group 3 (Lowest)</td> </tr> </tbody> </table> <p>The default and recommended Connection Type is Always-on.</p> | Connection Type | <input type="radio"/> Always-on <input checked="" type="radio"/> Backup Priority | Group 1 (Highest) | Reply to ICMP PING | <input checked="" type="checkbox"/> Enable <input type="checkbox"/> Disable | Group 1 (Highest) | | | Group 2 | | | Group 3 (Lowest) |
| Connection Type | <input type="radio"/> Always-on <input checked="" type="radio"/> Backup Priority | Group 1 (Highest) | | | | | | | | | | | |
| Reply to ICMP PING | <input checked="" type="checkbox"/> Enable <input type="checkbox"/> Disable | Group 1 (Highest) | | | | | | | | | | | |
| | | Group 2 | | | | | | | | | | | |
| | | Group 3 (Lowest) | | | | | | | | | | | |

| | |
|---------------------------|--|
| Reply to ICMP Ping | <p>If this field is disabled, the WAN connection will not respond to ICMP Ping requests.</p> <p>By default, this is enabled.</p> |
| Upload Bandwidth | <p>This setting specifies the data bandwidth in the outbound direction from the LAN through the WAN interface. This value is provided by the ISP and should reflect the actual speed the WAN gets.</p> <p>This value is referenced when default weight is chosen for outbound traffic and traffic prioritization. A correct value can result in effective traffic prioritization and efficient use of upload bandwidth.</p> |
| Download Bandwidth | <p>This setting specifies the data bandwidth in the inbound direction from the WAN interface to the LAN. This value is provided by the ISP and should reflect the actual speed the WAN gets.</p> <p>This value is referenced as the default weight value when using the custom rule Default (Auto), the algorithm Least Used, or the algorithm Persistence (Auto) in Outbound Policy with Managed by Custom Rules chosen (see Section 13.2).</p> |

11.1 Connection Method(s)

There are five possible connection methods:

1. DHCP
2. Static IP
3. PPPoE
4. GRE
5. Mobile Internet Connection
(available on Peplink Balance 20/30, 380+, please refer to Section 11.1.5 for details.)

11.1.1 DHCP Connection

The DHCP connection method is suitable if the ISP provides an IP address automatically by DHCP (e.g. Cable, Metro Ethernet, etc.).

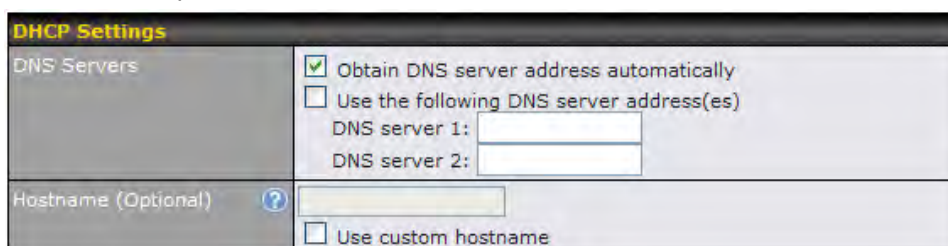

The screenshot shows the DHCP Settings configuration window. It has two main sections: 'DNS Servers' and 'Hostname (Optional)'. In the 'DNS Servers' section, there are two radio buttons: 'Obtain DNS server address automatically' (which is selected) and 'Use the following DNS server address(es)'. Below these are two input fields for 'DNS server 1:' and 'DNS server 2:'. In the 'Hostname (Optional)' section, there is a text input field and a checkbox for 'Use custom hostname'.

| DHCP Settings | |
|----------------------------|---|
| DNS Servers | <p>Each ISP may provide a set of DNS servers for DNS lookups. This setting specifies the DNS (Domain Name System) Servers to be used when a DNS lookup is routed through this connection.</p> <p>Selecting Obtain DNS server address automatically results in the DNS Servers to be assigned by the WAN DHCP Server to be used for outbound DNS lookups over the connection. (The DNS Servers are obtained along with the WAN IP address assigned from the DHCP server.)</p> <p>When Use the following DNS server address(es) is selected, you may enter custom DNS server addresses for this WAN connection into the DNS server 1 and DNS server 2 fields.</p> |
| Hostname (Optional) | <p>If your service provider's DHCP server requires you to supply a hostname value upon acquiring an IP address, you may enter the value here. If your service provider does not provide you with the value, you can safely bypass this option.</p> |

Please refer to Section 11.2, 11.4, 11.5, and 11.6 for details about **WAN Health Check**, **Bandwidth Allowance Monitor**, **Additional Public IP Settings**, and **Dynamic DNS Settings** respectively.

11.1.2 Static IP Connection

The Static IP connection method is suitable if the ISP provides a static IP address to connect directly.

| Static IP Settings  | |
|--|--|
| IP Address * | <input type="text"/> |
| Subnet Mask * | 255.255.255.0 (/24) ▼ |
| Default Gateway * | <input type="text"/> |
| DNS Servers | <input checked="" type="checkbox"/> Use the following DNS server address(es) DNS server 1: <input type="text"/> DNS server 2: <input type="text"/> |

| Static IP Settings | |
|---|---|
| IP Address / Subnet Mask / Default Gateway | These settings specify the information required in order to communicate on the Internet via a fixed Internet IP address. The information is typically determined by and can be obtained from the ISP. |
| DNS Servers | Each ISP may provide a set of DNS servers for DNS lookups. This field specifies the DNS (Domain Name System) Servers to be used when a DNS lookup is routed through this connection. You can input the ISP provided DNS server addresses into the DNS server 1 and DNS server 2 fields. If no address is entered here, this link will not be used for DNS lookups. |

Please refer to Section 11.2, 11.4, 11.5, and 11.6 for details about **WAN Health Check**, **Bandwidth Allowance Monitor**, **Additional Public IP Settings**, and **Dynamic DNS Settings** respectively.

11.1.3 PPPoE Connection

This connection method is suitable if ISP provides login ID / password to connect via PPPoE.

| PPPoE Settings | |
|-------------------------|--|
| PPPoE User Name * | <input type="text"/> |
| PPPoE Password | <input type="password"/> |
| Confirm PPPoE Password | <input type="password"/> |
| Service Name (optional) | <input type="text"/> <small>Leave it blank unless it's provided by ISP</small> |
| DNS Servers | <input checked="" type="checkbox"/> Obtain DNS server address automatically <input type="checkbox"/> Use the following DNS server address(es) DNS server 1: <input type="text"/> DNS server 2: <input type="text"/> |

| PPPoE Settings | |
|-----------------------------------|---|
| PPPoE User Name / Password | Enter the required information in these fields in order to connect via PPPoE to the ISP. The parameter values are determined by and can be obtained from the ISP. |
| Confirm PPPoE Password | Verify your password by entering it again in this field. |
| Service Name (Optional) | Service Name is a PPPoE parameter which is provided by the ISP. <i>Note: Leave this field blank unless it is provided by your ISP.</i> |
| DNS Servers | <p>Each ISP may provide a set of DNS servers for DNS lookups. This setting specifies the DNS (Domain Name System) Servers to be used when a DNS lookup is routed through this connection.</p> <p>Selecting Obtain DNS server address automatically results in the DNS Servers assigned by the PPPoE server to be used for outbound DNS lookups over the WAN connection. (The DNS Servers are obtained along with the WAN IP address assigned from the PPPoE server.)</p> <p>When Use the following DNS server address(es) is selected, you can put custom DNS server addresses for this WAN connection into the DNS server 1 and DNS server 2 fields.</p> |

Please refer to Section 11.2, 11.4, 11.5, and 11.6 for details about **WAN Health Check**, **Bandwidth Allowance Monitor**, **Additional Public IP Settings**, and **Dynamic DNS Settings** respectively.

| Note |
|--|
| PPPoE connection made from a firewall does not work with Drop-in mode. |

11.1.4 GRE Connection

The GRE connection method is suitable if the ISP provides GRE tunnel access through a private network to the Internet.

| GRE Settings | |
|----------------------------|--|
| WAN IP Address * | <input type="text"/> |
| WAN Subnet Mask * | 255.255.255.0 (/24) ▾ |
| WAN Default Gateway * | <input type="text"/> |
| Remote GRE Host * | <input type="text"/> |
| Tunnel Local IP Address * | <input type="text"/> |
| Tunnel Remote IP Address * | <input type="text"/> |
| Outgoing NAT IP Address * | <input type="text"/> |
| DNS Servers | <input checked="" type="checkbox"/> Use the following DNS server address(es) DNS server 1: <input type="text"/> DNS server 2: <input type="text"/> |

| GRE Settings | |
|---------------------|--|
| GRE Settings | <p>Please refer to the following sections for further details:</p> <ul style="list-style-type: none"> Section 11.1.4.1, Routing under GRE via Network Address Translation (NAT) Section 11.1.4.2, Routing under GRE via IP Forwarding <p>The values for DNS server 1 and DNS server 2 are typically determined by, and can be obtained from the ISP.</p> |
| DNS Servers | <p>Each ISP may provide a set of DNS servers for DNS lookups. This field specifies the DNS (Domain Name System) Servers to be used when a DNS lookup is routed through this connection.</p> <p>You can input the ISP provided DNS server addresses into the DNS server 1 and DNS server 2 fields. If no address is entered here, this link will not be used for DNS lookups.</p> |

Please refer to Section 11.2, 11.4, 11.5, and 11.6 for details about **WAN Health Check, Bandwidth Allowance Monitor, Additional Public IP Settings, and Dynamic DNS Settings** respectively.

11.1.4.1 Routing under GRE via Network Address Translation (NAT)

The following figure shows a typical scenario with Peplink Balance under the GRE connection mode and NAT routing mode:

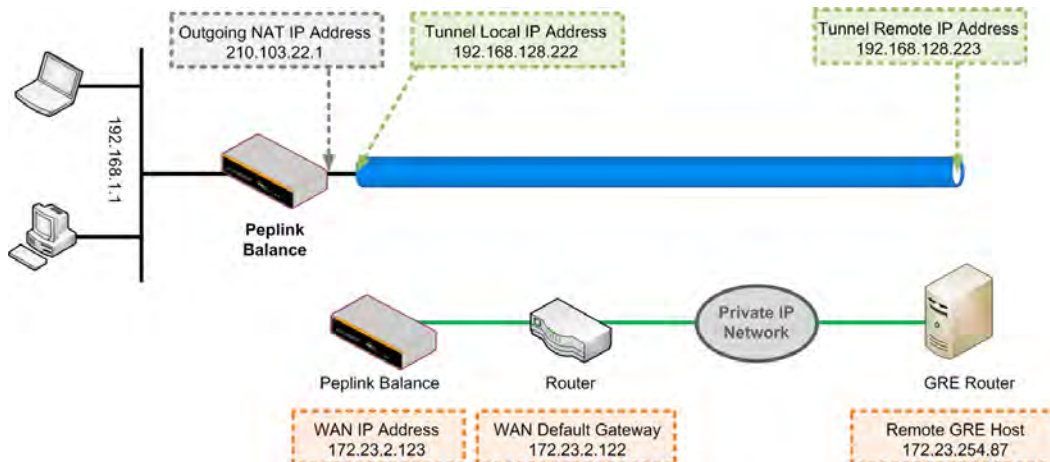

In this scenario, the IP address settings are as follows:

- WAN IP Address: 172.23.2.123
- Default Gateway: 172.23.2.122
- Remote GRE IP address: 172.23.254.87 (GRE router or host's IP address)
- Tunnel IP remote address: 192.168.128.223 (IP address of remote end of tunnel)
- Tunnel IP local address: 192.168.128.222 (IP address of local end of tunnel)
- Outgoing NAT IP address: 210.103.22.1 (This field is used for NAT routing mode only. For all outgoing traffic, the IP datagram will be sent via this IP address through the tunnel; as a result, the Outgoing NAT IP address is the public address that is seen by all external hosts on the WAN.)

The following figure shows the packet flow for Peplink Balance under GRE connection mode and NAT routing mode:

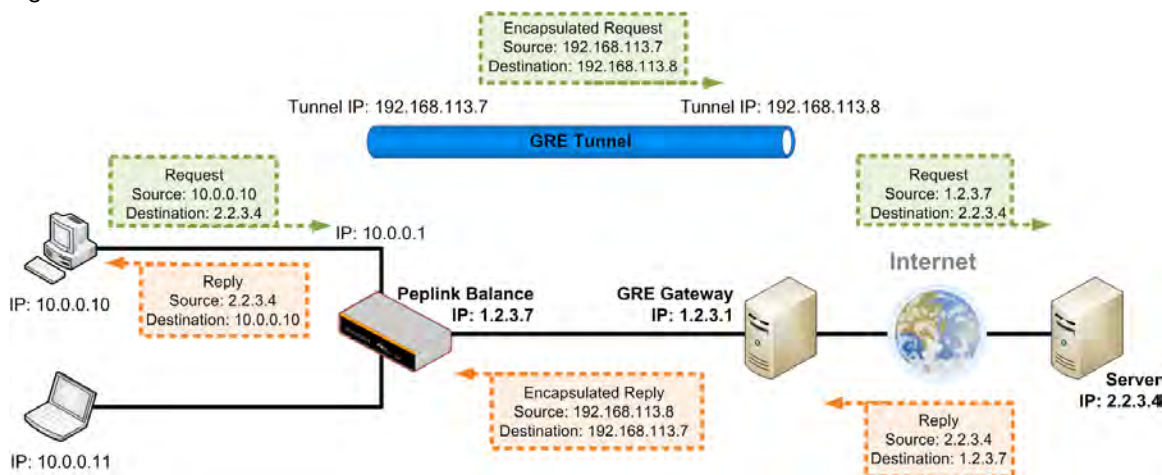

11.1.4.2 Routing under GRE via IP Forwarding

The following figure shows a typical scenario with Peplink Balance under the GRE connection mode and IP Forwarding routing mode:

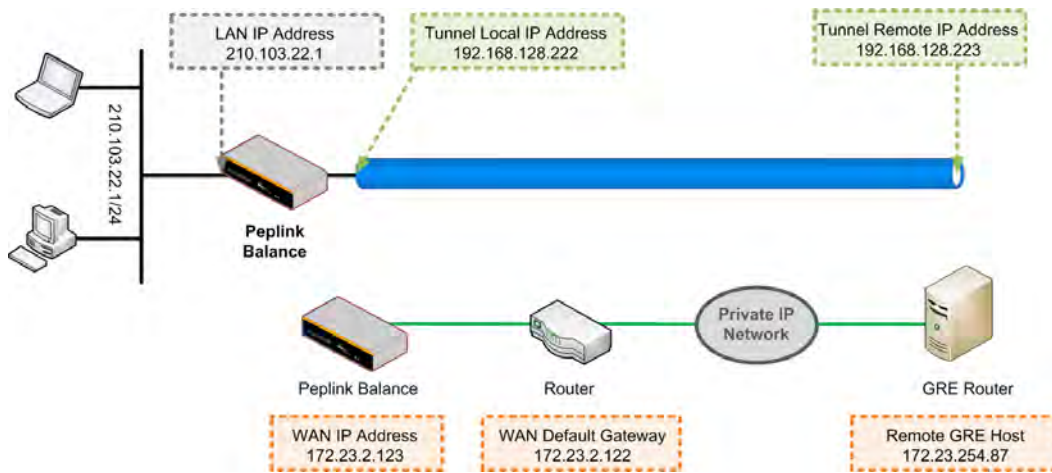

In this scenario, the IP address settings are as follows:

- WAN IP Address: 172.23.2.123
- Default Gateway: 172.23.2.122
- Remote GRE IP address: 172.23.254.87 (the GRE router or host's IP address)
- Tunnel IP remote address: 192.168.128.223 (IP address of remote end of tunnel)
- Tunnel IP local address: 192.168.128.222 (IP address of local end of tunnel)
- LAN IP Address: 210.103.22.1

The following figure shows the packet flow for Peplink Balance under GRE connection mode and IP Forwarding routing mode:

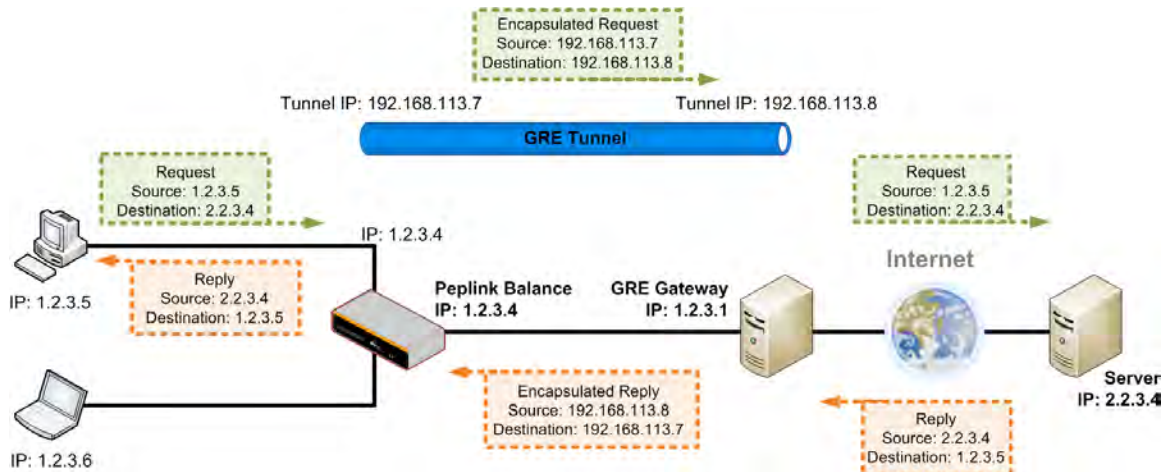

11.1.5 Mobile Internet Connection

(Available on Peplink Balance 20/30, 380+)

The Mobile Internet Connection method is suitable for USB modem mobile connection such as 3G, EVDO, EDGE, and GPRS, etc. Currently it only applies to USB mobile WAN port. For the list of supported modems, please refer to Peplink 3G Modem Support page: <http://www.peplink.com/3g>

| Connection Settings | |
|---|---|
| Enable | <input checked="" type="radio"/> Yes <input type="radio"/> No |
| Connection Type | <input type="radio"/> Always-on <input checked="" type="radio"/> Backup Priority Group 1 (Highest) ▼ |
| Standby State | <input checked="" type="radio"/> Remain connected <input type="radio"/> Disconnect |
| Idle Disconnect | <input checked="" type="checkbox"/> 3 minutes <small>Time value is global. A change will affect all WAN profiles.</small> |
| GRE | <input checked="" type="checkbox"/> Enable |
| Reply to ICMP PING | <input checked="" type="checkbox"/> Enable |
| Operator Settings (for HSPA/EDGE/GPRS only) | <input type="radio"/> Auto <input checked="" type="radio"/> Custom Mobile Operator Settings APN: <input type="text"/> Login ID: <input type="text"/> Password: <input type="text"/> Dial Number: <input type="text"/> |
| Remote GRE Host | <input type="text"/> |
| Tunnel Local IP Address | <input type="text"/> |
| Tunnel Remote IP Address | <input type="text"/> |
| DNS Servers | <input checked="" type="checkbox"/> Use the following DNS server address(es) DNS server 1: <input type="text"/> DNS server 2: <input type="text"/> |

| Connection Settings for Mobile Internet Connection | |
|--|---|
| Enable | Toggle the radio button to Yes to enable the connection. |
| Connection Type | This setting specifies the utilization of the WAN connection. The selection of Always-on results in the WAN connection to be used whenever it is available. If Backup is selected, the WAN connection is treated as a backup connection and is used only in the absence of available Always-on WAN. The default and recommended Connection Type is Always-on . |
| Standby State | This option allows you to choose whether to remain the connection connected or disconnect when this WAN connection is no longer in the highest priority and has entered the standby state. When Remain connected is chosen, upon bringing up this WAN connection to active, it will be immediately available for use. |
| Idle Disconnect | With this option enabled, an idle connection will be disconnected after a specified minutes of time. This time value specified is global and will affect all WAN profiles. The mobile connection will re-establish on demand. |
| GRE | Please refer to Section 11.1.4 for details. |
| Reply to ICMP Ping | If this field is disabled, the WAN connection will not respond to ICMP Ping requests. By default, this is enabled . |

| | |
|---------------------------|--|
| Operator Settings | <p>This setting applies to 3G / EDGE / GPRS modem only. It does not apply to EVDO / EVDO Rev. A modem.</p> <p>This allows you to configure the APN settings of your connection. If Auto is selected, Peplink Balance will automatically detect the APN, configure the modem, and make connection. You may change the APN settings by selecting Custom Mobile Operator Settings.</p> <p>The default and recommended Operator Settings is Auto.</p> <p>The correct values can be obtained from your mobile Internet service provider.</p> |
| SIM PIN (Optional) | <p>This is an optional field which is only needed when there is SIM lock for your SIM card service.</p> |
| DNS Servers | <p>Each ISP may provide a set of DNS servers for DNS lookups. This field specifies the DNS Servers to be used when a DNS lookup is routed through this connection.</p> <p>You can input the ISP provided DNS server addresses into the DNS server 1 and DNS server 2 fields. If no address is entered here, this link will not be used for DNS lookups.</p> <p>This option is enabled automatically and it is required to define the DNS server when GRE is enabled.</p> |

Please refer to Section 11.2, 11.4, 11.5, and 11.6 for details about **WAN Health Check, Bandwidth Allowance Monitor, Additional Public IP Settings, and Dynamic DNS Settings** respectively.

11.1.6 Modem Specific Custom Settings

The following settings may be available depending on the modem model.

| Modem Specific Custom Settings | |
|--------------------------------|--|
| Modem Model | xxx Modem |
| IMSI | 123400005678900 |
| Network Type |  3G preferred ▾ |
| GSM Frequency Band | All Bands ▾ |

| Modem Specific Custom Settings | |
|--------------------------------|---|
| Modem Model | This field displays the Manufacturer name of the connected mobile modem. |
| IMSI | This field shows the IMSI number associated with the SIM inside the mobile modem. |
| Network Type | <p>This setting allows you to define your preference of using the 3G and/or 2G networks. 3G networks include HSPA / UMTS; 2G networks include EDGE / GPRS.</p> <p>If 3G only or 2G only is chosen, only the HSPA / UMTS or EDGE / GPRS network will be used, respectively. If the chosen network is not available, no other network will be used regardless of its availability. The modem connection will remain offline.</p> <p>If 3G preferred or 2G preferred is chosen, the chosen network will be used when it is available. If the chosen network is not available, the other network will be used whenever available.</p> <p>The default Network Type is 3G preferred.</p> |
| GSM Frequency Band | <p>This setting allows you to specify which GSM frequency band to be used.</p> <p>GSM1900 is used in United States, Canada, and many other countries in the Americas.</p> <p>GSM900 / GSM1800 / GSM2100 are used in Europe, Middle East, Africa, Asia, Oceania, and Brazil.</p> <p>If All Bands is chosen, the appropriate frequency band will be used automatically. The default GSM Frequency Band is All Bands.</p> |

11.2 Physical Interface Settings

| Physical Interface Settings | |
|-----------------------------|---|
| Speed | <input type="text" value="Auto"/> |
| MTU | <input type="radio"/> Auto <input checked="" type="radio"/> Custom <input type="text" value="1440"/> <input type="button" value="Default"/> |
| MSS | <input checked="" type="radio"/> Auto <input type="radio"/> Custom <input type="text"/> |
| MAC Address Clone | <input type="radio"/> Default <input checked="" type="radio"/> Custom <input type="text" value="00 : 11 : 11 : 11 : 22 : BB"/> |
| VLAN | <input type="checkbox"/> Enable |

| Physical Interface Settings | |
|-----------------------------|---|
| Speed | <p>This setting specifies port speed and duplex configurations of the WAN Port. By default, Auto is selected and the appropriate data speed is automatically detected by Peplink Balance.</p> <p>In the event of negotiation issues, the port speed can be manually specified to circumvent the issues. You can also choose whether or not to advertise the speed to the peer by selecting the Advertise Speed checkbox.</p> |
| MTU | <p>This setting specifies the Maximum Transmission Unit. By default, MTU is set to Custom 1440.</p> <p>You may adjust the MTU value by editing the text field. Click Default to restore the default MTU value. Select Auto and the appropriate MTU value will be automatically detected. The auto-detection will run each time when the WAN connection establishes.</p> |
| MSS | <p>This setting should be configured based on the maximum payload size that the local system can handle. The MSS (Maximum Segment Size) is computed from the MTU minus 40 bytes for TCP over IPv4.</p> <p>If MTU is set to Auto, the MSS will also be set automatically. By default, MSS is set to Auto.</p> |
| MAC Address Clone | <p>This setting allows you to configure the MAC address. Some service providers (e.g. cable providers) identify the client's MAC address and require the client to always use the same MAC address to connect to the network. In such cases, change the WAN interface's MAC address to the original client PC's one via this field.</p> <p>The default MAC Address is a unique value assigned at the factory. In most cases, the default value is sufficient. Clicking the Default button restores the MAC Address to the default value.</p> |
| VLAN | <p>Some service providers require the router to enable VLAN tagging for Internet traffic. If it is required by your service provider, you can enable this field and enter the VLAN ID that the provider requires.</p> <p><i>Note: Leave this field disabled if you are not sure.</i></p> |

11.3 WAN Health Check

To ensure traffic is routed to healthy WAN connections only, Peplink Balance provides the functionality to periodically check the health of each WAN connection.

The Health Check settings for each WAN connection can be independently configured via **Network > Interfaces > WAN**:

| Health Check Settings | |
|--------------------------|--|
| Method | DNS Lookup |
| Health Check DNS Servers | Host 1: <input type="text"/> Host 2: <input type="text"/> <input checked="" type="checkbox"/> Use first two DNS servers as Health Check DNS Servers <input type="checkbox"/> Include public DNS servers |
| Timeout | 5 second(s) |
| Health Check Interval | 5 second(s) |
| Health Retries | 3 |
| Recovery Retries | 3 |

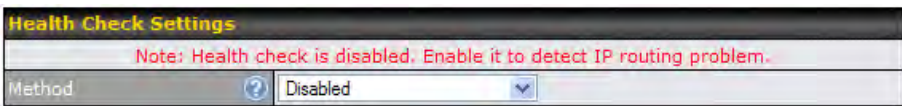
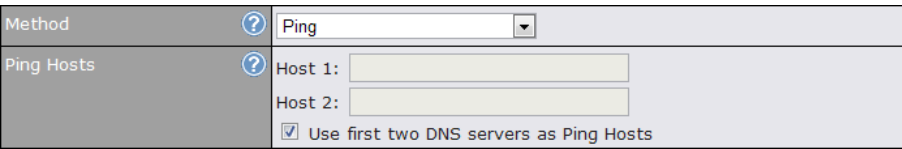
| Health Check Settings | |
|--|--|
| Method | This setting specifies the health check method for the WAN connection. The value of Method can be configured as Disabled , Ping or DNS Lookup . The default method is DNS Lookup . For Mobile Internet connection, the value of Method can be configured as Disabled or SmartCheck . |
| Health Check Disabled | |
|  <p>Note: Health check is disabled. Enable it to detect IP routing problem.</p> | |
| When Disabled is chosen in the Method field, the WAN connection will always be considered as up. The connection will NOT be treated as down in the event of IP routing errors. | |
| Health Check Method: Ping | |
| |  |
| PING Hosts | This setting specifies IP addresses or host names with which connectivity is to be tested via ICMP Ping. If Use first two DNS servers as Ping Hosts is checked, the target PING Host will be the first DNS server for the corresponding WAN connection. Reliable PING hosts with a high uptime should be considered. By default, the first two DNS servers of the WAN connection are used as the PING Hosts. |

Health Check Method: DNS Lookup

| | | |
|--------------------------|---|--|
| Method | ? | DNS Lookup |
| Health Check DNS Servers | ? | Host 1: <input type="text"/> Host 2: <input type="text"/> |
| | | <input checked="" type="checkbox"/> Use first two DNS servers as Health Check DNS Servers <input type="checkbox"/> Include public DNS servers |

DNS lookups will be issued to test the connectivity with target DNS servers. The connection will be treated as up if DNS responses are received from either one or both of the servers, regardless of whether the result was positive or negative.

This field allows you to specify two DNS hosts' IP address with which connectivity is to be tested via DNS Lookup.

If **Use first two DNS servers as Health Check DNS Servers** is checked, the first two DNS servers will be the DNS lookup targets for checking a connection's health. If the box is not checked, field Host 1 must be filled and field Host 2 is optional.

Health Check DNS Servers

If the box **Include public DNS servers** is selected and no response is received from all specified DNS servers, DNS lookups will also be issued to some public DNS servers. A WAN connection will be treated as down only if there is also no response received from the public DNS servers.

Connections will be considered up if DNS responses are received from any one of the health check DNS servers, regardless of a positive or negative result.

By default, the first two DNS servers of the WAN connection are used as the Health Check DNS Servers.

Health Check Method: SmartCheck

| | | |
|------------------------------|---|------------|
| Health Check Settings | | |
| Method | ? | SmartCheck |

SmartCheck applies only to the Peplink Balance 20/30/380 or above Mobile Internet connection. It monitors the link status, and is optimized for mobile networks with high traffic latency.

Other Health Check Settings

| | | | |
|-----------------------|---|---|-----------|
| Timeout | ? | 5 | second(s) |
| Health Check Interval | ? | 5 | second(s) |
| Health Retries | ? | 3 | |
| Recovery Retries | ? | 3 | |

Timeout

This setting specifies the timeout, in seconds, for ping/DNS lookup requests. Default Timeout is set to **5 seconds**.

Health Check Interval

This setting specifies the time interval, in seconds, between ping or DNS lookup requests. Default Health Check Interval is **5 seconds**.

Health Check Retries

This setting specifies the number of consecutive ping/DNS lookup timeouts after which Peplink Balance is to treat the corresponding WAN connection as down. Default Health Retries is set to **3**.

For example, with the default Health Retries setting of 3, after consecutive 3 timeouts, the corresponding WAN connection will be treated as down.

Recovery Retries

This setting specifies the number of consecutive successful ping/DNS lookup responses that must be received before Peplink Balance treats a previously down WAN connection to be up again.

By default, Recover Times is set to **3**. For example, a WAN connection that is treated as down will be considered to be up again upon receiving 3 consecutive successful ping/DNS lookup responses.

Note

In case a WAN connection goes down, all of the WAN connections with non-Always-on Connection Type will also be brought up until any one of higher priority WAN connections is up and found to be healthy. This design could increase the overall network availability.

For example, if WAN1, WAN2 and WAN3 have the connection types of Always-on, Backup Priority Group 1 and Backup Priority Group 2 respectively, when WAN1 goes down, WAN2 and WAN3 will also try to connect. If WAN3 is connected first, WAN2 will still be kept connecting. If WAN2 is connected, WAN3 will disconnect or abort making connection.

Automatic Public DNS Server Check on DNS Test Failure

In case the health check method is set to DNS Lookup and checks failed, the Balance will automatically perform DNS lookups on some public DNS servers. If the tests are success, it means the WAN may not be down but rather the target DNS server became malfunctioned. You will see the following warning message on the Main page.

 **Failed to receive DNS response from the health-check DNS servers for WAN connection 3. But public DNS server lookup test via the WAN passed. So please check the DNS server settings.**

11.4 Bandwidth Allowance Monitor

Bandwidth Allowance Monitor helps keep track of your network usage. Please refer to section 20.8 to view the usage statistics.

| Bandwidth Allowance Monitor Settings | |
|--------------------------------------|--|
| Bandwidth Allowance Monitor | <input checked="" type="checkbox"/> Enable |
| Action | Email notification is currently disabled. You can get notified when usage hits 75%/95% of monthly allowance by enabling Email Notification . <input checked="" type="checkbox"/> Disconnect when usage hits 100% of monthly allowance |
| Start Day | On 1st of each month at 00:00 midnight |
| Monthly Allowance | 100 GB |

| Bandwidth Allowance Monitor | |
|-----------------------------|---|
| Action | If the feature Email Notification is enabled, you will be notified through email when usage hits 75% and 95% of the monthly allowance. If the box Disconnect when usage hits 100% of monthly allowance is checked, this WAN connection will be disconnected automatically when the usage hits the monthly allowance. It will not resume connection unless this option has been turned off or the usage has been reset when a new billing cycle starts. |
| Start Day | This option allows you to define which day in the month each billing cycle begins. |
| Monthly Allowance | This field is for defining the maximum bandwidth usage allowed for the WAN connection each month. |

| Disclaimer | |
|---|--|
| Due to different network protocol overheads and conversions, the amount of data as reported by this Peplink device is not representative of actual billable data usage as metered by your network provider. Peplink disclaims any obligation or responsibility for any events arising out of the use of the numbers shown here. | |

11.5 Additional Public IP Settings

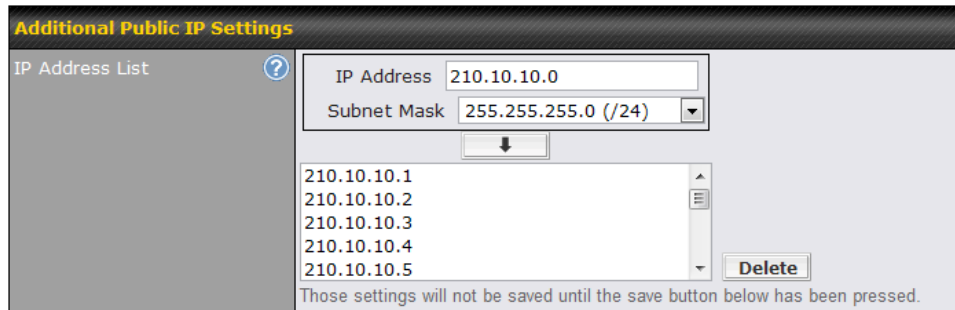

Additional Public IP Settings

IP Address List

The IP Address List represents the list of fixed Internet IP addresses assigned by the ISP, in the event that more than one Internet IP addresses are assigned to this WAN connection.

Enter the fixed Internet IP addresses and the corresponding subnet mask, and then click the **Down Arrow** button to populate IP address entries to the IP Address List.

11.6 Dynamic DNS Settings

Peplink Balance provides the functionality to register the domain name relationships to dynamic DNS service providers. Through registration with dynamic DNS service provider(s), the default public Internet IP address of each WAN connection can be associated with a host name. With Dynamic DNS service enabled for a WAN connection, you can connect to your WAN's IP address from the external even if its IP address is dynamic. You have to register for an account from the listed dynamic DNS service providers before enabling this option.

If the WAN connection's IP address is a reserved private IP address (i.e. behind a NAT router), the Public IP of each WAN will be automatically reported to the DNS service provider.

Either upon a change in IP address or every 23 days without link reconnection, Peplink Balance will connect to the dynamic DNS service provider to perform an IP address update within the provider's records.

The settings for dynamic DNS service provider(s) and the association of host name(s) are configured via **Network > Interfaces > WAN**:

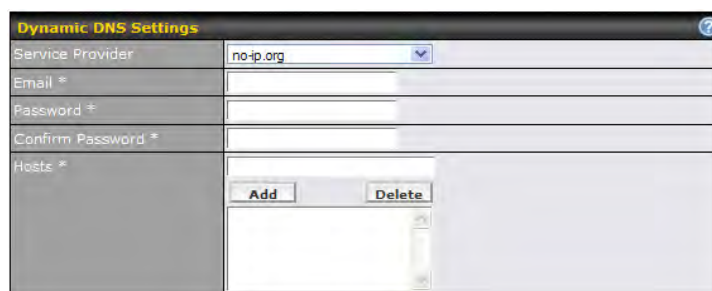

| Dynamic DNS Settings | |
|----------------------------------|--|
| Service Provider | This setting specifies the dynamic DNS service provider to be used for the WAN based on supported dynamic DNS service providers: <ul style="list-style-type: none">• changeip.com• dyndns.org• no-ip.org• tzo.com Select Disabled to disable this feature. |
| User ID / User / Email | This setting specifies the registered user name for the dynamic DNS service. |
| Password / Pass / TZO Key | This setting specifies the password for the dynamic DNS service. |
| Hosts / Domain | This setting specifies a list of host names or domains to be associated with the public Internet IP address of the WAN connection. |

Important Note

In order to use dynamic DNS services, appropriate host name registration(s), as well as a valid account with a supported dynamic DNS service provider are required.

A dynamic DNS update is performed whenever a WAN's IP address changed. E.g. IP is changed after a DHCP IP refresh, reconnection, etc.

Due to dynamic DNS service providers' policy, a dynamic DNS host would expire automatically because the host record was not updated for a long time. Therefore Peplink Balance performs an update every 23 days even if a WAN's IP address did not change.

12 Site-to-Site VPN

(Available on Peplink Balance 210+)



Peplink Balance Site-to-Site VPN functionality securely connects one or more branch offices to your company's main headquarters or to other branches. The data, voice, or video communications between these locations are kept confidential across the public Internet.

The Site-to-Site VPN of the Peplink Balance is specifically designed for multi-WAN environment. The Peplink Balance can aggregate all WAN connections' bandwidth for routing Site-to-Site VPN traffic. Unless all the WAN connections of one site are down, the Peplink Balance can still maintain VPN up and running.

VPN Bandwidth Bonding is supported in firmware 5.0+. All available bandwidth will be utilized to establish the VPN tunnel, and all traffic will be load balanced at packet level across all links. VPN Bandwidth Bonding is enabled by default.

Tip

You can define firewall rules to control access within the VPN network. Outbound traffic can be redirected and go through VPN tunnels with custom outbound policies, please refer to section 13 for details

12.1 Site-to-Site VPN Settings

Peplink Balance 380, 580, 710 and 1350 support making multiple Site-to-Site VPN connections with a remote Peplink Balance 210, 310, 380, 580, 710, 1350, or a Pepwave MAX Mobile Router. Peplink Balance 210 and 310 support making two Site-to-Site VPN connections with a remote Peplink Balance 210, 310, 380, 580, 710, 1350, or a Pepwave MAX Mobile Router.

Peplink Balance that supports multiple VPN connections can act as a central hub which connects branch offices. For example, branch office A and branch office B make VPN connections to headquarters C, both branch offices' LAN subnet and subnets behind it (i.e. static routes) will also be advertised to the headquarters C and the other branches. So branch office A will be able to access branch office B via headquarters C in this case.

The local LAN subnet and subnets behind the LAN (defined under **Static Route** in the LAN settings page) will be advertised to the VPN. All VPN members (branch offices and headquarters) will be able to route to the local subnets.

Note that all LAN subnet and subnets behind it have to be unique. Otherwise, VPN members will not be able to access each other.

All data can be routed over the VPN with 256-bit AES encryption standard.

To configure, navigate to **Network > Site-to-Site VPN**:

| VPN Connection | Peer Serial Number | Peer Address(es) | |
|--------------------|--------------------|--|--------|
| Branch A | 1824-1234-ABCD | 192.168.50.11 192.168.50.12 | Delete |
| Branch B | 1824-ABCD-1234 | 10.10.10.151 10.10.10.152 10.10.10.153 | Delete |
| Add VPN Connection | | | |

| Link Failure Detection | |
|--|---|
| Link Failure Detection Time ? | <input checked="" type="radio"/> Recommended (Approx. 15 secs) <input type="radio"/> Fast (Approx. 6 secs) <input type="radio"/> Faster (Approx. 2 secs) <input type="radio"/> Extreme (Under 1 sec) |
| Shorter detection time incurs more health checks and higher bandwidth overhead | |
| <input type="button" value="Save"/> | |

A list of defined **VPN Connection** profiles and **Link Failure Detection Time** option will be shown. Click the **Add VPN Connection** button to create a new VPN connection profile for making VPN connection to a remote Peplink Balance via the available WAN connections. Each profile is for making VPN connection with one remote Peplink Balance. Click a connection name on the leftmost column to edit the profile.

| VPN Settings | |
|---|---|
| VPN Connection Name ? | <input type="text" value="Headquarters"/> |
| Active | <input checked="" type="checkbox"/> |
| Encryption ? | <input checked="" type="radio"/> 256-bit AES <input type="radio"/> Off |
| Peer Serial Number ? | <input type="text" value="124-1234-1234"/> <input type="checkbox"/> Remote client is set up in high availability mode. |
| Pre-shared Key (Optional) | <input type="text"/> <input checked="" type="checkbox"/> Hide Characters |
| Peer IP Addresses / Host Names (Optional) ? | <input type="text"/> <small>If this field is empty, this field on the peer site must be filled</small> |

| VPN Settings | |
|--|--|
| VPN Connection Name | This field is for specifying a name to represent this VPN connection profile. |
| Active | When this box is checked, this VPN connection profile will be enabled. Otherwise, it will be disabled. |
| Encryption | By default, VPN traffic is encrypted with 256-bit AES standard . If the option Off is selected on both sides of a VPN connection, no encryption will be applied. |
| Peer Serial Number | Peplink Balance only establishes VPN connection with a remote peer that has a serial number specified here. If the remote peer is in high availability setup, you can check the box Remote client is set up in high availability mode and enter the second unit's serial number into the second text box. |
| Pre-shared Key | This is an optional field which defines the pre-shared key used for this particular VPN connection. The VPN connection's session key will be further protected by the factor of the pre-shared key. The connection will be up only if the pre-shared keys on each side match. When the remote peer is running firmware 5.0 or 5.1, this setting will be ignored. |
| Peer IP Addresses / Host Names (Optional) | Enter the remote peer's WAN IP address(es) or host name(s) here. Dynamic-DNS host names are accepted. This field is optional. With this field filled, the Peplink Balance will initiate connection to each of the remote IP addresses until success. If the field is empty, the Peplink Balance will wait for connection from the remote peer. Therefore, at least one side of the two VPN peers has to have this field filled. Otherwise, VPN connection cannot be established. Enter one IP address or host name per line. |

WAN Connection Priority

WAN Connection Priority

You can specify the priority of the WAN connections to be used in making VPN connections. A WAN connection will never be used when **OFF** is selected. Only available WAN connections with the highest priority will be utilized.

Link Failure Detection

Link Failure Detection Time

The bonded Site-to-Site VPN can detect routing failures on the path between two sites over each WAN connection. Failed WAN connections will not be used to route VPN traffic. Health check packets are sent to the peer to detect any failure. The more frequent checks it sends, the shorter detection time, but the higher bandwidth overhead will be consumed.

When **Recommended** is selected, a health check packet is sent out every 5 seconds, and the expected detection time is 15 seconds.

When **Fast** is selected, a health check packet is sent out every 3 seconds, and the expected detection time is 6 seconds.

When **Faster** is selected, a health check packet is sent out every 1 second, and the expected detection time is 2 seconds.

When **Extreme** is selected, a health check packet is sent out every 0.1 second, and the expected detection time is under 1 second.

By default, **Recommended** is selected.

Important Note to Users Upgrading to Firmware 5.0+

The Site-to-Site VPN in firmware 5.0+ requires the same firmware version for all devices in the VPN network. Please make sure that both ends of the Peplink Balance units are running with the same firmware version.

Important Note

- When outbound Internet traffic is routed to remote Site-to-Site VPN peer, the remote peer will route the traffic to its first available WAN connection only.
- Peplink proprietary Site-to-Site VPN used TCP and UDP port 32015 for establishing VPN connections. If you have a firewall in front of the Peplink Balance devices, you will need to add firewall rules for these port and protocols which will allow inbound and outbound traffic pass-through the firewall.

Tip

Want to know more about VPN Sub-Second Session Failover? Visit our [YouTube Channel](http://www.youtube.com/PeplinkChannel#p/u/0/FXPAJ37b4pQ) for a video tutorial!



<http://www.youtube.com/PeplinkChannel#p/u/0/FXPAJ37b4pQ>

12.2 Peplink Balance Behind NAT Router

The Peplink Balance supports establishing Site-to-Site VPN over WAN connections which are behind a NAT (Network Address Translation) router.

To be able for a WAN connection behind a NAT router to accept VPN connections, you can configure the NAT router in front of the WAN connection to inbound port forward TCP port 32015 to the Peplink Balance.

If one or more WAN connections on **Unit A** can accept VPN connections (by means of port forwarding or not) while none of the WAN connections on the peer **Unit B** can do so, you should put all public IP addresses or host names of the **Unit A** to the **Unit B's Peer IP Addresses / Host Names** field. Leave the field in **Unit A** blank. With such setting, site-to-site VPN connection can be set up and all WAN connections on both sides will be utilized.

For example, see the following diagram:

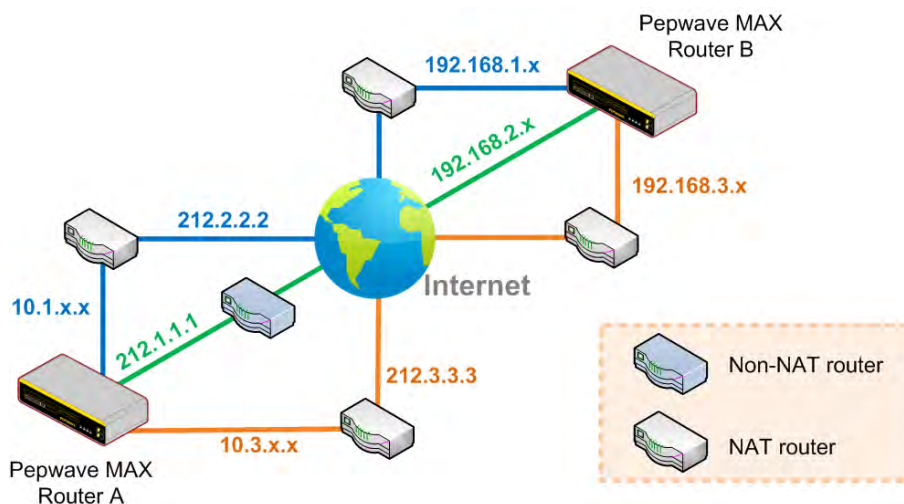

One of the WANs of Balance A is non-NAT'd (212.1.1.1). The rest of the WANs on Balance A and all WANs on Balance B are NAT'd. In such case, the **Peer IP Addresses / Host Names** field in Balance B should be filled with all of the Balance A's host names or public IP addresses (i.e. 212.1.1.1, 212.2.2.2 and 212.3.3.3), and the field in Balance A can be left blank. The two NAT routers on WAN1 and WAN3 of Balance A should inbound port forward TCP port 32015 to the Balance A so that all WANs would be utilized to establish VPN.

12.3 VPN Status

VPN Status is shown in the **Dashboard**. The connection status of each connection profile is shown as below.

| Site-to-Site VPN | | Details |
|------------------|---|---------|
| Branch A |  Established | |
| Branch B |  Connecting... | |

VPN connection status is also shown on the LCD panel of Peplink Balance 380, 580, 710 and 1350.

By clicking the **Details** button at the top-right hand corner of Site-to-Site VPN table, you will be forwarded to **Status > Site-to-Site VPN**. You can view the subnet and WAN connection information of each VPN peer. Please refer to section 20.5 for details.

IP subnets must be unique among VPN peers

The entire inter-connected Site-to-Site VPN network is one single non-NAT IP network. No two subnets in two sites shall be duplicated. Otherwise, connectivity problems will be experienced in accessing those subnets.

13 Management of Outbound Traffic to WAN

Peplink Balance provides the functionality to flexibly manage and load balance outbound traffic among the WAN connections.

Important Note

Outbound Policy is applied only when more than one WAN connection is active.

The settings for managing and load balancing outbound traffic are located in **Network > Outbound Policy**:

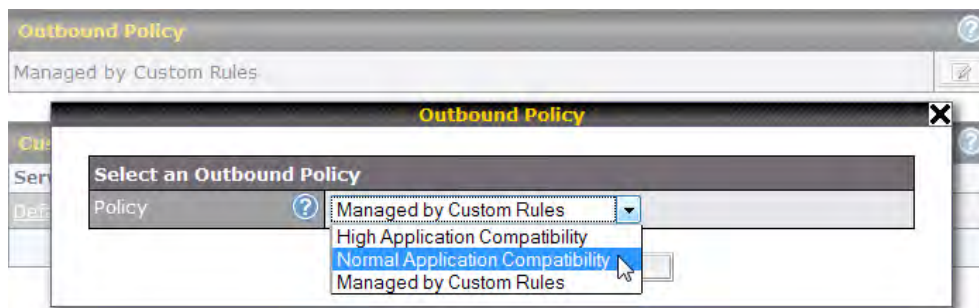

13.1 Outbound Policy

There are three main selections for the Outbound Traffic Policy of Peplink Balance:

- High Application Compatibility
- Normal Application Compatibility
- Managed by Custom Rules

The selections are explained as follows:

| Outbound Policy Settings | |
|---|--|
| High Application Compatibility | With the selection of this policy, outbound traffic from a source LAN device is routed through the same WAN connection regardless of the destination Internet IP address and protocol. This provides the highest application compatibility. |
| Normal Application Compatibility | With the selection of this policy, outbound traffic from a source LAN device to the same destination Internet IP address will persistently be routed through the same WAN connection regardless of protocol. This provides high compatibility to most applications, and users still benefit from WAN link load balancing when multiple Internet servers are accessed. |
| Managed by Custom Rules | With the selection of this policy, outbound traffic behavior can be managed by defining custom rules. Rules can be defined in a custom rule table. A default rule can be defined for connections that cannot be matched with any one of the rules. |

The default policy is **Normal Application Compatibility**.

Tip

Want to know more about how-to create outbound rules? Visit our [YouTube Channel](#) for a video tutorial!

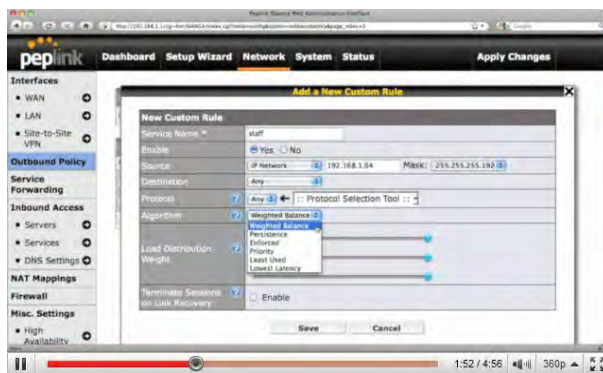

http://www.youtube.com/PeplinkChannel#p/u/2/m977ePdM_sl

13.2 Custom Rules For Outbound Policy

Click  in the Outbound Policy form. Choose **Managed by Custom Rules** and press the **Save** button. The following screen will then be displayed.

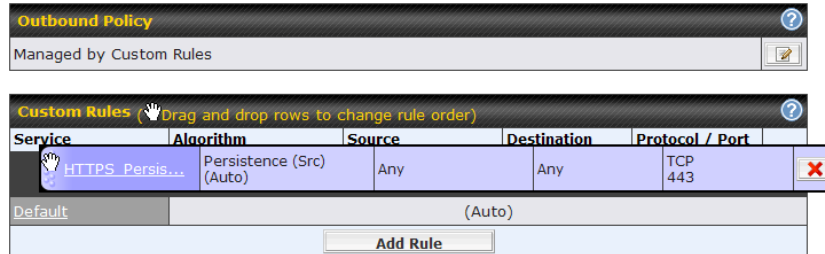

| Service | Algorithm | Source | Destination | Protocol / Port |
|-----------------|--------------------------|--------|-------------|-----------------|
| HTTPS Persis... | Persistence (Src) (Auto) | Any | Any | TCP 443 |
| Default | (Auto) | | | |

The bottom-most rule is **Default**. Edit this rule to change the device's default way to control outbound traffic for all connections that does not match any rules above it. Click on the service name **Default** to change its settings.

You may drag and drop a row to rearrange the priority of outbound rules.

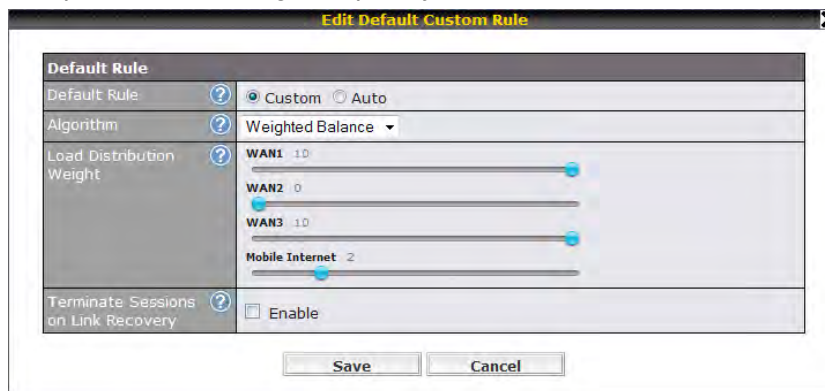

Edit Default Custom Rule

Default Rule

Default Rule: Custom Auto

Algorithm: Weighted Balance

Load Distribution Weight:

- WAN1: 10
- WAN2: 0
- WAN3: 10
- Mobile Internet: 2

Terminate Sessions on Link Recovery: Enable

By default, **Auto** is selected for the option **Default Rule**. You can select **Custom** in order to change the Algorithm to be used. Please refer to the upcoming sections for the details of the available algorithms.

To create a custom rule, click **Add Rule** at the bottom of the table, and the following window will be displayed:

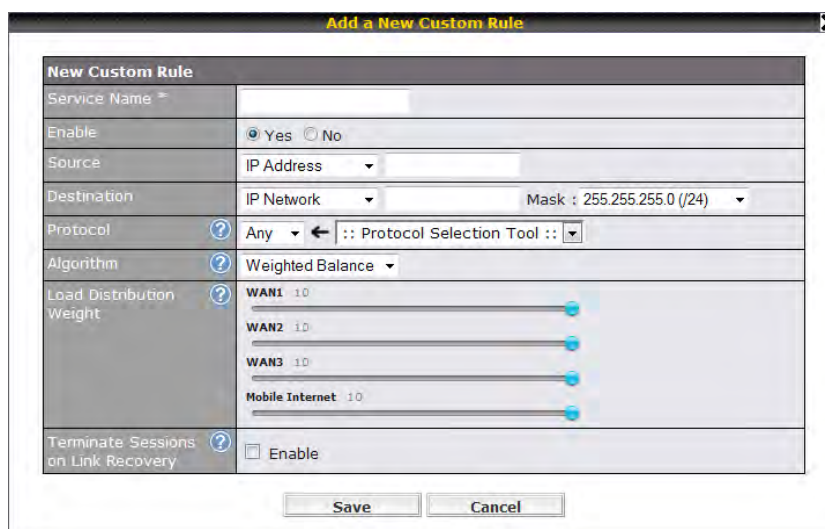

Add a New Custom Rule

New Custom Rule

Service Name:

Enable: Yes No

Source: IP Address

Destination: IP Network Mask: 255.255.255.0 (/24)

Protocol: Any

Algorithm: Weighted Balance

Load Distribution Weight:

- WAN1: 10
- WAN2: 10
- WAN3: 10
- Mobile Internet: 10

Terminate Sessions on Link Recovery: Enable

| New Custom Rule Settings | |
|--|---|
| Service Name | This setting specifies the name of the outbound traffic rule. |
| Enable | <p>This setting specifies whether the outbound traffic rule takes effect.</p> <p>With an Enable value of Yes, the rule takes effect: traffic is matched, and actions are taken, by Peplink Balance based on the other parameters of the rule.</p> <p>With an Enable value of No, the rule does not take effect: Peplink Balance disregards the other parameters of the rule.</p> |
| Source | This setting specifies the source IP Address, IP Network or MAC Address for traffic that matches the rule. |
| Destination | This setting specifies the destination IP Address or IP Network for traffic that matches the rule. |
| Protocol and Port | This setting specifies the IP Protocol and Port of traffic that matches this rule. You may select some common protocol from the Protocol Selection Tool drop-down menu. |
| Algorithm | <p>This setting specifies the behavior of Peplink Balance for the custom rule.</p> <p>One of the following values can be selected:</p> <ul style="list-style-type: none"> • Weighted Balance • Persistence • Enforced • Priority • Overflow • Least Used (not applicable to Balance 20/30) • Lowest Latency (not applicable to Balance 20/30) <p>The upcoming sections present the details of the listed algorithms.</p> |
| Terminate Sessions on Link Recovery | <p>This setting specifies whether to terminate existing IP sessions on a less preferred WAN connection in the event that a more preferred WAN connection is recovered. This setting is applicable to the Algorithms: Weighted, Persistence and Priority.</p> <p>By default, this is disabled. In this case, all existing IP sessions will not be terminated or affected when any other WAN connection is recovered. If it is set to enabled, existing IP sessions may be terminated when another WAN connection is recovered such that only the preferred healthy WAN connection(s) are used at any point in time.</p> |

13.2.1 Algorithm: Weighted Balance

This setting specifies the ratio of WAN connection usage to be applied on the specified IP Protocol & Port, and is applicable only when Algorithm is set to **Weighted Balance**.



The amount of matching traffic that is distributed to a WAN connection is proportional to the weight of WAN connection relative to the total weight. Use the sliders to change each WAN's weight.

Example: With the following weight settings on a Peplink Balance 310:

- WAN1: 10
- WAN2: 10
- WAN3: 5

Total weight is 25 = (10 + 10 + 5)

Matching traffic distributed to WAN1 is 40% = (10 / 25) x 100%

Matching traffic distributed to WAN2 is 40% = (10 / 25) x 100%

Matching traffic distributed to WAN3 is 20% = (5 / 25) x 100%

13.2.2 Algorithm: Persistence

The configuration of Persistent Services is the solution to the few situations where link load distribution for Internet services is undesirable.

For example, many e-banking and other secure websites, for security reasons, terminate the session when the client computer's Internet IP address changes mid-session.

In general, different Internet IP addresses represent different computers. The security concern is that an IP address change during a session may be the result of an unauthorized intrusion attempt. Therefore, to prevent damages from the potential intrusion, the session is terminated upon the detection of an IP address change.

Peplink Balance can be configured to distribute data traffic across multiple WAN connections. Also, the Internet IP depends on the WAN connections over which communication actually takes place. As a result, a LAN client computer behind Peplink Balance may communicate using multiple Internet IP addresses. For example, a LAN client computer behind a Peplink Balance 310 with three WAN connections may communicate on the Internet using three different IP addresses.

With the Persistency feature of Peplink Balance, rules can be configured to enable client computers to persistently utilize the same WAN connections for e-banking and other secure websites. As a result, a client computer will communicate using one IP address and eliminate the issues.

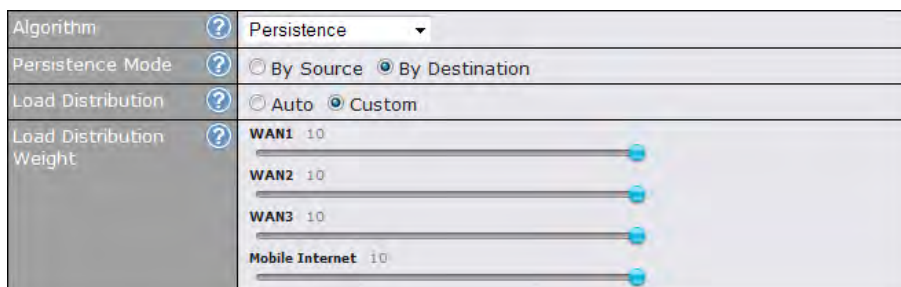

There are two Persistent Modes. One is **by source** and the other **by destination**.

By Source: The same WAN connection will be used for traffic matching the rule and originating from the same machine regardless of its destination. This option will provide the highest level of application compatibility.

By Destination: The same WAN connection will be used for traffic matching the rule, originating from the same machine, and going to the same destination. This option can better distribute load to WAN connections when there are only a few client machines.

The default Mode is **By Source**.

When there are multiple client requests, they can be distributed (persistently) to WAN connections with a weight. If you choose **Auto** in **Load Distribution**, the weights will be automatically adjusted according to each WAN's **Download Bandwidth** which is specified in the WAN settings page (see Section 11 Configuration of WAN Interface(s)). If you choose **Custom**, you can customize the weight of each WAN manually by using the sliders.

13.2.3 Algorithm: Enforced

This setting specifies the WAN connection usage to be applied on the specified IP Protocol & Port, and is applicable only when the Algorithm is set to **Enforced**.

| | |
|---------------------|--|
| Algorithm | Enforced |
| Enforced Connection | WAN: WAN1 WAN: WAN2 WAN: WAN3 VPN: Headquarters VPN: Branch Office 1 |

Matching traffic will be routed through the specified WAN connection regardless of health check status of the WAN connection.

Starting from firmware 5.2, outbound traffic can be enforced to go through a specified Site-to-Site VPN connection. **(Available on Peplink Balance 210+)**

13.2.4 Algorithm: Priority

This setting specifies the priority of the WAN connections to be utilized to route the specified network service. The highest priority WAN connection available will always be used for routing the specified type of traffic. A lower priority WAN connection will be used only when all higher priority connections have become unavailable.

| | | | | | | | | | | | |
|------------------|---|------------------|------------|-----------|-------------------|-----------|----------------------|-----------|--|-----------------|--|
| Algorithm | Priority | | | | | | | | | | |
| Priority Order | <table border="1"> <tr> <td>Highest Priority</td> <td>Not In Use</td> </tr> <tr> <td>WAN: WAN1</td> <td>VPN: Headquarters</td> </tr> <tr> <td>WAN: WAN2</td> <td>VPN: Branch Office 1</td> </tr> <tr> <td>WAN: WAN3</td> <td></td> </tr> <tr> <td>Lowest Priority</td> <td></td> </tr> </table> | Highest Priority | Not In Use | WAN: WAN1 | VPN: Headquarters | WAN: WAN2 | VPN: Branch Office 1 | WAN: WAN3 | | Lowest Priority | |
| Highest Priority | Not In Use | | | | | | | | | | |
| WAN: WAN1 | VPN: Headquarters | | | | | | | | | | |
| WAN: WAN2 | VPN: Branch Office 1 | | | | | | | | | | |
| WAN: WAN3 | | | | | | | | | | | |
| Lowest Priority | | | | | | | | | | | |

Starting from firmware 5.2, outbound traffic can be prioritized to go through Site-to-Site VPN connection(s). By default, VPN connections are not included in the priority list. **(Available on Peplink Balance 210+)**

Tip

Configure multiple distribution rules to accommodate different kinds of services.

13.2.5 Algorithm: Overflow

The traffic matching this rule will be routed through the healthy WAN connection that has the highest priority and is not in full load. When this connection gets saturated, new sessions will be routed to the next healthy WAN connection that is not in full load.

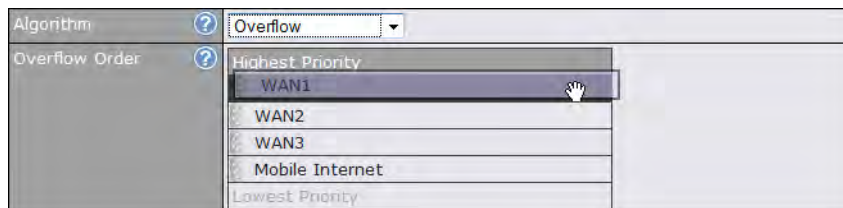

Drag and drop to specify the order of WAN connections to be used for routing traffic. Only the highest priority healthy connection that is not in full load will be utilized.

13.2.6 Algorithm: Least Used

(Available on Peplink Balance 210+)

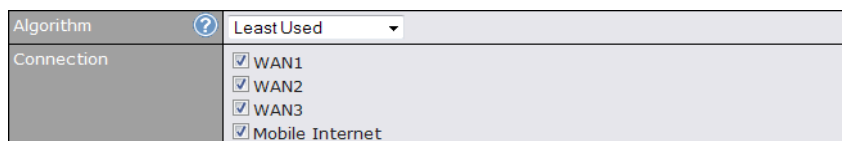

The traffic matching this rule will be routed through the healthy WAN connection that is selected in the field **Connection** and has the most available download bandwidth. The available download bandwidth of a WAN connection is calculated from the total download bandwidth specified in the WAN settings page and the current download usage. The available bandwidth and WAN selection is determined every time when an IP session is made.

13.2.7 Algorithm: Lowest Latency

(Available on Peplink Balance 210+)

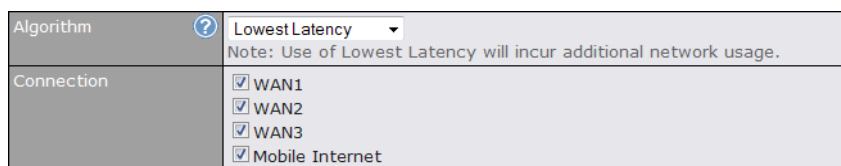

The traffic matching this rule will be routed through the healthy WAN connection that is selected in the field *Connection* and has the lowest latency. Latency checking packets are issued periodically to a nearby router of each WAN connection to determine its latency value. The latency of a WAN is the packet round trip time of the WAN connection. Additional network usage may be incurred as a result.

Tip

The round trip time of a “6M down / 640k up” link can be higher than that of a “2M down / 2M up” link. It is because the overall round trip time is lengthened by its slower upload bandwidth despite of its higher downlink speed.

Therefore this algorithm is good for two scenarios:

- All WAN connections are symmetric; or
- A latency sensitive application requires to be routed through the lowest latency WAN regardless the WAN's available bandwidth.

13.2.8 Expert Mode

Expert Mode is available for advance users. To enable the feature, click on the help test balloon and click the link **turn on Expert Mode**.

Under Expert Mode, a new special rule - "Site-to-Site VPN Routes" is displayed on the Custom Rules table. It represents all Site-to-Site VPN routes learned from remote VPN peers. By default, this bar is on the top of all custom rules. That means traffic for remote VPN subnets will be routed to its corresponding VPN peer. You can create custom **Priority** or **Enforced** rules and move them above the bar to override the Site-to-Site VPN Routes.

Upon disabling the Expert Mode, all rules above the bar will be removed.

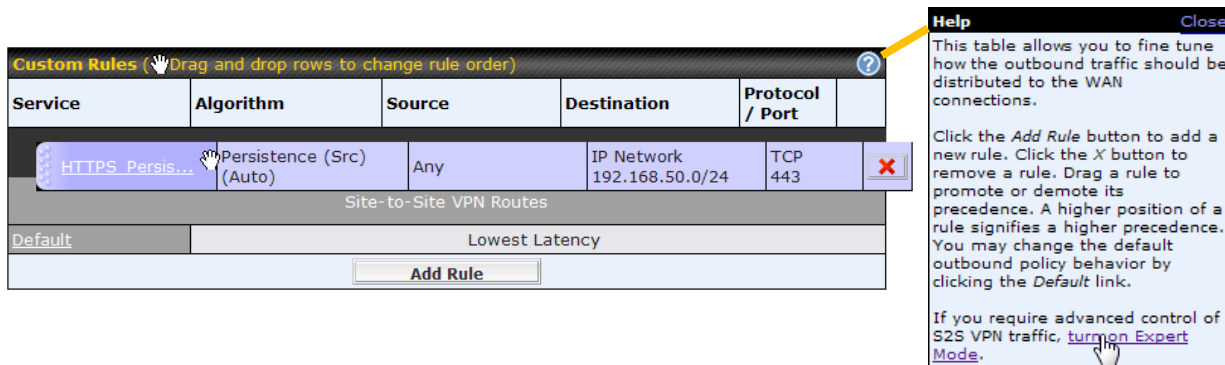

| Service | Algorithm | Source | Destination | Protocol / Port | |
|-----------------|-----------------------------|--------|-------------------------------|-----------------|---|
| HTTPS_Persis... | Persistence (Src) (Auto) | Any | IP Network 192.168.50.0/24 | TCP 443 | X |

Site-to-Site VPN Routes

Default Lowest Latency

Add Rule

Help Close

This table allows you to fine tune how the outbound traffic should be distributed to the WAN connections.

Click the *Add Rule* button to add a new rule. Click the *X* button to remove a rule. Drag a rule to promote or demote its precedence. A higher position of a rule signifies a higher precedence. You may change the default outbound policy behavior by clicking the *Default* link.

If you require advanced control of S2S VPN traffic, [turn on Expert Mode](#).

14 Inbound Access

Inbound Access is also known as inbound port address translation. On NAT WAN connection, all inbound traffic to the server behind Peplink unit requires Inbound Access rules.

By the custom definition of servers and services for inbound access, Internet users can access the servers behind Peplink Balance. Advanced configurations allow inbound access to be distributed among multiple servers on the LAN.

Important Note

Inbound Access applies only to WAN connections that operate under NAT mode. For WAN connections that operate under drop-in mode or IP forwarding, inbound traffic is forwarded to the LAN by default.

14.1 Definition of Port Forwarding

(Available on Peplink Balance 20/30)

Inbound Port Forwarding rules are defined at: **Network > Inbound Access > Port Forwarding**

| Service | IP Address(es) | Server | Protocol | Action |
|-------------|--------------------|--------------|----------|--------|
| Web | WAN1: Interface IP | 192.168.10.1 | TCP:80 | Delete |
| Add Service | | | | |

To define a new service, click the **Add Service** button, upon which the following appears:

| Enable | <input checked="" type="radio"/> Yes <input type="radio"/> No | | | | | | | | | | | | | | | | | | | | | | | | | | | | |
|--|---|-----------------------------|--------------------------|-----|-------|--|---|--------------------------|--------------------------|--|--|--------------------------|--------------------------|--|---|--------------------------|--------------------------|-------------------------------|--|--------------------------|--------------------------|-------------------------------|--|--------------------------|--------------------------|--|--|--------------------------|--------------------------|
| Service Name * | Web | | | | | | | | | | | | | | | | | | | | | | | | | | | | |
| IP Protocol | TCP ← HTTP | | | | | | | | | | | | | | | | | | | | | | | | | | | | |
| Port | Single Port Service Port: 80 | | | | | | | | | | | | | | | | | | | | | | | | | | | | |
| Inbound IP Address(es) * <small>(Require at least one IP address)</small> | <table border="1"> <thead> <tr> <th colspan="2">Connection / IP Address(es)</th> <th>All</th> <th>Clear</th> </tr> </thead> <tbody> <tr> <td><input checked="" type="checkbox"/> WAN1</td> <td><input checked="" type="checkbox"/> 218.100.66.100 (Interface IP)</td> <td><input type="checkbox"/></td> <td><input type="checkbox"/></td> </tr> <tr> <td></td> <td><input type="checkbox"/> 218.100.66.66</td> <td><input type="checkbox"/></td> <td><input type="checkbox"/></td> </tr> <tr> <td></td> <td><input type="checkbox"/> 218.100.66.103</td> <td><input type="checkbox"/></td> <td><input type="checkbox"/></td> </tr> <tr> <td><input type="checkbox"/> WAN2</td> <td></td> <td><input type="checkbox"/></td> <td><input type="checkbox"/></td> </tr> <tr> <td><input type="checkbox"/> WAN3</td> <td></td> <td><input type="checkbox"/></td> <td><input type="checkbox"/></td> </tr> <tr> <td><input type="checkbox"/> Mobile Internet</td> <td></td> <td><input type="checkbox"/></td> <td><input type="checkbox"/></td> </tr> </tbody> </table> | Connection / IP Address(es) | | All | Clear | <input checked="" type="checkbox"/> WAN1 | <input checked="" type="checkbox"/> 218.100.66.100 (Interface IP) | <input type="checkbox"/> | <input type="checkbox"/> | | <input type="checkbox"/> 218.100.66.66 | <input type="checkbox"/> | <input type="checkbox"/> | | <input type="checkbox"/> 218.100.66.103 | <input type="checkbox"/> | <input type="checkbox"/> | <input type="checkbox"/> WAN2 | | <input type="checkbox"/> | <input type="checkbox"/> | <input type="checkbox"/> WAN3 | | <input type="checkbox"/> | <input type="checkbox"/> | <input type="checkbox"/> Mobile Internet | | <input type="checkbox"/> | <input type="checkbox"/> |
| Connection / IP Address(es) | | All | Clear | | | | | | | | | | | | | | | | | | | | | | | | | | |
| <input checked="" type="checkbox"/> WAN1 | <input checked="" type="checkbox"/> 218.100.66.100 (Interface IP) | <input type="checkbox"/> | <input type="checkbox"/> | | | | | | | | | | | | | | | | | | | | | | | | | | |
| | <input type="checkbox"/> 218.100.66.66 | <input type="checkbox"/> | <input type="checkbox"/> | | | | | | | | | | | | | | | | | | | | | | | | | | |
| | <input type="checkbox"/> 218.100.66.103 | <input type="checkbox"/> | <input type="checkbox"/> | | | | | | | | | | | | | | | | | | | | | | | | | | |
| <input type="checkbox"/> WAN2 | | <input type="checkbox"/> | <input type="checkbox"/> | | | | | | | | | | | | | | | | | | | | | | | | | | |
| <input type="checkbox"/> WAN3 | | <input type="checkbox"/> | <input type="checkbox"/> | | | | | | | | | | | | | | | | | | | | | | | | | | |
| <input type="checkbox"/> Mobile Internet | | <input type="checkbox"/> | <input type="checkbox"/> | | | | | | | | | | | | | | | | | | | | | | | | | | |
| Server IP Address | 192.168.1.10 | | | | | | | | | | | | | | | | | | | | | | | | | | | | |

* Required Fields

Save Cancel

Port Forwarding Settings

Enable

This setting specifies whether the Inbound Service takes effect. With an Enable value of **Yes**, the inbound service takes effect: traffic is matched, and actions are taken, by Peplink Balance based on the other parameters of the rule. With an Enable value of **No**, the inbound service does not take effect: Peplink Balance disregards the other parameters of the rule.

Service Name

This setting identifies the service to the System Administrator. Valid values for this setting consist only of alphanumeric and the underscore “_” characters.

IP Protocol

The IP Protocol setting, along with the Port setting, specifies the protocol of the service as TCP, UDP, ICMP or IP.

Traffic that is received by Peplink Balance via the specified protocol at the specified port(s) is forwarded to the LAN hosts specified by the Servers setting.

(Please refer below for details on the Port and Servers settings.)

Alternatively, the **Protocol Selection Tool** drop-down menu can be used to automatically fill in the Protocol and a single Port number of common Internet services (e.g. HTTP, HTTPS, etc.)

After selecting an item from the **Protocol Selection Tool** drop-down menu, the Protocol and Port number remains manually modifiable.

The Port setting specifies the port(s) that correspond to the service, and can be configured to behave in one of the following manners:

Any Port, Single Port, Port Range, Port Map and Range Mapping

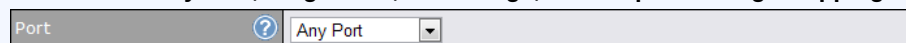

Any Port: all traffic that is received by Peplink Balance via the specified protocol is forwarded to the servers specified by the Servers setting.

For example, with IP Protocol set to **TCP**, and Port set to **Any Port**, all TCP traffic is forwarded to the configured servers.



Single Port: traffic that is received by Peplink Balance via the specified protocol at the specified port is forwarded via the same port to the servers specified by the Servers setting.

For example, with IP Protocol set to **TCP**, and Port set to **Single Port** and **Service Port 80**, TCP traffic received on Port 80 is forwarded to the configured servers via Port 80.

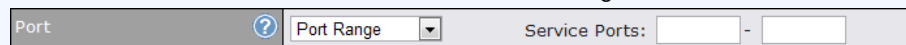

Port Range: traffic that is received by Peplink Balance via the specified protocol at the specified port range is forwarded via the same respective ports to the LAN hosts specified by the Servers setting.

For example, with IP Protocol set to **TCP**, and Port set to **Port Range** and **Service Port 80-88**, TCP traffic received on ports 80 through 88 is forwarded to the configured servers via the respective ports.



Port Mapping: traffic that is received by Peplink Balance via the specified protocol at the specified port is forwarded via a different port to the servers specified by the Servers setting.

For example, with IP Protocol set to **TCP**, and Port set to **Port Mapping**, **Service Port 80**, and **Map to Port 88**, TCP traffic on Port 80 is forwarded to the configured servers via Port 88.

(Please see below for details on the Servers setting.)

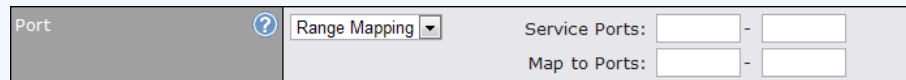

Range Mapping: traffic that is received by Peplink Balance via the specified protocol at the specified port range is forwarded via a different port to the servers specified by the Servers setting.

Port

Inbound IP Address(es)

This setting specifies the WAN connections and Internet IP address(es) from which the service can be accessed.

Server IP Address

This setting specifies the LAN IP address of the server that handles the requests for the service.

14.2 Definition of Servers on LAN

(Available on Peplink Balance 210+)

The settings to configure servers on the LAN are located at the following location: **Network > Inbound Access > Servers**

Inbound connections from the Internet will be forwarded to the specified Inbound IP Address(es) base on the protocol and port number .

When more than one server is defined, requests will be distributed to the servers in the weight ratio specified for each server.

| Server Name | IP Address | |
|---|------------|--|
| No Servers Defined | | |
| <input type="button" value="Add Server"/> | | |

To define a new server, click **Add Server**, upon which the following screen appears:

| | |
|---------------|--|
| Server Name * | <input type="text" value="myserver"/> |
| IP Address * | <input type="text" value="192.168.1.123"/> |

* Required

Enter a valid server name, and its corresponding LAN IP address.

Upon clicking **Save** after entering required information, the following screen appears.

| Server Name | IP Address | |
|---|---------------|---------------------------------------|
| myserver | 192.168.1.123 | <input type="button" value="Delete"/> |
| <input type="button" value="Add Server"/> | | |

To define additional servers, click **Add Server** and repeat the above steps.

14.3 Inbound Access Services

14.3.1 Definition of Services

Services are defined at: **Network > Inbound Access > Services**

| Service | IP Address(es) | Server | Protocol | Action |
|-----------------------------|----------------|--------|----------|--------|
| No Services Defined | | | | |
| Add Service | | | | |

Tip

At least one server must be defined before services can be added.

To define a new service, click the **Add Service** button, upon which the following appears:

| Enable | <input checked="" type="radio"/> Yes <input type="radio"/> No | | | | | | | | | | | | | | | | | | | | |
|--|---|-----------------------------|-------|--------|--|--|--|--|--|-------------------------------|--|--|--|-------------------------------|--|--|--|--|--|--|--|
| Service Name * | web | | | | | | | | | | | | | | | | | | | | |
| IP Protocol | TCP ← HTTP | | | | | | | | | | | | | | | | | | | | |
| Port | Single Port Service Port: 80 | | | | | | | | | | | | | | | | | | | | |
| Inbound IP Address(es) * | <table border="1"> <thead> <tr> <th colspan="2">Connection / IP Address(es)</th> <th>All</th> <th>Clear</th> </tr> </thead> <tbody> <tr> <td><input checked="" type="checkbox"/> WAN1</td> <td><input checked="" type="checkbox"/> 123.123.123.1 (Interface IP)</td> <td></td> <td></td> </tr> <tr> <td><input type="checkbox"/> WAN2</td> <td></td> <td></td> <td></td> </tr> <tr> <td><input type="checkbox"/> WAN3</td> <td></td> <td></td> <td></td> </tr> <tr> <td><input type="checkbox"/> Mobile Internet</td> <td></td> <td></td> <td></td> </tr> </tbody> </table> | Connection / IP Address(es) | | All | Clear | <input checked="" type="checkbox"/> WAN1 | <input checked="" type="checkbox"/> 123.123.123.1 (Interface IP) | | | <input type="checkbox"/> WAN2 | | | | <input type="checkbox"/> WAN3 | | | | <input type="checkbox"/> Mobile Internet | | | |
| Connection / IP Address(es) | | All | Clear | | | | | | | | | | | | | | | | | | |
| <input checked="" type="checkbox"/> WAN1 | <input checked="" type="checkbox"/> 123.123.123.1 (Interface IP) | | | | | | | | | | | | | | | | | | | | |
| <input type="checkbox"/> WAN2 | | | | | | | | | | | | | | | | | | | | | |
| <input type="checkbox"/> WAN3 | | | | | | | | | | | | | | | | | | | | | |
| <input type="checkbox"/> Mobile Internet | | | | | | | | | | | | | | | | | | | | | |
| Included Server(s) * | <table border="1"> <thead> <tr> <th colspan="2">Server</th> <th>Weight</th> </tr> </thead> <tbody> <tr> <td><input checked="" type="checkbox"/> myserver (192.168.1.123)</td> <td></td> <td>1</td> </tr> </tbody> </table> | Server | | Weight | <input checked="" type="checkbox"/> myserver (192.168.1.123) | | 1 | | | | | | | | | | | | | | |
| Server | | Weight | | | | | | | | | | | | | | | | | | | |
| <input checked="" type="checkbox"/> myserver (192.168.1.123) | | 1 | | | | | | | | | | | | | | | | | | | |

* Required Fields

[Save](#) [Cancel](#)

Services Settings

Enable

This setting specifies whether the inbound service rule takes effect.

When **Yes** is selected, the inbound service rule takes effect. If the inbound traffic matches the specified IP Protocol and Port, action will be taken by Peplink Balance based on the other parameters of the rule.

When **No** is selected, the inbound service rule does not take effect. Peplink Balance will disregard the other parameters of the rule.

Service Name

This setting identifies the service to the System Administrator.

Valid values for this setting consist only of alphanumeric and the underscore “_” characters.

IP Protocol

The IP Protocol setting, along with the Port setting, specifies the protocol of the service as TCP, UDP, ICMP or IP.

Traffic that is received by Peplink Balance via the specified protocol at the specified port(s) is forwarded to the LAN hosts specified by the Servers setting.

(Please see below for details on the Port and Servers settings.)

Alternatively, the **Protocol Selection Tool** drop-down menu can be used to automatically fill in the Protocol and a single Port number of common Internet services (e.g. HTTP, HTTPS, etc.).

After selecting an item from the **Protocol Selection Tool** drop-down menu, the Protocol and Port number remains manually modifiable.

The Port setting specifies the port(s) that correspond to the service, and can be configured to behave in one of the following manners:

Any Port, Single Port, Port Range, Port Map and Range Mapping

| | | | |
|------|---|----------|---|
| Port | ? | Any Port | ▼ |
|------|---|----------|---|

Any Port: all traffic that is received by Peplink Balance via the specified protocol is forwarded to the servers specified by the Servers setting.

For example, with IP Protocol set to **TCP**, and Port set to **Any Port**, all TCP traffic is forwarded to the configured servers.

| | | | | | |
|------|---|-------------|---|---------------|----------------------|
| Port | ? | Single Port | ▼ | Service Port: | <input type="text"/> |
|------|---|-------------|---|---------------|----------------------|

Single Port: traffic that is received by Peplink Balance via the specified protocol at the specified port is forwarded via the same port to the servers specified by the Servers setting.

For example, with IP Protocol set to **TCP**, and Port set to **Single Port** and **Service Port** 80, TCP traffic received on Port 80 is forwarded to the configured servers via Port 80.

| | | | | | | | |
|------|---|------------|---|----------------|----------------------|---|----------------------|
| Port | ? | Port Range | ▼ | Service Ports: | <input type="text"/> | - | <input type="text"/> |
|------|---|------------|---|----------------|----------------------|---|----------------------|

Port Range: traffic that is received by Peplink Balance via the specified protocol at the specified port range is forwarded via the same respective ports to the LAN hosts specified by the Servers setting.

For example, with IP Protocol set to **TCP**, and Port set to **Port Range** and **Service Port** 80-88, TCP traffic received on ports 80 through 88 is forwarded to the configured servers via the respective ports.

| | | | | | |
|------|---|--------------|---|---------------|----------------------|
| Port | ? | Port Mapping | ▼ | Service Port: | <input type="text"/> |
| | | | | Map to Port: | <input type="text"/> |

Port Mapping: traffic that is received by Peplink Balance via the specified protocol at the specified port is forwarded via a different port to the servers specified by the Servers setting.

For example, with IP Protocol set to **TCP**, and Port set to **Port Map**, **Service Port** 80, and **Mapping to Port** 88, TCP traffic on Port 80 is forwarded to the configured servers via Port 88.

(Please see below for details on the Servers setting.)

| | | | | | | | |
|------|---|---------------|---|----------------|----------------------|---|----------------------|
| Port | ? | Range Mapping | ▼ | Service Ports: | <input type="text"/> | - | <input type="text"/> |
| | | | | Map to Ports: | <input type="text"/> | - | <input type="text"/> |

Range Mapping: traffic that is received by Peplink Balance via the specified protocol at the specified port range is forwarded via a different port to the servers specified by the Servers setting.

Port

Inbound IP Address(es)

This setting specifies the WAN connections and Internet IP address(es) from which the service can be accessed.

Included Server(s)

This setting specifies the LAN servers that handle requests for the service, and the relative weight values.

The amount of traffic that is distributed to a server is proportional to the weight value assigned to the server relative to the total weight.

Example:

With the following weight settings on a Peplink Balance:

- demo_server_1: 10
- demo_server_2: 5

The total weight is 15 = (10 + 5)

Matching traffic distributed to demo_server_1: 67% = (10 / 15) x 100%

Matching traffic distributed to demo_server_2: 33% = (5 / 15) x 100%

14.4 UPnP / NAT-PMP Settings

UPnP and NAT-PMP are network protocols which allow a computer on the LAN to automatically configure the router to allow parties on the WAN to connect to itself. In this way, the process of inbound port forwarding is automated.

When a computer creates a rule using these protocols, the specified TCP/UDP port of all WAN connections' default IP address will be forwarded.

Check the corresponding box(es) to enable UPnP and/or NAT-PMP. Enable these features only if you trust the computers on the LAN.

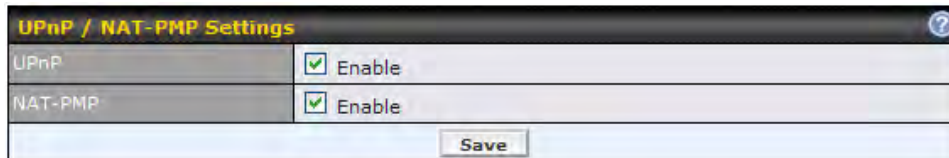

| UPnP / NAT-PMP Settings | |
|-------------------------------------|--|
| UPnP | <input checked="" type="checkbox"/> Enable |
| NAT-PMP | <input checked="" type="checkbox"/> Enable |
| <input type="button" value="Save"/> | |

When the options are enabled, a table listing all the forwarded ports under these two protocols can be found at **Status > UPnP / NAT-PMP**.

14.5 Definition of DNS Records

(Available on Peplink Balance 210+)

The built-in DNS Server functionality of Peplink Balance facilitates inbound load balancing. With the presence of the functionality, NS/SOA DNS records for a domain name can be delegated to Internet IP address(es) of Peplink Balance. Upon receiving a DNS query, Peplink Balance supports returning, as an “A” record, the corresponding IP address for the domain name on the most appropriate healthy WAN connection. It also supports acting as a generic DNS server for hosting “A”, “CNAME”, “MX”, “TXT” and “NS” records.

For example:

(This example is for illustration only; the actual resolution that takes place in implementation will likely be different.)

The DNS resolution of the domain name www.mycompany.com is delegated to the WAN2 Internet IP addresses of Peplink Balance.

Upon receiving the DNS query, Peplink Balance returns, as an “A” record, the IP address for www.mycompany.com on WAN1 because WAN1 is the most appropriate healthy link.

The settings for defining the DNS records to be hosted by Peplink Balance are located at: **Network > Inbound Access > DNS Settings**



The screenshot shows four configuration options for DNS Settings:

- DNS Server**: Disabled
- Zone Transfer**: Disabled
- Default SOA / NS**: (Empty)
- Default Connection Priority**: Priority 1: WAN1, WAN2; Priority 2: WAN3, Mobile Internet

DNS Settings

This setting specifies the WAN IP addresses on which the DNS server of Peplink Balance should listen.

If no addresses are selected, the Inbound Link Load Balancing feature will be disabled; Peplink Balance will not respond to DNS requests.

To specify and/or modify the IP addresses on which the DNS Server should listen, click the **Edit** button that corresponds to **DNS Server Listens on**, and the following screen is displayed:

DNS Servers

| | |
|--|--|
| <input checked="" type="checkbox"/> WAN1 | <input checked="" type="checkbox"/> 210.10.10.1 (Interface IP) |
| <input type="checkbox"/> WAN2 | |
| <input type="checkbox"/> WAN3 | |
| <input type="checkbox"/> Mobile Internet | |

DNS Server

To specify the Internet IP addresses on which the DNS Server should listen, select the WAN connection by checking the appropriate boxes and the IP addresses associated with the WAN connections by highlighting the appropriate items in the list. (Multiple items in the list can be selected by holding CTRL and clicking on the items.)

Click **Save** to save the settings when configuration is complete.

Zone Transfer

This setting specifies the IP address(es) of secondary DNS server(s) that are to be allowed to retrieve zone records from the DNS server of Peplink Balance.
The zone transfer server of Peplink Balance listens on TCP Port 53.

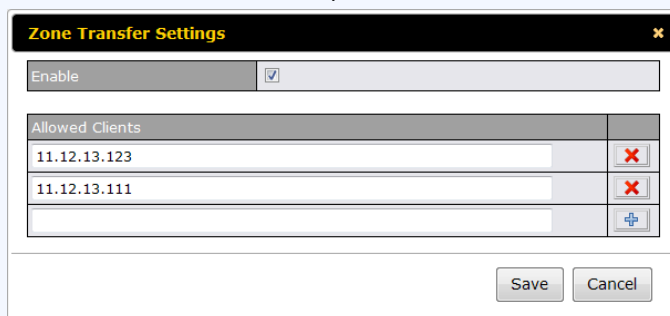

The screenshot shows a dialog box titled "Zone Transfer Settings" with a close button (X). It contains an "Enable" checkbox which is checked. Below it is a table titled "Allowed Clients" with two rows: "11.12.13.123" and "11.12.13.111". Each row has a red "X" button to its right. There is also a plus sign button at the bottom right of the table. At the bottom of the dialog are "Save" and "Cancel" buttons.

Peplink Balance serves both the clients that are accessing from the specified IP addresses, and the clients that are accessing from the LAN Interface (of the Peplink Balance unit).

Default SOA / NS

Click the  button to define a default SOA / NS record for all Domain Names. For Configuration details please refer to section **14.5.2**.

For defining a default SOA record, the field Name Server IP Address is optional. If left blank, the Address (A) record for the same server should be defined manually in each domain.

For defining default NS records, the host [domain] indicates that this record is for the domain name itself without a sub-domain prefix. To add a secondary NS server, just create a second NS record with the Host field empty. When the entered Name Server is a FQDN, the IP Address field will be disabled.

Default Connection Priority

Default Connection Priority defines the default priority group of each WAN connection in resolving A records. It applies to A records which have the Connection Priority set to **Default**. Please refer to Section **14.5.6** for the details.

The WAN connection(s) with the highest priority (smallest number) will be chosen. Those with lower priorities will not be chosen in resolving A records unless the higher priority ones become unavailable.

To specify the Primary and Backup connections, click the  button that corresponds to **Default Connection Priority**. The screen should assemble the one below.

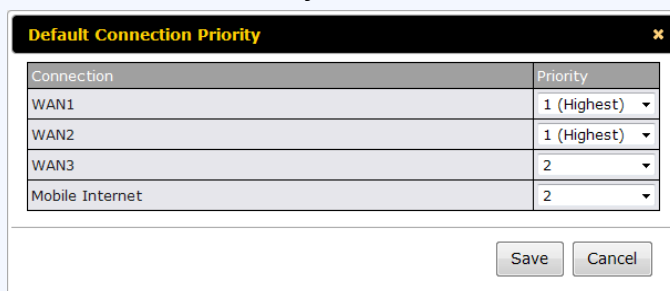

The screenshot shows a dialog box titled "Default Connection Priority" with a close button (X). It contains a table with two columns: "Connection" and "Priority".

| Connection | Priority |
|-----------------|---------------|
| WAN1 | 1 (Highest) ▼ |
| WAN2 | 1 (Highest) ▼ |
| WAN3 | 2 ▼ |
| Mobile Internet | 2 ▼ |

At the bottom of the dialog are "Save" and "Cancel" buttons.

Each WAN connection is associated with a priority number. Click **Save** to save the settings when configuration is complete.

Domain name

This section shows a list of domain names to be hosted by the Peplink Balance. Each domain can have its "NS", "MX" and "TXT" records, and its or its sub-domains' "A" and "CNAME" records. Add a new record by clicking the **New Domain Name** button. Click on a domain name to edit. Press  to remove a domain name.

14.5.1 Creating DNS Records

To create new DNS records for a domain, perform the following steps:

From **Network > Inbound Access > DNS Settings**, create a domain name in the **Domain Name** field. Then click on the newly created domain name and the following screen will be displayed:

peplink.com
✕

SOA Record
?

Use Default SOA and NS Records
🗑️

NS Records
?

| Host | Name Server | TTL (sec) | |
|---|-------------|-----------|--|
| <i>There is currently no NS records.</i> | | | |
| <input type="button" value="New NS Records"/> | | | |

MX Records
?

| Host | Priority | Mail Server | TTL (sec) | |
|--|----------|-------------|-----------|--|
| <i>There is currently no MX records.</i> | | | | |
| <input type="button" value="New MX Record"/> | | | | |

CNAME Records
?

| Host | Points To | TTL (sec) | |
|---|-----------|-----------|--|
| <i>There is currently no CNAME records.</i> | | | |
| <input type="button" value="New CNAME Record"/> | | | |

A Records
?

| Host | Included IP Address(es) | TTL (sec) | |
|---|-------------------------|-----------|--|
| <i>There is currently no A records.</i> | | | |
| <input type="button" value="New A Record"/> | | | |

TXT Records
?

| Host | TXT Value | TTL (sec) | |
|---|-----------|-----------|--|
| <i>There is currently no default TXT records.</i> | | | |
| <input type="button" value="New TXT Record"/> | | | |

SRV Records
?

| Service | Priority | Weight | Target | Port | TTL (sec) | |
|---|----------|--------|--------|------|-----------|--|
| <i>There is currently no SRV records</i> | | | | | | |
| <input type="button" value="New SRV Record"/> | | | | | | |

This page is for defining the domain's SOA, NS, MX, CNAME, A, TXT and SRV records. Seven tables are presented in this page for defining the five types of records.

14.5.2 SOA Records

Click on the  icon to choose whether to use the pre-defined Default SOA Record and NS Records. If the option **Use Default SOA and NS Records** is selected, any changes made in the Default SOA / NS Records will be applied to this domain automatically. Otherwise, select the option **Customize SOA Record** for this domain and you can customize this domain's SOA and NS records.

| | | |
|------------------------|---|-----------|
| Name Server | ? | ns1 |
| Name Server IP Address | ? | |
| Email | ? | webmaster |
| Refresh (sec) | ? | 16384 |
| Retry (sec) | ? | 2048 |
| Expire (sec) | ? | 1048576 |
| Min Time (sec) | ? | 2560 |
| TTL (sec) | ? | 3600 |

This table displays the current SOA record. When the option **Customize SOA Record for this domain** is selected, you can click the link **Click here to define SOA record** to create or click on the **Name Server** field to edit the SOA record.

In the SOA record, you have to fill out the fields *Name Server*, *Name Server IP Address (optional)*, *Email*, *Refresh*, *Retry*, *Expire*, *Min Time*, and *TTL*.

Default values are set for SOA and NS records,

- **Name Server IP Address (optional):** This is the IP address of the authoritative name server. If the Balance is the authoritative name server of the domain, this field's value should be the WAN connection's name server IP address that is registered in the DNS registrar. If this field is entered, a corresponding A record for the name server will be created automatically. If it is left blank, the A record for the name server must be created manually.
- **E-mail:** Defines the E-mail address of the person responsible for this zone. Note: Format should be mailbox-name.domain.com, e.g. hostmaster.example.com
- **Refresh:** Indicates the length of time (in seconds) when the slave will try to refresh the zone from the master.
- **Retry:** Defines the duration (in seconds) between retries if the slave (secondary) fails to contact the master when *refresh* (above) has expired.
- **Expire:** Indicates the time (in seconds) when the zone data is no longer authoritative. This options applies to Slaves DNS servers only.
- **Min Time:** Is the negative caching time which defines the time (in seconds) after an error record is cached
- **TTL (Time-to-Live):** Defines the duration (in seconds) that the record may be cached

14.5.3 NS Records

The NS Record table shows the NS servers and TTL that correspond to the domain.

The NS record of the name server defined in the SOA record is automatically added here.

To add a new NS record, click the **New NS Records** button in the **NS Records** box. Then the table will expand to look like the following:

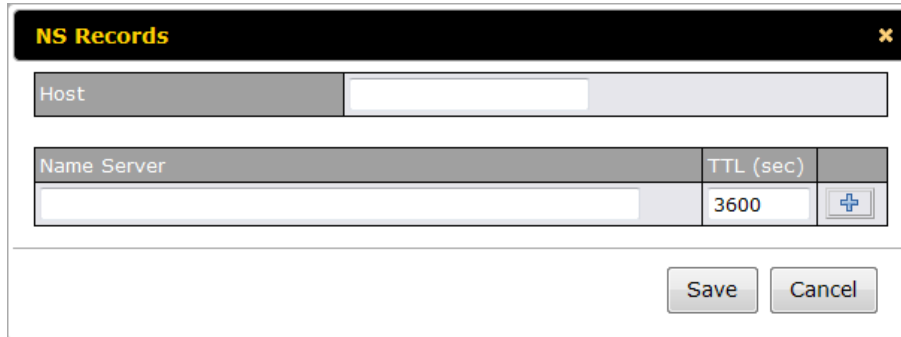

| NS Records | | |
|-------------|-----------|---|
| Host | | |
| Name Server | TTL (sec) | |
| | 3600 | + |
| Save Cancel | | |

When creating an NS record for the domain itself (not a sub-domain), the **Host** field should be left blank.

Enter a name server host name and its IP address into the corresponding boxes. The host name can be a non-FQDN (fully qualified domain name) (please be sure that a corresponding A record is created).

Click the  button on the right to finish and to add the other Name Server. After finishing adding NS records, click the **Save** button. (Before clicking the **Save** button, all NS record changes are not yet saved to the Peplink Balance.)

14.5.4 MX Records

The MX Record table shows the domain's MX records. To add a new MX record, click the **New MX Records** button in the **MX Records** box. Then the table will expand to look like the following:

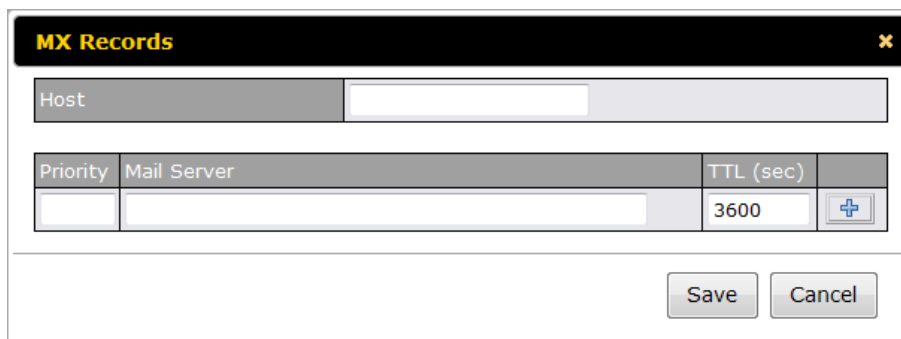

| MX Records | | | |
|-------------|-------------|-----------|---|
| Host | | | |
| Priority | Mail Server | TTL (sec) | |
| | | 3600 | + |
| Save Cancel | | | |

When creating an MX record for the domain itself (not a sub-domain), the **Host** field should be left blank.

For each record, **Priority and Mail Server** name must be entered. **Priority** typically ranges from 10 to 100. Smaller numbers have a higher a priority.

After finishing adding MX records, click the **Save** button.

14.5.5 CNAME Records

The CNAME Record table shows the domain's CNAME records. To add a new CNAME record, click the **New CNAME Records** button in the **CNAME Record** box. Then the table will expand to look like the following:

CNAME Record ✕

| | |
|-----------|----------------------|
| Host | <input type="text"/> |
| Points To | <input type="text"/> |
| TTL (sec) | 3600 |

When creating a CNAME record for the domain itself (not a sub-domain), the Host field should be left blank.

The wildcard character "*" is supported in the **Host** field. The Reference of "*.domain.name" will be returned for every name ending with ".domain.name" except names that have their own records.

The **TTL** field tells the time to live of the record in external DNS caches.

14.5.6 A Records

This table shows the A records of the domain name.

| Host | Included IP Address(es) | TTL (sec) | |
|------|-------------------------------|-----------|---|
| www | WAN1:default 123.123.123.1 | 3600 | ✕ |

To add an A record, click the **New A Record** button. The screen resembles the one below:

A Record ✕

| | |
|-----------|---|
| Host | www |
| TTL (sec) | 3600 |
| Priority | <input type="radio"/> Default <input checked="" type="radio"/> Custom |

Included IP Address(es)

| | | |
|-------------------------------------|-------------------|--|
| <input checked="" type="checkbox"/> | WAN1 | <input checked="" type="checkbox"/> 210.210.210.1 (Interface IP) <input style="width: 80%;" type="text"/> <input style="float: right;" type="button" value="+"/> |
| <input type="checkbox"/> | WAN2 | |
| <input type="checkbox"/> | WAN3 | |
| <input type="checkbox"/> | Mobile Internet | |
| <input checked="" type="checkbox"/> | Custom IP Address | <input checked="" type="checkbox"/> 123.123.123.1 <input style="width: 80%;" type="text"/> <input style="float: right;" type="button" value="+"/> |

| Connection | Priority |
|-----------------|---------------|
| WAN1 | 1 (Highest) ▾ |
| WAN2 | 1 (Highest) ▾ |
| WAN3 | 1 (Highest) ▾ |
| Mobile Internet | 1 (Highest) ▾ |

An A record may be automatically added for the SOA records with a Name Server IP Address provided.

| A Record Editing | |
|---------------------------------|---|
| Host Name | This field specifies the A record of this sub-domain to be served by the Peplink Balance. The wildcard character "*" is supported. The IP addresses of "*.domain.name" will be returned for every name ending with ".domain.name" except names that have their own records. |
| TTL | This setting specifies the time to live of this record in external DNS caches. In order to reflect any dynamic changes on the IP addresses in case of link failure and recovery, this value should be set to a smaller value. E.g. 5 secs, 60 secs, etc. |
| Priority | This option specifies the priority of different connections. Select the Default option to apply the Default Connection Priority (refer to the table shown on the main DNS Settings page) to an A record. To customize priorities, choose the Custom option and a priority selection table will be shown at the bottom. |
| Included IP Address (es) | <p>This setting specifies lists of WAN-specific Internet IP addresses that are candidates to be returned when Peplink Balance responds to DNS queries for the domain name specified by Host Name.</p> <p>The IP addresses listed in each box as default are the Internet IP addresses associated with each of the WAN connections. Static IP addresses that are not associated with any WAN can be entered into the Custom IP list. A PTR record is also created for each Custom IP's.</p> <p>For WAN connections that operate under Drop-in mode, there may be other routable IP addresses in addition to the default IP address. Therefore, Peplink Balance allows custom Internet IP addresses to be added manually via filling the text box on the right-hand side and clicking the  button.</p> <p>Only the checked IP addresses in the lists are candidates to be returned when responding to a DNS query.</p> <p>In case of a WAN connection is down, the corresponding set of IP addresses will not be returned. However, the IP addresses in the Custom IP field will always be returned.</p> <p>If the Connection Priority field is set to Custom, you can also specify the priority of the use of each WAN connection. Only selected IP address(es) of available connection(s) with the highest priority, and also Custom IP addresses will be returned. By default, the Connection Priority is set to Default.</p> |

14.5.7 PTR Records

PTR records are created along with A records pointing to Custom IPs. Please refer to **Section 14.5.6** for details. For example, if you created an A record *www.mydomain.com* pointing to *11.22.33.44*, then a PTR record *44.33.22.11.in-addr.arpa* pointing to *www.mydomain.com* will also be created.

When there are multiple host names pointing to the same IP address, only one PTR record for the IP address will be created.

In order to have the PTR records working, you will also have to create NS records for the PTR records. For example, if the IP address range *11.22.33.0* to *11.22.33.255* is delegated to the DNS server on the Peplink Balance, you will also have to create a domain *33.22.11.in-addr.arpa* and have its NS records pointing to your DNS server's (the Peplink Balance) public IP addresses.

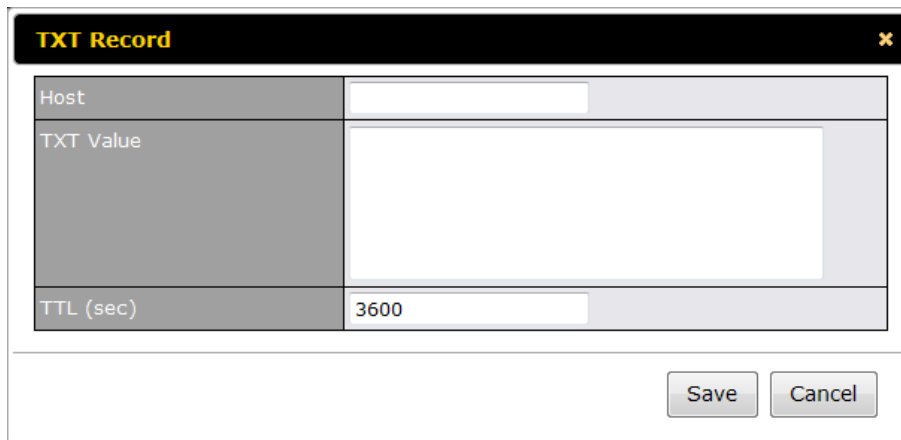

| TXT Record | |
|------------|----------------------|
| Host | <input type="text"/> |
| TXT Value | <input type="text"/> |
| TTL (sec) | 3600 |

Save Cancel

With the above records created, the PTR record creation is complete.

14.5.8 TXT Records

This table shows the TXT record of the domain name.

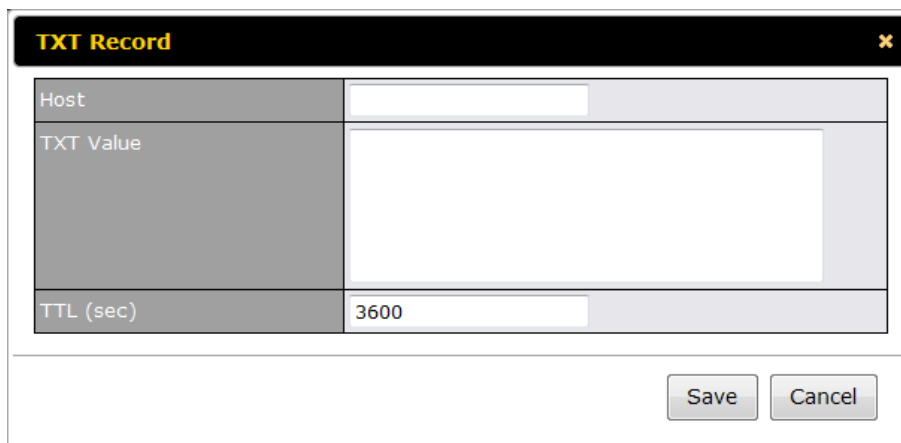

| TXT Record | |
|------------|----------------------|
| Host | <input type="text"/> |
| TXT Value | <input type="text"/> |
| TTL (sec) | 3600 |

Save Cancel

To add a new TXT record, click the **New TXT Record** button in the **TXT Records** box. Click the **Edit** button to edit the record. The time-to-live value and the TXT record's value can be entered. Click the **Save** button to finish.

When creating a TXT record for the domain itself (not a sub-domain), the Host field should be left blank. The maximum size of the TXT Value is 255 bytes.

After completed editing the five types of record, you can simply leave the page by going to another section of the Web Admin Interface.

14.5.9 SRV Records

To add a new SRV record, click the **New SRV Record** button in the **SRV Records** box.

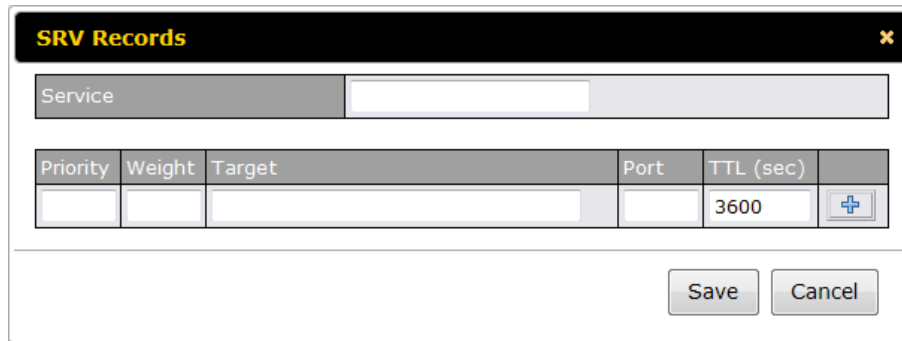

| Priority | Weight | Target | Port | TTL (sec) | |
|----------|--------|--------|------|-----------|---|
| | | | | 3600 | + |

- **Service:** The symbolic name of the desired service.
- **Priority:** Indicates the priority of the Target; the smaller the value, the higher the priority.
- **Weight:** A relative weight for records with the same priority.
- **Target:** The canonical hostname of the machine providing the service.
- **Port:** Enter the TCP or UDP port number on which the service is to be found.

Domain Delegation

These are the steps to be used when you host your domain at your ISP or a domain registrar and want to delegate a sub-domain to be resolved and managed at Peplink Balance.

1. Click **New Domain Name** button to add a domain name. e.g. *www.mycompany.com*. Click the corresponding domain name to view and edit record details.

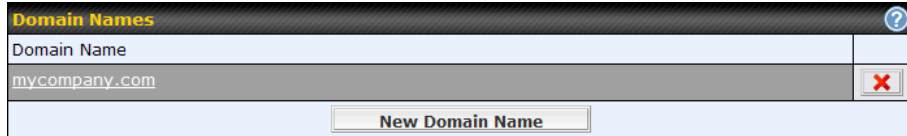

The screenshot shows a window titled "Domain Names" with a search icon. It contains a table with one row: "mycompany.com" with a red 'X' icon in the right column. Below the table is a "New Domain Name" button.

| Domain Name | |
|---------------|---|
| mycompany.com | X |

2. Create SOA / NS records named *ns1*, *ns2*, etc. The IP addresses are the Balance's DNS server addresses.

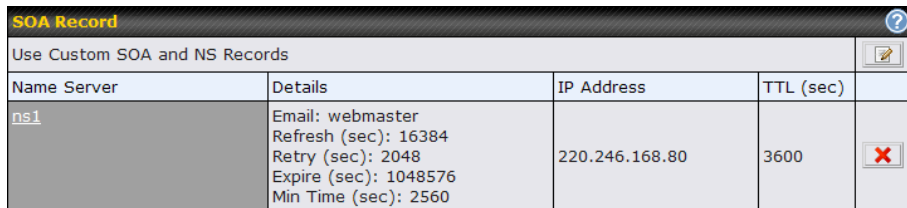

The screenshot shows a window titled "SOA Record" with a search icon. It has a checkbox "Use Custom SOA and NS Records" which is checked. Below is a table with columns: Name Server, Details, IP Address, TTL (sec), and an action column. The row for "ns1" has details: Email: webmaster, Refresh (sec): 16384, Retry (sec): 2048, Expire (sec): 1048576, Min Time (sec): 2560. The IP Address is 220.246.168.80 and the TTL is 3600. There is a red 'X' icon in the action column.

| Name Server | Details | IP Address | TTL (sec) | |
|-------------|--|----------------|-----------|---|
| ns1 | Email: webmaster Refresh (sec): 16384 Retry (sec): 2048 Expire (sec): 1048576 Min Time (sec): 2560 | 220.246.168.80 | 3600 | X |

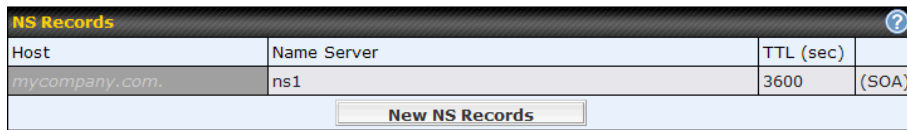

The screenshot shows a window titled "NS Records" with a search icon. It contains a table with columns: Host, Name Server, TTL (sec), and an action column. The row for "mycompany.com" has Name Server "ns1" and TTL "3600" with "(SOA)" in the action column. Below the table is a "New NS Records" button.

| Host | Name Server | TTL (sec) | |
|---------------|-------------|-----------|-------|
| mycompany.com | ns1 | 3600 | (SOA) |

3. Then create an A record with an empty host name:

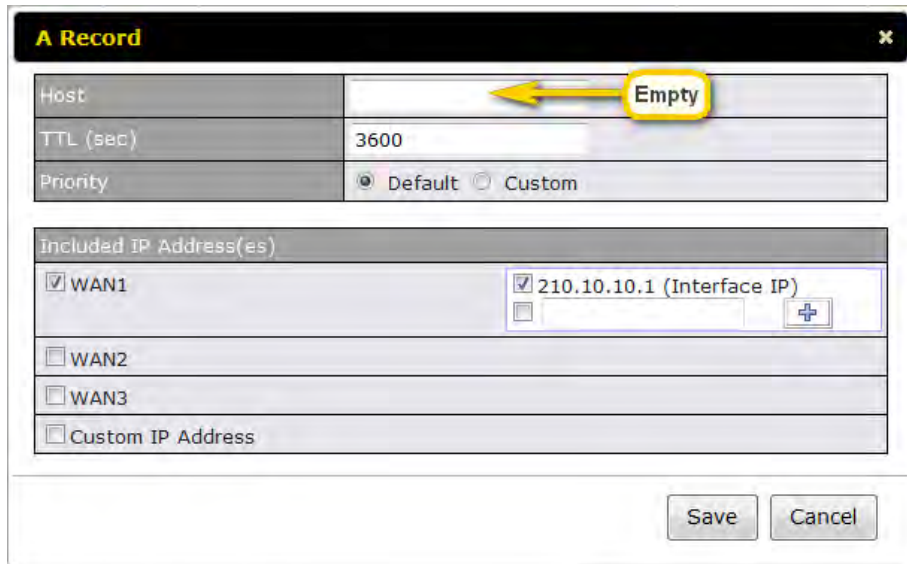

The screenshot shows a window titled "A Record" with a close icon. It has fields for Host, TTL (sec), and Priority. The Host field is empty and circled in yellow with a yellow arrow pointing to it and the word "Empty" next to it. The TTL is 3600. The Priority is set to "Default". Below is a section for "Included IP Address(es)" with checkboxes for WAN1, WAN2, WAN3, and Custom IP Address. WAN1 is checked and has "210.10.10.1 (Interface IP)" selected. There are "Save" and "Cancel" buttons at the bottom.

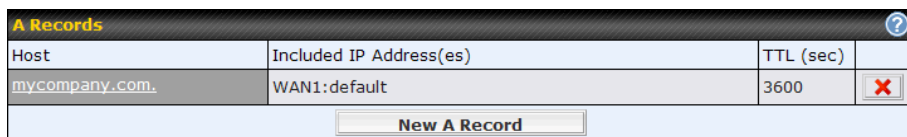

The screenshot shows a window titled "A Records" with a search icon. It contains a table with columns: Host, Included IP Address(es), TTL (sec), and an action column. The row for "mycompany.com" has Included IP Address(es) "WAN1:default" and TTL "3600" with a red 'X' icon in the action column. Below the table is a "New A Record" button.

| Host | Included IP Address(es) | TTL (sec) | |
|---------------|-------------------------|-----------|---|
| mycompany.com | WAN1:default | 3600 | X |

If ISC BIND 8 or 9 is being utilized in the zone file mycompany.com, then the addition of the following lines suffice:

```
www           IN      NS      balancewan1
www           IN      NS      balancewan2
balancewan1   IN      A       202.153.122.108
balancewan2   IN      A       67.38.212.18
```

202.153.122.108 and 67.38.212.18 represent the WAN1 and WAN2 Internet IP addresses of Peplink Balance, respectively. The values of the IP addresses are fictitious and for illustration only; the actual IP addresses in implementation will likely be different.

Hosting the complete domain at Peplink Balance

To host your own DNS server, contact the DNS registrar to have the NS records of the domain (e.g. mycompany.com) point to your Balance's WAN IP addresses. Then follow these instructions:

1. Under **Network > Inbound Access > DNS Settings**, create a new domain, for example mycompany.com.
2. Create NS records named ns1, ns2, etc. The IP addresses are the Balance's DNS server addresses (same as above).
3. Create the corresponding A, CNAME, MX and TXT records as you wish. The A record resembles the one below:

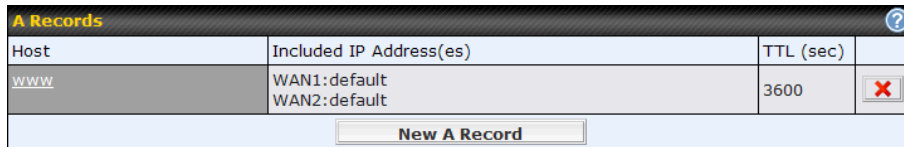

| Host | Included IP Address(es) | TTL (sec) | |
|------|------------------------------|-----------|--|
| www | WAN1:default WAN2:default | 3600 |  |

Testing the DNS Configuration

The following steps can be used to test the DNS configuration:

From a host on the Internet, use an IP address of Peplink Balance and nslookup to lookup the corresponding host name.

Check the information that is returned for the expected results.

An example with nslookup in Windows follows:

```
C:\Documents and Settings\User Name>nslookup
Default Server: ns1.myisp.com
Address: 147.22.11.2
> server 202.153.122.108 (This is Peplink Balance's WAN IP address.)
Default Server: balance.mycompany.com
Address: 202.153.122.108
> www.mycompany.com (This is the host name to be looked up.)
Default Server: balance.mycompany.com
Address: 202.153.122.108
Name: www.mycompany.com
Address: 202.153.122.109, 67.38.212.19
```

The values of the IP addresses are fictitious and for illustration only; the actual IP addresses in implementation will likely be different.

14.6 Reverse Lookup Zones



The dialog box titled "New Reverse Lookup Zone" has a close button (X) in the top right corner. It contains a text input field labeled "Zone Name" with the value ".in-addr.arpa" entered. Below the input field are two buttons: "Save" and "Cancel".

Reverse lookup refers to performing a DNS query to find one or more DNS names associated with a given IP address.

The DNS stores IP addresses in the form of specially formatted names as pointer (PTR) records using special domains/zones. The zone is in-addr.arpa.

To enable DNS clients to perform a reverse lookup for a host, perform two steps:

Create a Reverse Lookup Zone that corresponds to the subnet network address of the host.

In the Reverse Lookup Zone, add a pointer (PTR) resource record that maps the host IP address to the host name.

Click the **New Reverse Lookup Zone** button and enter a Reverse Lookup Zone Name. If you are delegated the subnet 11.22.33.0/24, the Zone Name should be 33.22.11.in-addr.arpa. PTR records for 11.22.33.1, 11.22.33.2, ... 11.22.33.254 should be defined in this zone where the Host IP Numbers are 1, 2, ... 254 respectively.

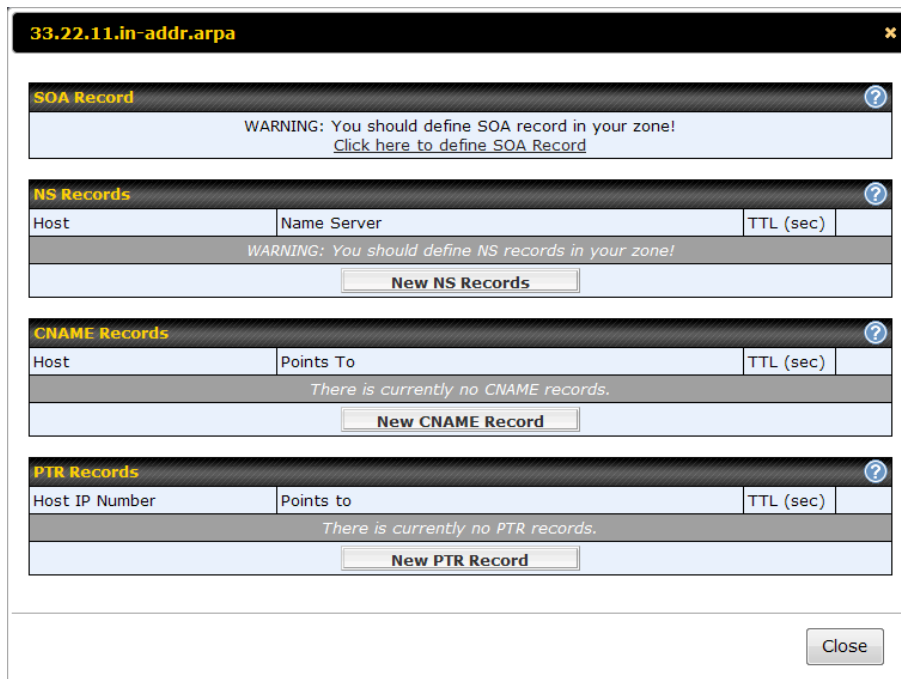

The dialog box titled "33.22.11.in-addr.arpa" has a close button (X) in the top right corner. It contains several sections for configuring DNS records:

- SOA Record:** A warning message: "WARNING: You should define SOA record in your zone! Click here to define SOA Record".
- NS Records:** A table with columns "Host", "Name Server", and "TTL (sec)". A warning message: "WARNING: You should define NS records in your zone!". A "New NS Records" button is below the table.
- CNAME Records:** A table with columns "Host", "Points To", and "TTL (sec)". A message: "There is currently no CNAME records.". A "New CNAME Record" button is below the table.
- PTR Records:** A table with columns "Host IP Number", "Points to", and "TTL (sec)". A message: "There is currently no PTR records.". A "New PTR Record" button is below the table.

A "Close" button is located at the bottom right of the dialog.

14.6.1 SOA Record

You can click the link [Click here to define SOA record](#) to create or click on the Name Server field to edit the SOA record.

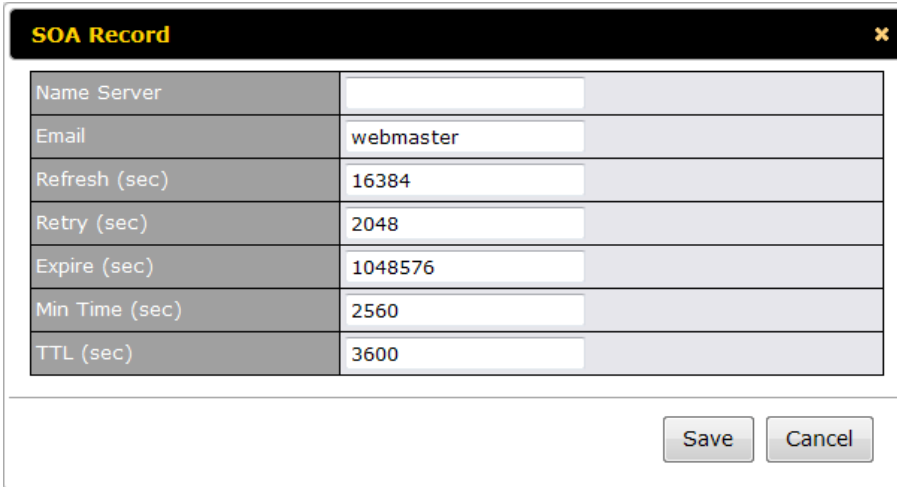

The SOA Record dialog box contains the following fields:

| Field | Value |
|----------------|-----------|
| Name Server | |
| Email | webmaster |
| Refresh (sec) | 16384 |
| Retry (sec) | 2048 |
| Expire (sec) | 1048576 |
| Min Time (sec) | 2560 |
| TTL (sec) | 3600 |

Buttons: Save, Cancel

In the SOA record, you must fill out the field's *Name Server*, *Name Server IP Address (optional)*, *Email*, *Refresh*, *Retry*, *Expire*, *Min Time*, and *TTL*.

Name Server: Enter the NS record's FQDN server name here.

For example:

"ns1.mydomain.com" (equivalent to "www.1stdomain.com.")

"ns2.mydomain.com."

Email, Refresh, Retry, Expire, Min Time, and TTL are the same as that in the forward zone. Please refer to section 14.5.2 for details.

14.6.2 NS Records

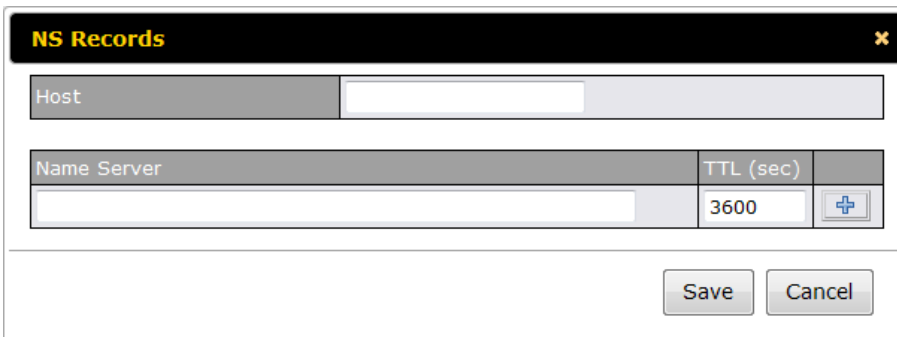

The NS Records dialog box contains the following fields:

| Host | Name Server | TTL (sec) |
|------|-------------|-----------|
| | | 3600 |

Buttons: Save, Cancel

The NS record of the name server defined in the SOA record is automatically added here. To create a new NS record, click the **New NS Records** button.

When creating an NS record for the *Reverse Lookup Zone* itself (not a sub-domain or dedicated zone), the **Host** field should be left blank.

Name Server field must be an FQDN.

14.6.3 CNAME Records

CNAME Record ✕

| | |
|-----------|----------------------|
| Host | <input type="text"/> |
| Points To | <input type="text"/> |
| TTL (sec) | 3600 |

To create a new CNAME record, click the **New CNAME Record** button.

CNAME records are typically used for defining classless reverse lookup zones. Subnetted reverse lookup zones are further described in [RFC 2317](#), "Classless IN-ADDR.ARPA delegation."

14.6.4 PTR Records

PTR Record ✕

| | |
|----------------|----------------------|
| Host IP Number | <input type="text"/> |
| Points To | <input type="text"/> |
| TTL (sec) | 3600 |

To create a new PTR record, click the **New PTR Record** button.

Host IP Number field is the last integer in the IP address of a PTR record. E.g. for the IP address *11.22.33.44*, where the Reverse Lookup Zone is *33.22.11.in-arpa.addr*, the Host IP Number should be *44*.

Points To field defines the host name which the PTR record should be pointed to. It must be an FQDN.

14.7 DNS Record Import Wizard

At the bottom of the page of DNS Settings, there is a link of *Import records via zone transfer...* which is used to import DNS record using Import Wizard.

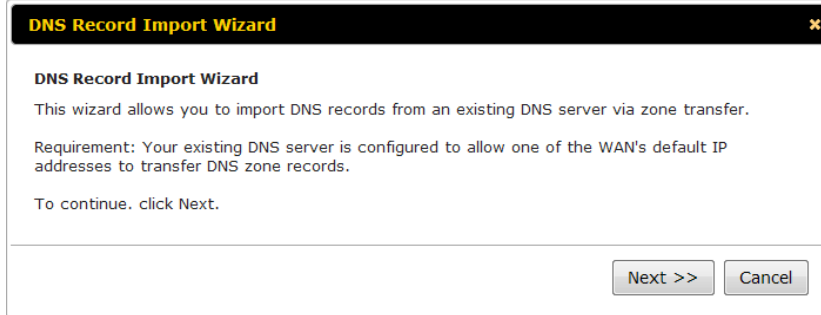

DNS Record Import Wizard

DNS Record Import Wizard

This wizard allows you to import DNS records from an existing DNS server via zone transfer.

Requirement: Your existing DNS server is configured to allow one of the WAN's default IP addresses to transfer DNS zone records.

To continue, click Next.

Next >> Cancel

- Select **Next>>** to continue.

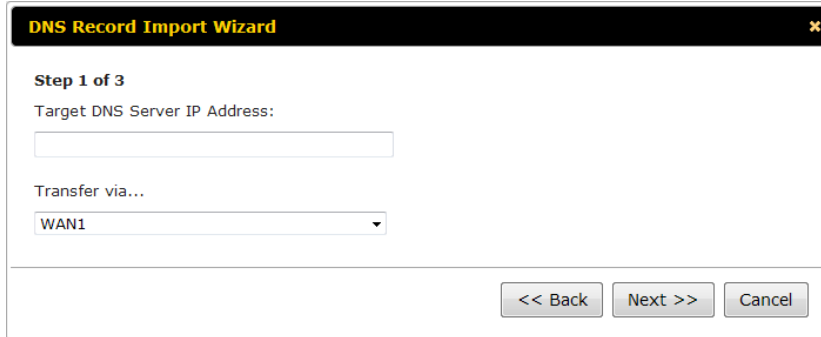

DNS Record Import Wizard

Step 1 of 3

Target DNS Server IP Address:

Transfer via...

WAN1

<< Back Next >> Cancel

- In the **Target DNS Server IP Address** field, enter the IP address of the DNS server.
- In the **Transfer via...** field, choose which connection you would like to transfer through.
- Select **Next>>** to continue.



DNS Record Import Wizard

Step 2 of 3

Domain Names (Zones):

peplink.com
mycompany.com

(One domain name per line)

<< Back Next >> Cancel

- In the blank space, enter the **Domain Names (Zones)** which you would like to assign with the IP address entered in the previous step. Enter one domain name per line.
- Select **Next>>** to continue.

Important Note

If you have entered domain(s) which already exist in your settings, a warning message like the following would be shown. Select **Next>>** to overwrite the existing record, or **<<Back** to go back to the previous step.

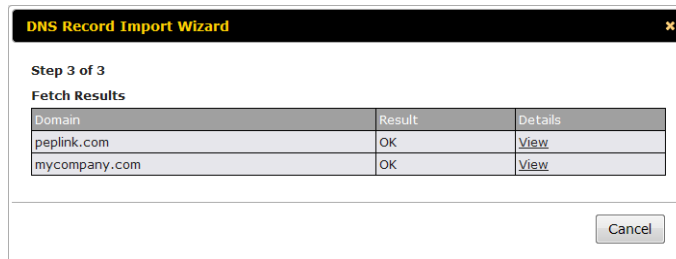
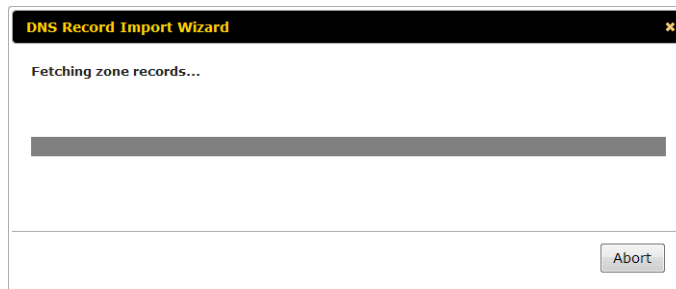
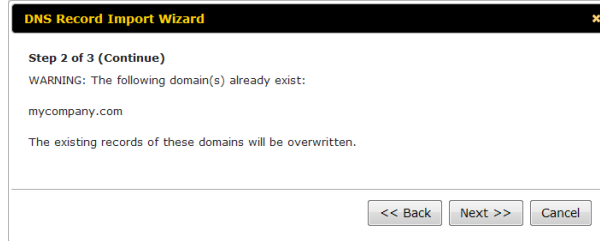

1. After the Fetching zone records process has completed, the fetch results would be shown as above. You can view import details by clicking the corresponding hyperlink on the right hand side.

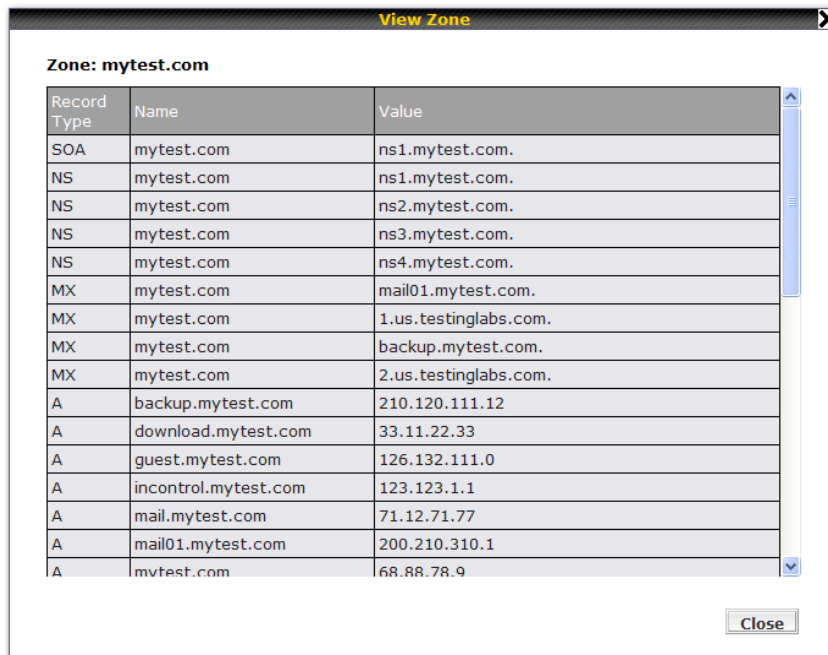

15 NAT Mappings

The configuration of NAT Mappings allows the IP address mapping of all inbound and outbound NAT'ed traffic to and from an internal client IP address.

The settings to configure NAT Mappings are located at: **Network > NAT Mappings**

| LAN Host | Inbound Mappings | Outbound Mappings | Action |
|--------------|----------------------|----------------------|--------|
| 192.168.1.23 | (WAN1):29.123.123.13 | (WAN1):29.123.123.13 | Delete |
| 192.168.1.24 | (WAN2):30.21.21.12 | (WAN2):30.21.21.12 | Delete |
| Add NAT Rule | | | |

To add a rule for NAT Mappings, click **Add NAT Rule**, upon which the following screen will be displayed:

| | |
|-------------------|---|
| LAN Client(s) | <input type="radio"/> IP Address |
| Address | 192.168.1.123 |
| Inbound Mappings | <p>Connection / Inbound IP Address(es)</p> <p><input checked="" type="checkbox"/> WAN1 <input checked="" type="checkbox"/> 210.10.10.1 <input type="checkbox"/> 210.10.10.2 <input type="checkbox"/> 210.10.10.3</p> <p><input type="checkbox"/> WAN2 <input type="checkbox"/> WAN3 <input type="checkbox"/> Mobile Internet</p> |
| Outbound Mappings | <p>Connection / Outbound IP Address</p> <p>WAN1: 210.10.10.1 (Interface IP) <input type="text"/></p> <p>WAN2: Interface IP <input type="text"/></p> <p>WAN3: Interface IP <input type="text"/></p> <p>Mobile Internet: Interface IP <input type="text"/></p> |

| NAT Mapping Settings | |
|-------------------------|---|
| LAN Client(s) | NAT Mapping rules can be defined for a single LAN IP Address , an IP Range , or an IP Network . |
| Address | This refers to the LAN host's private IP address. The system maps this address to a number of public IP addresses, specified below, in order to facilitate inbound and outbound traffic. This option is only available when IP Address is selected. |
| Inbound Mappings | This setting specifies the WAN connections and corresponding WAN-specific Internet IP addresses on which the system should bind on. Any access to the specified WAN connection(s) and IP address(es) will be forwarded to the LAN Host. This option is only available when IP Address is selected in LAN Client(s) field. Note 1: Inbound Mapping is not needed for WAN connections in drop-in or IP forwarding mode. Note 2: Each WAN IP address can be associated to one NAT Mapping only. |
| Range | The IP range is a contiguous group of private IP addresses used by the LAN host. The system maps these addresses to a number of public IP addresses, specified below, to facilitate outbound traffic. This option is only available when IP Range is selected. |

| | |
|--------------------------|--|
| Network | The IP network refers to all private IP addresses and ranges managed by the LAN host. The system maps these addresses to a number of public IP addresses, specified below, to facilitate outbound traffic. This option is only available when IP Network is selected. |
| Outbound Mappings | This setting specifies the WAN IP addresses should be used when an IP connection is made from a LAN host to the Internet. Each LAN host in an IP range or IP network will be evenly mapped to one of each selected WAN's IP addresses (for better IP address utilization) in a persistent manner (for better application compatibility). Note 1: If you do not want to use a specific WAN for outgoing accesses, you should still choose default here, then customize the outbound access rule in the Outbound Policy section. Note 2: WAN connections in drop-in or IP forwarding mode are not shown here. |

Click **Save** to save the settings when configuration has been completed.

Important Note

Inbound firewall rules override Inbound Mapping settings.

16 WLAN Controller

(Available on Peplink Balance 380+)

WLAN Controller is a feature available since firmware 5.3, which acts as a centralized controller of Pepwave AP One devices. With this feature, users will be able to customize and manage multiple Pepwave AP devices in the same Peplink Balance Interface.

To configure, navigate to **Network > WLAN Controller** and the following options will be shown.

Special Note

For demo and testing purposes, two Pepwave AP One devices can be controlled by a Peplink Balance without extra costs. To manage more than two units, a Full Edition license is required. Please contact our Authorized Reseller or Peplink Sales Team to obtain more information and price details.

16.1 WLAN Information

On the **Dashboard** of Web Admin Interface, the real-time WLAN information would be shown as below.

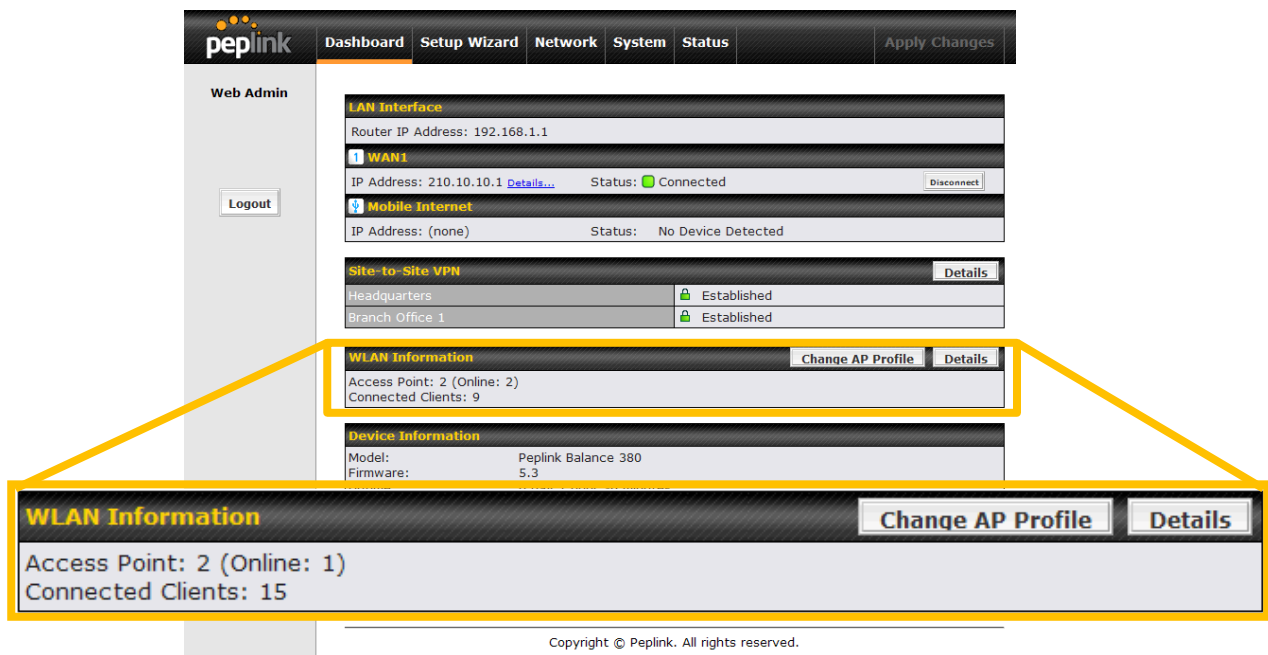

Copyright © Peplink. All rights reserved.

Three information will be shown: **number of managed Pepwave AP devices**, **number of online devices** and **number of current connected clients**.

Click **Change AP Profile** to configure the connected Pepwave AP devices and apply AP profiles. For details, please refer to section 16.1.1

Click **Details** to view Access Point details. For details, please refer to section 21.4.

16.1.1 Access Point Information

Access Point can be assigned with different AP Profiles created in section 16.5. Click **Change AP Profile** on the **Dashboard** and the following will be shown.

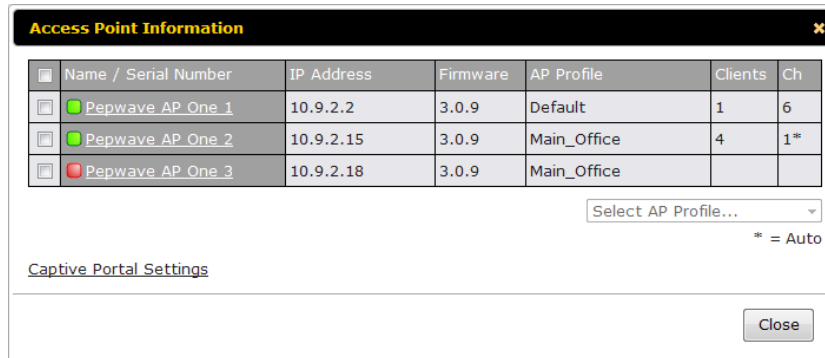

| <input type="checkbox"/> | Name / Serial Number | IP Address | Firmware | AP Profile | Clients | Ch |
|-------------------------------------|----------------------|------------|----------|-------------|---------|----|
| <input checked="" type="checkbox"/> | Pepwave AP One 1 | 10.9.2.2 | 3.0.9 | Default | 1 | 6 |
| <input checked="" type="checkbox"/> | Pepwave AP One 2 | 10.9.2.15 | 3.0.9 | Main_Office | 4 | 1* |
| <input type="checkbox"/> | Pepwave AP One 3 | 10.9.2.18 | 3.0.9 | Main_Office | | |

Select AP Profile...
* = Auto

[Captive Portal Settings](#)

Close

If there is a "*" next to the channel information, that means the AP One is configured to select a broadcasting channel automatically.

To apply a AP Profile, check the box(es) to choose the desired Pepwave AP device(s), and then choose a desired AP Profile in the dropdown list under the devices list. Press **Yes** to confirm the change.

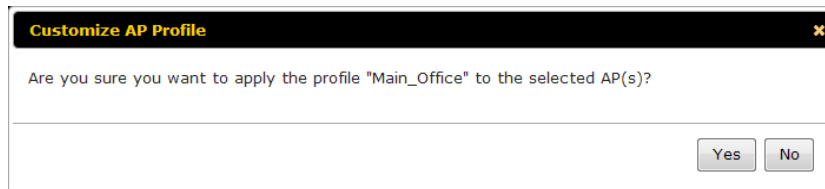

Are you sure you want to apply the profile "Main_Office" to the selected AP(s)?

Yes No

Once the change is confirmed, the new AP Profile will be applied to the selected device(s). Changes will be activated immediately.

To view the device detail, click the corresponding device's name and you will see the following screen.

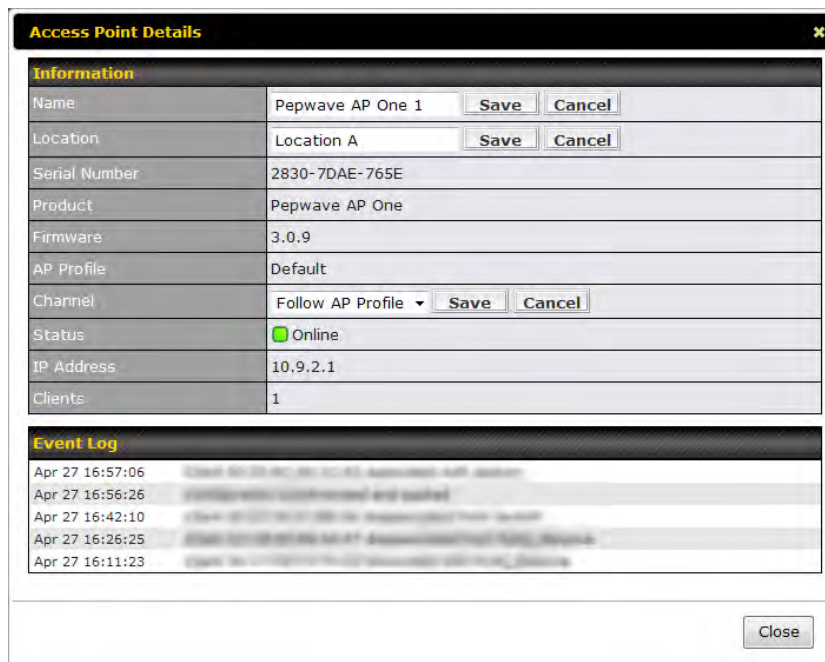



| Information | |
|---------------|---|
| Name | Pepwave AP One 1 <input type="button" value="Save"/> <input type="button" value="Cancel"/> |
| Location | Location A <input type="button" value="Save"/> <input type="button" value="Cancel"/> |
| Serial Number | 2830-7DAE-765E |
| Product | Pepwave AP One |
| Firmware | 3.0.9 |
| AP Profile | Default |
| Channel | Follow AP Profile <input type="button" value="Save"/> <input type="button" value="Cancel"/> |
| Status | <input checked="" type="checkbox"/> Online |
| IP Address | 10.9.2.1 |
| Clients | 1 |

| Event Log | |
|-----------------|---|
| Apr 27 16:57:06 | Client 10.9.2.15 (10.9.2.15) disconnected with reason: [REDACTED] |
| Apr 27 16:56:26 | Configuration synchronized and applied |
| Apr 27 16:42:10 | Client 10.9.2.15 (10.9.2.15) disconnected from access |
| Apr 27 16:26:25 | Client 10.9.2.15 (10.9.2.15) disconnected from access |
| Apr 27 16:11:23 | Client 10.9.2.15 (10.9.2.15) disconnected with reason: [REDACTED] |

Close

Device's **Name**, **Location** and **Channel** can be changed in here.

Access Point Information ✕

| <input type="checkbox"/> | Name / Serial Number | IP Address | Firmware | AP Profile | Clients | Ch |
|--------------------------|--|------------|----------|-------------|---------|----|
| <input type="checkbox"/> |  Pepwave AP One 1 | 10.9.2.2 | 3.0.9 | Default | 1 | 6 |
| <input type="checkbox"/> |  Pepwave AP One 2 | 10.9.2.15 | 3.0.9 | Main_Office | 4 | 1* |
| <input type="checkbox"/> |  Pepwave AP One 3 | 10.9.2.18 | 3.0.9 | Main_Office | | |

Select AP Profile... ▾

* = Auto

[Captive Portal Settings](#)

Close

A customized Captive Portal page can be configured for each Peplink Balance device. To start, click the link **Captive Portal Settings** and you will be forwarded to the configuration page. For details, please refer to section 16.4.

16.2 AP Management

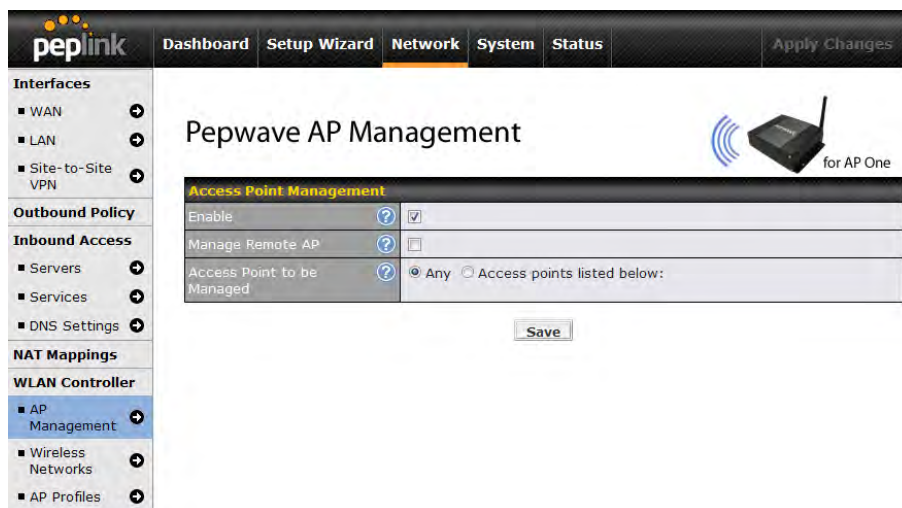

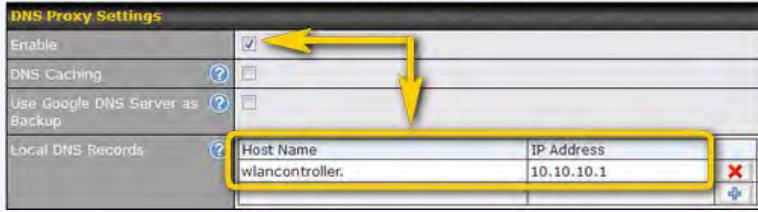
| Access Point Management | |
|-----------------------------------|--|
| Enable | <p>The WLAN Controller for managing Pepwave APs can be enabled by this option. When this option is enabled, the WLAN Controller will wait for management connections originating from APs over the LAN on TCP and UDP port 11753. It will also wait for captive portal connections on TCP port 443. An extended DHCP option "CAPWAP Access Controller addresses" (field 138) will be added to the DHCP server. A local DNS record "wlancontroller" will added to the local DNS proxy.</p> |
| Manage Remote AP | <p>The WLAN controller supports remote management of Pepwave APs. When this option is enabled, the WLAN controller will wait for management connections originating from remote APs over the WAN on TCP and UDP port 11753. It will also wait for captive portal connections on TCP port 443.</p> <p>The DHCP server and/or local DNS server of the remote AP's network should be configured as follows:</p> <ol style="list-style-type: none"> 1. Define an extended DHCP option "CAPWAP Access Controller addresses" (field 138) in the DHCP server, where the values are the WLAN controller's public IP addresses; and/or 2. Create a local DNS record for "wlancontroller." with a value corresponding to the WLAN controller's public IP address.  |
| Access Point to be Managed | <p>Access Point devices managed will be defined in this option. If Any is selected, the WLAN controller will manage any AP that reports to it. If Access points listed below is selected, only APs with a serial number listed in the text box will be managed.</p> |

16.3 Wireless Networks

Wireless Network settings, including the name of network (SSID) and security policy, can be defined and managed in this section. After defining a wireless network, users can choose the network in AP Profiles.

| Network Name (SSID) | Security Policy | Used by | |
|-----------------------------|----------------------|--------------------|--|
| Wireless Network | Open (No Encryption) | Default ProfileB | |
| New Network | | | |

Click the button **New Network** to create a new Network profile, or click the existing network profile to modify its settings.

Wireless Network ✕

Wireless Network Settings

| | |
|-----------------------|--|
| Network Name (SSID) | <input type="text"/> |
| VLAN ID | 0 (0: Untagged) |
| Broadcast SSID | <input checked="" type="checkbox"/> |
| Multicast Filter | <input type="checkbox"/> |
| Multicast Rate | (for b/g mode) 1M (for n mode) MCS0 |
| Layer 2 Communication | <input checked="" type="checkbox"/> |

Wireless Security Settings

| | |
|-----------------|----------------------|
| Security Policy | Open (No Encryption) |
|-----------------|----------------------|

Access Control

| | |
|------------------|--------------------------|
| Restricted Mode | Accept all except listed |
| MAC Address List | <input type="text"/> |

Captive Portal ?

| | |
|--------|-------------------------------------|
| Enable | <input checked="" type="checkbox"/> |
|--------|-------------------------------------|

Remember to [configure your Captive Portal](#)

| Wireless Network Settings | |
|----------------------------|---|
| Network Name (SSID) | This setting specifies the SSID of the virtual AP to be scanned by Wi-Fi clients. |
| VLAN ID | This setting specifies the VLAN ID to be tagged on all outgoing packets generated from this wireless network (i.e. packets that travel from the Wi-Fi segment, through the Pepwave AP One unit to Ethernet segment via the LAN port). The default value of this setting is 0 . That means VLAN tagging is disabled (instead of tagged with zero). |
| Broadcast SSID | This setting specifies whether or not the SSID of this wireless network can be scanned by Wi-Fi clients. Broadcast SSID is enabled by default. |
| Multicast Filter | This setting enables the filtering of multicast network traffic to the wireless SSID. |

| | |
|------------------------------|---|
| Multicast Rate | This setting specifies the transmit rate to used for sending multicast network traffic. The rate options and values will be affected by selected Protocol and Channel Bonding . |
| Layer 2 Communication | Layer 2 is in reference to the second layer in the ISO Open System Interconnect model. When this option is enabled, clients on the same VLAN, SSID or subnet are allowed to communicate directly via the Layer 2 Protocol(s). Traffic is passed to upper communication layer(s). By default, the setting is enabled . |

Wireless Security Settings

| | |
|------------------------|--|
| Security Policy | This setting configures the wireless authentication and encryption methods. Available options are: Open - No Encryption , Static WEP , 802.1X , WPA/WPA2 - Personal and WPA/WPA2 - Enterprise . Selecting Open - No Encryption disables encryption. For details on the other options, please refer to the following sections. <ol style="list-style-type: none">16.2.1 - Static WEP16.2.2 - 802.1X Parameters16.2.3 - WPA parameters16.2.4 - Radius Server Settings |
|------------------------|--|

Access Control

| | |
|-------------------------|--|
| Restricted Mode | The settings allow administrator to control the access through Mac address filtering. Available options are: None , Deny all except listed , Accept all except listed . |
| MAC Address List | Connection coming from the MAC Addresses in this list will be either deny or accept based the option selected in the previous field. |

Captive Portal

| | |
|---------------|--|
| Enable | When this option is enabled, web redirection will be applied to all unauthenticated Wi-Fi clients associated with this wireless network. Requests by unauthenticated Wi-Fi clients will be redirected to this Peplink Balance's built-in captive portal site. To configure the captive portal site, click the link "configure your Captive Portal" below. For details, please refer to section 16.3. NOTE: All changes made in the Captive Portal Management page are effective immediately |
|---------------|--|

16.3.1 Static WEP

The configuration of Static WEP parameters enables pre-shared WEP key encryption. Authentication is not supported by this method.

The security level of this method is known to be weak.

Static WEP parameters are entered via the following screen upon selection:

| Wireless Security Settings | |
|----------------------------|--------------------------|
| Security Policy | Static WEP |
| Key Size | 40 bits (64-bit WEP) |
| Key Format | ASCII |
| Encryption Key | <input type="text"/> |
| Shared Key Authentication | <input type="checkbox"/> |

| Static WEP Parameters | |
|----------------------------------|--|
| Key Size | The setting can be configured as either 40 bits (64-bit WEP) or 104 bits (128-bit WEP) . |
| Key Format | <p>The setting can be configured as either ASCII or HEX.</p> <ul style="list-style-type: none"> • ASCII will be applied to encryption keys that are manually entered only. • HEX will be applied to encryption keys that are either manually entered or automatically generated. |
| Encryption Key | <p>This setting specifies a user-specified encryption key value.</p> <p>For ASCII format, key length is either 5 or 13.</p> <p>For HEX format, key length is either 10 or 26.</p> |
| Shared Key Authentication | This setting enables the use of shared key authentication. Open authentication is the default authentication. |

16.3.2 802.1X Parameters

The configuration of 802.1X parameters enables Radius-based 802.1X authentication with a dynamic WEP key. Once selected, Radius Server Setting will be available.

The configuration screen is as follows:

| Wireless Security Settings | |
|----------------------------|---|
| Security Policy | 802.1X |
| WEP Key Size | 40 bits (64-bit WEP) |
| Re-keying Period | <input type="text" value="0"/> seconds (0: Disable) |

| 802.1x Parameters | |
|-------------------------|---|
| WEP Key Size | The setting can be configured as either 40 bits or 104 bits . |
| Re-keying Period | <p>This setting specifies the length of time throughout which the broadcast key remains valid. Upon expiration of Re-keying Period, the broadcast key will no longer be valid and the renewal of the broadcast key will be required.</p> <p>The default is 14400 seconds (i.e. 4 hours).</p> <p>A value of 0 disables re-keying.</p> |

16.3.3 WPA parameters

The configuration of WPA parameters enables **WPA/WPA2 – Personal** and **WPA/WPA2 - Enterprise**.

| Wireless Security Settings | |
|----------------------------|-------------------------|
| Security Policy | WPA/WPA2 - Enterprise ▾ |
| Encryption | TKIP/AES:CCMP |

When **WPA/WPA2 - Enterprise** is configured, Radius-based 802.1x authentication is enabled. Under this configuration, the **Shared Key** option should be disabled.

The security level of this method is known to be very high.

| Wireless Security Settings | |
|----------------------------|---|
| Security Policy | WPA/WPA2 - Personal ▾ |
| Encryption | TKIP/AES:CCMP |
| Shared Key | <input type="text"/> <input checked="" type="checkbox"/> Hide Characters |

When **WPA/WPA2 - Personal** is configured, a **Shared Key** is used for data encryption and authentication. Under this configuration, the **Shared Key** option should be enabled. Key length must be between 8 and 63 characters (inclusive).

The security level of this method is known to be high.

16.3.4 Radius Server Settings

When **802.1X** or **WPA/WPA2 – Enterprise** is selected as the wireless security protocol, Radius Server settings will be available as shown below.

| RADIUS Server Settings | Primary Server | Secondary Server |
|------------------------|---|---|
| Host | <input type="text"/> | <input type="text"/> |
| Secret | <input type="text"/> | <input type="text"/> |
| Authentication Port | 1812 <input type="button" value="Default"/> | 1812 <input type="button" value="Default"/> |
| Accounting Port | 1813 <input type="button" value="Default"/> | 1813 <input type="button" value="Default"/> |

| Radius Server Settings | |
|----------------------------|---|
| Host | Radius server specified by this setting will be used for authentication and accounting. |
| Secret | This is the secret for accessing the Radius server. |
| Authentication Port | This specifies the UDP port number for the Authentication port of the Radius server. By default, it is set as 1812 . |
| Accounting Port | This specifies the UDP port number for the Accounting port of the Radius server. By default, it is set as 1813 . |

16.4 Captive Portal Management

A customized Captive Portal page can be configured and applied to wireless networks. To configure, check the box at the bottom to enable the feature. Once enabled, a link for configuring Captive Portal will be available as shown below.

| Captive Portal | |
|---|-------------------------------------|
| Enable | <input checked="" type="checkbox"/> |
| Remember to configure your Captive Portal | |

Click the link **configure your Captive Portal** to start configuration. Once the configuration is complete, click the button **Save** to save settings.

Important Note

Only one portal page customization is available for each Peplink Balance device, multiple wireless networks with captive portal enabled will be redirected to the same portal page.

16.4.1 General

| Captive Portal Settings | |
|-------------------------|---|
| Captive portal mode | <input type="radio"/> Guest Account mode <input checked="" type="radio"/> Open Access mode |
| Free access quota | 20 mins (0: Unlimited) |
| Daily rollover time | 02 :00 |

Captive Portal Settings

| | |
|----------------------------|---|
| Captive Portal Mode | This is to specify the wireless network can be accessed by the general public or an access account is required. If Guest Account mode is selected, an access account is required. If Open Access mode is selected, users can associated with this network to gain access to the Internet without account information, a splash screen will be shown. |
| Free Access Quota | This option is only available if Open Access mode is selected, which specify the length of the free access to the general public users without access accounts. The number "0" mean the access is unlimited. The unit used is mins . |
| Daily Rollover Time | This option is only available if Open Access mode is selected, which specify the daily rollover time of the free access period. All access quota will be reset at this time specified. |

16.4.2 Guest Accounts

To manage and set up guest accounts for Guest Account mode, click the **Guest Accounts** tab and the following will be shown.

General **Guest Accounts** Portal Page Customization Email Settings

Search for Guest Accounts

Name / Username / Email

Unused Guest Accounts

| <input type="checkbox"/> | Username | Expiry Date | Time Quota | Creation Date |
|--------------------------|----------|-------------|------------|---------------|
| <input type="checkbox"/> | test1 | - | 5 mins | 2011/03/22 |

Page 1 / 1 (Total: 9)

CSV download: [All | Generated today | Not generated today]

Active Guest Accounts

| <input type="checkbox"/> | Username | Expiry Date | Time Quota | Creation Date |
|--------------------------|----------|-------------|------------|---------------|
| No Active Guest Accounts | | | | |

CSV download: [All]

Create Account **Generate Accounts**

Name *

Email Address (Username) *

Password *

Change Password at First Login

Expiry Date 2011-03-24 : :

Send Login Information to Email

Please update settings in Email Settings tab.

All unused Guest Accounts and Active Guest Accounts are shown. Check the corresponding checkbox and press delete to remove account from the system.

| Unused / Active Guest Accounts | |
|--------------------------------|---|
| Username | This shows the user name of the unused guest account. |
| Expiry Date | This shows the expiry date of the corresponding guest account. |
| Time Quota | This shows the time quota of the connection of the corresponding guest account. |
| Creation Date | This shows the date of creation of the corresponding guest account. |

There are two different methods to create new guest account: **Create Account** and **Generate Accounts**

16.4.2.1 Create Account

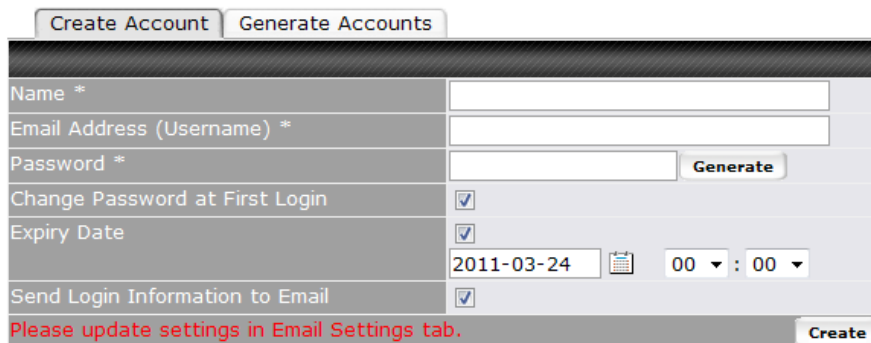

With this method, only one account will be created each time.

| Create Account | |
|--|---|
| Name | This is to specify a name for the created account for management use. |
| Email Address (Username) | This is to specify the username of the guest account. |
| Password | This is to specify the password of the guest account. |
| Change Password at First Login | With the box checked, user who uses this account to access will need to change the password at first login. |
| Expiry Date | With the box checked, an expiry date can be specified. This guest account will expire when time reach. |
| Send Login Information to Email | This is to enable the feature of sending an email regarding the login information. Email must be set to use with this feature. For details please refer to section 16.3.4 |

16.4.2.2 Generate Accounts

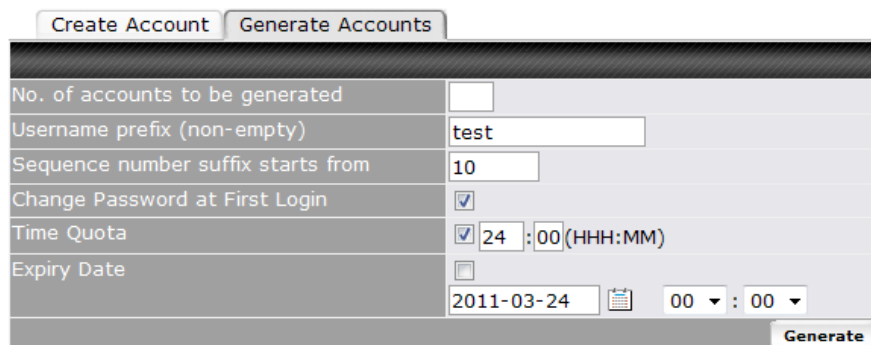

With this method, multiple accounts will be created in batch with the same settings.

| Generate Accounts | |
|---|--|
| No. of accounts to be generated | This is to specify the number of accounts will be generated with the same settings. |
| Username prefix (non-empty) | This is to specify the prefix of the username of the guest accounts. This field should not leave blank. |
| Sequence number suffix starts from | This is to specify the sequence number suffix which the username will start from. The specified value should be a number. |
| Change Password at First Login | With the box checked, user who uses this account to access will need to change the password at first login. |
| Time Quota | If this option is enabled, time quota of access will be set. If this option is disabled, users will have unlimited Internet access with this wireless network. |
| Expiry Date | With the box checked, an expiry date can be specified. This guest account will expire when time reach. |

16.4.3 Portal Page Customization

A customized portal page will be shown each time a user access the wireless network that has captive portal enabled. The portal page can be customized under the Portal Page customization tab.

General Guest Accounts **Portal Page Customization** Email Settings

Update Portal Page Information

| | |
|---------------------|---|
| Logo Image | Uploaded: 2011/04/27 18:00:50 <input type="button" value="Clear"/> Note: Max size: 2 MB. Supported image types: JPEG, PNG and GIF. |
| Message | Your message [Text Area] |
| Terms & Conditions | 1.) Terms 1 2.) Terms 2 3.) Terms 3 Other conditions [Text Area] |
| Custom Landing Page | <input checked="" type="checkbox"/> <input type="text" value="http://www.your-landing-page.com"/> |

| Update Portal Page Information | |
|--------------------------------|--|
| Logo Image | Click and choose a logo image and Upload for the portal page. The image file should be in the format of JPEG, PNG or GIF , with maximum size of 2MB . |
| Message | Custom message can be specified here. |
| Terms & Conditions | Custom Terms & Conditions messages can be specified here. |
| Custom Landing Page | To specify the custom landing page opened once the clients login as a user. |

Click **Preview** to preview the custom portal page, and click **Publish** to save settings.

An example of custom portal page is shown as below.



16.4.4 Email Settings

General Guest Accounts Portal Page Customization **Email Settings**

Email Server / Template Settings

| | |
|------------------------|--|
| Sender's Name | <input type="text"/> |
| Sender's Email Address | <input type="text"/> |
| SMTP Server | <input type="text"/> Port: <input type="text" value="25"/> |
| | <input checked="" type="checkbox"/> Require authentication |
| SMTP User Name | <input type="text"/> |
| SMTP Password | <input type="password"/> |
| Confirm SMTP Password | <input type="password"/> |
| SSL Encryption | <input type="checkbox"/> |

Account Information Email Template Default

Subject: Account information of \${SENDER}'s Wi-Fi server

Dear \${NAME}

Thank you for using \${SENDER}'s Wi-Fi service. Here is your account information:

User name: \${USERNAME}
Password: \${PASSWORD}
Expiry date: \${EXP_DATE}

\${SENDER}

PS: This is a post-only mailing. Replies to this message are not monitored or answered.

Password Reset Email Template Default

Subject: Password reset information about \${SENDER}'s Wi-Fi

Dear \${NAME}

Thank you for using \${SENDER}'s Wi-Fi service. Enter the following reset key in the Password Reset Page to reset the password of the account '\${USERNAME}'.

Reset key: \${RESET_KEY}

\${SENDER}

PS: This is a post-only mailing. Replies to this message are not monitored or answered.

Once you have selected for Guest Account mode as the Captive portal modem in section 16.4.1, the **Email Settings** tab will be available. Under this page, email server and templates can be set. Automatic emails will be sent with the specified information.

| Email Server / Template Settings | |
|----------------------------------|---|
| Sender's Name | This is to specify the sender's name of the email. |
| Sender's Email Address | This is to specify the sender's email address of the email. |
| SMTP Server | This is to specify the SMTP server which will be used to send email. If the Server requires authentication, check the box Require authentication . |
| SMTP User Name / Password | This setting specifies the SMTP username and password while sending email. These options are shown only if Require authentication check box is checked in SMTP Server setting. |

| | |
|------------------------------|--|
| Confirm SMTP Password | This field allows you to verify and confirm the new administrator password. |
| SSL Encryption | Check the box to enable SMTPS. When the box is checked, the next field SMTP Port will be changed to 465 automatically. |

Two different emails templates can be set and customize.

- **Account Information Email** will be sent when the user login at the first time with a guest account.
- **Password Reset Email** will be sent when the user is requesting a password reset on the portal page.

Different dynamic information is available for the email template.

| Dynamic Information for Captive Portal Email Template | |
|---|---|
| \${NAME} | This is to specify the name of account user. |
| \${SENDER} | This is to specify the sender's name. |
| \${RESET_KEY} | This is to specify the reset password of the specified account. |
| \${USERNAME} | This is to specify the account user name. |
| \${PASSWORD} | This is to specify the password of the account. |
| \${EXP_DATE} | This is to specify the expiry date of the account. |

Once the settings are complete, press the **Save** button to save and activate settings.

16.5 AP Profile

AP profiles assigned to each Pepwave AP device can be configured at **Network > WLAN Controller > AP Profiles**.

| Name | Action |
|----------------|--|
| 1. Default | Clone |
| 2. A's Profile | Clone ✖ |

Each AP is associated with one AP Profile. By default, all devices are associated with the first (Default) profile. The Default profile cannot be removed.

You can define an AP profile by clicking the **New AP Profile** button. Click the **Clone** button of an existing profile to create a new profile based on it. To change the settings of an existing profile, click the profile name and the following screen will be shown.

AP Profile ✖

| | |
|-------------------|---|
| AP Profile Name | Default |
| Wireless Networks | <input checked="" type="checkbox"/> Wireless_Network <input type="checkbox"/> Pepwave AP |

Wi-Fi AP Advanced Settings

| | |
|--|--|
| Management VLAN ID ? | 0 (0: Untagged) |
| Protocol | 802.11bgn |
| Operating Country | Default (US) |
| Channel Bonding | 20 MHz |
| Channel | 1 (2.412 GHz) |
| 802.1X Version | <input type="radio"/> V1 <input checked="" type="radio"/> V2 |
| Beacon Rate | 1Mbps <input type="button" value="Default"/> |
| Beacon Interval | 100ms <input type="button" value="Default"/> |
| DTIM | 1 <input type="button" value="Default"/> |
| RTS Threshold | 0 <input type="button" value="Default"/> |
| Slot Time | 9 μ s <input type="button" value="Default"/> |
| ACK Timeout | 48 μ s <input type="button" value="Default"/> |
| Frame Aggregation | <input checked="" type="checkbox"/> |
| Frame Length | 50000 <input type="button" value="Default"/> |

Web Administration Settings

| | |
|---------------------------|---|
| Enable | <input checked="" type="checkbox"/> |
| Web Access Protocol | <input type="radio"/> HTTP <input checked="" type="radio"/> HTTPS |
| Management Port | 443 |
| HTTP to HTTPS Redirection | <input checked="" type="checkbox"/> |
| Admin Username | admin |
| Admin Password | 96090b8a81c5 <input type="button" value="Generate"/> |

| AP Profile | |
|--------------------------|--|
| AP Profile Name | It specifies the name of this AP Profile. |
| Wireless Networks | It specifies which Wireless Networks would be chosen and used this AP Profile. |

| Wi-Fi AP Advanced Settings | |
|----------------------------|--|
| Management VLAN ID | This field specifies the VLAN ID to tag to management traffic, such as inter-AP-WLAN-controller communication traffic. The value is zero by default, which means that no VLAN tagging will be applied. NOTE: change this value with caution as alterations may result in loss of connection to the WLAN controller. |
| Protocol | <p>There are five options are available:</p> <p>802.11bgn: Pepwave AP devices accept 802.11b, 802.11g and 802.11n client association requests.</p> <p>802.11b/g: Pepwave AP devices accept both 802.11b and 802.11g client association requests.</p> <p>802.11b Only: Pepwave AP devices accept only 802.11b client association requests.</p> <p>802.11g Only: Pepwave AP devices accept only 802.11g client association requests.</p> <p>802.11n Only: Pepwave AP devices accept only 802.11n client association requests.</p> |
| Operating Country | <p>This setting specifies the country / region regulations which Pepwave AP One unit should follow.</p> <p>If North America region is selected, RF channels 1 to 11 are available. Maximum transmission power is 26 dBm (400 mW).</p> <p>If Europe region is selected, RF channels 1 to 13 are available. Maximum transmission power is 20 dBm (100 mW).</p> <p>NOTE: Users are required to choose the suitable option based on local laws and regulations.</p> |
| Channel Bonding | <p>This setting is only available when the protocol is selected as 802.11bgn or 802.11n Only.</p> <p>There are three options: 20 MHz, 20/40 MHz and 40 MHz</p> <p>With this feature enabled, it allows the Wi-Fi system to use two channels at once. Using two channels improves the performance of the Wi-Fi connection</p> |
| Channel | <p>This option selects the 802.11 channel to be utilized. Available options are from 1 to 11, and from 1 to 13 for the country setting of North America region and Europe region, respectively. (Channel 14 is only available when the country is selected as Japan with protocol 802.11b.)</p> <p>If Auto is set, the system would perform channel scanning based on the scheduled time set and choose the most suitable channel automatically.</p> |
| 802.1X Version | <p>This setting selects between v1 or v2 of the 802.1x EAPOL.</p> <p>When v1 is selected, both v1 and v2 clients can associate with the access point. However, when v2 is selected, only v2 clients can associate with the access point.</p> |

| | |
|--------------------------|--|
| | Most modern wireless clients support v2. In the event that there are stations that do not support v2, select the option v1. By default, the value of the setting is v2 . |
| Beacon Rate | This setting provides the option to send beacon in different transmit bit rate and the bit rates are: 1Mbps, 2Mbps, 5.5Mbps, 6Mbps, 11Mbps . |
| Beacon Interval | This setting provides the option to set the time between each beacon send. Available options are: 100ms, 250ms and 500ms . |
| DTIM | This setting provides the option to set the frequency for beacon to include Delivery Traffic Indication Message, DTIM. The interval unit is in millisecond. |
| RTS Threshold | This setting provides the option to set the minimum packet size for the unit to send an RTS using the RTS/CTS handshake. Setting zero would disable this feature. |
| Slot Time | This setting provides the option to modify the unit wait time before it transmits. The default value is 9 μ s. |
| ACK Timeout | This setting provides the option to set the wait time to receive acknowledgement packet before doing retransmission. The default value is 48 μ s. |
| Frame Aggregation | With this feature enabled, throughput will be increased by sending two or more data frames in a single transmission. |
| Frame Length | This option is only available when Frame Aggregation is enabled. It specifies the frame length for frame aggregation. By default, it is set as 50000 . |

| Web Administration Settings | |
|----------------------------------|---|
| Enable | Check the box to allow Peplink Balance to manage the web admin access information of the Pepwave AP One. |
| Web Access Protocol | This option specifies the web access protocol used for accessing the web admin of Pepwave AP One. The two available options are HTTP and HTTPS . |
| Management Port | This is to specify the management port used for accessing the device. |
| HTTP to HTTPS Redirection | This option will be available if you have chosen HTTPS as the Web Access Protocol. With this enabled, any HTTP access to the web admin will be redirect to HTTPS automatically. |
| Admin User Name | This specifies the administrator username of the web admin. It is set as admin by default. |
| Admin Password | This field allows you to specify a new administrator password. You may also click the Generate button and let the system generate a random password automatically. |

17 QoS

17.1 User Groups

(Available on Peplink Balance 380+)

LAN and PPTP clients can be categorized into three user groups - **Manager, Staff, and Guest**. This table allows you to define rules and assign client IP addresses or subnets to a user group. You can apply different bandwidth and traffic prioritization policies on each user group in the Bandwidth Control and Application sections.

The table is automatically sorted, and the table order signifies the rules' precedence. The smaller and more specific subnets are put towards the top of the table and have higher precedence; larger and less specific subnets are placed towards the bottom.

Click the **Add** button to define clients and their user group. Click the  button to remove the defined rule.

Two default rules are pre-defined and put at the bottommost. They are **All DHCP reservation clients** and **Everyone**, and they cannot be removed. **All DHCP reservation clients** represents the LAN clients defined in the DHCP Reservation table in the LAN settings page. **Everyone** represents all clients that are not defined in any rule above. Click on a rule to change its group.

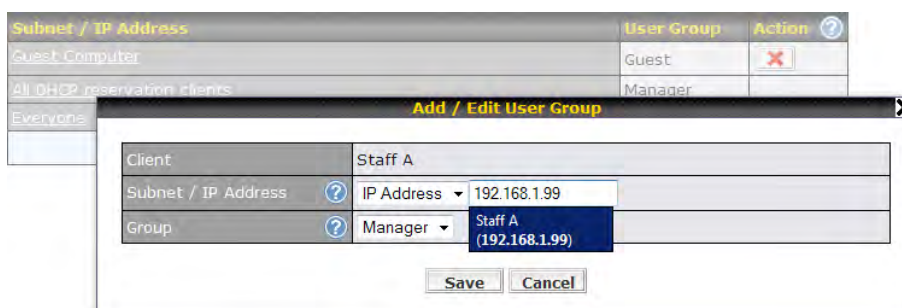

| Add / Edit User Group | |
|----------------------------|--|
| Subnet / IP Address | From the drop-down menu, choose whether you are going to define the client(s) by an IP Address or a Subnet . If IP Address is selected, enter a name defined in DHCP Reservation table or a LAN client's IP address. If Subnet is selected, enter a subnet address and specify its subnet mask. |
| Group | This field is to define which User Group the specified Subnet / IP Address belongs to. |

Once users have been assigned to a user group, their internet traffic will be restricted by rules defined for that particular group. Please refer to the following two sections for details.

17.2 Bandwidth Control

(Available on Peplink Balance 380+)

This section is to define how much minimum bandwidth will be reserved to each user group when a WAN connection is **in full load**. When this feature is enabled, a slider with two indicators will be shown. You can move the indicators to adjust each group's weighting. The lower part of the table shows the corresponding reserved download and upload bandwidth value of each connection.

By default, **50%** of bandwidth has been reserved for Manager, **30%** for Staff, and **20%** for Guest.

| Group Bandwidth Reservation | | | | |
|-----------------------------|-------------------------------------|----------------|--------------|--------------|
| Enable | <input checked="" type="checkbox"/> | | | |
| Group Reserved Bandwidth | | ↔ | ↔ | |
| | | Manager | Staff | Guest |
| | % BW | 50% | 30% | 20% |
| | WAN1 | 50.0M/50.0M | 30.0M/30.0M | 20.0M/20.0M |
| | WAN2 | 3.9M/4.0M | 2.3M/2.4M | 1.6M/1.6M |
| WAN3 | 750k/1.0M | 450k/614k | 300k/410k | |

You can define a maximum download speed (over all WAN connections) and upload speed (for each WAN connection) that each individual Staff and Guest member can consume. No limit can be imposed on individual Manager members.

By default, Download and Upload Bandwidth Limits are set to unlimited (set as **0**).

| Individual Bandwidth Limit | | | | | |
|----------------------------|-------------------------------------|----------|-----------|----------------|--|
| Enable | <input checked="" type="checkbox"/> | | | | |
| User Bandwidth Limit | Download | | Upload | | |
| | Manager: Unlimited | | Unlimited | | |
| | Staff: | 20 Mbps | 10 Mbps | (0: unlimited) | |
| | Guest: | 500 Kbps | 100 Kbps | (0: unlimited) | |

17.3 Application

17.3.1 Application Prioritization

For Peplink Balance 20, 30, 210 and 310:

Three priority levels can be set for application prioritization: ↑ High, — Normal, and ↓ Low.

Peplink Balance can detect various application traffics by inspecting the packets' content. Select an application by choosing a supported application, or by defining a custom application manually. The priority preference of supported applications is placed at the top of the table. Custom applications are at the bottom.

| Application | Priority | Action ? |
|--------------|----------|----------|
| PPTP | — Normal | |
| IPsec | ↑ High | |
| SIP | ↑ High | |
| Skype | ↑ High | |
| RTP | ↑ High | |
| RealMedia | ↓ Low | |
| Windowsmedia | ↓ Low | |
| MMS | — Normal | |
| RTSP | — Normal | |
| SSL | — Normal | |

For Peplink Balance 380, 580, 710 and 1350:

You can choose whether to apply the same Prioritization settings to all user groups or customize the settings for each group.

Application Prioritization

Apply same settings to all users
 Customize

Three priority levels can be set for application prioritization: ↑ High, — Normal, and ↓ Low.

Peplink Balance supports detect various application traffics by inspecting the packets' content. Select an application by choosing a supported application, or by defining a custom application manually. The priority preference of supported applications is placed at the top of the table. Custom applications are at the bottom.

| Application | Priority | | | Action ? |
|--------------|----------|----------|----------|----------|
| | Manager | Staff | Guest | |
| PPTP | ↑ High | — Normal | — Normal | |
| IPsec | ↑ High | — Normal | — Normal | |
| SIP | ↑ High | ↑ High | ↑ High | |
| Skype | — Normal | — Normal | ↓ Low | |
| RTP | — Normal | — Normal | ↓ Low | |
| RealMedia | — Normal | — Normal | ↓ Low | |
| Windowsmedia | — Normal | — Normal | ↓ Low | |
| MMS | — Normal | — Normal | ↓ Low | |
| RTSP | — Normal | — Normal | ↓ Low | |
| video_conf | ↑ High | ↑ High | ↑ High | |

17.3.2 Prioritization for Custom Application

Click the **Add** button to define a custom application. Click the button  in the **Action** column to delete the custom application in the corresponding row.

When **Supported Applications** is selected, the Peplink Balance will inspect network traffic and prioritize the selected application. Alternatively, select **Custom Applications** and define the application by providing the protocol, scope, port number, and DSCP value.

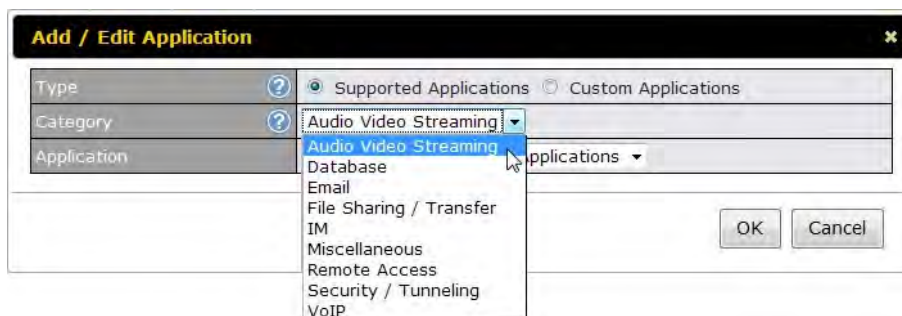

Category and **Application** availability will be different across different models of Peplink Balance.

17.3.3 DSL/Cable Optimization

DSL/cable-based WAN connection has its upload bandwidth lower than the download bandwidth. When this option is enabled, the download bandwidth of the WAN can be fully utilized in any situation.

When a DSL/cable circuit's uplink is congested, the download bandwidth will be affected. Users will not be able to download data in full speed until the uplink becomes less congested. The DSL/Cable Optimization can relieve such issue. When it is enabled, the download speed will become less affected by the upload traffic.

By default, this feature is enabled.

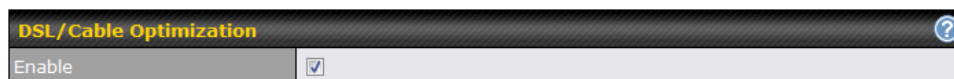

18 Firewall

A firewall is a mechanism that selectively filters data traffic between the WAN side (the Internet) and the LAN side of the network. It can protect the local network from potential hacker attacks, offensive Web sites, and/or other inappropriate uses.

The firewall functionality of Peplink Balance supports the selective filtering of data traffic in both directions:

- Outbound (LAN to WAN)
- Inbound (WAN to LAN)
- Intrusion Detection and DoS Prevention
- Web Blocking

With Site-to-Site VPN enabled (see **Section 12**), the firewall rules also apply to VPN tunneled traffic.

18.1 Outbound and Inbound Firewall

18.1.1 Access Rules

The outbound and inbound firewall settings are located at: **Network > Firewall > Access Rules**

Outbound Firewall Rules (Drag and drop rows to change rule order) ?

| Rule | Protocol | Source IP Port | Destination IP Port | Policy |
|---------|----------|----------------|---------------------|--------|
| Default | Any | Any | Any | Allow |

Inbound Firewall Rules (Drag and drop rows to change rule order) ?

| Rule | Protocol | WAN | Source IP Port | Destination IP Port | Policy |
|---------|----------|-----|----------------|---------------------|--------|
| Default | Any | Any | Any | Any | Allow |

Upon clicking **Add Rule**, the following screen appears:

Add a New Inbound Firewall Rule X

| New Firewall Rule | |
|-----------------------|--|
| Rule Name * | <input type="text"/> |
| Enable | <input checked="" type="radio"/> Yes <input type="radio"/> No |
| WAN Connection | Any |
| Protocol | Any ← :: Protocol Selection Tool :: |
| Source IP & Port | Any Address |
| Destination IP & Port | Any Address |
| Action | <input checked="" type="radio"/> Allow <input type="radio"/> Deny |
| Event Logging | <input type="checkbox"/> Enable |

Inbound / Outbound Firewall Settings

Rule Name This setting specifies a name for the firewall rule.

Enable This setting specifies whether the firewall rule should take effect.
When **Yes** is selected, the firewall rule takes effect. If the traffic matches the specified Protocol/IP/Port, actions will be taken by Peplink Balance based on the other parameters of the rule.
When **No** is selected, the firewall rule does not take effect. Peplink Balance will disregard the other parameters of the rule.

WAN Connection This setting is applicable to Inbound Firewall Rules only.
This setting specifies the WAN connection(s) on which the rule applies:

1. **Any**
2. **WAN1**
3. **WAN2**
4. **WAN3** (applicable only to Peplink Balance 30, 310, 380, 580, 710 and 1350)
5. **WAN4 to WAN5** (applicable only to Peplink Balance 580, 710 and 1350)
6. **WAN6 to WAN7** (applicable only to Peplink Balance 710 and 1350)
7. **WAN8 to WAN13** (applicable only to Peplink Balance 1350)
8. **Mobile Internet** (applicable only to Peplink Balance 20, 30, 380, 580, 710 and 1350)

A value of **Any, WAN1, WAN2, ... and Mobile Internet** specifies that the rule applies to all WAN connections, WAN1, WAN2, ... and Mobile Internet, respectively.

Protocol This setting specifies the protocol to be matched.
Via a drop-down menu, the following protocols can be specified:

- **TCP**
- **UDP**
- **ICMP**
- **IP**

Alternatively, the **Protocol Selection Tool** drop-down menu can be used to automatically fill in the Protocol and Port number of common Internet services (e.g. HTTP, HTTPS, etc.)
After selecting an item from the **Protocol Selection Tool** drop-down menu, the Protocol and Port number remains manually modifiable.

Source IP & Port This specifies the source IP address(es) and port number(s) to be matched for a firewall rule.
A single address, or a network, can be specified as the Source IP & Port setting, as indicated with the following screenshots:

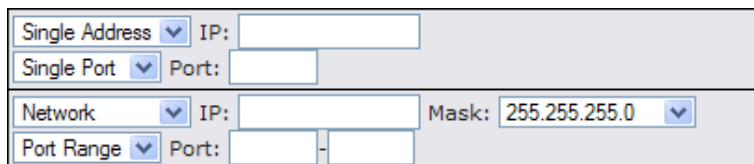

The screenshot shows a configuration interface for the Source IP & Port setting. It contains four rows of input fields:

- Row 1: A dropdown menu set to "Single Address" followed by an "IP:" label and an empty text input field.
- Row 2: A dropdown menu set to "Single Port" followed by a "Port:" label and an empty text input field.
- Row 3: A dropdown menu set to "Network" followed by an "IP:" label and an empty text input field, and a "Mask:" label followed by a dropdown menu set to "255.255.255.0".
- Row 4: A dropdown menu set to "Port Range" followed by a "Port:" label and two empty text input fields separated by a hyphen.

In addition, a single port, or a range of ports, can be specified for the Source IP & Port setting.

Destination IP & Port

This specifies the destination IP address(es) and port number(s) to be matched for a firewall rule.

A single address, or a network, can be specified as the Source IP & Port setting, as indicated with the following screenshots:

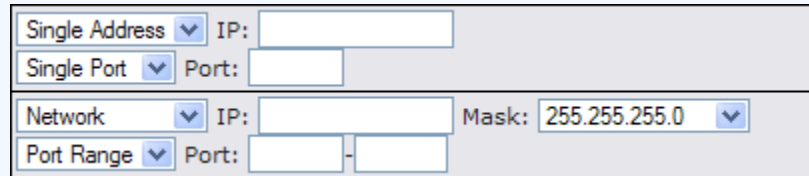

The screenshot shows a configuration form with four rows of input fields:

- Row 1: "Single Address" dropdown, "IP:" text box, and a greyed-out "Port:" text box.
- Row 2: "Single Port" dropdown, "Port:" text box, and a greyed-out "IP:" text box.
- Row 3: "Network" dropdown, "IP:" text box, "Mask:" text box with "255.255.255.0" selected, and a dropdown arrow.
- Row 4: "Port Range" dropdown, "Port:" text box, a hyphen "-", and another "Port:" text box.

In addition, a single port, or a range of ports, can be specified for the Source IP & Port setting.

Action

This setting specifies the action to be taken by Peplink Balance upon encountering traffic that matches the both of the following:

- Source IP & Port
- Destination IP & Port

With the value of **Allow** for the Action setting, the matching traffic passes through Peplink Balance (to be routed to the destination).

If the value of the Action setting is set to **Deny**, the matching traffic does not pass through Peplink Balance (and is discarded).

Event Logging

This setting specifies whether or not to log matched firewall events.

The logged messages are shown on the page Status > Event Log.

A sample message is as follows:

```
Aug 13 23:47:44 Denied CONN=Ethernet WAN SRC=20.3.2.1
DST=192.168.1.20 LEN=48 PROTO=TCP SPT=2260 DPT=80
```

- **CONN:** The connection where the log entry refers to
- **SRC:** Source IP address
- **DST:** Destination IP address
- **LEN:** Packet length
- **PROTO:** Protocol
- **SPT:** Source port
- **DPT:** Destination port

Upon clicking **Save** after entering required information, the following screen appears.

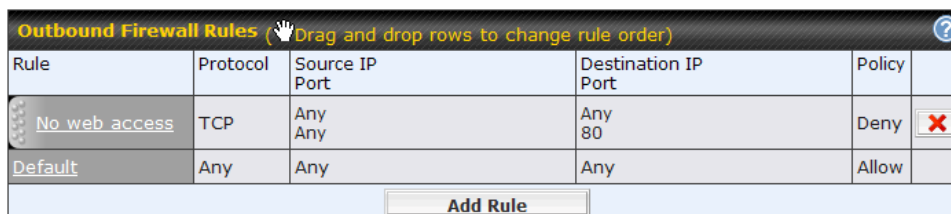



| Outbound Firewall Rules (Drag and drop rows to change rule order) | | | | |
|---|----------|----------------|---------------------|--|
| Rule | Protocol | Source IP Port | Destination IP Port | Policy |
| No web access | TCP | Any Any | Any 80 | Deny  |
| Default | Any | Any | Any | Allow |

Add Rule

To create an additional firewall rule, click **Add Rule** and repeat the above steps.

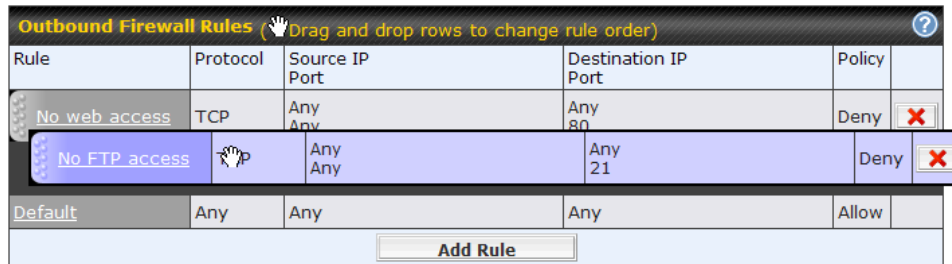
To reorder a rule's position, just drag on the rule by holding the left mouse button, move it to the desired position and drop it by releasing the mouse button.



| Rule | Protocol | Source IP Port | Destination IP Port | Policy | |
|---------------|----------|----------------|---------------------|--------|---|
| No web access | TCP | Any Any | Any 80 | Deny |  |
| No FTP access | | Any Any | Any 21 | Deny |  |
| Default | Any | Any | Any | Allow | |

To remove a rule, click .

Rules are matched from top to the bottom. If a connection matches any one of the upper rules, the matching process will stop. If none of the rules is matching, the **Default** rule will be applied.

By default, the **Default** rule is **Allow** for both outbound and inbound accesses.

Tip

If the default inbound rule is set as **Allow** for NAT enabled WANs, no inbound Allow firewall rules will be required for inbound Port Forwarding and inbound NAT Mapping rules. However, if the default inbound rule is set as **Deny**, a corresponding Allow firewall rules will be required.

18.1.2 Intrusion Detection and DoS Prevention

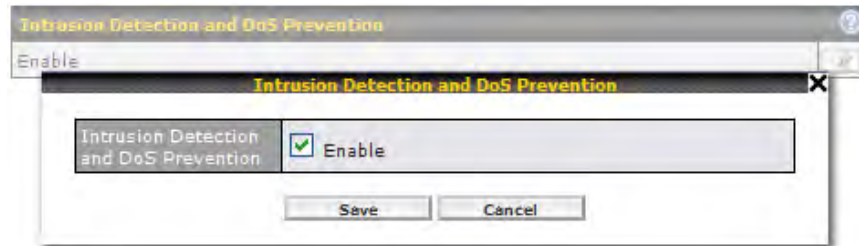

The Balance supports detecting and preventing intrusions and Denial-of-Service (DoS) attacks from the Internet. To turn on this feature, click , check the **Enable** check box for the **Intrusion Detection and DoS Prevention** and press the **Save** button.

When this feature is enabled, the Balance will detect and protect from the following kinds of intrusions and denial-of-service attacks.

- Port Scan:
- NMAP FIN/URG/PSH
- Xmas Tree
- Another Xmas Tree
- Null Scan
- SYN/RST
- SYN/FIN
- SYN Flood Prevention
- Ping Flood Attack Prevention

18.2 Web Blocking

(Available on Peplink Balance 380+)

| Web Blocking | | |
|----------------------|--|----------------------------------|
| Web Site Domain Name | | |
| <input type="text"/> | | <input type="button" value="+"/> |

| Exempted User Groups | |
|----------------------|---------------------------------|
| Manager | <input type="checkbox"/> Exempt |
| Staff | <input type="checkbox"/> Exempt |
| Guest | <input type="checkbox"/> Exempt |

| Exempted Subnets | | |
|----------------------|-----------------------|----------------------------------|
| Network | Subnet Mask | |
| <input type="text"/> | 255.255.255.0 (/24) ▾ | <input type="button" value="+"/> |

18.2.1 Web Blocking

Enter an appropriate website address and Peplink Balance will block and disallow LAN/PPTP/Site-to-Site VPN peer clients to access these websites. Exception can be added in the following sections - **18.2.2** and **18.2.3**.

You may enter the wild card ".*" at the end of a domain name to block any web site with a host name having the domain name in the middle.

For example, If you enter "foobar.*," then "www.foobar.com," "www.foobar.co.jp," or "foobar.co.uk" will be blocked.

Placing the wild card in any other position is not supported.

The Peplink Balance will inspect and look for blocked domain names on all HTTP traffic. Secure web (HTTPS) traffic is not supported.

18.2.2 Exempted User Group

Check and select pre-defined user group(s) who can exempt from the access blocking rules. User groups can be defined at **QoS > User Group** section. Please refer to section **17.1** for details.

18.2.3 Exempted Subnets

With the subnet defined in the field, clients on the particular subnet(s) can exempt from the access blocking rules.

19 Miscellaneous Settings

The miscellaneous settings include configuration for High Availability, PPTP Server, Service Forwarding, and Service Passthrough.

19.1 High Availability

(Available on Peplink Balance 210+)

Peplink Balance supports High Availability (HA) configurations via an open standard Virtual Router Redundancy Protocol (VRRP, RFC 3768).

In an HA configuration, two same-model Peplink Balance units (e.g. a pair of Peplink Balance 210 units, or a pair of Peplink Balance 710 units) provide redundancy and failover in a master-slave arrangement. From a high level, in the event that the Master Unit is down, the Slave Unit becomes active.

High Availability will be disabled automatically where there is a Drop-in connection configured on a LAN Bypass port.

The following diagram illustrates an HA configuration with two Peplink Balance 210 units, and two Internet connections:

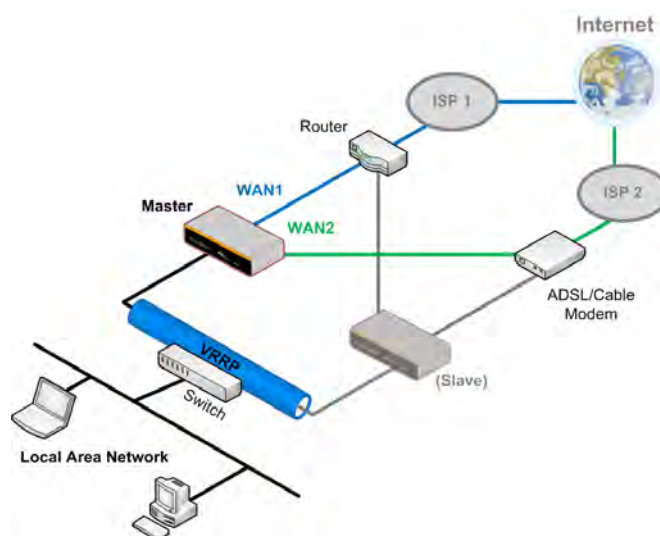

In the diagram, the WAN ports on each Peplink Balance unit connect to the router and modem; and Peplink Balance unit connects to the same LAN switch via a LAN port.

An elaboration on the technical details of the implementation, by Peplink Balance, of Virtual Router Redundancy Protocol (VRRP, RFC 3768) follows:

- In an HA configuration, the two Peplink Balance units communicate with each other using VRRP over the LAN.
- The two Peplink Balance units broadcast heartbeat signals to the LAN at a frequency of one heartbeat signal per second.
- In the event that no heartbeat signal from the Master Peplink Balance unit is received in 3 seconds (or longer) since the last heartbeat signal, the Slave Peplink Balance unit becomes active.
- The Slave Peplink Balance unit initiates the WAN connections, and binds to a previously configured LAN IP address.
- At a subsequent point when the Master Peplink Balance unit recovers, it will once again become active.

The settings to configure High Availability are located at the following location: **Network > Misc. Settings > High Availability**:

| High Availability Setup | | High Availability Setup | |
|----------------------------------|---|-------------------------|---|
| High Availability | <input checked="" type="checkbox"/> Enable | High Availability | <input checked="" type="checkbox"/> Enable |
| Group Number (1-255) | | Group Number (1-255) | |
| Preferred Role | <input checked="" type="radio"/> Master <input type="radio"/> Slave | Preferred Role | <input type="radio"/> Master <input checked="" type="radio"/> Slave |
| Resume Master Role Upon Recovery | <input checked="" type="checkbox"/> | Configuration Sync. | <input checked="" type="checkbox"/> |
| Virtual IP | | Master Serial Number | |
| LAN Administration IP | 192.168.1.1 | Virtual IP | |
| Subnet Mask | 255.255.255.0 | LAN Administration IP | 192.168.1.2 |
| | | Subnet Mask | 255.255.255.0 |

High Availability Settings

| | |
|---|--|
| High Availability | Checking this box specifies that the Peplink Balance unit is part of a High Availability configuration. |
| Group Number | This setting specifies a number that identifies a pair of Peplink Balance units that operate in a High Availability configuration. The two Peplink Balance units in the pair must have the same Group Number value. |
| Preferred Role | This setting specifies whether the Peplink Balance unit operates in Master or Slave mode. Click the corresponding radio button to set the role of the unit. One of the units in the pair must be configured as the Master and the other unit must be configured as the Slave |
| Resume Master Role Upon Recovery | This option is displayed when Master mode is selected in Preferred Role. If this option is enabled, once the device is recovered from outage, it will take over and resume its Master role from the slave unit. |
| Configuration Sync. | This option is displayed when Slave mode is selected in Preferred Role. If this option is enabled and the Master Serial Number entered matches with the actual master unit's, the master unit will automatically transfer the configuration to this unit. Please make sure the LAN IP Address and Subnet Mask fields are set correctly in the LAN Settings page. You can refer to the Event Log for the configuration synchronization status. |
| Master Serial Number | If the box Configuration Sync. is checked, serial number of the Master unit is required to be entered here. |
| Virtual IP | The setting specifies the LAN IP address on which the active Peplink Balance listens. The value of Virtual IP represents a LAN IP address that is shared among the Master and Slave units; however, at any time, only one of the two units will listen on the IP address. If the WAN is configured in NAT mode, Default Gateway of the clients on the LAN should be set to the virtual IP. These configurations are not required when the WAN is configured in Drop-in mode. |
| LAN Administration IP | This setting specifies a LAN IP address to be used for accessing administration functionality. This address should be unique within the LAN. |
| Subnet Mask | This setting specifies the subnet mask of the LAN. |

Important Note

For Balance in NAT mode, the VIP should be set as the default gateway for all hosts sitting on the LAN segment. For example, a firewall sitting behind the Balance should set its default gateway as the VIP instead of the IP of Master Balance.

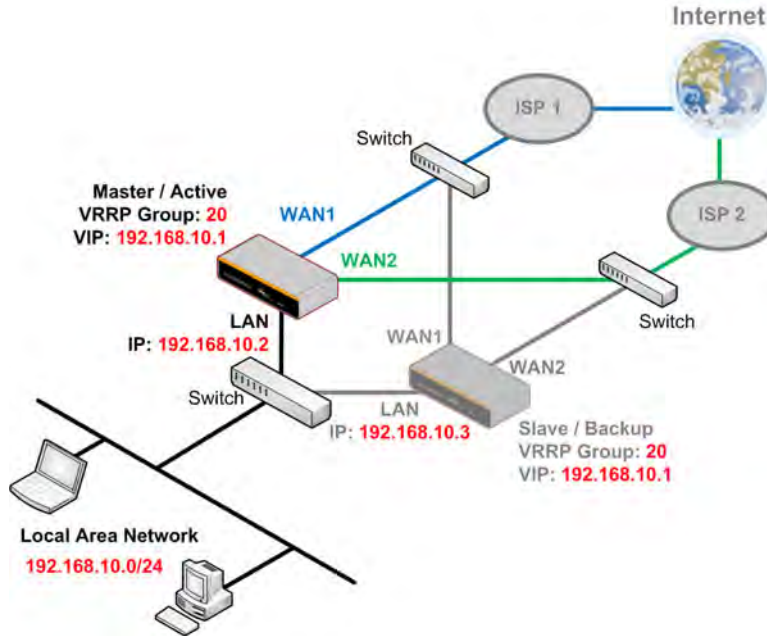

In Drop-in mode, no other configuration needs to be set.

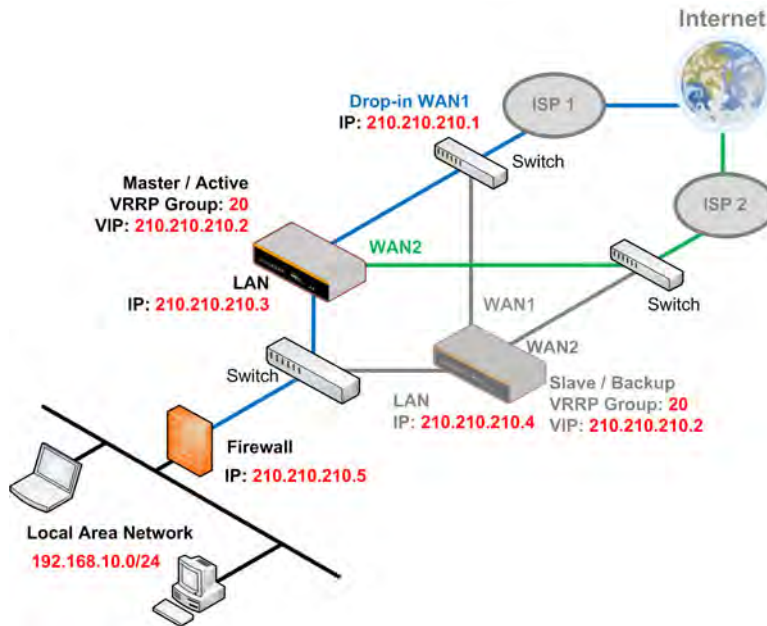

Please be noted that Drop-in WAN cannot be configured in LAN Bypass port when it is configuring High Availability.

19.2 PPTP Server

(Available on Peplink Balance 210+)



Peplink Balance has a built-in PPTP Server, which enables remote computers to conveniently and securely access the local network.

PPTP server setting is located at: **Network > Misc. Settings > PPTP Server**

Simply check the box to enable the PPTP server function. All connected PPTP sessions are displayed on the Client List at **Status > Client List**. Please refer to section 21.3 for details.

| PPTP Server | | | | | | | | | | | |
|--|--|-----------------------------|----------------------------------|--|---|-------------------------------|--|-------------------------------|--|--|--|
| Enable | <input checked="" type="checkbox"/> | | | | | | | | | | |
| Listen On | <table border="1"> <thead> <tr> <th colspan="2">Connection / IP Address(es)</th> </tr> </thead> <tbody> <tr> <td><input checked="" type="checkbox"/> WAN1</td> <td><input type="checkbox"/> 123.123.123.1 (Interface IP)</td> </tr> <tr> <td><input type="checkbox"/> WAN2</td> <td></td> </tr> <tr> <td><input type="checkbox"/> WAN3</td> <td></td> </tr> <tr> <td><input type="checkbox"/> Mobile Internet</td> <td></td> </tr> </tbody> </table> | Connection / IP Address(es) | | <input checked="" type="checkbox"/> WAN1 | <input type="checkbox"/> 123.123.123.1 (Interface IP) | <input type="checkbox"/> WAN2 | | <input type="checkbox"/> WAN3 | | <input type="checkbox"/> Mobile Internet | |
| Connection / IP Address(es) | | | | | | | | | | | |
| <input checked="" type="checkbox"/> WAN1 | <input type="checkbox"/> 123.123.123.1 (Interface IP) | | | | | | | | | | |
| <input type="checkbox"/> WAN2 | | | | | | | | | | | |
| <input type="checkbox"/> WAN3 | | | | | | | | | | | |
| <input type="checkbox"/> Mobile Internet | | | | | | | | | | | |
| Authentication | Local User Accounts ▼ | | | | | | | | | | |
| User Accounts * | <table border="1"> <tbody> <tr> <td>peplink</td> <td><input type="button" value="X"/></td> </tr> <tr> <td colspan="2" style="text-align: right;"><input type="button" value="Add"/></td> </tr> </tbody> </table> | peplink | <input type="button" value="X"/> | <input type="button" value="Add"/> | | | | | | | |
| peplink | <input type="button" value="X"/> | | | | | | | | | | |
| <input type="button" value="Add"/> | | | | | | | | | | | |

* Required

| PPTP Server Setting | |
|-----------------------|---|
| Listen On | This setting is for specifying the WAN connection(s) and IP address(es) where the PPTP server should listen on. |
| Authentication | <p>(This option is only applicable on Peplink Balance 380+.)</p> <p>This setting is for specifying the source of user database for PPTP authentication. There are three sources can be selected: Local User Accounts, LDAP Server, RADIUS Server.</p> <p>Local User Accounts - User accounts are stored in the Peplink Balance locally. You can add/modify/delete the accounts in the User Accounts table below.</p> <p>LDAP Server - Authenticate with an external LDAP server. Tested with OpenLDAP server where passwords are NTLM hashed. Active Directory is not supported. (You can choose to use RADIUS to authenticate with a Windows Server.)</p> <p>RADIUS Server - Authenticate with an external RADIUS server. Tested with Microsoft Windows Internet Authentication Service, and FreeRADIUS servers where passwords are NTLM hashed or in plain text.</p> |

User Accounts

This setting allows you to define the PPTP User Accounts. Click Add to input username and password to create an account. After adding the user accounts, you can click on a username to edit the account password. Click the button  to delete the account in its corresponding row.

Important Note

PPTP server will be disabled automatically if the Balance is deployed in Drop-in mode.

19.3 Service Forwarding

Service Forwarding settings are located at: **Network > Service Forwarding**

| SMTP Forwarding Setup | |
|--|---------------------------------|
| SMTP Forwarding | <input type="checkbox"/> Enable |
| Web Proxy Forwarding Setup | |
| Web Proxy Forwarding | <input type="checkbox"/> Enable |
| DNS Forwarding Setup | |
| Forward Outgoing DNS Requests to Local DNS Proxy | <input type="checkbox"/> Enable |

| Service Forwarding | |
|-----------------------------|---|
| SMTP Forwarding | When this option is enabled, all outgoing SMTP connections destined for any host at TCP port 25 will be intercepted. These connections will be redirected to a specified SMTP server and port number. SMTP server settings for each WAN can be specified after selecting Enable . |
| Web Proxy Forwarding | When this option is enabled, all outgoing connections destined for the proxy server specified in Web Proxy Interception Settings will be intercepted. These connections will be redirected to a specified web proxy server and port number. Web Proxy Interception Settings and proxy server settings for each WAN can be specified after selecting Enable . |
| DNS Forwarding | When this option is enabled, all outgoing DNS lookups will be intercepted and redirected to the built-in DNS name server. If any LAN device is using DNS name servers of a WAN connection, you may want to enable this option to enhance the DNS availability without modifying the DNS server setting of the clients. The built-in DNS name server will distribute DNS lookups to corresponding DNS servers of all available WAN connections. In this case, DNS service will not be interrupted even if any WAN connection is down. |

19.3.1 SMTP Forwarding

Some ISPs require their users to send e-mails via the ISP's SMTP server. All outgoing SMTP connections are blocked except those connecting to the ISP's. The Peplink Balance supports to intercept and redirect all outgoing SMTP connections (destined for TCP port 25) via a WAN connection to the WAN's corresponding SMTP server.

| SMTP Forwarding Setup | | | |
|-----------------------|-------------------------------------|--|-----------|
| SMTP Forwarding | | <input checked="" type="checkbox"/> Enable | |
| Connection | Enable Forwarding? | SMTP Server | SMTP Port |
| WAN1 | <input type="checkbox"/> | | |
| WAN2 | <input checked="" type="checkbox"/> | 22.2.2.2 | 25 |
| WAN3 | <input checked="" type="checkbox"/> | 33.3.3.2 | 25 |
| Mobile Internet | <input type="checkbox"/> | | |

To enable the feature, select the **Enable** check box under *SMTP Forwarding Setup*. Check the box **Enable Forwarding?** for the WAN connection(s) that needs such forwarding. Enter the ISP's e-mail server host name or IP address and TCP port number for each WAN.

The Peplink Balance will intercept SMTP connections, choose a WAN with reference to the Outbound Policy, and then forward the connection to the forwarded SMTP server if the chosen WAN has enabled forwarding. If the forwarding is disabled for a WAN connection, SMTP connections for the WAN will be simply forwarded to the connection's original destination.

| Note | |
|--|--|
| If you want to route all SMTP connections only to particular WAN connection(s), you should create a custom rule in Outbound Policy (see Section 13.1). | |

19.3.2 Web Proxy Forwarding

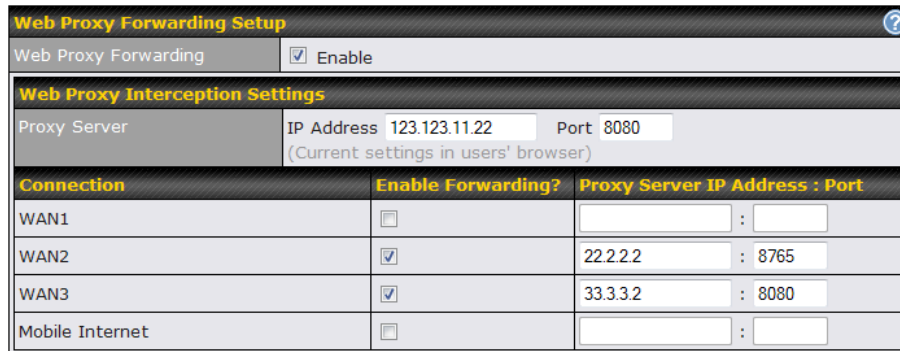

Web Proxy Forwarding Setup [?]

Web Proxy Forwarding Enable

Web Proxy Interception Settings

Proxy Server IP Address: 123.123.11.22 Port: 8080
(Current settings in users' browser)

| Connection | Enable Forwarding? | Proxy Server IP Address : Port |
|-----------------|-------------------------------------|--------------------------------|
| WAN1 | <input type="checkbox"/> | : |
| WAN2 | <input checked="" type="checkbox"/> | 22.2.2.2 : 8765 |
| WAN3 | <input checked="" type="checkbox"/> | 33.3.3.2 : 8080 |
| Mobile Internet | <input type="checkbox"/> | : |

When this feature is enabled, the Peplink Balance will intercept all outgoing connections destined for the proxy server specified in "Web Proxy Server Interception Settings", choose a WAN connection with reference of Outbound Policy, and then forward them to the specified web proxy server and port number. Redirected server settings for each WAN can be set here. If Forwarding is disabled for a WAN, web proxy connections for the WAN will be simply forwarded to the connection's original destination.

19.3.3 DNS Forwarding

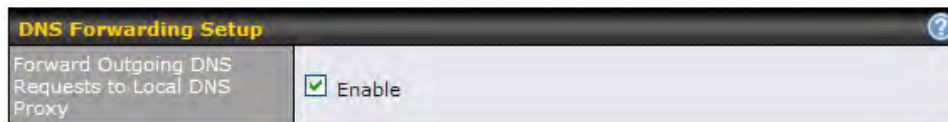

DNS Forwarding Setup [?]

Forward Outgoing DNS Requests to Local DNS Proxy Enable

When DNS Forwarding is enabled, all clients' outgoing DNS requests will also be intercepted and forwarded to the built-in DNS proxy server.

19.4 Service Passthrough

Service Passthrough settings can be found at: **Network > Misc. Settings > Service Passthrough**

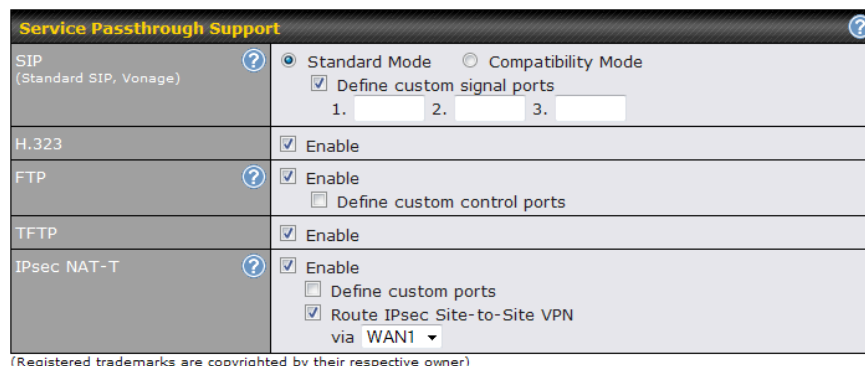

The screenshot shows the 'Service Passthrough Support' configuration window. It includes the following settings:

- SIP (Standard SIP, Vonage):** Radio buttons for 'Standard Mode' (selected) and 'Compatibility Mode'. A checked box for 'Define custom signal ports' with three input fields labeled 1., 2., and 3.
- H.323:** A checked box for 'Enable'.
- FTP:** A checked box for 'Enable' and an unchecked box for 'Define custom control ports'.
- TFTP:** A checked box for 'Enable'.
- IPsec NAT-T:** A checked box for 'Enable', an unchecked box for 'Define custom ports', and a checked box for 'Route IPsec Site-to-Site VPN' with a dropdown menu set to 'WAN1'.

(Registered trademarks are copyrighted by their respective owner)

Some Internet services required to be specially handled in a multi-WAN environment. The Peplink Balance supports handling such services correctly such that Internet applications do not notice it is behind a multi-WAN router. Settings for Service Passthrough Support are available here.

| Service Passthrough Support | |
|-----------------------------|--|
| SIP | <p>Session Initiation Protocol, aka SIP, is a voice-over-IP protocol. Peplink Balance can act as a SIP Application Layer Gateway (ALG) which binds connections for the same SIP session to the same WAN connection and translate IP address in the SIP packets correctly in NAT mode. Such passthrough support is always enabled and there are two modes for selection: Standard Mode and Compatibility Mode</p> <p>If your SIP server's signal port number is non-standard, you can check the box Define custom signal ports and input the port numbers to the text boxes.</p> |
| H.323 | <p>With this option enabled, protocols that provide audio-visual communication sessions will be defined on any packet network and passthrough the Balance.</p> |
| FTP | <p>FTP sessions consist of two TCP connections; one for control and one for data. In multi-WAN situation, they have to be binded to the same WAN connection. Otherwise, problems will arise in transferring files. By default, the Peplink Balance monitors TCP control connections on port 21 for any FTP connections and binds TCP connections of the same FTP session to the same WAN.</p> <p>If you have an FTP server listening on a port number other than 21, you can check the box Define custom control ports and enter the port numbers to the text boxes.</p> |
| TFTP | <p>The Peplink Balance monitors outgoing TFTP connections and routes any incoming TFTP data packets back to the client. Select Enable if you want to enable the TFTP Passthrough support.</p> |
| IPsec NAT-T | <p>This field is for enabling the support of IPsec NAT-T Passthrough. UDP ports 500, 4500 and 10000 are monitored by default.</p> <p>You may add more custom data ports that your IPsec system uses by checking the box Define custom ports. If the VPN contains IPsec Site-to-Site VPN traffic, you have to check the box Route IPsec Site-to-Site VPN and choose the WAN connection to route the traffic to.</p> <p>If you have IPsec Site-to-Site VPN traffic routed, check the Route IPsec Site-to-Site VPN option and select a WAN to force routing such traffic to the specified WAN.</p> |

20 System Settings

20.1 Admin Security

There are two user accounts available for accessing the Web Admin. Usernames are **admin** and **user**. They represent two user levels - **admin** has full administration access, while **user** is a read-only account. The read-only account can only access the device's status information and cannot make any change on the device.



Admin Account UI



User Account UI

A web login session will be logged out automatically when it has been idled for a longer time than the **Web Session Timeout**. The default timeout is 4 hours 0 minute. Before the session expires, you may click the **Logout** button in the Web Admin to exit from the session.

For security reason, after logging in to the Web Admin Interface for the first time, it is recommended to change the administrator password.

Configuring the administration interface to be accessible only from the LAN can further improve system security.

Administrative Settings configuration is located at: **System > Admin Security**

| Admin Settings | |
|----------------------------|--|
| Router Name | Balance_XXXX |
| Admin User Name | admin |
| Admin Password * | •••••••• |
| Confirm Admin Password * | •••••••• |
| Read-only User Name | user |
| User Password | •••••••• |
| Confirm User Password | •••••••• |
| Web Session Timeout | 4 Hours 0 Minutes |
| Authentication by RADIUS ? | <input checked="" type="checkbox"/> Enable |
| Auth Protocol | MS-CHAP v2 |
| Auth Server | Port <input type="text"/> Default |
| Auth Server Secret | <input type="text"/> <input checked="" type="checkbox"/> Hide Characters |
| Auth Timeout | 3 seconds |
| Accounting Server | Port <input type="text"/> Default |
| Accounting Server Secret | <input type="text"/> <input checked="" type="checkbox"/> Hide Characters |
| Network Connection | LAN |
| Security | HTTP / HTTPS |
| Web Admin Port | HTTP: 80 HTTPS: 443 Default |
| Web Admin Access | HTTP: LAN Only HTTPS: LAN/WAN |

| WAN Connection Access Settings | | | | | | | | | | | | | | | | | | | | | |
|--|--|-----------------------------|-------|-----|-------|--|--|--|--|--|--|--|--|-------------------------------|--|--|--|--|--|--|--|
| Allowed Source IP Subnets ? | <input type="radio"/> Any <input checked="" type="radio"/> Allow access from the following IP subnets only 12.34.45.0/24 11.22.33.0/24 | | | | | | | | | | | | | | | | | | | | |
| Allowed WAN IP Address(es) | <table border="1"> <thead> <tr> <th colspan="2">Connection / IP Address(es)</th> <th>All</th> <th>Clear</th> </tr> </thead> <tbody> <tr> <td><input checked="" type="checkbox"/> WAN1</td> <td> <input checked="" type="checkbox"/> 123.123.123.1 (Interface IP) <input type="checkbox"/> 123.123.123.10 <input type="checkbox"/> 123.123.123.11 </td> <td></td> <td></td> </tr> <tr> <td><input checked="" type="checkbox"/> WAN2</td> <td> <input checked="" type="checkbox"/> Interface IP <input type="checkbox"/> 1.1.1.1 </td> <td></td> <td></td> </tr> <tr> <td><input type="checkbox"/> WAN3</td> <td></td> <td></td> <td></td> </tr> <tr> <td><input type="checkbox"/> Mobile Internet</td> <td></td> <td></td> <td></td> </tr> </tbody> </table> | Connection / IP Address(es) | | All | Clear | <input checked="" type="checkbox"/> WAN1 | <input checked="" type="checkbox"/> 123.123.123.1 (Interface IP) <input type="checkbox"/> 123.123.123.10 <input type="checkbox"/> 123.123.123.11 | | | <input checked="" type="checkbox"/> WAN2 | <input checked="" type="checkbox"/> Interface IP <input type="checkbox"/> 1.1.1.1 | | | <input type="checkbox"/> WAN3 | | | | <input type="checkbox"/> Mobile Internet | | | |
| Connection / IP Address(es) | | All | Clear | | | | | | | | | | | | | | | | | | |
| <input checked="" type="checkbox"/> WAN1 | <input checked="" type="checkbox"/> 123.123.123.1 (Interface IP) <input type="checkbox"/> 123.123.123.10 <input type="checkbox"/> 123.123.123.11 | | | | | | | | | | | | | | | | | | | | |
| <input checked="" type="checkbox"/> WAN2 | <input checked="" type="checkbox"/> Interface IP <input type="checkbox"/> 1.1.1.1 | | | | | | | | | | | | | | | | | | | | |
| <input type="checkbox"/> WAN3 | | | | | | | | | | | | | | | | | | | | | |
| <input type="checkbox"/> Mobile Internet | | | | | | | | | | | | | | | | | | | | | |

| Admin Settings | |
|---------------------------------|--|
| Router Name | <p>This field allows you to define a name for this Peplink Balance unit.</p> <p>By default, Router Name is set as Balance_XXXX, where XXXX refers to the last 4 digits of the serial number of that balance unit.</p> |
| Admin User Name | It is set as admin by default and is not customizable. |
| Admin Password | This field allows you to specify a new administrator password. |
| Confirm Admin Password | This field allows you to verify and confirm the new administrator password. |
| Read-only User Name | It is set as user by default and is not customizable. |
| User Password | This field allows you to specify a new user password. Once the user password is set, the feature of read-only user will be enabled. |
| Confirm User Password | This field allows you to verify and confirm the new user password. |
| Web Session Timeout | <p>This field specifies the number of hours and minutes that a web session can remain idle before the balance terminates its access to Web Admin Interface.</p> <p>By default, it is set as 4 hours.</p> |
| Authentication by RADIUS | <p>With this box is checked, Web Admin will authenticate using an external RADIUS server. Authenticated users are treated as "admin" users with full read-write permission. Local "admin" and "user" accounts will be disabled. When the device is not able to communicate with the external RADIUS server, local accounts will be enabled again for emergency access.</p> <p>Authentication options will be available once this box is checked.</p> |

| | |
|---------------------------------|---|
| Auth Protocol | This specifies the authentication protocol used. Available options are MS-CHAP v2 and PAP . |
| Auth Server | This specifies the access address of the external RADIUS server. |
| Auth Server Secret | This is the secret for accessing the RADIUS server. |
| Auth Timeout | This option specifies the time value for authentication timeout. |
| Accounting Server | This specifies the access address of the external Accounting server. |
| Accounting Server Secret | This is the secret for accessing the Accounting server. |
| Network Connection | This option is for specifying the network connection which will be used for authentication connection. Users can choose from LAN, WAN and VPN connections. |
| Security | This option is for specifying the protocol(s) through which the Web Admin Interface can be accessible: <ul style="list-style-type: none"> • HTTP • HTTPS • HTTP/HTTPS |
| Web Admin Port | These fields are for specifying the port number at which the Web Admin Interface can be accessible. |
| Web Admin Access | This option is for specifying the network interfaces through which the Web Admin Interface can be accessible: <ul style="list-style-type: none"> • LAN only • LAN/WAN <p>If LAN/WAN is chosen, a WAN Connection Access Settings form will be displayed.</p> |

WAN Connection Access Settings

This field allows you to restrict web admin access only from defined IP subnets.

- **Any** - Allow web admin accesses to be from anywhere, without IP address restriction.
- **Allow access from the following IP subnets only** - Restrict web admin access only from the defined IP subnets. When this is chosen, a text input area will be displayed beneath:

Allowed Source IP Subnets

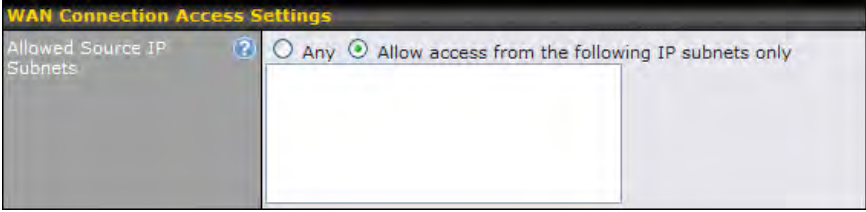

The allowed IP subnet addresses should be entered into this text area. Each IP subnet must be in form of *w.x.y.z/m*

where *w.x.y.z* is an IP address (e.g. 192.168.0.0), and
m is the subnet mask in CIDR format, which is between 0 and 32 inclusively. For example:
192.168.0.0/24

To define multiple subnets, separate each IP subnet one in a line.

For example:

192.168.0.0/24

10.8.0.0/16

This is to choose which WAN IP address(es) the web server should listen on.

**Allowed WAN IP
Address(es)**

| Allowed WAN IP Address(es) | |
|--|--|
| <input checked="" type="checkbox"/> WAN1 | <input checked="" type="checkbox"/> 210.10.10.1 (Interface IP) <input type="checkbox"/> 210.10.10.2 |
| <input type="checkbox"/> WAN2 | |
| <input type="checkbox"/> WAN3 | |
| <input type="checkbox"/> Mobile Internet | |

20.2 Firmware Upgrade

The firmware of Peplink Balance is upgradeable through Web Admin Interface.

Firmware upgrade functionality is located at: **System > Firmware**

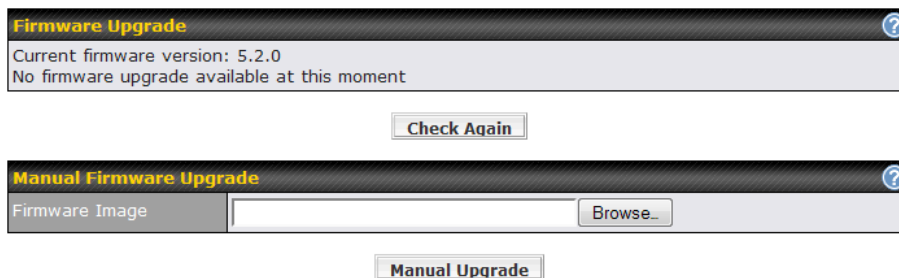

There are two ways to upgrade the unit. The first method is online firmware upgrade. The system can **Download and Upgrade** over the Internet. The second method is to upload a firmware file manually.

Click on the **Check again** button to use online upgrade. With online upgrade, Peplink Balance checks online for new firmware; if new firmware is available, the firmware is automatically downloaded by Peplink Balance. The upgrade process will subsequently be automatically initiated.

You may also download a firmware image from the Peplink website (<http://www.peplink.com>) and update the unit manually. Click **Browse...** to select the firmware file from the local computer, then click **Manual Upgrade** to send the firmware to Peplink Balance. Peplink Balance will then automatically initiate the firmware upgrade process.

Please note that all Peplink devices are equipped to be able to store two different firmware version in two different partitions. A firmware upgrade performed will always replace the inactive partition. If you want to keep the inactive firmware, you can simply reboot your device with the inactive firmware and then perform the firmware upgrade.

Firmware Upgrade Status for Peplink Balance 20, 30, 210 and 310

Status LED Information during firmware upgrade:

- OFF – Firmware upgrade in progress (DO NOT disconnect power.)
- Red – Unit is rebooting
- Green – Firmware upgrade successfully completed

Important Note

The firmware upgrade process may not necessarily preserve the previous configuration, and the behavior varies on a case-by-case basis. Consult the Release Notes for the particular firmware version.

Do not disconnect the power during firmware upgrade process.

Do not attempt to upload a non-firmware file, or a firmware file that is not qualified, or not supported, by Peplink.

Upgrading a Peplink Balance unit with an invalid firmware file will damage the unit, and may void the warranty.

Important Note

If the firmware is rolled back from 5.x to 4.x, the configurations will be lost.

20.3 Time

The Time Server functionality enables the system clock of Peplink Balance to be synchronized with a specified Time Server.

The settings for Time Server configuration are located at: **System > Time**

| Time Settings | |
|---------------|--|
| Time Zone | (GMT-08:00) Pacific Time (US & Canada) <input type="checkbox"/> Show all |
| Time Server | time.nist.gov <input type="button" value="Default"/> |

| Time Server Settings | |
|----------------------|--|
| Time Zone | This specifies the time zone (along with the corresponding Daylight Savings Time scheme) in which Peplink Balance operates. The Time Zone value affects the time stamps in the Event Log of Peplink Balance and E-mail notifications. Checked the box Show all to show all time zone options. |
| Time Server | This setting specifies the NTP network time server to be utilized by Peplink Balance. |

20.4 Email Notification

The Email Notification functionality of Peplink Balance provides a System Administrator with up to date information on network status.

The settings for configuring Email Notification are found at: **System > Email Notification**

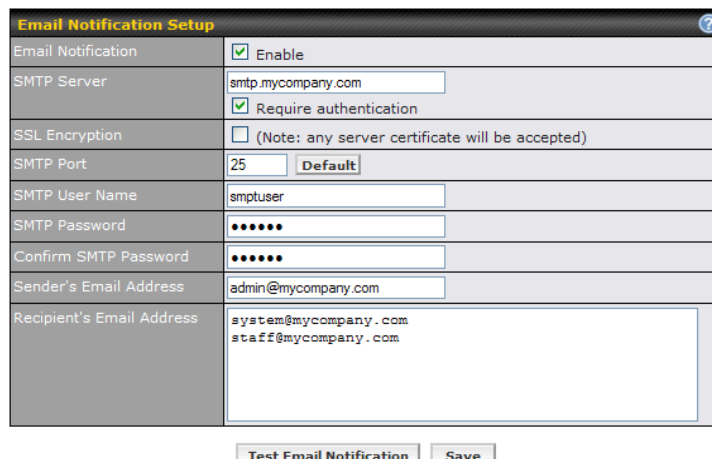

| Email Notification Settings | |
|----------------------------------|--|
| Email Notification | <p>This setting specifies whether or not to enable Email Notification.</p> <p>If the box Enable is checked, Peplink Balance sends email messages to a System Administrator when the WAN status changes, or when new firmware is available.</p> <p>If the box Enable is not checked, Email Notification is disabled and Peplink Balance will not send email messages.</p> |
| SMTP Server | <p>This setting specifies the SMTP server to be used for sending email. If the Server requires authentication, check the box Require authentication.</p> |
| SSL Encryption | <p>Check the box to enable SMTPS. When the box is checked, the next field SMTP Port will be changed to 465 automatically.</p> |
| SMTP Port | <p>This field is for specifying the SMTP Port number.</p> <p>By default, this is set to 25; when the SSL Encryption box is checked, the default port number will be set to 465.</p> <p>You may customize the port number by editing this field. Click the button Default to restore to default.</p> |
| SMTP User Name / Password | <p>This setting specifies the SMTP username and password while sending email. These options are shown only if Require authentication check box is checked in SMTP Server setting.</p> |
| Confirm SMTP Password | <p>This field allows you to verify and confirm the new administrator password.</p> |
| Sender's Email Address | <p>This setting specifies the sender email address reported by the email messages sent by Peplink Balance.</p> |
| Recipient's Email Address | <p>This setting specifies the email address to which Peplink Balance should send the email messages to. You may enter multiple recipients' email addresses in this field.</p> |

After you have completed the settings, you can click the **Test Email Notification** button to test the settings before saving it. After it is clicked, you will see this screen to confirm the settings:

| Test Email Notification | |
|---------------------------|---|
| SMTP Server | smtp.mycompany.com |
| SMTP Port | 25 |
| SMTP User Name | smtpuser |
| Sender's Email Address | admin@mycompany.com |
| Recipient's Email Address | system@mycompany.com staff@mycompany.com |

Click **Yes** to confirm. Wait a few seconds. You will see a returned message and the detailed test result.

Test email sent. Email notification settings are not saved, it will be saved after clicked the 'Save' button.

Test Result

```
[INFO] Try email through connection #3
[<-] 220 ESMTP
[->] EHLO balance
[<-] 250-smtp Hello balance [210.210.210.210]
250-SIZE 100000000
250-8BITMIME
250-PIPELINING
250-AUTH PLAIN LOGIN
250-STARTTLS
250-ENHANCEDSTATUSREPORTING=1
[>-] MAIL FROM:admin@mycompany.com
[<-] 250 OK
[>-] RCPT TO:system@mycompany.com
[<-] 250 OK
[>-] RCPT TO:staff@mycompany.com
[<-] 250 OK
[>-] QUIT
[<-] 220 Bye
```

20.5 Remote Syslog

The Remote Syslog functionality of Peplink Balance enables event logging at a specified remote Syslog server.

The settings for configuring Remote System Log are found at: **System > Remote Syslog**

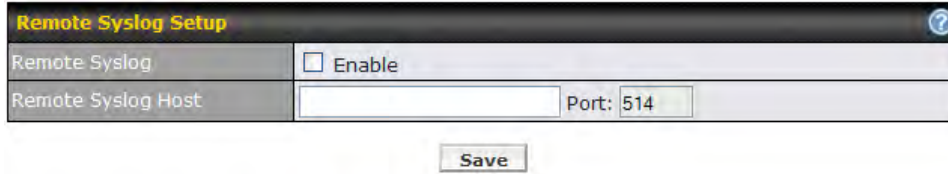

| Remote Syslog Setup | |
|---------------------|---------------------------------|
| Remote Syslog | <input type="checkbox"/> Enable |
| Remote Syslog Host | <input type="text"/> Port: 514 |

Save

| Remote Syslog Settings | |
|---------------------------|--|
| Remote Syslog | This setting specifies whether or not to log events at the specified remote Syslog server. |
| Remote Syslog Host | This setting specifies the IP address or host name of the remote Syslog server. |
| Port | This setting specifies the port number of the remote Syslog service. By default, the Port setting value is 514 . |

20.6 SNMP

SNMP, or Simple Network Management Protocol, is an open standard that can be used to collect information about the Peplink Balance unit.

SNMP configuration is located at: **System > SNMP**

| SNMP Settings | |
|-------------------------------------|--|
| SNMP Device Name | Balance_XXXX |
| SNMP Port | 161 <input type="button" value="Default"/> |
| SNMPv1 | <input checked="" type="checkbox"/> Enable |
| SNMPv2c | <input type="checkbox"/> Enable |
| SNMPv3 | <input type="checkbox"/> Enable |
| <input type="button" value="Save"/> | |

| Community Name | Allowed Source Network | Access Mode | |
|---|------------------------|-------------|---------------------------------------|
| MyCompany | 192.168.1.20/24 | Read Only | <input type="button" value="Delete"/> |
| <input type="button" value="Add SNMP Community"/> | | | |

| SNMPv3 User Name | Authentication / Privacy | Access Mode | |
|--|--------------------------|-------------|---------------------------------------|
| snmpuser | MD5 / DES | Read Only | <input type="button" value="Delete"/> |
| <input type="button" value="Add SNMP User"/> | | | |

| SNMP Settings | |
|-------------------------|---|
| SNMP Device Name | This field shows the router name defined in System > Admin Security. |
| SNMP Port | This option specifies the port which SNMP used. The default port is set as 161 . |
| SNMPv1 | This option allows you to enable SNMP version 1. |
| SNMPv2 | This option allows you to enable SNMP version 2. |
| SNMPv3 | This option allows you to enable SNMP version 3. |

To add a community for either SNMPv1 or SNMPv2, click the **Add SNMP Community** button in the **Community Name** table, upon which the following screen is displayed:

| SNMP Community Setting | |
|-------------------------------------|--|
| Community Name | MyCompany |
| Allowed Source Subnet Address | 192.168.1.20 |
| Allowed Source Subnet Mask | 255.255.255.0 <input type="button" value="v"/> |
| <input type="button" value="Save"/> | |

| SNMP Community Settings | |
|--------------------------------------|---|
| Community Name | This setting specifies the SNMP Community Name. |
| Allowed Source Subnet Address | This setting specifies a subnet from which access to the SNMP server is allowed. Enter subnet address here (e.g. 192.168.1.0). |

Allowed Source Subnet Mask This setting specifies the subnet mask that corresponds to the subnet specified via Allowed Source Subnet Address (e.g. 255.255.255.0).

To define a user name for SNMPv3, click **Add SNMP User** in the **SNMPv3 User Name** table, upon which the following screen is displayed:

| SNMPv3 User Setting | |
|-------------------------|-------------------|
| User Name | snmpuser |
| Authentication Protocol | MD5 |
| Authentication Password | mypassword |
| Privacy Protocol | DES |
| Privacy Password | myprivacypassword |

| SNMPv3 User Settings | |
|--------------------------------|--|
| User Name | This setting specifies a user name to be used in SNMPv3. |
| Authentication Protocol | <p>This setting specifies via a drop-down menu the one of the following valid authentication protocols:</p> <ul style="list-style-type: none"> NONE MD5 SHA |
| Authentication Password | This setting specifies the authentication password, and is applicable only if the MD5 or SHA authentication protocol is selected. |
| Privacy Protocol | <p>This setting specifies via a drop-down menu the one of the following valid privacy protocols:</p> <ul style="list-style-type: none"> NONE DES |
| Privacy Password | This setting specifies the privacy password, and is applicable only if the DES privacy protocol is selected. |

20.7 Reporting Server

The Reporting functionality enables Peplink Balance to post traffic data and other information periodically to a Peplink's Reporting Server for generating detailed historical usage reports of the device.

The settings for configuring Reporting Server functionality are found at the following location: **System > Reporting Server**:

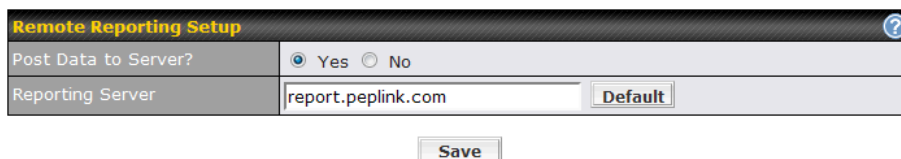

Remote Reporting Setup ?

| | |
|----------------------|--|
| Post Data to Server? | <input checked="" type="radio"/> Yes <input type="radio"/> No |
| Reporting Server | <input type="text" value="report.peplink.com"/> <input type="button" value="Default"/> |

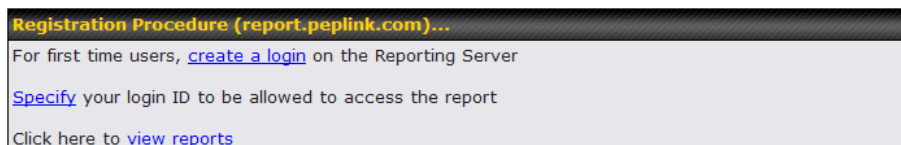

Registration Procedure (report.peplink.com)...

For first time users, [create a login](#) on the Reporting Server

[Specify](#) your login ID to be allowed to access the report

Click here to [view reports](#)

| Remote Reporting Settings | |
|----------------------------|---|
| Post Data to Server | This setting specifies whether or not Peplink Balance should periodically and automatically post traffic data to reporting server. |
| Reporting Server | This setting specifies the Internet IP address or host name of the reporting server. By default, the Reporting Server value is report.Peplink.com. |
| “create a login” | Click the link to register a login ID on Peplink's Reporting Server. Each login ID can associate with multiple Peplink Balance devices. If you already have a login ID on the server, you can skip this step. |
| “Specify” | Click on the link and the following window will pop up:  <p>Reporting Server Registration</p> <p>User Account * <input type="text"/></p> <p>Registration will contact the reporting server to associate this Peplink Balance with the specified user account on the server. Make sure you have a valid user account before this registration.</p> <p><input type="button" value="Update"/> <input type="button" value="Cancel"/></p> <p>Reporting Server: <input type="text" value="report.peplink.com"/></p> |
| | Fill in the “User Account” field to specify the login ID on the Reporting Server to be allowed to access the report of this Peplink Balance device. |

Click the link to view link usage reports from the Reporting Server. A login screen should be shown:

“view reports”



Peplink Balance Report Server 4.8.9

peplink
Balance Reporting Server

User Report Login

Username

Password

[Register Report Account](#) [Forgot Password](#)

Copyright (c) Peplink. All Rights Reserved.

Important Note

The registration process will establish contact to the reporting server to associate the Peplink Balance unit with the specified user account on the server.

Prior to registration, please ensure that the user account to be entered is valid.

20.8 Configuration

Backing up the Peplink Balance settings immediately after the successful completion of the initial setup is strongly recommended.

The functionality to download and upload Peplink Balance settings is found at: **System > Configuration**

The image displays four sequential screenshots of the Peplink Balance web administration interface, separated by horizontal lines. Each screenshot has a dark header bar with a title and a help icon (question mark in a circle) on the right.

- Restore Configuration to Factory Settings:** The header bar contains the title. Below it is a single button labeled "Restore Factory Settings".
- Download Active Configurations:** The header bar contains the title. Below it is a single button labeled "Download".
- Upload Configurations:** The header bar contains the title. Below it is a form with a label "Configuration File", an empty text input field, and a "Browse..." button. Below the form is an "Upload" button.
- Upload Configurations from High Availability Pair:** The header bar contains the title. Below it is a form with a label "Configuration File", an empty text input field, and a "Browse..." button. Below the form is an "Upload" button.

20.8.1 Restore Configuration to Factory Settings

The **Restore Factory Settings** button is to reset the configuration to the factory default settings. You have to click the **Apply Changes** button to make the settings effective.

20.8.2 Downloading Active Configurations

The **Download** button is to backup the current active settings. Click **Download** and save the configuration file.

20.8.3 Uploading Configurations

To restore or change settings based on a configuration file, click **Browse** to locate the configuration file on the local computer, and then click **Upload**.

The new settings can then be applied by clicking the **Apply Changes** button on the page header, or discard at the Main page of Web Admin Interface.

20.8.4 Uploading Configuration from High Availability Pair

(Available on Peplink Balance 210+)

In a High Availability (HA) configuration, to quickly load onto the Peplink Balance unit the configuration of its HA counterpart, click the **Upload** button.

After loading the settings, configure the LAN IP address of the Peplink Balance unit to be different from the HA counterpart.

20.9 Reboot

This page provides a Reboot button for restarting the system.

For highest reliability, Peplink Balance series are equipped with two copies of firmware of different version. You can select the firmware version you would like the device to reboot with.

The firmware marked with **(Running)** is the current system boot up firmware.

Please note that a firmware upgrade will always replace the inactive firmware partition.

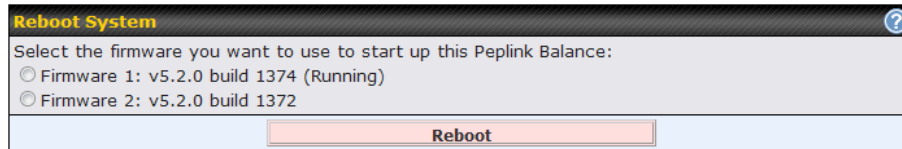

The screenshot shows a dialog box titled "Reboot System" with a question mark icon in the top right corner. The text inside the dialog box reads: "Select the firmware you want to use to start up this Peplink Balance:". Below this text are two radio button options: "Firmware 1: v5.2.0 build 1374 (Running)" and "Firmware 2: v5.2.0 build 1372". At the bottom of the dialog box is a red "Reboot" button.

20.10 Ping Test

The Ping Test tool in Peplink Balance performs Pings through a specified Ethernet interface or a Site-to-Site VPN connection (VPN connections are only available on Peplink Balance 210 or above).

You can specify the number of pings in the field **Number of times** to a maximum of **10** times, and Packet Size can be specified in the field **Packet Size** to a maximum of **1472** bytes.

The Ping utility is located at **System > Tools > Ping**, illustrated as follows:

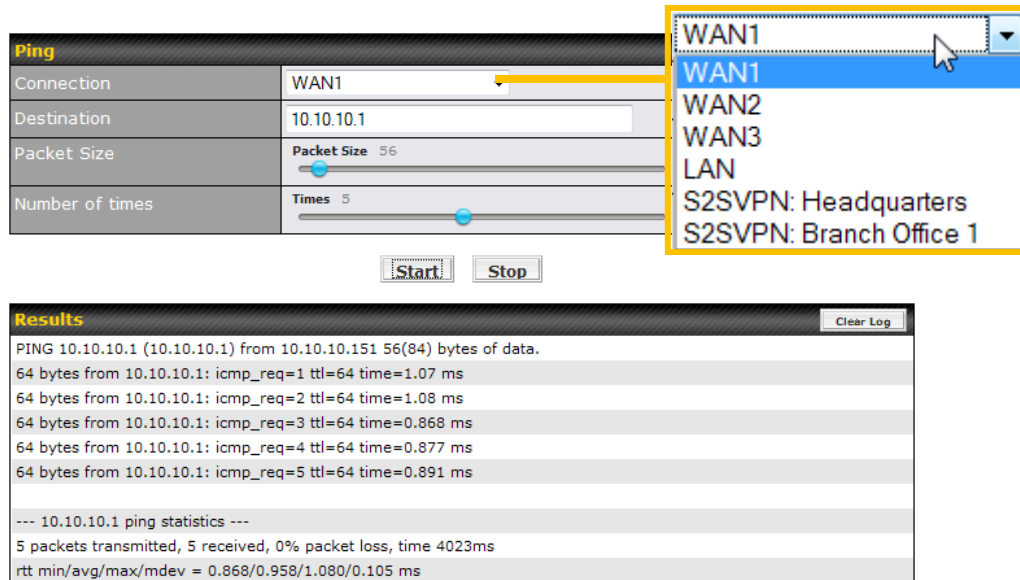

| Ping | |
|-----------------|----------------|
| Connection | WAN1 |
| Destination | 10.10.10.1 |
| Packet Size | Packet Size 56 |
| Number of times | Times 5 |

[Start] [Stop]

| Results | | Clear Log |
|--|--|-----------|
| PING 10.10.10.1 (10.10.10.1) from 10.10.10.151 56(84) bytes of data. | | |
| 64 bytes from 10.10.10.1: icmp_req=1 ttl=64 time=1.07 ms | | |
| 64 bytes from 10.10.10.1: icmp_req=2 ttl=64 time=1.08 ms | | |
| 64 bytes from 10.10.10.1: icmp_req=3 ttl=64 time=0.868 ms | | |
| 64 bytes from 10.10.10.1: icmp_req=4 ttl=64 time=0.877 ms | | |
| 64 bytes from 10.10.10.1: icmp_req=5 ttl=64 time=0.891 ms | | |
| --- 10.10.10.1 ping statistics --- | | |
| 5 packets transmitted, 5 received, 0% packet loss, time 4023ms | | |
| rtt min/avg/max/mdev = 0.868/0.958/1.080/0.105 ms | | |

Tip

A System Administrator can use the Ping utility to manually check the connectivity of a particular LAN/WAN connection.

20.11 Traceroute Test

The Traceroute Test tool in Peplink Balance traces the routing path to the destination through a particular Ethernet interface or a Site-to-Site VPN connection (VPN connections are available on Peplink Balance 210+).

The Traceroute Test utility is located at **System > Tools > Traceroute**, illustrated as follows:

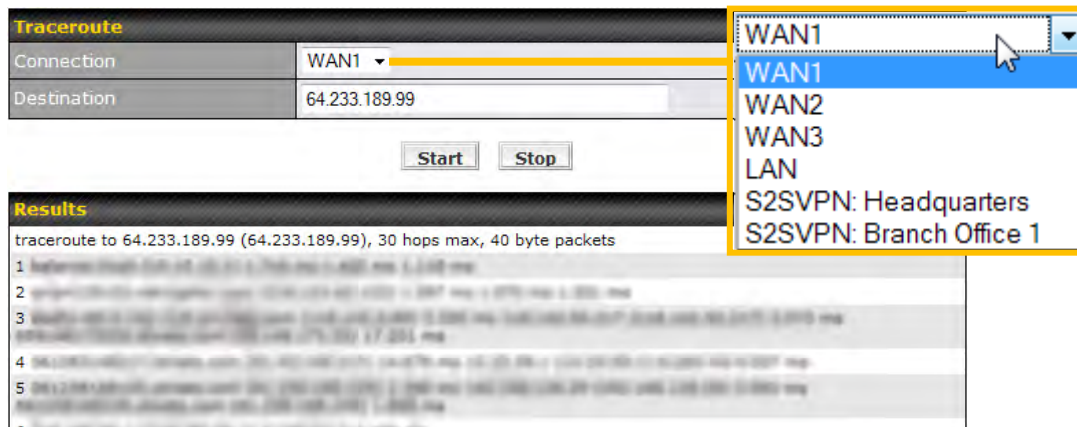

Tip

A System Administrator can use the Traceroute utility to analyze the connection path of a LAN/WAN connection.

20.12 VPN Test

(Available on Peplink Balance 210+)

The VPN Test tool can help to test the throughput between different VPN peers.

You can define the **Test Type**, **Direction**, and **Duration** of the test, and press **Go!** to perform the throughput test.

The VPN Test utility is located at **System > Tools > VPN Test**, illustrated as follows:

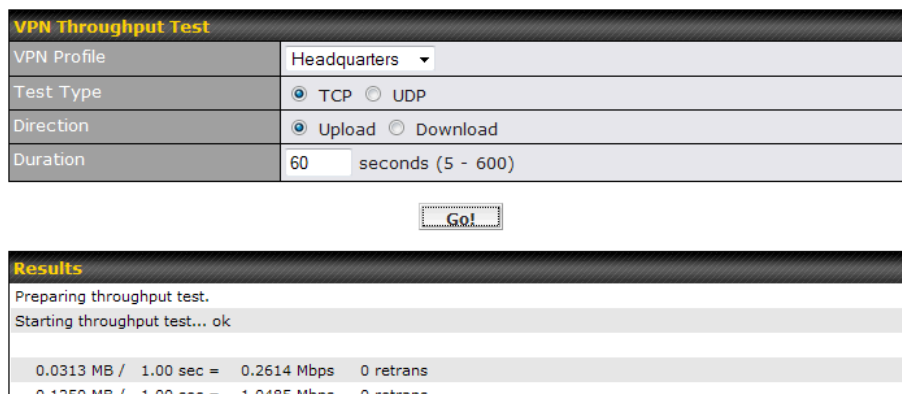

21 Status

This section displays the information of Peplink Balance on the **Device**, **Active Sessions**, **Client List**, **WINS Client List**, **Site-to-Site VPN**, **UPnP / NAT-PMP**, **Event Log**, and **Bandwidth**.

21.1 Device

System information is located at **Status > Device**:

| System Information | |
|--------------------|------------------------------|
| Router Name | Balance_XXXX |
| Model | Peplink Balance 380 |
| Hardware Revision | 4 |
| Serial Number | 1824-1234-1234 |
| Firmware | 5.2.0 build 1374 |
| Uptime | 3 day 7 hours 12 minutes |
| System Time | Wed Dec 15 17:31:28 PDT 2010 |
| Diagnostic Report | Download |

| Interface | MAC Address |
|-----------|-------------------|
| LAN | 00:11:AA:02:22:C0 |
| WAN 1 | 00:11:AA:02:22:C1 |
| WAN 2 | 00:11:AA:02:22:C2 |
| WAN 3 | 00:11:AA:02:22:C3 |

| System Information | |
|--------------------------|---|
| Router Name | This is the name specified in the field Router Name located in System > Admin Security. |
| Model | This shows the model name and number of this device. |
| Hardware Revision | This shows the hardware version of this device. |
| Serial Number | This shows the serial number of this device. |
| Firmware | This shows the firmware version in which this device is currently running. |
| Uptime | This shows the length of time since the device is rebooted. |
| System Time | This shows the current system time. |
| Diagnostic Report | Download button is for exporting a diagnostic report file required for system investigation. |

The second table shows the MAC address of each LAN/WAN interface connected.

Important Note

If you encounter issues and would like to contact Peplink Support Team (<http://www.peplink.com/contact/>), please download the diagnostic report file and attach it along with a description of your encountered issue.

In firmware 5.1 or before, Diagnostic Report file can be obtain at **System > Reboot**

21.2 Active Sessions

Information on Active Sessions is at: **Status > Active Sessions**



| Filter: 192.168.1.110 | | | | | |
|--|---------------------------------|---------------------------------|-------------|-----------|-----------|
| <input type="checkbox"/> 1 WAN1 | <input type="checkbox"/> 2 WAN2 | <input type="checkbox"/> 3 WAN3 | | | |
| <input type="checkbox"/> Mobile Internet | <input type="checkbox"/> VPN | | | | |
| Outbound | | | | | |
| Protocol | Source IP | Destination IP | Service | Interface | Idle Time |
| TCP | 192.168.1.110:4147 | 123.123.123.1:443 | HTTPS | WAN1 | 00:00:02 |
| ICMP | 192.168.1.110 | 60.60.60.1 | | WAN1 | 00:00:02 |
| TCP | 192.168.1.110:2423 | 123.123.123.1:443 | HTTP | WAN1 | 00:00:13 |
| TCP | 192.168.1.110:1144 | 123.123.123.123:5222 | XMPP Client | WAN2 | 00:00:19 |
| TCP | 192.168.1.110:1156 | 65.65.65.1:1863 | | WAN1 | 00:00:22 |
| UDP | 192.168.1.110:62817 | 90.123.90.1:123 | NTP | WAN2 | 00:00:29 |
| Inbound | | | | | |
| Protocol | Source IP | Destination IP | Service | Interface | Idle Time |
| UDP | 10.10.10.112:1024 | 192.168.1.110:514 | Syslog | WAN1 | 00:00:20 |

This Active Sessions section displays the active inbound / outbound sessions of each WAN connection on Peplink Balance.

A filter is available to help sort out the active session information. Enter a keyword in the field or check one of the WAN connection boxes for filtering.

21.3 Client List

The client list table is located at **Status > Client List**. It lists DHCP client **IP address**, their **Name** (retrieved from DHCP reservation table or defined by users), current **Download and Upload rate** and **MAC address** that the Peplink Balance has offered IP addresses to since it is powered up. Clients can be imported into DHCP Reservation table by clicking the  button on the right-most column. Further update the record after the import by going to **Network > LAN**.

| Client List | | | | | | |
|----------------|------------------|-----------------|---------------|----------------------|---|---|
| IP Address ▲ | Name | Download (kbps) | Upload (kbps) | MAC Address | Import | |
| 192.168.0.10 | | | 17 | 0 00:00:22:11:CC:0D |  | |
| 192.168.0.150 | Desktop | | 22 | 18 00:22:44:DD:11:33 | | <input type="button" value="Save"/> <input type="button" value="Cancel"/> |
| 192.168.0.200 | | | 0 | 0 00:1A:AA:AA:33:A0 |  | |
| 192.168.1.99 | | | 0 | 0 | | |
| 192.168.1.138 | Smart Phone | | 0 | 0 | | |
| 192.168.50.150 | Site-to-Site VPN | | 0 | 0 | | |



Scale: kbps Mbps

If PPTP Server in section 19.2, Site-to-Site VPN in section 12, or WLAN Controller in section 16 is enabled, you may see the corresponding connection name would be listed in the field of **Name**.

21.4 Access Point

(Available on Peplink Balance 380+)

The Status of connected access point devices can be found at **Status > Access Point**.

| Access Point | | | | | |
|--|------------|----------|-------------|---------|----|
| Name | IP Address | Firmware | AP Profile | Clients | Ch |
|  Pepwave AP One 1 | 10.9.2.15 | 3.0.9 | Main_Office | 4 | 1* |
|  Pepwave AP One 2 | | | Main_Office | | |

* = Auto

It lists all connected or detected Pepwave access point devices and their IP address, firmware version, assigned AP profile, number of connected clients and broadcasting channel.

The broadcasting channel follows by a "*" means the channel is automatically chosen and selected by the Peplink Balance.

21.5 WINS Client

The WINS client list table is located at **Status > WINS Client**.

| WINS Client List | |
|------------------|------------|
| Name ▲ | IP Address |
| UserA | 10.9.2.1 |
| UserB | 10.9.30.1 |
| UserC | 10.9.2.4 |

It lists WINS client IP addresses and their Names. This option will only be available when you have enabled the WINS Server in section 9.

Name of clients retrieved will be automatically matched into Client List in the previous section.



Click the button **Flush All** to flush all WINS client records.

21.6 Site-to-Site VPN

(Available on Peplink Balance 210+)

This is a page showing the current status of Site-to-Site VPN, located at: **Status > Site-to-Site VPN**

Details about Site-to-Site VPN connection peers would be shown as below.







| Site-to-Site VPN | | | | | |
|--|--|-------------|------------|---------------------|--|
| Peer | Remote Networks | | | | |
|  Headquarters | 192.168.30.0/24 | | | | |
| WAN1 |  In Use | Rx: 8 kbps | Tx: 5 kbps | Drop rate: 0.00/sec | |
| WAN2 |  In Use | Rx: 2 kbps | Tx: 1 kbps | Drop rate: 0.00/sec | |
| Total | | Rx: 10 kbps | Tx: 6 kbps | Drop rate: 0.00/sec | |

You can simply click on the corresponding peer name to explore the WAN connection(s) status and subnet information of each VPN peer.

21.7 UPnP / NAT-PMP

The table that shows the forwarded ports under UPnP and NAT-PMP protocols is located at **Status > UPnP / NAT-PMP**:

This section appears only if you have enabled the function of UPnP / NAT-PMP as mentioned in Section 14.4.

| Forwarded Ports | | | | | | |
|-----------------|----------|------------------|---------|----------|-----------------|---|
| External | Internal | Internal Address | Type | Protocol | Description | |
| 47453 | 3392 | 192.168.1.100 | UPnP | UDP | Application 031 |  |
| 35892 | 11265 | 192.168.1.50 | NAT-PMP | TCP | NAT-PMP 58 |  |
| 4500 | 3560 | 192.168.1.20 | UPnP | TCP | Application 013 |  |
| 5921 | 236 | 192.168.1.30 | UPnP | TCP | Application 047 |  |
| 22409 | 8943 | 192.168.1.70 | NAT-PMP | UDP | NAT-PMP 97 |  |
| 2388 | 27549 | 192.168.1.40 | UPnP | TCP | Application 004 |  |

Click the button  to delete the single UPnP / NAT-PMP record in its corresponding row. To delete all records, click **Delete All** on the right-hand side below the table.

Important Note

UPnP / NAT-PMP records would be deleted immediately after clicking the button  or **Delete All** without the need to click **Save** or **Confirm**.

21.8 Event Log

Event Log information is located at: **Status > Event Log**

21.8.1 Device Event Log

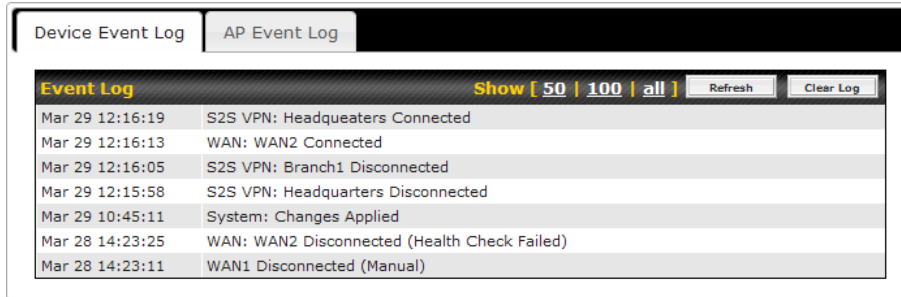

The screenshot shows the 'Device Event Log' interface. At the top, there are two tabs: 'Device Event Log' (selected) and 'AP Event Log'. Below the tabs is a header bar with 'Event Log' on the left, 'Show [50 | 100 | all]' in the center, and 'Refresh' and 'Clear Log' buttons on the right. The main area contains a table of event entries.

| Time | Event Description |
|-----------------|--|
| Mar 29 12:16:19 | S2S VPN: Headqueaters Connected |
| Mar 29 12:16:13 | WAN: WAN2 Connected |
| Mar 29 12:16:05 | S2S VPN: Branch1 Disconnected |
| Mar 29 12:15:58 | S2S VPN: Headquarters Disconnected |
| Mar 29 10:45:11 | System: Changes Applied |
| Mar 28 14:23:25 | WAN: WAN2 Disconnected (Health Check Failed) |
| Mar 28 14:23:11 | WAN1 Disconnected (Manual) |

The log section displays a list of events that has taken place on the Peplink Balance unit. Click the **Refresh** button to retrieve log entries again. Click the **Clear Log** button to clear the log. Select **50**, **100**, or **all** to show the corresponding number of events in the log.

21.8.2 AP Event Log (Available on Peplink Balance 380+)

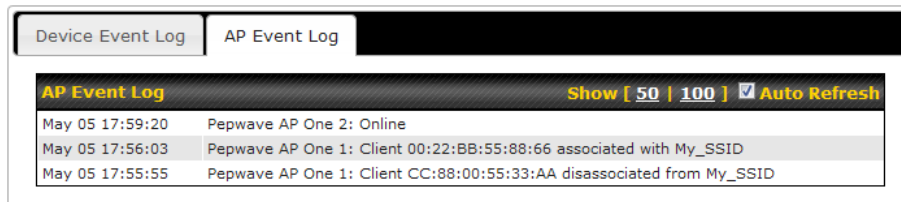

The screenshot shows the 'AP Event Log' interface. At the top, there are two tabs: 'Device Event Log' and 'AP Event Log' (selected). Below the tabs is a header bar with 'AP Event Log' on the left, 'Show [50 | 100]' in the center, and a checked checkbox for 'Auto Refresh' on the right. The main area contains a table of event entries.

| Time | Event Description |
|-----------------|---|
| May 05 17:59:20 | Pepwave AP One 2: Online |
| May 05 17:56:03 | Pepwave AP One 1: Client 00:22:BB:55:88:66 associated with My_SSID |
| May 05 17:55:55 | Pepwave AP One 1: Client CC:88:00:55:33:AA disassociated from My_SSID |

This section displays a list of events that has taken place on the connected / detected Pepwave AP devices. Select **50** or **100** to show the corresponding number of events in the log. Check the box next to **Auto Refresh** and the log will be refreshed automatically.

21.9 Bandwidth

This section shows the bandwidth usage statistics, located at: **Status > Bandwidth**.

Bandwidth usage at the LAN and when the device is switched off, e.g. LAN Bypass, are not recorded and not shown.

21.9.1 Real-Time

The **Data Transferred since installation** shows you how many network traffic has been processed by your device since first boot.

Click **Show Details** in the top right hand corner of each table and the details of data transferred will be shown.

The check box **Stacked** below the data transferred graph can be checked to show the aggregated transferred rate of both traffic direction.

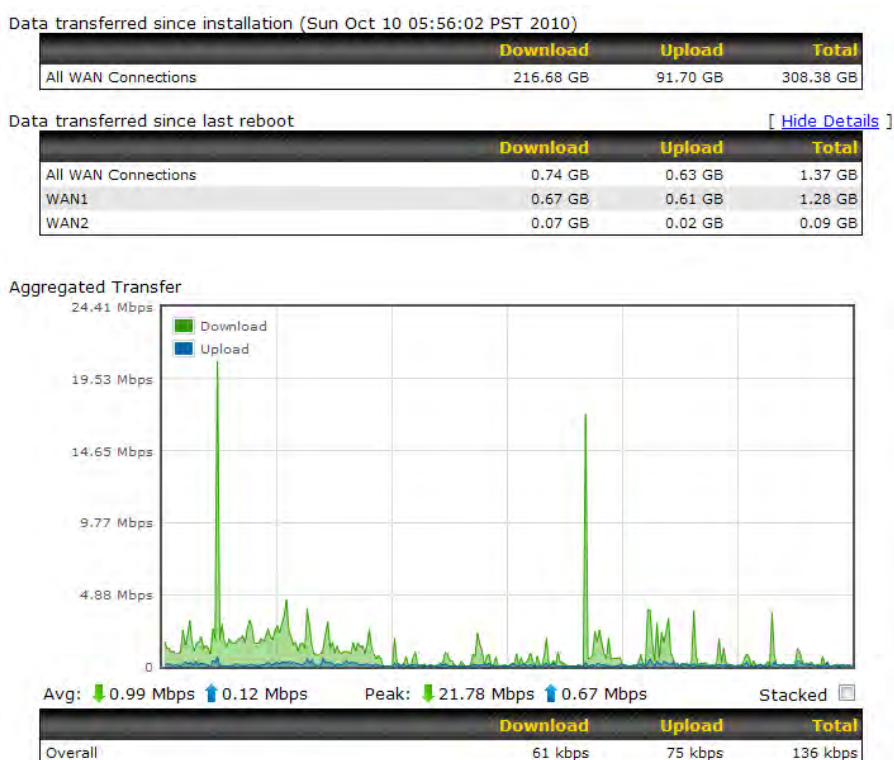

21.9.2 Daily

This page shows the daily bandwidth usage for all and each WAN connection.

Select the connection in which you want to check its usage from the drop down menu. If you have enabled **Bandwidth Monitoring** feature as shown in section 11.4, the **Current Billing Cycle** table for that WAN connection will be displayed.

Click on a date to view the client bandwidth usage of that specific date. This feature is not available if you have selected to view the bandwidth usage of only a particular WAN connection.

The Scale of the graph can be set to show in **Megabyte (MB)** or **Gigabyte (GB)**.

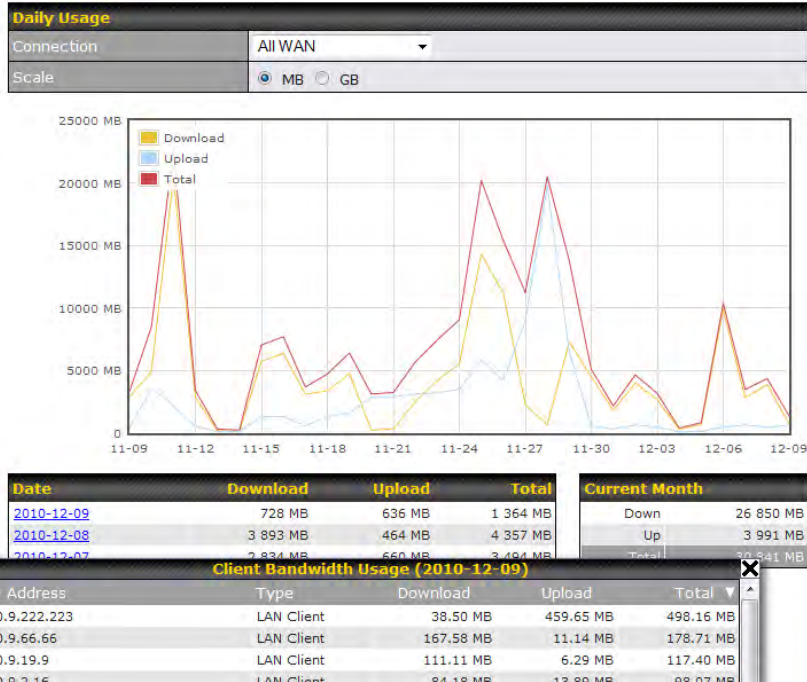

All WAN Daily Bandwidth Usage

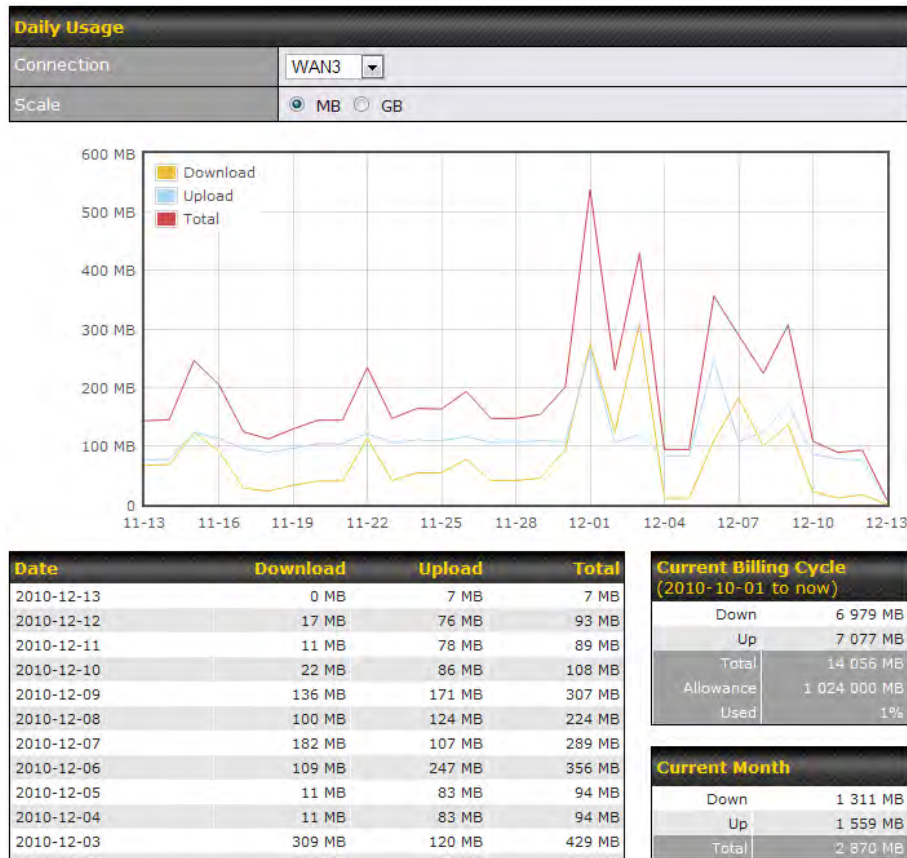

WAN3 Daily Bandwidth Usage

21.9.3 Monthly

This page shows the monthly bandwidth usage for each WAN connection.

If you have enabled **Bandwidth Monitoring** feature as shown in section 11.4, a particular connection can be chosen to check its usage and select to show the monthly usage period in **Billing Cycle** or **Calendar Month**.

Click the first two rows to view the client bandwidth usage of the most recent two months. This feature is not available if you have chosen to view the bandwidth usage of only a particular WAN connection.

The Scale of the graph can be set to show in **Megabyte (MB)** or **Gigabyte (GB)**.

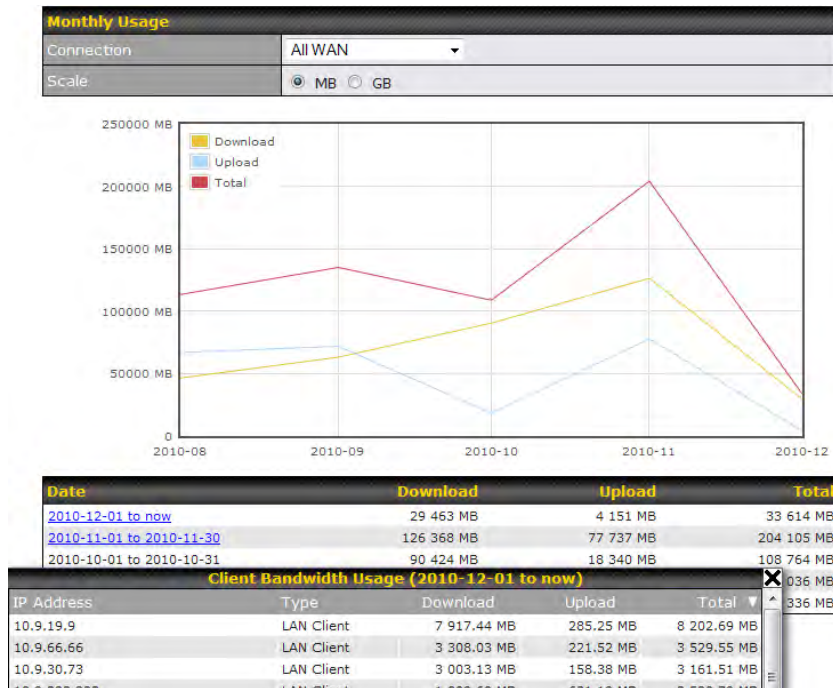

All WAN Monthly Bandwidth Usage

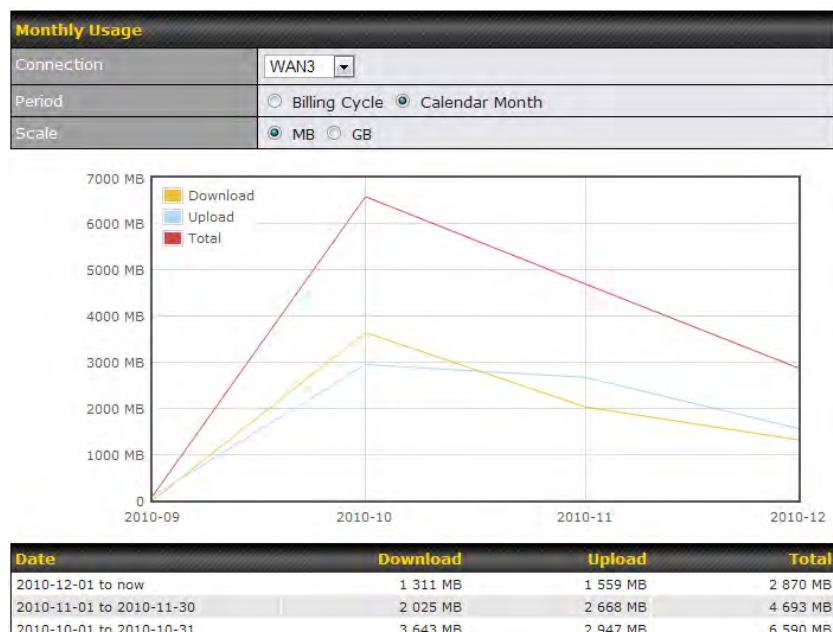

WAN3 Monthly Bandwidth Usage

Appendix A. Restoration of Factory Defaults

To restore the factory default settings on a Peplink Balance unit, perform the following:

For Balance 20/30/210/310:

1. Locate the reset button on the Peplink Balance unit.
2. With a paper clip, press and keep the reset button pressed for at least 10 seconds, until the unit reboots itself.

For Balance 380/580/710/1350:

- Use the buttons on front panel to control the LCD menu to go to **Maintenance > Factory Default**, and then choose **Yes** to confirm.

Afterwards, the factory default settings will be restored.

Important Note

All user settings will be lost after restoring the factory default settings.
Regular backup of configuration parameters is strongly recommended.

Appendix B. Routing under DHCP, Static IP, and PPPoE

The information in this appendix applies only to situations where Peplink Balance operates with to a WAN connection under DHCP, Static IP, and PPPoE.

For information that applies to GRE, please refer to:

- Section 11.1.4.1, **Routing under GRE via Network Address Translation (NAT)**
- Section 11.1.4.2, **Routing under GRE via IP Forwarding**

B.1 Routing via Network Address Translation (NAT)

When Peplink Balance is operating under NAT mode, the source IP addresses of outgoing IP packets are translated to the WAN IP address of Peplink Balance. Therefore, with NAT, all LAN devices share the same WAN IP address to access the Internet (i.e. the WAN IP address of Peplink Balance).

Operating Peplink Balance in NAT mode requires only one WAN (Internet) IP address. In addition, operating in NAT mode also has security advantages because LAN devices are hidden behind Peplink Balance, not directly accessible from the Internet, and, hence, less vulnerable to attacks.

The following figure shows the packet flow in NAT mode:

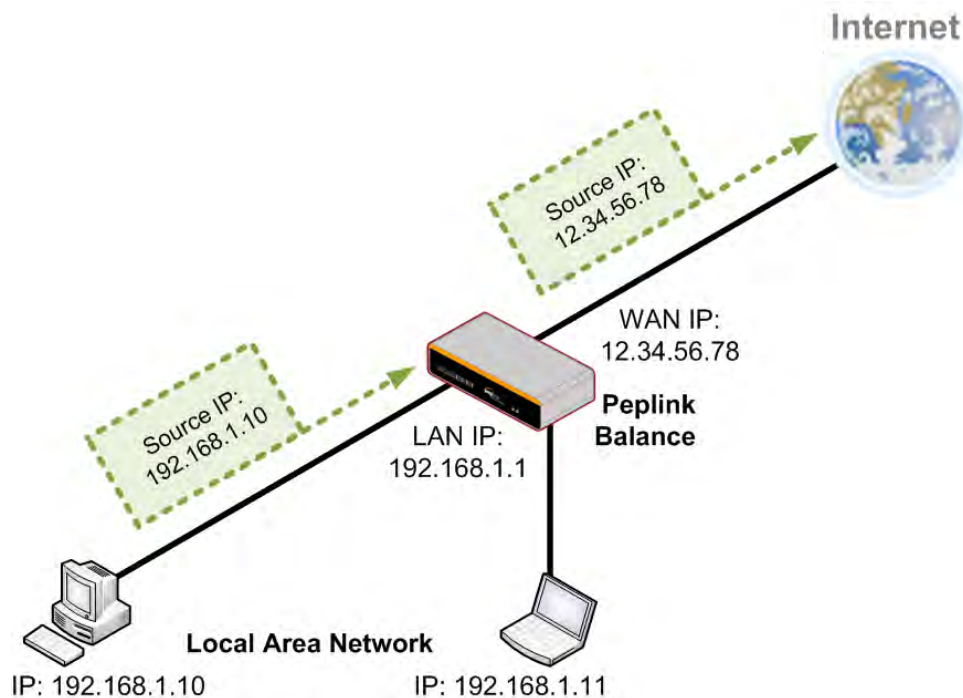

B.2 Routing via IP Forwarding

When Peplink Balance is operating under IP Forwarding mode, the IP addresses of IP packets are unchanged; Peplink Balance forwards both inbound and outbound IP packets without changing their IP addresses.

The following figure shows the packet flow in IP Forwarding mode:

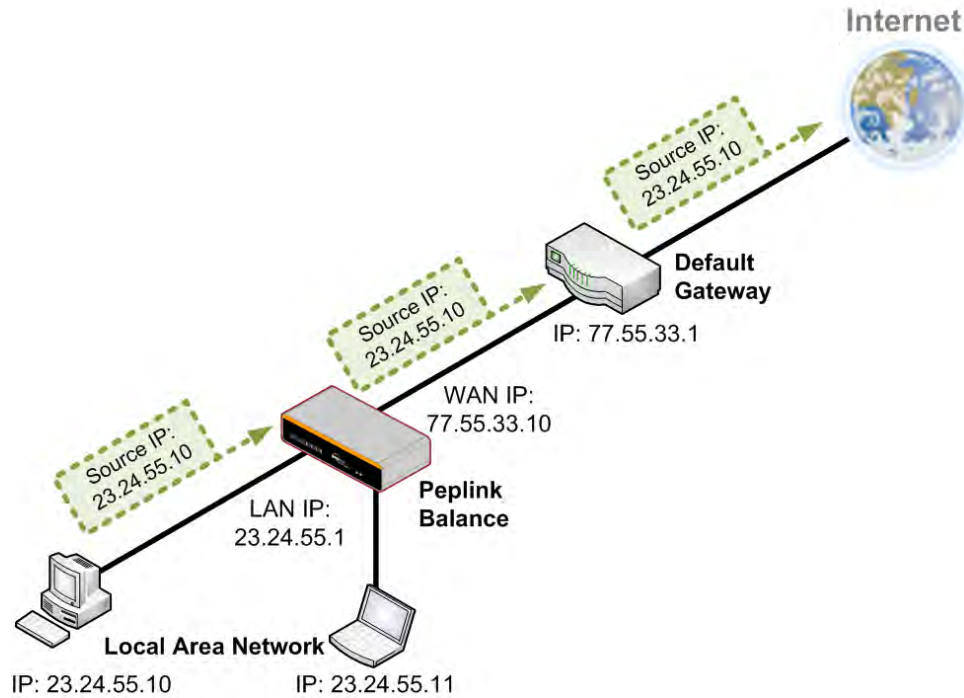

Appendix C. Case Studies

C.1 Performance Optimization

C.1.1 Scenario

In this scenario, email and web browsing are the two main Internet services used by the LAN users. The mail server is external to the network.

The connections are ADSL (with slow uplink and fast downlink) and Metro Ethernet (symmetric).

C.1.2 Solution

The solution is to individually set the WAN loading balance according to the service.

- Web browsing mainly downloads data; sending e-mails mainly consumes upload bandwidth.
- Both connections offer good download speeds; WAN2 offers good upload speeds.
- Define WAN1 and WAN2's inbound and outbound bandwidths to be 3M/512k and 4M/4M respectively.
- For HTTP, set the weight to 3 : 4.
- For SMTP, set the weight to 1 : 8, such that users will have a greater chance to be routed via WAN2 when sending e-mail.

C.1.3 Settings

1. Add a new outbound traffic rule for HTTP.
2. Add a new outbound traffic rule for SMTP.

In general, to add a new outbound traffic rule:

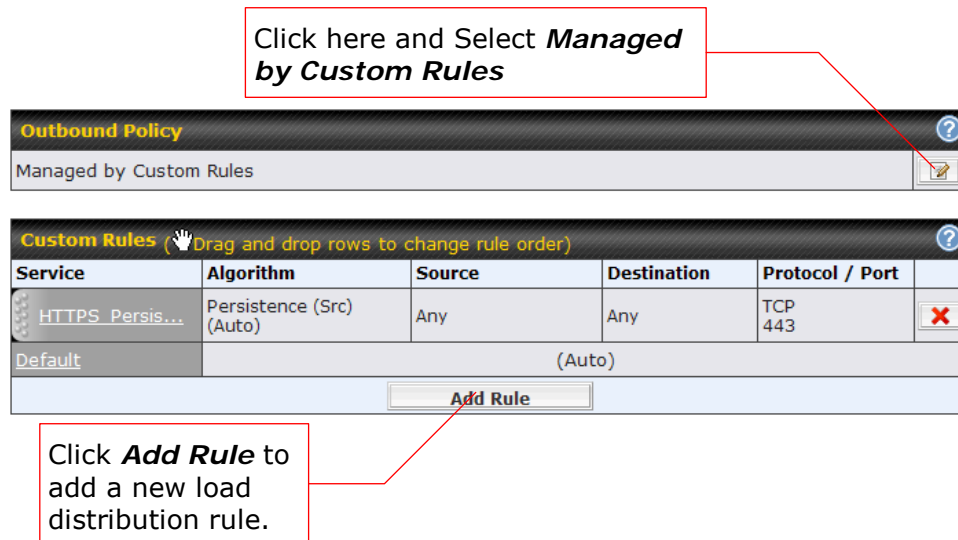

Click here and Select **Managed by Custom Rules**

| Service | Algorithm | Source | Destination | Protocol / Port | |
|-----------------|--------------------------|--------|-------------|-----------------|---|
| HTTPS Persis... | Persistence (Src) (Auto) | Any | Any | TCP 443 | X |
| Default | | | (Auto) | | |

Click **Add Rule** to add a new load distribution rule.

Settings for HTTP:

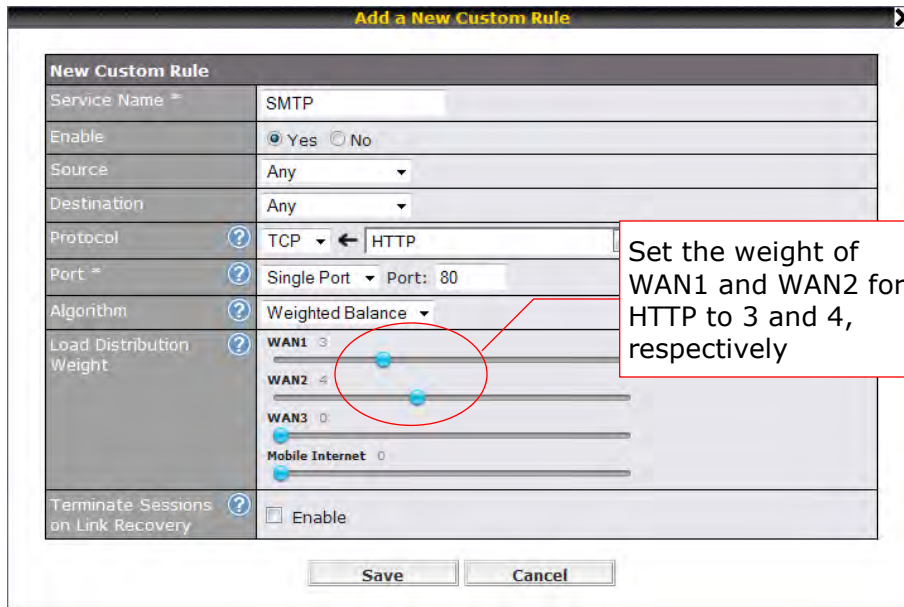

Add a New Custom Rule

| New Custom Rule | |
|-------------------------------------|---|
| Service Name | SMTP |
| Enable | <input checked="" type="radio"/> Yes <input type="radio"/> No |
| Source | Any |
| Destination | Any |
| Protocol | TCP ← HTTP |
| Port | Single Port Port: 80 |
| Algorithm | Weighted Balance |
| Load Distribution Weight | WAN1 3 WAN2 4 WAN3 0 Mobile Internet 0 |
| Terminate Sessions on Link Recovery | <input type="checkbox"/> Enable |

Save Cancel

Settings for SMTP:

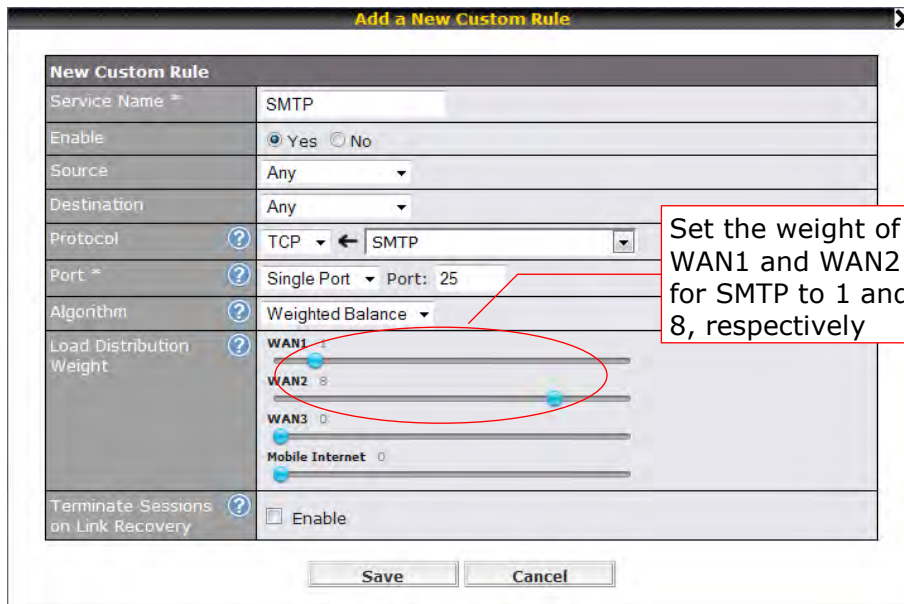

Add a New Custom Rule

| New Custom Rule | |
|-------------------------------------|---|
| Service Name | SMTP |
| Enable | <input checked="" type="radio"/> Yes <input type="radio"/> No |
| Source | Any |
| Destination | Any |
| Protocol | TCP ← SMTP |
| Port | Single Port Port: 25 |
| Algorithm | Weighted Balance |
| Load Distribution Weight | WAN1 1 WAN2 8 WAN3 0 Mobile Internet 0 |
| Terminate Sessions on Link Recovery | <input type="checkbox"/> Enable |

Save Cancel

C.2 Maintaining the Same IP Address throughout a Session

C.2.1 Scenario

Some client IP address sensitive web sites (for example, Internet banking) use both client IP address and cookies matching for session identification. Since different IP addresses are used during the load balancing, the session is dropped when a mismatching IP is detected.

C.2.2 Solution

Make use of the Persistency functionality of Peplink Balance.

With Persistence is configured and the option **By Destination** is selected, Peplink Balance uses a consistent WAN connection for source-destination pairs of IP addresses, and prevents sessions from being dropped.

With Persistence is configured and the option **By Source** is selected, Peplink Balance uses a consistent WAN connection for same source IP addresses. This option offers even higher application compatibility but the outbound traffic load will be distributed more evenly only if more users use the Internet.

C.2.3 Settings

Set persistence in:

Network > Outbound Policy > Managed by Custom Rules

Click **Add Rule**, select **HTTP** (TCP port 80) for web service, and select **Persistence**.

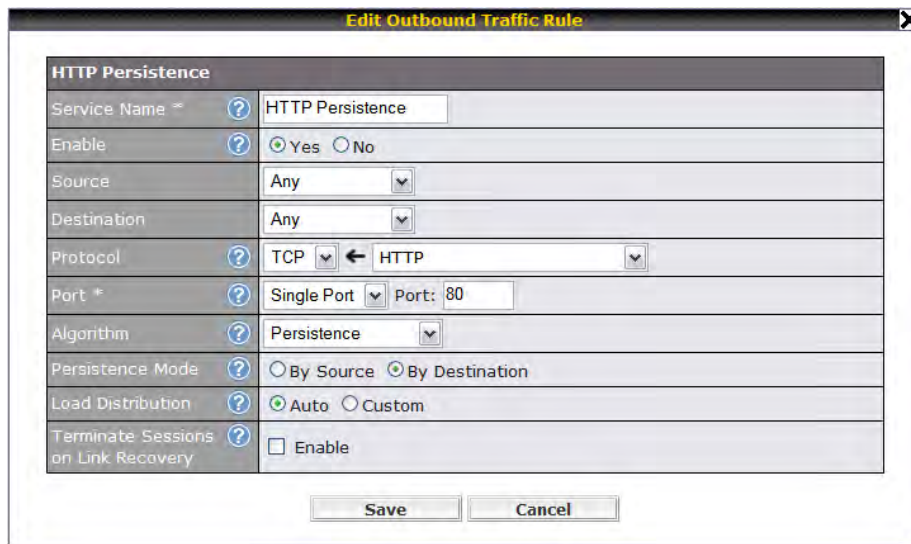

The screenshot shows a dialog box titled "Edit Outbound Traffic Rule" with a close button (X) in the top right corner. The dialog contains the following settings:

| HTTP Persistence | |
|-------------------------------------|---|
| Service Name | HTTP Persistence |
| Enable | <input checked="" type="radio"/> Yes <input type="radio"/> No |
| Source | Any |
| Destination | Any |
| Protocol | TCP ← HTTP |
| Port * | Single Port Port: 80 |
| Algorithm | Persistence |
| Persistence Mode | <input type="radio"/> By Source <input checked="" type="radio"/> By Destination |
| Load Distribution | <input checked="" type="radio"/> Auto <input type="radio"/> Custom |
| Terminate Sessions on Link Recovery | <input type="checkbox"/> Enable |

At the bottom of the dialog are "Save" and "Cancel" buttons.

Tip

A network administrator can use the Traceroute utility to manually analyze the connection path of a particular WAN connection.

C.3 Bypassing the Firewall to Access Hosts on LAN

C.3.1 Scenario

There are times when remote access to computers on the LAN is desirable; for example, when hosting web sites, online businesses and FTP download and upload areas, etc.

In such cases, it may be appropriate to create an inbound NAT mapping for the network to allow some hosts on the LAN to be accessible from outside of the firewall.

C.3.2 Solution

Web Admin Interface can be used for adding an inbound NAT mapping to a host and to bind the host to the WAN connections, via **Network > NAT Mappings > Add NAT Rule**

For example, the following settings add the host, with IP address 192.168.1.102, to an Inbound Mapping and bind the host to the default IP and 211.123.123.100 of WAN1:

| LAN Client(s) | ? | IP Address ▾ | | | | | | | | | | | | |
|--|--|--|-------------------------------------|--|--|--|------|--|-------------------------------|----------------|-------------------------------|----------------|--|--|
| Address | ? | 192.168.1.102 | | | | | | | | | | | | |
| Inbound Mappings | ? | <table border="1"> <tr> <th colspan="2">Connection / Inbound IP Address(es)</th> </tr> <tr> <td><input checked="" type="checkbox"/> WAN1</td> <td><input checked="" type="checkbox"/> 211.123.123.100 (Interface IP)</td> </tr> <tr> <td></td> <td><input type="checkbox"/> 211.123.123.101</td> </tr> <tr> <td><input type="checkbox"/> WAN2</td> <td></td> </tr> <tr> <td><input type="checkbox"/> WAN3</td> <td></td> </tr> <tr> <td><input type="checkbox"/> Mobile Internet</td> <td></td> </tr> </table> | Connection / Inbound IP Address(es) | | <input checked="" type="checkbox"/> WAN1 | <input checked="" type="checkbox"/> 211.123.123.100 (Interface IP) | | <input type="checkbox"/> 211.123.123.101 | <input type="checkbox"/> WAN2 | | <input type="checkbox"/> WAN3 | | <input type="checkbox"/> Mobile Internet | |
| Connection / Inbound IP Address(es) | | | | | | | | | | | | | | |
| <input checked="" type="checkbox"/> WAN1 | <input checked="" type="checkbox"/> 211.123.123.100 (Interface IP) | | | | | | | | | | | | | |
| | <input type="checkbox"/> 211.123.123.101 | | | | | | | | | | | | | |
| <input type="checkbox"/> WAN2 | | | | | | | | | | | | | | |
| <input type="checkbox"/> WAN3 | | | | | | | | | | | | | | |
| <input type="checkbox"/> Mobile Internet | | | | | | | | | | | | | | |
| Outbound Mappings | ? | <table border="1"> <tr> <th colspan="2">Connection / Outbound IP Address</th> </tr> <tr> <td>WAN1</td> <td>211.123.123.100 (Interface IP) ▾</td> </tr> <tr> <td>WAN2</td> <td>Interface IP ▾</td> </tr> <tr> <td>WAN3</td> <td>Interface IP ▾</td> </tr> <tr> <td>Mobile Internet</td> <td>Interface IP ▾</td> </tr> </table> | Connection / Outbound IP Address | | WAN1 | 211.123.123.100 (Interface IP) ▾ | WAN2 | Interface IP ▾ | WAN3 | Interface IP ▾ | Mobile Internet | Interface IP ▾ | | |
| Connection / Outbound IP Address | | | | | | | | | | | | | | |
| WAN1 | 211.123.123.100 (Interface IP) ▾ | | | | | | | | | | | | | |
| WAN2 | Interface IP ▾ | | | | | | | | | | | | | |
| WAN3 | Interface IP ▾ | | | | | | | | | | | | | |
| Mobile Internet | Interface IP ▾ | | | | | | | | | | | | | |

C.4 Inbound Access Restriction

C.4.1 Scenario

A firewall is required in order to protect the network from potential hacker attacks and other Internet security threats.

C.4.2 Solution

Firewall functionality is built into Peplink Balance. By default, inbound access is unrestricted.

Enabling a basic level of protection involves setting up firewall rules.

For example, to set up a firewall rule between the Internet and the private network that monitors Web access from Internet, click the **Add Rule** button in the **Inbound Firewall Rules** table, and then change the settings according to the following screenshot:

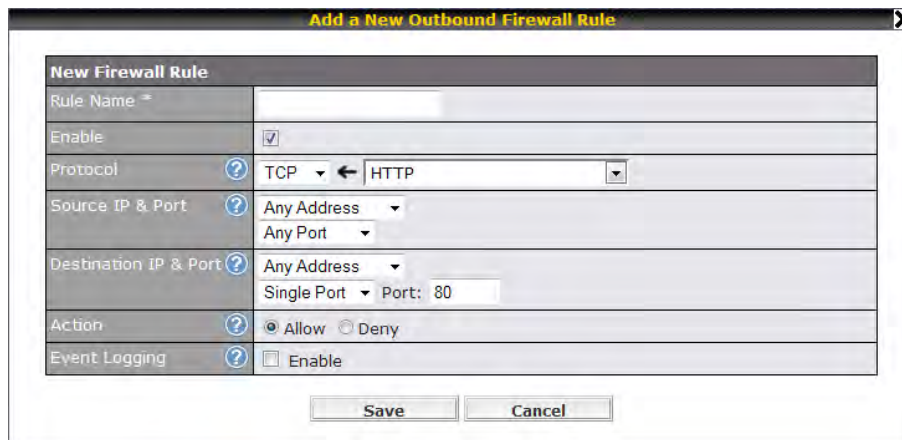

| New Firewall Rule | |
|-----------------------|---|
| Rule Name * | |
| Enable | <input checked="" type="checkbox"/> |
| Protocol | TCP ← HTTP |
| Source IP & Port | Any Address Any Port |
| Destination IP & Port | Any Address Single Port Port: 80 |
| Action | <input checked="" type="radio"/> Allow <input type="radio"/> Deny |
| Event Logging | <input type="checkbox"/> Enable |

Save Cancel

After the fields have been entered as in the screenshot, click **Save** to add the rule.

Then change the default inbound rule to **Deny** by clicking the **default** rule in the **Inbound Firewall Rules** table.

C.5 Outbound Access Restriction

C.5.1 Scenario

For security reasons, it may be appropriate to disallow LAN users to use ftp to transfer files to and from the Internet, or otherwise restrict outbound access.

This can easily be achieved by setting up an outbound firewall rule with Peplink Balance.

C.5.2 Solution

To set up a firewall between Internet and private network for outbound access, click the **Add Rule** button in the **Outbound Firewall Rules** table, and then make the settings according the following screenshot:

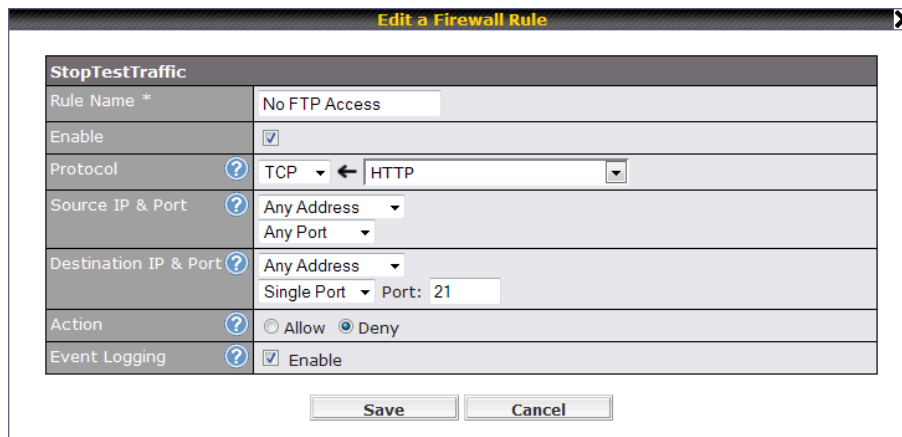

| StopTestTraffic | |
|-----------------------|---|
| Rule Name * | No FTP Access |
| Enable | <input checked="" type="checkbox"/> |
| Protocol | TCP ← HTTP |
| Source IP & Port | Any Address Any Port |
| Destination IP & Port | Any Address Single Port Port: 21 |
| Action | <input type="radio"/> Allow <input checked="" type="radio"/> Deny |
| Event Logging | <input checked="" type="checkbox"/> Enable |

Save Cancel

After the fields have been entered as in the screenshot, click **Save** to add the rule.

Appendix D. Troubleshooting

Problem 1

Outbound load is only distributed over one WAN connection.

Solution

Outbound load can only be distributed evenly to the WAN connection if many outbound connections are made. If there is only one user on the LAN and only one download session is made from his/her browser, the WAN connections cannot be fully utilized.

For a single user, download manager applications are recommended. The applications can split a file into pieces and download the pieces simultaneously. For example: FlashGet (Windows), GetRight (Windows), iGetter (MAC), etc.

If the outbound traffic is going across the Site-to-Site VPN tunnel, i.e. transferring a file to a VPN peer, all WAN connections will be bonded by our Site-to-Site VPN technology. In this case, all bandwidth will be utilized and a file will be transferred across all available WAN connections.

For details, please refer to this FAQ: <http://www.peplink.com/index.php?view=faq&id=111&path=19>

Problem 2

I am using a download manager program (e.g. FlashGet, Download Accelerator Plus, DownThemAll etc.) now. Why is the download speed still in single link's speed?

Solution

First, check whether the WAN connections are up.

Second, ensure your download manager application has split the file into 3 parts or more.

It is also possible that all of 2 or even 3 download sessions were being distributed to the same link by chance.

Problem 3

I am using some websites to lookup my public IP address, e.g. www.whatismyip.com. When I keep pressing the browser's Refresh button, the server almost always returns the same address. The IP address supposed to be changing for every refresh

Solution

The web server has enabled the **Keep Alive** function such that you were using the same TCP session to query the server.

Try to test with a web site that does not enable **Keep Alive**.

For example, try <http://private.dnsstuff.com/tools/aboutyou.ch> (This third-party web site is provided only for reference. Peplink has no association with the site and does not guarantee the site's validity or availability.)

Problem 4

What can I do if I suspect a problem on my LAN connection?

Solution

You can test the LAN connection using **Ping**.

For example, if you are using DOS/Windows, at the Command Prompt, type:

```
ping 192.168.1.1
```

This pings the Peplink Balance device (provided that Peplink Balance device's IP is 192.168.1.1) to test whether the connection to Peplink Balance is OK.

Problem 5

What can I do if I suspect a problem on my Internet/WAN connection?

Solution

You can test the WAN connection by **Ping**, which is similar to problem 4.

As we want to isolate the problems from the LAN, **Ping** will be performed from Peplink Balance. By using the **Ping/Traceroute** under the tab **Status** of the Peplink Balance, you may able to find out the source of problem.

Problem 6

When I upload files to a server via ftp, the transfer stalls after a few kilobytes of data are sent. What should I do?

Solution

The Maximum Transmission Unit (MTU) or MSS setting may need to be adjusted.

By default, the MTU is set at 1440. Choose **Auto** for all of your WAN connections. If it does not solve, you may try the MTU 1492 if a connection is a DSL. If problem still persists, change the size to smaller values until your problem is resolved (e.g. 1462, 1440, 1420, 1400, etc).

Appendix E. Product Specifications

E.1 Peplink Balance 20 and 30

Routing

- Flexible Custom Outbound Routing Policy

WAN Support

- DHCP, PPPoE, GRE, and Static IP
- Outbound Link Load Balance

Device Management

- Wizard & Menu Driven Web Management Interface over HTTP / HTTPS
- Remote Reporting and Management
- Configurations Upload and Download

Internet Access Sharing

- SUA (Single User Account) / Multi-to-Multi NAT
- NAT supports PAT (Port Address Translation)

Security

- Compatible with IPsec and PPTP VPN Passthrough
- Rules-based Stateful Firewall, with IP, Protocol, and Port filtering
- Intrusion Detection System

Physical Interface

- Two (Balance 20) / Three (Balance 30) RJ-45 for an IEEE 802.3u 10/100M WAN
- Four RJ-45 for an IEEE 802.3u 10/100M LAN

Power Specification

- AV Input 100-240V, DC Output 12V

Operating Environment

- Kensington Lock Interface
- Temperature: 0°C - 50°C
- Humidity: 10% - 90% (non-condensing)

E.2 Peplink Balance 210 and 310

Routing

- Drop-in Mode and NAT
- Flexible Custom Outbound Routing Policy

WAN Support

- DHCP, PPPoE, GRE, and Static IP
- Inbound and Outbound Link Load Balance

Device Management

- Wizard & Menu Driven Web Management Interface over HTTP / HTTPS
- Remote Reporting and Management
- Bandwidth Usage Monitor
- Configurations Upload and Download

Internet Access Sharing

- SUA (Single User Account) / Multi-to-Multi NAT
- NAT supports PAT (Port Address Translation)

Security

- PPTP VPN Server
- Rules-based Stateful Firewall, with IP, Protocol, and Port filtering
- VPN Encryption: 256-bit AES
- Intrusion Detection System

Physical Interface (Balance 210)

- Two RJ-45 for an IEEE 802.3u 10/100M WAN
- Four RJ-45 for an IEEE 802.3u 10/100M LAN
- RS-232 Console / Serial (modem / TA) Port

Physical Interface (Balance 310)

- Three RJ-45 for an IEEE 802.3u 10/100M WAN
- Four RJ-45 for an IEEE 802.3u 10/100M LAN
- RS-232 Console / Serial (modem / TA) Port

Power Specification

- AV Input 100-240V, DC Output 9-30V

Operating Environment

- Temperature: 0°C - 50°C
- Humidity: 10% - 90% (non-condensing)

E.3 Peplink Balance 380

Routing

- Drop-in Mode and NAT
- Flexible Custom Outbound Routing Policy

WAN Support

- DHCP, PPPoE, GRE, and Static IP
- Inbound and Outbound Link Load Balance

Device Management

- Wizard & Menu Driven Web Management Interface over HTTP / HTTPS
- Remote Reporting and Management
- Bandwidth Usage Monitor
- Configurations Upload and Download

Internet Access Sharing

- SUA (Single User Account) / Multi-to-Multi NAT
- NAT supports PAT (Port Address Translation)

Security

- PPTP VPN Server
- Rules-based Stateful Firewall, with IP, Protocol, and Port filtering
- VPN Encryption: 256-bit AES
- Intrusion Detection System

Physical Interface (Balance 380)

- Three RJ-45 for an IEEE 802.3u 10/100M WAN
- One RJ-45 for an IEEE 802.3u 10/100M LAN
- RS-232 Console / Serial (modem / TA) Port

Physical Interface (Balance 380 Hardware version 3, 4)

- Three RJ-45 for an IEEE 802.3ab 10/100M/1000M WAN
- One RJ-45 for an IEEE 802.3ab 10/100M/1000M LAN
- RS-232 Console / Serial (modem / TA) Port

Physical Interface (Balance 380 Hardware version 5)

- Three RJ-45 for an IEEE 802.3ab 10/100M/1000M WAN
- One RJ-45 for an IEEE 802.3ab 10/100M/1000M LAN
- One RJ-45 Console / Serial (modem / TA) Port

Power Specification

- AC input 110/220V

Operating Environment

- Temperature: 0°C - 40°C
- Humidity: 10% - 90% (non-condensing)

E.4 Peplink Balance 580

Routing

- Drop-in Mode and NAT
- Flexible Custom Outbound Routing Policy

WAN Support

- DHCP, PPPoE, GRE, and Static IP
- Inbound and Outbound Link Load Balance

Device Management

- Wizard & Menu Driven Web Management Interface over HTTP / HTTPS
- Remote Reporting and Management
- Bandwidth Usage Monitor
- Configurations Upload and Download

Internet Access Sharing

- SUA (Single User Account) / Multi-to-Multi NAT
- NAT supports PAT (Port Address Translation)

Security

- PPTP VPN Server
- Rules-based Stateful Firewall, with IP, Protocol, and Port filtering
- VPN Encryption: 256-bit AES
- Intrusion Detection System

Physical Interface

- Five RJ-45 for an IEEE 802.3ab 10/100M/1000M WAN
- One RJ-45 for an IEEE 802.3ab 10/100M/1000M LAN
- One RJ-45 Console / Serial (modem / TA) Port
- LAN Bypass from WAN5 to LAN

Power Specification

- AC input 110/220V

Operating Environment

- Temperature: 0°C - 40°C
- Humidity: 10% - 90% (non-condensing)

E.5 Peplink Balance 710

Routing

- Drop-in Mode and NAT
- Flexible Custom Outbound Routing Policy

WAN Support

- DHCP, PPPoE, GRE, and Static IP
- Inbound and Outbound Link Load Balance

Device Management

- Wizard & Menu Driven Web Management Interface over HTTP / HTTPS
- Remote Reporting and Management
- Bandwidth Usage Monitor
- Configurations Upload and Download

Internet Access Sharing

- SUA (Single User Account) / Multi-to-Multi NAT
- NAT supports PAT (Port Address Translation)

Security

- PPTP VPN Server
- Rules-based Stateful Firewall, with IP, Protocol, and Port filtering
- VPN Encryption: 256-bit AES
- Intrusion Detection System

Physical Interface

- Four RJ-45 for an IEEE 802.3u 10/100M WAN
- Three RJ-45 for an IEEE 802.3ab 10/100/1000M WAN
- One RJ-45 for an IEEE 802.3ab 10/100/1000M LAN
- RS-232 Console / Serial (modem / TA) Port

Power Specification

- AC input 110/220V

Operating Environment

- Temperature: 0°C - 40°C
- Humidity: 10% - 90% (non-condensing)

E.6 Peplink Balance 1350

Routing

- Drop-in Mode and NAT
- Flexible Custom Outbound Routing Policy

WAN Support

- DHCP, PPPoE, GRE, and Static IP
- Inbound and Outbound Link Load Balance

Device Management

- Wizard & Menu Driven Web Management Interface over HTTP / HTTPS
- Remote Reporting and Management
- Bandwidth Usage Monitor
- Configurations Upload and Download

Internet Access Sharing

- SUA (Single User Account) / Multi-to-Multi NAT
- NAT supports PAT (Port Address Translation)

Security

- PPTP VPN Server
- Rules-based Stateful Firewall, with IP, Protocol, and Port filtering
- VPN Encryption: 256-bit AES
- Intrusion Detection System

Physical Interface

- Thirteen RJ-45 for an IEEE 802.3ab 10/100/1000M WAN
- One RJ-45 for an IEEE 802.3ab 10/100/1000M LAN
- One RJ-45 Console / Serial (modem / TA) Port
- LAN Bypass from WAN1 to LAN

Power Specification

- AC input 110/220V

Operating Environment

- Temperature: 0°C - 40°C
- Humidity: 10% - 90% (non-condensing)



What are we doing at the moment?
Follow us on [Twitter!](#)
<http://twitter.com/Peplink>



Want to know more about us?
Add us on [Facebook!](#)
<http://www.facebook.com/peplink>



Difficulties when configuring the device?
Visit our [YouTube Channel!](#)
<http://www.youtube.com/PeplinkChannel>



Anything want to share with everyone?
Discuss on [Peplink Forum!](#)
<http://forum.peplink.com>

Contact Us:

Sales

<http://www.peplink.com/contact/sales/>

Support

<http://www.peplink.com/contact/>

Business Development and Partnerships

<http://www.peplink.com/partners/channel-partner-program/>

Contact Address:

United States Office

800 West El Camino Real,
Mountain View
CA 94040
United States
Tel: +1 (650) 450 9668
Fax: +1 (866) 625 4664

Hong Kong Office

17/F, Park Building,
476 Castle Peak Road
Cheung Sha Wan
Hong Kong
Tel: +852 2990 7600
Fax: +852 3007 0588

Italy Office

Via Sismondi 50/3
20133 Milan
Italy
Tel: +39 02 8986 6852

Saudi Arabia Office

3/F, Saudi Business Center,
Jeddah,
Saudi Arabia
Tel: +39 02 8986 6852

South Africa Office

Unit 24, Cambridge Office
Park, 5 Bauhinia Street,
Highveld, Centurion,
South Africa
Tel: +27 12 665 5829