



PCT2265
Touch LED LCD Monitor

USER'S GUIDE

www.planar.com

The information contained in this document is subject to change without notice. This document contains proprietary information that is protected by copyright. All rights are reserved. No part of this document may be reproduced, translated to another language or stored in a retrieval system, or transmitted by any means, electronic, mechanical, photocopying, recording, or otherwise, without prior written permission. Windows is a registered trademark of Microsoft Inc. Other brand or product names are trademarks of their respective holders.

| TABLE OF CONTENTS

FOR YOUR SAFETY	3
PRECAUTIONS	4
SPECIAL NOTES ON LCD MONITORS	6
BEFORE YOU OPERATE THE MONITOR	6
FEATURES	6
PACKAGE LIST	7
ADJUSTING THE HEIGHT	8
CONTROLS AND CONNECTORS	9
ADJUSTING THE VIEWING ANGLE	10
OPERATING INSTRUCTIONS	11
GENERAL INSTRUCTIONS	11
FRONT PANEL CONTROL	12
HOW TO ADJUST A SETTING	13
ADJUSTING THE PICTURE	14
PLUG AND PLAY	16
CALIBRATION/RESET INSTRUCTIONS	17
TECHNICAL SUPPORT (FAQ)	18
TECHNICAL SUPPORT (FAQ)	19
ERROR MESSAGE & POSSIBLE SOLUTION	19
APPENDIX	20
SPECIFICATIONS	20
FACTORY PRESET TIMING TABLE	21
CONNECTOR PIN ASSIGNMENT	22
WALL MOUNTING (OPTIONAL)	24
PLANAR SUPPORT	25

| FOR YOUR SAFETY

Before operating the monitor, please read this manual thoroughly. This manual should be retained for future reference.

FCC Class B Radio Frequency Interference Statement

WARNING: (FOR FCC CERTIFIED MODELS)

NOTE: This equipment has been tested and found to comply with the limits for a Class B digital device, pursuant to Part 15 of the FCC Rules. These limits are designed to provide reasonable protection against harmful interference in a residential installation. This equipment generates, uses and can radiate radio frequency energy, and if not installed and used in accordance with the instructions, may cause harmful interference to radio communications. However, there is no guarantee that interference will not occur in a particular installation. If this equipment does cause harmful interference to radio or television reception, which can be determined by turning the equipment off and on, the user is encouraged to try to correct the interference by one or more of the following measures:

1. Reorient or relocate the receiving antenna.
2. Increase the separation between the equipment and receiver.
3. Connect the equipment into an outlet on a circuit different from that to which the receiver is connected.
4. Consult the dealer or an experienced radio/TV technician for help.

NOTICE:

1. The changes or modifications not expressly approved by the party responsible for compliance could void the user's authority to operate the equipment.
2. Shielded interface cables and AC power cord, if any, must be used in order to comply with the emission limits.
3. The manufacturer is not responsible for any radio or TV interference caused by unauthorized modification to this equipment. It is the responsibilities of the user to correct such interference.

WARNING:

To prevent fire or shock hazard, do not expose the monitor to rain or moisture. Dangerously high voltages are present inside the monitor. Do not open the cabinet. Refer servicing to qualified personnel only.

Disposal of waste equipment by user in private household in the European Union



This symbol on the product or on its packaging indicates that this product must not be disposed of with your other household waste. Instead, it is your responsibility to dispose of your waste equipment by handing it over to a designated collection point for the recycling of waste electrical and electronic equipment. The separate collection and recycling of your waste equipment at the time of disposal will help to conserve natural resources and ensure that it is recycled in a manner that protects human health and the environment. For more information about where you can drop off your waste equipment for recycling, please contact your local city office, your household waste disposal service or the shop where you purchased the product.

PRECAUTIONS

- Do not use the monitor near water, e.g. near a bathtub, washbowl, kitchen sink, laundry tub, swimming pool or in a wet basement.
- Do not place the monitor on an unstable cart, stand, or table. If the monitor falls, it can injure a person and cause serious damage to the appliance. Use only a cart or stand recommended by the manufacturer or sold with the monitor. If you mount the monitor on a wall or shelf, use a mounting kit approved by the manufacturer and follow the kit instructions.
- Slots and openings in the back and bottom of the cabinet are provided for ventilation. To ensure reliable operation of the monitor and to protect it from overheating, be sure these openings are not blocked or covered. Do not place the monitor on a bed, sofa, rug, or similar surface. Do not place the monitor near or over a radiator or heat register. Do not place the monitor in a bookcase or cabinet unless proper ventilation is provided.
- The monitor should be operated only from the type of power source indicated on the label. If you are not sure of the type of power supplied to your home, consult your dealer or local power company.
- The monitor is equipped with a three-pronged grounded plug, a plug with a third (grounding) pin. This plug will fit only into a grounded power outlet as a safety feature. If your outlet does not accommodate the three-wire plug, have an electrician install the correct outlet, or use an adapter to ground the appliance safely. Do not defeat the safety purpose of the grounded plug.

- Unplug the unit during a lightening storm or when it will not be used for long period of time. This will protect the monitor from damage due to power surges.
- Do not overload power strips and extension cords. Overloading can result in fire or electric shock.
- Never push any object into the slot on the monitor cabinet. It could short circuit parts causing a fire or electric shock. Never spill liquids on the monitor.
- Do not attempt to service the monitor by yourself; opening or removing covers can expose you to dangerous voltages and other hazards. Please refer all servicing to qualified service personnel.
- To ensure satisfactory operation, use the monitor only with UL listed computers which have appropriate configured receptacles marked between 100 - 240V AC, Min. 5A.
- The wall socket shall be installed near the equipment and shall be easily accessible.

SPECIAL NOTES ON LCD MONITORS

The following symptoms are normal with LCD monitor and do not indicate a problem.

NOTES

- Due to the nature of the fluorescent light, the screen may flicker during initial use. Turn off the Power Switch and then turn it on again to make sure the flicker disappears.
- You may find slightly uneven brightness on the screen depending on the desktop pattern you use.
- The LCD screen has effective pixels of 99.99% or more. It may include blemishes of 0.01% or less such as a missing pixel or a pixel lit all of the time.
- Due to the nature of the LCD screen, an after image of the previous screen may remain after switching the image, when the same image is displayed for hours. In this case, the screen is recovered slowly by changing the image or turning off the Power Switch for hours.
- When the screen becomes black or flashing, or cannot illuminate any more, contact your dealer or service center to replace parts. Don't repair the screen by yourself!

BEFORE YOU OPERATE THE MONITOR

FEATURES

- 21.5" (54.6 cm) Wide Screen TFT Color Monitor
- 16:9 Widescreen
- Crisp, Clear Display for Windows
- Recommended Resolutions: 1920*1080@60Hz
- LED backlit, energy efficient
- Ergonomic Design
- Space Saving, Compact Case Design
- USB 2.0 hub



Use extreme caution when unpacking your monitor as the deskstand is spring-loaded. Failure to follow the instructions below may lead to physical harm.

1. Lay the monitor flat on an even surface –display facing up
2. Remove Styrofoam
3. Remove the orange strap
4. Remove the bag

PACKAGE LIST

The product package should include the following items:

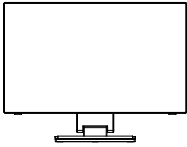

Monitor

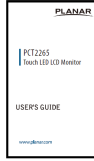

User's Guide

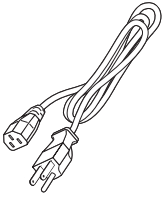

Power Cable

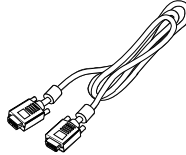

VGA Cable

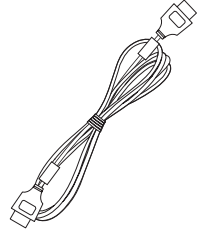

HDMI Cable

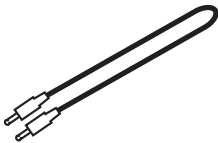

Audio Cable

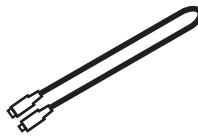

USB Cable

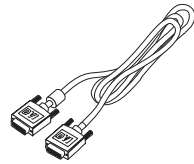

DVI Cable

ADJUSTING THE HEIGHT

The monitor's height may be adjusted from 4.8in to 15.2in (122mm to 385mm).

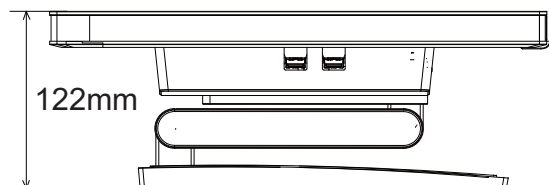

CONTROLS AND CONNECTORS

POWER CORD

Power Source:

1. Make sure that the power cord is the correct type required in your area.
2. This monitor has an internal universal power supply that allows operation in either 100/120V AC or 220/240V AC voltage area (No user adjustment is required.)
3. Connect the AC-power cord into the monitor's power input socket, The AC-power cord may be connected to either a wall power outlet or the power outlet socket on your PC, depending on the type of power cord supplied with your monitor.

SIGNAL CABLE

Connecting the Signal Cable : Plug one end of the signal cable to the LCD monitor and the other end to a computer or a video source.

USB Cable – A to B

The USB Cable – A to B – must be connected from the monitor to the computer for the touch screen to operate.

Connecting the USB Cable: Plug one end of the cable to the monitor – USB Cable (upstream) slot - and the other end to a USB port on the computer. Refer to page 17 for Calibration and Reset Instructions.

Caution: If the AC outlet is not grounded (with three holes), install the proper grounding adapter (not supplied).

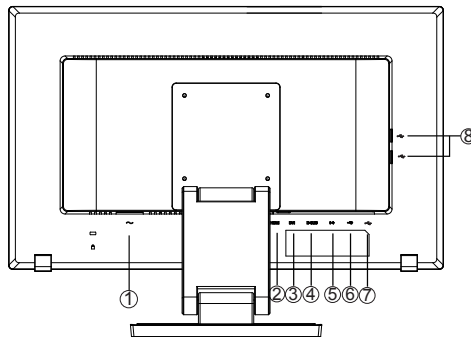

Figure 2 Connecting Cables

1.	Power Cable	5.	Audio cable
2.	HDMI Cable	6.	USB Cable*2 (downstream)
3.	DVI Cable	7.	USB Cable (upstream)
4.	D-SUB Cable	8.	USB Cable*2(downstream)

ADJUSTING THE VIEWING ANGLE

- For optimal viewing it is recommended to look at the full face of the monitor, then adjust the monitor's angle to your own preference.
- Hold the stand so you do not topple the monitor when you change the monitor's angle.
- You are able to adjust the monitor's angle from -5° to 90° .

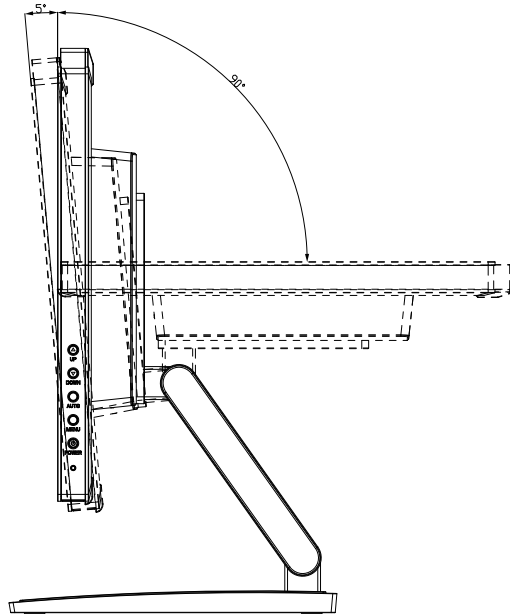

Figure 3

NOTES

- Do not touch the screen when you change the angle. It may cause damage or break the screen.
- Careful attention is required not to catch your fingers or hands when you change the angle.

OPERATING INSTRUCTIONS

GENERAL INSTRUCTIONS

Press the power button to turn the monitor on or off. The other control buttons are located at front panel of the monitor (See Figure 4). By changing these settings, the picture can be adjusted to your personal preferences.

- The power cord should be connected.
- Connect the video cable from the monitor to the video card.
- Press the power button to turn on the monitor. The power indicator will light up.

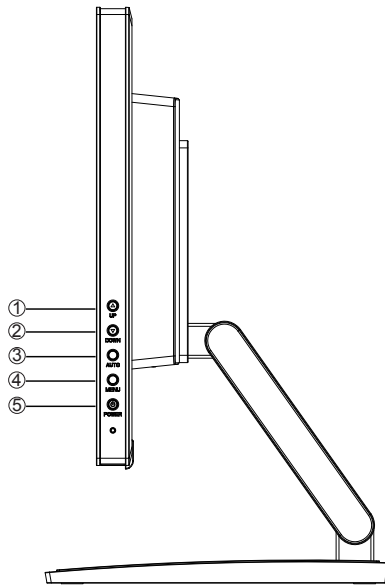

Figure 4 External Control Button

1.	UP
2.	DOWN
3.	AUTO
4.	Menu
5.	Power button

FRONT PANEL CONTROL

- **Power Button:**
Press this button to switch ON/OFF monitor's power.
- **Power Indicator:**
Blue — Power On mode.
Orange — Power saving mode.
- **MENU / ENTER :**
Activates OSD menu or function adjust confirm.
- **ECO/(-)**
Activates the ECO control when the OSD is OFF or navigate through adjustment icons when OSD is ON or adjust a function when function is activated.
- **Volume /+ :**
Activates the volume control when the OSD is OFF or navigate through adjustment icons when OSD is ON or adjust a function when function is activated.
- **Source / Auto Adjust / Exit**
When the OSD is OFF, pressing Auto/Source button will toggle between sources. Press continuously to select the input source indicated in the message bar. Press Menu/Enter button to change to the selected source. Auto configure hot key: (VGA input only) When the OSD is OFF, press and hold down the button for 2 seconds to auto configure. When OSD menu is ON, this button will act as a Exit Key (Exit OSD menu)

OSD Lock Function: Lock-All 4 buttons are locked except "POWER" button.

To lock the OSD, press and hold the MENU button while the monitor is off and then Press power button to turn the monitor on. To un-lock the OSD, press and hold the MENU button while the monitor is off and then press power button to turn the monitor on.

NOTES

- Do not install the monitor in a location near heat sources such as radiators or air ducts, or in a place subject to direct sunlight, or excessive dust or mechanical vibration or shock.
- Save the original shipping carton and packing materials, as they will come in handy if you ever have to ship your monitor.
- For maximum protection, repackage your monitor as it was originally packed at the factory.
- To keep the monitor looking new, periodically clean it with a soft cloth. Stubborn stains may be removed with a cloth lightly dampened with a mild detergent solution. Never use strong solvents such as thinner, benzene, or abrasive cleaners, since these will damage the cabinet. As a safety precaution, always unplug the monitor before cleaning it.
- Do not scratch the screen with hard things as it may cause permanent damage.
- Do not allow liquids into monitor as it will result in component damage.

HOW TO ADJUST A SETTING

1. Press the MENU-button to activate the OSD window.
2. Press + or - to navigate through the functions. Once the desired function is highlighted, press the MENU-button to activate it. If the function selected has a sub-menu, press + or - again to navigate through the sub-menu functions. Once the desired function is highlighted, press MENU-button to activate it.
3. Press + or - to change the settings of the selected function.
4. If you want to adjust any other function, repeat steps 2-3.

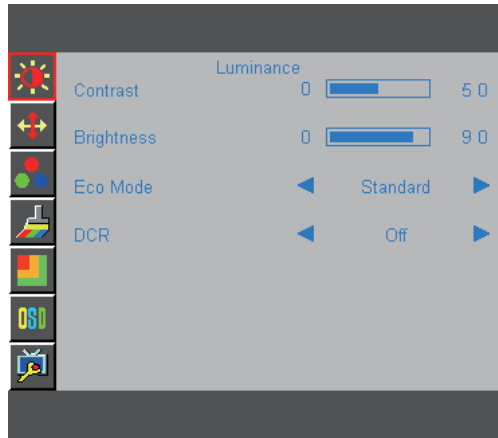









Figure 5 The OSD Message

ADJUSTING THE PICTURE

Main Menu Item	Main Menu Icon	1 st Sub Menu Item	Description
Luminance		Contrast	Adjusts Image brightness in relation to the background.
		Brightness	Adjusts backlight levels.
		Eco Mode	Picture Adjustment, Standard: Brightness = 90, Contrast = 50. Brightness, Contrast (Adjustable)
			Text: Brightness = 20, Contrast = 50. Brightness, Contrast ,Grayed. (Nonadjustable)
			Internet: Brightness = 40, Contrast = 50. Brightne ss, Contrast ,Grayed. (Nonadjustable)
			Game: Brightness = 60 Contrast = 50, Brightness, Contrast ,Grayed. (Nonadjustable)
			Movie: Brightness = 80, Contrast = 50, Brightness, Contrast ,Grayed. (Nonadjustable)
			Sports: Brightness = 100, Contrast = 50, Brightness, Contrast ,Grayed. (Nonadjustable)
			DCR
Image Setup		Clock	Adjust picture Clock to reduce Vertical-Line noise.
		Phase	Adjust Picture Phase to reduce Horizontal-Line noise.
		H. Position	Adjust the horizontal position of the picture.
		V. Position	Adjust the vertical position of the picture.
		Image Ratio	Select Image Aspect Ratio.

Main Menu Item	Main Menu Icon	1 st Sub Menu Item	Description
Color Temp.		Normal	Normal Color Temperature. (RGB value is nonadjustable)
		Warm	Warm Color Temperature. (RGB value is nonadjustable)
		Cool	Cool Color Temperature. (RGB value is nonadjustable)
		sRGB	RGB Color Temperature. (RGB value is nonadjustable)
		User	Adjust R.G.B levels as desired. User-R:Adjust Red Gain User-G:Adjust Green Gain User-B:Adjust Blue Gain
Color Boost		Full Enhance	Full Enhance.
		Nature Skin	Red level is raised.
		Green Field	Green level is raised.
		Sky-blue	Blue level is raised.
		Auto Detect	Auto gain for input signal.
		Demo	Demonstrates Color Boost Enhancements in the left half of screen.
Picture Boost		Frame Size	Adjust the Size of the Frame.
		Contrast	Contrast Adjustment for Enhance Area.
		Brightness	Brightness Adjustment for Enhance Area.
		H. Position	Adjust the horizontal position of the Bright Frame.
		V. Position	Adjust the vertical position of the Bright Frame.
		Bright Frame	Enhance Area function.
OSD Setup		H. Position	Adjust the horizontal position of the OSD.
		V. Position	Adjust the vertical position of the OSD.
		Timeout	Adjust the OSD timeout.
		Language	Set OSD display language .(English is default setting)
Extra		Input Select	Select input source.
		DDC/CI	Select DDC/CI on or off.
		Reset	Set Monitor to default status.
		Information	Show the resolution, H/V frequency of current input timing.

PLUG AND PLAY

Plug & Play DDC2B Feature

This monitor is equipped with VESA DDC2B capabilities according to the VESA DDC STANDARD. It allows the monitor to inform the host system of its identity and, depending on the level of DDC used, communicate additional information about its display capabilities.

The DDC2B is a bidirectional data channel based on the I²C protocol. The host can request EDID information over the DDC2B channel.

THIS MONITOR WILL APPEAR TO BE NON-FUNCTIONAL IF THERE IS NO VIDEO INPUT SIGNAL. IN ORDER FOR THIS MONITOR TO OPERATE PROPERLY, THERE MUST BE A VIDEO INPUT SIGNAL.

This monitor meets the Green monitor standards as set by the Video Electronics Standards Association (VESA) and The Swedish Confederation Employees (NUTEK). This feature is designed to conserve electrical energy by reducing power consumption when there is no video-input signal present. When there is no video input signal this monitor, following a time-out period, will automatically switch to an OFF mode. This reduces the monitor's internal power supply consumption. After the video input signal is restored, full power is restored and the display is automatically redrawn. The appearance is similar to a "Screen Saver" feature except the display is completely off. The display is restored by pressing a key on the keyboard, or clicking the mouse.

USING THE RIGHT POWER CORD :

The accessory power cord for the Northern American region is the wallet plug with NEMA 5-15 style and is UL listed and CSA labeled. The voltage rating for the power cord shall be 125 volts AC.

Supplied with units intended for connection to power outlet of personal computer: Please use a cord set consisting of a minimum No. 18 AWG, type SJT or SVT three conductors flexible cord. One end terminates with a grounding type attachment plug, rated 10A, 250V, CEE-22 male configuration. The other end terminates with a molded-on type connector body, rated 10A, 250V, having standard CEE-22 female configuration.

Please note that power supply cord needs to use VDE 0602, 0625, 0821 approval power cord in European countries.

CALIBRATION/RESET INSTRUCTIONS

PCT2265 Calibration/Reset Instructions:

The PCT2265 is available with USB connection. It is Microsoft® Windows® 7, 8 HID (Human Interface Device) compatible if you use the USB touch screen interface. No additional software driver is required. Calibration is a simple process and can be invoked by running Tablet PC Settings from Control Panel and clicking the Calibrate button. Click the Reset button to reset the touchscreen to the factory calibration settings. To reset the existing calibration data, click "Reset" in the Tablet PC Settings window.

TECHNICAL SUPPORT (FAQ)

Problem & Question	Possible Solution
Power LED is not on	<ul style="list-style-type: none"> * Check if the Power Switch is in the ON position. * Power Cord should be connected.
No Plug & Play	<ul style="list-style-type: none"> * Check if the PC system is Plug & Play compatible. * Check if the Video Card is Plug & Play compatible . * Check if the D-15 plug pin of Video Cable is bent.
Picture is fuzzy	<ul style="list-style-type: none"> * Adjust the Contrast and Brightness Controls.
Picture bounces or a wave pattern is present in the picture	<ul style="list-style-type: none"> * Move electrical devices that may cause electrical interference.
The power LED is ON (orange) but there's no video or no picture.	<ul style="list-style-type: none"> * Computer Power Switch should be in the ON position. * Computer Video Card should be snugly seated in its slot. * Make sure monitor's video cable is properly connected to the computer. * Inspect monitor's video cable and make sure none of the pins are bent. * Make sure computer is operational by hitting the CAPS LOCK key on the keyboard while observing the CAPS LOCK LED.The LED should either turn ON or OFF after hitting the CAPS LOCK key.
Missing one of the primary colors (RED, GREEN, or BLUE)	<ul style="list-style-type: none"> * Inspect the monitor's video cable and make sure that none of the pins are bent.
Screen image is not centered or sized properly.	<ul style="list-style-type: none"> * Adjust pixel frequency (CLOCK) and FOCUS or press hot-key (AUTO).
Picture has color defects (white does not look white)	<ul style="list-style-type: none"> * Adjust RGB color or select color temperature.
Poor brightness or contrast	<ul style="list-style-type: none"> * When the brightness of the screen lowers after being used for a certain period and the function of the display is affected, send it to our authorized service center for repair.
Horizontal or vertical disturbances on the screen	<ul style="list-style-type: none"> * Restart your computer or adjust CLOCK and FOCUS or perform auto configure hot key.

TECHNICAL SUPPORT (FAQ)

CLOCK (pixel frequency) controls the number of pixels scanned by one horizontal sweep. If the frequency is not correct, the screen shows vertical stripes and the picture has not correct width.

FOCUS adjusts the phase of the pixel clock signal. With a wrong phase adjustment the picture has horizontal disturbances in light picture.

For FOCUS and CLOCK adjustment use "dot-pattern" or win 95/98/2000/ME/XP/Win 7 shut-down mode pattern.

ERROR MESSAGE & POSSIBLE SOLUTION

NO SIGNAL:

1. Check that the signal-cable is properly connected, if the connector is loose,tighten the connector's screws.
2. Check the signal-cable's connection pins for damage.

INPUT NOT SUPPORT:

Your computer has been set to unsuitable display mode, set the computer to display mode given in the following table.

APPENDIX

SPECIFICATIONS

LCD Panel	Driving system	TFT Color LCD
	Size	54.6cm(21.5")
	Pixel pitch	0.2482(H) × 0.2482(V)
Input	Video	R,G,B Analog Interface
		HDMI
		DVI-D
	Separate Sync.	H/V TTL
	H-Frequency	Analog&Digital:30kHz – 83kHz
V-Frequency	Analog&Digital:55-75Hz	
Display Colors		16.7M Colors
Dot Clock		170MHz
Max. Resolution		1920X1080@60Hz
Plug & Play		VESA DDC2BTM
Power Consumption	ON Mode	≤28W(TYP)
	OFF Mode	≤0.5W
Input Connector		D-Sub mini 15 pin, HDMI, DVI-D
Input Video Signal		Analog:0.7Vp-p(Standard),75Ω,Positive Digital:HDMI
Power Source		100~240VAC,50/60Hz
Environmental Considerations		Operating Temp: 0°C to 40°C Storage Temp.: -25°C to 55°C Operating Humidity: 10% to 85%
Dimensions (W x H X D)		20.59" x 15.19" x 9.39" (522mm x 385mm x 238mm)
Weight (w/stand)		14.6lbs (6.64kg)
Weight ((w/o stand))		9.5lbs (4.31kg)
Regulatory Compliance		cTUVus, CE , FCC B

FACTORY PRESET TIMING TABLE

STAND	RESOLUTION	HORIZONTAL FREQUENCY(kHZ)	VERTICAL FREQUENCY(Hz)
VGA	640 x 480	31.469	59.94
	640 x 480	35	66.667
VGA	640 x 480	37.861	72.809
Mac VGA	640 x 480	37.5	75
Dos-mode	720 x 400	31.469	70.087
	800 x 600	35.156	56.25
	800 x 600	37.879	60.317
	800 x 600	48.077	72.188
SVGA	800 x 600	46.875	75
Mac SVGA	832 x 624	49.726	74.551
	1024 x 768	48.363	60.004
	1024 x 768	56.476	70.069
	1024 x 768	57.5	72.074
XGA	1024 x 768	60.023	75.029
	1280 x 1024	67.981	60.02
SXGA	1280 x 1024	79.976	75.025
	1440 x 900	55.935	59.887
WXGA+	1440 x 900	70.635	74.984
WSXGA+	1680 x 1050	65.29	59.954
HDTV	1920 X 1080	66.295	59.887

CONNECTOR PIN ASSIGNMENT

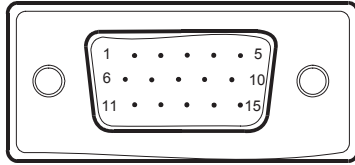

15 - Pin Color Display Signal Cable

PIN NO.	DESCRIPTION	PIN NO.	DESCRIPTION
1.	Red	9.	+5V
2.	Green	10.	Detect Cable
3.	Blue	11.	Ground
4.	Ground	12.	DDC-Serial Data
5.	Ground	13.	H-Sync
6.	R-Ground	14.	V-Sync
7.	G-Ground	15.	DDC-Serial Clock
8.	B-Ground		

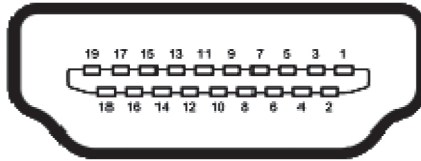

19 - Pin Color Display Signal Cable

PIN NO.	DESCRIPTION	PIN NO.	DESCRIPTION
1.	TMDS Data 2+	11.	TMDS Clock Shield
2.	TMDS Data 2 Shield	12.	TMDS Clock-
3.	TMDS Data 2-	13.	CEC
4.	TMDS Data 1+	14.	N.C.
5.	TMDS Data 1 Shield	15.	DDC SCL
6.	TMDS Data 1-	16.	DDC CLK
7.	TMDS Data 0+	17.	DDC/CEC Ground
8.	TMDS Data 0 Shield	18.	+5V Power (max 50mA)
9.	TMDS Data 0-	19.	Hot Plug Detect
10.	TMDS Clock+		

WALL MOUNTING (OPTIONAL)

Refer to the instructions that come with the base mounting kit. To convert your display from a desk-mounted to a wall-mounted display, do the following:

1. Verify that the power button is turned Off, then disconnect the power cord.
2. Remove the plastic covers from the back of the display.
3. Remove the four screws attaching the base (screw dimension: M4 x 12mm).
4. Attach the mounting bracket from the VESA compatible wall mounting kit (100 mm x 100 mm distance).
5. Attach the display to the wall, following the instructions in the wall-mounting kit.

NOTE: For use only with wall mount bracket with minimum weight/load: 26.5lb (12kg.)

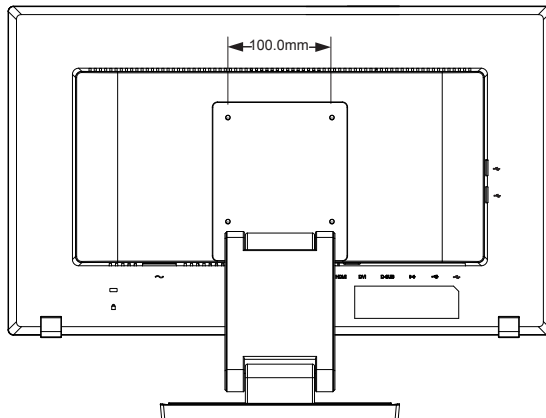

| PLANAR SUPPORT

Cables and Accessories

To find cables and accessories for your Planar monitor, touch screen or other Planar products visit our online store at www.PlanarOnline.com

Technical Support

Visit Planar at <http://www.planar.com/support> for operations manuals, touch screen drivers, warranty information and access to Planar's Technical Library for online troubleshooting.

To speak with Planar Customer Support please have you model and serial number available and dial:

Planar Support

Tel: 1-866-PLANAR1 (866-752-6271) or +1 503-748-5799 outside the US.

Hours: 24 hours a day, 7 days a week.

Toll or long distance charges may apply.

Planar Systems, Inc.

Customer Service

24x7 Online Technical Support: <http://www.planar.com/support>

1195 NW Compton Drive

Beaverton, OR 97006-1992

Tel: 1-866-PLANAR1 (866-752-6271), or +1 503-748-5799 outside the United States,

Hours: 24 hours a day, 7 days a week

©2013 Planar Systems, Inc.

Planar is a registered trademark of Planar Systems, Inc. Other brands and names are the property of their respective owners. Technical information in this document is subject to change without notice.



PN: 020-1236-00B