

CS510-XD™ / CS520-XD™

Wireless Headset System

Designed in Santa Cruz, California

Guía de inicio rápido
Guide de démarrage rapide



plantronics

1 Charge Headset

1 Plug one end of power supply into power jack on back of the base and other end into working power outlet.

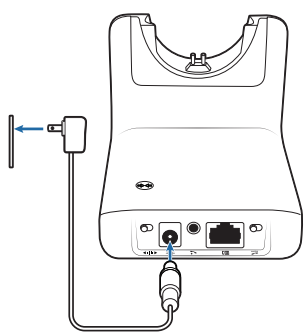

2 To charge, dock headset in base for minimum of 20 minutes.

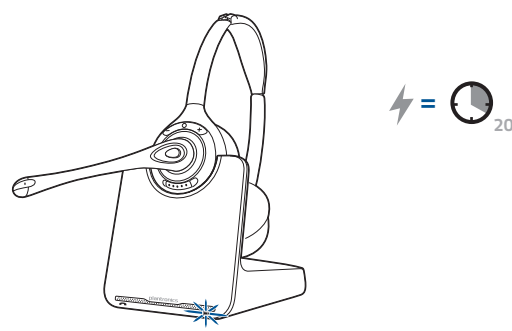

2 Connect Desk Phone

1 Connect cables from desk phone to base.

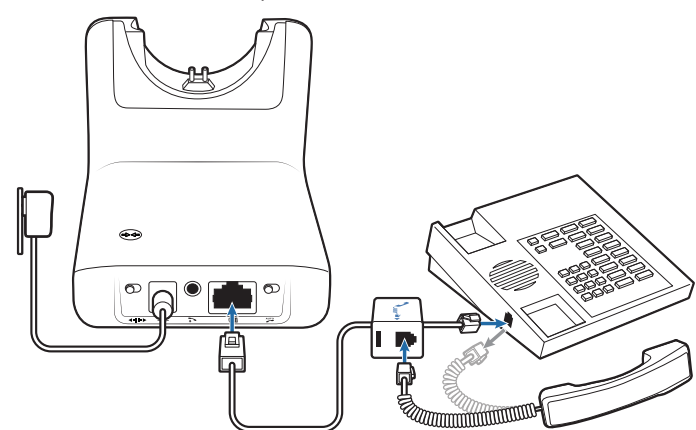

3 Make a Call

1 While wearing headset, tap call control button.

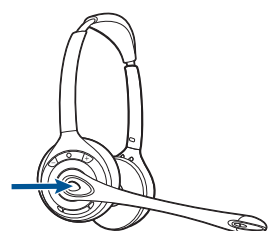

2 Remove the desk phone handset.

3 Dial test call from desk phone.

NOTE You may also call the automated sound test at 800-317-8308. It's the quickest way to test and optimize your system.

4 End call by pressing headset call control button and hang up the handset.

Troubleshooting Tip: If you do not hear a dial tone, adjust the slide switch (A–G) until you do. Default setting **A** works for majority of desk phones.



NOTE For remote call control capability (HL10™ lifter or EHS™ cable), see plantronics.com/accessories.

System Features

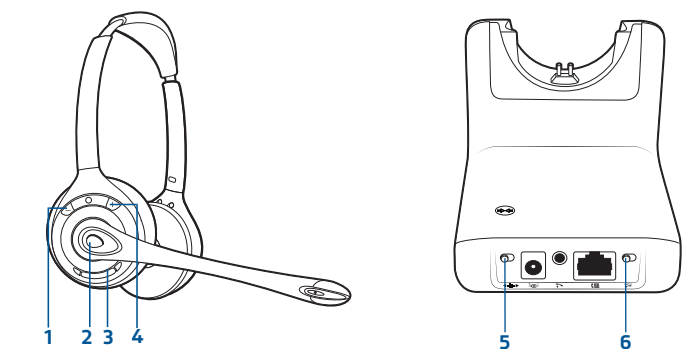

1 **Volume down button (-)** Tap

2 **Call control button**

Answer/end call Tap

3 **Mute button Tap** (base LED solid red)

4 **Volume up button (+)** Tap

5 **Narrowband/wideband audio switch**

Black Narrowband Audio

Yellow Wideband Audio (desk phone must be capable of wideband audio)

NOTE Talk time will be reduced when operating in wideband mode.

6 **Auto answer switch**

Black (off) Tap call control button to place or answer call

Gray (on) Lift headset from base to place or answer call

Your CS510-XD/CS520-XD consists of a C052-XD™ base and a WH300-XD™/WH350-XD™ headset.

Plantronics, Inc.
345 Encinal Street
Santa Cruz, CA 95060
United States

© 2013 Plantronics, Inc. All rights reserved. Plantronics, the logo design, CS510-XD, CS520-XD, C052-XD, WH300-XD, WH350-XD, EHS, and HL10 are trademarks or registered trademarks of Plantronics, Inc. All other trademarks are the property of their respective owners. Patents US D535,285; D538,785; BR D71026967; CN ZL200630123314.7; ZL200630123313.2; ZL20130145424.4; EM 000543798-0004; 000543798-0005; 001-865510-0001; IN 236857; TW D117515; D117333; Patents Pending

NEED MORE HELP?

Technical support

plantronics.com/support

Online user guide

<http://docs.plantronics.com/cs500>

CS510-XD™ / CS520-XD™

Sistema de auriculares inalámbricos

Diseñado en Santa Cruz, California

GUÍA DE INICIO RÁPIDO

plantronics

1 Cómo cargar el audifono

1 Enchufe un extremo del suministro eléctrico en el conector hembra en la parte trasera de la base y el otro extremo en la salida del tomacorriente que está funcionando.

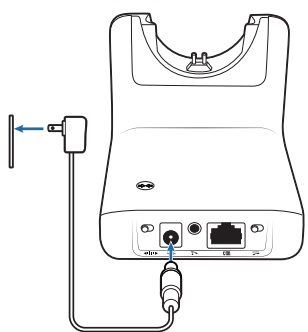

2 Para cargar, coloque los auriculares en la base durante 20 minutos como mínimo.

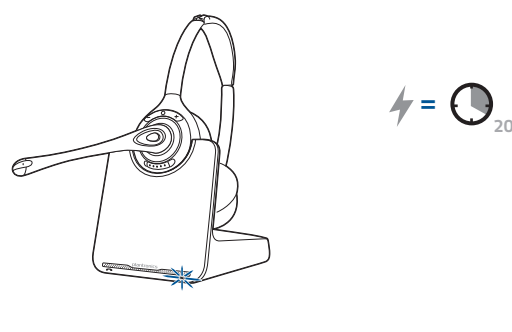

2 Cómo conectar el teléfono de escritorio

1 Conecte los cables del teléfono de escritorio a la base.

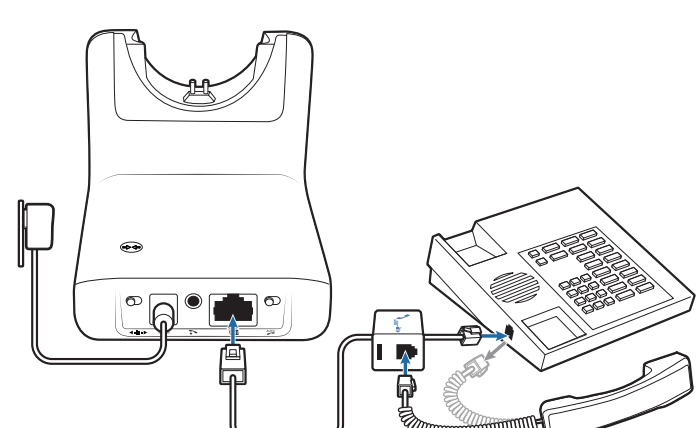

3 Cómo hacer una llamada

1 Con los auriculares colocados, toque el botón de control de llamadas.

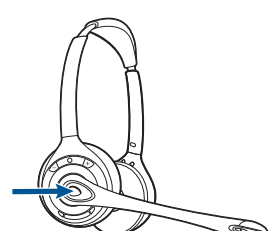

2 Levante el tubo del teléfono de escritorio.

3 Realice una llamada de prueba desde el teléfono de escritorio.

4 Para finalizar la llamada, presione el botón de control de llamadas de los auriculares y cuelgue el tubo.

Consejo para la resolución de problemas: Si no escucha un tono de marcar, ajuste el conmutador deslizante (A–G) hasta que lo haga. El ajuste preconfigurado **A** funciona para la mayoría de los teléfonos de escritorio.

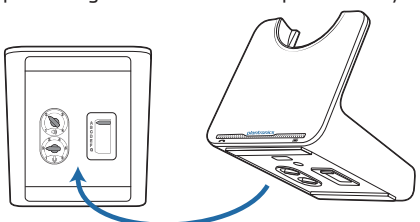

NOTA Para la función de control de llamadas remotas (dispositivo para descolgar el teléfono HL10 o cable EHS), consulte plantronics.com/accessories.

Funciones del sistema

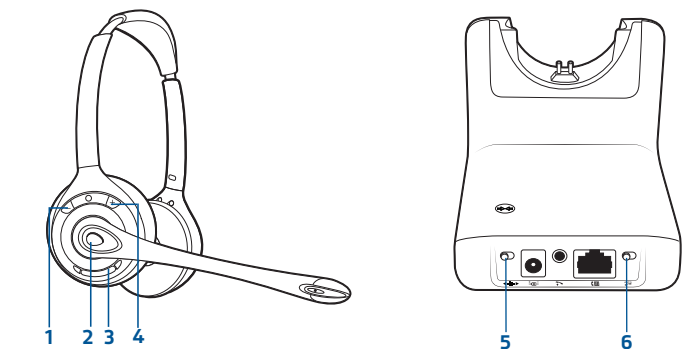

1 **Botón para bajar el volumen (-)** Toc

2 **Botón de control de llamadas**

Responder/finalizar llamada Toc

3 **Botón de silencio** Toc (base LED en color rojo sólido)

4 **Botón para aumentar el volumen (+)** Toc

5 **Interruptor de audio de banda ancha/estrecha**

Negro: audio de banda estrecha

Amarillo: audio de banda ancha (el teléfono de escritorio debe tener capacidad para audio de banda ancha)

NOTA Se reducirá el tiempo de conversación al operar en modo de banda ancha.

6 **Respuesta automática Conmutador**

Negro (apagado) Toque el botón de control de llamadas para realizar o responder una llamada

Gris (encendido) Levante los auriculares de la base para realizar o responder una llamada

Su CS510-XD/CS520-XD incluye una base C052-XD y unos auriculares WH300-XD/WH350-XD.

¿NECESITA MÁS AYUDA?

Asistencia técnica

plantronics.com/support

Guía del usuario en línea

<http://docs.plantronics.com/cs500>

Limited Warranty
Plantronics offers a one-year limited warranty on this product. In some countries you must register your product to receive warranty services. Please be aware that you may have other rights depending on the laws of the state or country where the product was purchased. We strongly advise you to keep your receipt of purchase in order to prove the date of purchase of this product. To register your product and for warranty terms and conditions, visit our web site at www.plantronics.com/support.

Arbitration Agreement
Most disputes and claims related to this product, including your use of this product, are subject to the Plantronics, Inc. Arbitration Agreement ("Arbitration Terms"). Disputes or claims arising or brought in any country of Europe or Africa are not subject to this Arbitration Agreement. The Arbitration Terms along with FAQs related to the arbitration process can be found at www.plantronics.com/us/terms/arbitration-forms/, or can be requested in writing submitted either to: (i) general.counsel@plantronics.com or (ii) Plantronics, Inc., 345 Encinal Street, Santa Cruz, CA 95060, United States of America. Attention: General Counsel.

Safety Instructions
Please read the following safety and operational instructions before using this product. Please keep these instructions for your reference. When using this product, these basic safety precautions and warnings should be followed to reduce the risk of fire, electric shock, injury to persons and damage to property. Additional warnings may be present on the product, packaging, or in the user instructions.

General
Operating, storage and charging temperature is 0°C to 40°C (32°F to 104°F).

Warnings

- Use only those Plantronics products and accessories designed for use with this Plantronics system.
- CHILDREN: Never allow children to play with the product—small parts may be a choking hazard.
- Do not disassemble the product or AC adapter as this may expose you to dangerous voltages or other risks. Incorrect reassembly can cause electric shock or fire when the product is subsequently used.
- Do not insert anything into the product or charger because this may cause damage to the internal components or cause injury to you.
- Avoid contact with liquids. Do not locate this product near water, for example, near a bathtub, or sink, in a wet basement, or near a swimming pool to protect against or damage to the product or injury to you.
- Discontinue use of product and contact Plantronics if the product overheats, has a damaged cord or plug, if the product has been dropped or damaged, or if the product has come into contact with liquids.
- This product should never be placed over or near a heat source and should not be placed in locations which do not have proper ventilation.
- If you experience a skin irritation after using this product, discontinue use and contact Plantronics.
- Exposure to high volume sound levels may cause temporary or permanent damage to your hearing. Although there is no single volume setting that is appropriate for everyone, you should always use your headset with the volume set at moderate levels and avoid prolonged exposure to high volume sound levels. The louder the volume, the less time is required before your hearing could be affected. You may experience different sound levels when using your headset with different devices. The device you use and its settings affect the level of sound you hear. If you experience hearing discomfort, you should stop listening to the device through your headset and have your hearing checked by your doctor. To protect your hearing, some hearing experts suggest that you:

1. Set the volume control in a low position before putting the headset on your ears and use as low a volume as possible.
2. Avoid turning up the volume to block out noisy surroundings. Whenever possible, use your headset in a quiet environment with low background noise.
3. Limit the amount of time you use headsets at high volume levels.
4. Turn the volume down if the sound from the headset prevents you from hearing people speaking near you. See plantronics.com/healthandsafety for more information on headsets and hearing.

FCC Registration Information – Part 68
This equipment complies with Part 68 of the FCC rules and the requirements adopted by ACTA. On the exterior of this equipment is a label that contains a product identifier in the format USAA40Q#TXXXX. If requested, this information must be provided to your telephone company. A plug and jack used to connect this equipment to the premises wiring and telephone network must comply with the applicable FCC Part 68 rules and requirements adopted by ACTA. A compliant telephone cord and modular plug is provided with this product. It is designed to be connected to a compatible jack that is also compliant. See installation instructions for details.
The REN is used to determine the quantity of devices you may connect to your telephone line. Excessive RENs on a telephone line may result in the devices not ringing in response to an incoming call. In most, but not all areas, the sum of the RENs should not exceed five (5.0). To be certain of the number of devices you may connect to your telephone line, contact your local telephone company for products approved after August 8, 2001, the REN for this product is part of the product identifier that has the format USAA40Q#TXXXX. The digits represented by # are the REN without decimal points. (For example, 03 represents a REN of 0.3.) For earlier products, the REN is separately shown on the label. If this telephone equipment causes harm to the telephone network, the telephone company will notify you in advance that temporary discontinuance of service may be required. But if advance notice isn't practical, the telephone company will notify the customer as soon as possible. Also, you will be advised of your right to file a complaint with the FCC, if you believe it is necessary.
The telephone company may make changes in its facilities, equipment, operations, or procedures that could affect the proper functioning of your equipment. If they do, you will be notified in advance in order for you to make necessary modifications to maintain uninterrupted service. If trouble is experienced with this unit, for repair or warranty information, please contact customer service at (800) 544-4660. If the equipment is causing harm to the network, the telephone company may request that you disconnect the equipment until the problem is resolved.
DO NOT DISASSEMBLE THIS EQUIPMENT: It does not contain any user-serviceable components.
We recommend the installation of an AC surge arrester in the AC outlet to which this equipment is connected. Telephone companies report that electrical surges, typically lightning transients, are very destructive to customer terminal equipment connected to AC power sources.

Exposure to RF Radiation
The internal wireless radio operates within the guidelines found in radio frequency safety standards and recommendations, which reflect the consensus of the scientific community. Independent studies have shown that the internal wireless radio is safe for use by consumers. Visit plantronics.com for more information.
In order to comply with FCC and IC RF Exposure requirements, the base must be installed and operated such that a minimum separation distance of 20 cm is maintained between the base and all persons during normal operation. The headset complies with FCC radiation limits set forth for an uncontrolled environment.
NOTE: Modifications not expressly approved by Plantronics, Inc. could void the user's authority to operate the equipment.

Charging Warnings
• Use only the charger supplied by Plantronics to charge the product. Do not use the chargers for any other purpose.
• Ensure that the voltage rating corresponds to the power supply you intend to use, for example 100-240 V, 50/60 Hz, 0.2 A.

- Charge the headset according to the instructions supplied with the unit.
- Plug the AC adapter or charger into an outlet that is near the equipment and will be easily accessible.
- Never store or use the product or charge the battery where the temperature may fall below 0°C (32°F) or rise above 40°C (104°F).

Headset Battery Warnings

- To avoid the risk of explosion, fire or leakage of toxic chemicals, please observe the following warnings:
- Do not dispose of the product or battery in a fire or heat above 40°C (104°F).
 - Do not open, deform or mutilate the battery. There may be corrosive materials which can cause damage to eyes or skin and may be toxic if swallowed.
 - Always store batteries where children cannot reach them.
 - If your product has a replaceable battery, use only the battery type supplied by Plantronics. Remove a spent battery promptly.
 - Do not allow any battery or its holder to contact metal objects such as keys or coins.
- RECYCLING: Your headset and/or the battery must be recycled or disposed of properly. Contact your local recycling center for proper disposal of your headset.

FCC Requirements Part 15
Note: This equipment has been tested and found to comply with the limits for a Class B digital device, pursuant to part 15 of the FCC Rules. These limits are designed to provide reasonable protection against harmful interference in a residential installation. This equipment generates, uses, and can radiate radio frequency energy and, if not installed and used in accordance with the instructions, may cause harmful interference to radio communications. However, there is no guarantee that interference will not occur in a particular installation. If this equipment does cause harmful interference to radio or television reception, which can be determined by turning the equipment off and on, the user is encouraged to try to correct the interference by one or more of the following measures:

1. Reorient or relocate the receiving antenna.
2. Increase the separation between the equipment and receiver.
3. Connect the equipment into an outlet on another circuit that to which the receiver is connected.
4. Consult the dealer or an experienced radio/TV technician for help.

FCC Registration Information – Part 68
This equipment complies with Part 68 of the FCC rules and the requirements adopted by ACTA. On the exterior of this equipment is a label that contains a product identifier in the format USAA40Q#TXXXX. If requested, this information must be provided to your telephone company. A plug and jack used to connect this equipment to the premises wiring and telephone network must comply with the applicable FCC Part 68 rules and requirements adopted by ACTA. A compliant telephone cord and modular plug is provided with this product. It is designed to be connected to a compatible jack that is also compliant. See installation instructions for details.
The REN is used to determine the quantity of devices you may connect to your telephone line. Excessive RENs on a telephone line may result in the devices not ringing in response to an incoming call. In most, but not all areas, the sum of the RENs should not exceed five (5.0). To be certain of the number of devices you may connect to your telephone line, contact your local telephone company for products approved after August 8, 2001, the REN for this product is part of the product identifier that has the format USAA40Q#TXXXX. The digits represented by # are the REN without decimal points. (For example, 03 represents a REN of 0.3.) For earlier products, the REN is separately shown on the label. If this telephone equipment causes harm to the telephone network, the telephone company will notify you in advance that temporary discontinuance of service may be required. But if advance notice isn't practical, the telephone company will notify the customer as soon as possible. Also, you will be advised of your right to file a complaint with the FCC, if you believe it is necessary.

The telephone company may make changes in its facilities, equipment, operations, or procedures that could affect the proper functioning of your equipment. If they do, you will be notified in advance in order for you to make necessary modifications to maintain uninterrupted service. If trouble is experienced with this unit, for repair or warranty information, please contact customer service at (800) 544-4660. If the equipment is causing harm to the network, the telephone company may request that you disconnect the equipment until the problem is resolved.
DO NOT DISASSEMBLE THIS EQUIPMENT: It does not contain any user-serviceable components.
We recommend the installation of an AC surge arrester in the AC outlet to which this equipment is connected. Telephone companies report that electrical surges, typically lightning transients, are very destructive to customer terminal equipment connected to AC power sources.

Exposure to RF Radiation
The internal wireless radio operates within the guidelines found in radio frequency safety standards and recommendations, which reflect the consensus of the scientific community. Independent studies have shown that the internal wireless radio is safe for use by consumers. Visit plantronics.com for more information.
In order to comply with FCC and IC RF Exposure requirements, the base must be installed and operated such that a minimum separation distance of 20 cm is maintained between the base and all persons during normal operation. The headset complies with FCC radiation limits set forth for an uncontrolled environment.
NOTE: Modifications not expressly approved by Plantronics, Inc. could void the user's authority to operate the equipment.

Advertencias sobre la carga

- Utilice únicamente el cargador proporcionado por Plantronics para cargar el producto. No use los cargadores para ningún otro fin. Asegúrese de que el voltaje indicado para el producto coincide con el voltaje de la red eléctrica que piensa utilizar, por ejemplo 100-240 V, 50/60 Hz, 0.2 A.
- Cargue el audifono siguiendo las instrucciones suministradas con esta unidad.
- Conecte el adaptador de CA o el cargador a una toma de corriente próxima al equipo y a la que pueda llegar fácilmente.
- No guarde ni use el producto, ni cargue la batería, en lugares donde la temperatura pueda bajar a menos de 0°C (32°F) o subir a más de 40°C (104°F).

Advertencias sobre la pila del audifono

- Para evitar el riesgo de explosión, incendio o emisión de sustancias tóxicas, tome en cuenta las advertencias siguientes:
- No tire el producto ni la pila al fuego ni lo exponga a un calor por encima de los 40°C (104°F).
 - No abra, deforme ni corte la pila. La pila puede contener materiales corrosivos que pueden causar daños oculares o cutáneos, o ser tóxicos si se ingieren.
 - Guarde siempre las pilas en un lugar que esté fuera del alcance de los niños.
 - Si el producto tiene una batería que se puede cambiar, use únicamente el tipo de batería suministrado por Plantronics. Retire las baterías gastadas lo antes posible.
 - No permita que la pila ni su soporte entren en contacto con objetos metálicos, como llaves o monedas.
- RECIKLADO: el audifono o la pila incluida se deben reciclar o eliminar de manera adecuada. Póngase en contacto con el centro de reciclado local para desechos correctamente.

CS510-XD™ / CS520-XD™

Système de micro-casque sans fil

Conçu à Santa Cruz, en Californie

GUIDE DE DÉMARRAGE RAPIDE

plantronics

1 Recharge du micro-casque

- 1 Branchez une extrémité du cordon d'alimentation dans la prise arrière de la base et l'autre dans une prise de courant fonctionnelle.

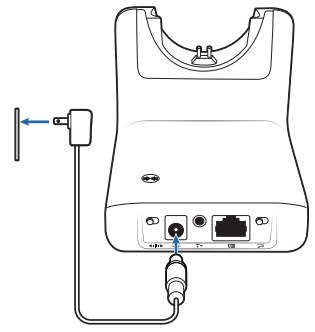

- 2 Pour recharger le micro-casque, connectez-le à la base pendant au moins 20 minutes.

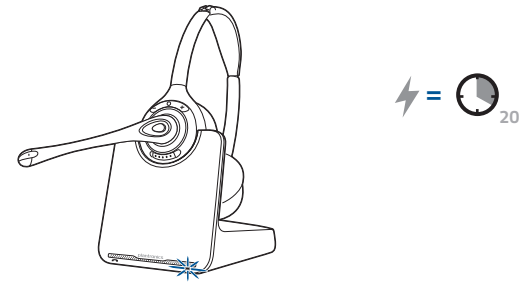

2 Connexion au téléphone de bureau

- 1 Connectez les câbles du téléphone de bureau à la base.

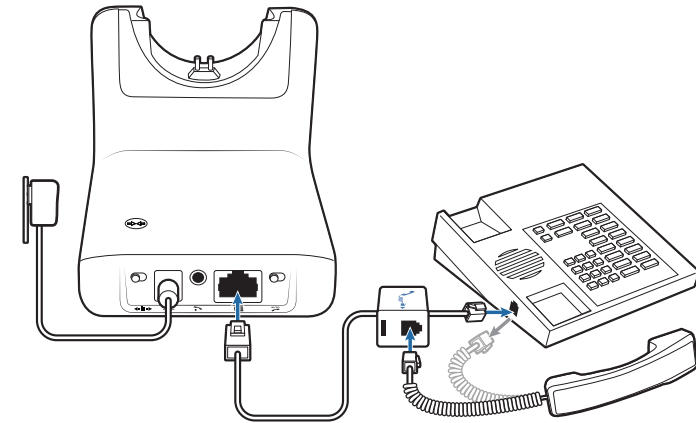

3 Effectuer un appel

- 1 Une fois le micro-casque installé, appuyez sur le bouton de contrôle des appels.

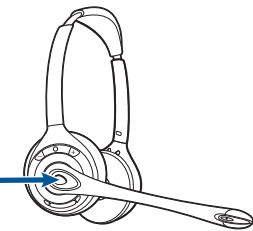

- 2 Débranchez le combiné du téléphone de bureau.

- 3 Procédez à un appel d'essai à partir du téléphone de bureau.

REMARQUE Vous pouvez également appeler le test de son automatisé au 1 800-317-8308. C'est la façon la plus rapide de tester et d'optimiser votre système.

- 4 Terminez l'appel en appuyant sur le bouton de contrôle des appels du micro-casque et en raccrochant le combiné.

Conseil de dépannage : si vous n'entendez pas la tonalité, changez la position du bouton coulissant (A-G) jusqu'à ce que vous l'entendiez. La configuration par défaut **A** fonctionne avec la majorité des téléphones de bureau.

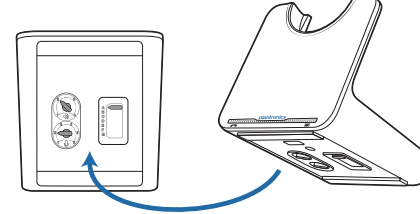

REMARQUE Pour la fonction de contrôle des appels à distance (décrocheur HLI0 ou câble de commutateur électronique), voir plantronics.com/accessories.

BESOIN D'AIDE SUPPLÉMENTAIRE?

Soutien technique
plantronics.com/support

Guide de l'utilisateur en ligne
<http://docs.plantronics.com/cs500>

Caractéristiques du système

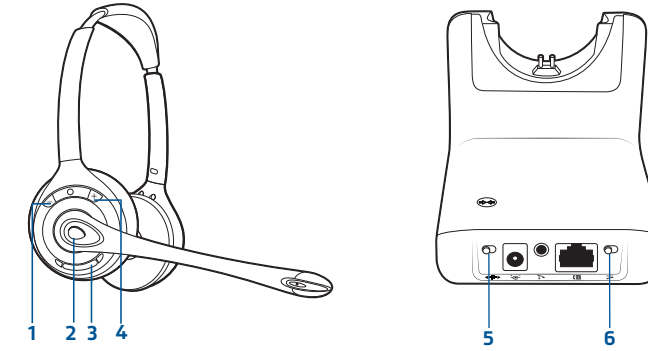

- 1 Bouton de réduction du volume (-)

- 2 Bouton de contrôle des appels
Appuyer pour répondre/terminer un appel

- 3 Bouton discrétion (voyant rouge vif sur la base)

- 4 Bouton d'augmentation du volume (+)

- 5 Bouton de changement de bande passante audio «|»

Noir Bande audio étroite

Jaune Audio large bande (le téléphone de bureau doit prendre en charge l'audio en bande large)

REMARQUE : l'autonomie de conversation est réduite en mode large bande.

- 6 Bouton de réponse automatique ^{AUTO}

Noir (arrêt), appuyez sur le bouton de contrôle des appels pour appeler ou répondre à un appel

Gris (marche), soulevez le micro-casque de la base pour appeler ou répondre à un appel

Votre CS510-XD/CS520-XD comprend une base C052-XD et un micro-casque WH300-XD/WH350-XD.

Garantie limitée

Plantronics offre une garantie limitée d'un an sur ce produit. Dans certains pays, vous devez enregistrer votre produit pour bénéficier des services de garantie. Toutefois, vous pouvez également jouir d'autres droits, lesquels peuvent varier en fonction des lois en vigueur dans l'Etat et le pays dans lequel vous avez effectué votre achat. Nous vous conseillons de conserver votre reçu afin de prouver la date d'achat de ce produit. Pour enregistrer votre produit et consulter les conditions générales de garantie de Plantronics, rendez-vous notre site Web www.plantronics.com/support.

Clause compromissoire

La plupart des réclamations et des litiges associés à ce produit, notamment votre utilisation de ce produit, sont soumis à la convention d'arbitrage de Plantronics, Inc. (le Conditions d'arbitrage). Les litiges et réclamations subis ou engagés en Europe ou en Afrique ne sont pas soumis à cette clause compromissoire. Vous pouvez consulter les Conditions d'arbitrage et les questions fréquemment posées sur le processus d'arbitrage à l'adresse plantronics.com/us/terms/arbitration-forms/ ou demander une copie papier (i) par e-mail : general.counsel@plantronics.com ou (ii) par courrier : Plantronics, Inc., 345 Encinal Street, Santa Cruz, CA 95060, Etats-Unis, à l'attention du Conseil général.

Renseignements sur la sécurité

Veillez lire les renseignements suivants sur la sécurité et le fonctionnement avant d'utiliser ce produit. Veuillez conserver ces instructions pour consultation ultérieure. Lorsque vous utilisez ce produit, vous devez prendre certaines précautions de base pour réduire le risque d'incendie, de choc électrique, de blessure et pour éviter tout dommage matériel. D'autres avertissements peuvent figurer sur l'appareil, sur l'emballage ou dans les instructions.

Généralités

La plage de température d'utilisation, d'entreposage et de chargement de l'appareil est de 0 °C à 40 °C (32 °F à 104 °F).

⚠ Avertissements

- N'utilisez que les produits et accessoires Plantronics spécialement conçus pour ce système.
- ENFANTS. Ne laissez pas les enfants jouer avec le produit; ils risqueraient de s'étouffer avec les petites pièces.
- Ne démontez pas le produit ou l'adaptateur c.a. car cela peut vous exposer à des tensions dangereuses ou à d'autres risques. Un mauvais remontage de l'appareil pourrait causer un choc électrique lors d'une utilisation ultérieure du produit.
- N'insérez rien dans le micro-casque ou le chargeur; vous pourriez endommager les composants internes ou vous blesser.
- Évitez tout contact avec des liquides. Ne placez pas le produit près d'une source d'eau ou d'humidité, par exemple près d'une baignoire, d'un évier ou d'une piscine ni dans un sous-sol humide, afin d'éviter tout dommage au produit ou toute blessure éventuelle.
- Cessez d'utiliser le produit et communiquez avec Plantronics en cas de surchauffe, de prise ou de cordon endommagé, si vous avez laissé tomber le produit ou s'il est endommagé, ou si le produit est entré en contact avec des liquides.
- Ce produit ne doit jamais être placé près d'une source de chaleur ni dans un endroit où la ventilation est inadéquate.
- Si une irritation de la peau se manifeste après avoir utilisé ce produit, cessez de l'utiliser et communiquez avec Plantronics.
- Une exposition à un volume sonore élevé peut endommager votre ouïe de manière temporaire ou permanente. Même si aucun réglage de volume n'est approprié pour tous, vous devez toujours régler le volume d'écoute à une intensité modérée et éviter d'utiliser un volume élevé de façon prolongée. Plus le volume est élevé, plus vous risquez d'endommager rapidement votre audition. Le volume du micro-casque peut varier selon l'appareil auquel il est couplé. L'appareil que vous utilisez ainsi que ses paramètres modifient le volume. Si vous ressentez une gêne auditive, arrêtez d'utiliser le micro-casque et consultez un médecin. Pour protéger votre audition, voici ce que des experts en matière d'audition recommandent :

1. Réglez le volume à bas niveau avant de placer le micro-casque sur vos oreilles et utilisez-le au volume le plus bas possible.
2. Évitez d'augmenter le volume pour vous isoler des bruits environnants. Utilisez de préférence le micro-casque dans un endroit tranquille, sans trop de bruits de fond.
3. Utilisez à volume élevé le moins longtemps possible.
4. Baissez le volume si le son provenant du micro-casque vous empêche d'entendre les personnes qui parlent autour de vous. Pour obtenir de plus amples renseignements sur les micro-casques et l'audition, consultez le site plantronics.com/healthandsafety.

⚠ Avertissements relatifs au chargeur

- Utilisez uniquement le chargeur fourni par Plantronics pour charger le produit. N'utilisez le chargeur à aucune autre fin. Assurez-vous que la tension nominale correspond à l'alimentation que vous voulez utiliser, par exemple 100-240 V; 50/60 Hz; 0,2 A.
- Chargez le micro-casque selon les instructions fournies avec l'appareil.
- Branchez l'adaptateur ou le chargeur c.a. dans une prise suffisamment près et facilement accessible.
- Ne rangez ou n'utilisez jamais le produit dans un endroit où la température pourrait tomber sous 0 °C.

⚠ Pile du micro-casque – Avertissements

Pour éviter les risques d'explosion, d'incendie ou de fuite de produits chimiques toxiques, tenez compte des avertissements suivants :

- Ne jetez pas le produit au feu et ne l'exposez pas à une chaleur excédant 40 °C (104 °F).
- Ne tentez pas d'ouvrir ou de perforez la pile. Elle peut contenir des matières corrosives toxiques pouvant causer des blessures aux yeux et à la peau.
- Gardez toujours les piles hors de portée des enfants.
- Si votre micro-casque est doté d'une pile remplaçable, utilisez uniquement la pile livrée avec le produit. Retirez rapidement la pile lorsqu'elle est usée.
- Évitez tout contact entre une pile ou un porte-pile et des objets métalliques, tels que des clés ou de la monnaie.

RECYCLAGE : Le micro-casque et les piles doivent être recyclés ou éliminés de la façon appropriée. Communiquez avec le centre de recyclage de votre région afin de mettre votre micro-casque au rebut de façon appropriée.

Exposure to RF Radiation

The internal wireless radio operates within the guidelines found in radio frequency safety standards and recommendations, which reflect the consensus of the scientific community. Independent studies have shown that the internal wireless radio is safe for use by consumers. Visit plantronics.com for more information.

In order to comply with IC RF Exposure requirements, the base must be installed and operated such that a minimum separation distance of 20 cm is maintained between the base and all persons during normal operation. The headset complies with FCC radiation limits set forth for an uncontrolled environment.

NOTE Modifications not expressly approved by Plantronics, Inc. could void the user's authority to operate the equipment.

Industry Canada Regulatory Information

This product meets the applicable Industry Canada technical specifications/Le présent matériel est conforme aux spécifications techniques applicable d'Industrie Canada.

This Class B digital apparatus complies with Canadian ICES-003. Operation is subject to the following two conditions: (1) this device may not cause interference, and (2) this device must accept any interference, including interference that may cause undesired operation of the device.

Cet appareil numérique de la classe B est conforme à la norme NMB-003 du Canada.

Le présent appareil est conforme aux CNR d'Industrie Canada applicables aux appareils radio exempts de licence.

L'exploitation est autorisée aux deux conditions suivantes : (1) l'appareil ne doit pas produire de brouillage, et (2) l'utilisateur de l'appareil doit accepter tout brouillage radioélectrique subi, même si le brouillage est susceptible d'en compromettre le fonctionnement.

Exposure to RF Radiation

Cet équipement est conforme aux limites d'exposition de radiation IC énoncées pour un environnement non contrôlé.