

# PA50 Wireless Mic

## Getting Started

Refer to the safety instructions at the end of this guide prior to installation or use. For the full User Guide, visit [www.plantronics.com/calisto800](http://www.plantronics.com/calisto800)

The PA50 wireless mic is designed for use with the Calisto 800 series of multi-device speakerphones. The wireless mic provides unparalleled freedom of movement and optimal voice transmission.

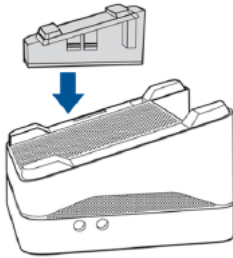

### 1: Setup

⚠️ Disconnect all cables from the Calisto base. Insert wireless mic docking station firmly into the slots at the bottom of the base.

Reconnect all cables. Place the wireless mic in the docking station and charge it for a minimum of 2 hours or until the Calisto screen indicates the mic is fully charged.

### 2: Pairing

Once the wireless mic is fully charged, on the Calisto speakerphone, go in **Menu > Settings > Bluetooth Setup** and select “Headset (or Wireless Mic)” and then “Pair New Headset”.

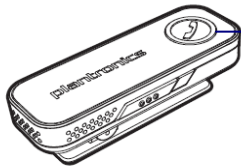

Put the wireless mic in pairing mode by pressing the  button for 6 seconds or until the light flashes red/green.

Press “Next” to prompt Calisto to search for it.

Follow the instructions on screen to complete pairing. Once it is paired, the wireless mic is connected.

### 3: Wearing and Use

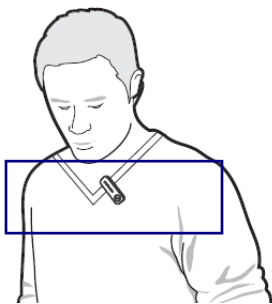

The wireless mic can be worn on a collar or lapel, see diagram for optimal location.

The wireless mic can also be placed flat on a table for flexible small group conferencing. It provides 360- degree microphone coverage.

Talk Time: Up to 7 hours

Maximum range: Up to 45 feet/12 meters

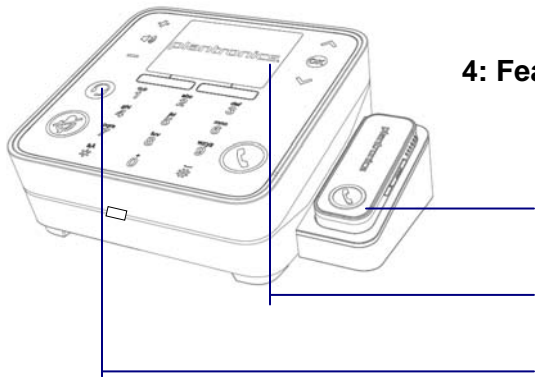

#### 4: Features

Once undocked, press the  key on the wireless mic to replace the built-in speakerphone microphone.

When the wireless mic is active, the  is displayed on screen and the built-in speakerphone microphone is turned off.

To transfer a call from the wireless mic to the speakerphone and back, press  on the speakerphone.

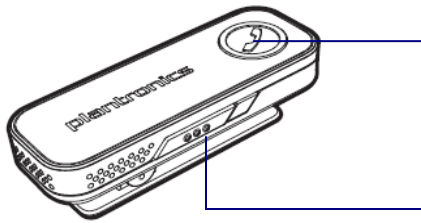

Talk/End button: Press with one tap to answer or end a call. The key is green when you have an incoming call, red when you are on a call.

Mute/Unmute buttons: press red button on both sides. The buttons light red when a call is muted.

## Warranty

Warranty: Plantronics offers a two (2) year limited warranty. For full warranty details, conditions and technical assistance, please visit our website: [www.plantronics.com/support](http://www.plantronics.com/support)

## Safety Instructions

Please read the following safety and operational instructions before using your Calisto phone system. Please keep these instructions for your reference. When using this product, these basic safety precautions and warnings should be followed to reduce the risk of fire, electric shock, injury to persons and damage to property.

/!\ This symbol identifies and alerts the user to the presence of important safety warnings.

Operating, storage and charging temperature is 0°C to 40°C (32°F to 104°F).

### /!\ Warnings

- Observe all signs and instructions regarding the use of an electrical device or RF radio product in designated areas, such as gas/refueling stations, hospitals, blasting areas, potentially explosive atmospheres, or aircraft.
- Do not insert anything into the product because this may cause damage to the internal components or cause injury to you.
- Avoid contact with liquids. Do not locate this product near water, for example, near a bathtub, or sink, in a wet basement, or near a swimming pool.
- Use only those Plantronics products and accessories designed for use with this product.
- CHILDREN. Never allow children to play with the product—small parts may be a choking hazard.
- If you experience a skin irritation after using this product, discontinue use and contact Plantronics.

### /!\ Wireless Microphone Charging/Battery Warnings (PA50)

- Use only the charging base supplied by Plantronics to charge the microphone. Do not use the charger for any other purpose.
- Charge the microphone according to the instructions supplied with the unit.
- Never store or use the product or charge the battery where the temperature may fall below 0°C (32°F) or rise above 40°C (104°F).
- To avoid the risk of explosion, fire or leakage of toxic chemicals, please observe the following warnings:
  - Do not dispose of the product or battery in a fire or heat above 40°C (104°F).
  - This product has an embedded, non-replaceable battery, designed to last the life time of the product. Do not attempt to open the product or remove the battery as this may cause injury to you or damage the product. Please contact the local recycling facility for removal of the battery.
  - Do not open, deform or mutilate the battery. There may be corrosive materials which can cause damage to eyes or skin and may be toxic if swallowed.

RECYCLING: This product must be recycled or disposed of properly. Contact your local recycling center for proper disposal instructions

## **FCC Requirements Part 15**

Note: This equipment has been tested and found to comply with the limits for a Class B digital device, pursuant to part 15 of the FCC Rules. These limits are designed to provide reasonable protection against harmful interference in a residential installation. This equipment generates, uses, and can radiate radio frequency energy and, if not installed and used in accordance with the instructions, may cause harmful interference to radio communications. However, there is no guarantee that interference will not occur in a particular installation. If this equipment does cause harmful interference to radio or television reception, which can be determined by turning the equipment off and on, the user is encouraged to try to correct the interference by one or more of the following measures:

1. Reorient or relocate the receiving antenna.
2. Increase the separation between the equipment and receiver.
3. Connect the equipment into an outlet on another circuit.
4. Consult the dealer or an experienced radio/TV technician for help.

### **Exposure to RF Radiation**

The internal wireless radio operates within the guidelines found in radio frequency safety standards and recommendations, which reflect the consensus of the scientific community. Independent studies have shown that the internal wireless radio is safe for use by consumers. Visit [plantronics.com](http://plantronics.com) for more information.

The Microphone Clip complies with FCC radiation exposure limits set forth for an uncontrolled environment.

NOTE: Modifications not expressly approved by Plantronics, Inc. could void the user's authority to operate the equipment.

### **Industry Canada Regulatory Information**

This product meets the applicable Industry Canada technical specifications/Le présent matériel est conforme aux spécifications techniques applicables d'Industrie Canada.

This Class B digital apparatus complies with Canadian ICES-003.  
Cet appareil numérique de la classe B est conforme à la norme NMB-003 du Canada.