



# Savi™ Go WO101/B Optimized for Microsoft Office Communicator 2007® Professional Wireless Headset System

User Guide



## Welcome

Congratulations on purchasing your new Plantronics product. This guide contains instructions for setting up and using your Savi Go professional wireless headset system.

# Contents

## 1 Package Contents and Features

- 1.1 USB Adapter..... 4
- 1.2 Headset ..... 4

## 2 Set Up ..... 6

- 2.1 Connecting USB Adaptor to PC..... 6
- 2.2 Connecting Power Supply to  
Charger Base ..... 6
- 2.3 Fitting Headset ..... 7
- 2.4 Docking and Charging Headset..... 7

## 3 Test Call ..... 8

- 3.1 Making a Test Call Using Microsoft  
Office Communicator..... 8

## 4 Using Your Headset System with Microsoft Office Communicator ..... 9

- Powering Headset On/Off..... 9
- Placing, Answering and Ending Calls with  
Microsoft Office Communicator ..... 9
- Muting a Headset Call ..... 10
- USB Adapter Indicator Light..... 10
- Headset Indicator Lights and Tones ..... 10
- Out of Range Warning ..... 11
- Low Battery Warning ..... 11
- Checking Battery Level..... 11
- Turning Headset Indicator Blue Flash On/Off ..... 11
- Mute Warning ..... 11
- Pairing Headset to USB Adapter ..... 11

## 5 Using Your Headset with Your Bluetooth Mobile Phone..... 12

- Pairing Your Headset to Your Bluetooth  
Mobile Phone..... 12
- Placing, Answering and Ending Calls  
with Your Headset and Bluetooth Mobile Phone..... 12

## Troubleshooting and Common Questions..... 13

# 1 Package Contents and Features

## 1.1 Savi Go USB Adapter and Charger

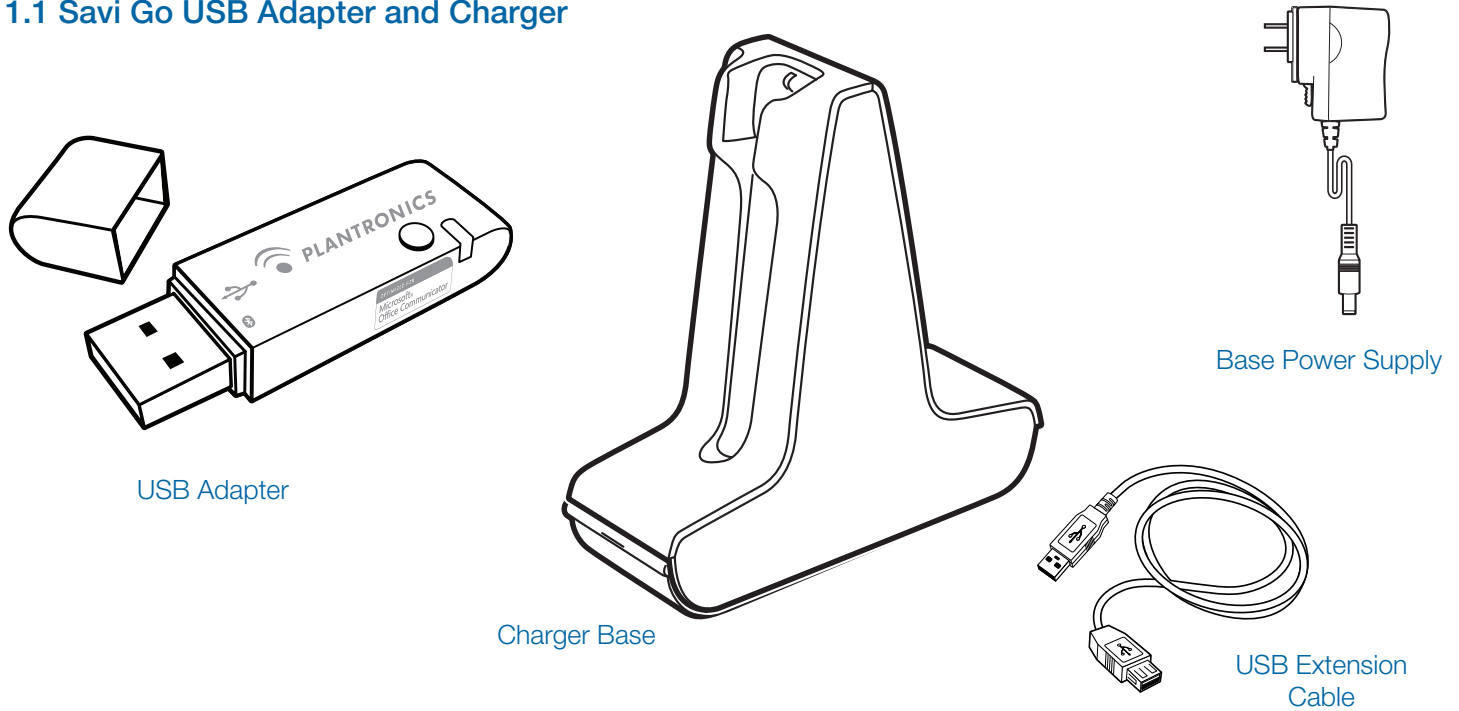

USB Adapter

Charger Base

Base Power Supply

USB Extension Cable

## 1.2 Savi Go (check model number) Headset

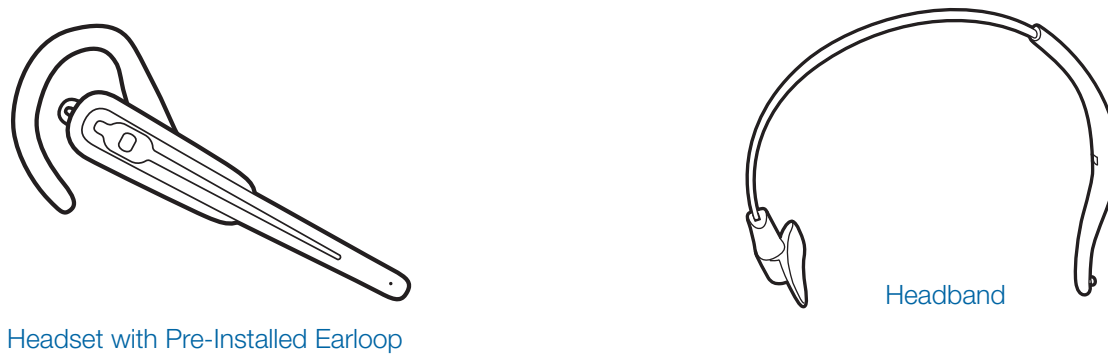

Headset with Pre-Installed Earloop

Headband

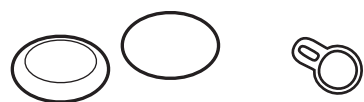

Foam Ear Cushions

Extra Ear Tab

---

## Savi Go USB Adapter Features

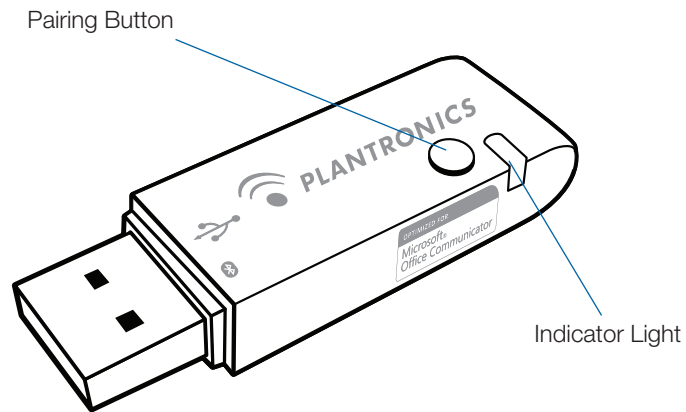

---

## Savi Go (check model number) Headset Features

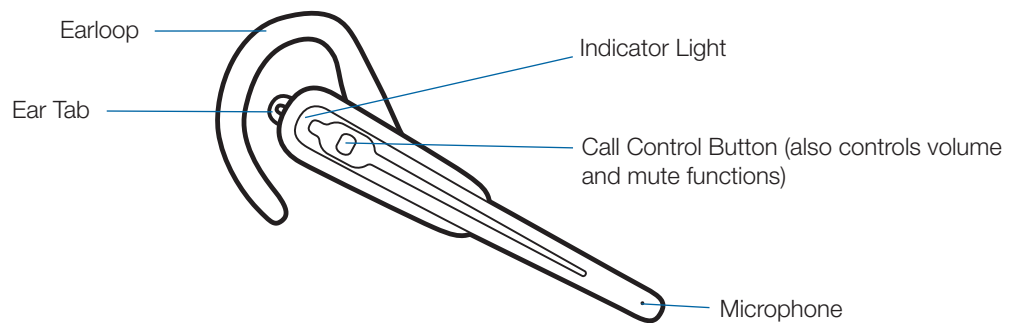

# 2 Set Up

## 2.1 Connecting USB Adapter to PC

**1 Insert the USB adapter into USB Port on PC.** The indicator light on the base will be solid red to indicate the USB adapter is powered on.

**NOTE** If the USB port is hard to access, use the provided USB extension cable.

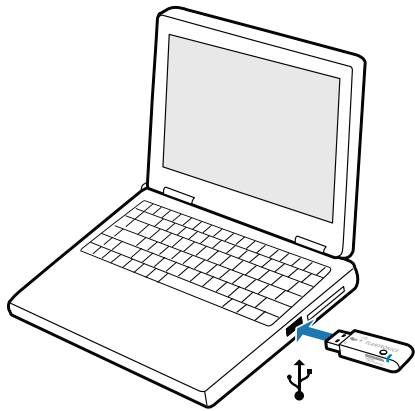

## 2.2 Connecting Power Supply to Charger Base

**1 Connect the base power supply into the power jack on the charger base.**

**2 Connect the power supply to the outlet.** The power indicator light will be solid green.

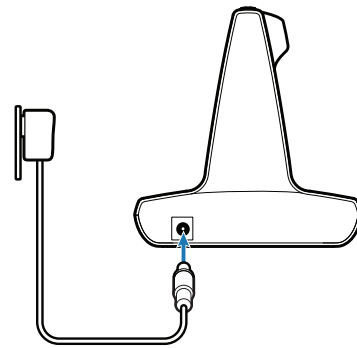

**IMPORTANT NOTE** For best performance it is recommended that Windows is updated with Service Pack levels listed below:

Microsoft Windows® XP-Service Pack 3 (SP3) or later

Microsoft Windows Vista®-Service Pack 1 (SP1) or later

## 2.3 Fitting Headset

The headset comes with a pre-installed earloop and ear tab. An optional headband is also provided.

- 1 To install the headband, gently unsnap the pre-installed earloop from the headset.**
- 2 Snap the headband into the headset.** The headband can be adjusted to fit.
- 3 For either wearing option rotate the headset until the microphone is pointed toward your mouth.**
- 4 The headset can be converted for wearing on the left or right ear with both earloop and headband.**

- 5 The ear tab has been designed to maximize stability of the headset. It can be rotated on the headset to optimize its fit and comfort in the ear. If desired, the ear tab can be removed by pulling tab from the headset.**

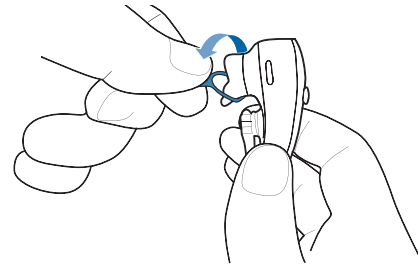

## 2.4 Docking and Charging Headset

- 1 Gently push the headset into the charge cradle.**  
The indicator light on the headset will be solid red to indicate that the headset battery is charging
- 2 Charge for at least 20 minutes prior to the first use.**  
A full charge takes 3 hours.

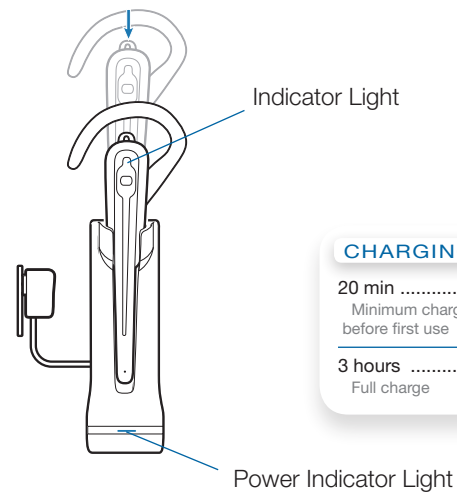
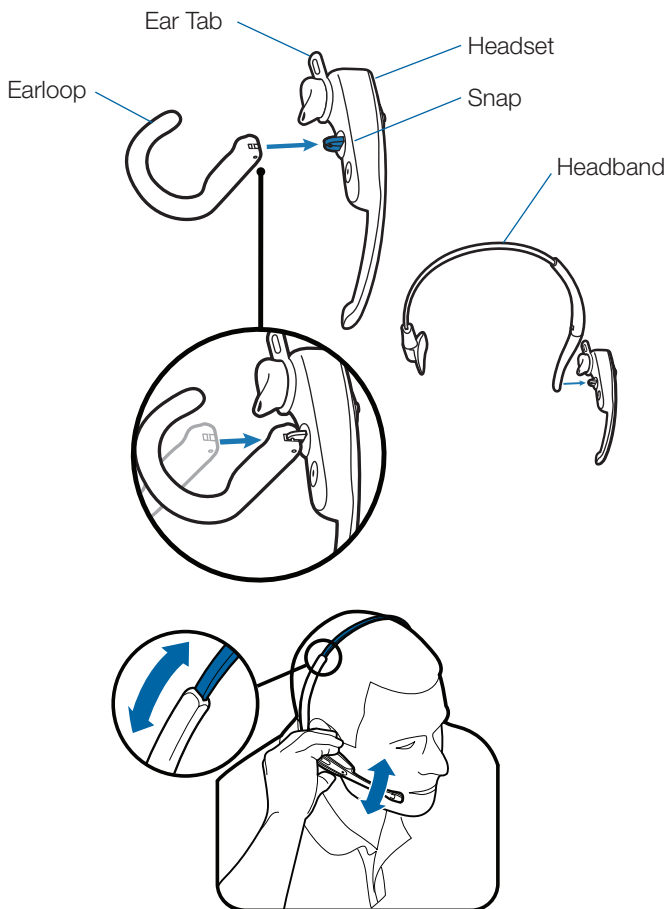

### CHARGING TIME

20 min .....	
Minimum charge before first use	
3 hours .....	
Full charge	

# 3 Test Call

## 3.1 Making a Test Call Using Microsoft Office Communicator

- 1** Ensure Microsoft Office Communicator is running on your PC.
- 2** Set the headset and microphone volume to a comfortable level using the Microsoft Office Communicator “Set up Audio and Video” page\*.
- 3** Place a test call using Microsoft Office Communicator.
- 4** Adjust the receive and listen volume to comfortable levels using the volume control in the “Conversation Window”\*.
- 5** You can also fine tune the listening volume on the headset by pushing the call control button up to increase the volume and pushing down to decrease the volume.

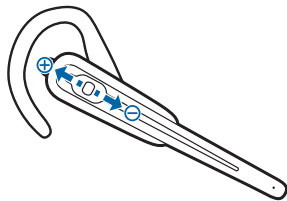

**NOTE** Do not press the call control button in when adjusting the volume otherwise the call can be ended accidentally.

- 6. To end the test call, press the call control button on the headset**

\* Consult Microsoft Office Communicator Help for more information.



## 4 Using Your Headset System with Microsoft Office Communicator

 For your safety, do not use headset at high volumes for extended periods of time. Doing so can cause hearing loss. Always listen at moderate levels. For more information on headsets and hearing visit: [www.plantronics.com/healthandsafety](http://www.plantronics.com/healthandsafety).

### Powering Headset On/Off

The headset will be ready to use once it has been charged in the charger base as described in [Section 2.5. Docking and Charging the Headset](#)

To conserve power you may optionally power the headset off, by pressing and holding the call control button for six seconds. The headset indicator light will be lit red for four seconds to confirm that the headset is powered off. Note once powered off you will not be able to use the headset.

To power the headset back on press and hold the call control button for four seconds when the headset indicator will light blue for two seconds, then flash red a number of times to indicate the remaining battery charge (see [Checking the Battery Level](#)).

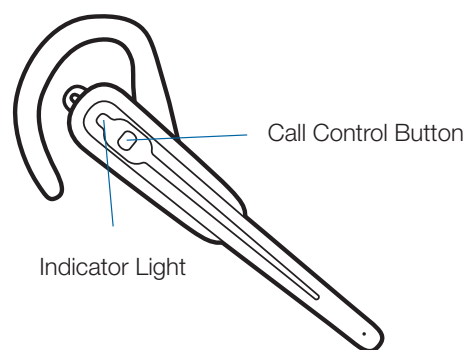

### Placing, Answering, and Ending Calls with Microsoft Office Communicator

To place a call	Dial number using Microsoft Office Communicator*
To answer a call on the headset	Short press call control button on headset
To answer a call when already on an active call on your mobile phone	Short press the call control button once to end the mobile phone call then press again to answer your Microsoft Office Communicator call
To end a call on the headset	Short press call control button on headset

\*Consult Microsoft Office Communicator Help for more information on how to place a call.

**NOTE** You can also answer calls directly from Microsoft Office Communicator by clicking on the Call Alert that appears on your PC screen. In this case the call will be directed to the default speakerphone which may not be your headset. Consult Microsoft Office Communicator Help for more information.

## Muting a Headset Call

To mute a call, press and hold the call control button down (in the volume down position) for two seconds. You will hear a low/high tone pair indicating the mute is activated.

To unmute a call, push and hold the call control button down (in the volume down position) for two seconds. You will hear a high/low tone pair indicating the mute is deactivated.

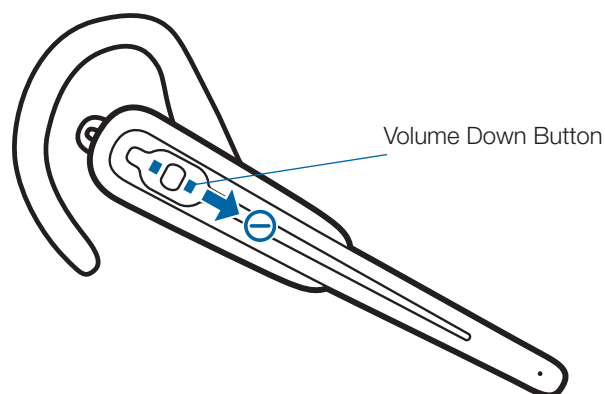

## USB Adapter Indicator Light

USB Adapter Status	Indicator Light
Headset in talk mode	Solid blue
Base and headset pairing	Flashes red and blue

## Headset Indicator Lights and Tones

Headset Status	Headset Indicator Light
Headset charging	Solid red
Headset fully charged	Off
Headset battery low	Flashes double red
Headset ready	Slow blue flash (every 10 sec.)
Incoming call	Flashes purple
Active call	Fast blue flash (every 2 sec.)

## Out of Range Warning

If you are on a call you will hear the audio degrade as you move out of range.

If you stay out of range, active calls will be suspended. Calls will be re-established upon walking back into range.

## Low Battery Warning

A repeating high/low tone pair every 10 seconds indicates the battery is low. You should recharge the headset immediately.

## Checking Battery Level

You can check the battery level by moving the call control button to the volume down position, then pressing inwards and holding for two seconds. The headset indicator will flash red to indicate the remaining battery charge level.

One red flash = low charge level

Two red flashes = medium charge level

Three red flashes = high charge level

## Turning Headset Indicator Blue Flash On/Off

By default the headset indicator flashes blue to indicate the headset state as described in the section [Headset Indicator Lights and Tones](#). This feature may be disabled by moving the call control button to the volume up position, then pressing inwards and holding for two seconds. The headset indicator will show a short burst of blue flashes.

Repeat this operation to turn the headset blue flashing indicator back on.

## Mute Warning

When mute is activated, you will hear a single low tone which will repeat every 30 seconds.

## Pairing Headset to USB Adapter

The headset and base unit are supplied paired to each other. However, if you wish to use a replacement headset with your existing USB adapter, the units can be paired to each other by the following method:

- 1 Ensure your replacement headset is fully charged.**
- 2 Power the headset off by pressing and holding the call control button for six seconds.** The headset indicator light will be red for four seconds.
- 3 Place the headset in pairing mode by pressing and holding the call control button until the indicator light flashes red and blue.**
- 4 Place the USB adapter in pairing mode by pressing and holding the pairing button on the adapter for two seconds.** The pairing light will flash red and blue.
- 5 When the pairing light on the USB adapter goes solid blue, the headset and the USB adapter are paired.**

**NOTE** Take caution pairing the USB adapter. Do not press hard. Please “press” with both fingers rather than push on the USB adapter to avoid damage to the USB adapter or USB port.

# 5 Using Your Headset with your Bluetooth Mobile Phone

## Pairing your Headset to your Bluetooth Mobile Phone

- 1 Turn on your mobile phone and enable Bluetooth. For most phones select Settings>Tools>Connections>Bluetooth>On.** See your phones user guide for more information.
- 2 Power the headset off by pressing and holding the call control button for six seconds.** The headset indicator light will be red for four seconds.
- 3 Press and hold the headset call control button for six seconds or until the red and blue indicator lights flash alternately.**

**NOTE** The headset will stay in pairing mode for two minutes.

- 4 Use the commands on your phone to locate the headset. For most phones select Settings>Tools>Connections>Bluetooth>Search>Savi Go WH100.** See your phones user guide for more information.

- 5 When prompted for a passkey, enter 0000 (4 zeros).** The headset indicator light will flash blue when paired successfully.

**NOTE** For detailed pairing instructions for popular mobile phones visit: [www.plantronics.com/easytopair](http://www.plantronics.com/easytopair).

## Placing, Answering, and Ending Calls with your Headset and Bluetooth Mobile Phone

To place a call	Dial number on your mobile phone keypad
To answer a call	Short press call control button.
To answer a call when already on an active Microsoft Office Communicator call	Short press the call control button to end the Microsoft Office Communicator call, then press again to answer your mobile phone call
To end a call	Short press call control button.
Redial last number*	Double tap call control button. There will be a high tone on each press. A final tone indicates the last number has been redialed.
Activate voice dialing*	Press and hold call control button for two seconds. First tone on key press start followed by a second tone which indicates voice dial is activated.
Reject a call	Press and hold call control button until you hear two tones.
Transfer a call from your mobile phone to your headset	Press and hold call control button for two seconds until you hear a long tone.
Transfer a call from your headset to your mobile phone	Press and hold call control button for two seconds until you hear a long tone.

\* Only available on mobile phones and carriers that support these features.

# Troubleshooting and Common Questions

## Troubleshooting — Microsoft Office Communicator Usage

---

<a href="#">My headset doesn't work with Microsoft Office Communicator.</a>	<p>Make sure your headset is charged.</p> <p>Make sure your headset is on and connected.</p> <p>Press the call control button on your headset.</p> <p>Fine tune the listening volume with the call control button.</p> <p>If the volume is still too low, adjust the listening volume on the PC using Microsoft Office Communicator*.</p>
<a href="#">The sound is distorted or I hear an echo in the headset.</a>	<p>Reduce speaking volume on the PC using Microsoft Office Communicator*.</p> <p>Point microphone towards your chin.</p> <p>If the distortion is still present, lower the volume using the call control button.</p>
<a href="#">While on an Microsoft Office Communicator call I want to accept a call from my mobile phone</a>	<p>Press the call control button for less than 1 second (this will disconnect the Microsoft Office Communicator call.) Press the call control button again to connect with your mobile phone.</p>
<a href="#">People I talk to can hear a buzz in the background.</a>	<p>The charger base is plugged into a power strip. Plug the charger into the wall directly.</p>
<a href="#">Reconnecting the Bluetooth link between your headset and your PC</a>	<p>If you turn on the headset beyond Bluetooth range, and then return within it, you will need to reestablish the Bluetooth link by pressing the call control button.</p>
<a href="#">Talk time performance is significantly degraded even after a full recharge.</a>	<p>Battery is wearing out. Call Plantronics for factory service information. Contact information is provided at the back of the user guide.</p>

---

\* Consult Microsoft Office Communicator Help for more information

## Troubleshooting — Mobile Phone Usage

---

My headset does not work with my phone.

Make sure the headset is fully charged.  
Make sure headset is paired with the Bluetooth phone you are trying to use.  
See “Pairing Your Headset to your Mobile Phone” on page 12.

---

My phone did not locate the headset.

Turn both your phone and headset off and on, and then repeat the pairing process on page 12.

---

I could not enter my PIN code.

Turn both your phone and headset off and on, and then repeat the pairing process on page 12.  
Your PIN code, or Passkey, is 0000.

---

I cannot hear caller/dial tone.

The headset is not turned on. Press the call control button for approximately 2 seconds until you hear a tone or see the indicator glow blue.  
Your headset is out of range. Move the headset closer to the Bluetooth phone.  
Your headset battery is drained. Charge your battery. See “Docking and Charging Your Headset” on page 7.  
The listening volume is too low. Incremental tapping of the call control button will adjust volume.  
Make sure that the headset fits properly. See “Fitting Headset” on page 7.

---

Audio quality is poor.

Make sure that headset is sitting correctly in ear with boom pointing towards corner of mouth.  
See “Fitting the Headset” on page 7.

---

Callers cannot hear me.

Your headset is out of range. Move the headset closer to the Bluetooth phone.

---

My headset falls off my ear.

Make sure that Headset is sitting correctly on your ear with boom pointing towards corner of mouth.  
See “Fitting the Headset” on page 7.

---



## FCC Part 15 Regulatory Information

### DECLARATION OF CONFORMITY

We Plantronics, 345 Encinal Street, Santa Cruz, California, 95060 USA (800) 544-4660, declare under our sole responsibility that the product BUA 200 complies with Part 15 of the FCC Rules. Operation is subject to the following two conditions: (1) this device may not cause harmful interference, and (2) this device must accept any interference received, including interference that may cause undesired operation.

Note: This equipment has been tested and found to comply with the limits for a Class B digital device, pursuant to part 15 of the FCC Rules. These limits are designed to provide reasonable protection against harmful interference in a residential installation. This equipment generates, uses, and can radiate radio frequency energy and, if not installed and used in accordance with the instructions, may cause harmful interference to radio communications. However, there is no guarantee that interference will not occur in a particular installation. If this equipment does cause harmful interference to radio or television reception, which can be determined by turning the equipment off and on, the user is encouraged to try to correct the interference by one or more of the following measures:

- Reorient or relocate the receiving antenna.
- Increase the separation between the equipment and receiver.
- Connect the equipment into an outlet on a circuit different from that to which the receiver is connected.
- Consult the dealer or an experienced radio/TV technician for help.

This equipment complies with FCC radiation exposure limits set forth for an uncontrolled environment. Changes or modifications not expressly approved by the party responsible for compliance could void the user's authority to operate the equipment.

## Industry Canada Regulatory Information

This Class B digital apparatus complies with Canadian ICES-003.

Cet appareil numérique de la classe B est conforme à la norme NMB-003 du Canada.

## Support

For support please contact your Plantronics Authorized Resellers.

Plantronics, Inc.  
345 Encinal Street  
Santa Cruz, CA 95060  
United States  
Tel: 800-544-4660  
[www.plantronics.com](http://www.plantronics.com)



© 2008 Plantronics, Inc. All rights reserved. Plantronics, the logo design, HL10, PerSono Suite and Plantronics Savi, are trademarks or registered trademarks of Plantronics, Inc. All other trademarks are the property of their respective owners.

Patents U.S. 5,210,791; 6,735,453; 6,923,688; 7,075,270; D469,756; D512,984; D517,519; D519,498; D521,492; D523,412; Australia 147229; 303053; 303054; China ZL200530008543.X; ZL200530008542.5; EM 293964-0003; 293964-0004-0006; France 651,857-651,865; Germany 40108524.4; GB Regd.Des.No. 2104923; Taiwan D112594 and Patents Pending.

XXXXX-XX (12.08)