

User Guide

**CLARITY**<sup>®</sup>  
Professional

**XLC3.4**<sup>™</sup>  
CORDLESS

**Extra Loud Cordless  
Speakerphone with  
Caller ID**

**CLARITY**<sup>®</sup>  
Professional

Clarity, a Division of Plantronics, Inc.  
4289 Bonny Oaks Drive, Chattanooga, TN 37406  
Tel: 800-426-3738 Fax: 800-325-8871  
E-mail: claritycs@plantronics.com Website: www.clarityproducts.com

©2010 Clarity, a Division of Plantronics, Inc. All rights reserved.  
Clarity, Clarity Professional, XLC3.4, Digital Clarity Power and  
the amplified figure are trademarks or registered trademarks of  
Plantronics, Inc.  
Rev. A (09-10)

**PRINTED IN CHINA**

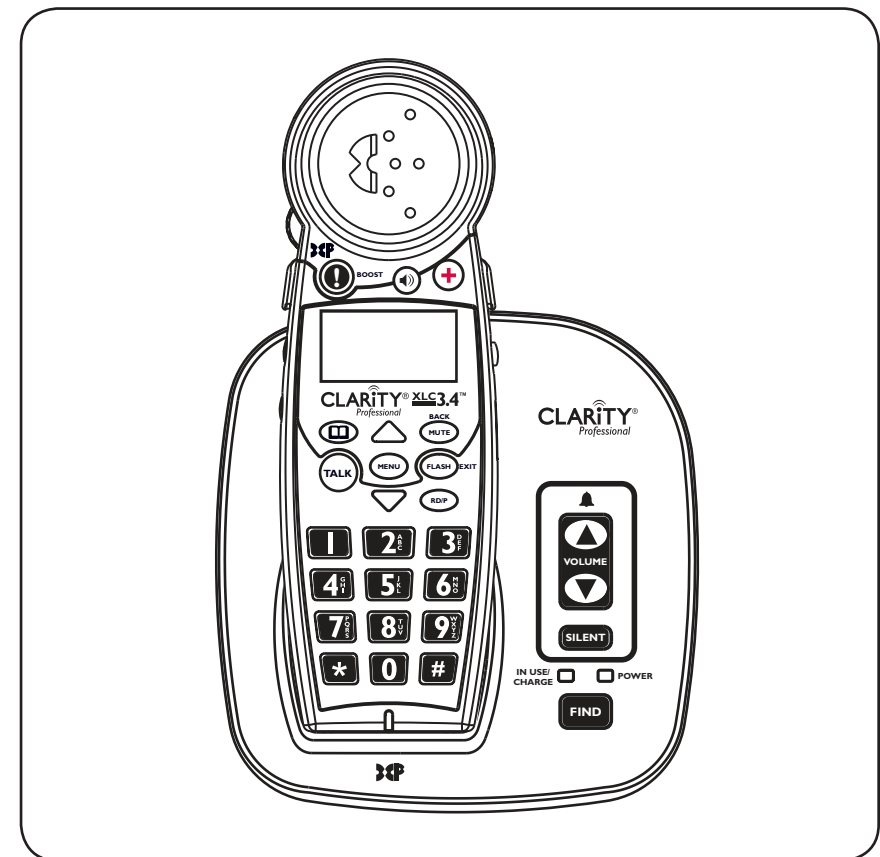

## **XLC3.4 TABLE OF CONTENTS**

<b>IMPORTANT SAFETY INSTRUCTIONS</b>	<b>2</b>
<b>CONTENTS &amp; PARTS CHECKLIST</b>	<b>5</b>
<b>INSTALLATION</b>	<b>6</b>
<b>WALL MOUNTING YOUR XLC3.4</b>	<b>8</b>
<b>BASE - Quick Reference Guide</b>	<b>10</b>
<b>HANDSET - Quick Reference Guide</b>	<b>11</b>
<b>BATTERY INFORMATION</b>	<b>14</b>
<b>PLACING &amp; ANSWERING CALLS</b>	<b>15</b>
<b>VOLUME &amp; TONE ADJUSTMENTS</b>	<b>16</b>
<b>CALLER ID FUNCTION</b>	<b>16</b>
<b>PHONEBOOK</b>	<b>17</b>
<b>SCREEN DETAILS</b>	<b>17</b>
<b>TELEPHONE MENU</b>	<b>19</b>
<b>HANDSET REGISTRATION</b>	<b>28</b>
<b>TROUBLESHOOTING</b>	<b>29</b>
<b>TECHNICAL SPECIFICATIONS</b>	<b>32</b>
<b>REGULATORY COMPLIANCE</b>	<b>33</b>
<b>WARRANTY INFORMATION</b>	<b>36</b>

**XLC3.4 IMPORTANT SAFETY INSTRUCTIONS**

When using your telephone equipment, basic safety precautions should always be followed to reduce the risk of fire, electric shock and injury to persons, including the following:

1. Read and understand all instructions.
2. Follow all warnings and instructions marked on the telephone.
3. Avoid contact with liquids. Do not locate base unit or handset near water, for example, near a bathtub, wash basin, sink or laundry tub, in a wet basement or near a swimming pool.
4. Avoid using a telephone (other than a cordless type) during a storm. There may be a remote risk of electrical shock from lightning.
5. Do not use the telephone to report a gas leak in the vicinity of the leak.
6. Unplug this telephone from the wall outlets before cleaning. Do not use liquid cleaners or aerosol cleaners on the telephone. Use a damp cloth for cleaning.
7. Place this telephone on a stable surface. Serious damage and/or injury may result if the telephone falls.
8. Do not cover the slots and openings on this telephone. This telephone should never be placed

near or over a radiator or heat register. This telephone should not be placed in a built-in installation unless proper ventilation is provided.

9. Operate this telephone using the electrical voltage as stated on the base unit or the owner's manual. If you are not sure of the voltage in your home, consult your dealer or local power company.
10. Do not allow anything to rest on the power cord or locate this product in an area where the power cord is likely to be damaged by furniture or foot traffic.
11. Do not overload wall outlets or extension cords as this can increase the risk of fire or electrical shock.
12. Never push any objects through the slots in the telephone. They can touch dangerous voltage points or short out parts that could result in a risk of fire or electrical shock. Never spill liquid of any kind on the telephone.
13. To reduce the risk of electrical shock, do not take this phone apart. Opening or removing covers may expose you to dangerous voltages or other risks. Incorrect reassembly can cause electric shock when the appliance is subsequently used.
14. Unplug this product from the wall outlet and refer servicing to the manufacturer under the following conditions: when the

**SAVE THESE INSTRUCTIONS**

**XLC3.4 IMPORTANT SAFETY INSTRUCTIONS**

- power supply cord or plug is frayed or damaged; if liquid has been spilled into the product; if the telephone has been exposed to rain or water; if the telephone has been dropped or the case has been damaged; if the telephone exhibits a distinct change in performance; if the telephone does not operate normally by following the operating instructions. Adjust only those controls that are covered by the operating instructions. Improper adjustment may require extensive work by a qualified technician to restore the telephone to normal operation if the telephone does not operate normally by following the operating instructions.
15. Never install telephone wiring during a lightning storm.
  16. Never install telephone jacks in wet locations unless the jack is specifically designed for wet locations.
  17. Never touch uninsulated telephone wires or terminals unless the telephone line has been disconnected at the network interface.
  18. Use caution when installing or modifying telephone lines.
  19. This product should be operated only from the type of power source indicated on the marking label. If you are not sure of the type of power supply to your

- home, consult your local power company.
20. Do not attempt to open the AC adapter. There are potentially dangerous voltages inside, and there are no serviceable parts.
  21. Discontinue use of product and contact Clarity if the product overheats, has a damaged cord or plug, if the product has been dropped or damaged or if the product has come into contact with liquids.
  22. Use only the AC adapter provided with this product or a replacement AC adapter provided by Clarity.
  23. This phone amplifies sound to loud volumes. To prevent hearing damage, all users of the phone should be informed of the high volume capability of the phone and children should only use the phone when supervised by an adult.
  24. Exposure to high volume sound levels or excessive sound pressure may cause temporary or permanent damage to your hearing. Although there is no single volume setting that is appropriate for everyone, you should always use your telephone with the volume set at moderate levels and avoid prolonged exposure to high volume sound levels. The louder the volume, the less time is required before your hearing could be

**SAVE THESE INSTRUCTIONS**

## XLC3.4 IMPORTANT SAFETY INSTRUCTIONS

affected. If you experience hearing discomfort, you should have your hearing checked by a doctor. To protect your hearing, you should:

A) Set the volume control in a low position and gradually increase the volume as needed. Before pressing the BOOST button, reduce the volume to the lowest level. Use the phone on the lowest volume setting as possible.

B) Limit the amount of time you use the telephone at high volume levels.

25. If you experience a skin irritation after using this product, discontinue use and contact Clarity.

## BATTERY SAFETY INSTRUCTIONS

**Dispose of used batteries according to the instructions.**

1. Do not dispose of the battery in a fire as it may explode. Check with local codes for possible special disposal instructions.
2. Do not open or mutilate the battery. Released electrolyte is corrosive and may cause damage to the eyes and skin. It may be toxic if swallowed.
3. Exercise care in handling batteries in order not to short the battery with conducting materials such as rings, bracelets and keys. The battery or conduction material may overheat and cause burns.
4. Remove batteries when they are discharged and when the equipment will not be used for an extended period of time. Dispose of batteries according to local environmental laws.
5. Do not disassemble, heat, crush, deform or puncture batteries.
6. Do not attempt to charge non-rechargeable batteries.
7. Keep batteries out of the reach of children.

**WARNING:** Risk of explosion if battery is replaced by an incorrect type.

**SAVE THESE INSTRUCTIONS**

## XLC3.4 CONTENTS & PARTS CHECKLIST

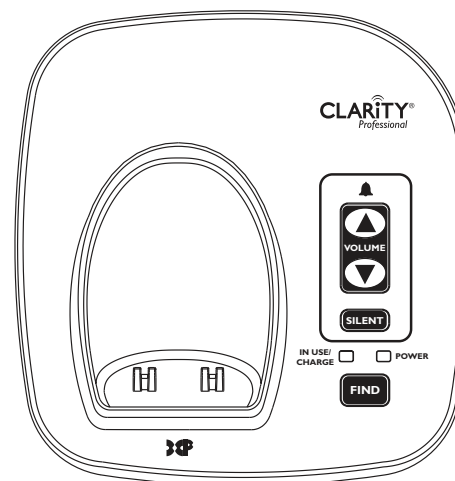

Base



Handset

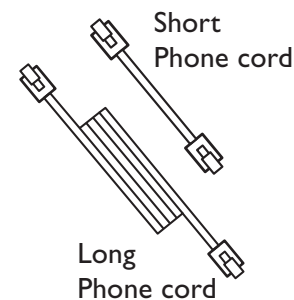

Long Phone cord

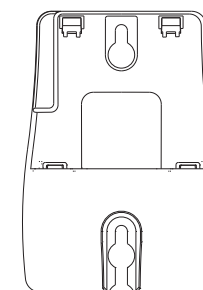

Wall mount bracket

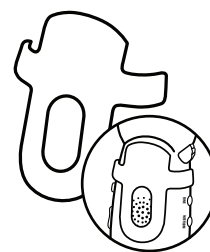

Belt clip



AC power adapter

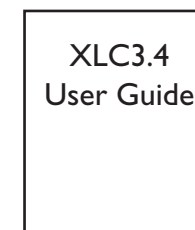

User guide

## XLC3.4 INSTALLATION

Connect your telephone as shown on the enclosed Quick Start guide.

Your telephone should arrive pre-assembled. To install it:

1. Remove base from package.
2. Hold one end of your XLC3.4's long phone line cord tightly. The correct end to hold should already be plugged into your phone's jack. Simultaneously pull the other end of the phone cord away from the phone, unraveling it and allowing you to plug that end of the cord into a wall telephone outlet.
3. Plug the loose end of the phone cord into the wall telephone outlet.
4. Hold one end of your phone's white power adapter cord tightly. The correct end to hold should already be plugged into the back of your telephone base unit. Simultaneously pull the other end of the adapter cord away from the phone, unraveling it and allowing you to plug that end of the cord into a wall electrical outlet.
3. Plug white power adapter cord on left rear of the base into a wall electrical outlet.
6. Remove handset from package.
7. Pull the handset's battery tab located on the bottom of the device in the direction of the arrow.
8. Place the handset in the base charger. The batteries in the handset must be fully charged for 10 hours before using the telephone for the first time.
9. Lift handset and press **TALK** to test. If you hear a dial tone, your telephone is ready for use. If not, check all connections again.

## XLC3.4 INSTALLATION

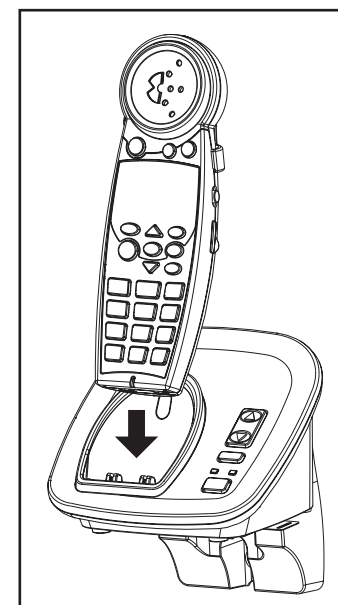
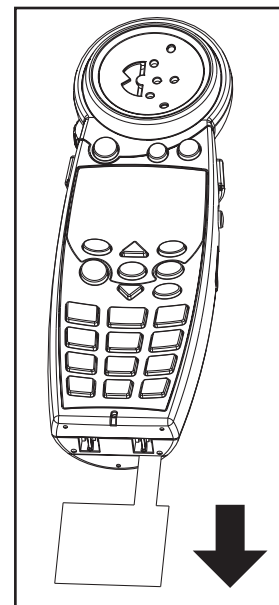
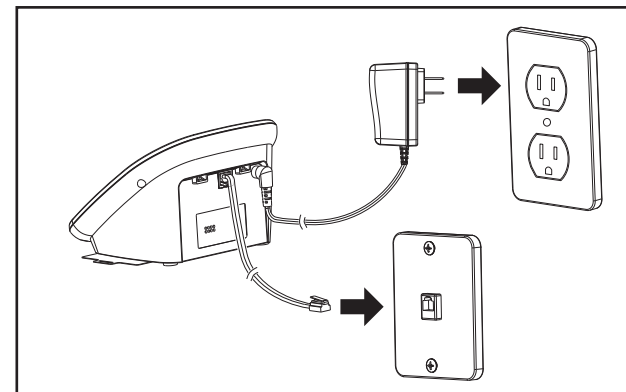
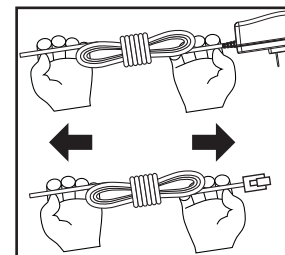

## XLC3.4 WALL MOUNTING YOUR XLC3.4

Wall mount your telephone as shown on the enclosed Quick Start guide. (This is optional.)

1. Follow the instructions in the Installation section on page 6 to remove the base and handset from the base – steps 1, 4, 6.
2. Unplug the long phone line cord from the phone jack located on the back of your XLC3.4. Plug one end of the short phone line cord into the same jack identified by LINE on the back of your base.
3. Install the XLC3.4 base onto the wall mount bracket as shown on page 9. Guide the short phone cord through the wall mount bracket as shown in the diagram.
4. Using a screwdriver, loosen the screws on your phone wall outlet (1-2 turns).
5. Plug the loose end of the short phone cord into the wall phone outlet.
6. Attach the wall mount bracket (with the XLC3.4 base) onto the wall phone outlet.
7. Plug the power adapter into a wall electrical outlet.
8. Pull the handset's battery tab located on the bottom of the device in the direction of the arrow.
9. Place the handset in the base and allow 10 hours for full charge.

## XLC3.4 WALL MOUNTING YOUR XLC3.4

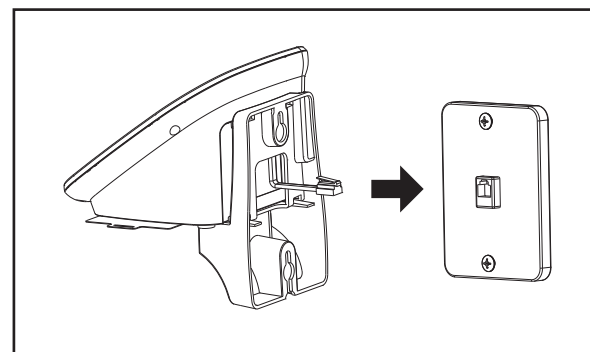
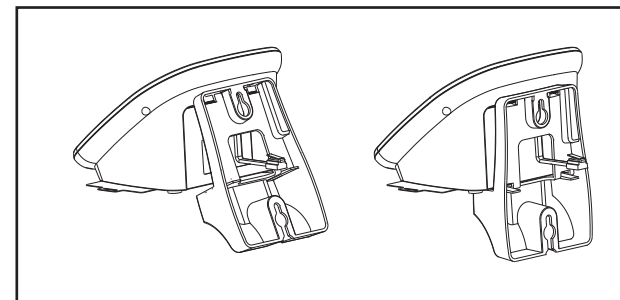
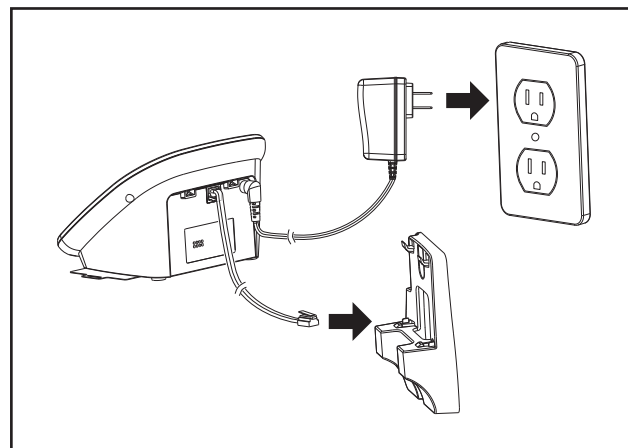

## XLC3.4 BASE - Quick Reference Guide

### 1 Visual Ringer

Lights up when phone rings; turns on when phone is in use.

### 2 IN USE / CHARGE Light

The light turns red when the phone is charging, and it turns green when the phone is in use.

### 3 POWER Light

Light is lit green when the power adapter is plugged in.

During a power outage, the POWER light will blink green once per second.

### 4 FIND

Press this key to locate handset.

### 5 SILENT

Press if you want to turn off the base ringer. The button lights up red when the ringer is turned off.

### 6 VOLUME (UP / DOWN)

Use these keys to increase or decrease the ringer volume.

### 7 RINGER STYLE

Use this key to choose the most comfortable base ring tone for your environment. There are six ring tones available.

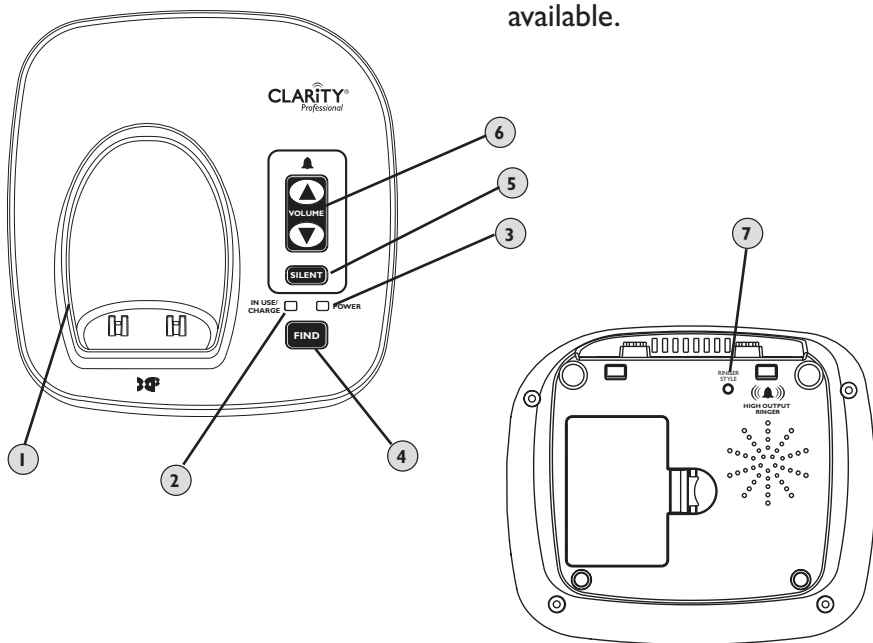

## XLC3.4 HANDSET - Quick Reference Guide

**NOTE (Base):** You can only set the ringer volume or style when the phone is not in use.

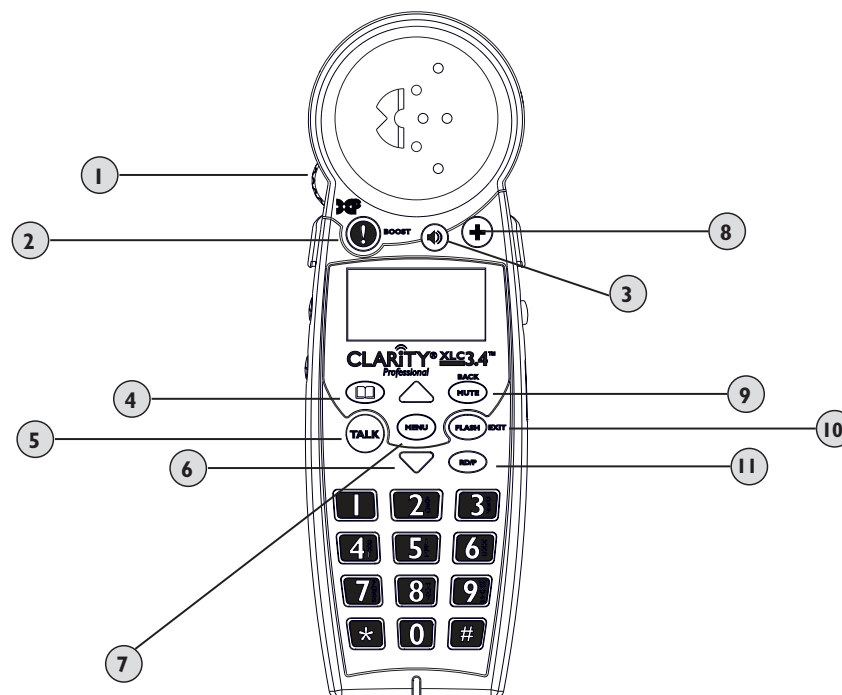

### 1 VOLUME Control Wheel

Use the rotary control to increase or decrease the volume of the incoming call. The volume level is displayed on the screen, lower right corner.

### 2 BOOST

Press this button to engage the extra amplification. The BOOST button turns red when Boost function is active.

Press and hold this button for three seconds to engage the Outgoing Speech Amplification (OSA - see page 17). When OSA is active, the screen displays "OSA On".

For more details on the Boost function, see page 16.

### 3 Speaker

During a call, press to activate handset speakerphone. Press again to switch back to earpiece.

## XLC3.4 HANDSET - Quick Reference Guide

When in speakerphone mode, the speakerphone icon is displayed on the screen (to the left of the battery icon), and the speakerphone button lights up red.

### 4 Phonebook

This button allows you to access your XLC3.4's list of saved names and numbers. See page 21.

### 5 TALK

This button allows you to make or answer phone calls. It lights up green during a call.

### 6 Arrow Buttons (UP / DOWN)

Press **UP** or **DOWN** arrows to navigate through the menus.

In standby mode, press **UP** or **DOWN** to access your Caller List.

### 7 MENU Button

Press this button to engage your phone's available options. See page 17 for details.

### 8 Help Button

Press to dial pre-programmed number.

### 9 MUTE / BACK (EDIT) Button

**Mute:** Allows you to conduct

private conversations you don't want heard (during a call).

**Back:** In MENU mode, allows you to return to the previous screen.

**(Edit):** When a phone number is displayed, allows you to toggle between 7/10/11 digit formats for the number you are viewing.

### 10 FLASH / EXIT

**FLASH:** While on a call, press **FLASH / EXIT** to receive another incoming call. (Call Waiting service is required.)

**EXIT:** In MENU mode, allows you to return to standby mode.

### 11 RD / P (Redial / Pause)

Press to redial last number dialed or insert pause (two seconds) when programming memories or pre-dialing.

### 12 Headset

A 2.5 mm headset can be used in the Headset Port. (We recommend the Plantronics MI75C headset.)

### 13 TONE

Press to select the audio tone for the handset. See page 16.

## XLC3.4 HANDSET - Quick Reference Guide

### 14 Intercom

Press to call other handset on system.

### 15 RINGER ON / OFF

Switch to turn handset ringer on or off.

### 16 NECKLOOP

A 3.5 mm neckloop can be used in the Neckloop Port. (We recommend the Clarity CE30 Neckloop.)

### 17 Belt Clip

The belt clip comes pre-attached.

### 18 Speaker Grill

### 19 Battery Compartment

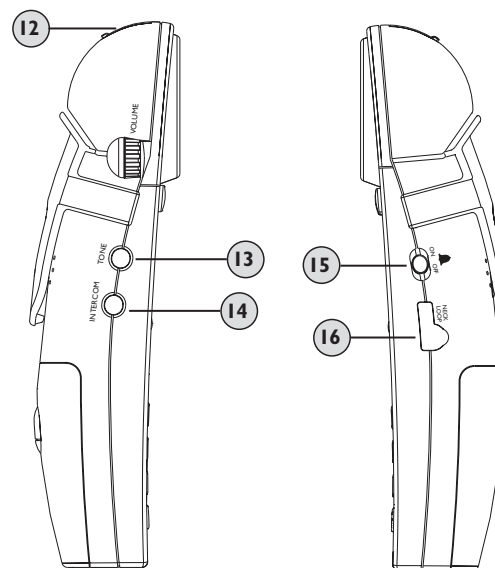
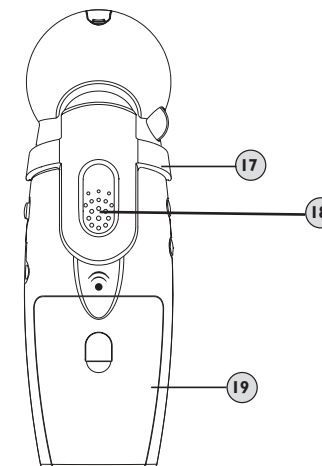



## XLC3.4 BATTERY INFORMATION

### HANDSET

The batteries in the handset must be fully charged for 10 hours before using the telephone for the first time.

**Battery life:** Talk time is 6.5 hours, while standby is 130 hours without usage. Actual times will vary depending on the amplifier settings used. Replace batteries every two years.

**Battery spec** (as supplied with your phone): 3xAAA NiMH rechargeable batteries, (1.2V 600mAh NiMH, 60AAAHC, GPI International Ltd.).

To replace batteries, remove the handset battery cover and install new batteries, then close battery cover.

### BASE (OPTIONAL)

The base batteries are optional (backup). If you choose to install backup batteries for the base, use rechargeable batteries **ONLY**. The backup batteries should be AAA, NiMH, rechargeable only, rated 600mAh. They must be fully charged for 10 hours before using the telephone for the first time.

The base backup batteries ensure the functionality of your cordless phone (3-4 hours), in case of a power outage.

When the base unit operates in battery mode (no AC power), the base POWER light will blink once every two seconds.

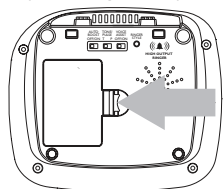

Open battery compartment door here.

To install batteries in the base:

1. Turn base over and remove memory card.
2. Open battery compartment door.
3. Install batteries according to the polarity shown inside the battery compartment.

**NOTE:** To replace handset batteries or to install base backup batteries, use **ONLY standard rechargeable AAA NiMH batteries - 600mAh.**

### LOW BATTERY INFORMATION

#### Handset

1. The battery icon on the screen shows no bars; the screen displays "Low Battery".
2. The handset beeps every two seconds in OFF HOOK mode.
3. The TALK button blinks green twice every 15 seconds in Standby mode. It will not flash an alert in OFF HOOK mode.

#### Base (if optional batteries are installed)

1. The POWER light will blink green once every five seconds.

**WARNING: Use rechargeable batteries only.  
Do NOT use alkaline batteries!**

## XLC3.4 PLACING & ANSWERING CALLS

### TO PLACE A CALL:

1. Press **TALK**, then dial the number using the numeric keypad. See lighting pattern for the TALK button on the bottom of the page.
2. Adjust the volume to the most comfortable level - using the Volume Control and BOOST button (if necessary).
3. Press the **TONE** button on the side of the handset to adjust the tonality of the incoming voice to the most comfortable level.

**WARNING: VOLUME MAY BE LOUD!**

### NOTE:

1. If the Voice Assist function is enabled, you will hear the digits of the incoming phone number.
2. Step 1 above can be replaced with one of the following options:
  - Dial from CID records: Choose a record from your Caller List (see page 17), then press **TALK**.
  - Dial from PHONEBOOK: Choose a record from your Phonebook (see page 18), then press **TALK**.
  - Pre-dial: before pressing **TALK**, dial the number you wish to call; digits will display on the screen; press **TALK** when the number is complete.

Follow with steps 2-3 above to enjoy a clear and comfortable phone conversation.

### TO ANSWER A CALL:

1. When phone is ringing, press **TALK** to answer the call.
2. Adjust the volume and tone of the incoming voice according to your preferences.
3. When finished, press **TALK** to hang up.

### NOTE:

1. For an explanation of the TALK button light, see the bottom of the page.
2. If you have CID service, note the incoming phone number displayed on your screen.
3. If the Voice Assist function is enabled, you will hear the digits of the incoming phone number.
4. At any point during the conversation, press the speakerphone button  to switch to handsfree mode. Use the volume control for adjusting the level of the incoming audio. Switch back to earpiece mode by pressing the speakerphone button again.

### Talk Button Lighting Pattern

Green: Phone is in use.

Flashing Green every 15 seconds in standby mode: Low batteries.

## XLC3.4 VOLUME & TONE ADJUSTMENTS

### Digital Clarity Power™ Technology

With Digital Clarity Power, high frequency sounds are amplified more than low frequency sounds so words are not just louder, but clearer and easier to understand. It also provides intelligent amplification to make soft sounds audible, while keeping loud sounds bearable.

### BOOST On / Off

The BOOST button controls the loudness of the receiver. Once the BOOST button is pressed, an extra level of amplification is added over the entire range of volume control.

### VOLUME Control Wheel

During a call, the dial on the side controls the level of volume for handset and speakerphone. The volume dial provides up to 16dB of volume before the BOOST button is activated. Once the BOOST button is pressed, the XLC3.4 will provide up to 50dB of amplification.

### Auto Boost

(For turning Auto Boost On or Off, see page 24.)

**ON** – When the Auto Boost is set to ON, the Boost function will be ON every time a call starts. If the phone hangs up, the Boost function will remain ON.

**OFF** – When the Auto Boost is set to OFF, the Boost function will be OFF at the beginning of all calls. Every time a call starts, the user will need to press the **BOOST** button in order to gain the extra level of amplification.

### TONE

Press the **TONE** button to change the style of amplification. Switching audio tones will change how the telephone conversation sounds to you.

The BOOST button engages the amplifier, controlling the phone's loudness. When the VOLUME dial is adjusted and the BOOST button is pressed, the phone can reach up to 50dB of gain. **WARNING: VOLUME MAY BE LOUD. PROCEED WITH CARE.**

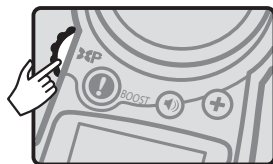
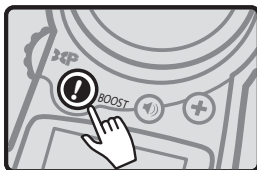

## XLC3.4 VOLUME & TONE ADJUSTMENTS

In order to achieve the best audio experience, we recommend the following:

1. Adjust the Volume Control and enable the Boost function (if needed). (Lower the volume level to minimum (VOL 0) before activating the Boost feature.)
2. Press the **TONE** button to toggle between the available tone settings.

### Outgoing Speech Amplification (OSA)

If the level of your voice is too low, while on a call press and hold the **BOOST** button -- the screen displays “OSA On” on the middle line, alternating with the tone setting.

To disable OSA, press and hold the **BOOST** button until the display shows the tone setting only.

**WARNING: Voice volume level may be loud. We recommend that you turn on this OSA function only if your voice is considered too quiet.**

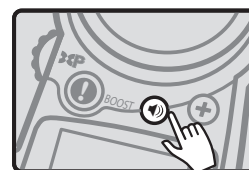

### Speakerphone

To switch to speakerphone mode, press the **SPK** button .

The display shows the speakerphone mode (see page 18).

## XLC3.4 CALLER ID FUNCTION

Your XLC3.4 is CID / CWCID compatible (optional service, purchased from your local telephone service provider).

When your phone is ringing, the screen shows the name and number of the person calling you. This information will be stored in the Caller List on your phone.

To access this list, and for further details regarding this function, press **UP** or **DOWN** in standby mode, and/or follow the instructions under CALLER LIST (page 20).

**NOTE:** If you have CID service, the date and time will automatically be set after the first incoming call.

## XLC3.4 PHONEBOOK

To access your phone's stored records (Phonebook), and for further details regarding this feature, press the **Phonebook** button  on the handset, and / or follow the instructions under PHONEBOOK (page 21).

## XLC3.4 SCREEN DETAILS

### IMPORTANT:

In standby mode, the screen displays the date and time, handset number (for the first 10 seconds of inactivity), and date and time (after the first 10 seconds of inactivity).

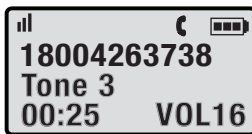

### EXAMPLE 1 (above):







- Phone is in a call, earpiece mode.
- Number that was dialed: 18004263738.
- Tone setting is 3.
- Volume level is 16.
- Call timer: 25 seconds since the beginning of the call.



### EXAMPLE 2 (above):

- Phone is in standby; more than 10 seconds since the phone was active.
- Date: April 25.
- Time: 12:38AM.
- There are new calls in the Caller List.
- There is new voicemail (service from the local phone service provider).

### SCREEN ICONS AND SYMBOLS

-  Battery charge level  
When the icon displays just one bar, return the handset to the charger.
-  New calls indicator  
There are new calls in your Caller List.
-  The phone is in a call, in speakerphone mode.
-  The phone is in a call, in earpiece mode.
-  New voicemail (separate service).
-  Handset is connected to base, and in range.

## XLC3.4 TELEPHONE MENU

To start the setup process, press **MENU**. You will see the list of features to be set up on your new XLC3.4

At any point during the navigation of the MENU options, you can press **MUTE / BACK** to go back to the previous screen, or you can press **FLASH / EXIT** to return to standby mode (exit setup).

To navigate through the menu options, press **UP** or **DOWN** arrows.

While in MENU mode, note the cursor on the top row, to the left of the text. It indicates that the feature displayed on the upper row is active. Press **MENU** to select that feature or option.

The SETUP menu allows you to choose your preferences for the following features of your new XLC3.4:

- **Caller List** - to view and manage the information for your incoming calls - CID / CWCID service (required from your local telephone company);
- **Phonebook** - to view and manage your saved records (names and numbers for your frequently dialed locations);
- **Ringer Setup** - to choose ringer tones, set ringer volume, turn keypad tones on or off (default: On);
- **Visual ring** - to turn your handset visual ringer on or off (default: On);
- **Auto Boost** - to enable Boost function to be active at the beginning of all calls (default: Off);
- **Phone Setup** - to re-establish registration to the base, to enable Auto Talk function (default: Off), to enable Voice Assist feature (default: On), to enable Any Key Answer (default: Off), to enable Low Noise feature (default: On), to choose the language you wish to use (default: English), to choose the dial mode needed for your specific setup (default: Tone), to adjust the contrast of your handset screen (default: medium);
- **Date & time** - to allow you to manually set the date and time; the date (month and day only) and time will be set during the first incoming call, if you subscribe to CID service from your local telephone service provider.

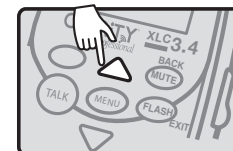
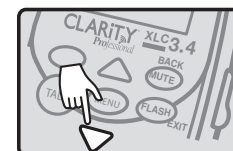
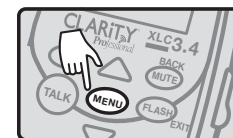

## XLC3.4 MENU - CALLER LIST



If you have new calls, you will notice the New Calls icon to the left of the battery level indicator (upper right corner).

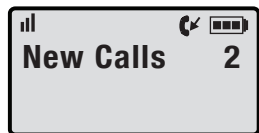

In standby mode, press **MENU** twice.

Your screen displays the number of new calls (which have not been reviewed yet).

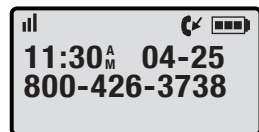

Press **UP** or **DOWN** to review the records in your call history (up to 40 records).

For each record, the screen alternates between showing the date / time of call and phone number, and the name associated with the phone number that called you.



Press **MUTE / BACK** to review the available formats for the record: 7 digits (no area code), 10 digits (area code + number), 11 digits (1+area code+number). The screen displays the new numbers.

When the format number is correct, press **TALK** if you wish to dial back the number.

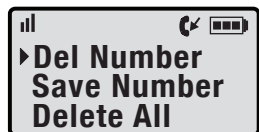

If you wish to save or delete the record from your memory, press **MENU** (after formatting the number). You will see the options available for that record. From here, choose one of the paths described below:

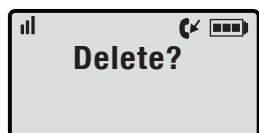

- To delete the record, press **MENU** once. The screen displays "Delete?" Press **MENU** to delete (screen displays OK and you hear five beeps), or **MUTE / BACK** to return to previous screen.

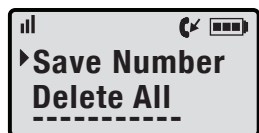

- To save the number, press **DOWN** once, then press **MENU**. You can edit the number and then the name associated with the record. Press **MUTE / BACK** to delete the previous character; press **UP** or **DOWN** to move cursor within name. Use keypad to add characters to the name.

Press **MENU** to save the number to your phonebook.



- To delete all records, press **DOWN** twice, then press **MENU**. The screen displays "Delete All?" Press **MENU** to delete all records (screen displays OK and you hear five beeps), or press **MUTE / BACK** to return to previous screen.

## XLC3.4 MENU - PHONEBOOK

To access your phonebook from standby, press **MENU** once to enter the menu, press **DOWN** once, press **MENU** again to select.

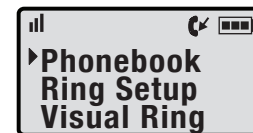

Use **UP** or **DOWN** to browse through your saved records.

To dial one of your saved numbers, press **TALK** when it is shown on the screen.

To add a number, edit a number, delete a number or delete all numbers, press **MENU** while viewing a saved record. From here, choose one of the paths described below:

- Press **MENU** to select "Add Number" option. You will be prompted to enter the number as you will dial it. To edit the number before saving it, use **MUTE / BACK** to delete the last digit (one at a time); use **UP** or **DOWN** to move within the number without deleting all digits.

When finished, press **MENU** to save the number.

You will be prompted to enter the name for the number you saved. Use the numeric keypad to enter the name to be saved.

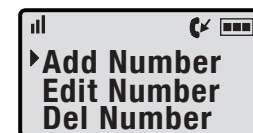

When finished, press **MENU** to save the number. Screen will display "OK" and you will hear five beeps.

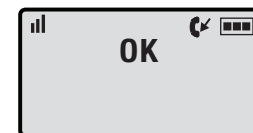

- To edit the saved record while viewing it: press **DOWN** to advance the row that reads "Edit Number" to the top of the screen. Press **MENU** to select this option.

You will be prompted to edit the number - use **UP** or **DOWN** to move the cursor, or use **MUTE / BACK** to delete the last digit. Press **MENU** when the editing is complete.

You will be prompted to edit the name. Use the same controls as above.

Press **MENU** to save your edited record. Screen will display "OK" and you will hear five beeps.

