

RIG 500 PRO Series

User Guide

Contents

Setup and basics	3
Fit	3
Set up your headset	3
Adjust the volume	4
System volume	5
Mute	5
Support	6

Setup and basics

- Fit** 1 The headband adjusts to three sizes (small, medium, large) by moving the earcups. To remove an earcup, press the earcup to detach it from the headband.

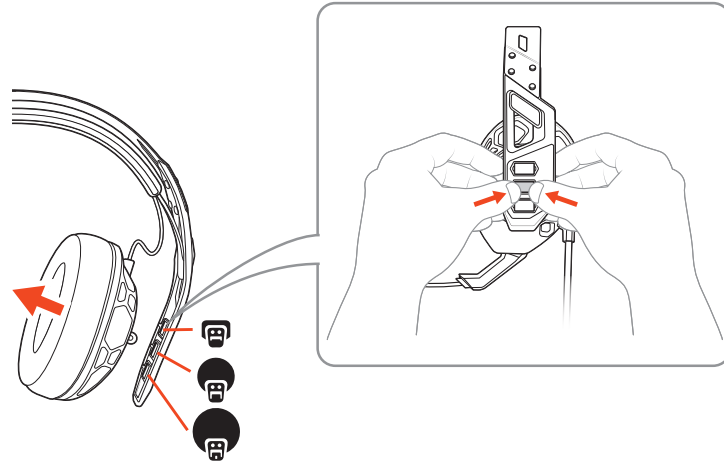

- 2 To change your ear cushions, gently pull the ear cushion off. To replace it, align the notches.

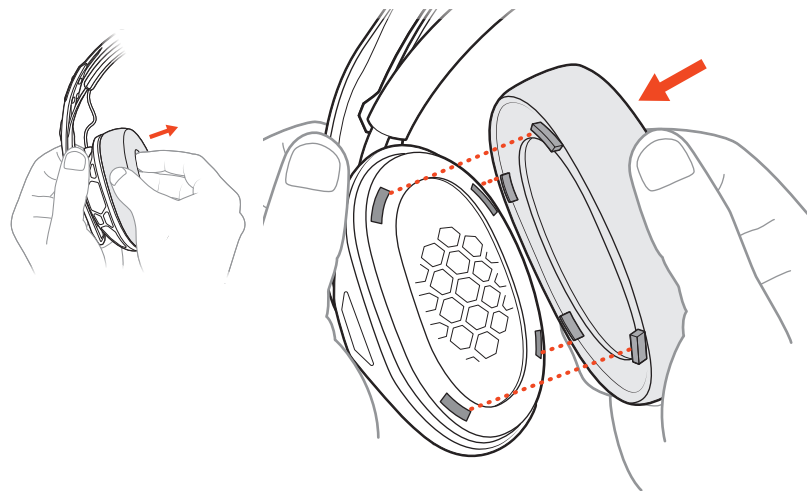

Set up your headset

Your headset components easily snap into the headset frame to configure the best fit and sound.

Follow the diagram to put your headset together.

Connect to PC RIG 500 PRO, RIG 500 PRO ESPORTS

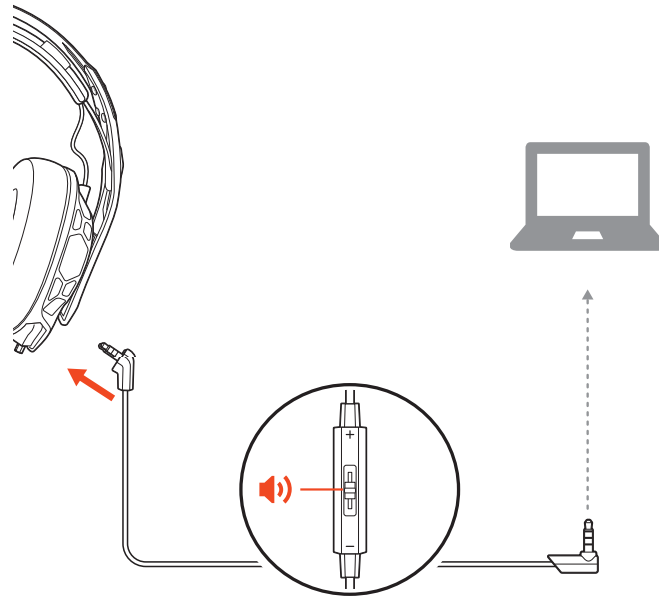

Connect to console RIG 500 PRO ESPORTS, RIG 500 PRO HC, RIG 500 PRO HX/HX SE

Out of the box, the volume wheel has the Xbox One sleeve attached and the PS4 sleeve is supplied (the RIG 500 PRO HS/HS SE models have the PS4 sleeve attached and the Xbox One sleeve is supplied). Align notches on the appropriate sleeve and volume wheel before attaching to your controller.

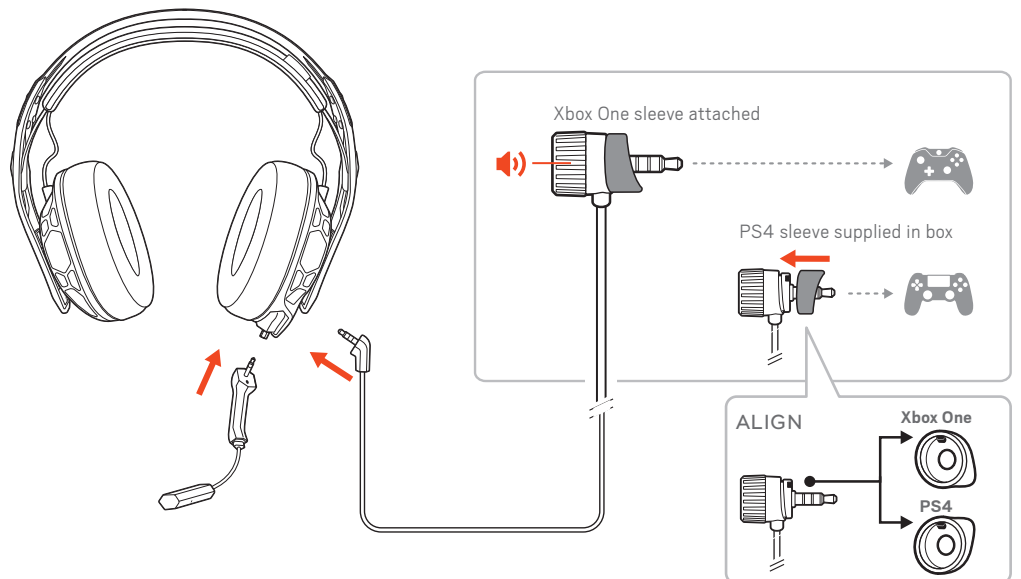

Adjust the volume

To adjust your headset volume, turn the volume wheel.

NOTE If your controller has a volume feature, you can lock the volume wheel at maximum by turning it fully to the right.

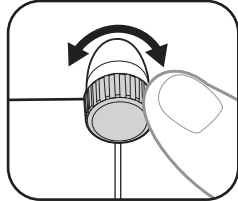

System volume

To adjust system volume, check your console's user guide.

Mute

Lift the boom to a full stop to mute the microphone.

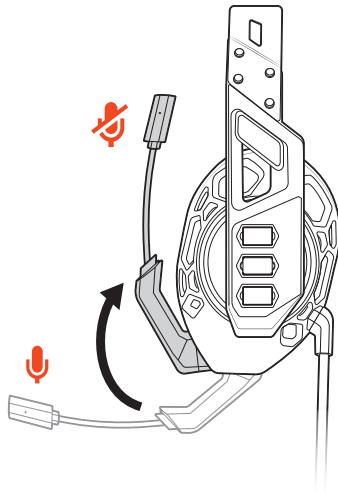

CAUTION Do not force the boom past its upper or lower limits.

Support

NEED MORE HELP?

plantronics.com/support

Plantronics, Inc.

345 Encinal Street
Santa Cruz, CA 95060
United States

Plantronics B.V.

Scorpius 171
2132 LR Hoofddorp
Netherlands

© 2018 Plantronics, Inc. All trademarks are the property of their respective owners.

Patents pending.

213083-06 (06.18)