



User Manual

PocketBook IQ 701



Table of contents

Table of contents	2
Safety precautions	5
PocketBook IQ 701 technical characteristics	8
Pocketbook IQ 701 – Appearance and controls	10
Controls and Indicators:	12
Getting started	14
User Manual	15
Navigation	17
Selection of items and starting applications.....	17
Panel of running applications	17
Using the On-Screen Keyboard	17
The status bar	18
Library	19
Working with Folders and files	20
Working with Books and Bookshelves.....	20
Quick menu of the library	20
Managing Books in the Library	21
Software functions	24
Main Menu	24
Library.....	28
Loading and reading books	45
Loading books to the memory	45
Open a book	45
Reading Mode.....	45
Quick menu.....	47

Panel of basic commands	47
Quick Menu.....	49
Troubleshooting	56
Client Support	60
Software version update	61
Compliance with international standarts	63



Thank you for purchasing PocketBook IQ 701!

Before you start using this PocketBook IQ 701 please read this Manual carefully. You will learn how to ensure your own safety and extend the service life of your device.

If any of the following safety measures have not been complied with or defects/faults are observed please contact the authorized service center to check your device. Failure to comply with this requirement may cause the device to malfunction.

Safety precautions

Do not expose your device to excessively high or low temperatures. Avoid direct sunlight. Avoid heating or cooling the battery. An excessively hot battery may cause skin burns. Please note that the operating temperature ranges from 0°C to 40°C.

Avoid exposure to direct flame or smoke (cigarette, lighter, open fire etc.).

Avoid exposure to liquids or damp (do not use the device in the rain, in the street at higher humidity, near bodies of water etc.). Avoid penetration of liquids or moisture since this may cause short circuit and/or damage to the battery. If liquid does get into the device, remove the battery immediately and contact the authorized service center.

Do not leave the device for a long time in poorly ventilated environment, e.g. in a car or in closed tight boxes/packaging.

Avoid exposure to strong electromagnetic fields.

Neither drop nor try to bend the device. If the device is damaged contact the authorized service center.

Do not disassemble or modify the book reader. Only authorized personnel may conduct work on the device.

This device is not waterproof and must not be used under water. If your device has become wet contact the authorized center immediately.

Do not use the device with a damaged battery, charger (broken case, poor contact, broken feed cable) or SD card. If the battery is damaged (cracked case, leakage of electrolyte, off-shape etc.) it should be replaced.

Do not replace the battery yourself. Use of home-made or modified batteries may cause an explosion and/or damage the device.

Warning! Do not destroy the battery by burning it, to avoid the danger of explosion!

Avoid any mechanical pressure on the screen. Protect the screen from objects that may scratch or damage it. To ensure adequate protection of the screen, we recommend storing the device in a protective and/or hard cover.

Do not use organic or inorganic solvents (e.g. benzol etc.) to clean the screen/case. Use a soft cloth to remove dust from the device's surface. To remove dirt apply a few drops of distilled water. To remove persistent dirt contact the authorized center.

Do not expose the screen to electrostatic charges or artificial sources of UV electromagnetic radiation.

Up to five faulty pixels are acceptable in the screen and do not constitute a warrantable defect of the screen.

Never leave cables near heat sources. Heated cables or their insulation may become deformed or damaged, which could lead to fire or electric shock.



Avoid any mechanical impacts onto connectors and keys of the device. This may affect their operation and cause malfunction.



Disposal of electric and electronic components (the Directive is applicable to the EU and other European countries where separate waste disposal systems exist).

In other countries dispose of batteries in accordance with local laws.

Incorrect disposal of this device may have adverse impacts on the environment and public health. To prevent such consequences follow the device-specific disposal requirements. Recycling of these materials helps preserve natural resources. For more information regarding recycling issues please contact local municipal authorities, your domestic waste collection service, the store where you purchased the device or the authorized service center.

Do not use wireless communication in places where it is not allowed. Please do not use wireless communication onboard a plane and in hospitals – this may affect airborne avionics or medical equipment. Moreover, do not use your device where mobile communications are prohibited.

This book reader receives and transmits radio frequencies and may interfere with radio communications and other electronic equipment. If you use personal medical devices (e.g. a pacemaker or hearing aid) please contact your doctor or the manufacturer to learn whether or not such medical devices are protected against external RF signals.

By the end of product guarantee term, please contact the nearest authorized service facility for examination on the subject of security is maintained.

Keep away from children.

PocketBook IQ 701 technical characteristics

Display	7" Touch screen, TFT 800x600, 143 dpi, 262,000 colors
Processor	800 MHz
Memory	RAM: 256MB Permanent: Micro SD card (2GB). Supports up to 32GB.
Operating system	Android®
Communications	Mini USB (480 Mb/s), Wi-Fi® (b/g/n)
Memory Slot	External memory slot SD (SDHC) up to 32GB
Audio Output	Stereo connector for 3.5 mm earphones; 2 x 0.5 W speakers
Accelerometer	Yes
Book formats	PDF (ADOBE DRM), EPUB (ADOBE DRM), PDF, EPUB, FB2, TXT, DJVU, RTF, HTML, DOC, DOCX, FB2.ZIP
Image formats	JPEG, PNG, GIF
Audio formats	MP3, AAC
Video Formats	3GP, MP4, AVI
Battery	Li-Polymer, 7.4V, 1600 mAh
Charger	12V / 1.5A
Size	144x192x14 mm



PocketBook Int. Room 2201, 22/F.1 Duddell str. Central, Hong Kong
info@pocketbook-int.com, www.pocketbook-int.com

Weight	516 g
---------------	-------

Pocketbook IQ 701 – Appearance and controls

This section provides a general description of your PocketBook IQ 701 and its functional keys.

Front view:

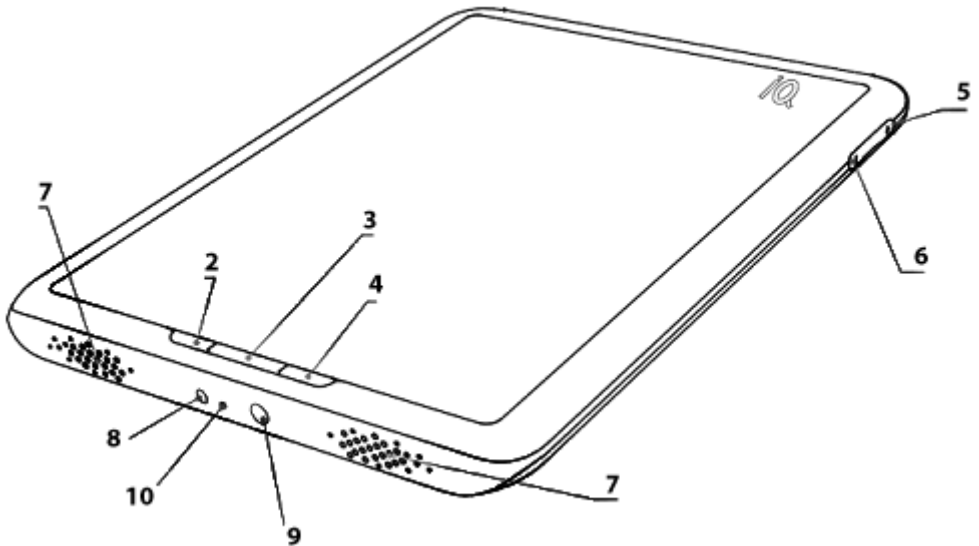

Back view:

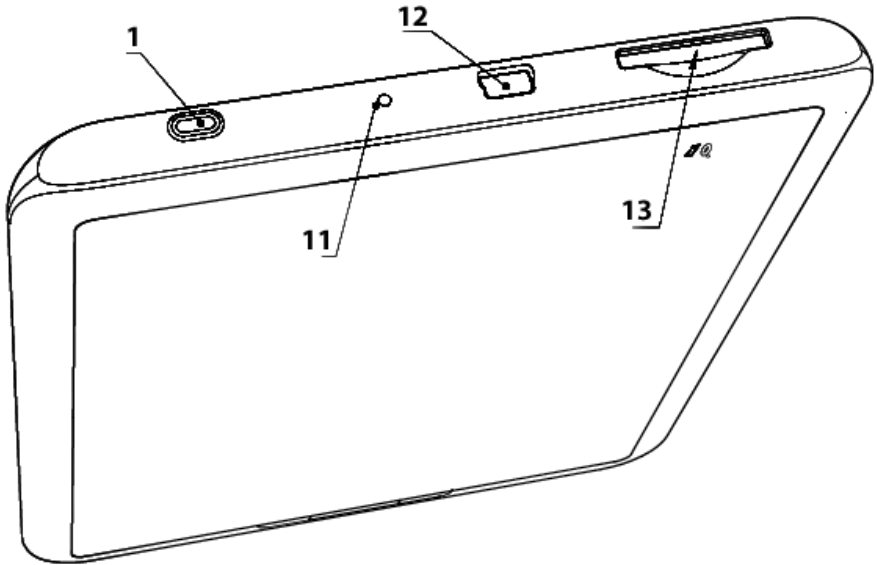

Controls and Indicators:

1. **'On/Off'** – switches the device on/off (long pressing);
2. **'Menu'** – calls the fast access menu;
3. **'Home'** – return to Main Menu;
4. **'Return'** – back to the previous menu, close the book. Long pressing forces shutdown;
5. **'Volume +'** – increasing volume;
6. **'Volume -'** – decreasing volume;
7. **Speakers** – 2 x 0.5W speakers for playing back audio files;
8. **Power connector** – designed for charging your device from the mains;
9. **3.5 mm Audio Jack** – designed for connecting 3.5 mm earphones;
10. **Color indicator** – designed for indicating the device status when connected to a PC Steady orange indicator light that charging in progress, constant green – battery fully charged;
11. **'Reset'** – reloads the device;
12. **Mini-USB** connector – designed for connecting your device to PC;

13. SD-card slot is used to connect an external SD memory card (SD-card is optional);

Getting started

STEP 1. CHARGING THE BATTERY

When you charge your device for the first time keep it charging for 8 – 12 hrs without switching it on. You can charge your PocketBook IQ 701 battery from the mains, using the power charger.

When charging the battery for the first time:

1. Make sure the device and its power indicator are off. If it is on, keep the 'On/Off' button pressed for a few seconds;
2. Select 'Power Off' on the context menu that appears;
3. Connect your device to the mains using the charger;
4. The indicator turns yellow as soon as the charging process starts;
5. When the battery is fully charged, the indicator turns green or off;
6. Now you can disconnect the device and turn it on for the first time.

STEP 2. TURNING ON

Keep 'On/Off' pressed for about 2 seconds. A start up logo appears;

When the device is ready to operate, the image will be replaced by the lockscreen. The lockscreen can be unlocked in

two ways: either by pressing the Menu button on the front panel or by touching the lock icon in the screen  and sliding your finger over the screen in the direction indicated by the arrow until the screen is unlocked. Upon unlocking, the main menu will open on the screen displaying the last opened books and the key options of PocketBook IQ.

Individual functions presented here are described in more detail in the Complete User Manual e-book loaded into the memory of your device.

STEP 3. SETTINGS

Follow the Wizard instructions to customize the main parameters. After finishing the customization a Main Menu will appear.

STEP 4. READING BOOKS

Your PocketBook IQ 701 already stores hundreds of books of various genres and styles and in different languages. For more information on how to add new books to your library, see [‘Loading and reading e-books’](#).

User Manual

The *User Manual* is stored in the internal memory of your device so that you may refer to detailed descriptions of functions you need at any time.



PocketBook Int. Room 2201, 22/F.1 Duddell str. Central, Hong Kong
info@pocketbook-int.com, www.pocketbook-int.com

User Manual for the latest version also available on the
PocketBook official website: http://pocketbook-int.com/support/pocketbook-IQ_701/

Navigation

Selection of items and starting applications

To invoke the desired menu item or run the application, simply touch its icon or list item on the screen with your finger or stylus. To return to a previous screen, simply click the 'Return' button on the front panel. This action will minimize the application but not close it.

Panel of running applications

The panel contains a list of currently running applications.

To display this panel, press and hold the Home button

Using the panel, you can quickly move to another opened application.

Using the On-Screen Keyboard

To access the on-screen keyboard, touch any text box.

The screen will display a standard keyboard. Enter your text by touching the keys of the on-screen keyboard.

To add a new input language:

Access the keyboard, then press and hold the '?123' button. In the contextual menu, which has opened, select the 'Android keyboard settings'. In Android keyboard settings

select the 'Input Languages' option. Select the required input languages.

You can change input languages by sliding over the 'Space' key. Select the required keyboard layout in the pop-up window.



The status bar

The status bar, which is located at the top edge of the screen, shows:

- date and time;
- battery status;
- connection icons that inform you about what type of connection is currently used:
 - wireless network;
 - computer via USB.

The status bar also may show system notification icons. These notifications can be viewed by expanding the status bar. To do this, press and hold your finger (or stylus) on the status bar and pull it down to the bottom edge of the screen.

Library

The 'Library' section is the main management tool for e-book files on the device.

The 'Library' section contains the following tabs:

- 'Library' - the main tab of the section
- 'History' - a list of books opened most recently, in chronological order
- 'Favorites' - a bookshelf containing books marked as Favorites by the user
- 'Online' – BookLand Internet bookstore

The main section, 'Library', has a number of display options:

- Folders (by default)
- Bookshelves

Working with Folders and files

To open a folder - tap on its title. The folder will open and display a list of its contents. To collapse all the contents back, tap its title again.

To open a file - tap on its title. If this file is registered in the system, it will be opened by the viewer program.

Working with Books and Bookshelves

To view the contents of a bookshelf, simply touch its title. Tap this title again to close this bookshelf.

To open a book touch its title. The library displays books only in those formats that can be read by the device.

Quick menu of the library

While in the 'Library' section you can call the quick menu option by pressing the 'Menu' button. The quick menu provides the following functions:

- **Search** (finding books in the library by title or author);
- **Sorting** (sorting books):
 - by Title;
 - by Author;
 - by Date.

Sorting function is not operable in the 'History' tab of the 'Library' section.

- **Table Thumbnails\List View** (switching the view of the books in the form of thumbnails or a detailed list);
- **Add shelf** (adding new shelves (icons) or creating new folders);
- **Folders\Shelves** (toggles library display mode. Bookshelves - used for working with book files installed on the device. Files - used for working with all files in the device);
- **Downloads** (opens a folder with downloads from the 'BookLand' online library and other files).

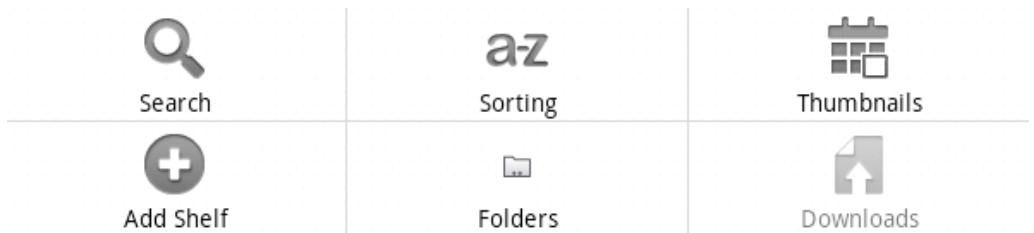

Managing Books in the Library

Press and hold the corresponding object for about 2 seconds to display a contextual menu. In the 'Library' section, the following commands are available in the book's contextual menu:

- **Open;**

- **Rename**
- **Delete**
- **Add to Favorites/Remove from Favorites;**
- **Mark as unread’/’Mark as read;**
- **Shelves**
- **‘View Info’.**

Note: Certain commands are only enabled in 'Bookshelves' mode.

‘Open’ - use this option to open a selected book.

You can edit a book file name by selecting the **'Rename'** option. However, not the book title contained in meta data.

By selecting the **'Delete'** option you can delete a book. Be careful – the book file is physically deleted in this case, as opposed to hiding a book in the bookshelf.

‘Add to Favorites/Remove from Favorites’ - use this option to add a selected book to ‘Favorites’.

‘Mark as unread’/‘Mark as read’ – use this option to mark a selected book as unread or read.

The **'Bookshelves'** option displays the names of bookshelves containing the selected book. (Including the 'Favourites' bookshelf)



PocketBook Int. Room 2201, 22/F.1 Duddell str. Central, Hong Kong
info@pocketbook-int.com, www.pocketbook-int.com

'View Info' - use this option to view information about the book.

Software functions

Main Menu

The Main Menu appears after turning on and unlocking the device; it is a software element which displays the basic functional and control sections to make the device easier to use:

- **Last opened;**
- **Reading statistics;**
- **Main panel;**
- **‘BookLand’ online library.**

To access the Main Menu while your device is in use, press ‘Home’ on the face panel or press the ‘Return’ key sequentially.

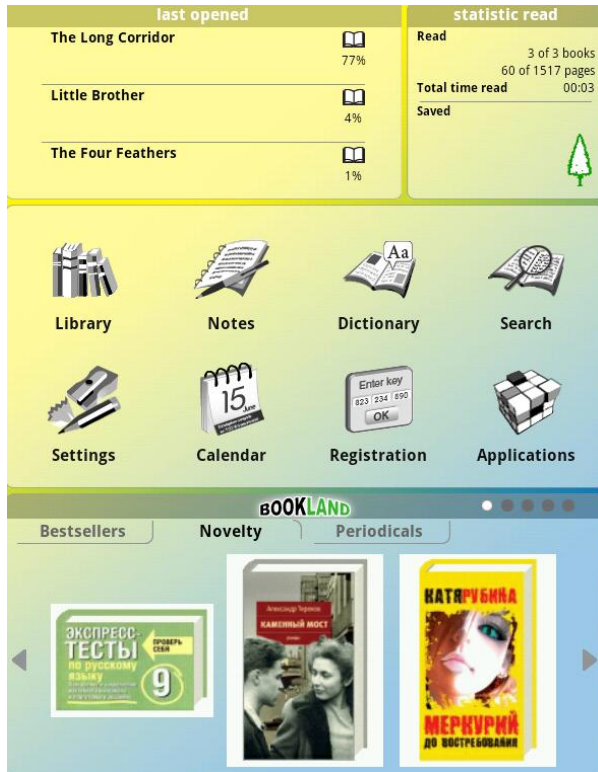

See below for more details on each item of the Main Menu.

Last opened books

‘Last opened’ – is a special widget of the Main Menu which was created for instant access to recently opened books. Its main function is to show you the last three books opened in reverse chronological order.

last opened	
The Long Corridor	 77%
Little Brother	 4%
The Four Feathers	 1%

If you want to list other books which were opened earlier you need to press the scroll arrows on the edges of this widget. To open any book from this list, simply tap on the title of the book.

Reading statistics

The 'Reading Statistics' widget will show you how many books and pages have already been read and how many live trees have been saved as compared to books printed on paper.

statistic read	
Read	3 of 3 books 60 of 1517 pages
Total time read	00:03
Saved	

Main Toolbar

Displaying main functional and control sections:

1. **Library;**
2. **Notes;**
3. **Dictionary;**
4. **Search;**
5. **Settings;**
6. **Calendar;**
7. **Registration/Favourites;**
8. **Applications**

See below for more details on each item of the Main Toolbar.

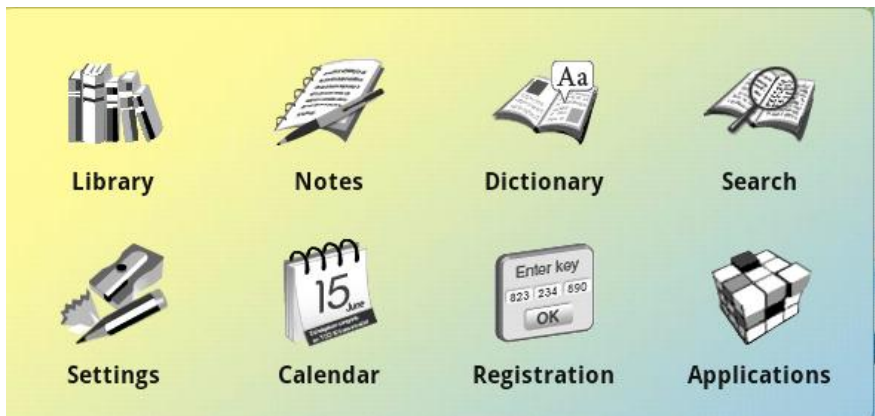

Library



To enter 'Library', tap the 'Library' icon in the Main panel.

This section shows all books, magazines and other documents downloaded to the internal memory and SD-card (if any).

Note: *Files in media formats (i.e. music, video etc.) are not displayed in the Library. To access these files, use the File Manager (see [Applications](#) section.)*

Main functions:

- ✓ Searching for/opening books and other documents;
- ✓ Managing the section content via Context Menu;
- ✓ Accessing the 'BookLand' online library.

Shelves

All books on the PocketBook IQ 701 can be arranged as a bookshelf for your convenience. The user can create new bookshelves if needed. Using a 'Shelves' option from the quick menu, you can set correspondence of the books to various bookshelves. The book can simultaneously be on the different bookshelves.

You can search books by title or author, arrange books in accordance with your preferences (outlines of the books or in the form of a list).

Note: By default, the books are displayed in the device as *Folders*. The 'Bookshelf' display mode serves to simplify book management in the library.

Online library 'BookLand'

PocketBook IQ 701 allows you to browse and download books from the 'BookLand' online bookstore. The device accesses the library services via wireless Internet connection Wi-Fi.



To enter the online library, simply tap any book in the 'BookLand' widget from the Main Menu. This action will automatically start your browser and takes you to the page with the selected book.

Note: in order to access 'BookLand', you need to establish Wi-Fi connection.

Main functions:

- ✓ Log on to/user registration in the library;
- ✓ Browse, manage book shelves/content;
- ✓ Access to new books and bestsellers in store or the free library;
- ✓ Book search in the catalog;
- ✓ Overview of popular authors;
- ✓ Overview of ways to replenish your balance in the 'BookLand' library.

You can also pass to 'BookLand' online library directly from the 'Library' section. To do this, click on the ' Online' tab in this Section.

Accessing the books in the BookLand

1. Open the 'Library' section by pressing the 'Library' button in the main menu.
2. Touch the 'Online' tab with your stylus.

Library



Library



History



Favorites



Online

Note: To connect to the bookstore, the device must have a configured Internet connection.

3. Select the desired book by using the 'BookLand' store's browsing tools. In the menu of the 'BookLand' section select what you need:

Search in the library

You can perform book search by book title.

Press the **Menu** button to call the library's quick access menu. Press the **Search** icon.

The screen will display the search query box and the on-screen keyboard.

Enter your search query in the text box. The search is performed by book titles and it is displayed when you enter your query in brief form (title and author).

Upon starting the search (the button with magnifying glass image near the text box), the result will be displayed in full: Cover page, book title, and author.

Notes



This section of the Main Menu stores notes made by you. You can edit, as well as create text and graphic [notes](#).

Dictionary



Allows you to translate a selected word using available dictionaries. After launching the application, the onscreen keyboard will appear (see the '[Using onscreen keyboard](#)' section for detailed information on how to use the keyboard). Type in the required word and the application will find the translation. You can turn pages of the dictionary. If you have several dictionaries on your PocketBook IQ 701, you can switch between dictionaries.

Additional dictionaries you can download from the <http://pocketbook-int.com/support/> or <http://www.bookland.net.ua/abbyy/>;

To install the dictionary, use the **Settings > Applications > Manage package** tab;

Search



Using the onscreen keyboard, you can search for books in the 'Search' section of the Main Menu by specifying a book's full or partial name or the author's name.

Settings



In this section:

- Set the interface language and font
- Activate and deactivate internal functions of the device
- Customize the power saving mode
- Manage the services and installed programs
- Browse the device, memory and operating system status and set the current time and date.

WIRELESS & NETWORKS.

- **Flight mode.**

This option disables all wireless connections;

- **Wi-Fi.**

If you select this checkbox the device will start to search for Wi-Fi networks;

- **Wi-Fi settings.**

Configuring Wi-Fi Connection. In this submenu you can enable the Wi-Fi module:

- Wi-Fi enable/disable;
- Network notification. Enabling this setting activates notification on finding accessible networks;
- Adding Wi-Fi networks.

By checking the 'Network Notification' option you can make your device scan the air for available Wi-Fi access points. Your device will offer you a list of available networks. If the 'Network Notification' option is disabled, you can scan the air by calling up the quick access menu in 'Wi-Fi Settings' and pressing the 'Search' button;

You can scan available Wi-Fi networks by bringing up the context menu and selecting 'Scan'.

To configure additional parameters bring up the context menu and select 'Advanced'. Here you can find:

- Regulatory domain. Setting the number of channels to use;
- Wi-Fi sleep policy. Selects the time to switch from Wi-Fi to standby mode;
- MAC address. Shows your current MAC address.

If you need to connect to the network by using a hidden SSID name, you will be able to do this by manually configuring network settings. To this end, you must click 'Add Wi-Fi network' option in 'Wi-Fi settings' sub-menu. In the opened

window, click the 'Network SSID' box and enter network SSID name using the on-screen keyboard which has just opened.

Below, you will find a drop-down list to select a network protection method. 'No Protection' option is set by default. From the list, select the access protection method used in the network you want to connect to. Upon selection of protected connection, a text box will pop up to enter the password for accessing the network. Enter the access password using the on-screen keyboard.

To simplify entering the password, you can check the 'Display password' box – in this case the characters being entered will not be automatically hidden; so, you will be able to correct misentered characters, rather than enter the password anew. But be careful not to allow outsiders to see your password and use it for unauthorized access.

Having entered all the required settings, press the 'Save' button and the network with specified settings will be displayed in your list of networks. To connect to this network, find it in your list of networks, click it and select the 'Connect' option.

VPN settings.

Here you can set up and manage Virtual Private Networks (VPNs).

PocketBook IQ 701 allows you to use 4 types of VPN connections:

- PPTP;
- L2TP;
- L2TP/IPSec PSK;
- L2TP/IPSec CRT.

SOUNDS & DISPLAY.

- Sound settings:
 - **Silent mode.** Marking this checkbox will disable all sounds except media and alarms;
 - **Media volume.** Here you can adjust the volume for music and videos;
 - **SD-card notifications.** You can enable audible notifications on insertion / removal of the SD card.
- Display settings:
 - **Orientation.** Marking this checkbox will enable automatic screen rotation to reading with maximum comfort;
 - **Animation.** Here you can choose the amount of animation in the device;
 - **Brightness.** Here you can adjust the brightness of your device;
 - **Screen timeout.** Here you can adjust the delay before the screen automatically turns off.

APPLICATIONS.

- **Unknown sources.** By checking this box, you allow installation of applications obtained from any other sources beside Android Market.
- **Manage applications.**

This option allows you to view the list of manually installed applications, view their parameters and access rights, uninstall applications and control their operation (force quit).;
- **Running services.**

Selecting this option, you can view a list of running services and utilities. You can force quit any of the running services;
- **Development.**

Here is a collection of supplementary options including enabling 'USB Debugging' mode for application developers and 'Leave Switched On' option which, when enabled, will not allow the device to go to sleep mode during charging.

ACCOUNTS & SYNC.

- **Background data.** Marking this checkbox will allow applications to sync, send and receive data at any time.

- **Auto-sync.** Marking this checkbox will allow applications to sync data automatically.
- **Add account.** Here you can add a mail account.

PRIVACY.

- **Factory data reset.**

Erases all data on the device. Information that will be deleted:

- Your Google account;
- System data and settings;
- Downloaded and installed applications.

Information that will not be deleted:

- System software;
- Files on SD-card (photos, music etc.).

SD CARD AND MEMORY.

Here you can view

- Total space
- Available space

Management SD-card:

Memory card operations:

- **Remove SD-card.**

If you want to remove the SD memory card, the PB IQ device has a function for safe card removal. To access it select the 'Unmount SD Card' option;

- **Format SD-card.**

This option will enable you to erase all information from your SD-card. Be careful - upon formatting, all data on memory card (for example, photos and music) will be lost.

To format the SD card, it must first be unmounted it by calling the 'Unmount SD Card' command.

SEARCH

- **Google search settings.**
- **Searchable items.** Here you can choose what to search on the device;
- **Clear search shortcuts.** Clear the list of recently selected search results.

LANGUAGE & KEYBOARD

- **Select locale.**

Locate selection changes the interface language; keyboard layout, as well as formats of date, time and numbers are customized separately

- **Android keyboard.**

Checkbox next to 'Android Keyboard' option activates on-screen keyboard.

The following additional options can be enabled for the on-screen keyboard:

- Vibrate on keypress;
 - Sound on keypress;
 - Auto-capitalization. Enables automatic capitalization of the letters;
 - Input languages. Here you can set input languages;
 - Show suggestions. Display suggested words while typing.
 - Auto-complete. Press spacebar to automatically insert suggested word.
- User dictionary. User's dictionary serves to check spelling, and user can add to it words unavailable in a standard dictionary.

TEXT-TO-SPEECH

The settings section contains the parameters for audio reproduction of text (for more details on text-to-speech, go to the "[Reading Mode](#)" section).

The section contains the following settings:

- Listen to a Sample – Play a text sample reproduced with the current settings.
- Install Voice Package – Install and delete voice packages.

The voice packages you can download from the official site www.pocketbook-int.com;

- Always Use My Settings – Override the application settings with the user's preferences.
- Text Speed - Set text playback speed.
- Language – Select the default playback language.

DATE AND TIME

- **Set date;**
- **Select time zone;**
- **Set time;**
- **Use 24-hour format;**
- **Select date format**

ABOUT THE DEVICE

Here you can find detailed information about your device.

- **Model number;**
- **Firmware version;**

- **S/N** – device serial number

Calendar



The user can make use of the installed calendar. As usual, 'Calendar' application is designed to assist in organizing one's plans and engagements. It allows you to view current date, week, month, and year.

Favorites



You can add your favorite book to this shelf.

ADDING BOOKS TO 'FAVORITES'

- Go to Main Menu – 'Library' – 'All books'. Press and hold selected book.
- From displayed list select 'Add to Favorites'.
- Open selected book. Open the quick menu and select 'More'. From displayed list select 'Add to Favorites'.

- When in the 'Library' section, hold your finger (or stylus) on the selected book, then go to the 'Shelves' option of context menu, check the box corresponding to the 'Favorites' bookshelf and confirm your decision by pressing the 'Accept' button.

REMOVING BOOKS FROM 'FAVORITES'

- When in the 'Favorites' section, hold your finger (or stylus) on selected book, then go to the 'Shelves' option in context menu. Uncheck the 'Favorites' option in the opened menu. Press the 'Accept' button.
- When in the 'Library' section, hold your finger (or stylus) on selected book, then go to the 'Delete from Favorites' option in context menu.

Applications

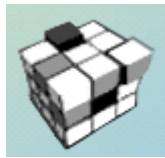

This section contains programs installed by the user or automatically. PocketBook IQ 701 lets you install any programs designed for the Android® operating system except those which utilize any modules or functions which are not available in the device.

The software package includes a number of default applications such as DolphinBrowserHD and OperaMini which can be installed by the user using the File Manager: /PocketBook701/app.

The programs can be installed manually by copying the installation package to the device and running the installation wizard manually from the File Manager.

Loading and reading books

Loading books to the memory

Connect your device to PC via the mini-USB cable. Internal memory and external SD-card will be displayed in Using Windows Explorer or any file manager of another application, copy books to the selected folder in the device memory or onto the SD card.

Open a book

To open a book, enter 'Library' and select the required book. A recently opened book can be opened from Main Menu ([Last opened](#)). If you have already started to read this book, it will be opened on the page at which it was closed.

The right part of the screen displays the number of the open page and the total number of pages.

***Note:** some functions become unavailable while a book is in the process of opening. This is due to the calculation of the number of pages.*

Reading Mode

Basic mode of using the device.

In reading mode, the corresponding viewing program opens the selected file.

Main Features:

- ✓ Paging;
- ✓ Display rotation;
- ✓ Zoom;
- ✓ Switching to specified page;
- ✓ Linking inside the book;
- ✓ Bookmark managing;
- ✓ Notes managing;
- ✓ Switch to Structured Table of Contents;
- ✓ Adding to Favorites;
- ✓ Marking book as read/unread;
- ✓ Viewing book info;
- ✓ Display configuration;
- ✓ Closed books.

PAGING

To go to the next or previous page slide your finger or stylus in the centre of the display in the opposite direction of where you want to go. This movement is similar to page turning when you are reading a paper book.

Paging is also available in the main operation menu. To open main operation menu tap on the status bar at the bottom of the screen when you are reading a book.

When reading books in PDF and DJVU formats, if content does not fit the page, you can move the image. To move the image press and hold your finger in the centre on the display and move the image.

Quick menu

To open the quick menu when reading a book, press the 'Menu' button.

Panel of basic commands

To call the command panel, touch the **Status bar** with your finger (or stylus) slide it up and expand to get the panel of basic commands.

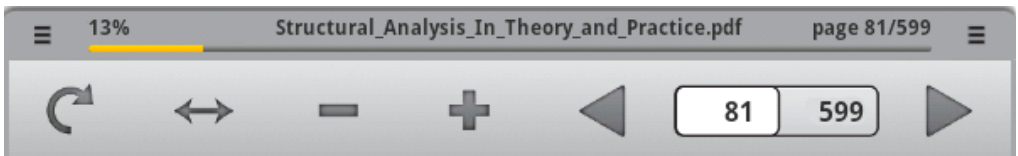

LOCKING SCREEN ROTATION

Selecting this function, you can lock and unlock the current screen position.

FIT TO WIDTH

For graphic format files. This function restores the book display scale using a page size equal to screen width.

HOW TO CHANGE THE DISPLAY SCALE

You can select a desired scale for the displayed text. To do this, call the basic commands menu and, using the '+' and '-' buttons

CURRENT PAGE AND TURNING PAGES

The cells of right-hand side of the command panel display page-turning arrows, current page, and total number of pages. You can turn the pages by pressing the arrows.

To go to the specified page, press the cell with the current page number with your finger or stylus and then use the on-screen keyboard to enter the page number you want to go to in the opened text box 'Go to page'.

Note: *Scale changing or menu calling is accompanied by changes of the visible screen area and the reader recalculates the total number of pages in the book. This can take up some time.*

Linking inside the book

Some book formats allow you to link inside a book. References in the text are highlighted by color. To go to the link, press and hold the required link (use the stylus here for greater precision).

The reference will open as a separate page. To return to the book, press the 'Return' button

Quick Menu

To access the Quick Menu, click the "Menu" button on the device's front panel.

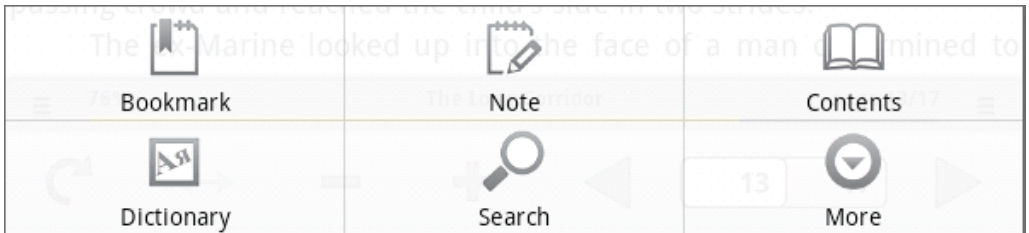

BOOKMARK MANAGING

To create a note press in the centre of the display and hold. The quick menu will appear. Select 'Create bookmark'. To view bookmarks open the main operation menu and select the 'Bookmark' icon. In the displayed list select the desired bookmark.

NOTES MANAGING

From time to time you may find it useful to save a selected fragment to a separate notepad. To create a new note in the reading mode, bring up the Quick Menu by pressing the "Menu" button and clicking on the "Note" icon.

If a text format (FB2, EPUB) book is open, the notepad will show the editable page text for saving. You can add comments to the text or delete any unnecessary fragments before saving the note for further reference and usage.

If a graphic format (PDF, DJVU) book is open, the notepad will show a screenshot of the page fragment being viewed. Using drawing tools, you can make notes on a page screenshot and save it as an image for further reference and usage.

SWITCHING TO STRUCTURED TABLE OF CONTENTS

To switch to a book's content select 'Contents' option in the quick menu.

The contents displays the names of chapters and sections of the book. To go to a selected chapter, press its name with your finger or stylus.

Contents can be structured, with hierarchical structure of chapters, sections and parts. Sections with hidden parts of the structure are designated by arrows. To expand a hidden branch, click the arrow.

Note: *This function is only supported by books in format with a structured table of contents. In PDF, the 'Contents' menu option is disabled.*

DICTIONARY

To run dictionary in reading mode, click the 'Dictionary in Quick Access Menu' icon.

Touch the word you want to translate in a page with your finger (or stylus) or enter it using the on-screen keyboard.

Press the '**Enter Word**' button to type a word for translation in the text box by yourself.

SEARCH

To find the desired words or parts of words in the text quickly, click the search button in the shortcut menu. The onscreen keyboard will appear with a text box. Using the onscreen keyboard, enter the text to search for and click "Search". Search results will be highlighted in color.

The control panel search results appear at the bottom of the screen. Use the arrows to navigate through the pages of search results.

TEXT TO SPEECH

The Text-to-speech function or TTS is used to transform text information into speaker voice sounds.

To enable the text-to-speech function, do the following:

While in the Reading Mode, bring up the [quick access menu](#) (by pressing "**Menu**") and select "**More**".

You can access the menu by pressing and holding the page center with your finger.

Select "**Text to Speech**" in the additional menu that opens.

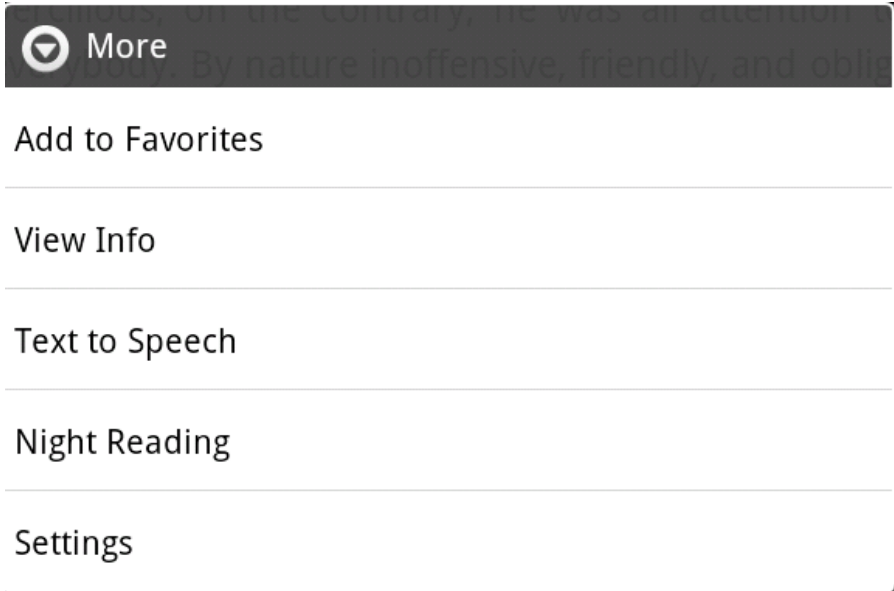

The TTS control menu will show at the bottom of the open book.

Highlight a sentence in the text for playback.

- Press "Play" to start speech reproduction.
- Use the fast forward and rewind buttons to further select sentences for playback.
- Use the volume controls to adjust playback volume.

from Meryton, denominated from that period Lucas Lodge, where he could think with pleasure of his own importance, and, unshackled by business, occupy himself solely in being civil to all the world. For, though elated by his rank, it did not render him supercilious; on the contrary, he was all attention to everybody. By nature inoffensive, friendly, and obliging, his presentation at St. James's had made him courteous.

Lady Lucas was a very good kind of woman, not too clever to be a valuable neighbour to Mrs. Bennet. They had several children. The eldest of them, a sensible, intelligent young woman, about twenty-seven, was Elizabeth's intimate friend.

That the Miss Lucases and the Miss Bennets should meet to talk over a ball was absolutely necessary; and the morning after the assembly brought

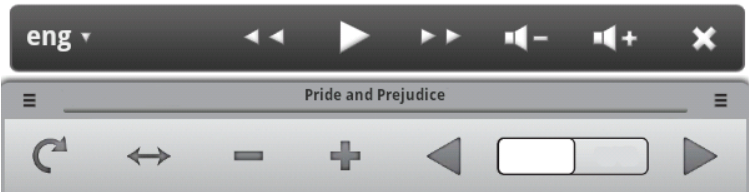

To select the playback language press the tongue icon on the left of the TTS control panel

Select the desired playback language from the list of available ones that opens.



Note: Some of the text-to-speech mode settings are available in the "[Settings](#)" section

Note: The Text-to-Speech function becomes accessible for an opened book only after page calculation.

Note: The currently reproduced sentence text is highlighted. Pages of the book being reproduced by voice are flipped automatically.

BOOK INFO

To view book info open the quick menu by pressing and holding the stylus or your finger in the centre of the display;

From the displayed list select 'View info' option. Information on the book is displayed, such as title, author, cover page, full path, and file size.

NIGHT READING

Turns the night reading mode on/off. Night Reading mode adjusts the display to read at nights, when there is not enough light. With this mode you do not need a book light;

CONFIGURATION

To open the Settings menu in reading mode. Go to the extended option menu 'More' and select the 'Settings' option. This menu allows you to edit certain book display settings in reading mode;

Here you can configure:

- **Panel menu lock** – locks/ unlocks the main operation menu in current status (opened/ hidden);
- **Full screen** – turns full screen viewing mode on/off (hides menu panel);
- **Volume key scrolling** –activates/deactivates buttons '+' and '-' used for paging while reading;
- **Font size** –selects font size.

Closing the book

To close a book press 'Return' or the 'Home' button.

Troubleshooting

MALFUNCTION: Device does not turn on or turns on but only the logo loads

POSSIBLE CAUSE: battery is low.

SOLUTION: charge the battery.

MALFUNCTION: A book does not open - the message 'book is probably damaged or protected' appears, or nothing happens at all.

POSSIBLE CAUSE: this book is damaged.

SOLUTION: If the book was downloaded from the online store try to re-load it again. If the file opens on your PC, but does not open on the device, resave the book in another format.

MALFUNCTION: No response when you press any key.

POSSIBLE CAUSE: sometimes (e.g., when downloading damaged or books with too large a volume) the device may 'hangup'.

SOLUTION: close the frozen application by pressing the 'Return' key for 1–2 sec. If this doesn't help, press 'Reset' on the rear panel to reload your device.

PROBLEM: Having connected to PC, no disks of the device are seen in WINDOWS Explorer.

POSSIBLE CAUSE: your device is in the battery charging mode.

SOLUTION: check USB mode in 'Configuration' item of Main Menu.

Set 'Connection to PC' or 'Ask at Connection'.

POSSIBLE CAUSE: no signal in connection cable.

SOLUTION: check USB cable condition and its proper connection to connector. Try to connect the USB-cable to another connector.

PROBLEM: Bookmarks, settings and current position in file are not saving.

POSSIBLE CAUSE: damaged file system.

SOLUTION: connect the device to a PC and check disks. To do this, open 'My Computer', right-click on the selected disk and select 'Properties – Service – Check Disk'.

POSSIBLE CAUSE: internal memory overloaded.

SOLUTION: Delete books, images and/or music files that you do not need.

PROBLEM: Battery discharges too fast.

POSSIBLE CAUSE 1: disabled automatic turning off.

SOLUTION: select 'Configuration' ⇔ 'Clock' in Main Menu. Select automatic turn off time (10, 20, 30 or 60 minutes) for the 'Turn Off in...' item.

POSSIBLE CAUSE 2: music player is in background mode. The music player is the most energy-consuming application. A tone icon in the right lower corner indicates that the player is active.

SOLUTION: turn off the player.

PROBLEM: Another version of firmware is beeing installed on the device.

POSSIBLE CAUSE 1: An older version of firmware is in internal memory.

SOLUTION: Delete the old firmware file from the root folder of the device's internal memory.

POSSIBLE CAUSE 2:

Two or more firmware files are present. Each version of firmware has a unique name; thereforer, several of them could reside at the same time in root directory of both SD card and internal memory. The system will run the firmware it finds first.

SOLUTION: Prior to copying a new firmware file for installation, find and delete all old firmware files in roots of both SD card and internal memory matching the mask:
"*_PB701SWUPDATE.zip"



PocketBook Int. Room 2201, 22/F.1 Duddell str. Central, Hong Kong
info@pocketbook-int.com, www.pocketbook-int.com

Client Support

For detailed information about service centers in your country please visit the official website of PocketBook International: <http://www.pocketbook-int.com>.

Software version update

When installing firmware, the device is fully formatted: all settings, additionally installed applications, and files loaded by you will be deleted. Prior to updating software, it is recommended to save all of your important data to a PC or any other storage medium.

To update a software version:

1. Select '**Products**' on the manufacturer's official website www.pocketbook-int.com

2. Select PocketBook IQ 701;

3. Click '**Software and Documentation**' link (in the right part of the screen);

4. List '**Firmware**': Select the latest SW version for PocketBook IQ 701 and download it (right-click on the selected file ⇒ 'Save As...' ⇒ select saving location ⇒ 'Save');

***Note:** This page presents new applications for your device; you can also install new games and dictionaries, or read the User Manual'.*

5. Copy firmware archive file to the SD card (supplied optionally);

6. Remove SD-card with new firmware update and insert it into PocketBook IQ 701;

The firmware file can be also be directly loaded to the root folder of the device's internal memory.

7. Turn off the PocketBook IQ 701 by pressing 'On/Off' button and choosing 'Turn off' option from context menu;

8. Press and hold 'Volume +' button and, keeping it pressed, push the 'On/Off' button;

9. Release all buttons and wait until installation of the firmware is complete. After that the device will reboot automatically;

10. To check a firmware version, select 'Settings' ⇒ 'About device'.

Note: *If a firmware file is in the root folder of the device, it will take priority over the file on SD card during the update procedure.*

Compliance with international standards

The EUT should only be connected by adapter to a complied Limited Power Source. The adapter supplier/model and power supply specification:

AC Power:

Manufacturer: Huntkey

Model: HKA01812015-2D/3D

Rated output voltage: DC 12V 1.5A)



This equipment is marked with the 0984 symbol and can be used throughout the European community.

This indicates compliance with the R&TTE Directive 1999/5/EC and meets the relevant parts of the following technical specifications:

- EN 300 328 V1.7.1 – Electromagnetic compatibility and Radio spectrum Matters (ERM); Wideband Transmission Systems; Data transport equipment operating in the 2.4 GHz ISM band and using wide band modulation techniques; Harmonized EN covering essential requirements under article 3.2 of the R&TTE Directive
- EN 301 489-1 V1.8.1 - Electromagnetic compatibility and Radio spectrum Matters (ERM); ElectroMagnetic Compatibility (EMC) standard for radio equipment and services; Part 1: Common technical requirements
- ETSI EN 301 489-7 V1.2.1 Electromagnetic compatibility and Radio spectrum Matters (ERM); ElectroMagnetic Compatibility (EMC) standard for radio equipment and services; Part 7: Specific conditions for mobile and portable radio and ancillary equipment of digital cellular radio telecommunications systems (GSM and DCS)
- EN 301 489-17 V2.1.1 - Electromagnetic compatibility and Radio spectrum Matters (ERM); EMC standard for radio equipment and services; Part 17: Specific conditions for 2.4 GHz wideband transmission systems and 5 GHz high performance RLAN equipment
- ETSI EN 301 489-24 V1.4.1- Electromagnetic compatibility and Radio spectrum Matters (ERM); ElectroMagnetic Compatibility (EMC) standard for radio equipment and services; Part 24: Specific conditions for IMT-2000 CDMA Direct Spread (UTRA) for Mobile and portable (UE) radio and ancillary equipment

- ETSI EN 301 511 V9.0.2 - Global System for Mobile communications (GSM); Harmonized EN for mobile stations in the GSM 900 and GSM 1 800 bands covering essential requirements under article 3.2 of the R&TTE directive (1999/5/EC)
- ETSI EN 301 908-1 V3.2.1 - Electromagnetic compatibility and Radio spectrum Matters (ERM); Base Stations (BS), Repeaters and User Equipment (UE) for IMT-2000 Third-Generation cellular networks; Part 1: Harmonized EN for IMT-2000, introduction and common requirements, covering essential requirements of article 3.2 of the R&TTE Directive
- EN60950-1:2006+A11:2009 - Information technology equipment - Safety - Part 1: General requirements
- EN 62311: 2008 - Assessment of electronic and electrical equipment related to human exposure restrictions for electromagnetic fields (0 Hz-300 GHz)

France - 2.4GHz for Metropolitan France:

In all Metropolitan departments, wireless LAN frequencies can be used under the following conditions, either for public or private use:

- Indoor use: maximum power (EIRP*) of 100 mW for the entire 2400-2483.5 MHz frequency band
- Outdoor use: maximum power (EIRP*) of 100 mW for the 2400-2454 MHz band and with maximum power (EIRP*) of 10 mW for the 2454-2483 MHz band.

Important: Changes or modifications to this product not authorized could void the EMC and wireless compliance and negate your authority to operate the product. This product has demonstrated EMC compliance under conditions that included the use of compliant peripheral devices and shielded cables between system components. It is important that you use compliant peripheral devices and shielded cables between system components to reduce the possibility of causing interference to radios, televisions, and other electronic devices.

FCC Compliance Statement

This device complies with part 15 of the FCC rules. Operation is subject to the following two conditions: (1) this device may not cause harmful interference, and (2) this device must accept any interference received, including interference that may cause undesired operation.

Note: This equipment has been tested and found to comply with the limits for a Class B digital device, pursuant to part 15 of the FCC Rules. These limits are designed to provide reasonable protection against harmful interference in a residential installation. This equipment generates, uses and can radiate radio frequency energy and, if not installed and used in accordance with the instructions, may cause harmful interference to radio communications. However, there is no guarantee that interference will not occur in a particular installation. If this equipment does cause harmful interference to radio or television reception, which can be

determined by turning the equipment off and on, the user is encouraged to try to correct the interference by one or more of the following measures:

- Reorient or relocate the receiving antenna.
- Increase the separation between the equipment and receiver.
- Connect the equipment into an outlet on a circuit different from that to which the receiver is connected.
- Consult the dealer or an experienced radio/TV technician for help.

FCC Radiation Exposure Statement

This equipment complies with FCC RF radiation exposure limits set forth in an uncontrolled environment. This transmitter must not be co-located or operating in conjunction with any other antenna or transmitter.

The device was tested and complies to measurement standards and procedures specified in FCC OET Bulletin 65, Supplement C

Certification information (SAR) The device meets guidelines for exposure to radio waves.

Your device is a radio transmitter and receiver. It is designed not to exceed the limits for exposure to radio waves recommended by international guidelines. These guidelines were developed by the independent scientific organization ICNIRP and include safety margins designed to assure the protection of all persons, regardless of age and health.

The exposure guidelines for devices employ a unit of measurement known as the Specific Absorption Rate or SAR. The SAR limit stated in the ICNIRP guidelines is 2.0 watts/kilogram (W/kg) averaged over 10 grams of tissue. Tests for SAR are conducted using standard operating positions with the device transmitting at its highest certified power level in all tested frequency bands. The actual SAR level of an operating device can be below the maximum value because the device is designed to use only the power required to reach the network.

The highest SAR value under the ICNIRP

Band	Channel	EU 10g SAR Limit	Highest 10g SAR Value
802.11 b	7	2 W/kg	0.265 W/kg

This equipment complies with the European Council Recommendation of 12 July 1999 on the Limitation of

Exposure of the General Public to Electromagnetic Fields [1999/519/EC].



PocketBook Int. Room 2201, 22/F.1 Duddell str. Central, Hong Kong
info@pocketbook-int.com, www.pocketbook-int.com

Assembled in China

Designed by Pocketbook Int. Room 2201, 22/F.1 Duddell str. Central, Hong Kong

“Contains Reader® Mobile technology by Adobe Systems Incorporated”