

26" HD-LCD TV/DVD Combo with High Definition ATSC Tuner FXM-2611C



SERVICE MANUAL



Important Service and Safety Information



WARNING



CAUTION

Prior to using this service manual, please ensure that you have carefully followed all the procedures outlined in the user's manual for this product.

- (1) Read all of these instructions.
- (2) Save these instructions.
- (3) Follow all warnings and instructions marked on the product.
- (4) Unplug this product from the wall outlet before cleaning. Do not use liquid cleaners or aerosol cleaners; use a damp cloth for cleaning.
- (5) Do not use this product near water.
- (6) Do not place this product on an unstable cart, stand or table. The product may fall, causing serious damage to the product.
- (7) Slots and openings in the cabinet and the back or bottom are provided for ventilation, to ensure reliable operation of the product and to protect it from overheating, those openings must not be blocked or covered. The openings should never be blocked by placing the product on a bed, sofa, rug, or other similar surface. This product should not be placed in a built-in installation unless proper ventilation is provided.
- (8) This product should be operated from the type of power source indicated on the marketing label. If you are not sure of the type of power available, consult your dealer or local power company.
- (9) This product is equipped with a 3-wire grounding type plug, a plug having a third (grounding) pin. This plug will only fit into a grounding-type power outlet. This is a safety feature, if you are unable to insert the plug into the outlet, contact your electrician to replace your obsolete outlet. Do not ignore the purpose of the grounding-type plug.
- (10) Do not allow anything to rest on the power cord. Do not locate this product where people will walk on the cord.
- (11) If an extension cord is used with this product, make sure that the total of the ampere ratings on the product plugged into the extension cord does not exceed 15 ampere.
- (12) Never push objects of any kind into this product through cabinet slots as they may touch dangerous voltage points or short out parts that could result in a risk of fire or electric shock. Never spill liquid of any kind on the product.
- (13) Do not attempt to service this product yourself, as opening or removing covers may expose you to dangerous voltage points or other risks. Refer all servicing to service personnel.
- (14) Unplug this product from the wall outlet and refer servicing to qualified service personnel under the following conditions:
 - a. When the power cord or plug is damaged or frayed.
 - b. If liquid has been spilled into the product.
 - c. If the product has been exposed to rain or water.
 - d. If the product does not operate normally, when the operating instructions are followed. Adjust only those controls that are covered by the operating instructions since improper adjustment of other controls may result in damage and will often require extensive work by a qualified technician to restore the product to normal operation.
 - e. If the product has been dropped or the cabinet has been damaged.
 - f. If the product exhibits a distinct change in performance, indicating a need for service.

Important Service and Safety Information

Service work should be performed only by qualified service technicians familiar with all safety checks and these service guidelines:

ELECTRIC SHOCK HAZARD



WARNING

Always disconnect AC power before servicing!

Never modify any circuit!

Never insert any objects into the holes in the TV case!

ELECTROSTATIC DISCHARGE (ESD)

Components inside an LCD or plasma TV are sensitive to static electricity. Before servicing the TV, follow these guidelines:

- Avoid static-causing surfaces such as carpeted floors, plastic, and packing foam.
- Remove replacement components from their antistatic bags only when you are ready to use them. Do not lay components on the outside of antistatic bags because only the inside of the bags provide electrostatic protection.
- Always hold components by their edges. Avoid touching the edge connectors. Never slide components over any surface.
- Wear a grounding wrist strap (available at most electronics stores) and attach it to a bare metal part of your workbench or other grounded connection.
- Touch a bare metal surface on your workbench or other grounded object before touching any components.

NOTICE ABOUT REPLACEMENT PARTS



CAUTION

Many electrical and mechanical parts within LCD or plasma televisions are chosen for their specific safety characteristics within the overall system. Replacing individual parts with components rated for higher voltage or wattage can be dangerous!

Replacement parts must always be identical to those originally used in the television. Unauthorized substitute parts may result in fire, electric shock, or other hazards.

Table of Contents

1. Specifications	5
2. Operation.....	7
3. Troubleshooting Flow Chart.....	13
4. Polaroid Display Cell Defect Specification	15
5. Before Returning This Product to the User	16
6. Disassembly Procedure	17
Rear Cover Removal.....	18
Main Board Removal and Replacement.....	20
Control Button Board Removal and Replacement.....	22
DVD Module Board Removal and Replacement.....	23
Power Board Removal and Replacement.....	24
IR / Power LED Board Removal and Replacement	25
7. Spare Parts List – FXM-2611C.....	26
8. Exploded View Diagram – FXM-2611C.....	27
9. Block Diagrams – FXM-2611C.....	28
10. Schematic Diagrams – FXM-2611C.....	30
11. PCB Layout Diagrams	38



1. Specifications

FXM-2611C Specifications:

TFT-LCD Resolution		1366x768
TFT-LCD Screen Size		26 inches
Laser Wavelength		780/650 nm
Video System		NTSC
Frequency Response		20Hz-20kHz ± 2.5 dB
Audio Signal-to-noise Ratio		≥ 85 dB
Audio distortion + noise		≤ 70 dB (1kHz)
Channel Separation		≥ 70 dB (1kHz)
Dynamic Range		≥ 80 dB (1kHz)
Audio Out	Analog Audio Out	Out Level: $1.5V \pm_{1.0}^{0.2}$, Load: $10K\Omega$
Video Out	Video Out	Out Level: $1V_{p-p} \pm 0.1$, Load: 75Ω Unbalanced Negative
Power		AC110-220V 50/60Hz
Power Consumption		< 230 W
Ambient Temperature		10—45°C (50—113°F)

DESIGN AND SPECIFICATIONS ARE SUBJECT TO CHANGE WITHOUT NOTICE

Discs Formats Supported By This Player:

	DISC LOGO	CONTENTS	SIZE	MAXIMUM TIME
DVD		Audio + Video (movies)	12cm	133min(SS-SL)
				242min(SS-DL)
				266min(DS-SL)
				484min(DS-DL)
CD		Audio	12cm	74min
JPEG		Still Photographs	12cm	

- The operating method of some DVD discs is specified by the software maker. Please refer to the instruction manual of the disc.
- The DVD Player will play most recordable (CD-R) or erasable (CD-RW) CDs, but playback of CD-R or CD-RW discs created on a computer requires proper formatting and finalization of the disc for audio playback. Some computers and/or software programs may not be capable of creating compatible discs.

2. Operation

Front and Right View:



- (1) 26" Color TFT screen - Offers a crystal clear image.
- (2) INPUT button - Press to enter the Input menu and then use the ▲ ▼ buttons to select mode: Tuner, AV1 (Composite 1), AV2 (Composite 2), AV3 (Component 1), AV4 (Component), VGA, HDMI, DVD, then press the Enter button to enter the selected mode.
- (3) MENU button - Press to enter or exit system setup menu.
- (4) CH ▲/▼ button - In TV mode, press to select channels. In setup menu, the same function as ▲/▼ direction buttons.
- (5) VOL ▲/▼ button - Press to decrease or increase the volume, the same function as ◀/▶ direction buttons in setup menu.
- (6) ■ STOP button - Press to stop playback in DVD mode.
- (7) PLAY button - Press to start playback in DVD mode.
- (8) EJECT button - Press to eject the disc out from the disc tray.
- (9) POWER button - Press to enter or exit the standby mode.
- (10) Disc Tray Slot - Insert disc into this slot.
- (11) SD/MS/MMC card port - Insert SD/MS/MMC card into this slot.
- (12) USB Port - Connecting to the USB device.
- (13) Remote Sensor - Remote sensor window for the remote control.
- (14) Power Indicator - In standby mode, it turns red; when operation it is blue;
- (15) Speakers - Provides high quality sound.

Rear View:

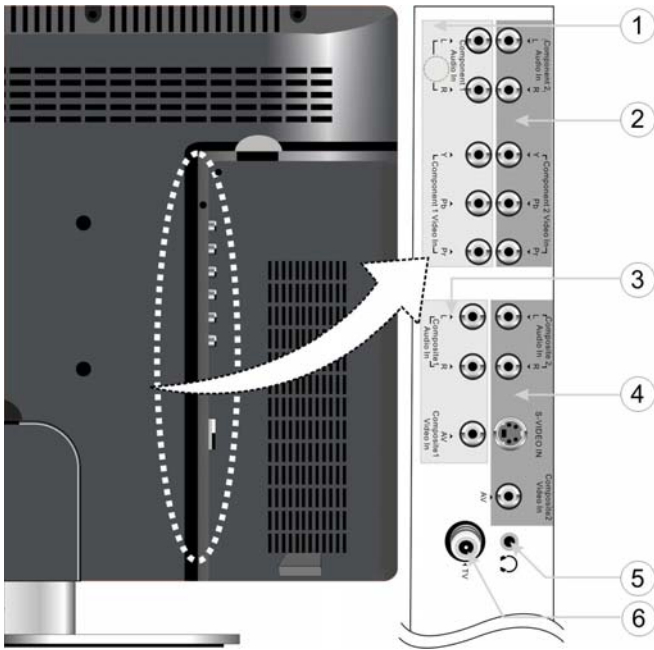

- (1) Y/Pr(Cr)/Pb(Cb) and L/R audio Input Jacks - Connectors for the Y/Pr(Cr)/Pb(Cb) input in AV3 (Component) mode.
- (2) Y/Pr(Cr)/Pb(Cb) and L/R audio Input Jacks - Connectors for the Y/Pr(Cr)/Pb(Cb) input in AV4 (Component) mode.
- (3) Video and L/R audio Input Jacks - Connectors for the audio and video signal input in AV1 (Composite) mode.
- (4) Video/S-VIDEO and L/R audio Input Jacks - Connectors for the audio and video/S-Video signal input in AV2 (Composite) mode. The Video and S-Video is with the same L/R audio jacks, and the S-Video is the priority.
- (5) Earphone Jack - Used for connecting to the earphone.
- (6) TV Signal Input Jack - Connect to TV antenna in TV mode.
- (7) VGA Input Jack - Connect to the VGA output jack of the PC in VGA mode.
- (8) HDMI Jack - Connect to the HDMI.
- (9) OPTICAL audio output Jack - Connectors for the optical digital audio (SPDIF) output.
- (10) AV Output Jack - Connectors for the audio and video signal output.
- (11) Power In Jack - Connect to power supply.

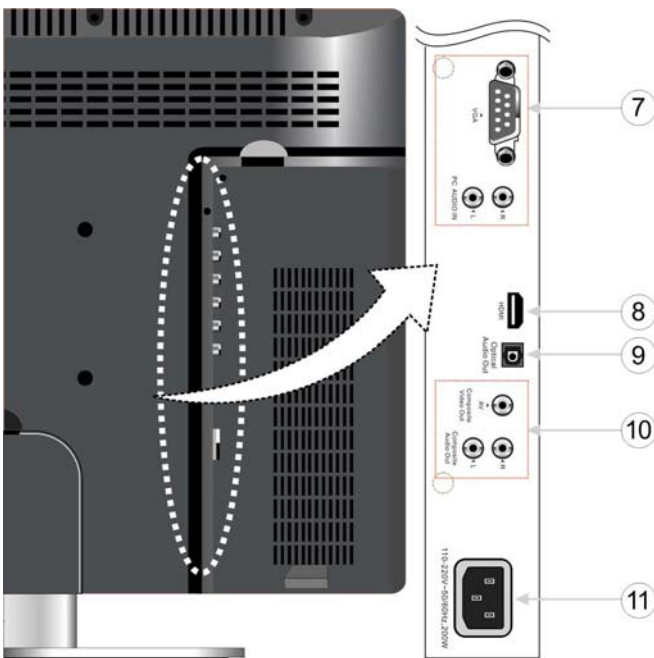

Remote Control – General:

Installing Batteries

Push the back cover to open the battery compartment.

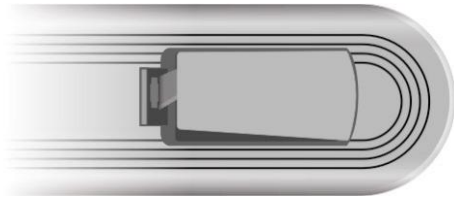

Insert two batteries (1.5V, size AAA), please make sure the polarity matches the marks inside the compartment.

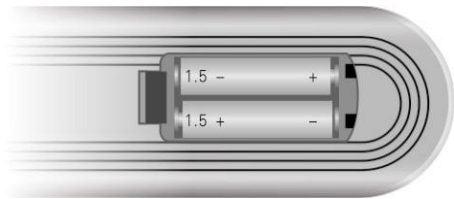

Press the back cover to close it.

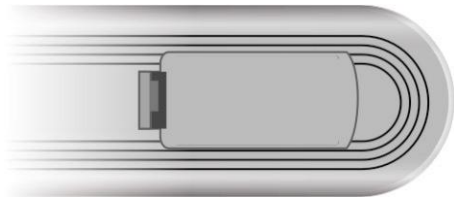

Under normal use the batteries will last for six months. Remove the batteries when the remote will not be used for a long time.

Using Remote control

Point the remote control no more than 7 meters from the remote control sensor and within about 60 degrees of the front of the unit.



The operating distance may vary depending on the surrounding brightness.

Notes:

- Do not point bright lights directly at the remote control sensor.
- Do not place objects between the remote control unit and the remote control sensor.
- Do not use this remote control while simultaneously operating the remote control of any other equipment.

Remote Control – TV Mode:



- (1) **POWER button** - Press to enter or exit the standby mode.
- (2) **0~9 Number buttons** - Press to select numbers.
- (3) **MTS button** - In TV mode, press to shift among SAP, Mono or Stereo mode.
- (4) **VOL +/- button** - Press to increase or decrease the volume.
- (5) **MUTE button** - Press to turn on or off the speaker output.
- (6) **Input button** - Press to enter the Input menu, then use the **▲ ▼** button to select mode: Tuner, AV1 (Composite), AV2 (Composite), AV3 (Component), AV4 (Component), VGA, HDMI, DVD, press the Enter button to enter the selected mode.
- (7) **Direction buttons (▲ ▼ ◀ ▶)** - In the setup menu, press the **▲ ▼** button to select the desired items, press the **◀ ▶** button to adjust or set.
- (8) **Enter button** - Press to confirm selection or exit the setup in the setup menu.
- (9) **Sleep button** - press to set the sleep time.
- (10) **TV button** - Press to shift to TV mode.
- (11) **Signal button** - Press to display the ATSC signal status.
- (12) **▶ button** - Press number buttons to select channel and then press the button to confirm and go the selected channel.
- (13) **+10/- button** - In TV mode, press the number buttons to select channel first, then press this button and add number button "0" or one number from "1~5" to select analog or digital TV program. Add "0" for analog TV program, add one number from "1~5" for digital TV program.
- (14) **Last button** - In TV mode, press to return to the channel last viewed.
- (15) **CH ▲ / ▼ button** - In TV mode, press to select channel.
- (16) **Freeze button** - Press to freeze the current picture.
- (17) **Menu button** - Press to enter or exit the system setup menu.
- (18) **Exit button** - Press to exit system setup menu.
- (19) **CC button** - Press to display among CC1, CC2, CC3, CC4 or CCD function OFF.
- (20) **Info. Button** - Press to display the current mode information on the screen.

Remote Control – DVD Mode:

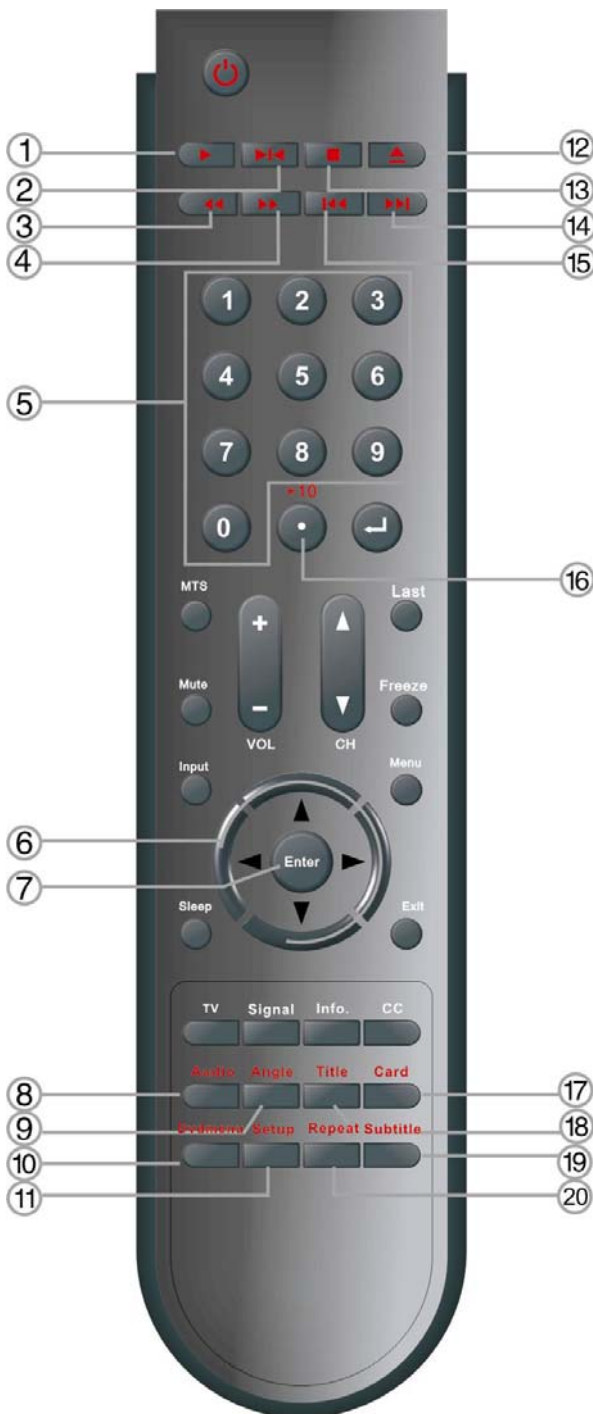

- (1) ▶ **Play button** - Press to play the disc in DVD mode.
- (2) ⏸ **Pause button** - In DVD mode, press to pause the playback or start step frame by frame playback. Press the ▶ PLAY button to resume normal playback.
- (3) ⏮ **Fast Reverse button** - In DVD mode, press to search backward
- (4) ⏭ **Fast Forward button** - In DVD mode, press to search forward.
- (5) **0~9 Number buttons** - Press to select numbers.
- (6) **Direction buttons (▲▼◀▶)** - In the setup menu, press the ▲▼ button to select the desired items, press the ◀▶ button to adjust or set.
- (7) **Enter button** - Press to confirm selection or exit the setup in the setup menu.
- (8) **Audio button** - In DVD mode, press to select audio language when the DVD disc with multiple audio languages is played.
- (9) **Angle button** - In DVD mode, press to select various camera angles (if the DVD disc contains multiple camera angles).
- (10) **DVD menu button** - Press to access the disc menu in DVD mode.
- (11) **Setup button** - Press to access the DVD setup menu under DVD mode.
- (12) ▲ **Eject button** - Press to eject the disc out.
- (13) ■ **Stop button** - In DVD mode, press to stop playback, then press the PLAY button to resume normal playback. Press the STOP button twice repeatedly to stop completely.
- (14) ⏮ **Next Skip button** - Press to skip to the next chapter/track for some discs under DVD mode.
- (15) ⏮ **Previous Skip button** - Press once to skip to the beginning of the current chapter/track. Press twice repeatedly to skip to the previous chapter/track for some discs under DVD mode.
- (16) +10/- **button** - Press the button and 0~9 number buttons to select number greater than 9.
- (17) **Card button** - In DVD mode, press to shift to USB or CARD mode when there is the input source.
- (18) **Title button** - In DVD mode, during a DVD disc playback, press to go to title menu if the disc contains.
- (19) **Subtitle button** - In DVD mode, press to select different subtitle languages during a multiple language DVD disc playback.
- (20) **Repeat button** - In DVD mode, press to repeat a chapter, track, title, or all content

Moving the DVD Disc Tray:

CAUTION: Before removing or installing the DVD disc tray, unplug the power supply cord.

This unit is designed with a movable DVD Disc Tray. The Disc Tray can be installed in three different positions giving you the ability to maximize space and convenience. Follow the procedure (below) to remove and reinstall.

Remove the DVD Disc Tray:

- Step 1:** Open the back cover by sliding the left rear panel of the unit outward.
- Step 2:** Remove the DVD disc tray.
- Loosen and remove the screw holding the DVD disc tray in place.
 - Disconnect the MGI connecting cord from the LCD TV and DVD disc tray.
 - Remove the DVD disc tray by pushing it outward.
- Step 3:** Close the back cover.

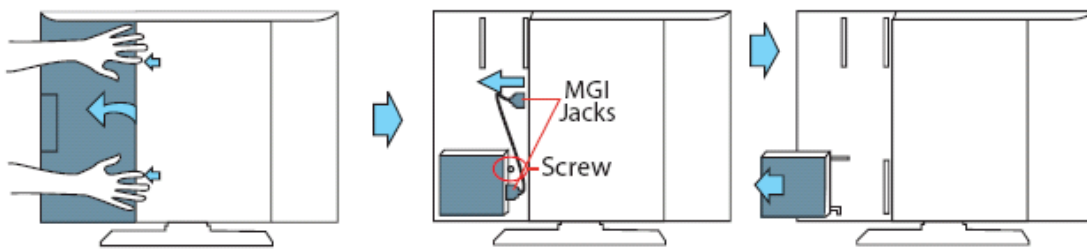

Installing the DVD Disc Tray:

There are three different positions for installing the DVD disc tray and two MGI jacks for connecting the MGI connecting cord.

NOTE: The bottom DVD disc tray position (3) is designed for TVs that are wall-mounted. If you would like to install the DVD disc tray in the bottom position (3), remove the stand. To remove the stand, cover the screen with a soft cloth and place the LCD screen face down on a stable surface. Remove the screws securing the stand to the TV. (VESA 200 wall-mounting kit and instructions are not included.)

- Step 1:** Open the back cover on the left rear panel of the unit and select which of the three possible positions you would like to install your DVD disc tray in.
- Step 2:** Insert the DVD disc tray and lock into place using the screw. Plug one end of the MGI connecting cord into the DVD disc tray. Plug the other end of the MGI connecting cord into the MGI jack on the LCD TV.
- Step 3:** Close the back cover.

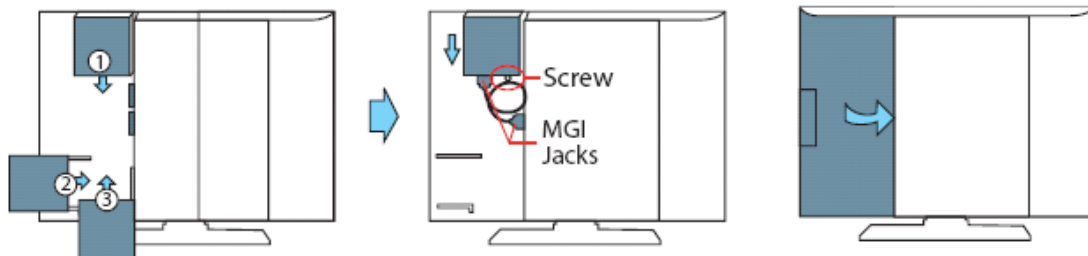

3. Troubleshooting Flow Chart

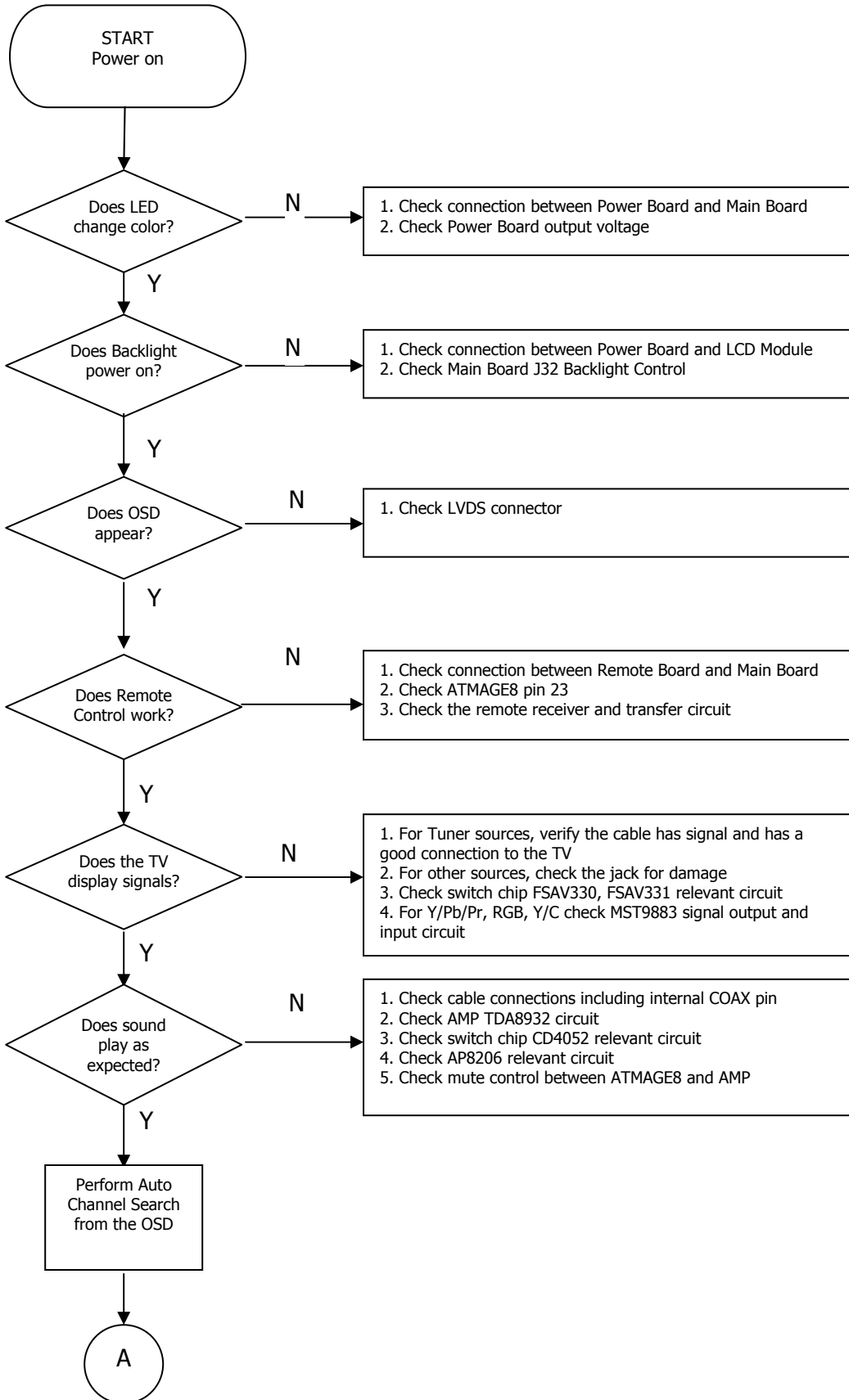

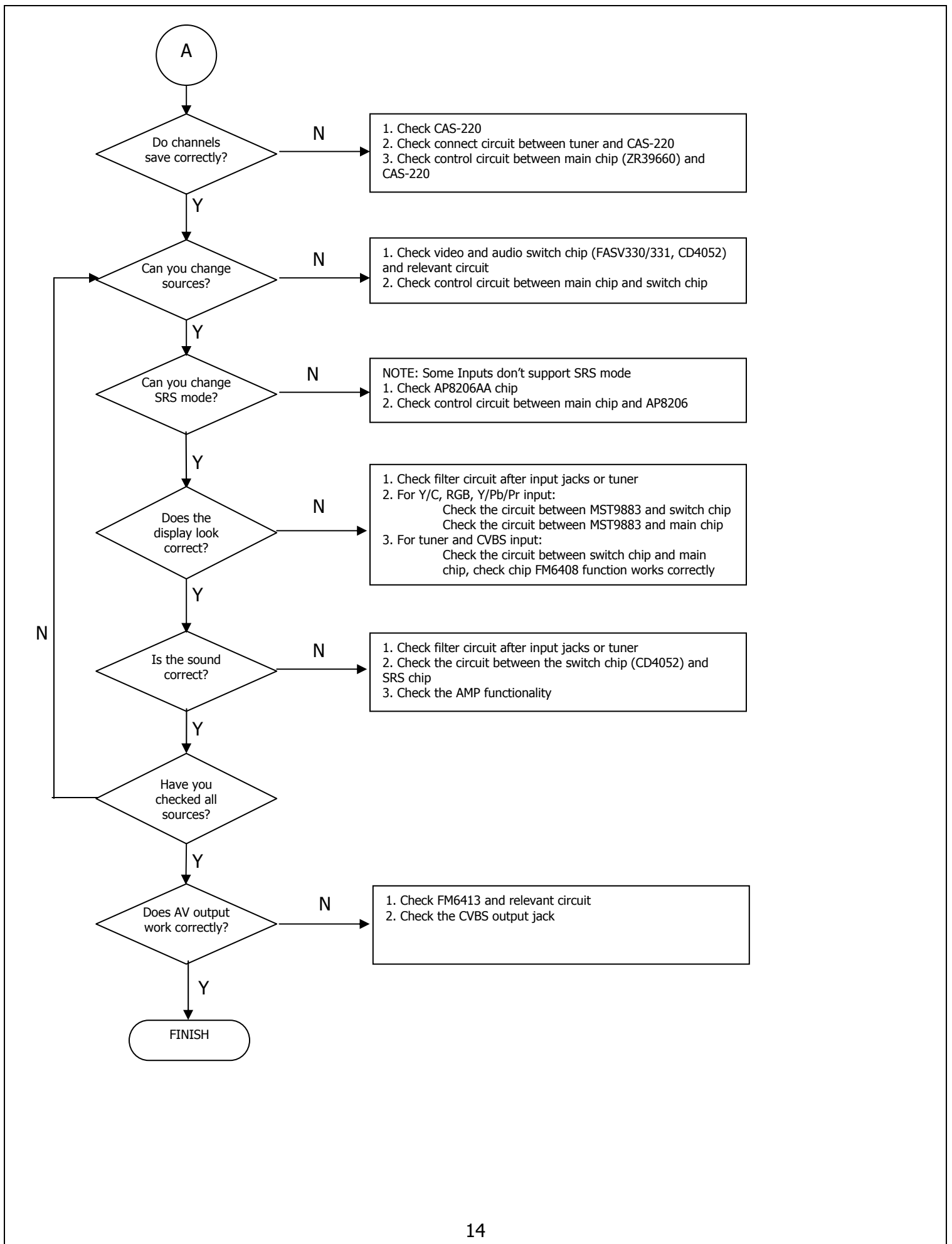

4. Polaroid Display Cell Defect Specification

In some cases, a panel may have defective cells that cannot be controlled.

These defective cells can be categorized into two types;

- (1) Non-lighting or dark cell defect: defect in which the cell is always off
- (2) Non-extinguishing or bright cell defect: defect in which the cell is always on

The Polaroid Display Cell Defect Specifications below define the allowed limits for display cell defects and are used as the criteria in determining whether an LCD panel is replaced.

7 or more defective pixels across the entire LCD screen Polaroid will repair (replace LCD panel) or replace the TV.

5. Before Returning This Product to the User

Before returning this product to the user, always perform the following safety checks:

- (1) Inspect all wiring to be sure no wires are pinched between the chassis or any metal parts.
- (2) Inspect all protective devices for proper installation, including non-metallic controls, insulation materials, cabinet backs, compartment covers, and shields.
- (3) Verify that no shock hazard exists on any part of the chassis, especially any metal components including cable connection points, chassis hardware, or antennas (if equipped). Use the following procedure:
 - a. Plug the AC cord directly into a 120 V AC outlet.
 - b. Create a test circuit consisting of a 1.5k ohm, 10 watt resistor paralleled by a 0.15 μ F capacitor.
 - c. Using an AC voltmeter (sensitivity of 5000 ohm per volt or higher), measure the voltage drop across the test circuit between all exposed metallic parts and a known earth ground. Measurement points include antenna, metal cabinet parts, screw heads, and metal knobs or controls. Measurement points can vary slightly even between revisions of the same model, so always conduct a thorough review of the chassis to locate metal points that a user may touch.
 - d. Any voltage reading of 0.375 Vrms AC (0.25 mArms) or higher indicates a potential shock hazard. **THIS CONDITION MUST BE CORRECTED BEFORE RETURNING THE PRODUCT TO THE USER!**
 - e. Repeat the above checks with the AC polarity reversed. A non-polarized adapter is required to reverse the polarity; DO NOT LEAVE THIS ADAPTER WITH THE USER! Under normal operation the product must use the proper polarity.

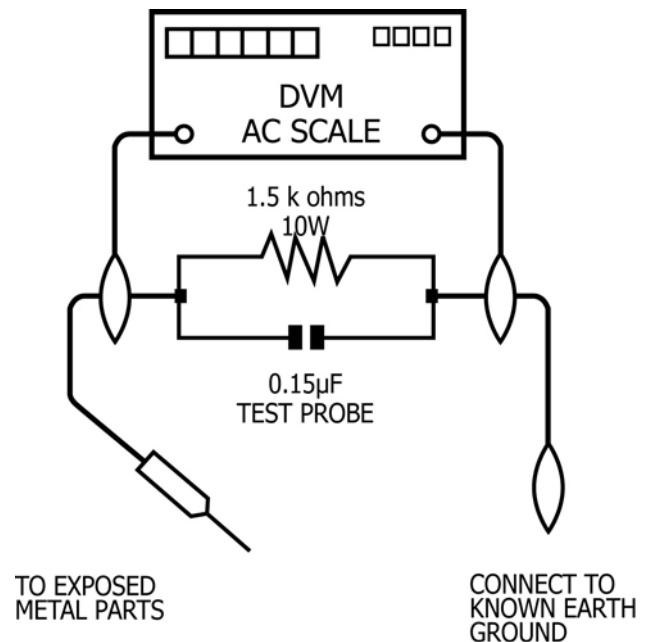

6. Disassembly Procedure



WARNING

Note: Before disassembly of any part the TV, make sure the power is OFF, and the power cord is removed from the wall outlet. Allow time for power within all system boards to discharge before you begin disassembly. Never insert any objects into the vent holes in the TV case.



CAUTION

Note: Before returning this product to the end user, you must follow the steps outlined in the section, *Before Returning This Product to the User*, on page 16. This procedure ensures that the chassis will not cause electric shock.

When servicing an LCD or plasma TV, always observe the following safety guidelines:

- Wear a grounding (ESD) wrist strap, and use a grounded or dissipative work mat.
- Use a stable and strong work surface that is large enough to hold components you might remove.
- When removing components that are attached with a cable, unplug the cable before removing the screws to avoid damaging the cable.
- Use a magnetized screwdriver for removing screws.
- To help keep track of screws, place each component's screws next to the component on your work surface.

ELECTROSTATIC DISCHARGE (ESD)

Components inside an LCD or plasma TV are sensitive to static electricity. Before servicing the TV, follow these guidelines:

- Avoid static-causing surfaces such as carpeted floors, plastic, and packing foam.
- Remove replacement components from their antistatic bags only when you are ready to use them. Do not lay components on the outside of antistatic bags because only the inside of the bags provide electrostatic protection.
- Always hold components by their edges. Avoid touching the edge connectors. Never slide components over any surface.
- Wear a grounding wrist strap (available at most electronics stores) and attach it to a bare metal part of your workbench or other grounded connection.
- Touch a bare metal surface on your workbench or other grounded object before touching any components.

Rear Cover Removal

- (1) Lay TV flat on workbench. Be careful to protect the front bezel and LCD screen from being scratched. Use protective cloth between work bench and TV front.
- (2) Remove back covers A, B, and C.



- (3) Remove DVD Player (A), Cable (B), and Stand Cover (C).



(4) Remove six (6) screws from the TV Stand (A) and remove the stand from the TV.

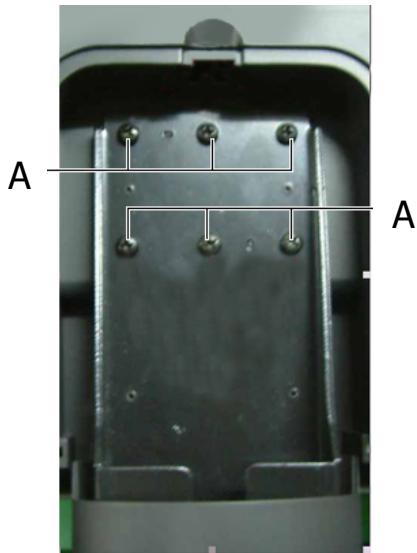

(5) Remove all screws from the rear cover (Location A).

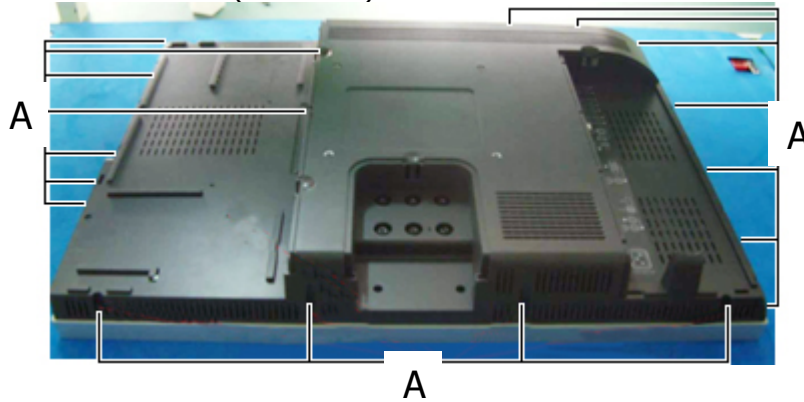

(6) Remove all screws from the rear panel label area (A) and remove rear cover.

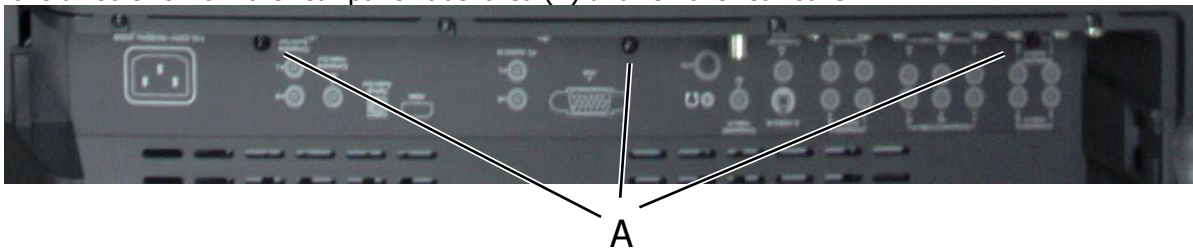

(7) View after rear cover removal:



Main Board Removal and Replacement

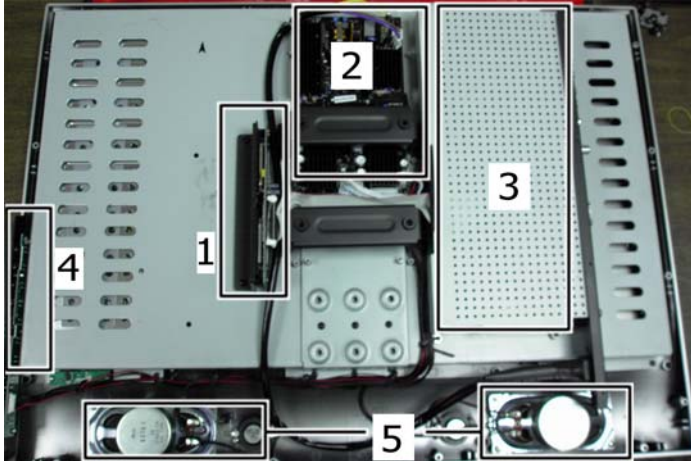

- (1) DVD Module Board
- (2) Power Board
- (3) Main Board
- (4) Control Button Board
- (5) Speakers



Note: Before disassembly of any part the TV, make sure the power is OFF, and the power cord is removed from the wall outlet. Allow time for power within all system boards to discharge before you begin disassembly. Never insert any objects into the vent holes in the TV case.

- (1) Remove rear cover and baffles as shown in the section, Disassembly Procedure on page 17.
- (2) Remove the 4 screws from the top and bottom of the main board cover (Location A), and remove the cover.

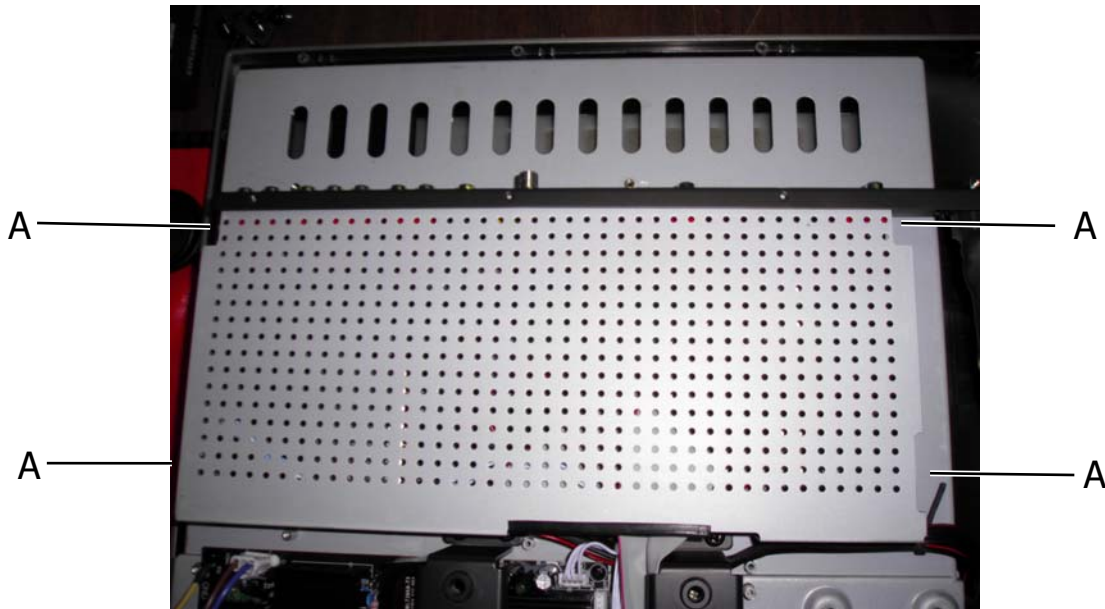

(3) Disconnect cables on Main Board.



(4) Remove all screws from the Main Board (Location A and B) and remove.



Note: Before returning this product to the end user, you must follow the steps outlined in the section, **Before Returning This Product to the User**, on page 16. This procedure ensures that the chassis will not cause electric shock.

Control Button Board Removal and Replacement

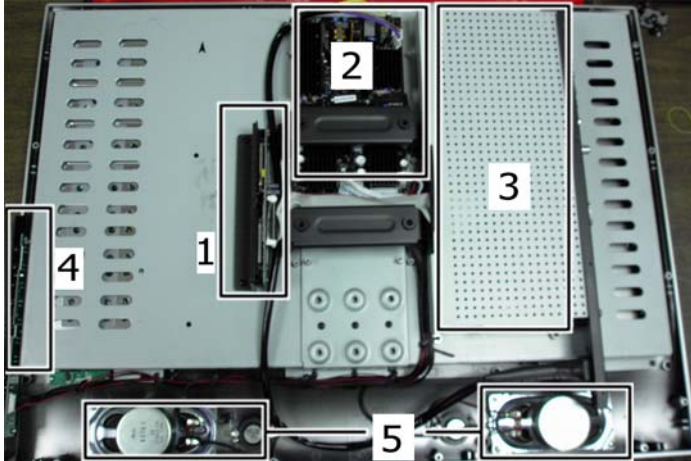

- (1) DVD Module Board
- (2) Power Board
- (3) Main Board
- (4) Control Button Board
- (5) Speakers



Note: Before disassembly of any part the TV, make sure the power is OFF, and the power cord is removed from the wall outlet. Allow time for power within all system boards to discharge before you begin disassembly. Never insert any objects into the vent holes in the TV case.

- (1) Remove rear cover and baffles as shown in the section, Disassembly Procedure on page 17.
- (2) Remove the screws from the control button board cover (Location A), and separate the control button board from the cover.



A



Note: Before returning this product to the end user, you must follow the steps outlined in the section, Before Returning This Product to the User, on page 16. This procedure ensures that the chassis will not cause electric shock.

DVD Module Board Removal and Replacement

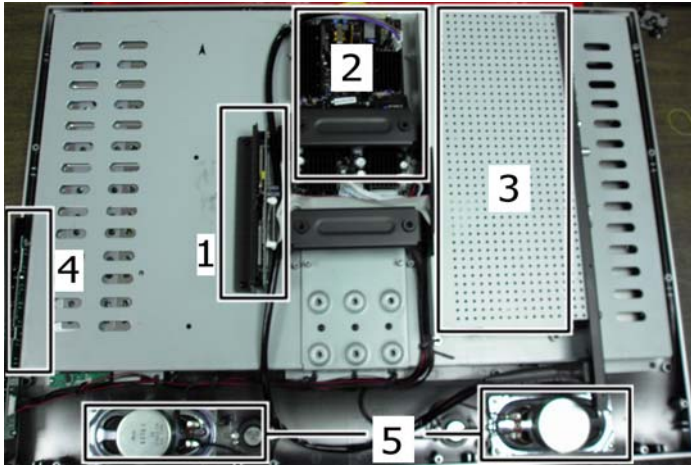

- (1) DVD Module Board
- (2) Power Board
- (3) Main Board
- (4) Control Button Board
- (5) Speakers



Note: Before disassembly of any part the TV, make sure the power is OFF, and the power cord is removed from the wall outlet. Allow time for power within all system boards to discharge before you begin disassembly. Never insert any objects into the vent holes in the TV case.

- (1) Remove rear cover and baffles as shown in the section, Disassembly Procedure on page 17.
- (2) Remove cable from DVD Module Board (A).
- (3) Remove 2 screws from the DVD Module Board Cover (B).
- (4) Separate the DVD Module Board from the Cover.

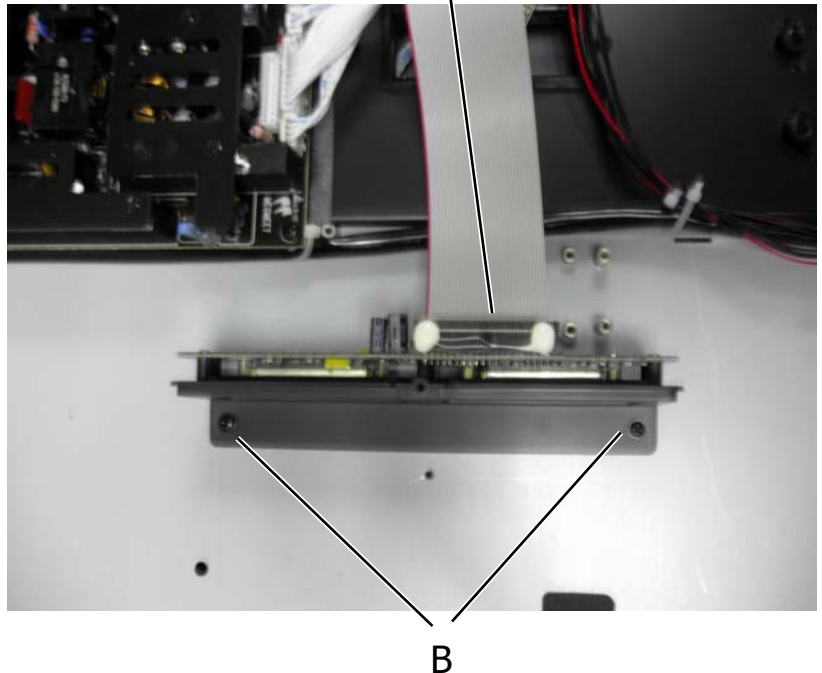

Note: Before returning this product to the end user, you must follow the steps outlined in the section, Before Returning This Product to the User, on page 16. This procedure ensures that the chassis will not cause electric shock.

Power Board Removal and Replacement

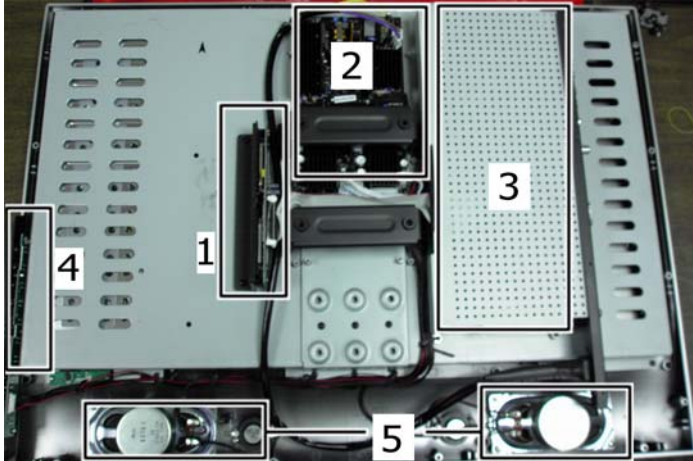

- (1) DVD Module Board
- (2) Power Board
- (3) Main Board
- (4) Control Button Board
- (5) Speakers



Note: Before disassembly of any part the TV, make sure the power is OFF, and the power cord is removed from the wall outlet. Allow time for power within all system boards to discharge before you begin disassembly. Never insert any objects into the vent holes in the TV case.

- (1) Remove rear cover and baffles as shown in the section, Disassembly Procedure on page 17.
- (2) Remove the 4 screws from the Power Board (A).
- (3) Remove 2 Power Board cables (B).

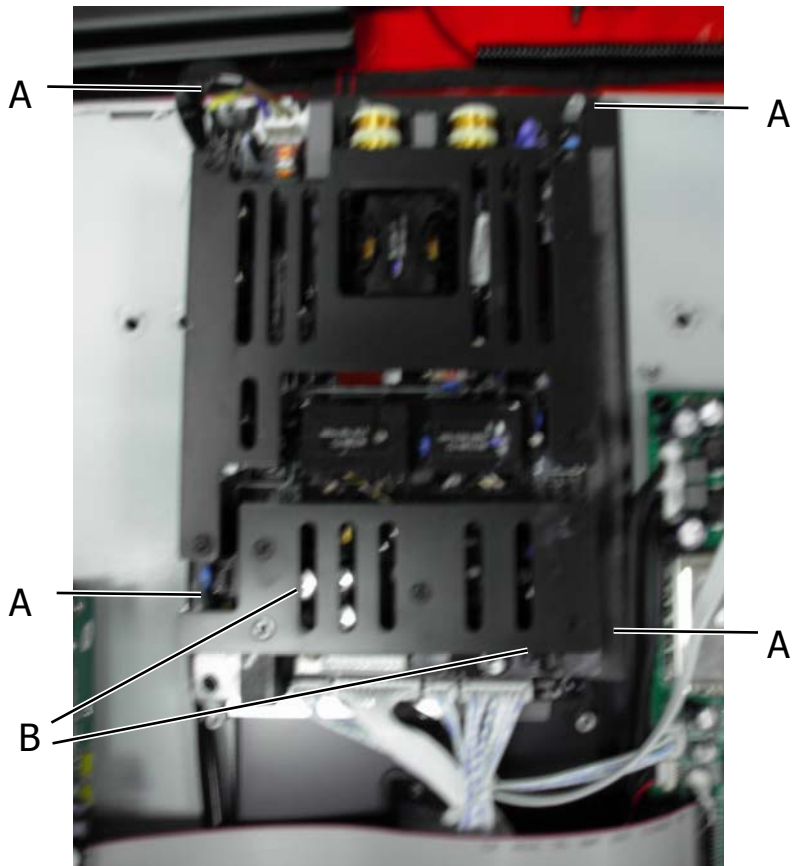

Note: Before returning this product to the end user, you must follow the steps outlined in the section, Before Returning This Product to the User, on page 16. This procedure ensures that the chassis will not cause electric shock.

IR / Power LED Board Removal and Replacement

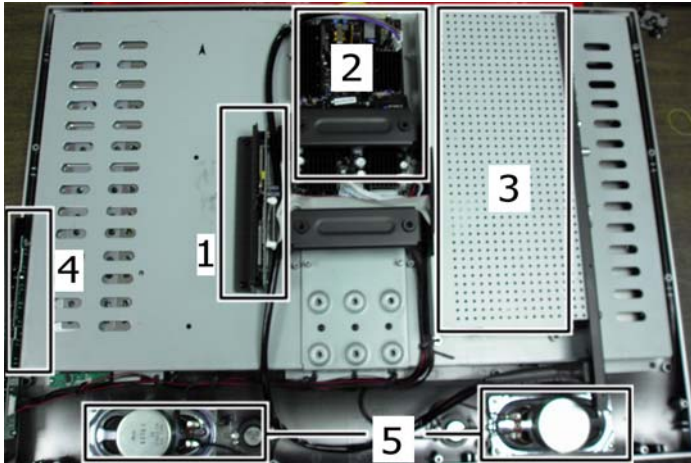

- (1) DVD Module Board
- (2) Power Board
- (3) Main Board
- (4) Control Button Board
- (5) Speakers



Note: Before disassembly of any part the TV, make sure the power is OFF, and the power cord is removed from the wall outlet. Allow time for power within all system boards to discharge before you begin disassembly. Never insert any objects into the vent holes in the TV case.

- (1) Remove rear cover and baffles as shown in the section, Disassembly Procedure on page 17.
- (2) Remove the 2 screws from the IT / Power LED Board and remove the board (A).
- (3) Remove cable (B).

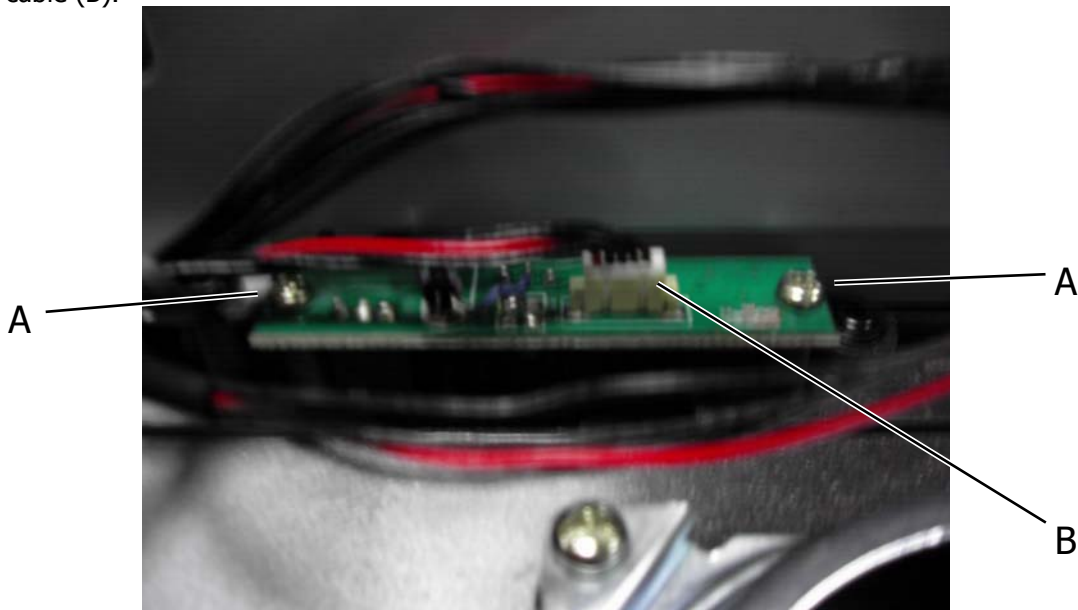

Note: Before returning this product to the end user, you must follow the steps outlined in the section, Before Returning This Product to the User, on page 16. This procedure ensures that the chassis will not cause electric shock.

7. Spare Parts List – FXM-2611C

Part Number	Description
2713C	FXM-26,32,FXX-321C MAIN BOARD
MLT-366A	FXM-2611C POWER BOARD
2635C	FXM, FXX IR/POWER LED BOARD
E270	27" LCD PANEL CMO 00 Interchangeable with E270-01
E270-01	27" LCD PANEL CMO 01 Interchangeable with E270
E090	FXM, FXX MID SPEAKER L-R
E091	FXM, FXX TWEETER SPEAKER L-R
E114	3M AV Cord (yellow-white-red)
E115	3M AV Cord (red-white)
E116	3M AV Cord (red-green-blue)
2628C	FXM, FXX CONTROL BUTTON BOARD
DM-601	FXM, FXX MODULAR DVD PLAYER W/CABLE
LTD62701-RE01	FXM-2611C MIDDLE FRAME
LTD62701-RE02	FXM-2611C BEZEL FRAME
LTD62701-RE03	FXM-2611C BACK FRAME
CAS	FXM, FXX COMPLETE ASSEMBLED STAND
LTD-6	REMOTE CONTROL

8. Exploded View Diagram – FXM-2611C

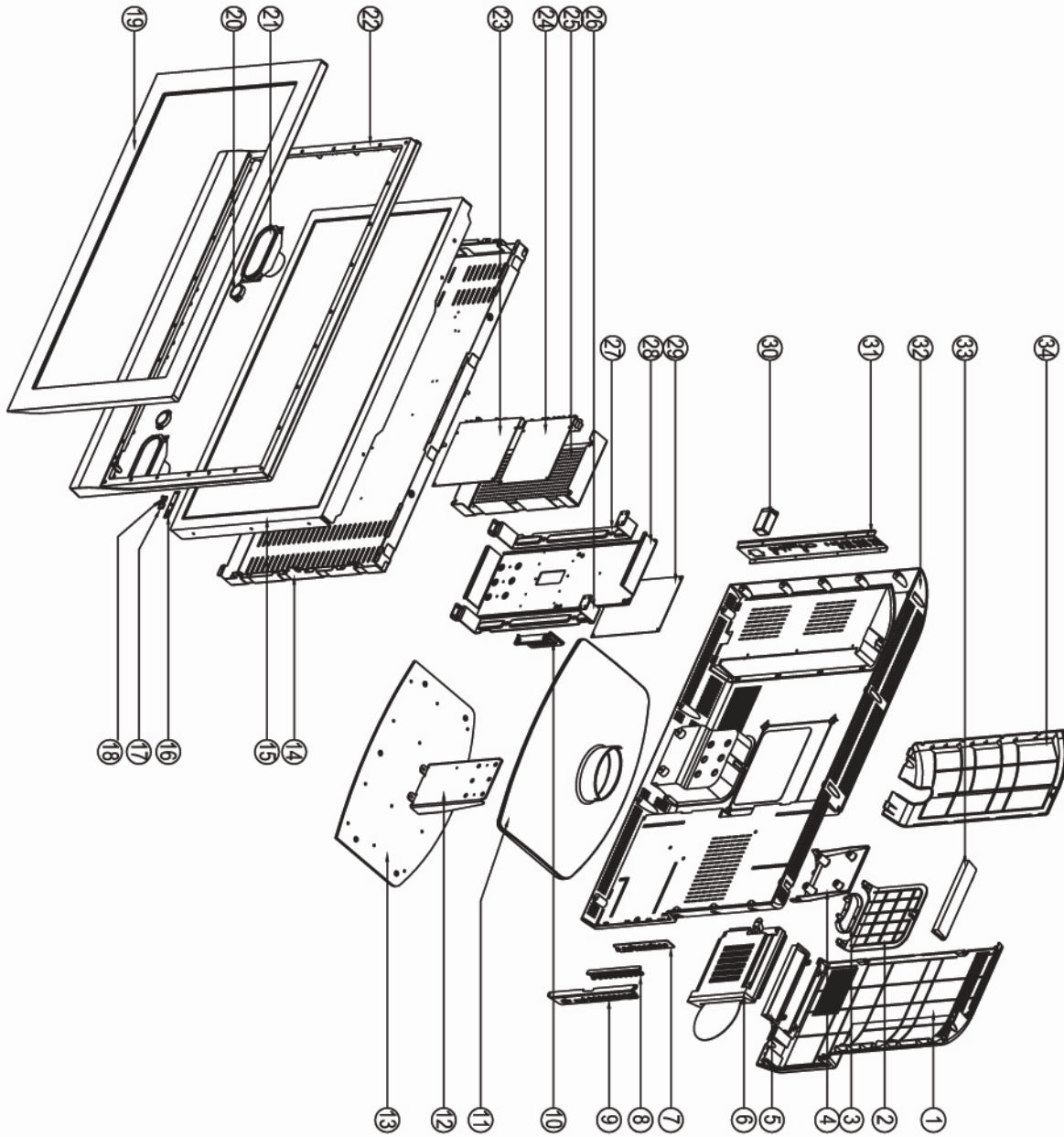

#	Item
1	DVD Back Cover
2	Pedestal Back Cover
3	Cable Clip
4	Pedestal Back Cover
5	DVD Cover
6	DVD Module
7	Control Button Board
8	Bracket
9	Control Button Board Cover
10	DVD Module Board
11	Stand Base Cover
12	Stand Bracket
13	Stand Base
14	LCD Shield Cover
15	26-inch LCD
16	IR / Power LED Board
17	Cover
18	Cover
19	Front Bezel
20	Speaker – Tweeter
21	Speaker
22	Middle Frame
23	Main Board
24	Main Board
25	Main Board Shield Cover
26	Baffle (Right)
27	Baffle (Left)
28	Bracket Link Board
29	Power Board
30	AC Socket
31	Input Cover
32	Back Cover
33	DVD Cover
34	TV Back Cover

9. Block Diagrams – FXM-2611C

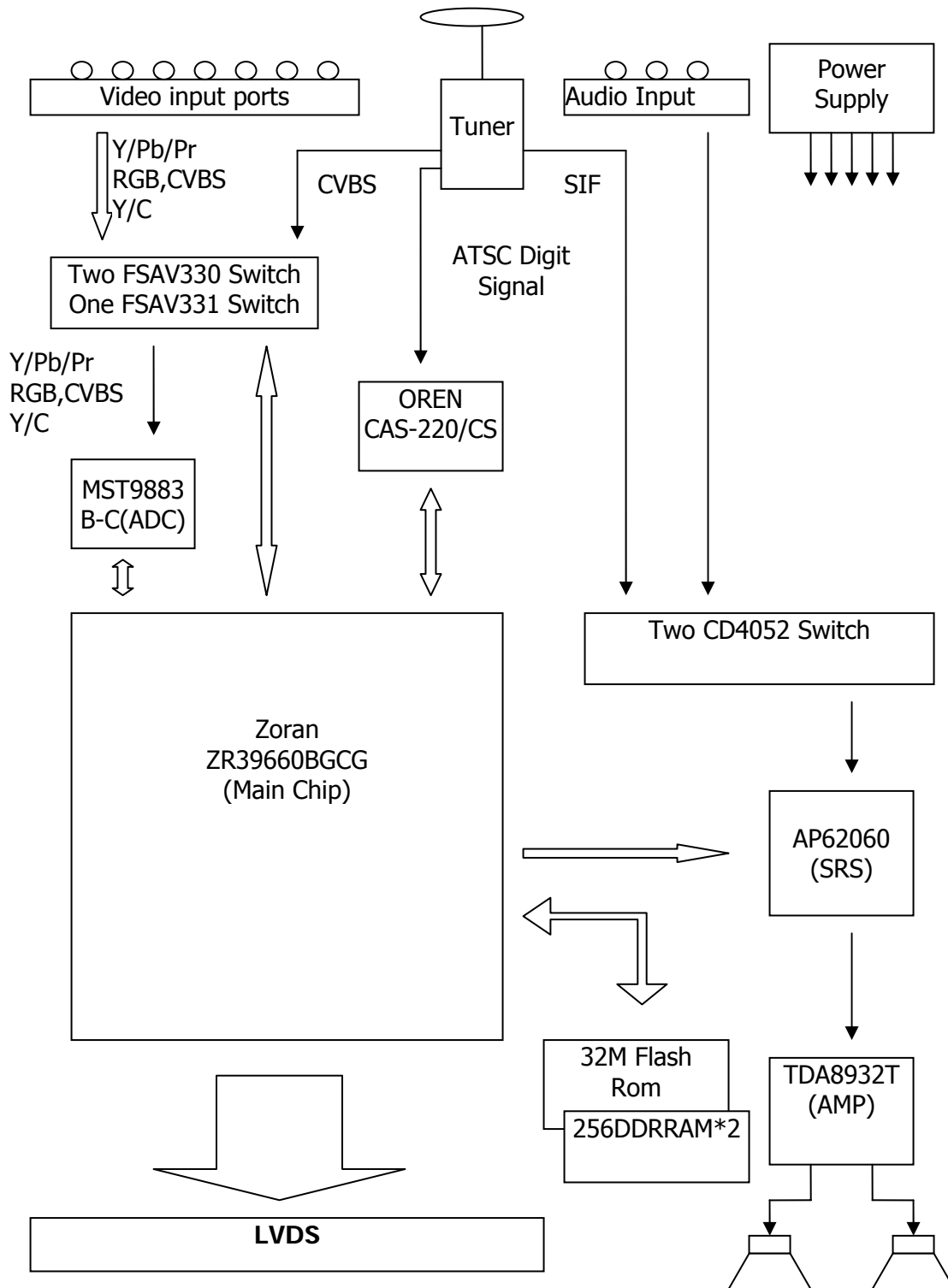

Video Signal Processing Block Diagram

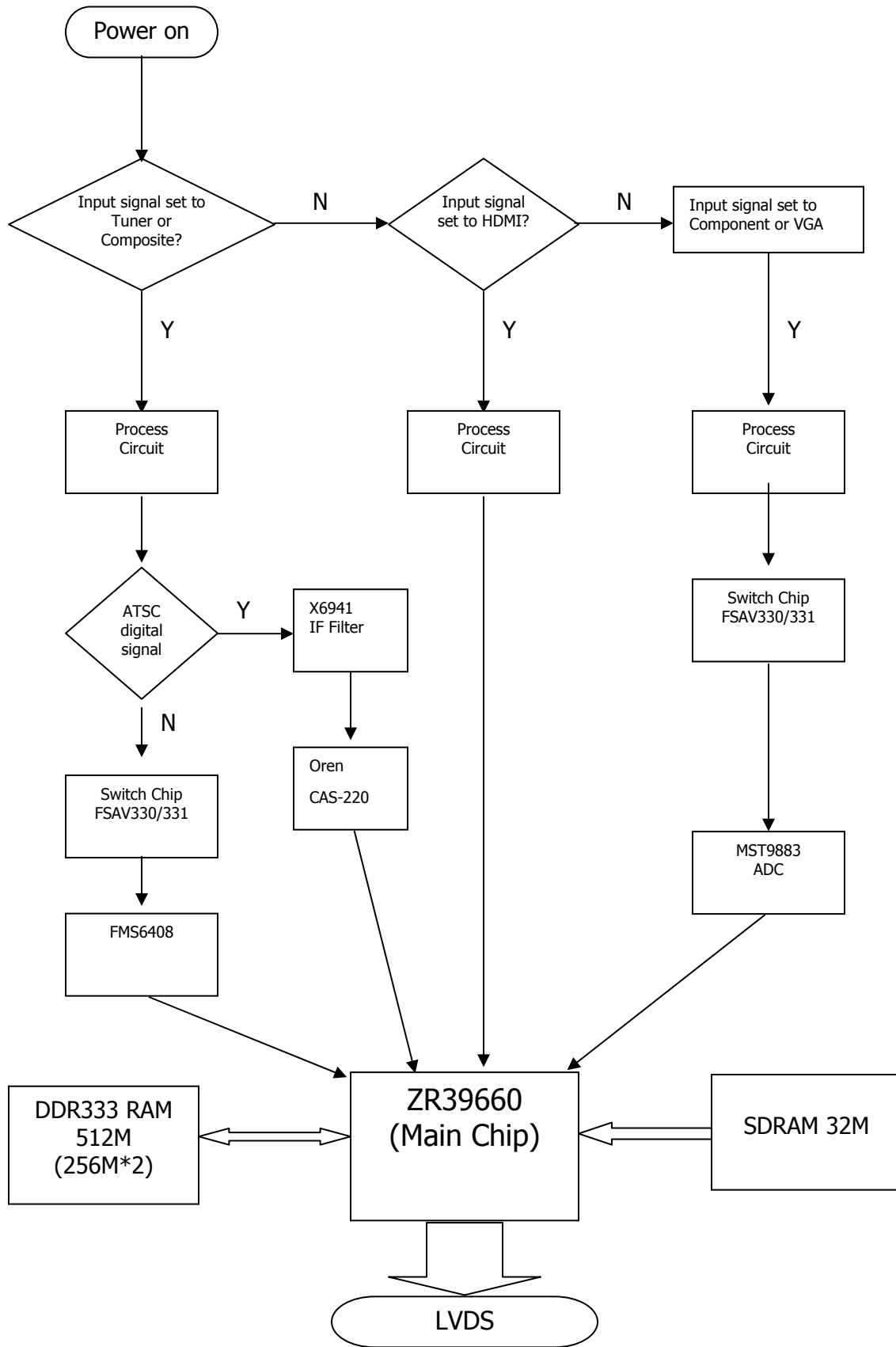

10. Schematic Diagrams – FXM-2611C

Tuner

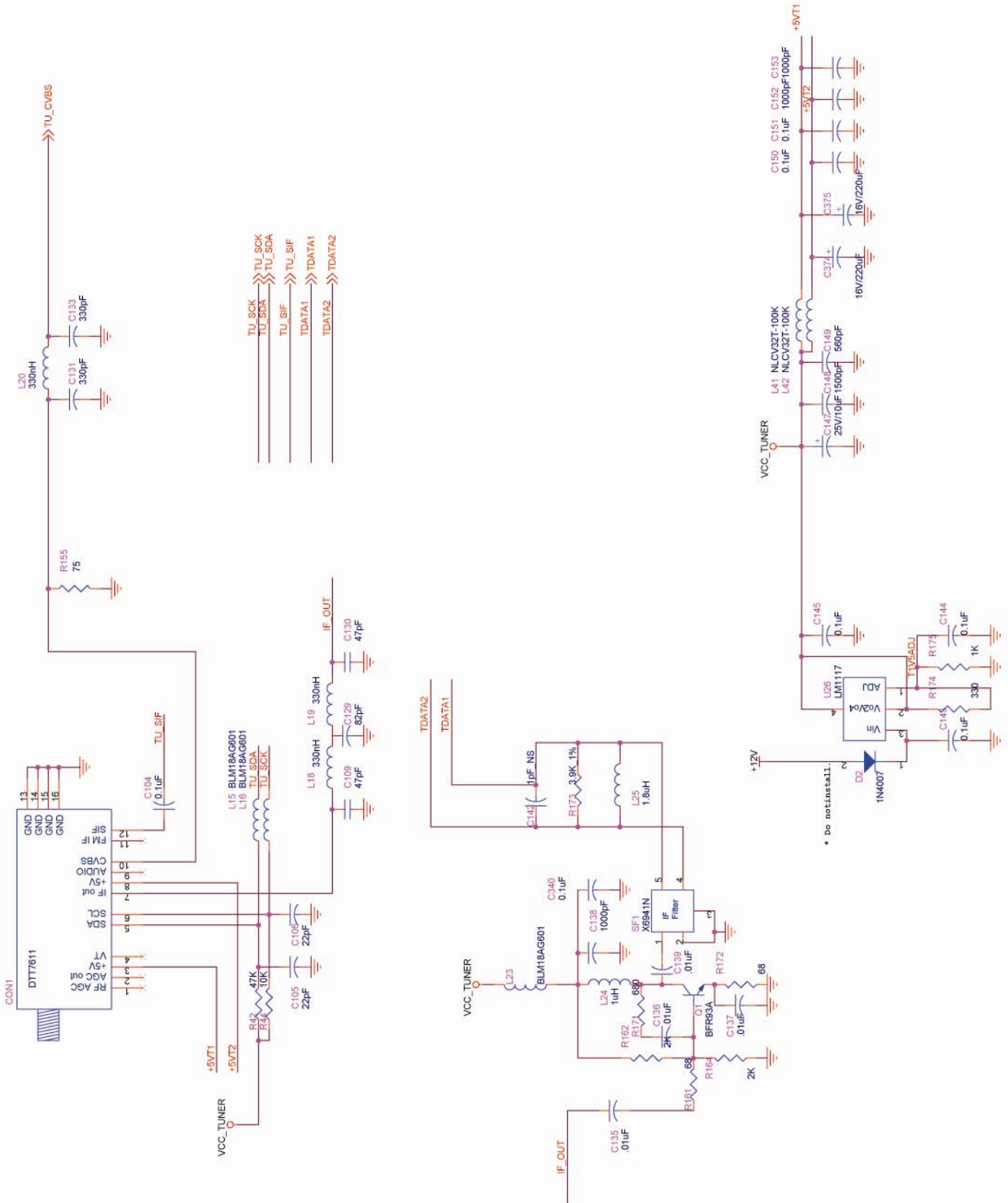

Audio I/O

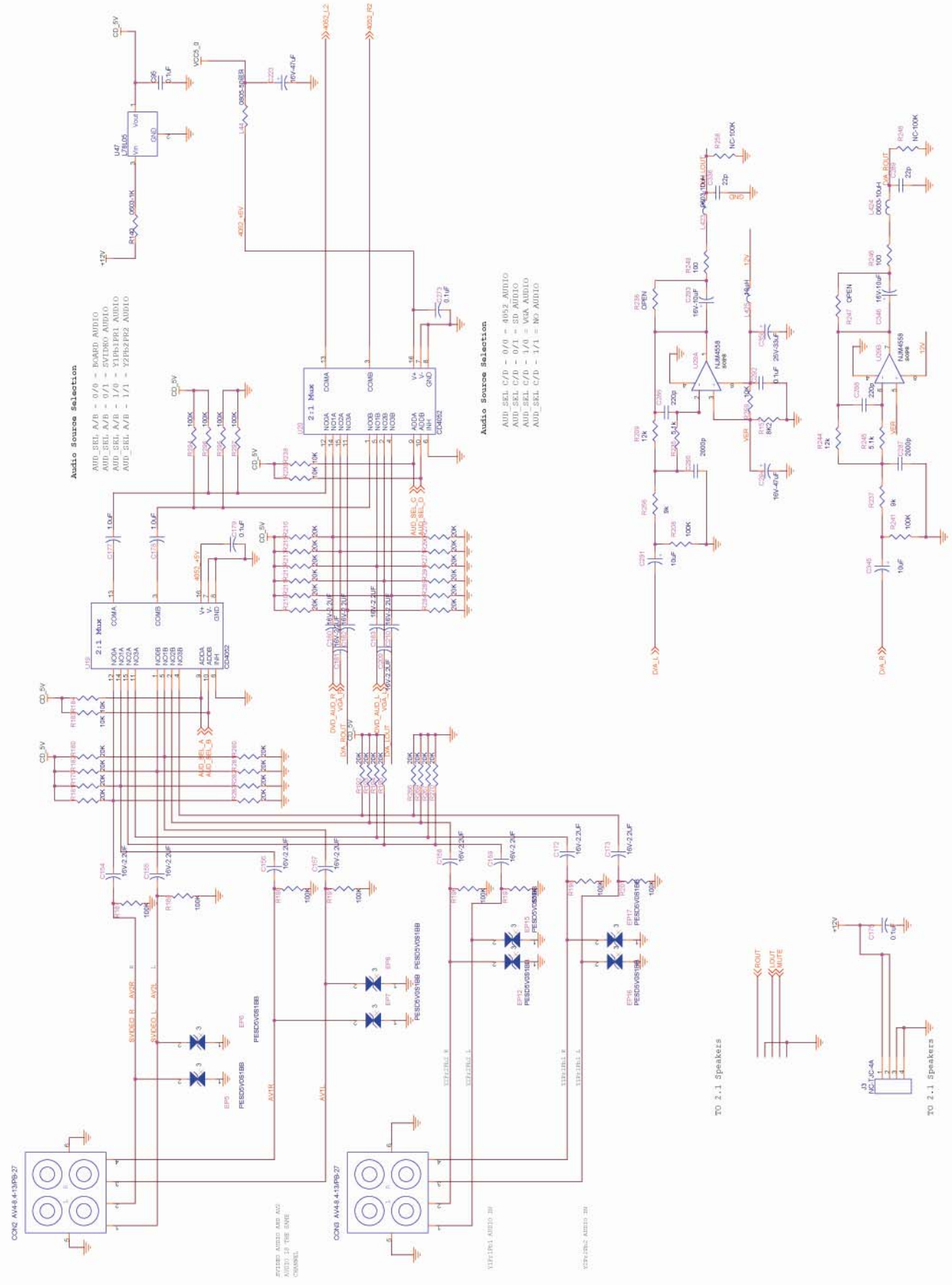

HDMI I/O

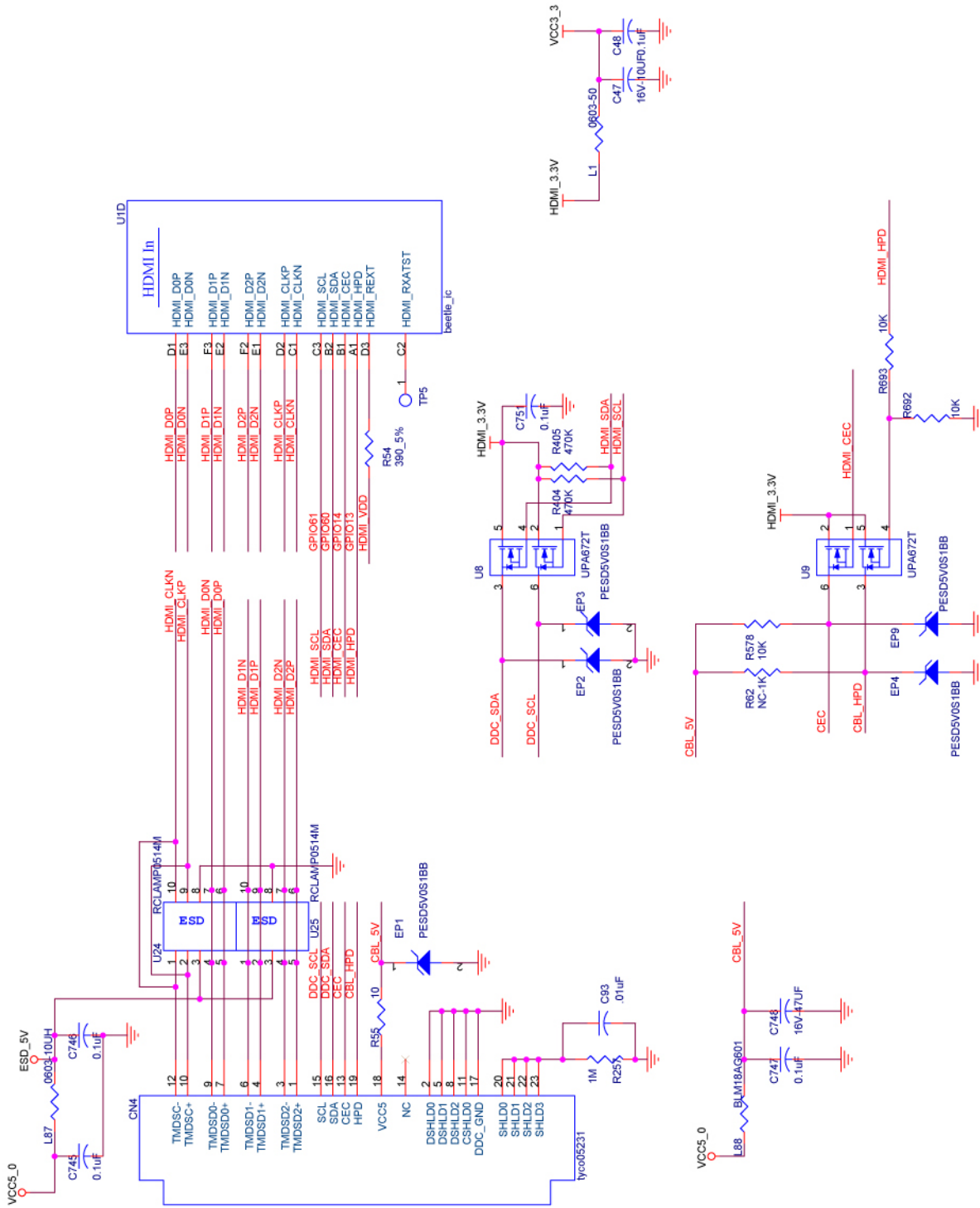

15 HDMI_VDD >> HDMI_VDD

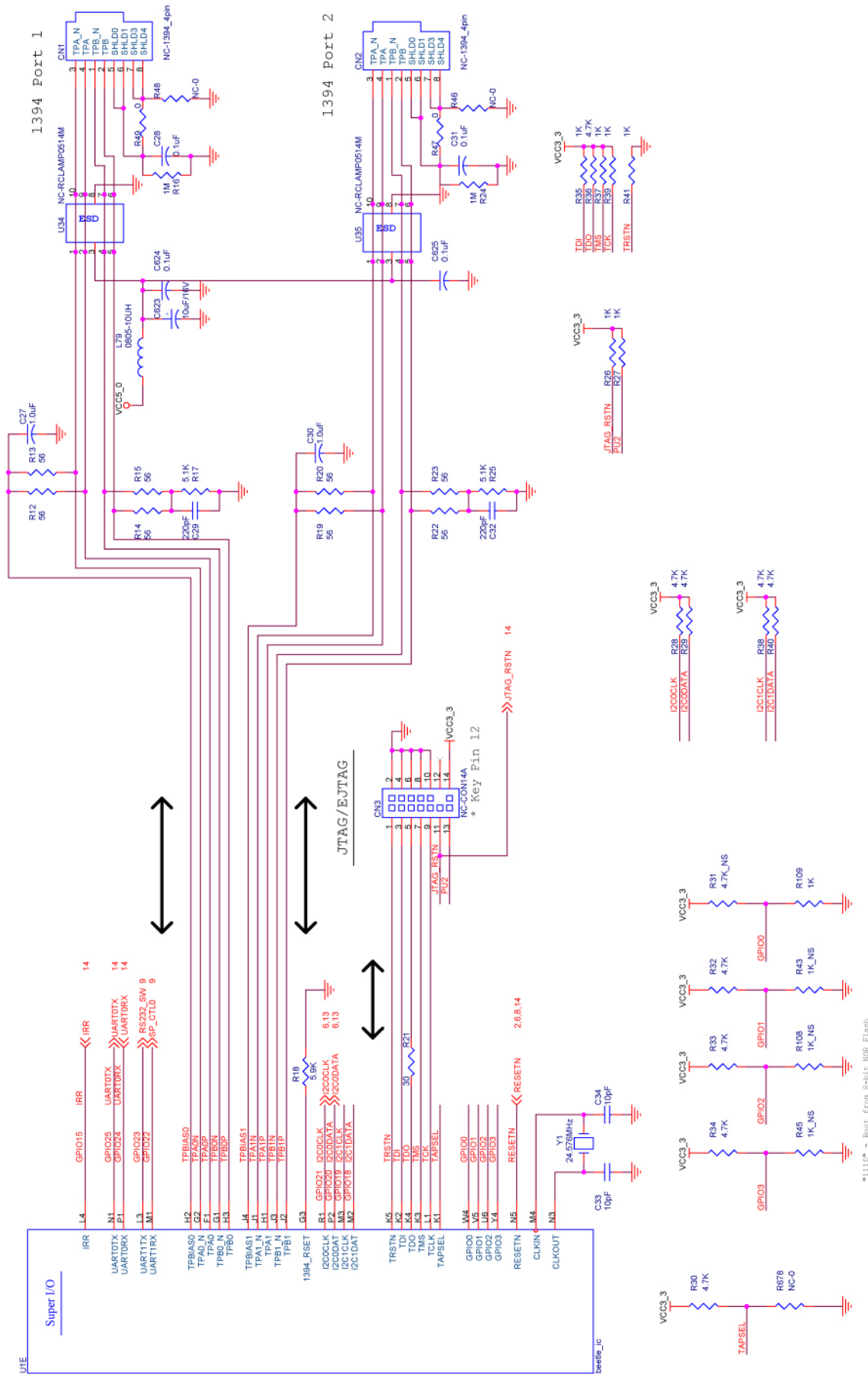

1110 - Boot from 8-bit NOR Flash

Module Board

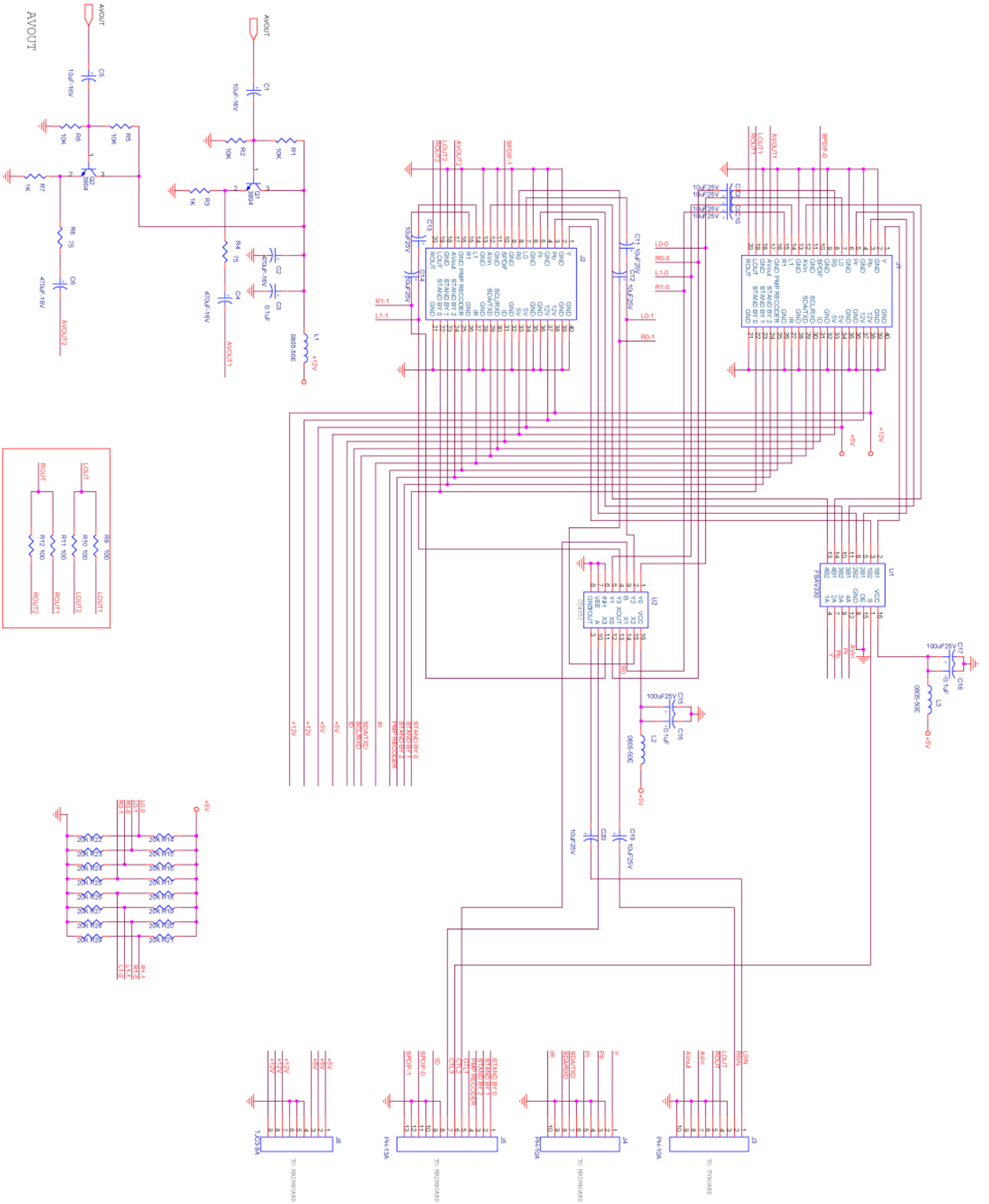

Front Panel Connectors

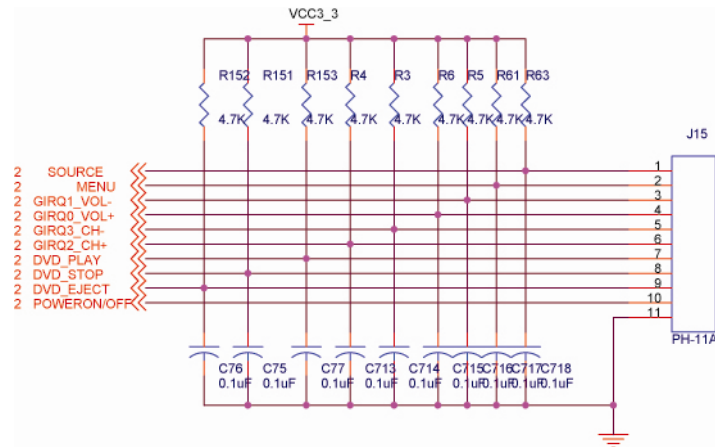

Backlight

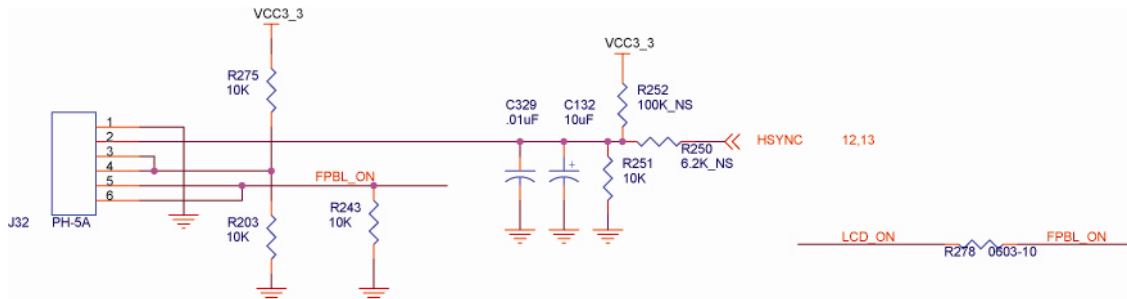

IR Board

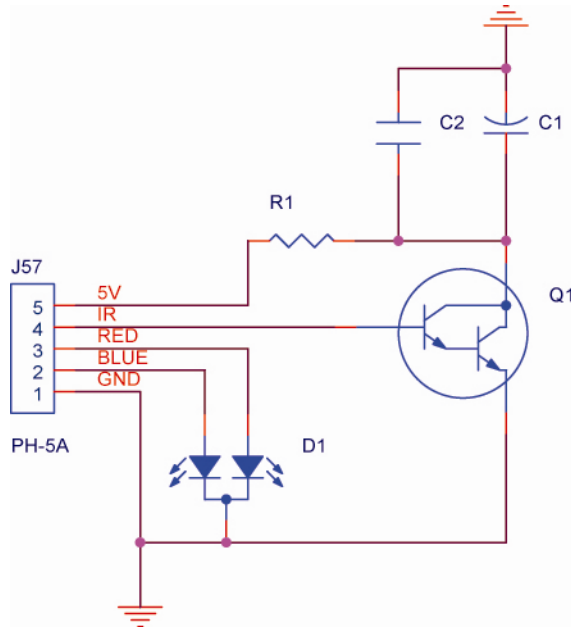

Reset Circuit

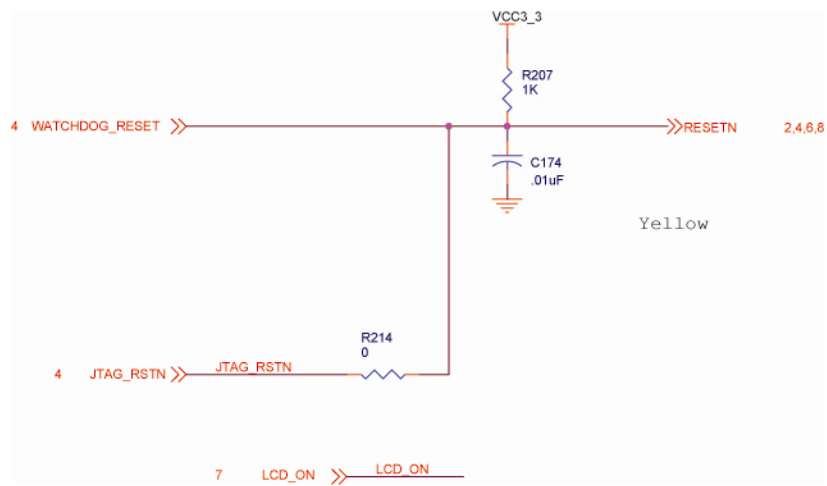

11. PCB Layout Diagrams

Main Board (Top View)

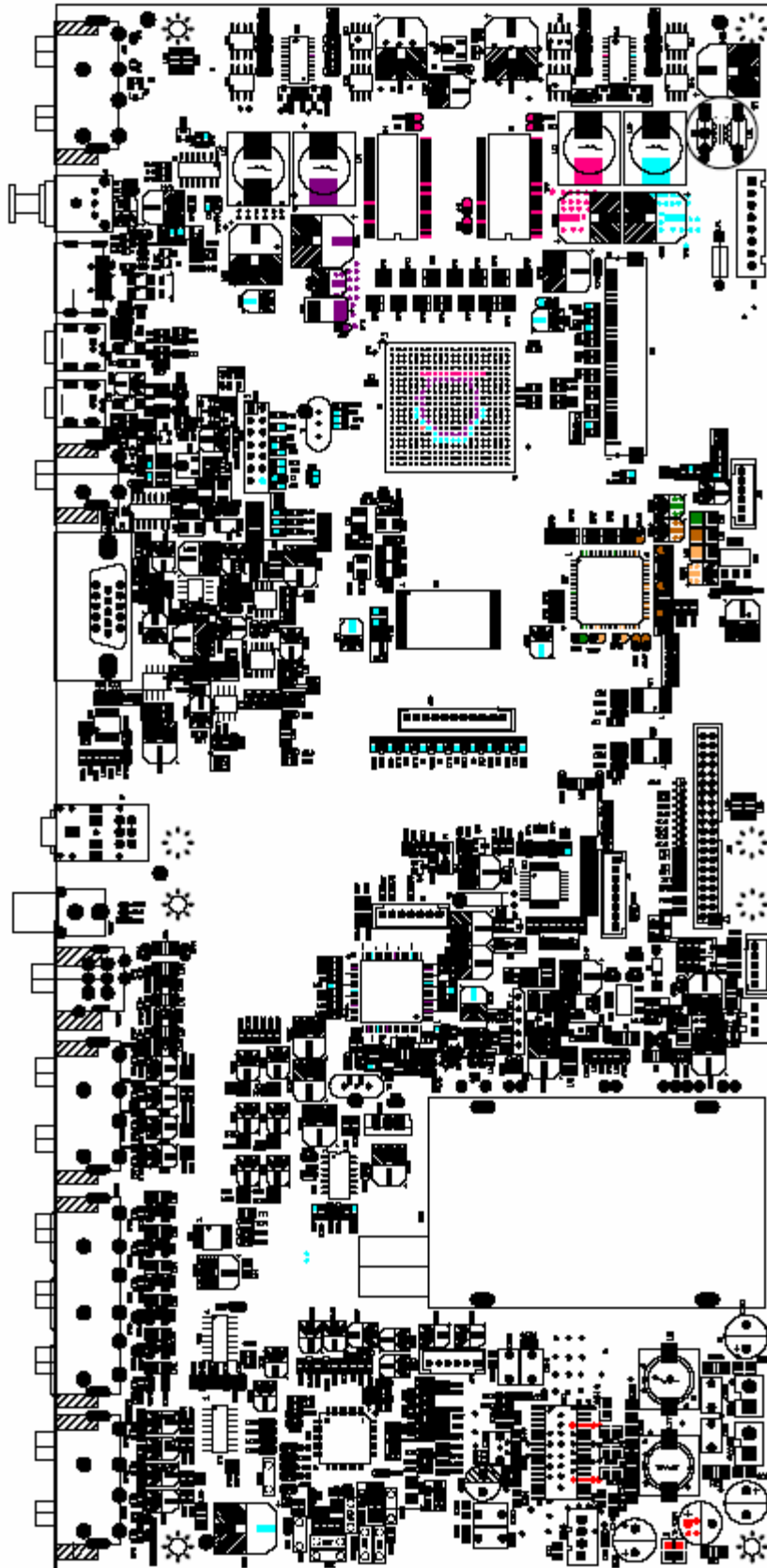

Main Board (Bottom view)

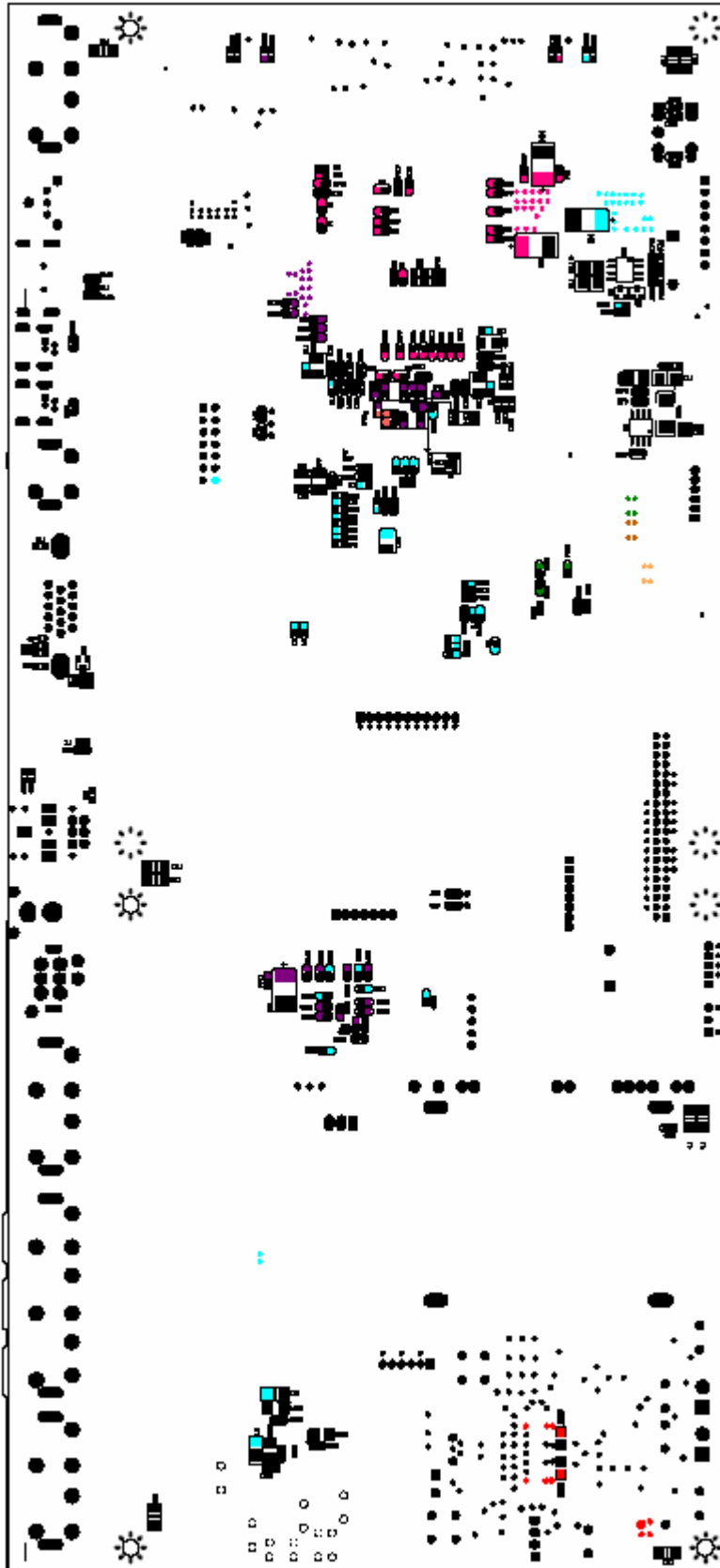

Control Button board top view

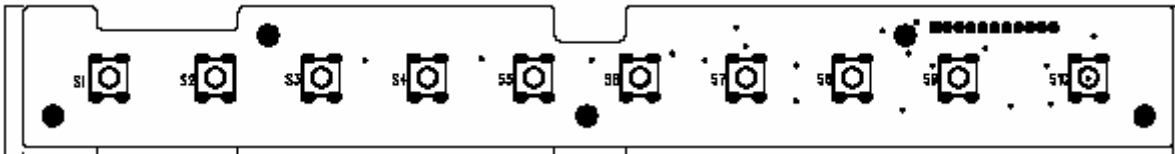

Control Button board bottom view

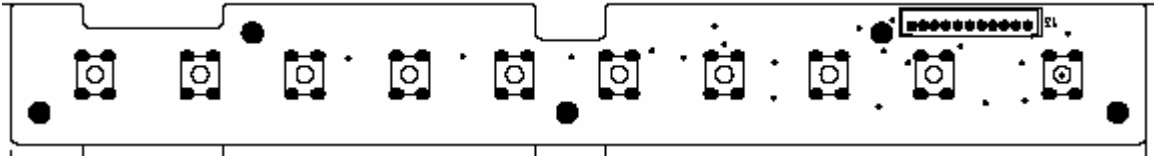

Remote board top view

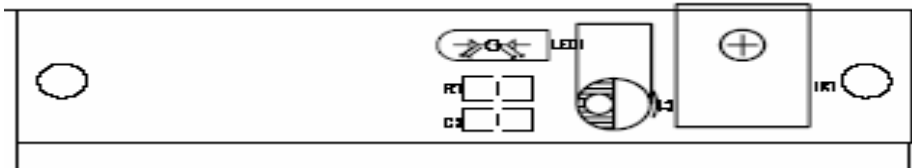

Remote board bottom view

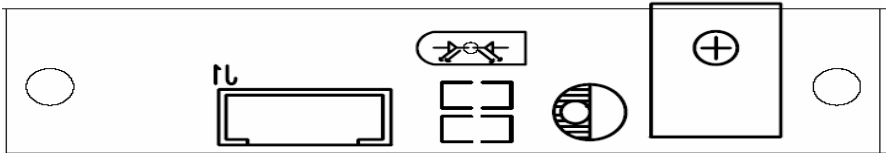

DVD Module board top view

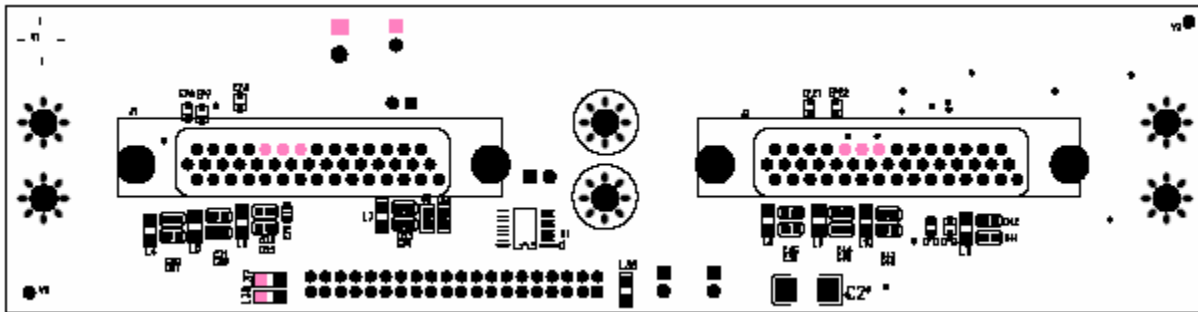

DVD Module board bottom view

