

THE REMOTE CONTROL WiFi DRONE WITH CAMERA

Instruction manual
7199-89WH

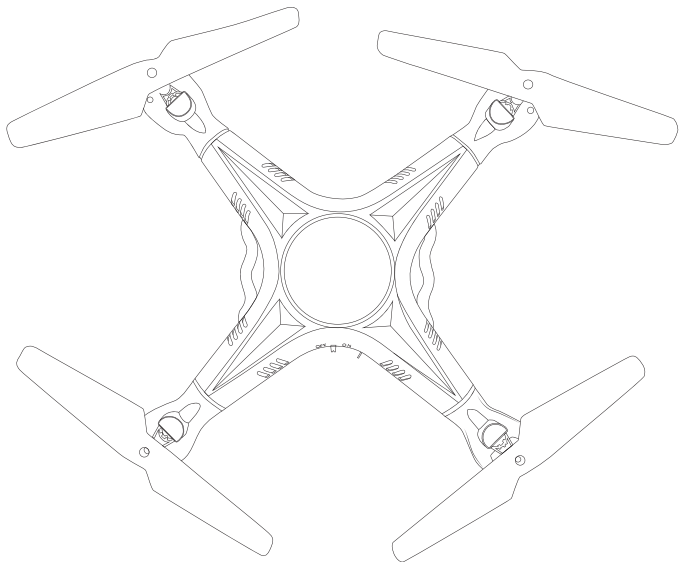

What's Included:

- 1 x Drone
- 1 x Instruction Manual
- 1 x Remote Controller
- 1 x USB to Battery Lead (charging cord)

Parts Included:

- 1 x LiPo Battery
 - 4 x Additional propellers
 - 4 x Protecting frame
 - 6 x Small Phillips Screws
 - 1 x Phillips Screwdriver
 - 1 x Smart Phone Holder
 - 4 x AA Battery
- made in china

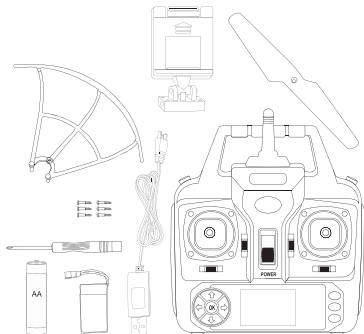

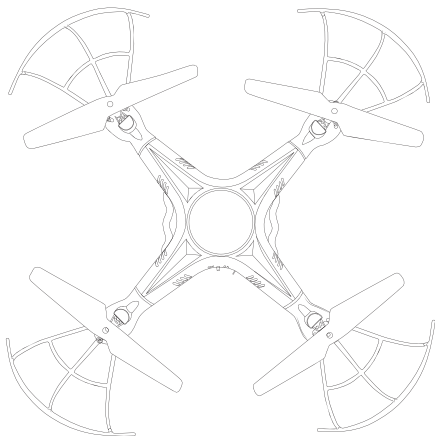

Hello! Here is everything you need to know about the Remote Control WiFi Drone with Camera. In order to help you understand how to operate our product like-a-pro (and in a safer manner), and to quickly show off for all of your friends; please read the entire instruction manual (It's in your best interest to keep this for future use).

INDEX

Safety Notes	02
Safety Advisory Notice	03
Safety Check Before Flying	04
Charging the Battery	04
Assembling Diagrams	05
Remote Controls	06
Time to Fly	06
Taking Photos & Videos	08
Auto Hover Function.....	08
One Key Return Function	08
Headless Function.....	08
Recalibrating	08
WiFi Connection	08
App Control Specifications	09
Tech Specifications	09
FCC Statement	10

SAFETY NOTES

Important Notes: Ages +14

This drone is not a toy, it can be fun but must be taken seriously.

Any improper use of this product will result in serious injury. Be aware of your personal safety, safety of others and your surrounding environment.

We recommend beginners learn to fly with more experienced pilots playing nearby before attempting to fly the Remote Control WiFi Drone with Camera in the same environment.

Caution:

This Wifi Drone has parts that move at high speed, which poses a certain degree of danger.

Choose a wide open space without obstacles. Do not operate this Wifi Drone near buildings, crowds of people, high voltage cables, or trees to ensure the safety of yourself, others and your drone.

Keep small parts out of reach of children, to avoid choking hazards. Adult supervision is advised.

✳ LiPo Battery Safety Notes:

This Wifi Drone is powered by a Lithium-Polymer (LiPo) battery.

To avoid risk of fire or damage, never recharge your battery while it is inserted in the Drone.

If you do not plan to fly the Wifi Drone for a week or more, store the battery approximately 50% charged to maintain battery performance and life.

Prevent Moisture:

This Wifi Drone contains many precise electrical components.

Store the battery and the Wifi Drone in a dry area at room temperature. Exposure to water or moisture may cause malfunction resulting in loss of responsiveness, or a crash.

Proper Operation:

For safety only use the included spare parts for replacements.

Always be aware of the Rotating Blades:

When in operation, the main and tail rotor blades will be spinning at high speed. The blades are capable of inflicting serious body injury or property damage.

Be careful to keep your body and loose clothing away from the blades. Never take your eyes off the Wifi Drone or leave it unattended while it is turned on. Stop operating immediately if the Wifi Drone flies out of your view. Once landed, immediately turn off the Wifi Drone and remote control.

Avoid Flying Alone:

Beginners should avoid flying alone when learning flight skills. We recommend flying with an experienced pilot nearby in case you need help.

SAFETY ADVISORY NOTICE

 Lithium-Polymer (LiPo) Batteries



LiPo batteries are different from conventional batteries in that their chemicals contents are encased in a relatively lightweight foil packaging. This has the advantage of significantly reducing their weight, but does make them more susceptible to damage if explosion if safety practices are ignored.

- Charge and store LiPo batteries in a location where a battery fire or explosion (including smoke hazard) will not endanger life or property.
- Keep LiPo batteries away from children and animals.
- Never charge the LiPo battery that has ballooned or swelled.
- Never charge the LiPo battery that has been punctured or damaged.
- After a crash, inspect the battery pack for the sign of damage. Discard in accordance with your local recycling laws.
- Never charge the LiPo battery in a moving vehicle.
- Never overcharge the LiPo battery.
- Never leave the LiPo battery unattended during recharging.
- Do not charge LiPo batteries near flammable materials or liquids.
- Ensure that charging leads are connected correctly. Reverse polarity charging can lead to battery damage or a fire or explosion.
- Have a suitable fire extinguisher (electrical type) OR a large bucket of dry sand near the charging area. Do not try to extinguish electrical (LiPo) battery fires with water.
- Reduce risks from fire/explosion by storing and charging LiPo batteries inside a suitable container.
- Protect your LiPo battery from accidental damage during storage and transportation. (Do not put battery packs in pockets or bags where they can short circuit or can come into contact with sharp or metallic objects).
- If your LiPo battery is subjected to a shock (such as a crash), place it in a metal container and observe for signs of swelling or heating for at least 30 minutes.
- Do not attempt to disassemble or modify or repair the LiPo battery.

SAFETY CHECK BEFORE FLYING

Carefully inspect the Drone before every flight

- Before operations, check the batteries of the transmitter and Drone are charged for the flight.
- Before turning on the transmitter, check that the throttle stick is pulled completely backward (down position).
- Carefully check the Wifi Drone and propellers. Broken parts will pose risk of injury and hazard.
- Check the battery and power plug are securely fastened. Severe vibration during flight may detach the plug and result in loss of control.
- When turning on the until, always turn on the remote first, and then turn on the Wifi Drone. To power off, always turn off the Wifi Drone first and then the transmitter. Improper procedure may cause loss of control of the Wifi Drone.

CHARGING THE LI-PO BATTERY

Charge the Li-Po battery completely before initial use of the Wifi Drone for optimal use.

- Use the provided charging cable, if the cable is damaged do not attempt to use.
- Do not charge the battery if swollen, leaking, or seemingly damaged.
- Do not overcharge the battery. When batteries are fully charged the LED indicators light will go out, unplug the battery from the power source immediately.
- Do not charge on the flammable or combustible surface (such as carpet, wooden floor, solid wood furniture, etc.) or on electric-conductive surface.
- When the battery has recently died, wait a few minutes to let the battery cool then begin charging.

Remove and detach the battery form the bottom of the Drone

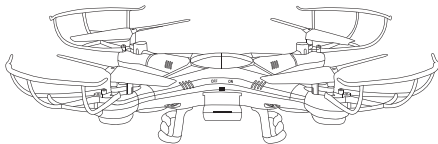

- Connect the battery with USB charger, then connect the USB charger to a computer or AC wall adapter.
- An LED light indicator will light while charging, and turn off when charging is complete.

ASSEMBLING THE DRONE

Assembling the Wifi Drone: Use the provided equipment to achieve the Wifi Drone's best use

- 1 First: Install the landing skids to the bottom of the Drone (Figure 1), and install the protecting frame around the blades for every corner, then lock the screws into place (Figure 2).



- 2 Second: When replacing damaged blades use the provided ones from the Wifi Drone packaging. The set will come with 4 replacement propellers, two (A) type and two (B) type. To place the propellers correctly so that the Wifi Drone will fly you must align the like the illustration below; the A's are diagonal from one another, and the B's are as well (Figure 2). Once the propellers have been aligned correctly push them into place.

- 3 Third: The final step in preparing the Wifi Drone for flight is implementing the fully charged Li-Po Battery. On the provided Li-Po battery, connect the Battery end into the Battery lead located on the physical Wifi Drone, as shown in Figure 3. Then slide the Li-Po battery into the alcove of the physical Wifi Drone, so that the battery cords are outside of the Wifi Drone.

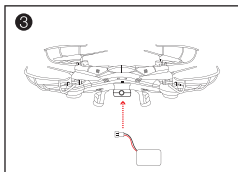
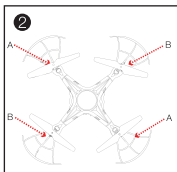

- 4 Fourth: Turn the controller over, and using the provided screw driver remove the screw to unlock the battery placement compartment. Unhinge the compartments door and push and slide the door off the compartment, follow the "open" arrow and place four (included) AA Batteries into the back of the controller, as shown in Figure 4.

- 5 Fifth: Attach the smartphone holder to the control securely, and fit your mobile device with in the grips (Figure 5) to get a live feed of the Drone's camera.

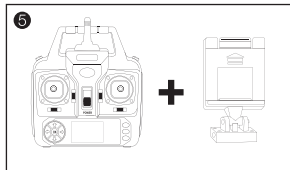
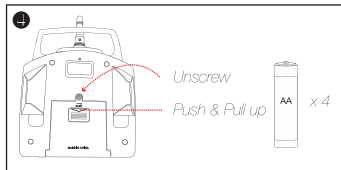

REMOTE CONTROLS

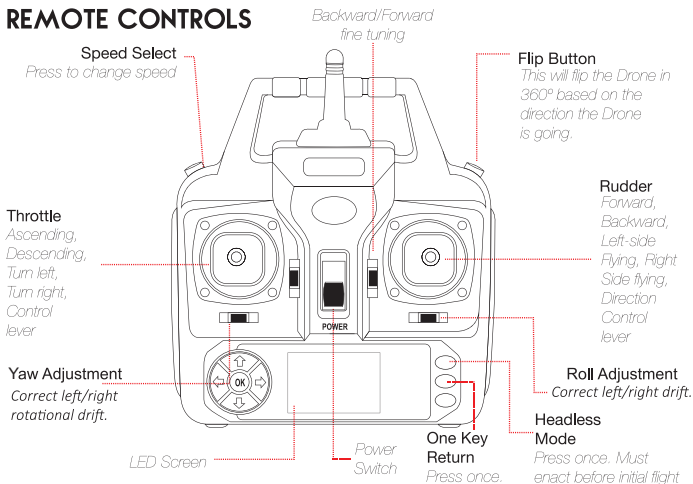

TIME TO FLY

Please read the instructions carefully to and proficiently fly the Wifi Drone. Reference the above diagram to understand which controls to use when.

⚠ YOU CAN PERFORM FLIPS, ATTEMPT ONLY IF UNDER CONTROL OF THE DRONE.

Turning On The Drone:

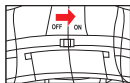

Press the Power switch to turn on the drone.
Once the drone's LED indicator is flashing, it is ready for pairing.

Press the Power switch to turn on the remote.

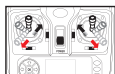
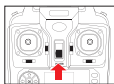

To pair ,Pull the left throttle lever to the furthest back left corner while pulling the rudder lever to the furthest back right corner then release both levers to return to center and the motors begin working ,this shows that the drone has entered into the "ready to fly" state with " Auto hover " function.

(Disarming Drone, If you want to emergency stop the drone with using the same operation, but while the drone is flying in the high air, first of all, you should be lower the drone's height to the ground, at the same time to make the same operation.)

Operating Direction

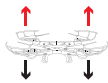

Push the throttle lever upward or downward, the aircraft will fly upward or downward correspondingly.

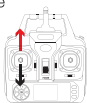

Push the throttle lever to the left or to the right, the aircraft will spin to the left or to the right.

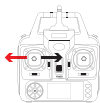

Operating Direction (continued)



Push the rudder lever upward or downward, the aircraft will be flying forward or backward.

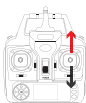

Push the rudder lever to the left or to the right, the aircraft will be flying to the left side or to the right side accordingly.

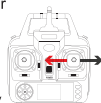

Trimming



In the case the Drone is hovering in the air and the aircraft is flying forward or backward, to make a correction push the trimmer down or up.

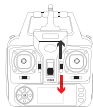

In the case that the Drone is hovering and the aircraft is will be flying to left side or right side, you are able to correct this by pushing the trimmer right or left.

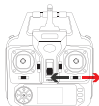

If your Drone is spinning and needs corrected, use the trimmer to direct the aircraft either right or left to balance out the spinning.

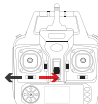

Headless Mode

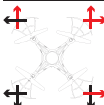

Please refer to page 8 for full instructions on how to properly operate in Headless Mode.



Flips & Rolls



Left Flip



Right Flip



Forward Flip



Backward Flip



Flying Environment

- Flying Indoor: Please choose to fly in the spacious area where there is no obstacle or pet or people nearby.
- Flying Outdoor: Please choose to in warm weather, sunny, not windy or you risk the loss of your Wifi Drone.
- It is not recommended to fly in extreme weather conditions, as strong wind may cause limited flying response or losing control over the Wifi Drone all together. Also, if flying in strong wind, you're risking the that the Wifi Drone could be blown away or physically damaged.

TAKING PHOTOS AND VIDEOS:

- Make sure the 3 pin plug is inserted into the drone.
- Turn on the Drone following the instructions above.
- Photos: See Page 9 APP CONTROL SPECIFICATIONS press button 2
- Videos: See Page 9 APP CONTROL SPECIFICATIONS press button 3

AUTO HOVER FUNCTION:

- Place the drone with the front side facing away from the controller
- At the same time, pull the left throttle lever to the furthest back left corner while pulling the rudder lever to the furthest back right corner then release both levers to return to center.

In the auto hover mode, the drone should be capable of auto hovering while in flight.

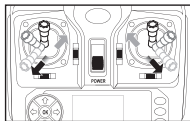

ONE KEY RETURN FUNCTION:

Before using one key return mode, it is necessary to activate the mode.

- Press the "one key return" button on the remote one time as the arrow on the diagram indicates. The controller will beep indicating it is in one key return mode.

(To cancel this mode, press the button again.)

- While flying Drone in One Key Return mode, the button can be pressed at any time to return the drone to its launching location.
- Once the Drone is on the return route, press the button again or press the right lever up to end the return function.

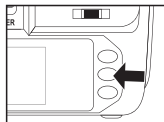

HEADLESS FUNCTION:

Place the Drone in a horizontal position or while hovering in the air, position the Drone so that the front (red LEDs indicate the front side) faces away from the remote.

- Once connected push the Headless Mode button down.
- Headless Mode can be activated at any time - including mid-flight.

(To cancel Headless Mode, press the button again, While the drone in Headless Mode, each direction can be regarded as the front of drone.)

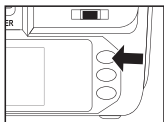

RECALIBRATING:

Recalibrating Directionality:

- Place the drone with the front side facing away from the controller
- Pull both levers to the furthest back left corner.

The LED indicator will begin flashing.

- Once the remote controller beeps, release both levers to allow them to return to the center position.

The LED indicator will stop flashing, but remains lit to indicate the reset was successful.

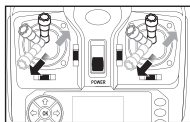

Recalibrating Horizontal Navigation:

- Place the drone with the front side facing away from the controller
- Pull both levers to the furthest back right corner.

The LED indicator will begin flashing.

- Once the remote controller beeps, release both levers to allow them to return to the center position.

The LED indicator will stop flashing, but remains lit to indicate the reset was successful.

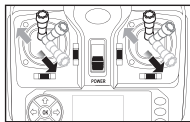

WIFI CONNECTION:

Enter Google™ Play or the iTunes App Store and search for WiFi UFO. Once selected, download and install the app or scan the QR code that complies with your device.



WiFi connection instructions:

- Turn on the drone, and when the blue LED indicator lights this signifies the drone is ready to connect via WiFi .
- Enter WiFi settings on the selected mobile device. Select "WiFiDrone-#####" from the list of available connections. Note: the six "#" will be different for every user.

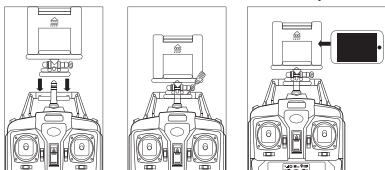

APP CONTROL SPECIFICATIONS:

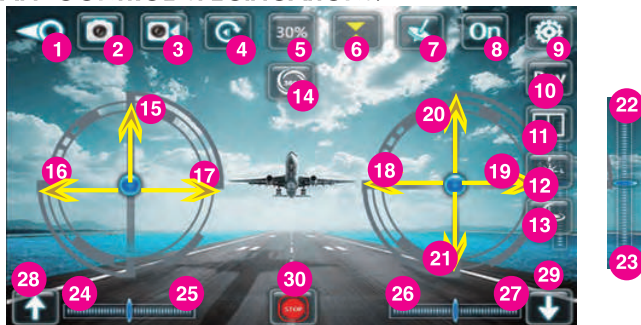

1. Return
2. Pictures
3. The recorded video
4. Documentation
5. Speed: 30% / 60% / 100%
6. The fixed-height mode
7. Gravity sensing mode
8. Show / Hide control interface
9. Display Settings menu
10. Reverse the lens
11. 3D display
12. Headless mode
13. Gyroscope correction
14. 360 degree rollover
15. The throttle control
- 16/17. Right / left rotation
- 18/19. Left / right side fly
- 20/21. Forward / back
- 22/23. Front / Rear trim
- 24/25. Right / left rotation trimming
- 26/27. Left / right side fly fine-tuning
28. One key take-off
29. One key drop
30. Emergency Stop

TECH SPECIFICATIONS

Information regarding the physical and capable attributes of the Wifi Drone.

Diameter of Motor	7mm	Total weight	110g
Fuselage Height	75mm	Charging Time	40 minutes
Battery	600mAh/3.7V lithium battery	Code of main engine	Hollow cup engine
Gyroscope	6 axial digital Gyro	Flying Time	8 minutes
Length of Fuselage	320mm	Flying Height	★ 50 meters

★ Considering the Wifi Drone is small we suggest not fly too high to see.

FCC STATEMENT:

This device complies with Part 15 of the FCC Rules. Operation is subject to the following two conditions:

- This device may not cause harmful interference, and
- This device must accept any interference received, including interference that may cause undesired operation.

WARNING: Changes or modifications not expressly approved by the party responsible for compliance could void the user's authority to operate the equipment.

- NOTE: This equipment has been tested and found to comply with the limits for a Class B digital device, pursuant to Part 15 of the FCC Rules. These limits are designed to provide reasonable protection against harmful interference in a residential installation. This equipment generates uses and can radiate radio frequency energy and, if not installed and used in accordance with the instructions, may cause harmful interference to radio communications. However, there is no guarantee that interference will not occur in a particular installation. If this equipment does cause harmful interference to radio or television reception, which can be determined by turning the equipment off and on, the user is encouraged to try to correct the interference by one or more of the following measures:
 - Reorient or relocate the receiving antenna.
 - Increase the separation between the equipment and receiver.
 - Connect the equipment into an outlet on a circuit different from that to which the receiver is connected.
 - Consult the dealer or an experienced radio/TV technician for help.

FCC Radiation Exposure Statement:

This equipment complies with FCC radiation exposure limits set forth for an uncontrolled environment. This equipment should be installed and operated with minimum distance 20cm between the radiator & your body.

This Transmitter must not be co-located or operating in conjunction with any other antenna or transmitter