











1993
PONTIAC
Bonneville
(SE, SSE, SSEi)
OWNER'S MANUAL

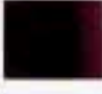
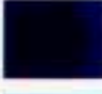

Pontiac Bonneville

1993 Owner's Manual **Table of Contents**

Introduction	How to Use this Manual	3	
Part 1	Seats & Safety Belts	9	
Part 2	Features & Controls	45	
Part 3	Comfort Controls & Audio Systems	119	
Part 4	Your Driving and the Road	145	
Part 5	Problems on the Road	191	
Part 6	Service & Appearance Care	221	
Part 7	Maintenance Schedule	275	
Part 8	Customer Assistance Information Includes "Reporting Safety Defects" on page 302	297	
Part 9	Index	311	
	Service Station Information	Last Page	

Important Notes About this Manual

Please keep this manual in your Pontiac, so it will be there if you ever need it when you're on the road. If you sell the vehicle, please leave this manual in it so the new owner can use it.

This manual includes the latest information at the time it was printed. We reserve the right to make changes in the product after that time without further notice.

Note to Canadian Owners

For vehicles first sold in Canada, substitute the name "General Motors of Canada Limited" for Pontiac Division whenever it appears in this manual.

For Canadian Owners Who Prefer a French Language Manual:

Aux propriétaires canadiens: Vous pouvez vous procurer un exemplaire de ce guide en français chez votre concessionnaire ou au DGN Marketing Services Ltd., 1500 Bonhill Rd., Mississauga, Ontario L5T 1C7.

Published by **Pontiac Division**
General Motors Corporation

The word **Pontiac**, the Pontiac emblem and the name Bonneville are registered trademarks of General Motors Corporation.

The word **Delco** is a registered trademark of General Motors Corporation.

© Copyright 1992 General Motors Corporation, Pontiac Division. All rights reserved.

How to Use this Manual



Using Your 1993 Pontiac Owner's Manual

Many people read their owner's manual from beginning to end when they first receive their new vehicle. This will help you learn about the features and controls for your vehicle. In this manual, you'll find that pictures and words work together to explain things quickly.

There are nine parts with color-tabbed pages in this manual. Each part begins with a brief list of contents, so you can usually tell at a glance if that part contains the information you want.

You can bend the manual slightly to reveal the color tabs that help you find a part.

Part 1: Seats and Safety Belts

This part tells you how to use your seats and safety belts properly.

Part 2: Features & Controls

This part explains how to start and operate your Pontiac.

Part 3: Comfort Controls & Audio Systems

This part tells you how to adjust the ventilation and comfort controls and how to operate your audio system.

How to Use this Manual

Using Your 1993 Pontiac Owner's Manual (CONT.)

Part 4: Your Driving and the Road

Here you'll find helpful information and tips about the road and how to drive under different conditions.

Part 5: Problems on the Road

This part tells you what to do if you have a problem while driving, such as a flat tire or engine overheating.

Part 6: Service & Appearance Care

Here the manual tells you how to keep your Pontiac running properly and looking good.

Part 7: Maintenance Schedule

This part tells you when to perform vehicle maintenance and what fluids and lubricants to use.

Part 8: Customer Assistance Information

This part tells you how to contact Pontiac for assistance and how to get service publications. It also gives you information on *Reporting Safety Defects*.

Part 9: Index

Here's an alphabetical listing of almost every subject that's in this manual. You can use it to quickly find something you want to read.

Service Station Information:

This is a quick reference of service information. You can find it on the last page of this manual.

Safety Warnings and Symbols

You will find a number of safety cautions in this book. We use yellow and the word CAUTION to tell you about things that could hurt you if you were to ignore the warning.

CAUTION



These mean there is something that could hurt you or other people.

In the yellow caution area, we tell you what the hazard is. Then we tell you what to do to help avoid or reduce the hazard. Please read these cautions. If you don't, you or others could be hurt.

You will also find a red circle with a slash through it in this book. This safety symbol means:

Don't
Don't do this
Don't let this happen



Vehicle Damage Warnings

Also, in this book you will find these blue notices:

NOTICE

These mean there is something that could damage your vehicle.

In the blue notice area, we tell you about something that can damage your vehicle. Many times, this damage would not be covered by your warranty, and it could be costly. But the notice will tell you what to do to help avoid the damage.

When you read other manuals, you might see CAUTION and NOTICE warnings in different colors or in different words. In this manual, we've used the familiar words and colors that Pontiac has used for years.

You'll also see warning labels on your vehicle. They use the same colors, and the words CAUTION or NOTICE.

How to Use this Manual

Vehicle Symbols

These are some of the symbols you will find on your vehicle. For example, these symbols are used on an original battery:

Caution Possible Injury



Protect Eyes by Shielding



*Caustic Battery Acid
Could Cause Burns*



Avoid Spark or Flames



*Sparks or Flame Could
Explode Battery*



These symbols are important for you and your passengers whenever your vehicle is driven:

Fasten Safety Belts



Door Lock/Unlock



These symbols have to do with your lights:

Master Lighting Switch



Turn Signal Direction

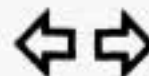

Hazard Warning Flashers



Headlight High Beam



Parking Lights



Fog Lights



These symbols are on some of your controls:

Windshield Wipers



Windshield Washer



Headlight Washers



Windshield Defroster



Rear Window Defogger



Ventilating Fan



Power Window



These symbols are used on warning and indicator lights:

Engine Coolant Temperature

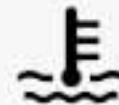

Battery Charging System



Fuel



Engine Oil Pressure



Brake



Anti-Lock Brakes



How to Use this Manual

Here are some other symbols you may see:

Fuse

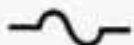

Trunk Release



Lighter



Horn



Speaker



Hood Release





Part 1

Seats & Safety Belts

Here you'll find information about the seats in your Pontiac, your Supplemental Inflatable Restraint ("air bag") system and how to use your safety belts properly. You can also learn about some things you should **not** do with safety belts.

Seats and Seat Controls	10
Safety Belts	13
How to Wear Safety Belts Properly	18
Driver Position	18
Supplemental Inflatable Restraint System (Air Bag)	22
Safety Belt Use During Pregnancy	29
Right Front Passenger Position	29
Center Passenger Position	30
Rear Seat Passengers	31
Children	33
Smaller Children and Babies	33
Child Restraints	34
Larger Children	42
Safety Belt Extender	43
Replacing Safety Belts After a Crash	44

Seats & Safety Belts

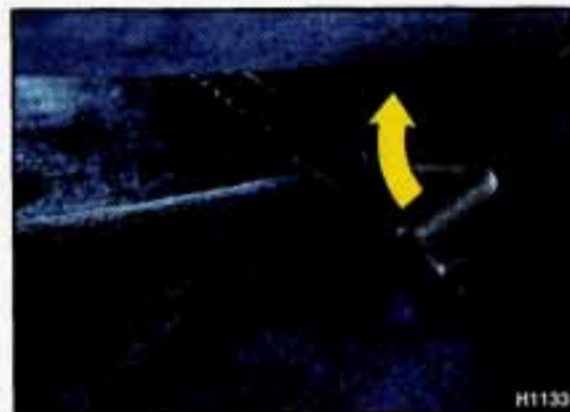

■ *Seats and Seat Controls*

This section tells you about the seats—how to adjust them—and also about reclining seatbacks and head restraints.

Manual Front Seat

CAUTION



You can lose control of the vehicle if you try to adjust a manual driver's seat while the vehicle is moving. The sudden movement could startle and confuse you, or make you push a pedal when you don't want to. Adjust the driver's seat only when the vehicle is not moving.

Move the control lever under the front of the seat to unlock it. Slide the seat to where you want it. Then release the lever and try to move the seat with your body, to make sure the seat is locked into place.

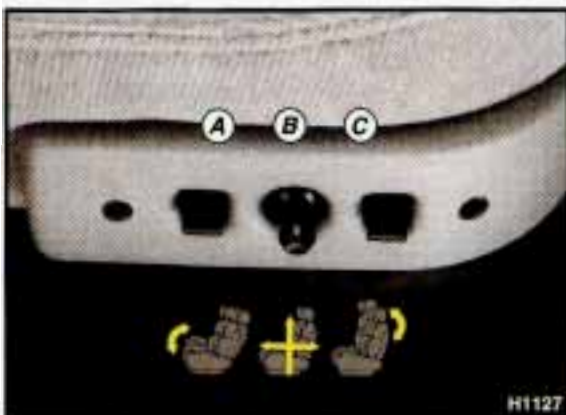

Power Seat (OPTION)

To adjust the power seat on some models:

Front Control (A): Raise the front of the seat by holding the switch up. Lower the front of the seat by holding the switch down.

Center Control (B): Move the seat forward or back by holding the control to the right or left.

Move the seat higher by holding the control up. Lower the seat by holding the control down.

Rear Control (C): Raise the rear of the seat by holding the switch up. Lower the rear of the seat by holding the switch down.





Adjustable Support Seat (OPTION)

On some models, you'll find the controls on the center console. Slide the selector switch to **L** or **R** to choose the front seat you want to adjust.

 Adjusts the seat forward or back.

 Adjusts the seat up or down.

 Adjusts the seatback to an upright or reclined position. Don't have a seatback reclined if your vehicle is moving.

 Adjusts the position of the seatback side bolsters.

 Tilts the rear of the seat up or down.



 Tilts the front of the seat up or down.

Seats & Safety Belts



Adjustable Support Seat (CONT.)

Lumbar Controls

-  Reshapes the lower back area of the seat.
-  Reshapes the middle back area of the seat.
-  Reshapes the upper back area of the seat.

Manual Reclining Seatback (OPTION)

Lift the lever to release the seatback, then tilt the seatback forward or backward, as desired. Release the lever to lock the seatback in place.

But don't have a seatback reclined if your vehicle is moving.

CAUTION

 Sitting in a reclined position when your vehicle is in motion can be dangerous. Even if you buckle up, your safety belts can't do their job when you're reclined like this.

The shoulder belt can't do its job because it won't be against your body. Instead, it will be in front of you. In a crash you could go into it, receiving neck or other injuries.

The lap belt can't do its job either. In a crash the belt could go up over your abdomen. The belt forces would be there, not at your pelvic

(Continued)



CAUTION



(Continued)

bones. This could cause serious internal injuries.

For proper protection when the vehicle is in motion, have the seatback upright. Then sit well back in the seat and wear your safety belt properly.

Head Restraints

Slide the head restraint up or down so that the top of the restraint is closest to the top of your ears.

This position reduces the chance of a neck injury in a crash.

On some models, you can also adjust the head restraint by tilting the pad forward or rearward.

■ ***Safety Belts: They're For Everyone***

This part of the manual tells you how to use safety belts properly. It also tells you some things you should not do with safety belts. And it explains the Supplemental Inflatable Restraint, or "air bag" system.

Seats & Safety Belts



■ *Safety Belts: They're For Everyone (Cont.)*

CAUTION

 Don't let anyone ride where they can't wear a safety belt properly. If you are in a crash and you're not wearing a safety belt, your injuries can be **much** worse. You can hit things inside the vehicle or be ejected from it. You can be seriously injured or killed. In the same crash, you might not be if you are buckled up. Always fasten your safety belt, and check that your passengers' belts are fastened properly too.

This figure lights up when you turn the key to **Run** or **Start** when your safety belt isn't buckled, and you'll hear a chime, too. It's the reminder to buckle up. In many states and Canadian provinces, the law says to wear safety belts. Here's why: **They work.**

You never know if you'll be in a crash. If you do have a crash, you don't know if it will be a bad one.

A few crashes are very mild. In them, you won't get hurt even if you're not buckled up. And some crashes can be so serious, like being hit by a train, that even buckled up a person wouldn't survive. But most crashes are in between. In many of them, people who buckle up can survive and sometimes walk away. Without belts they could be badly hurt or killed.

After 25 years of safety belts in vehicles, the facts are clear. In most crashes buckling up does matter . . . a lot!

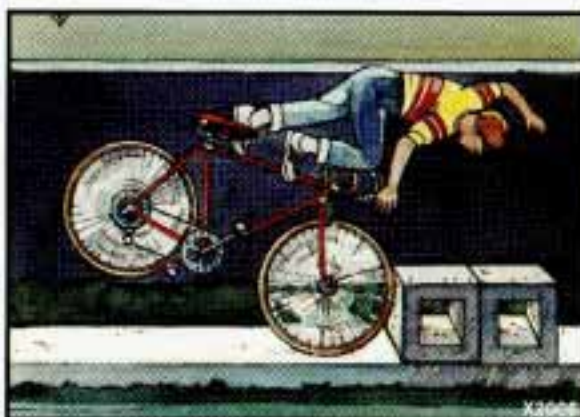

Why Safety Belts Work

When you ride in or on anything, you go as fast as it goes.

- 1. For example, if the bike is going 10 mph (16 km/h), so is the child.**

- 2. When the bike hits the block, it stops. But the child keeps going!**

- 3. Take the simplest “car.” Suppose it’s just a seat on wheels.**

Seats & Safety Belts

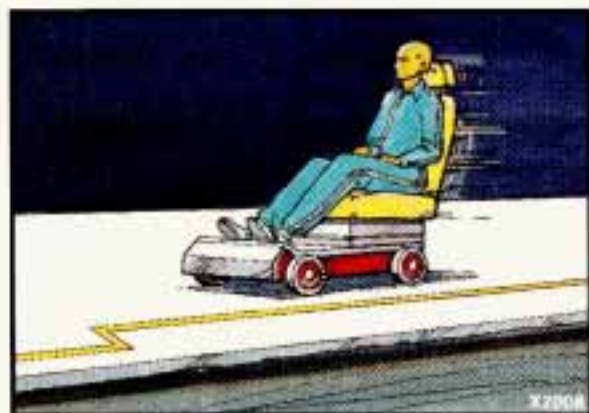

Why Safety Belts Work (CONT.)
4. Put someone on it.

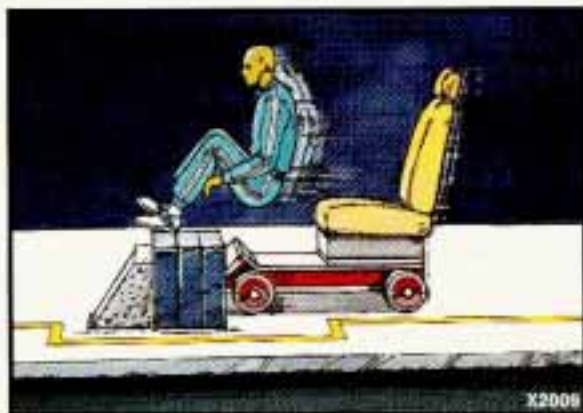

5. Get it up to speed. Then stop the "car." The rider doesn't stop.



6. The person keeps going until stopped by something. In a real vehicle, it could be the windshield...



7. or the instrument panel...



8. or the safety belts!

With safety belts, you slow down as the vehicle does. You get more time to stop. You stop over more distance, and your strongest bones take the forces. That's why safety belts make such good sense.

Here Are Questions Many People Ask About Safety Belts—and the Answers

Q: Won't I be trapped in the vehicle after an accident if I'm wearing a safety belt?

A: You **could** be—whether you're wearing a safety belt or not. But you can easily unbuckle a safety belt, even if you're upside down. And your chance of being conscious during and after an accident, so you **can** unbuckle and get out, is **much** greater if you are belted.

Q: Why don't they just put in air bags so people won't have to wear safety belts?

A: "Air bags," or Supplemental Inflatable Restraint systems, are in some vehicles today and will be in more of them in the future. But they are supplemental systems only—so they work **with** safety belts, not instead of them. Every "air bag" system ever offered for sale has required the use of safety belts. Even if you're in a vehicle that has "air bags," you still have to buckle up to get the most protection. That's true not only in frontal collisions, but especially in side and other collisions.

Q: If I'm a good driver, and I never drive far from home, why should I wear safety belts?

A: You may be an excellent driver, but if you're in an accident—even one that isn't your fault—you and your passengers can be hurt. Being a good driver doesn't protect you from things beyond your control, such as bad drivers.

Most accidents occur within 25 miles (40 km) of home. And the greatest number of serious injuries and deaths occur at speeds of less than 40 mph (65 km/h).

Safety belts are for everyone.

Seats & Safety Belts



Safety Belt Reminder Light

When the key is turned to **Run** or **Start**, a light will come on for about eight seconds to remind people to fasten their safety belts. Unless the driver's safety belt is buckled, a chime will also sound.

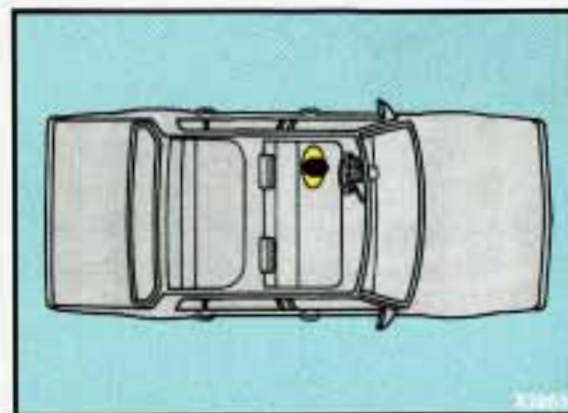

Driver Position

This section describes the driver's restraint system.

■ **How to Wear Safety Belts Properly—Adults**

This section is only for people of adult size.

CAUTION



There are special things to know about safety belts and children. And there are different rules for babies and smaller children. If a child will be riding in your Pontiac, see the *Index* under *Children and Safety Belts*. Follow those rules for everyone's protection.

First, you'll want to know which restraint systems your vehicle has. We'll start with the driver position.

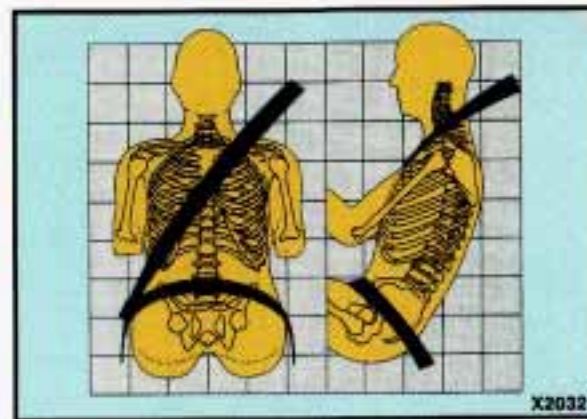

Lap-Shoulder Belt

The driver has a lap-shoulder belt. Here's how to wear it properly.

1. Close and lock the door.
2. Adjust the seat (to see how, see the *Index* under *Seat Controls*) so you can sit up straight.

3. Pick up the latch plate and pull the belt across you. Don't let it get twisted.
4. Push the latch plate into the buckle until it clicks.

If the belt isn't long enough, see the *Index* under *Safety Belt Extender*.

Make sure the release button on the buckle faces upward or outward so you would be able to unbuckle it quickly if you ever had to.

The lap part of the belt should be worn low and snug on the hips, just touching the thighs. In a crash, this applies force to the strong pelvic bones. And you'd be less likely to slide under the lap belt. If you slid under it, the belt would apply force at your abdomen. This could cause serious or even fatal injuries. The shoulder belt should go over the shoulder and across the chest. These parts of the body are best able to take belt restraining forces.

The safety belt locks if there's a sudden stop or crash.

Seats & Safety Belts



Lap-Shoulder Belt (CONT.)

Shoulder Belt Height Adjuster

You can move the shoulder belt adjuster to the height that is right for you.



To move it up or down, squeeze the release handle. When you release the handle, try to move it down a little to make sure it has locked into position.

You can move the adjuster up from a lower position by pushing the bottom of the release handle.



Adjust the height so that the shoulder portion of the belt is properly positioned on your shoulder, away from your face and neck.

To help you find a height that is right for you, follow these guidelines:

For a Tall Person:

Use the upper or upper-middle position.

For a Person of Average Height:

Use a position somewhere in the middle.

For a Short Person:

Use the lower or lower-middle position.

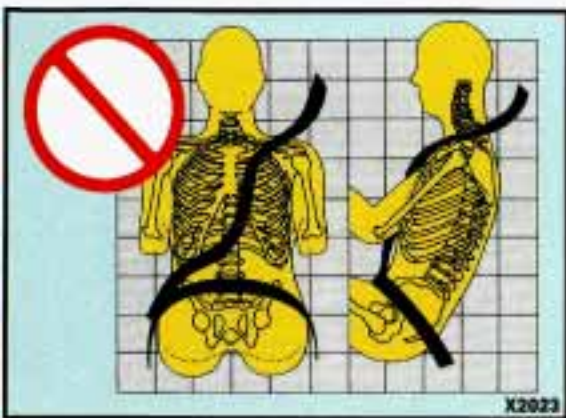

Q: What's wrong with this?

A: The shoulder belt is too loose. It won't give nearly as much protection this way.

CAUTION

 You can be seriously hurt if your shoulder belt is too loose. In a crash, you would move forward too much, which could increase injury. The shoulder belt should fit against your body.



Q: What's wrong with this?

A: The belt is buckled in the wrong place.

CAUTION

 You can be seriously injured if your belt is buckled in the wrong place like this. In a crash, the belt would go up over your abdomen. The belt forces would be there, not at the pelvic bones. This could cause serious internal injuries. Always buckle your belt into the buckle nearest you.

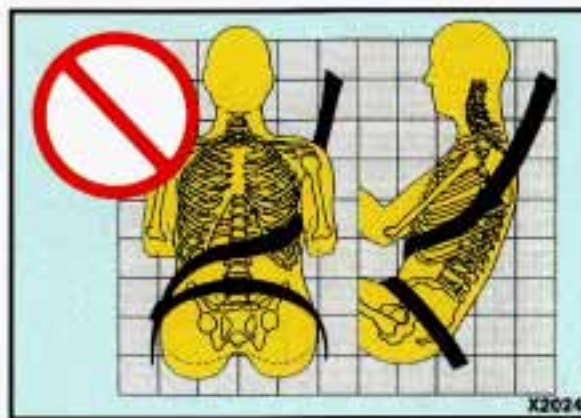

Q: What's wrong with this?

A: The shoulder belt is worn under the arm. It should be worn over the shoulder at all times.

CAUTION

 You can be seriously injured if you wear the shoulder belt under your arm. In a crash, your body would move too far forward, which would increase the chance of head and neck injury. Also, the belt would apply too much force to the ribs, which aren't as strong as shoulder bones. You could also severely injure internal organs like your liver or spleen.

Seats & Safety Belts

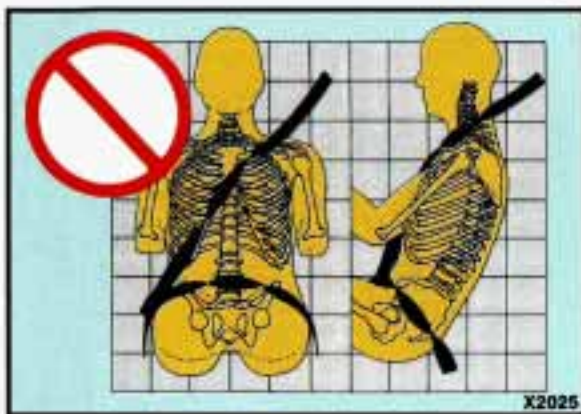

Lap-Shoulder Belt (CONT.)

Q: What's wrong with this?

A: The belt is twisted across the body.

CAUTION



You can be seriously injured by a twisted belt. In a crash, you wouldn't have the full width of the belt to spread impact forces. If a belt is twisted, make it straight so it can work properly, or ask your dealer to fix it.



To unlatch the belt, just push the button on the buckle. The belt should go back out of the way.

Before you close the door, be sure the belt is out of the way. If you slam the door on it, you can damage both the belt and your vehicle.



■ Supplemental Inflatable Restraint System (Air Bag)

This section explains the driver's Supplemental Inflatable Restraint (SIR) or "air bag" system. Your Pontiac may have an air bag for the driver and for the right-front passenger.

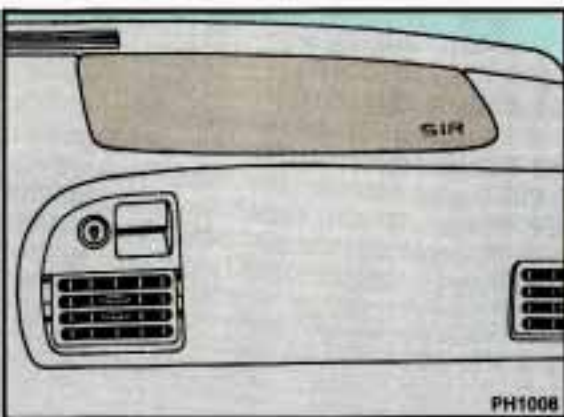

Your Pontiac may have the right-front passenger's SIR option. If your vehicle has an air bag for the right-front passenger, it will say SIR on the instrument panel above the glove box.

Here are the Most Important Things to Know:

CAUTION

 Even with an air bag, if you're not wearing a safety belt and you're in a crash, your injuries may be much worse. Air bags are not designed to inflate in rollovers or in rear, side or low-speed frontal crashes. You need to wear your safety belt to reduce the chance of hitting things inside the vehicle or being ejected from it. Always wear your safety belt, even with an air bag.

CAUTION

 Air bags inflate with great force, faster than the blink of an eye. If you're too close to an inflating air bag, it could seriously injure you. Safety belts help keep you in position for an air bag inflation in a crash. Always wear your safety belt, even with an air bag, and sit as far back as you can while still maintaining control of your vehicle.

CAUTION

 An inflating air bag can seriously injure small children. Always secure children properly in your vehicle. To read how, see the *Children and Safety Belts* section of this manual, and read the caution label on the front passenger's safety belt.

Seats & Safety Belts

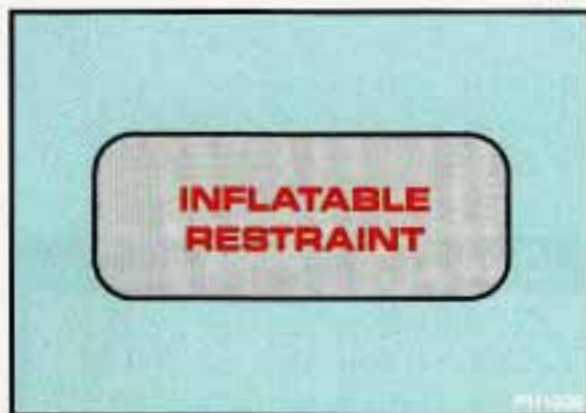

Air Bag System Light

There is an air bag readiness light on the instrument panel, which shows **INFLATABLE RESTRAINT**. The system checks itself and the light tells you if there is a problem.

You will see this light flash for a few seconds when you turn your ignition to **Run** or **Start**. Then the light should go out, which means the system is ready.



CAUTION



If the air bag readiness light doesn't come on when you start your vehicle, or stays on, or comes on when you are driving, your air bag system may not work properly. Have your vehicle serviced right away.

How the Air Bag System Works

Q: Where is the air bag?

A: The driver's air bag is in the middle of the steering wheel.



If your vehicle has a right-front passenger air bag, it is located in the instrument panel on the passenger's side.

Q: When is an air bag expected to inflate?

A: The air bag is designed to inflate in moderate to severe frontal or near-frontal crashes. The air bag will only inflate if the velocity of the impact is above the designed threshold level. When impacting straight into a wall that does not move or deform, the threshold level for most GM vehicles is between 9 and 14 mph (14 and 23 km/h). However, this velocity threshold depends on the vehicle design and may be several miles-per-hour faster or slower. In addition, this threshold velocity will be considerably higher if the vehicle strikes an object such as a parked car which will move and deform on impact. The air bag is also not designed to inflate in rollovers, side impacts, or rear impacts where the inflation would provide no occupant protection benefit.

In any particular crash, the determination of whether the air bag

should have inflated cannot be based solely on the level of damage on the vehicle(s). Inflation is determined by the angle of the impact and the vehicle's deceleration, of which vehicle damage is only one indication. Repair cost is not a good indicator of whether an air bag should have deployed.

Q: What makes an air bag inflate?

A: In a frontal impact of sufficient severity, sensors strategically located on the vehicle detect that the vehicle is suddenly stopping as a result of a crash. These sensors complete an electrical circuit, triggering a chemical reaction of the sodium azide sealed in the inflator. The reaction produces nitrogen gas, which inflates the cloth bag. The inflator, cloth bag, and related hardware are all part of the air bag inflator module packed inside the steering wheel and in the instrument panel in front of the passenger if there is a passenger air bag.

Seats & Safety Belts

How the Air Bag System Works (CONT.)

Q: How does an air bag restrain?

A: In moderate to severe frontal or near-frontal collisions, even belted occupants can contact the steering wheel or the instrument panel. The air bag supplements the protection provided by safety belts. Air bags distribute the force of the impact more evenly over the occupant's upper body, stopping the occupant more gradually. But air bags would not provide protection in many types of collisions, including rollovers and rear and side impacts, primarily because an occupant's motion is not toward the air bag. Air bags should never be regarded as anything more than a supplement to safety belt protection in moderate to severe frontal and near-frontal collisions.

Q: What will you see after an air bag inflation?

A: After the air bag has inflated, it will then quickly deflate. This occurs so quickly that some people may not even realize that the air bag inflated. The air bag will **not** impede the driver's vision or ability to steer the vehicle, nor will it hinder the occupants from exiting the vehicle. There will be small amounts of smoke coming from vents in the deflated air bag. Some components of the air bag module in the steering wheel hub for the driver's air bag or the instrument panel for the passenger's bag may be hot for a short time, but the portion of the bag that comes into contact with you will not be hot to the touch. The nitrogen gas used to inflate the

air bag will have vented into the passenger compartment, and the bag will be deflated within seconds after the collision. Nitrogen makes up about 80% of the air we breathe and is not hazardous. As the nitrogen vents from the bag, small particles are also vented into the passenger compartment.

In many crashes severe enough to inflate an air bag, windshields may be broken by vehicle deformation. Additional windshield breakage may occur in vehicles with passenger air bags because the windshield acts as a reaction surface for the inflating air bag.

CAUTION



- Don't attach anything to the steering wheel pad. It might injure the driver if the air bag inflates.
- If your vehicle has the right-front passenger's air bag, don't set anything on or attach anything to the instrument panel. It might injure the passenger if the air bag inflates.
- The air bags are designed to inflate only once. After they inflate, you'll need some new parts for your air bag system. If you don't get them, the air bag system won't be there to help protect you in another crash. A new system will include the air bag modules and possibly other parts. The service manual has information about the need to replace other parts.
- Let only qualified technicians work on your air bag system. Improper service can mean that your air bag system won't work properly. See your dealer for service.

NOTICE

If you damage the cover for the right-front passenger's air bag, it may not work properly. You may have to replace both the air bag and the instrument panel. Don't open or break the air bag cover.

Seats & Safety Belts

Servicing Your Pontiac with the Air Bag System

Please tell or remind anyone who works on your Pontiac that it has the air bag system. There are parts of the air bag system in several places around your vehicle. You don't want the system to inflate while someone is working on your vehicle. The air bag system does not need regular maintenance. Your Pontiac dealer and the 1993 Bonneville Service Manual have information about the air bag system, including repair or disposal.

CAUTION



For up to two minutes after the ignition key is turned off and the battery disconnected, an air bag can still inflate during improper service. You can be injured if you are close to an air bag when it inflates. Be sure to follow the proper service procedures.

When electrical work is done under the hood or inside your vehicle, the ignition should be in **LOCK**, if possible.

Avoid wires wrapped with yellow tape, or yellow connectors. They are probably part of the air bag system.

If your vehicle has a driver's air bag and a right-front passenger's air bag, both bags must be disconnected if the ignition has to be on for electrical work or if the steering column is to be disassembled.

First, disconnect the driver's air bag like this:

- Turn off the ignition.
- Remove the SIR (air bag) fuse (see the *Index* under *Fuses & Circuit Breakers*).
- Disconnect the yellow connector at the base of the steering column.



Safety Belt Use During Pregnancy

Safety belts work for everyone, including pregnant women. Like all occupants, they are more likely to be seriously injured if they don't wear safety belts. A pregnant woman should wear a lap-shoulder belt, and the lap portion should be worn as low as possible throughout the pregnancy.

The best way to protect the fetus is to protect the mother. When a safety belt is worn properly, it's more likely that the fetus won't be hurt in a crash. For pregnant women, as for anyone, the key to making safety belts effective is wearing them properly.

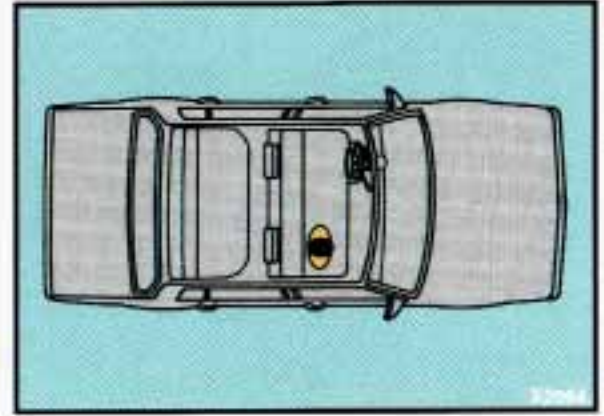

Right Front Passenger Position

The right-front passenger's safety belt works the same way as the driver's safety belt. See the *Index* under *Driver Position*.

When the lap portion of the belt is pulled out all the way, it will lock. If it does, let it go back all the way and start again.

If your vehicle has a center passenger position, be sure to use the correct buckle when buckling your lap-shoulder belt. If you find that the latch plate will not go fully into the buckle, see if you are using the buckle for the center passenger position.

After you follow this procedure for the driver's air bag, then disconnect the right-front passenger's air bag like this:

- Lower the passenger side hush panel under the glove box.
- Disconnect the yellow connector at the base of the instrument panel.

When the work is complete, if the air bag system was disconnected, be sure to reattach everything and replace the fuse before turning the ignition on. When you turn the ignition key on, be sure you see the inflatable restraint light on the instrument panel. If you don't see this light flash and then go out as usual, have your air bag system repaired.

Seats & Safety Belts

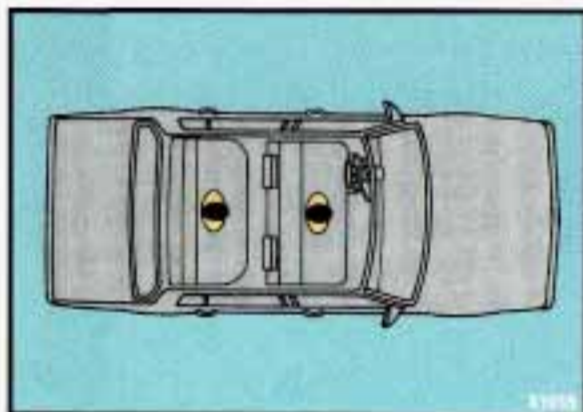

Center Passenger Position

If your vehicle has rear and/or front bench seats, someone can sit in the center positions.



When you sit in a center seating position, you have a lap safety belt, which has no retractor. To make the belt longer, tilt the latch plate and pull it along the belt.



To make the belt shorter, pull its free end as shown until the belt is snug. Buckle, position and release it the same way as the lap part of a lap-shoulder belt.

If the belt isn't long enough, see the *Index* under *Safety Belt Extender*. Make sure the release button on the buckle faces upward or outward so you would be able to unbuckle it quickly if you ever had to.

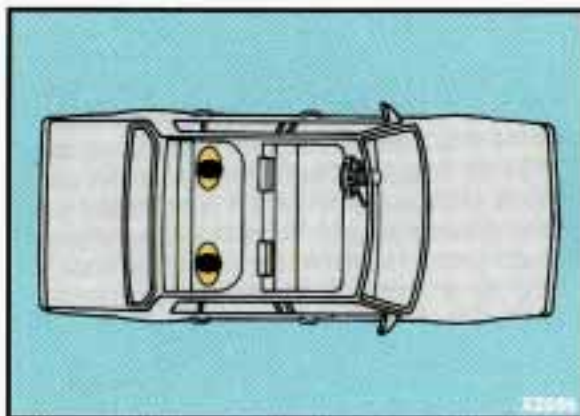

Rear Seat Passengers

It's very important for rear seat passengers to buckle up! Accident statistics show that unbelted people in the rear seat are hurt more often in crashes than those who are wearing safety belts.

Rear passengers who aren't safety belted can be thrown out of the vehicle in a crash. And they can strike others in the vehicle who are wearing safety belts.

Rear Seat Outside Passenger Positions

The positions next to the windows have lap-shoulder belts.

Here's How to Wear One Properly:

- 1.** Pick up the latch plate and pull it across you. Don't let it get twisted.
- 2.** Push the latch plate into the buckle until it clicks.

When the lap belt is pulled out all the way, it will lock. If it does, let it go back all the way and start again.

If the belt is not long enough, see the *Index* under *Safety Belt Extender*.

Make sure the release button on the buckle faces upward or outward so you would be able to unbuckle it quickly if you ever had to.

Seats & Safety Belts

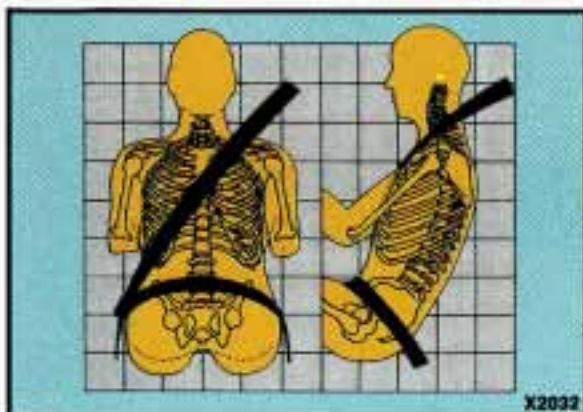

Rear Seat Outside Passenger Positions (CONT.)

The lap part of the belt should be worn low and snug on the hips, just touching the thighs. In a crash, this applies force to the strong pelvic bones. And you'd be less likely to slide under the lap belt. If you slid under it, the belt would apply force at your abdomen. This could cause serious or even fatal injuries. The shoulder belt should go over the shoulder and across the chest. These parts of the body are best able to take belt restraining forces.

The safety belt locks if there's a sudden stop or a crash.

CAUTION



You can be seriously hurt if your shoulder belt is too loose. In a crash, you would move forward too much, which could increase injury. The shoulder belt should fit against your body.



To unlatch the belt, just push the button on the buckle.



■ Children

Everyone in a vehicle needs protection! That includes infants and all children smaller than adult size. In fact, the law in every state and Canadian province says children up to some age must be restrained while in a vehicle.

Smaller Children and Babies

CAUTION

 Smaller children and babies should always be restrained in a child or infant restraint. The instructions for the restraint will say whether it is the right type and size for your child. A very young child's hip bones are so small that a regular belt might not stay low on the hips, as it should. Instead, the belt will likely be over the child's abdomen. In a crash the belt would apply force right on the child's abdomen, which could cause serious or fatal injuries. So, be sure that any child small enough for one is always properly restrained in a child or infant restraint.



CAUTION

 Never hold a baby in your arms while riding in a vehicle. A baby doesn't weigh much—until a crash. During a crash a baby will become so heavy you can't hold it. For example, in a crash at only 25 mph (40 km/h), a 12-pound (5.5 kg) baby will suddenly become a 240-pound (110 kg) force on your arms. The baby would be almost impossible to hold.

(Continued)

Seats & Safety Belts



Smaller Children and Babies ***(CONT.)***

CAUTION



(Continued)

Secure the baby in an infant restraint.

Child Restraints

Be sure to follow the instructions for the restraint. You may find these instructions on the restraint itself or in a booklet, or both. These restraints use the belt system in your vehicle, but the child also has to be secured within the restraint to help reduce the chance of personal injury. The instructions that come with the infant or child restraint will show you how to do that.

Where to Put the Restraint

Accident statistics show that children are safer if they are restrained in the rear rather than the front seat. We at General Motors therefore recommend that you put your child restraint in the rear seat. If your vehicle has an air bag for the front passenger, **never** put a rear-facing child restraint in the front passenger seat. Here's why:

CAUTION

 A child in a rear-facing child restraint can be seriously injured if the right-front passenger's air bag inflates. This is because the back of a rear-facing child restraint would be very close to the inflating air bag. If your vehicle has a right-front passenger's air bag, always secure a rear-facing child restraint in the rear seat.

You may secure a forward-facing child restraint in the right-front seat. However, before securing a forward-facing child restraint, **ALWAYS** move the front passenger seat as far back as it will go. Or, secure the child restraint in the rear seat.

CAUTION

 A child in a child restraint in the front-center seat can be badly injured by the passenger air bag if it inflates. **NEVER** use a child restraint in the front-center seat. It's always better to secure a child restraint in the rear seat. You may, however, secure a forward-facing child restraint in the right-front passenger seat only with the seat moved all the way back.

Wherever you install it, be sure to secure the child restraint properly.

CAUTION

 An unsecured child restraint can move around in a collision or sudden stop and injure people in the vehicle. Be sure to properly secure any child restraint in your vehicle—even when no child is in it.

Seats & Safety Belts

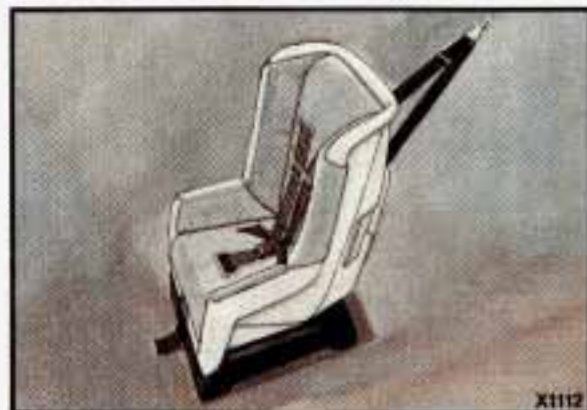

Top Strap

If your child restraint has a top strap, it should be anchored. If you need to have an anchor installed, you can ask your Pontiac dealer to put it in for you. If you want to install an anchor yourself, your dealer can tell you how to do it.

Vehicles first sold in Canada have child restraint anchor bracket hardware in the glove box, along with instructions for installing it. This should be used only with a child restraint, and only to secure a child restraint at the center rear seating position. Additional anchor brackets for child restraints at one or both of the rear outside seating positions are available at Pontiac dealerships in Canada.

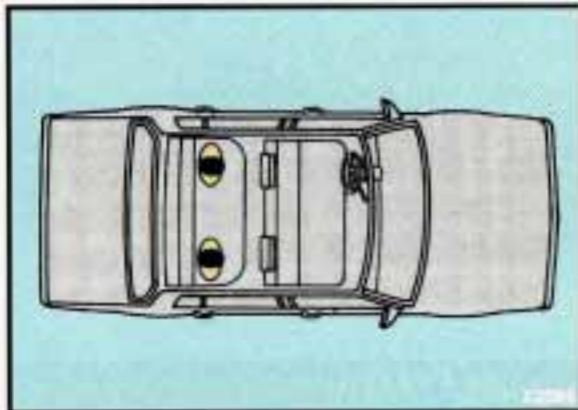

Securing a Child Restraint in a Rear Outside Position

You'll be using the lap-shoulder belt. See the earlier section about the top strap if the child restraint has one.

1. Put the restraint on the seat. Follow the instructions for the child restraint.
2. Secure the child in the child restraint as the instructions say.
3. Pull out the vehicle's safety belt and run the lap part through or around the restraint. The child restraint instructions will show you how.

See if the shoulder belt would go in front of the child's face or neck. If so, put it behind the child restraint.



4. Buckle the belt. Make sure the release button faces upward or outward, so you'll be able to unbuckle it quickly if you ever need to.



5. Pull the rest of the lap belt all the way out of the retractor to set the lock.



6. To tighten the belt, feed it into the retractor while you push down on the child restraint.



7. Push and pull the child restraint in different directions to be sure it is secure.

To remove the child restraint, just unbuckle the vehicle's safety belt and let it go back all the way. The safety belt will move freely again and be ready to work for an adult or larger child passenger.

Seats & Safety Belts

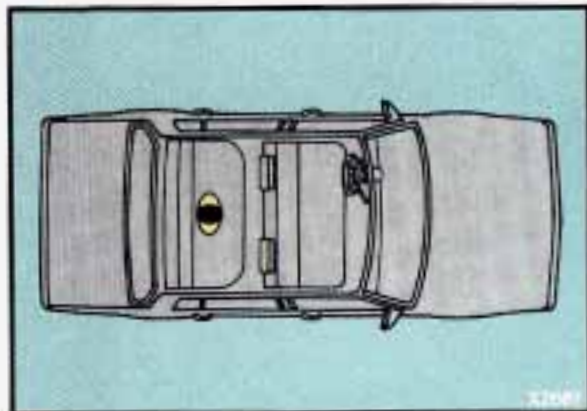

Securing a Child Restraint in a Center Seat Position

When you secure a child restraint in a center seating position, you'll be using the lap belt. See the earlier section about the top strap if the child restraint has one.



1. Make the belt as long as possible by tilting the latch plate and pulling it along the belt.
2. Put the restraint on the seat. Follow the instructions for the child restraint.
3. Secure the child in the child restraint as the instructions say.



4. Run the vehicle's safety belt through or around the restraint. The child restraint instructions will show you how.
5. Buckle the belt. Make sure the release button faces upward or outward, so you'll be able to unbuckle it quickly if you ever need to.
6. To tighten the belt, pull its free end while you push down on the child restraint.

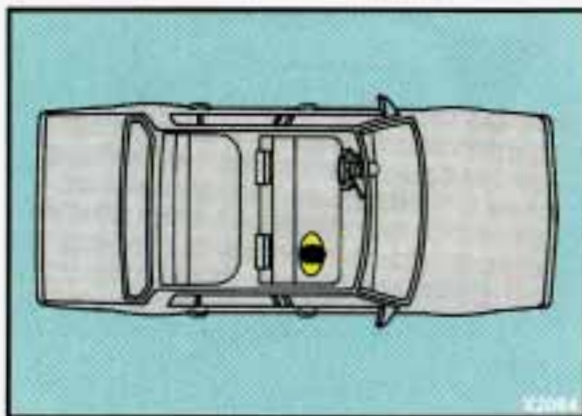

Securing a Child Restraint in the Right Front Seat

If you have the right-front passenger's air bag, **never** put a rear-facing child restraint in this position. Here's why:

CAUTION

 A rear-facing child restraint in the front seat could be pushed into the seatback by the right-front passenger's air bag if it inflates. A child in a rear-facing child restraint can be seriously injured if this happens. Always secure a rear-facing child restraint in the rear seat.

7. Push and pull the child restraint in different directions to be sure it is secure. If the child restraint isn't secure, turn the latch plate over and buckle it again. Then see if it is secure. If it isn't, secure the restraint in a different place in the vehicle and contact the child restraint maker for their advice.

To remove the child restraint, just unbuckle the vehicle's safety belt. It will be ready to work for an adult or larger child passenger.

You'll be using the lap-shoulder belt. See the earlier section about the top strap if the child restraint has one.

Seats & Safety Belts



Securing a Child Restraint in the Right Front Seat (CONT.)

- 1.** If you have the right-front passenger's SIR, move the seat as far back as it will go before securing a front-facing child restraint.
- 2.** Put the restraint on the seat. Follow the instructions for the child restraint.
- 3.** Secure the child in the child restraint as the instructions say.
- 4.** Pull out the vehicle's safety belt and run the lap part through or around the restraint. The child restraint instructions will show you how.
See if the shoulder belt would go in front of the child's face or neck. If so, put it behind the child restraint.

- 5.** Buckle the belt. Make sure the release button faces upward or outward, so you'll be able to unbuckle it quickly if you ever need to.

- 6.** Pull the rest of the lap belt all the way out of the retractor to set the lock.



7. To tighten the belt, feed the lap belt back into the retractor while you push down on the child restraint.



8. Push and pull the child restraint in different directions to be sure it is secure.

To remove the child restraint, just unbuckle the vehicle's safety belt and let it go back all the way. The safety belt will move freely again and be ready to work for an adult or larger child passenger.

Seats & Safety Belts



Larger Children

Children who have outgrown child restraints should wear the vehicle's safety belts. If you have the choice, a child should sit next to a window so the child can wear a lap-shoulder belt and get the additional restraint a shoulder belt can provide.

Accident statistics show that children are safer if they are restrained in the rear seat. But they need to use the safety belts properly.

- Children who aren't buckled up can be thrown out in a crash.



- Children who aren't buckled up can strike other people who are.



CAUTION



Never do this.

Here two children are wearing the same belt. The belt can't properly spread the impact forces. In a crash, the two children can be crushed together and seriously injured. A belt must be used by only one person at a time.



CAUTION



Never do this.

Here a child is sitting in a seat that has a lap-shoulder belt, but the shoulder part is behind the child. If the child wears the belt in this way, in a crash the child might slide under the belt. The belt's force would then be applied right on the child's abdomen. That could cause serious or fatal injuries.

Wherever the child sits, the lap portion of the belt should be worn low and snug on the hips, just touching the child's thighs. This applies belt force to the child's pelvic bones in a crash.

Safety Belt Extender

If the vehicle's safety belt will fasten around you, you should use it. But if a safety belt isn't long enough to fasten, your dealer will order you an extender. It's free. When you go in to order it, take the heaviest coat you will wear, so the extender will be long enough for you. The extender will be just for you, and just for the seat in your vehicle that you choose. Don't let someone else use it, and use it only for the seat it is made to fit. To wear it, just attach it to the regular safety belt.

Q: What if a child is wearing a lap-shoulder belt, but the child is so small that the shoulder belt is very close to the child's face or neck?

A: Move the child toward the center of the vehicle, but be sure that the shoulder belt still is on the child's shoulder, so that in a crash the child's upper body would have the restraint that belts provide.

If the child is so small that the shoulder belt is still very close to the child's face or neck, you might want to place the child in the center seat position, the one that has only a lap belt.

Seats & Safety Belts

Checking Your Restraint Systems

Now and then, make sure all your belts, buckles, latch plates, retractors, anchorages and reminder systems are working properly. Look for any loose parts or damage. If you see anything that might keep a restraint system from doing its job, have it repaired.

Replacing Safety Belts After a Crash

If you've had a crash, do you need new belts?

After a very minor collision, nothing may be necessary. But if the belts were stretched, as they would be if worn during a more severe crash, then you need new belts.

If belts are cut or damaged, replace them. Collision damage also may mean you will have to have safety belt parts, like the retractor, replaced or anchorage locations repaired—even if the belt wasn't being used at the time of the collision.

If your seat adjuster won't work after a crash, the special part of the safety belt that goes through the seat to the adjuster may need to be replaced.

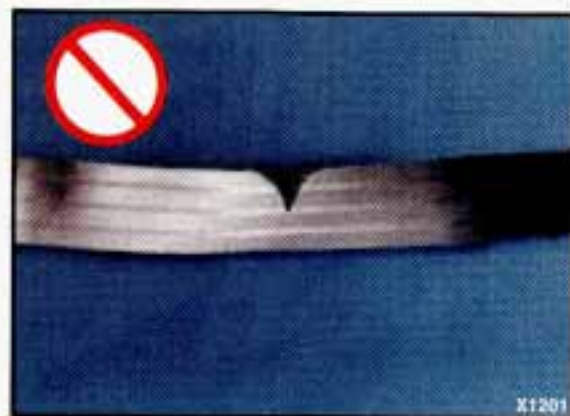

Q: What's wrong with this?

A: The belt is torn.

CAUTION



Torn or frayed belts may not protect you in a crash. They can rip apart under impact forces. If a belt is torn or frayed, get a new one right away.



Part **2**

Features & Controls

Here you can learn about the many standard and optional features on your Pontiac, and information on starting, shifting and braking. Also explained are the instrument panel and the warning systems that tell you if everything is working properly—and what to do if you have a problem.

Keys	46
Locks	47
Remote Keyless Entry	48
Glove Box	56
Ignition Switch	57
Starting Your Engine	58
Shifting the Transaxle	61
Parking Brake	67
Shifting into Park	68
Windows	73
Turn Signal/Headlight Beam Lever	73
Windshield Wipers	75
Windshield Washer	76
Cruise Control	77
Light Controls	81
Interior Lights	84
Mirrors	86
Sunroof	89
Ashtrays and Lighter	91
Instrument Panel	94
Warning Lights, Gages and Indicators	99
Gages	108
Driver Information Center	111
Electronic Compass	113
Head-Up Display	116

Features & Controls



Keys

CAUTION



Leaving young children in a vehicle with the ignition key is dangerous for many reasons. A child or others could be badly injured or even killed. They could operate power windows or other controls or even make the vehicle move. Don't leave the keys in a vehicle with young children.



The ignition keys are for the ignition only.



The door keys are for the doors and all other locks.

When a new Pontiac is delivered, the dealer removes the plugs from the keys and gives them to the first owner. However, the ignition key may not have a plug.

Each plug has a code on it that tells your dealer or a qualified locksmith how to make extra keys. Keep the plugs in a safe place. If you lose your keys, you'll be able to have new ones made easily using these plugs. If your ignition keys don't have plugs, go to your Pontiac dealer for the correct key code if you need a new ignition key.

There are 15 alternative PASS-Key® blanks, to help discourage theft. Your dealer can help determine which blank you need.

NOTICE

Your Pontiac has a number of new features that can help prevent theft. But you can have a lot of trouble getting into your vehicle if you ever lock your keys inside. You may even have to damage your vehicle to get in. So be sure you have extra keys.

Door Locks



CAUTION



Unlocked doors can be dangerous.

Passengers—especially children—can easily open the doors and fall out. When a door is locked, the inside handle won't open it.

Outsiders can easily enter through an unlocked door when you slow down or stop your vehicle.

This may not be so obvious: You increase the chance of being thrown out of the vehicle in a crash if the doors aren't locked. Wear safety belts properly, lock your doors, and you will be far better off whenever you drive your vehicle.

There are several ways to lock and unlock your vehicle.

From the Outside:

Use your door key or Remote Keyless Entry, if your vehicle has this option. If you have the Theft Deterrent System, you will also unlock and lock all doors when you unlock or lock either front door with your key.

From the Inside:

To lock the door, slide the locking lever rearward.

To unlock the door, slide the locking lever forward.

Features & Controls



Power Door Locks

With power door locks, you can lock or unlock all the doors of your vehicle from the driver or front passenger door lock switch.

The lever on each rear door works only that door's lock. It won't lock (or unlock) all of the doors—that's a safety feature.

Leaving Your Vehicle

If you are leaving the vehicle, open your door and set the locks from inside, then get out and close the door.

If your vehicle has the Theft-Deterrent System option, see *Theft-Deterrent System* later in this section.



Remote Keyless Entry (OPTION)

If your Pontiac has this option, you can lock and unlock your doors or unlock your trunk from about 15 feet (4.5 m) away using the key chain transmitter supplied with your vehicle.

Operation

The driver's door will unlock when **UNLOCK** is pressed. If pressed again within 25 seconds, all doors will unlock. All doors will lock when **LOCK** is pressed.

The trunk will unlock when the opened trunk symbol is pressed, but only when the ignition is off.

Press any button to illuminate the interior lights (see the *Index* under *Illuminated Entry System*).

Matching Transmitters to Your Vehicle

Each key chain transmitter is coded to prevent another transmitter from unlocking your vehicle. If a transmitter is lost or stolen, a replacement can be purchased through your dealer.

Remember to bring the remaining transmitter with you when you go to your dealer. When the dealer matches the replacement transmitter to your vehicle, the remaining transmitter must also be matched. Once the new transmitter is coded, the lost transmitter will not unlock your vehicle.

You can match a transmitter to as many different vehicles as you own, provided they are equipped with **exactly the same model system**. (General Motors offers several different models of these systems on their vehicles.) Each vehicle can have only two transmitters matched to it. See your dealer to match transmitters to another vehicle.

Your Remote Keyless Entry operates on a radio frequency subject to Federal Communications Commission (FCC) Rules.

This device complies with Part 15 of the FCC Rules. Operation is subject to the following two conditions: (1) This device may not cause harmful interference, and (2) This device must accept any interference received, including interference that may cause undesired operation.

Should interference to this system occur, try this:

- Check to determine if battery replacement is necessary. See the instructions on battery replacement.
- Check the distance. You may be too far from your vehicle. This product has a maximum range.
- Check the location. Other vehicles or objects may be blocking the signal.
- See your Pontiac dealer or a qualified technician for service.

Changes or modifications to this system by other than an authorized service facility could void authorization to use this equipment.

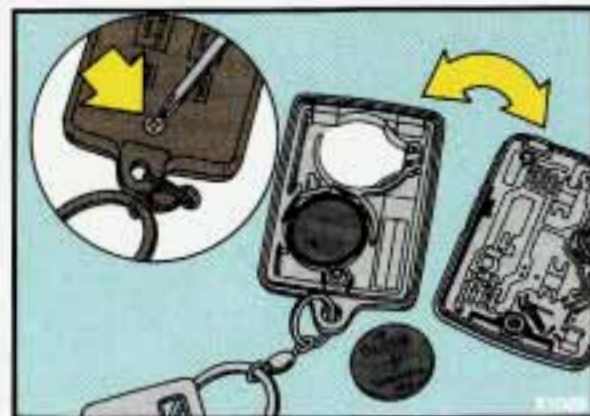

Battery Replacement

Under normal use, the batteries in your key chain transmitter should last about two years.

You can tell the batteries are weak if the transmitter won't work at the normal range in any location. If you have to get close to your vehicle before the transmitter works, it's probably time to change the batteries.

To Replace Batteries in the Remote Keyless Entry:

1. Remove the screw from back cover.
2. Lift the front cover off, bottom half first.
3. Remove and replace the two batteries (2016).
4. Reassemble the transmitter.
5. Check the transmitter operation.

Features & Controls



Rear Door Security Locks

Your Pontiac is equipped with rear door security locks that help prevent passengers from opening the rear doors of your vehicle from the inside. To use one of these locks:

1. Move the lever on the door all the way up to the **ENGAGED** position.
2. Close the door.
3. Do the same thing to the other rear door lock.

The rear doors of your vehicle cannot be opened from inside when this feature is in use. If you want to open a rear door when the security lock is on:

1. Unlock the door from the inside.

2. Then open the door from the outside. If you don't cancel the security lock feature, adults or older children who ride in the rear won't be able to open the rear door from the inside. You should let adults and older children know how these security locks work, and how to cancel the locks.

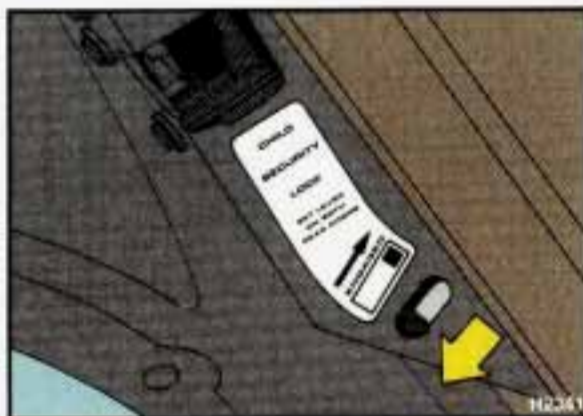

To cancel the rear door lock:

1. Unlock the door from the inside and open the door from the outside.

2. Move the lever all the way down.

3. Do the same for the other rear door. The rear door locks will now work normally.

Theft

Vehicle theft is big business, especially in some cities. Although your Pontiac has a number of theft-deterrent features, we know that nothing we put on it can make it impossible to steal. However, there are ways you can help.

Key in the Ignition:

If you walk away from your vehicle with the keys inside, it's an easy target for joy riders or professional thieves—so don't do it. When you park your Pontiac and open the driver's door, you'll hear a tone reminding you to remove your key from the ignition and take it with you. Always do this. Your steering wheel will be locked, and so will your ignition and transaxle.

Features & Controls



Theft (CONT.)

Parking at Night:

Park in a lighted spot, close all windows and lock your vehicle. Remember to keep your valuables out of sight. Put them in a storage area, or take them with you.

Parking Lots:

If you park in a lot where someone will be watching your vehicle, it's best to lock it up and take your keys. But what if you have to leave your ignition key? What if you have to leave something valuable in your vehicle?

- Put your valuables in a storage area, like your trunk or glove box.
- Lock the glove box.
- Lock all the doors except the driver's.
- Then take the door key with you.

PASS-Key II™

Your vehicle is equipped with the PASS-Key II™ (Personalized Automotive Security System) theft-deterrent system. PASS-Key II™ is a passive theft-deterrent system. This means you don't have to do anything to arm or disarm the system. It works when you insert or remove the key from the ignition. PASS-Key™ uses a resistor pellet in the ignition key that matches a decoder in your vehicle.

When the PASS-Key II™ system senses that someone is using the wrong key, it shuts down the vehicle's starter and fuel systems. For about three minutes, the starter won't work and fuel won't go to the engine. If someone tries to start your vehicle again or uses another key during this time, the vehicle will not start. This discourages someone from randomly trying different keys with different resistor pellets in an attempt to make a match.



The ignition key must be clean and dry before it's inserted in the ignition or the engine may not start.

If the engine does not start and the **SECURITY** light is on, the key may be dirty or wet. Turn the ignition off. Clean and dry the key. Wait about three minutes and try again. The security light may remain on during this time. If the starter still won't work, and the key appears to be clean and dry, wait about three minutes and try the other ignition key. At this time, you may also want to check the fuse (see the *Index* under *Fuses & Circuit Breakers*). If the starter won't work with the other key, your vehicle needs service. If your vehicle does start, the first ignition key may be faulty. See your Pontiac dealer or a

locksmith who can service the PASS-Key II™

If you accidentally use a key that has a damaged or missing resistor pellet, the starter won't work and the **SECURITY** light will flash. But you don't have to wait three minutes before trying one of the other ignition keys. See your Pontiac dealer or a locksmith who can service the PASS-Key II™ to have a new key made.

If you're ever driving and the **SECURITY** light comes on and remains on, you will be able to restart your engine if you turn it off. Your PASS-Key II™ system, however, is not working properly and must be serviced by your Pontiac dealer. Your vehicle is not protected by the PASS-Key II™ system.

If you lose or damage a PASS-Key II™ ignition key, see your Pontiac dealer or a locksmith who can service PASS-Key II™ to have a new key made.

Theft-Deterrent System (OPTION)

If your Pontiac has this option, it has a theft-deterrent alarm system. With this system, the **SECURITY** light will flash when you open the door (if your ignition is off).

This light reminds you to arm the theft-deterrent system when leaving your vehicle.

To Arm the System:

1. Open the door.
2. Lock the door with the power door lock switch or Keyless Entry transmitter. The **SECURITY** light should come on and stay on.
3. Close all doors. The **SECURITY** light will go off after about 30 seconds and the system will then be armed.

Features & Controls

Theft-Deterrent System (CONT.)

If the **SECURITY** light comes on for one minute and then shuts off while the ignition is on, the security system has detected a problem with itself. See your dealer for service.

If a door or the trunk is opened without the key or the Keyless Entry transmitter, the alarm will go off. It will also go off if the trunk lock is damaged or if the ignition is turned on. Your vehicle's lights will flash and the horn will sound for three minutes, then will go off to save battery power. And your vehicle will not start.

Remember, the theft-deterrent system won't arm if you lock the doors with a key or manual door lock. It arms only if you use a power door lock switch or Keyless Entry transmitter.

To Avoid Setting Off the Alarm by Accident:

If you don't want to arm the theft-deterrent system, the vehicle should be locked with a key **after** the doors are closed.

Always unlock a door with a key, or use the Keyless Entry System transmitter. Unlocking a door any other way will set off the alarm.

To Stop the Alarm:

If you set off the alarm by accident, unlock any door with your key. You can also turn off the alarm by pressing the **UNLOCK** button on the Keyless Entry System transmitter. The alarm won't stop if you try to unlock a door any other way.

To Test the Alarm:

Roll your window down, then follow the directions under *To Arm the System* earlier. Once the alarm is set, reach through the window and manually unlock the door from the inside or turn on the ignition. The alarm should sound.

If the alarm does not sound when it should, check to see if your horn works. The horn fuse may be blown. To replace the fuse, see the *Index* under *Fuses & Circuit Breakers*.

To reduce the possibility of theft, always arm the theft-deterrent system when leaving your vehicle.

Illuminated Entry System (OPTION)

When you lift the lever of either front door, a light will glow around the door lock. This will help you insert the door key at night.

The lights inside your vehicle will also go on. These lights will go off after about 20 seconds, or when you start your engine. These lights will also go on when you press any button on the optional Remote Keyless Entry transmitter.

If a door is left ajar, your interior lights will turn off after ten minutes to save your battery.



Trunk Lock

To unlock the trunk from the outside, insert the door key and turn it.

Features & Controls



Remote Trunk Release (OPTION)

Press the trunk release button located below the driver's door armrest to release the trunk lid. The ignition must be on and the transaxle must be in **P** (Park). The system also works with the Remote Keyless Entry System.

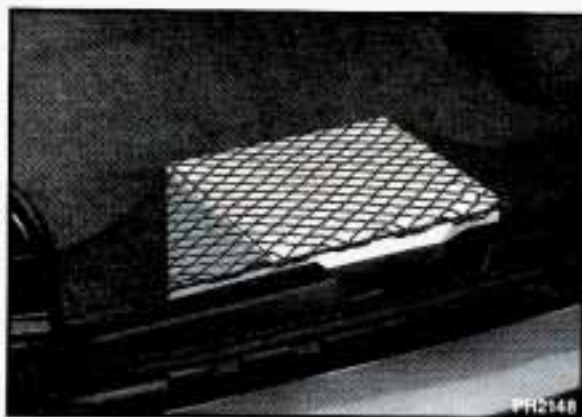

Convenience Net (OPTION)

Your vehicle may have a convenience net. You'll see it just inside the back wall of the trunk.

Put small loads, like grocery bags, behind the net to help keep them from falling over during sharp turns or quick starts and stops.

The net isn't for larger, heavier loads. Store them in the trunk as far forward as you can.

You can unhook the net so that it will lie flat when you're not using it.



Glove Box

Use the door key to lock and unlock the glove box. To open, lift the latch release on the left side of the glove box door.

There's a special shelf inside for storing this manual.

New Vehicle "Break-In"

NOTICE

Your modern Pontiac doesn't need an elaborate "break-in." But it will perform better in the long run if you follow these guidelines:

- Don't drive at any one speed—fast or slow—for the first 500 miles (804 km). Don't make full-throttle starts.
- Avoid making hard stops for the first 200 miles (322 km) or so. During this time your new brake linings aren't yet broken in. Hard stops with new linings can mean premature wear and earlier replacement. Follow this "breaking-in" guideline every time you get new brake linings.

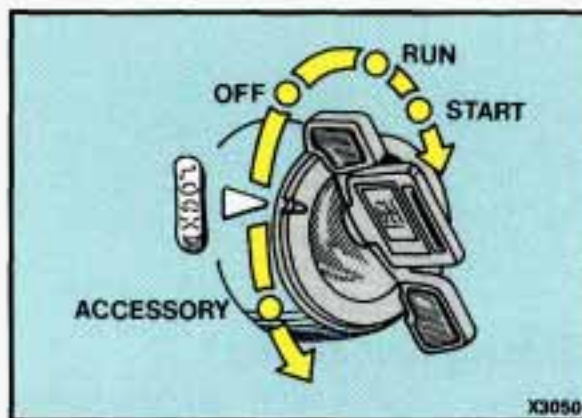

Ignition Switch

With the ignition key in the ignition switch, you can turn the switch to five positions:

Accessory: An "on" position in which you can operate your electrical power accessories. Press in the ignition switch as you turn the top of it toward you.

Lock: The only position in which you can remove the key. This locks your steering wheel, ignition and transaxle.

Off: Unlocks the steering wheel, ignition, and transaxle, but does not send electrical power to any accessories. Use this position if your vehicle must be pushed or towed, but never try to push-start your vehicle. A warning chime will sound if you open the driver's door when the ignition is off and the key is in the ignition.

Run: An "on" position to which the switch returns after you start your engine and release the switch. The switch stays in the **Run** position when the engine is running. But even when the engine is not running, you can use **Run** to operate your electrical power accessories, and to display some instrument panel warning lights.

Start: Starts the engine. When the engine starts, release the key. The ignition switch will return to **Run** for normal driving.

Note that even if the engine is not running, the positions **Accessory** and **Run** are "on" positions that allow you to operate your electrical accessories, such as the radio.

Key Reminder Warning

If you leave your key in the ignition, in the **Off** position, you will hear a warning tone when you open the driver's door.

Features & Controls

Ignition Switch (CONT.)

Retained Accessory Power:

If you have this option, after you turn your ignition off and even remove the key, you will still have electrical power to such accessories as the radio, power windows and trunk release for up to ten minutes. But if you open a door, power is shut off.

NOTICE

If your key seems stuck in **Lock** and you can't turn it, be sure it is all the way in. If it is, then turn the steering wheel left and right while you turn the key hard. But turn the key only with your hand. Using a tool to force it could break the key or the ignition switch. If none of this works, then your vehicle needs service.

Starting Your Engine

Engines start differently. The 8th digit of your Vehicle Identification Number (VIN) shows the code letter or number for your engine. You will find the VIN at the top left of your instrument panel. (See the *Index* under *Vehicle Identification Number*.) Follow the proper steps to start the engine.

Move your shift lever to **P** (Park) or **N** (Neutral). Your engine won't start in any other position—that's a safety feature. To restart when you're already moving, use **N** (Neutral) only.

NOTICE

Don't try to shift to **P** (Park) if your Pontiac is moving. If you do, you could damage the transaxle. Shift to **P** (Park) only when your vehicle is stopped.

1. Don't push the accelerator pedal before starting your engine. In some other vehicles you might need to do this, but because of your vehicle's computer systems, you don't.
2. Turn your ignition key to **Start**. When the engine starts, let go of the key. The idle speed will go down as your engine gets warm.



3800 Tuned Port Injection Engine (Code L):

3. If it doesn't start right away, hold your key in **Start** for about three seconds at a time until your engine starts. Wait about 15 seconds between each try to help avoid draining your battery.

3800 Supercharged Engine (Code 1):

3. If it doesn't start right away, hold your key in **Start** for about three to five seconds at a time until your engine starts. Wait about 15 seconds between each try to help avoid draining your battery.

NOTICE

Holding your key in **Start** for longer than 15 seconds at a time will cause your battery to be drained much sooner. And the excessive heat can damage your starter motor.

4. If your engine still won't start (or starts but then stops), it could be flooded with too much gasoline. Try pushing your accelerator pedal all the way to the floor and holding it there as you hold the key in **Start** for about three seconds. If the vehicle starts briefly but then stops again, do the same thing, but this time keep the pedal down for five or six seconds. This clears the extra gasoline from the engine. After waiting about 15 seconds, repeat the normal starting procedure.

NOTICE

Your engine is designed to work with the electronics in your vehicle. If you add electrical parts or accessories, you could change the way the fuel injection system operates. Before adding electrical equipment, check with your dealer. If you don't, your engine might not perform properly.

If you ever have to have your vehicle towed, see the part of this manual that tells how to do it without damaging your vehicle. See the *Index* under *Towing Your Pontiac*.

Features & Controls



Driving Through Deep Standing Water

NOTICE

If you drive too quickly through deep puddles or standing water, water can come in through your engine's air intake and badly damage your engine. If you can't avoid deep puddles or standing water, drive through them very slowly.

Engine Block Heater (OPTION)

In very cold weather, 0°F (-18°C) or colder, the engine block heater can help. You'll get easier starting and better fuel economy during engine warm-up.

To Use the Block Heater:

1. Turn off the engine.
2. Open the hood and unwrap the electrical cord.
3. Plug it into a normal, grounded 110-volt outlet.

CAUTION



Plugging the cord into an ungrounded outlet could cause an electrical shock. Also, the wrong kind of extension cord could overheat and cause a fire. You could be seriously injured. Plug the cord into a properly grounded three-prong 110-volt outlet. If the cord won't reach, use a heavy-duty three-prong extension cord rated for at least 15 amps.



NOTICE

After you've used the block heater, be sure to store the cord as it was before, to keep it away from moving engine parts. If you don't, it could be damaged.

How long should you keep the block heater plugged in? The answer depends on the weather, the kind of oil you have, and some other things. Instead of trying to list everything here, we ask that you contact a Pontiac dealer in the area where you'll be parking your vehicle. The dealer can give you the best advice for that particular area.

■ *Shifting the Automatic Transaxle*

Your automatic transaxle may have a shift lever located on the console between the seats or on the steering column. Both are shown.

There are several shift positions. In this manual, these are referred to by the commonly used symbols in the right column below:

Park	P
Reverse	R
Neutral	N
Overdrive	D
Drive	D
Second	2
First	1

Features & Controls



Park

P (Park): This locks your front wheels. It's the best position to use when you start your engine because your vehicle can't move easily.

CAUTION



It is dangerous to get out of your vehicle if the shift lever is not fully in **P (Park)** with the parking brake firmly set. Your vehicle can roll.

Don't leave your vehicle when the engine is running unless you have to. If you have left the engine running, the vehicle can move suddenly. You or others could be injured. To be sure your vehicle won't move, even when you're on fairly level ground, always set your parking brake and move the shift lever to **P (Park)**. See the *Index* under *Shifting into P (Park)*. If you are parking on a hill, or if you're pulling a trailer, also see the *Index* under *Parking on Hills* or *Towing a Trailer*.

Ensure the shift lever is fully in **P (Park)** range before starting the engine. Your Pontiac has a brake-transaxle shift interlock. You have to fully **apply** your regular brakes **before** you can shift from **P (Park)** when the ignition key is in the **On** position. If you cannot shift out of **P (Park)**, ease pressure on the shift lever—push the shift lever all the way into **P (Park)** and also release the shift lever button on floor shift console models as you maintain brake application. Then move the shift lever into the gear you wish. (Press the shift lever button before moving the shift lever on floor shift console models.) See *Shifting Out of P (Park)* later in this section.



Reverse

R (Reverse): Use this gear to back up.

NOTICE

Shifting to **R** (Reverse) while your vehicle is moving forward could damage your transaxle. Shift to **R** only after your vehicle is stopped.



To rock your vehicle back and forth to get out of snow, ice, or sand without damaging your transaxle, see the *Index* under *If You're Stuck: In Sand, Mud, Ice, or Snow*.



Neutral

N (Neutral): In this position, your engine doesn't connect with the wheels. To restart when you're already moving, use **N** (Neutral) only. Also, use **N** when your vehicle is being towed.

Features & Controls



Neutral (CONT.)

CAUTION



Shifting out of **P** (Park) or **N** (Neutral) while your engine is “racing” (running at high speed) is dangerous. Unless your foot is firmly on the brake pedal, your vehicle could move very rapidly. You could lose control and hit people or objects. Don't shift out of **P** (Park) or **N** (Neutral) while your engine is racing.

NOTICE

Damage to your transaxle caused by shifting out of **P** (Park) or **N** (Neutral) with the engine racing isn't covered by your warranty.



Forward Gears

D (Automatic Overdrive): This position is for normal driving. If you need more power for passing, and you're:

- Going less than about 35 mph (56 km/h), push your accelerator pedal about halfway down.
- Going about 35 mph (56 km/h) or more, push the accelerator all the way down.

You'll shift down to the next gear and have more power.



H2354

NOTICE

If your vehicle seems to start up rather slowly, or if it seems not to shift gears as you go faster, something may be wrong with a transaxle system sensor. If you drive very far that way, your vehicle can be damaged. So, if this happens, have your vehicle serviced right away. Until then, you can use **2** (Second Gear) when you are driving less than 35 mph (56 km/h) and **D** (Overdrive) for higher speeds.

D (Third Gear): This is like **D**, but you never go into Overdrive. Here are some times you might choose **D** instead of **D**:

- When driving on hilly, winding roads.
- When towing a trailer, so there is less shifting between gears.
- When going down a steep hill.

2 (Second Gear): This position gives you more power but lower fuel economy. You can use **2** on hills. It can help control your speed as you go down steep mountain roads, but then you would also want to use your brakes off and on.

NOTICE

Don't drive in **2** (Second Gear) for more than 5 miles (8 km), or at speeds over 55 mph (88 km/h), or you can damage your transaxle. Use **D** or **D** as much as possible. Don't shift into **2** unless you are going slower than 65 mph (105 km/h), or you can damage your engine.

Features & Controls

Forward Gears (CONT.)

1 (First Gear): This position gives you even more power (but lower fuel economy) than **2**. You can use it on very steep hills, or in deep snow or mud. If the selector lever is put in **1**, the transaxle won't shift into first gear until the vehicle is going slowly enough.

NOTICE

If your front wheels can't rotate, don't try to drive. This might happen if you were stuck in very deep sand or mud or were up against a solid object. You could damage your transaxle.

Also, if you stop when going uphill, don't hold your vehicle there with only the accelerator pedal. This could overheat and damage the transaxle. Use your brakes or shift into **P (Park)** to hold your vehicle in position on a hill.



Performance Shifting (OPTION)

Press **PERFORM SHIFT** to allow the transaxle to shift at higher engine speeds, increasing acceleration performance. An indicator light on the switch will glow when performance shifting is in operation.

Downshifts will occur at a lower percentage of accelerator application while you're in the **PERFORM SHIFT** mode.

Press **NORMAL SHIFT** to have the transaxle shift at lower engine speeds, increasing fuel economy. An indicator light on the switch will glow when normal shifting is in operation.

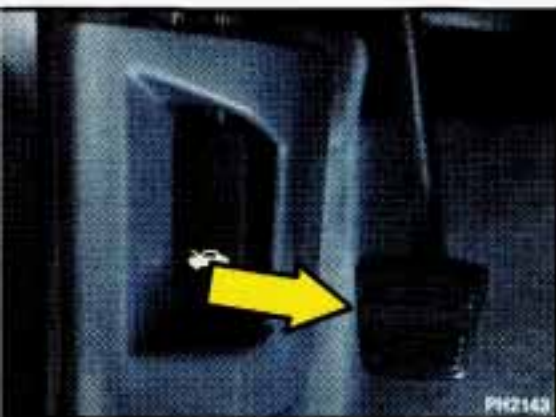

Parking Brake

To Set the Parking Brake:

Hold the regular brake pedal down with your right foot. Push down the parking brake pedal with your left foot. If the ignition is on, the brake system warning light will come on. A chime will sound after the vehicle has traveled 46 feet (14 meters).



To Release the Parking Brake:

Hold the regular brake pedal down. Pull the **BRAKE RELEASE** lever. If you try to drive off with the parking brake on, the brake light stays on and a chime sounds until you release the parking brake or recycle the ignition.

NOTICE

Driving with the parking brake on can cause your rear brakes to overheat. You may have to replace them, and you could also damage other parts of your vehicle.

If You are on a Hill:

See the *Index* under *Parking on Hills*. That section shows how to turn your front wheels.

If You are Towing a Trailer and are Parking on Any Hill:

See the *Index* under *Towing a Trailer*. That section shows what to do first to keep the trailer from moving.

Features & Controls



■ *Shifting Into P (Park)*

CAUTION



It can be dangerous to get out of your vehicle if the shift lever is not fully in **P (Park)** with the parking brake firmly set. Your vehicle can roll. If you have left the engine running, the vehicle can move suddenly. You or others could be injured. To be sure your vehicle won't move, when you're on fairly level ground, use the steps that follow. If you are parking on a hill, or if you're pulling a trailer, also see the *Index* under *Parking on Hills* or *Towing a Trailer*.

Steering Column Shift Lever

1. Hold the brake pedal down with your right foot and set the parking brake.

2. Move the shift lever into the **P (Park)** position as follows:

- Pull the lever toward you.



- Move the lever up as far as it will go.
3. Move the ignition key to **Lock**.
 4. Remove the key and take it with you. If you can walk away from your vehicle with the ignition key in your hand, your vehicle is in **P** (Park).

Console Shift Lever

1. Hold the brake pedal down with your right foot and set the parking brake.



2. Move the shift lever into **P** (Park) position like this:
 - Hold in the button on the lever.
 - Push the lever all the way toward the front of your vehicle.
3. Move the ignition key to **Lock**.
4. Remove the key and take it with you. If you can walk away from your vehicle with the ignition key in your hand, your vehicle is in **P** (Park).

Features & Controls

Leaving Your Vehicle With the Engine Running

CAUTION



It is dangerous to leave your vehicle with the engine running. Your vehicle could move suddenly if the shift lever is not fully in **P** (Park) with the parking brake firmly set. And, if you leave the vehicle with the engine running, it could overheat and even catch fire. You or others could be injured. Don't leave your vehicle with the engine running unless you have to.

If you have to leave your vehicle with the engine running, be sure your vehicle is in **P** (Park) and your parking brake is firmly set before you leave it. After you've moved the shift lever into the **P** (Park) position, hold the regular brake pedal down. Then, see if you can move the shift lever away from **P** (Park) without first pulling it toward you (or, if you have the console shift lever, without first pushing the button).

If you can, it means that the shift lever wasn't fully locked into **P** (Park).

Shifting Out of **P** (Park)

Your Pontiac has a brake-transaxle shift interlock. You have to fully **apply** your regular brakes **before** you can shift from **P** (Park) when the ignition is in the **On** position. See the *Index* under *Shifting the Automatic Transaxle*.

If you cannot shift out of **P** (Park), ease pressure on the shift lever—push the shift lever all the way into **P** (Park) and also release the shift lever button on floor shift console models as you maintain brake application. Then move the shift lever into the gear you wish. (Press the shift lever button before moving the shift lever on floor shift console models.) If you ever hold the brake pedal down but still can't shift out of **P** (Park), try this:

1. Turn the key to **Off**. Open and close the driver's door to turn off the Retained Accessory Power feature.
2. Apply and hold the brake until the end of Step 4.
3. Shift to **N** (Neutral).
4. Start the vehicle and then shift to the drive gear you want.
5. Have the vehicle fixed as soon as you can.



Parking Over Things That Burn

CAUTION

 Things that can burn could touch hot exhaust parts under your vehicle and ignite. Don't park over papers, leaves, dry grass or other things that can burn.

Engine Exhaust

CAUTION

 Engine exhaust can kill. It contains the gas carbon monoxide (CO), which you can't see or smell. It can cause unconsciousness and death.

You might have exhaust coming in if:

- Your exhaust system sounds strange or different.
- Your vehicle gets rusty underneath.
- Your vehicle was damaged in a collision.
- Your vehicle was damaged when driving over high points on the road or over road debris.
- Repairs weren't done correctly.
- Your vehicle or exhaust system has been modified improperly.

If you **ever** suspect exhaust is coming into your vehicle:

- Drive it only with all the windows down to blow out any CO; and
- Have it fixed **immediately**.

Features & Controls

Running Your Engine While You're Parked

It's better not to park with the engine running. But if you ever have to, here are some things to know.

CAUTION



Idling the engine with the air system control **OFF** could allow dangerous exhaust into your vehicle (see the earlier CAUTION under *Engine Exhaust*).

Also, idling in a closed-in place can let deadly carbon monoxide (CO) into your vehicle even if the fan switch is at the highest setting. One place this can happen is a garage. Exhaust—with CO—can come in easily. **Never** park in a garage with the engine running.

Another closed-in place can be a blizzard. (See the *Index* under *Blizzard*.)

It can be dangerous to get out of your vehicle if the shift lever is not fully in **P** (Park) with the parking brake firmly set. Your vehicle can roll. Don't leave your vehicle when the engine is running unless you have to. If you've left the engine running, the vehicle can move suddenly. You or others could be injured. To be sure your vehicle won't move, even when you're on fairly level ground, always set your parking brake and move the shift lever to **P** (Park).

If you are parking on a hill, or if you're pulling a trailer, also see the *Index* under *Parking on Hills* or *Towing a Trailer*.

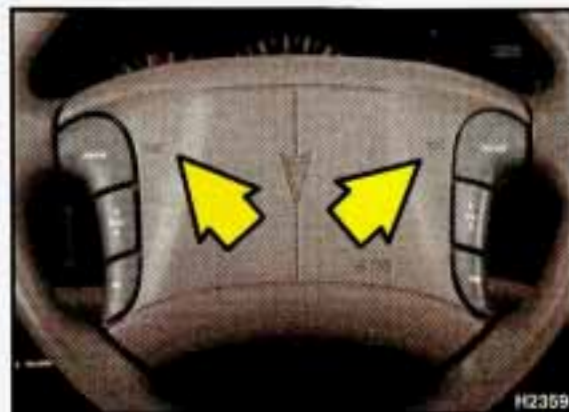

Horn

You can sound the horn by pressing the horn symbols on your steering wheel.

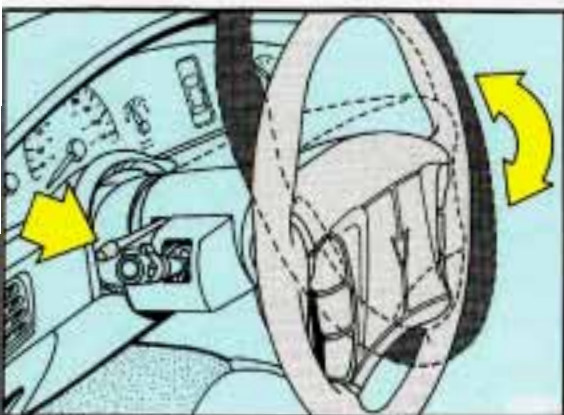

Tilt Steering Wheel

A tilt steering wheel allows you to adjust the steering wheel before you drive. You can also raise it to the highest level to give your legs more room when you exit and enter the vehicle.

To tilt the wheel, hold the steering wheel and pull the lever. Move the steering wheel to a comfortable level, then release the lever to lock the wheel in place.



Power Windows

Switches on the driver's armrest control each of the windows when the ignition is on. In addition, each passenger door has a control switch for its own window.

When the driver's window switch is held rearward for more than a half second, the window will lower completely. The window can be opened in smaller amounts by pressing the switch rearward and releasing it immediately.

To stop the window while it is lowering, press the switch again, then release. To raise the window, hold the switch forward.



■ *Turn Signal/Headlight Beam Lever*

The lever on the left side of the steering column includes your:

- Headlight High-Low Beam
- Headlight Washers (SSE and SSEi only)
- Windshield Wipers
- Windshield Washer
- Cruise Control (Option)
- Turn Signal and Lane Change Indicator

The High-Low Beam feature is discussed under *Headlights*. See the *Index* under *Headlights*.

Features & Controls

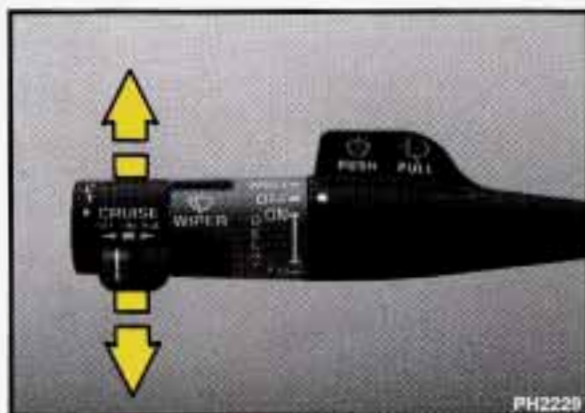

Turn Signal and Lane Change Indicator

The turn signal has two upward (for Right) and two downward (for Left) positions. These positions allow you to signal a turn or a lane change.

To signal a turn, move the lever all the way up or down. When the turn is finished, the lever will return automatically.

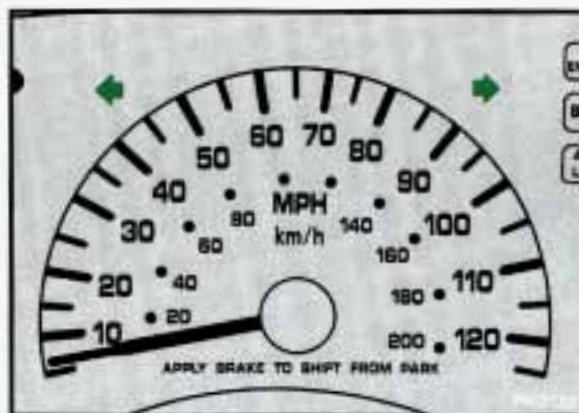

A green arrow on the instrument panel will flash in the direction of the turn or lane change.

To signal a lane change, just raise or lower the lever until the green arrow starts to flash. Hold it there until you complete your lane change. The lever will return by itself when you release it.

As you signal a turn or a lane change, if the arrows don't flash but just stay on, a signal bulb may be burned out and other drivers won't see your turn signal. If you have the Driver Information Center, it will tell you if you have a burned out bulb. See the *Index* under *Driver Information Center*.

If a bulb is burned out, replace it to help avoid an accident. If the green arrows don't go on at all when you signal a turn, check the fuse (see the *Index* under *Fuses & Circuit Breakers*) and for burned-out bulbs.

If you have a trailer towing option with added wiring for the trailer lights, a different turn signal flasher is used. With this flasher installed, the signal indicator will flash even if a turn signal bulb is burned out. Check the front and rear turn signal lights regularly to make sure they are working.

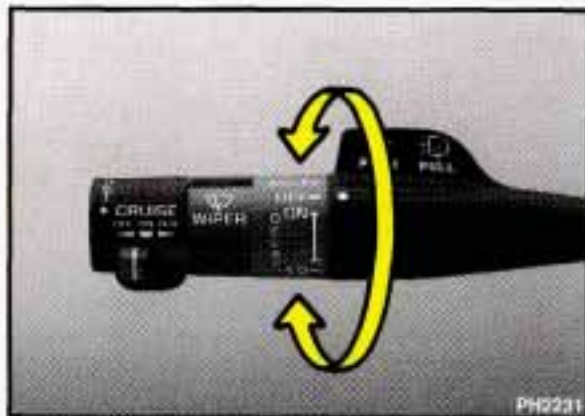
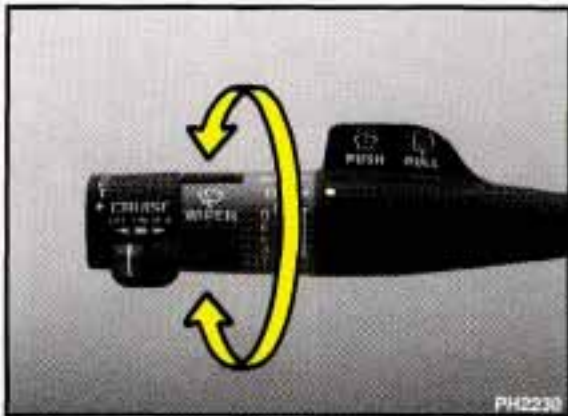

Windshield Wipers

You control the windshield wipers by turning the band marked **WIPER**.

For a single wiping cycle, turn the band to **MIST**. Hold it there until the wipers start, then let go. The wipers will stop after one cycle. If you want more cycles, hold the band on **MIST** longer.

For steady wiping at low speed, turn the band away from you to the **LO** position. For high speed wiping, turn the band further, to **HI**. To stop the wipers, move the band to **OFF**.

You can set the wiper speed for a long or short delay between wipes. This can be very useful in light rain or snow. Turn the band to choose the delay time. The closer to **LO**, the shorter the delay.

CAUTION



Damaged wiper blades may prevent you from seeing well enough to drive safely. To avoid damage, be sure to clear ice and snow from the wiper blades before using them. If they're frozen to the windshield, carefully loosen or thaw them. If your blades do become damaged, get new blades or blade inserts.

Heavy snow or ice can overload your wipers. A circuit breaker will stop them until the motor cools. Clear away snow or ice to prevent an overload.

Features & Controls

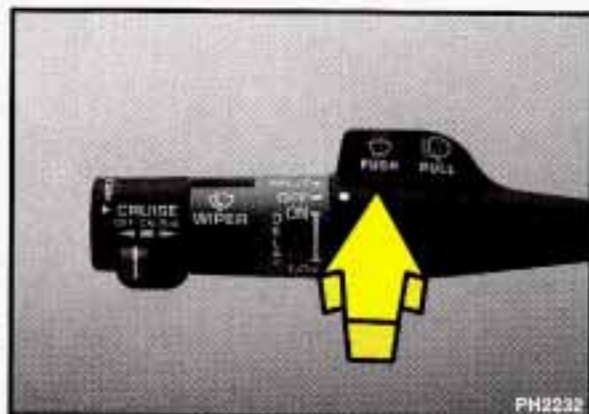

Windshield Washer

At the top of the turn signal/high beam lever there's a paddle with the word **PUSH** on it. To spray washer fluid on the windshield, push the paddle for less than a second. The wipers will clear the window and then either stop or return to your preset speed. For more washer cycles, push and hold the paddle.

Some models have a **WASHER FLUID** warning, that indicates if the fluid level in the windshield washer is low. See the *Index* under *Low Washer Fluid Warning Light*.

CAUTION



- Driving without washer fluid can be dangerous. A bad mud splash can block your vision. You could hit another vehicle or go off the road. Check your washer fluid level often.
- In freezing weather, don't use your washer until the windshield is warmed. Otherwise the washer fluid can form ice on the windshield, blocking your vision.

NOTICE

- When using concentrated washer fluid, follow the manufacturer's instructions for adding water.
- Don't mix water with ready-to-use washer fluid. Water can cause the solution to freeze and damage your washer fluid tank and other parts of the washer system. Also, water doesn't clean as well as washer fluid.
- Fill your washer fluid tank only $\frac{3}{4}$ full when it's very cold. This allows for expansion, which could damage the tank if it is completely full.
- Don't use radiator antifreeze in your windshield washer. It can damage your washer system and paint.



Headlight Washers (OPTION)

If you have this option, you can wash your headlights in bad weather or whenever desired. Here's how:

To operate the headlight washers, the ignition must be on. Pull the paddle on the turn signal/headlight beam lever labeled **PULL**. Each headlight will get a spray of washer fluid.



■ **Cruise Control (OPTION)**

With cruise control, you can maintain a speed of about 25 mph (40 km/h) or more without keeping your foot on the accelerator. This can really help on long trips.

Cruise control does not work at speeds below about 25 mph (40 km/h).

When you apply your brakes, the cruise control shuts off.

CAUTION



- Cruise control can be dangerous where you can't drive safely at a steady speed. So, don't use your cruise control on winding roads or in heavy traffic.
- Cruise control can be dangerous on slippery roads. On such roads, fast changes in tire traction can cause needless wheel spinning, and you could lose control. Don't use cruise control on slippery roads.

Features & Controls

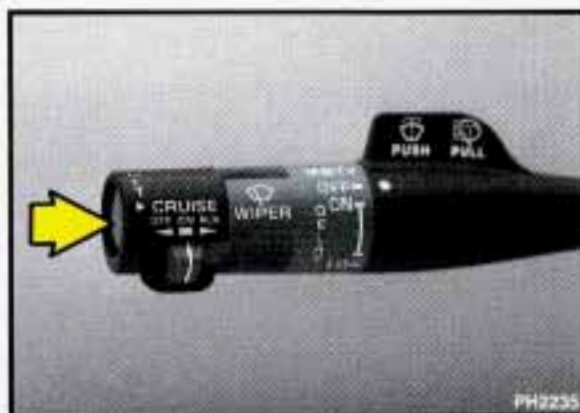

To Set Cruise Control

1. Move the cruise control switch to ON.

CAUTION



If you leave your cruise control switch ON when you're not using cruise, you might hit a button and go into cruise when you don't want to. You could be startled and even lose control. Keep the cruise control switch OFF until you want to use it.

2. Get up to the speed you want.

3. Push in the SET button at the end of the lever and release it.
4. Take your foot off the accelerator pedal.

To Resume a Set Speed

Suppose you set your cruise control at a desired speed and then you apply the brake. This, of course, shuts off the cruise control. But you don't need to reset it. Once you're going about 25 mph (40 km/h) or more, you can move the cruise control switch from ON to R/A (which stands for Resume/Accelerate) for about half a second. You'll go right back up to your chosen speed and stay there.

CAUTION



If you hold the switch at **R/A** longer than half a second, the vehicle will keep going faster until you release the switch or apply the brake. You could be startled and even lose control. So unless you want to go faster, don't hold the switch at **R/A**.

To Increase Speed While Using Cruise Control

There are two ways to go to a higher speed. Here's the first:

1. Use the accelerator pedal to get to the higher speed.
2. Push the button at the end of the lever, then release the button and the accelerator pedal. You'll now cruise at the higher speed.

Here's the second way to go to a higher speed:

- Move the cruise switch from **ON** to **R/A**. Hold it there until you get up to the speed you want, and then release the switch.
- To increase your speed in very small amounts, move the switch to **R/A** for less than half a second and then release it. Each time you do this, your vehicle will go about 1 mph (1.6 km/h) faster.

The accelerate feature will only work after you turn on the cruise control by pushing the **SET** button.

Features & Controls

To Reduce Speed While Using Cruise Control

There are two ways to reduce your speed while using cruise control:

- Push in the button at the end of the lever until you reach the lower speed you want, then release it.
- To slow down in very small amounts, push the button for less than half a second. Each time you do this, you'll go 1 mph (1.6 km/h) slower.

Passing Another Vehicle While Using Cruise Control

Use the accelerator pedal to increase your speed. When you take your foot off the pedal, your vehicle will slow down to the cruise control speed you set earlier.

Using Cruise Control on Hills

How well your cruise control will work on hills depends upon your speed, load, and the steepness of the hills. When going up steep hills, you may have to step on the accelerator pedal to maintain your speed. When going downhill, you may have to brake or shift to a lower gear to keep your speed down. Of course, applying the brake takes you out of cruise control. Many drivers find this to be too much trouble and don't use cruise control on steep hills.

To Get Out of Cruise Control

There are two ways to turn off the cruise control:

- Step lightly on the brake pedal; OR
- Move the cruise switch to **OFF**.
- When the Traction Control System is turned on, it will turn off the cruise control. See the *Index* under *Traction Control*.

To Erase Cruise Speed Memory

When you turn off the cruise control or the ignition, or shift into **P** (Park), your cruise control set speed memory is erased.



H2361

Light Controls

Parking Lights:

Pull the switch to the first stop to turn on:

- Parking Lights
- Side Marker Lights
- Taillights
- Instrument Panel Lights

Headlights:

Pull the switch out all the way to turn on the headlights, together with:

- Parking Lights
- Side Marker Lights
- Taillights
- Instrument Panel Lights

Push the switch in all the way to turn all the lights off.

Features & Controls

Operation of Lights

Although your vehicle's lighting system (headlamps, parking lamps, fog lamps, side marker lamps and tail lamps) meets all applicable federal lighting requirements, certain states and provinces may apply their own lighting regulations that may require special attention before you operate these lamps. For example, some jurisdictions may require that you operate your lower beam lamps with fog lamps at all times,

or that headlamps be turned on whenever you must use your windshield wipers. In addition, most jurisdictions prohibit driving solely with parking lamps, especially at dawn or dusk. It is recommended that you check with your own state or provincial highway authority for applicable lighting regulations.

Lights On Reminder

If you open the door while leaving the lights on, you will hear a warning tone.

Daytime Running Lights **(CANADA ONLY)**

The Canadian federal government has decided that Daytime Running Lights (DRL) are a useful feature, in that DRL can make your vehicle more visible to pedestrians and other drivers during daylight hours. DRL are required on new vehicles sold in Canada.

Your DRL work with a light sensor on top of the instrument panel. Don't cover it up. The low beam headlights will come on at reduced brightness in daylight when:

- The ignition is on
- The headlight switch is off, and
- The transaxle is not in **P** (Park).

At dusk, the exterior lights will come on automatically and the low beams will change to full brightness. At dawn, the exterior lights will go out and the low beams will change to the reduced brightness of DRL (if the headlight switch is off).

Of course, you may still turn on the headlights any time you need to.

To idle your vehicle with the DRL off, shift the transaxle into **P** (Park). The DRL will stay off until you shift out of **P** (Park).

At night, you can turn off all exterior lights when you are in **P** (Park) by moving the Twilight Sentinel control all the way past **MIN** to turn it off, if it was on. If it was off, move the control to the right to turn it on, then back off. The lights will come back on when you put the transaxle in gear.



Headlight High-Low Beam Changer

To change the headlights from low beam to high, or high to low, pull the turn signal lever all the way toward you. Then release it.

When the high beams are on, a blue light on the instrument panel also will be on.

Features & Controls



Instrument Panel Intensity Control

You can brighten or dim your instrument cluster lights by rotating the headlight switch. Rotate the switch all the way counterclockwise to turn on the interior courtesy lights. Rotate the switch clockwise to turn off the instrument cluster lights and displays.



Twilight Sentinel (OPTION)

If You Have this Option, Here's How it Works:

1. Push in the headlight switch to turn your headlights off.
2. Rotate the Twilight Sentinel switch counterclockwise from **OFF**.

The Twilight Sentinel Does Two Things:

First, depending on how dark it becomes outside, the Twilight Sentinel turns your headlights on automatically, when they're needed. Avoid covering the sensor located near the windshield, by the defroster outlet—otherwise your headlights will stay on.

Also, it's possible that your headlights might go out if you drove from a dark area into a bright area, such as a lighted parking lot. If this happens, turn on your headlights with the regular headlight switch.



Fog Lights

The switch for your fog lights is in the overhead console.

An indicator light in the switch will glow when the fog lights are switched on. Your headlights must be on low beams, or your parking lights must be on, for your fog lights to work.



Front Reading Lights

These lights and the interior courtesy lights will come on when you open the doors.

To turn on a reading light when the doors are closed, press either switch. Press it again to turn the light off.

To avoid draining your vehicle's battery, be sure to turn off the reading lights when leaving your vehicle.

Second, to light your way when you leave your vehicle, the Twilight Sentinel will keep your headlights on for as long as three minutes. Rotate the Twilight Sentinel switch to **MAX** for a three-minute delay. Rotate it the other way to reduce the delay.

Features & Controls



Rear Reading Lights

These overhead lights and the interior courtesy lights will come on when you open the doors.

To turn on the reading light when the door is closed, slide the switch up. Slide it down to turn off the light.



Inside Manual Day/Night Rearview Mirror

To reduce glare from lights behind you, pull the lever toward you to the night position.

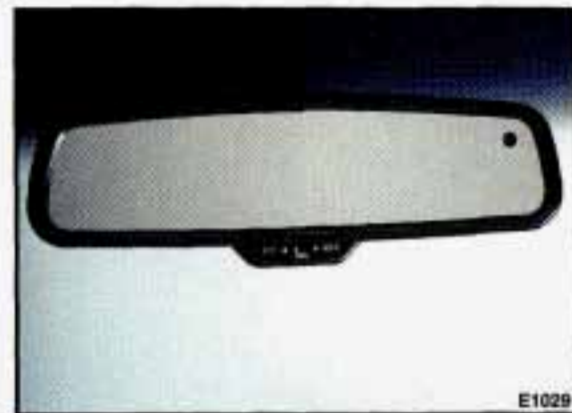

Electrochromic Day/Night Rearview Mirror

This mirror automatically changes to reduce glare when set in the **MIN** or **MAX** positions. One photocell on the back of the mirror senses when it is becoming dark outside. Another photocell is built into the mirror surface to sense headlights behind you.

The mirror will darken gradually to reduce glare. This change may take a few moments.



E1030



PH2150

Convex Outside Mirror

Your right side mirror is convex. A convex mirror's surface is curved so you can see more from the driver's seat.

CAUTION

 If you aren't used to a convex mirror, you can hit another vehicle. A convex mirror can make things (like other vehicles) look farther away than they really are. If you cut too sharply into the right lane, you could hit a vehicle on your right. Check your inside mirror or glance over your shoulder before changing lanes.

Setting the Sensitivity:

MIN: The mirror will gradually reduce glare when headlights behind you are very close. This is a good position for city driving, where there may be light from many sources.

MAX: The mirror will begin to gradually reduce glare when headlights are far behind you. This is a good setting for rural driving.

The mirror goes to a clear position whenever you shift to **R** (Reverse).

OFF: Shuts off the Day/Night function. The mirror will stay in the Day setting.

To keep the photocells operating well, occasionally clean them with a cotton swab and glass cleaner.

Manual Remote Control Mirror

The outside rearview mirror should be adjusted so you can just see the side of your vehicle when you are sitting in a comfortable driving position.

Adjust the driver side outside mirror with the control lever on the driver's door.

To adjust your passenger side mirror, sit in the driver's seat and have a passenger adjust the mirror for you.

Features & Controls

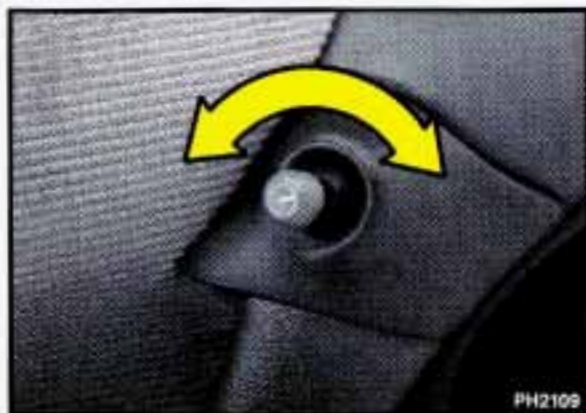

Power Remote Control Mirrors *(OPTION)*

A control lever on the driver's door controls both outside rearview mirrors. Select the mirror you want to adjust by rotating the lever to the left or right. Adjust each mirror so that you can just see the side of your vehicle when you are sitting in a comfortable driving position.

When you operate the optional rear window defogger, the outside rearview mirrors are also heated to help clear them of ice and snow.



Sun Visors

To block out glare, you can swing down the visors. You can also remove them from the center mount and swing them to the side, while the auxiliary sunshade remains to block glare from the front.



Visor Vanity Mirrors

Standard Mirror:

Open the cover to expose the vanity mirror.

Lighted Mirrors:

If your vehicle has the optional lighted vanity mirrors, the lights come on when you open the cover. These can even be used for reading. You can adjust the brightness of the lights with the switch.

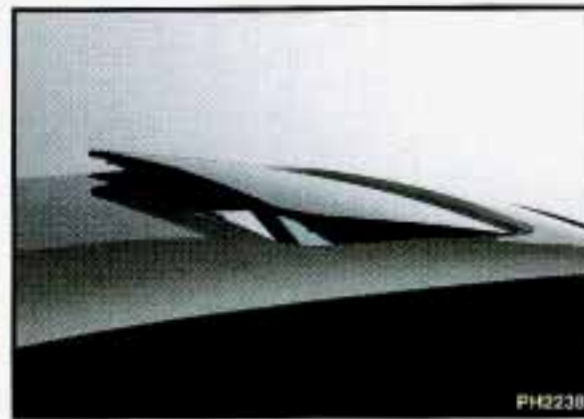
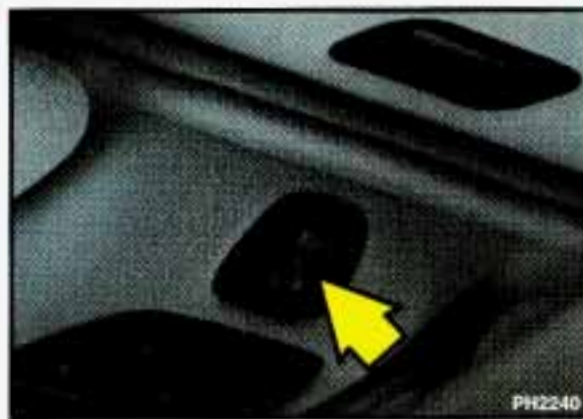

Express Open Sunroof (OPTION)

Your express open sunroof provides an airy, spacious feel to your vehicle's interior and can also increase ventilation. It includes a sliding glass panel and a sliding sunshade. The control switch will work only when the ignition is on, or during Retained Accessory Power, if you have that option. See the *Index* under *Retained Accessory Power*.

To Open the Sunroof:

Press the control switch rearward and release it to open the glass panel and sunshade. If you want to stop the sunroof in a partially open position, lightly press the switch again. Press the switch rearward again to open fully. The sunshade can also be opened by hand.

To Close the Sunroof:

Press and hold the control switch forward to close the glass panel. The sunshade can only be closed by hand.

The sunroof glass panel cannot be opened or closed if your vehicle has an electrical failure.

To Open the Sunroof Rear Vent:

Press the control switch forward when the sunroof is closed. Open the sunshade by hand.

To Close the Sunroof Rear Vent:

Press the switch rearward.

Features & Controls



Storage Armrest (OPTION)

Console Shift Models:

Press the button at the front edge to open the armrest storage area for cassette tapes, gloves, etc. A cup holder flips forward for use.

There's also a bin for storage underneath the armrest storage area.



Column Shift Models:

The front armrest opens into a storage area for cassette tapes, gloves, etc. To open it, hold down the base and lift the lid. A cup holder flips forward and unfolds to hold two cups.



Door Cup Holder

The front doors provide space for holding a cup or soft drink.



Rear Storage Compartment

Lift the rear of the armrest to reveal the storage space.



Pull down the interior door to access the trunk for storing long objects.



Ashtrays

Lift the cover to reveal the front ashtray. To clean the ashtray, lift it out by pulling on the snuffer.

Features & Controls



Ashtrays (CONT.)

On models without a console, there's an ashtray/cup holder under the instrument panel. To clean the ashtray, lift it out by pulling up on the tabs on either side. It snaps back into place.



To open the rear ashtrays, lift the cover.

NOTICE

Don't put papers and other things that burn into your ashtrays. If you do, cigarettes or other smoking materials could set them on fire, causing damage.



Lighters

To use a lighter, just push it in all the way and let go. When it's ready, it will pop back by itself.



NOTICE

Don't hold a cigarette lighter in with your hand while it is heating. If you do, it won't be able to back away from the heating element when it's ready. That can make it overheat, damaging the lighter and the heating element.



Sunglasses Storage

With the overhead console, you have a storage door for sunglasses. Press the rear edge of the storage door to release it. Place your sunglasses inside the door. To close the door, raise it and press it into position.

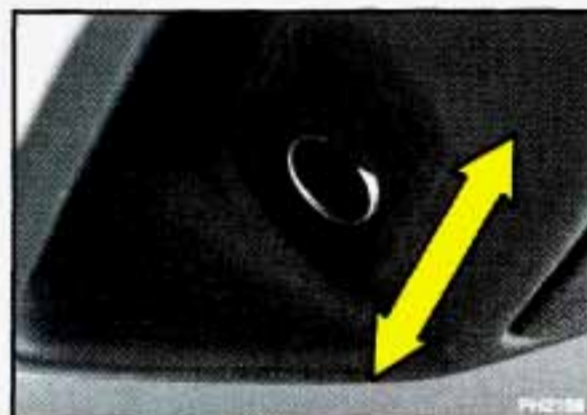

Accessory Outlet

On models with the overhead console, there is a 12-volt outlet. Slide the cover aside to access the outlet.

NOTICE

Adding some electrical equipment to your vehicle can damage it or keep other things from working as they should. This wouldn't be covered by your warranty. Check with your dealer before adding electrical equipment, and never use anything requiring more than 20 amps.

Features & Controls

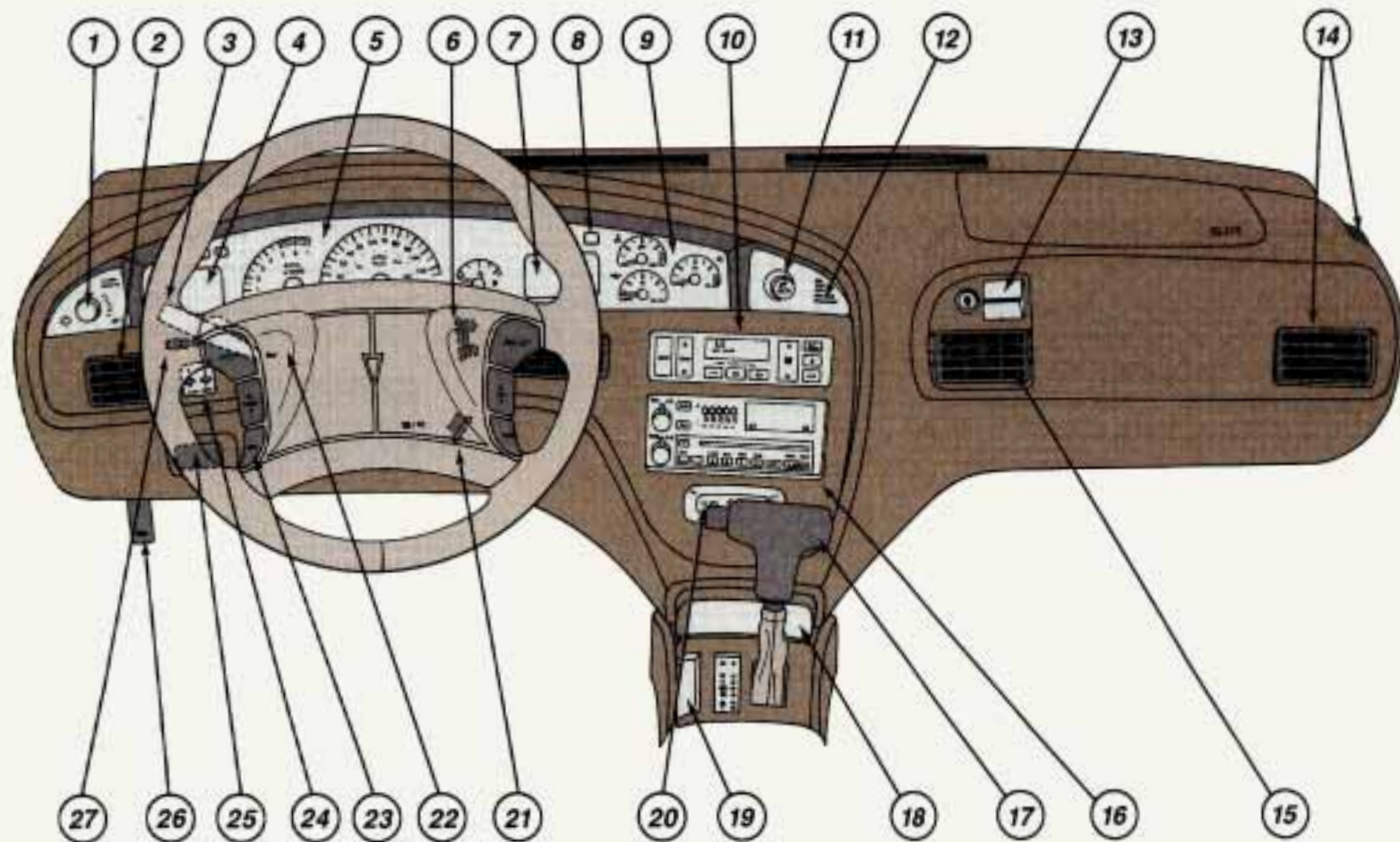

H2378

The Instrument Panel— Your Information System

Your instrument panel is designed to let you know at a glance how your vehicle is running. You'll know how fast you're going, how much fuel you're using, and many other things you'll need to drive safely and economically.

The main components of your instrument panel are:

- 1. Light Controls/Twilight Sentinel (Option)**
- 2. Side Vent**
- 3. Turn Signal/Headlight Beam Lever**
- 4. Electronic Compass (Option)**
- 5. Instrument Cluster**
- 6. Ignition Switch**
- 7. Driver Information Center (Option)**
- 8. Trip Odometer Reset**
- 9. Gage Cluster**
- 10. Climate Controls/Rear Window Defogger**
- 11. Lighter**
- 12. Temperature Sensor**
- 13. Glove Box**
- 14. Side Vents**
- 15. Center Vent**
- 16. Audio System**
- 17. Gear Shift Lever**
- 18. Ashtray**
- 19. Console Switch Bank (Option)**
- 20. Gain Control (Option)**
- 21. Hazard Warning Flashers Switch**
- 22. Horn**
- 23. Steering Wheel Audio Controls (Option)**
- 24. Head-Up Display Control (Option)**
- 25. Parking Brake Release**
- 26. Hood Release**
- 27. Tilt Wheel Lever**

Features & Controls

Instrument Panel Clusters

Your Pontiac is equipped with one of these instrument panel clusters, which includes indicator warning lights and gages that are explained on the following pages. Be sure to read about those that apply to the instrument panel cluster for your vehicle.

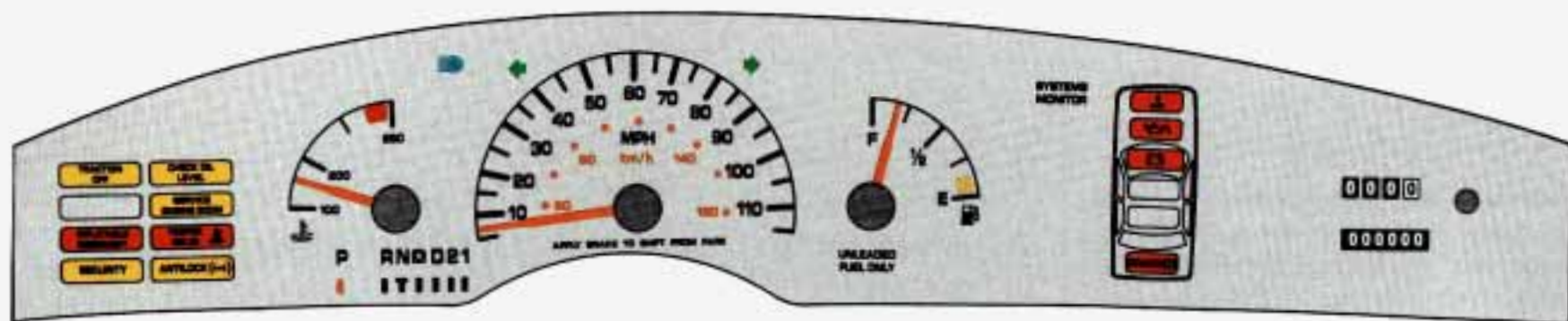

H2303

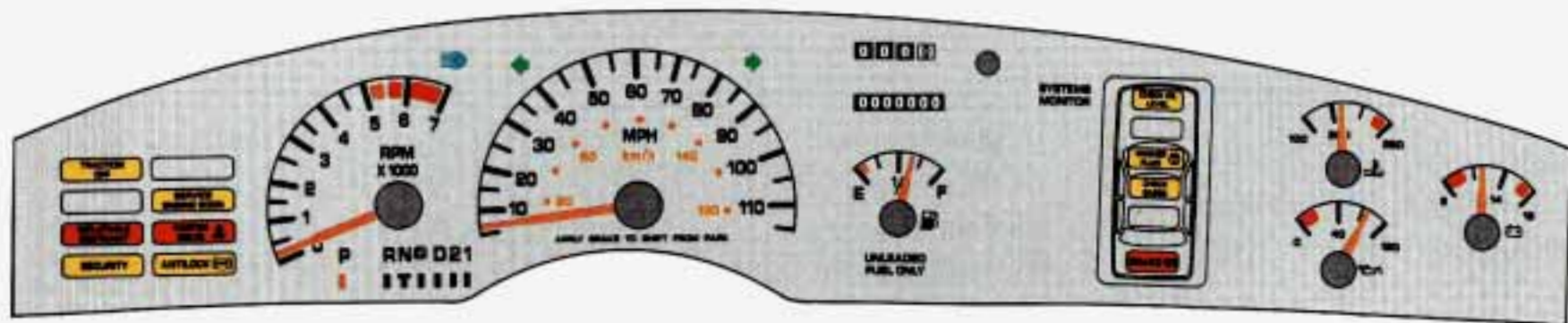



H2305



H 2312

Features & Controls

Speedometer and Odometer

Your speedometer lets you see your speed in both miles per hour (mph) and kilometers per hour (km/h). The odometer shows how far your vehicle has been driven, in either miles (used in the U.S.) or kilometers (used in Canada).

The odometer and trip odometer are displayed in the Driver Information Center on vehicles so equipped.

Tamper Resistant Odometer

Your Pontiac has a tamper resistant odometer. If you see silver lines between the numbers, you'll know that someone has probably tried to turn it back, so the numbers may not be true.

You may wonder what happens if your vehicle needs a new odometer installed. If the new one can be set to the mileage total of the old odometer, then it must be. But if it can't, then it's set at zero and a label must be put on the driver's door to show the old mileage reading when the new odometer was installed.



Trip Odometer

The trip odometer can tell you how far you have driven since you last reset it. To set it to zero:

- On vehicles with the Driver Information Center, press the button labeled **TRIP**.
- On vehicles with the Systems Monitor, the button is next to the trip odometer. Push and release in a smooth, continuous motion until all zeroes appear.

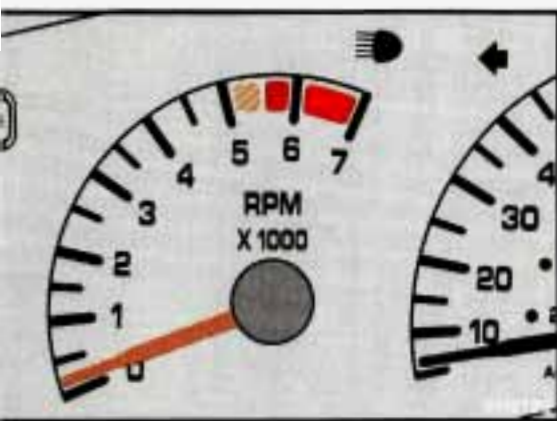

Tachometer (OPTION)

The tachometer shows your engine speed in revolutions per minute (rpm). Do not run your engine at speeds in the red area.

■ **Warning Lights, Gages and Indicators**

This section describes the warning lights and gages that may be on your vehicle. The pictures will help you locate them.

Warning lights and gages can signal that something is wrong before it becomes serious enough to cause an expensive repair or replacement. Paying attention to your warning lights and gages could also save you or others from injury.

Warning lights go on when there may be or is a problem with one of your vehicle's functions. As you will see in the details on the next few pages, some warning lights come on briefly when you turn the ignition key just to let you know they're working. If you are familiar with this section, you should not be alarmed when this happens.

Gages can indicate when there may be or is a problem with one of your vehicle's functions. Often gages and warning lights work together to let you know when there's a problem with your vehicle.

When one of the warning lights comes on and stays on when you are driving, or when one of the gages shows there may be a problem, check the section that tells you what to do about it. Please follow the manual's advice. Waiting to do repairs can be costly—and even dangerous. So please get to know your warning lights and gages. They're a big help.

Your vehicle may also have a Driver Information Center that works along with the warning lights and gages. See the *Index* under *Driver Information Center*.

Features & Controls

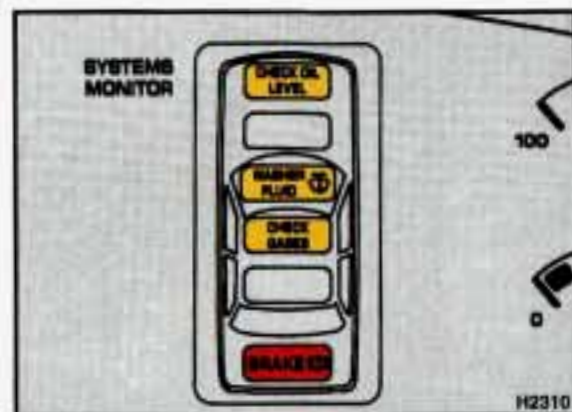
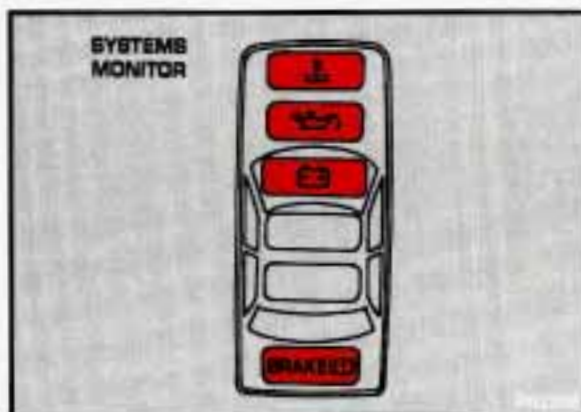

■ Warning Lights

Your Pontiac has some of the warning light systems shown here. The symbols are explained on the following pages.

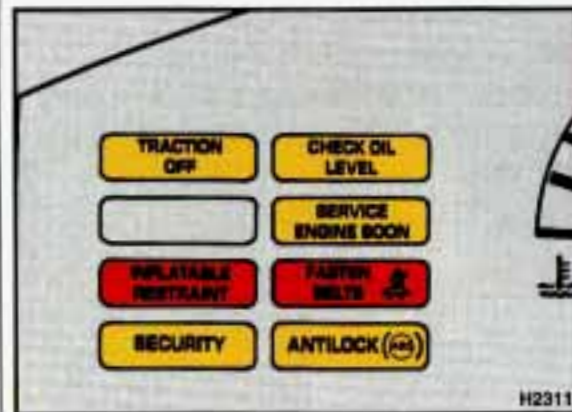
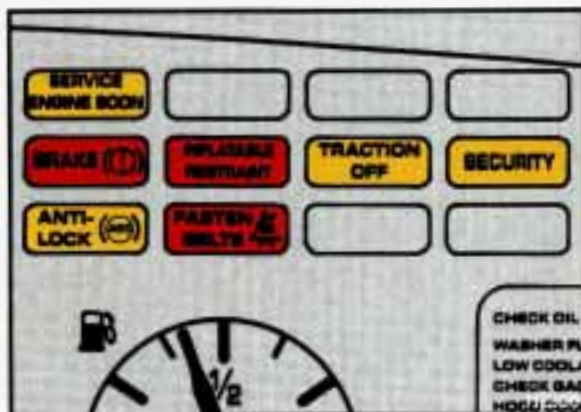

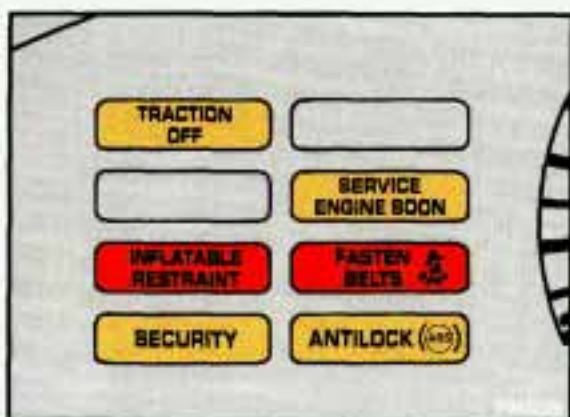
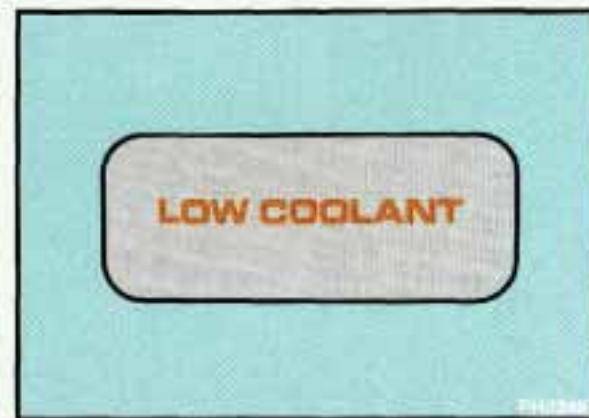
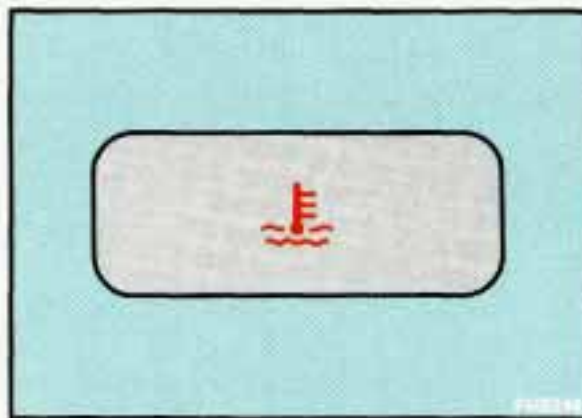

Engine Coolant Temperature Warning Light

This light tells you that your engine coolant has overheated or your radiator cooling fans are not working. If you have been operating your vehicle under normal driving conditions, you should pull off the road, stop your vehicle and turn the engine off as soon as possible.

HOT COOLANT CAN BURN YOU BADLY! In *Problems on the Road*, this manual shows what to do. See the *Index* under *Engine Overheating*.

Some clusters with gages do not have a coolant temperature warning light. In those clusters a **CHECK GAGES** warning light will alert you of a potential coolant heating problem.

Low Coolant Warning Light (OPTION)

If this light comes on, your system may be low on coolant and the engine may overheat. Check to see if the level is low, and add coolant if necessary. See the *Index* under *Engine Coolant*.

The **LOW COOLANT** warning light will also come on when you turn on the ignition, but your engine is not running, as a check to show you it is working. If it doesn't come on then, have it fixed right away.

Features & Controls

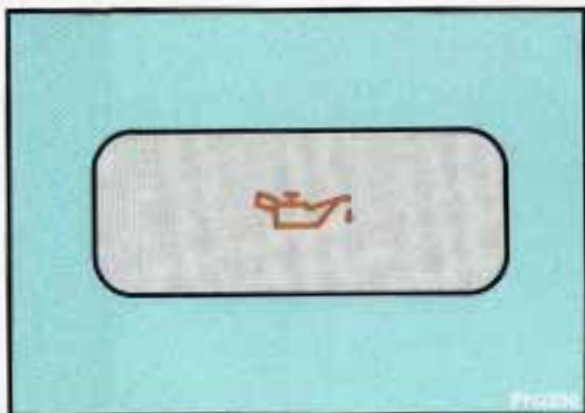

Oil Warning Light

If you have a problem with your oil, this light may stay on after you start your engine, or come on when you are driving. This indicates that oil is not going through your engine quickly enough to keep it cool. The engine could be low on oil, or could have some other oil problem. Have it fixed right away.

The oil light could also come on in two other situations:

- When the ignition is on but the engine is not running, the light will come on as a test to show you it is working, but the light will go out when you turn the ignition to **Start**. If it doesn't come on with the ignition on, you may have a problem with the fuse or bulb. Have it fixed right away.
- If you make a hard stop, the light may come on for a moment. This is normal.

Clusters with gages use the **CHECK GAGES** warning light to alert you of a potential oil pressure problem.

CAUTION



Don't keep driving if the oil pressure is low. If you do, your engine can become so hot that it catches fire. You or others could be burned. Check your oil as soon as possible and have your vehicle serviced.

NOTICE

Damage to your engine from neglected oil problems can be costly and is not covered by your warranty.



Check Oil Level Warning Light (OPTION)

This light indicates when the engine oil level is 1 to 1½ quarts (0.95 L to 1.4 L) low. It will go on for one to three seconds when the ignition is turned to the Run position, as a bulb check. It will then go off. Even if you have a low oil level, it will go off for 15 to 20 seconds. Then, if the oil level is low, and it has been at least eight minutes since your engine was last running, the **CHECK OIL LEVEL** light will come on for 20 to 40 seconds. The eight-minute delay allows the majority of the oil to drain back into the oil pan and prevent a false low condition.

If the **CHECK OIL LEVEL** warning comes on, the oil level should be checked at the oil dipstick. If the level is low, the engine oil should be brought up to the proper level (see the *Index* under *Engine Oil*). After restoring the proper level and waiting for the eight-minute drainback, the key can be turned to the **Run** position and the **CHECK OIL LEVEL** warning light should only come on as a bulb check.

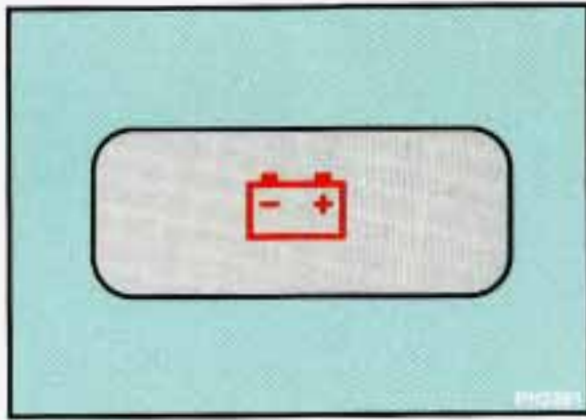

Battery Warning Light

This light will come on briefly when you start the vehicle, as a check to show you it is working, then it should go out. If it stays on, or comes on while you are driving, you may have a problem with the electrical charging system. It could indicate that you have a loose generator drive belt, or another electrical problem. Have it checked right away. Driving while this light is on could drain your battery.

If you must drive a short distance with the light on, be certain to turn off all

Features & Controls



Battery Warning Light (CONT.)

your accessories, such as the radio and climate control system.

Some clusters with gages do not have a battery warning light. They have a **CHECK GAGES** warning to indicate a problem. Vehicles with the supercharged engine also have a similar battery warning light.

Malfunction Indicator Lamp (Service Engine Soon Light)

A computer monitors operation of your fuel, ignition and emission controls systems. This light should come on when the ignition is on but the engine is not running, as a check to show you it is working. If it does not come on at all, have it fixed right away. If it stays on, or it comes on while you are driving, the computer is indicating that you have a problem. You should take your vehicle in for service soon.

NOTICE

If you keep driving your vehicle with this light on, after awhile the emission controls won't work as well, your fuel economy won't be as good, and your engine may not run as smoothly. This could lead to costly repairs not covered by your warranty.

A rectangular light with rounded corners, containing the text "WASHER FLUID" in orange capital letters.

Low Washer Fluid Warning Light (OPTION)

This light will come on when your windshield washers are working and the fluid container is less than one-third full.

CAUTION

 Driving without washer fluid can be dangerous. A bad mud splash can block your vision. You could collide with another vehicle. Check your washer fluid often, and add only the proper fluid. See the *Index* under *Windshield Washer Fluid*.

A rectangular light with rounded corners, containing the text "BRAKE" in red capital letters and a red exclamation mark inside a circle.

Brake System Warning Light

Your Pontiac's hydraulic brake system is divided into two parts. If one part isn't working, the other part can still work and stop you. For good braking, though, you need both parts working well. If the warning light goes on, there could be a brake problem. Have your brake system inspected right away.

This light should come on as you start the vehicle. If it doesn't come on then, have it fixed so it will be ready to warn you if there's a problem.

This light will also come on when you set your parking brake, and the light will stay on if your parking brake doesn't release fully. If you try to drive off with the parking brake set, a chime will also come on until you release the parking brake. If the light and chime stay on after your parking brake is fully released, it means you have a brake problem. If the light and chime come on while driving, pull off the road and stop carefully. You may notice that the pedal is harder to push. Or, the pedal may go closer to the floor. It may take longer to stop. If the light is still on, have the vehicle towed for service. (See the *Index* under *Towing Your Pontiac*.)

Features & Controls

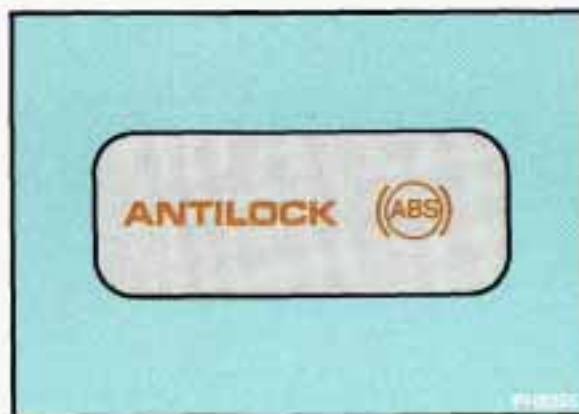

Brake System Warning Light (CONT.)

CAUTION



Your brake system may not be working properly if the brake warning light is on. Driving with the brake warning light on can lead to an accident. If the light is still on after you've pulled off the road and stopped carefully, have the vehicle towed for service.

Anti-Lock Brake System Warning Light

With anti-lock, this light will go on when you start your engine and may stay on for several seconds or so. That's normal. If the light doesn't come on, have it fixed so it will be ready to warn you if there is a problem.

If the light stays on or comes on when you're driving, stop as soon as possible and turn the key off. Then start the engine to reset the system. If the light still stays on, or if it comes on again while you're driving, your Pontiac needs service.

Unless the regular brake system warning light is also on, you will still have brakes, but not anti-lock brakes. If the regular

brake system warning light is also on, see the *Index* under *Brake System Warning Light*.

The anti-lock brake system warning light may also come on when you are driving with a compact spare tire. If this happens, the light means you won't have anti-lock until you replace the compact spare with a full-size tire. If the warning light stays on after you replace the compact spare with a full-size tire, or comes on again while you are driving, your Pontiac needs service.



TRACTION OFF

Traction Control System Warning Light (OPTION)

The **TRACTION OFF** warning light means that the system is not working. This warning light may come on for the following reasons:

- If your transaxle overheats, the traction control system automatically shuts off until the transaxle cools. The warning light will come on and stay on during that time.
- If your brakes overheat, the traction control system will go off and the warning light will come on until your brakes cool down. The warning light will come on for varying periods of time.

- If you turn the system off by pressing the switch on the center console while the vehicle is stopped, the warning light will come on and stay on. To turn the system back on, bring the vehicle to a stop and press the switch again. The warning light should go off. The system will also turn itself on if you turn your ignition off and back on again.

If the **TRACTION OFF** warning light comes on and stays on for an extended period of time, even when you've switched the system on, your vehicle needs service.

CAUTION



If you let your tires spin at high speed when the **TRACTION OFF** warning light is on, they can explode and you or others could be injured. And, spinning your tires with the **TRACTION OFF** warning light on can cause the transaxle to overheat or can cause other problems. That could cause an engine fire or other damage. When you're stuck, spin the wheels as little as possible. Don't spin the wheels above 35 mph (56 km/h) as shown on the speedometer.

Features & Controls

Traction Control System Warning Light (CONT.)

NOTICE

Spinning your wheels when the **TRACTION OFF** warning light is on can destroy parts of your vehicle as well as the tires. If you spin your wheels too fast while shifting your transaxle back and forth, you can destroy your transaxle. When you're stuck, spin the wheels as little as possible.

■ *Gages*

Your Pontiac may have many of the following gages. Be sure to read about the ones that came with your vehicle.

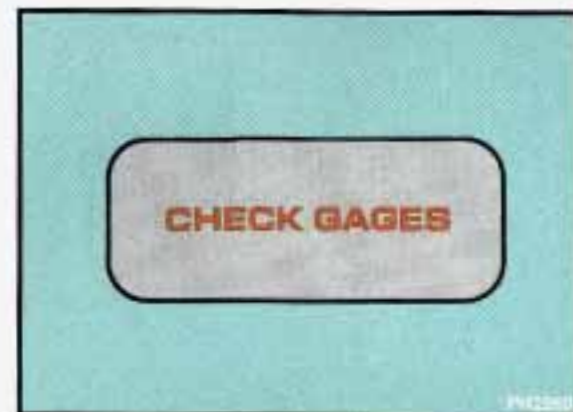

Check Gages Warning Light (OPTION)

This light will come on briefly when you are starting the engine. If the light comes on and stays on while you are driving, check your gages for fuel, coolant temperature, oil pressure or voltage. This light will stay on if your engine is not running.

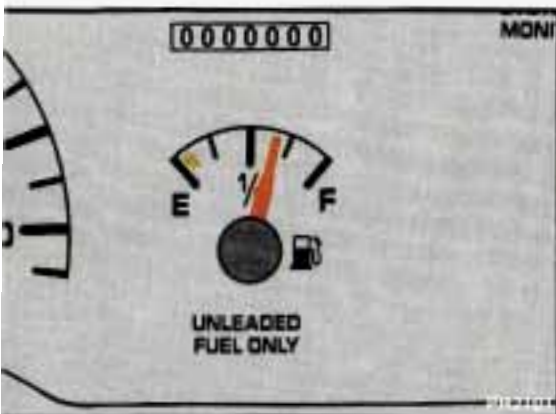

Fuel Gage

You will either have this fuel gage or one very similar. Your fuel gage tells you about how much fuel you have left, when the ignition is on. When the gage reads in the yellow band, a warning chime will sound and the **CHECK GAGES** warning light will go on, if you have it.

Here are five things that some owners ask about. None of these show a problem with your fuel gage:

- At the gas station, the gas pump shuts off before the gage reads **F** (Full).

- It takes a little more or less fuel to fill up than the gage indicated. For example, the gage may have indicated the tank was half full, but it actually took a little more or less than half the tank's capacity to fill the tank.
- The gage moves a little when you turn a corner or speed up.
- The gage doesn't go back to **E** (Empty) when you turn off the ignition.
- If you have the large span (220°) gage, the needle moves more for a given amount of fuel. This does not indicate excessive fuel consumption, and is normal.

For your fuel tank capacity, see *Service Station Information* on the last page of this manual.

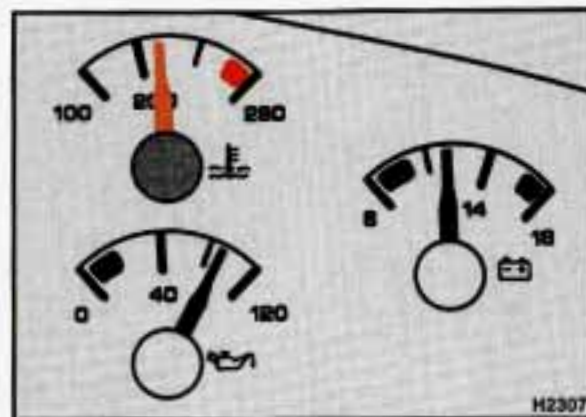

Engine Coolant Temperature Gage (OPTION)

A coolant temperature gage shows the engine coolant temperature.

If the gage pointer moves into the red warning area, your engine is too hot! The **CHECK GAGES** light will go on and a warning chime will sound, if you have this option. It means that your engine coolant has overheated. If you have been operating your vehicle under normal driving conditions, you should pull off the road, stop your vehicle and turn off the engine as soon as possible.

HOT COOLANT CAN BURN YOU BADLY! In *Problems on the Road*, this manual shows what to do. See the *Index* under *Engine Overheating*.

Features & Controls

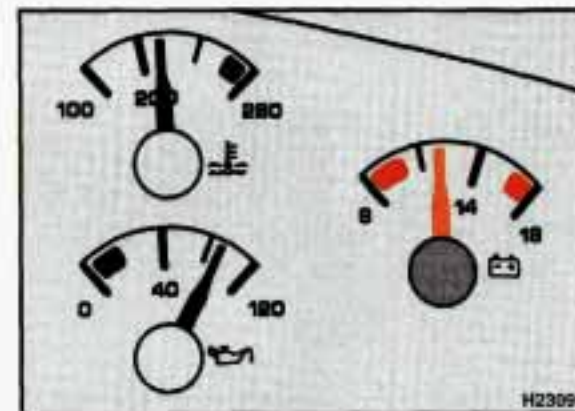
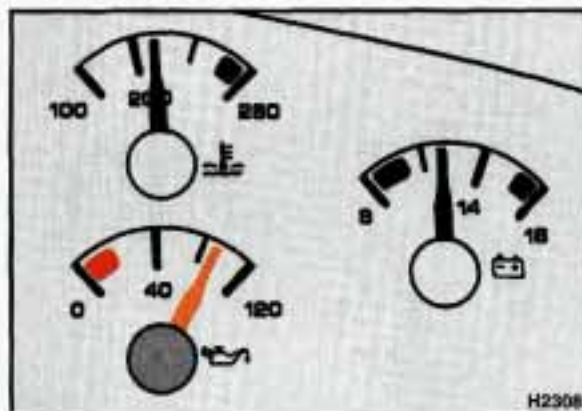

Oil Pressure Gage (OPTION)

The oil pressure gage shows the engine oil pressure in psi (pounds per square inch) when the engine is running. Canadian vehicles indicate pressure in kPa. Oil pressure may vary with engine speed, outside temperature and oil viscosity, but readings above the red warning zone indicate the normal operating range.

A reading in the red zone may be caused by a dangerously low oil level or other problem causing low oil pressure. The **CHECK GAGES** light will go on and a warning chime will sound, if you have this option.

Driving your vehicle with low oil pressure can cause extensive engine damage.

CAUTION



Don't keep driving if the oil pressure is low. If you do, your engine can become so hot that it catches fire. You or others could be burned. Check your oil as soon as possible and have your vehicle serviced.

NOTICE

Damage to your engine from neglected oil problems can be costly and is not covered by your warranty.

Voltmeter (OPTION)

Unless you have the supercharged engine, you may have a voltmeter.

When the engine is running, the gage shows the condition of the charging system. Readings outside the red warning zone indicate the normal operating range.

Readings in the red warning zone indicate a possible problem in the electrical system. The **CHECK GAGES** light will also come on, and a warning chime will sound. Have your vehicle serviced immediately.

When your engine is not running, but the ignition is on (in the **Run** position), the gage shows your battery's state of charge in DC volts.

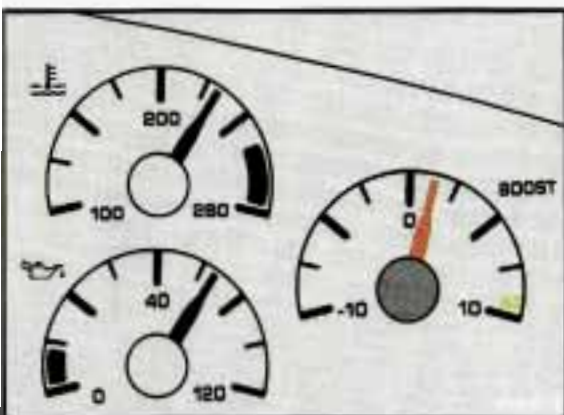

Boost Gage (OPTION)

Vehicles equipped with the supercharged engine have this boost gage that indicates vacuum during light to moderate throttle and boost under heavier throttle. The gage displays the air pressure level in psi going into the engine's combustion chamber.

The gage is automatically centered at zero psi every time the engine is started. Actual vacuum or boost is displayed from this zero point. Changes in ambient pressure, such as driving in mountains and changing weather, will slightly change the zero reading.



■ **Driver Information Center**

If you have the Driver Information Center, it gives you important safety and maintenance facts. When you turn the ignition on, the entire Center lights up for a few seconds. Then it goes to work.

FUNCTION MONITOR: This lets you know if you are low on fluids or have a problem with a vehicle function:

- **CHECK OIL LEVEL:** This message could mean your oil level is low. If it comes on for more than three seconds, see the *Index* under *Check Oil Level Warning Light*.

- **WASHER FLUID:** This message means your washer fluid tank is less than 30% full. The windshield portion of the vehicle outline will also glow. If these come on, see the *Index* under *Windshield Washer Fluid*.
- **LOW COOLANT:** This message means your coolant level has fallen to about half full. If it comes on, see the *Index* under *Engine Coolant*.
- **CHECK GAGES:** If this light comes on and stays on while you are driving, check your gages for fuel, coolant temperature, oil pressure or battery voltage.

Features & Controls

■ *Driver Information Center* (Cont.)

LAMP MONITOR: Whenever you try to use one of the following lights, **LAMP MONITOR** will tell you if a bulb is out.

- Head Lamp (Low and High beam)
- Turn Signal
- Park Lamp
- Brake Lamp
- Back-Up Lamp
- Tail Lamp

If a bulb is out, you will see a message, such as **PARK LAMP**, and you will also see where the problem is on the vehicle outline. The message stays on until the problem is fixed. See the *Index* under *Replacement Bulbs* for bulb details.

If a burned-out bulb is replaced, the warning light will stay on until the bulb is used (for example, by turning on your lights).

If you pull a trailer, the extra trailer lamp bulbs will not allow the lamp monitor to properly detect a burned-out bulb. When the trailer lights are disconnected, the lamp monitor will again monitor the bulbs.

SECURITY: You'll get a **DOOR AJAR** message if a door is not fully closed. The vehicle outline will show you which door it is. You will also get a **HOOD AJAR** or **TRUNK AJAR** message if the hood or the trunk isn't fully closed. The vehicle outline will also show you these are ajar.



■ *Electronic Compass (OPTION)*

On some vehicles, an electronic compass comes on when you start the engine. As with all compasses, it senses magnetic north to determine direction. But magnetic north is not located at the same place as true north, so a zone value is used to improve accuracy.

Setting Up Your Compass Consists of Two Steps:

1. Calibrating the compass to magnetic north.
2. Setting the zone so the compass points to true north.

Calibrating the Compass

The compass should be calibrated according to the proper Zone Setting:

- At least once a year.
- Any time it displays the word **CALIBRATE**.
- Any time it seems to show incorrect directions.

Calibrating to Magnetic North:

1. Drive to an open area such as a large, empty parking lot. Be sure the area is not only free of other vehicles but also away from power lines or large metal objects.
2. Push and hold **MODE** for more than six seconds. After three seconds, **CALIBRATE** and the heading display will go off. **ZONE** and the zone number will be displayed.

After six seconds, **CALIBRATE** will flash and the heading display will rotate. **ZONE** and the zone number will go blank.

Release the **MODE** button.

Features & Controls

Calibrating the Compass (CONT.)

3. Drive slowly in a circle at about 5 mph (8 km/h). Try to keep your vehicle level.
4. When **CALIBRATE** stops flashing, your compass is calibrated to magnetic north.

If **CALIBRATE** stops flashing before $1\frac{3}{4}$ circles, the calibration may not be accurate. However, if you are certain the calibration is accurate after the zone is set, then recalibration is not needed. Otherwise, repeat the calibration. If this condition continues, move the vehicle to a new area and recalibrate.

If **CALIBRATE** continues to flash after about seven circles, your compass is not calibrated. You could be too close to a power line or large metal object, or something magnetic in your vehicle (like a CB antenna) could keep the compass from calibrating.

If you are uncertain about where you are in the calibration sequence, or want to start over, simply push and release the **MODE** or **SET** button, or turn the ignition off and restart the engine.

Setting the Zone

Setting the zone corrects for differences between magnetic and true north.

You can set the zone in two ways: By selecting the zone you are located in or by pointing your vehicle north and telling the compass the direction of north. Perform only one of the two methods (A or B) each time you change zones. The last zone selection is remembered.



A. By Geographic Location:

1. With the engine running, press and hold **MODE** for more than three seconds. After three seconds, **CALIBRATE** and the heading display will go blank. **ZONE** and the zone number will be displayed. Release the **MODE** button.
2. Check the chart to see which zone you are in.
3. Press or hold **SET** until the display shows the number of your zone.
4. Press **MODE** again to enter your zone in the compass.

B. By Pointing Vehicle North:

1. Point your vehicle to true north.
2. Press and hold **MODE** until **ZONE** appears on the display.
3. Press or hold **SET** until **ZONE 00** is displayed.
4. Press **MODE**. The display will show a northern heading and the direction bars will flash.
5. Press **MODE** again. The display will show the current zone setting for two seconds, then keep that setting unless you change it.
6. When your engine is running, your compass should display true north.

You can change your zone any time you move to another zone without calibrating to magnetic north. However, if you are uncertain of accuracy, repeat the entire sequence by starting with step 1.

Temporary Disturbances:

Your compass may sometimes display a different heading for a moment as you pass under bridges, power lines or large metal objects, or when you are driving on steep hills. This is normal.

Features & Controls



Head-Up Display (OPTION)

If you have the optional Head-Up Display (HUD), you can see the speedometer reading in English or metric units displayed “through” the windshield.

The HUD also shows:

- Turn signal indicator lights.
- A high beam indicator symbol.
- A **CHECK GAGES** message. (For low oil pressure, high coolant temperature, low oil level and low fuel.)
- A low fuel warning symbol.

The HUD shows these lights when they are lit on the instrument panel.

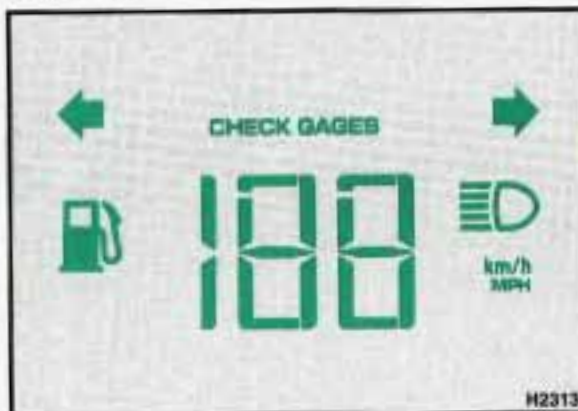

When you sit straight in your seat, the HUD image will appear slightly to the right in front of the driver.

When the ignition is turned to **Run**, all possible HUD images will come on as shown above. Then the Head-Up Display will operate normally.

CAUTION



If you never look at your instrument panel, you may not see something important, such as a warning light. So be sure to scan your displays and controls and the driving environment just as you would in a vehicle without HUD.

NOTICE

Although the HUD image appears to be near the front of the vehicle, do not use it as a parking aid. The HUD was not designed for that purpose. If you try to use it that way, such as in a parking lot, you may misjudge distance and run into something.



To Adjust the HUD so You Can See it Properly:

The HUD controls are located to the left of the steering column.

1. Start your engine and slide the **DIM** (dimmer) control all the way up.

The brightness of the HUD image is determined by whether the headlight switch is on or off, and where you have set the HUD dimmer control.

2. Adjust the seat, if necessary, before setting the height control.

Slide the **ADJUST** (image height) control all the way up, raising the image as far as possible. Then slide the HUD image height control downward so the image is as low as possible but in full view.

3. Slide the dimmer control down until the HUD image is no brighter than necessary. To turn the HUD off, slide the dimmer control all the way down.

If the sun comes out, or it becomes cloudy, or if you turn on your headlights, you may need to adjust the HUD's brightness using the HUD dimmer control. Polarizing sunglasses could make the HUD image harder to see.

CAUTION



If the HUD image is too bright, or too high in your field of view, it may take you more time to see things you need to see when it's dark outside. Be sure to keep the HUD image dim and placed low in your field of view.

Pushing the **ENG/MET** (English/Metric) button will switch the HUD speedometer indicator from English (conventional) to metric units, or back again.

Features & Controls



Care of the Head-Up Display

Clean the inside of the windshield as needed to remove any dirt or film that reduces the sharpness or clarity of the HUD image.

To Clean the HUD:

Spray household glass cleaner on a soft, clean cloth. Wipe the HUD lens gently, then dry it. Do not spray cleaner directly on the lens, because the cleaner fluid could leak inside the unit if you do.

If You Can't See the HUD Image When the Ignition is On:

- Is anything covering the HUD unit?
- Is the HUD dimmer control far enough up?
- Is the HUD image adjusted to the proper height?
- Still no HUD image? Check the fuse in the fuse panel. See the *Index* under *Fuses & Circuit Breakers*.

If the HUD Image is Not Clear:

- It could be too bright. Slide the HUD dimmer control further downward.
- You may need to clean the windshield and HUD lens.

Your windshield is part of the HUD system. If you ever have to have a new windshield, be sure to get one designed for HUD. If you don't, the HUD image may look blurred and out of focus.



Part **3**

Comfort Controls & Audio Systems

In this part you'll find out how to operate the comfort control systems and audio systems offered with your Pontiac. Be sure to read about the particular system supplied with your vehicle.

Standard Climate Control	120
Electronic Climate Control	123
Setting the Clock	127
AM/FM Stereo Radio	128
AM/FM Stereo with Cassette Player	129
AM/FM Stereo with Cassette Player and Graphic Equalizer	131
AM/FM Stereo with Compact Disc Player	134
Steering Wheel Controls for Audio System	139
Gain Control	140
Understanding Radio Reception	140
Care of Your Cassette Tape Player	141
Care of Your Compact Discs	141
Fixed Mast Antenna	142
Power Antenna Mast Care	142

Comfort Controls & Audio Systems



■ Standard Climate Control

The air conditioner and heater work best if you keep your windows closed while using them.

 : Selects the force of air you want. The fan is always running unless the mode control is moved to **OFF**.

Temperature Control: The center control regulates the temperature of the air coming through the system.

Mode Control: The right control has settings for air conditioning and non-air conditioning modes.



Air Conditioning Settings

There are three air conditioning settings. On very hot days, open the windows long enough to let hot inside air escape. This reduces the time your air conditioner's compressor will have to run, which should help fuel economy.

MAX: Provides maximum cooling or quick cool-down on very hot days. This setting recirculates much of the air inside your vehicle, and it should not be used for long periods because the air may become too cold and dry.

A/C: Use for normal cooling on hot days. This setting cools outside air and directs it through the instrument panel outlets.

 (**Bi-Level**): Use on cool, but sunny days. This setting brings in the outside air, but directs it in two ways. The cool air is directed to the upper portion of your body through the instrument panel outlets, but warmed air is directed through the heater ducts and defroster vents. At times this temperature difference may be more apparent than others.

The air conditioner compressor operates in all air conditioner positions, and in  (Defrost) and  (Defog) when the outside temperature is above 50°F (10°C). When the air conditioner is on, you may sometimes notice slight changes in your vehicle's engine speed and power. This is normal, because the system is designed to cycle the compressor on and off to keep the desired cooling and help fuel economy.

Non-Air Conditioning Settings

 (**Vent**): This setting brings in the outside air and directs it to the upper portion of your body through the instrument panel outlets.

 (**Heat**): This setting directs warmed air through the heater ducts.

The air conditioner compressor doesn't run in the non-air conditioning settings. This reduces engine load, resulting in improved fuel economy. If no non-air conditioning setting maintains the comfort of the air inside your vehicle, or it causes your windows to fog up, move the right selector to **MAX** or **A/C**, or to  (**Defrost**).

Defrosting

The  setting (**Defrost**) directs most air through the defroster vents, and some through the heater ducts. Use this for when you have fog or ice on the windshield. When it's 50°F (10°C) or warmer outside, you'll get cooled air.



Defogging Windows with Standard Climate Control

Move the temperature control to maximum heat.

To quickly defog the windshield, set the right selector to  and turn the fan control to **HIGH**.

Use  (**Defog**) for normal defogging of the windshield.

Comfort Controls & Audio Systems



Defogging Windows with Standard Climate Control (CONT.)

To defog the side windows, move the mode control to  and the fan control to **HIGH**. Aim the side vents toward the side windows. For increased air flow to the side vents, close the center vents.



Rear Window Defogger (OPTION)

The rear window defogger uses a warming grid to remove fog from the rear window. Press the  button and release it. A light will glow in the switch while the defogger is working. The defogger will return to off automatically after about 10 minutes of use. If you turn it on again, the defogger will operate for about five minutes only. You can also turn the defogger off by turning off the ignition or pressing the button again.

Do not attach a temporary vehicle license across the defogger grid on the rear window.

NOTICE

Don't use a razor blade or something else sharp on the inside of the rear window. If you do, you could cut or damage the warming grid, and the repairs wouldn't be covered by your warranty.



■ *Electronic Climate Control* (OPTION)

With this system, you can control the ventilation, heating and air conditioning in your vehicle, or you can use the automatic setting.

The digital screen displays the outside temperature, the inside temperature setting, the fan speed, and the heating mode you have selected.

The air conditioner compressor operates in all **AUTO** setting positions, and in

 when the outside temperature is above 49°F (9°C). When the air conditioner is on, you may sometimes notice slight changes in your vehicle's engine speed and power. This is normal, because the system is designed to cycle

the compressor on and off to keep the desired cooling and help fuel economy.

TEMP: Sets the interior temperature you want. The temperature you set will be displayed on the digital screen.

Once you set the temperature, the system will try to maintain the set temperature, whether or not you are using the heating or cooling controls. But if you set the temperature for 60°F (16°C) or 90°F (32°C), the fan will stay on **HI** speed unless you select a different speed.

AUTO: To allow the system to automatically control the temperature, air distribution and fan speed:

1. Set the temperature you want with the **TEMP** switch.
2. Press the **AUTO** switch.

EXT. TEMP: Press to have the outside temperature displayed on the digital screen (unless the system is off). Press again to return to the inside temperature setting. When the system is off, the outside temperature will be displayed.

Use the following controls when **AUTO** is not desired.

 : Sets the fan speed. Press the top of the switch to raise the fan speed, the bottom of the switch to lower the fan speed.

Comfort Controls & Audio Systems

■ *Electronic Climate Control* (Cont.)

° F/° C: Press this to read the temperature in degrees Fahrenheit or Celsius.

OFF: Shuts the system off. The outside temperature will be displayed. Air will still flow through your vehicle if it is moving. Also, the system will try to maintain the temperature you set, but may not be able to if it's very warm or cold outside.

ECON: Use in cold or cool weather. This saves fuel because the air conditioner compressor doesn't run. But this setting doesn't remove humidity from the air.



(Defrost): Press this to remove fog or ice from the windshield. It will start at the high fan speed, but you can select another speed if you want. It's a good idea to remove any ice or snow from the hood and from the air inlet between the hood and windshield.



(Rear Window Defogger): Press to warm the defogger grid on the rear window. On some models, the outside rearview mirrors are also warmed. The rear window defogger will turn off automatically after about 10 minutes of use. If you turn it on again, the defogger will operate for about five minutes only. You can also turn the defogger off by turning off the ignition or pressing the switch again.

Do not attach a temporary vehicle license across the defogger grid on the rear window.

NOTICE

Don't use a razor blade or something else sharp on the inside of the rear window. If you do, you could cut or damage the warming grid, and the repairs wouldn't be covered by your warranty.

Extended Idling with Electronic Climate Control

When the engine idles for a long time, the outside temperature sensor may cause the system to blow air that is too cool. This should stop once the vehicle is moving again. Extended idling is not recommended. See the *Index* under *Engine Exhaust*.



Rear Vents

Slide the center control up to direct air upward. Slide it down to direct air downward. The center position will direct air both up and down.

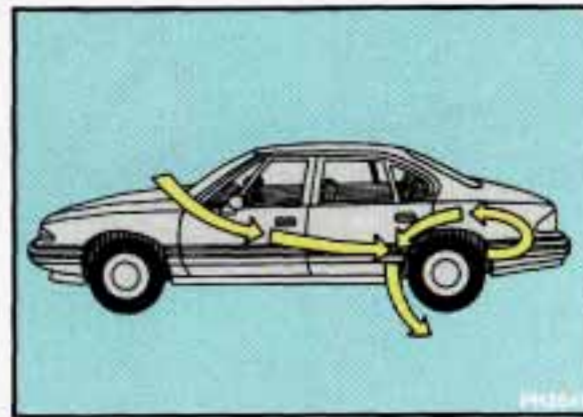

Flow-Through Ventilation System

Your Pontiac's flow-through ventilation system supplies outside air into the vehicle when it is moving. Outside air will also enter the vehicle when the heater or the air conditioning fan is running.

Comfort Controls & Audio Systems



Flow-Through Ventilation System (CONT.)

Ventilation Tips

- Keep the hood and front air inlet free of ice, snow, or any other obstruction (such as leaves). The heater and defroster will work far better, reducing the chance of fogging the inside of your windows.
- When you enter a vehicle with Standard Climate Control in cold weather, select a heater function that blows air through the floor ducts. Then turn the blower fan to **HI** for a few moments before driving off. This will blow moist air from the intake

ducts toward the floor, not the windshield. It reduces the chance of fogging the inside of your windows. If you have the Electronic Climate Control, the **AUTO** setting does this for you.

- Keep the air path under the front seats clear of objects. This helps air to circulate throughout your vehicle.

■ Audio Systems

The following pages describe the audio systems available for your Pontiac, and how to get the best performance from them. Please read about the system in your vehicle.

CAUTION



Hearing damage from loud noise is almost undetectable until it is too late. Your hearing can adapt to higher volumes of sound. Sound that seems normal can be loud and harmful to your hearing. Take precautions by adjusting the volume control on your radio to a safe sound level before your hearing adapts to it.

To help avoid hearing loss or damage:

1. Adjust the volume control to the lowest setting.
2. Increase volume slowly until you hear comfortably and clearly.

NOTICE

Before you add any sound equipment to your vehicle—like a tape player, CB radio, mobile telephone or two-way radio—be sure you can add what you want. If you can, it's very important to do it properly. Added sound equipment may interfere with the operation of your vehicle's engine, Delco® radio or other systems, and can even damage them. And, your vehicle's systems may interfere with the operation of sound equipment that has been added improperly.

So, before adding sound equipment, check with your dealer and be sure to check federal rules covering mobile radio and telephone units.



Setting the Clock

For Radios with ◀SEEK▶:

1. With the radio off, press SET. The SET indicator will appear on the digital screen for five seconds.
2. Within that five seconds, press and hold SEEK▶ until the correct minute appears on the display.
3. Before another five seconds pass, press and hold ◀SEEK until the correct hour appears.



For Radios with ▼SEEK▲:

1. With the radio on or off, press SET. The SET indicator will appear on the digital display for five seconds.
2. Within that five seconds, press and hold SEEK▲ until the correct minute appears on the display.
3. Before another five seconds pass, press and hold ▼SEEK until the correct hour appears.

Comfort Controls & Audio Systems



AM/FM Stereo Radio

The digital display indicates information on time or radio station frequency, the AM or FM radio band, whether the station is in stereo, and other radio functions.

Upper Knob (PWR•VOL): This knob does three things:

- Rotate it to turn the system on and off (**PWR**).
- Rotate it to control the volume.
- Press it to recall the station frequency when the radio is on.

BAL (Balance): The control ring behind the upper knob adjusts the left/right speaker balance.

Lower Knob (TUNE): This knob does two things:

- Rotate it to tune in radio stations.
- Press it to change between the AM or FM band.

FADE: The control ring behind the lower knob adjusts the front/rear speaker balance.

▼ SEEK ▲: Press to seek and stop on the next station higher or lower on the radio band.

TREB (Treble): Slide this lever up to increase treble, or down to decrease it. If a station is weak or noisy, reduce the treble.

BASS: Slide this lever up to increase bass, or down to decrease it.

To Preset Radio Stations:

1. Tune in the desired station.
2. Press **SET**. The word **SET** will appear on the digital screen for five seconds.
3. While **SET** is displayed, press one of the four pushbuttons.
The station is now preset. You can tune to it immediately by pressing the same numbered pushbutton.
4. Repeat steps 1-3 for each of four AM and four FM stations.

Up to three additional stations on each band may be preset by "pairing" pushbuttons:

1. Tune in the desired station.
2. Press **SET**, and within five seconds press any two adjacent pushbuttons at the same time.
3. The station can be tuned in when the same two pushbuttons are pressed at the same time.



AM/FM Stereo with Cassette Player

The digital display indicates information on time or radio station frequency, the AM or FM radio band, whether the station is in stereo, and other radio functions.

Upper Knob (PWR•VOL): This knob does four things:

- Rotate it to turn the system on and off (**PWR**).
- Rotate it to control the volume.
- Press it to recall the station frequency when the radio is on.

- When a tape is playing, press it to hear the other side of the tape.

BAL (Balance): The control ring behind the upper knob adjusts the left/right speaker balance.

Lower Knob (TUNE): This knob does two things:

- Rotate it to tune in radio stations.
- Press it to change between the AM or FM band.

FADE: The control ring behind the lower knob adjusts the front/rear speaker balance.

▼ SEEK ▲: Press to seek and stop on the next station higher or lower on the radio band.

TREB (Treble): Slide this lever up to increase treble, or down to decrease it. If a station is weak or noisy, reduce the treble.

BASS: Slide this lever up to increase bass, or down to decrease it.

To Preset Radio Stations:

1. Tune in the desired station.
2. Press **SET**. The word **SET** will appear on the digital screen for five seconds.
3. While **SET** is displayed, press one of the four pushbuttons.
The station is now preset. You can tune to it immediately by pressing the same numbered pushbutton.
4. Repeat steps 1-3 for each of four AM and four FM stations.

Comfort Controls & Audio Systems

AM/FM Stereo with Cassette Player (CONT.)

Up to three additional stations on each band may be preset by "pairing" pushbuttons:

1. Tune in the desired station.
2. Press **SET**, and within five seconds press any two adjacent pushbuttons at the same time.
3. The station can be tuned in when the same two pushbuttons are pressed at the same time.

To Play a Cassette Tape:

With the power switch on, insert a tape into the cassette door. Do not use tapes that are longer than 45 minutes on each side.

When the right indicator arrow is lit, selections listed on the bottom side of the cassette are playing. When the left arrow is lit, selections listed on the top side of the cassette are playing. To change sides of the tape, press the upper control knob while the cassette is playing. When the end of a tape is reached, the other side will then play.

FAST FORWARD: Depress the button with the arrow pointing in the same direction that the tape is playing. To stop fast forward, press the **STOP-EJECT** button.

REVERSE: Depress the button with the arrow pointing in the opposite direction that the tape is playing. To stop reverse, press the **STOP-EJECT** button.

STOP-EJECT: To stop playing a tape, fully press this button (the cassette will be partially ejected, and the radio will begin playing).



AM/FM Stereo with Cassette Player and Graphic Equalizer

The digital display indicates information on time or radio station frequency, the AM or FM radio band, whether the station is in stereo, and other radio functions.

PWR (Power): Turns the unit on and off when the ignition is on.

Upper Knob (VOL): This knob does two things:

- Rotate it slightly to the left or right to control the volume.
- Press it to mute the radio or tape player. Press again to listen.

BAL (Balance): The control ring behind the upper knob adjusts the left/right speaker balance. The digital display shows the balance selected.

Lower Knob (TUNE): This knob does two things:

- Rotate it slightly to the left or right to tune in radio stations. If you hold it to the left or right, it will tune rapidly. You can also rotate it one stop at a time to fine-tune a specific frequency.
- Press to change between the AM, FM1 or FM2 bands. (FM1 allows you to preset five stations, FM2 allows you to preset another five stations.)

Your radio has an AMAX-certified receiver. It can produce quality AM stereo sound and receive C-Quam® stereo broadcasts. AMAX reduces noise without reducing the high frequencies you need for the best sound. You don't have to do anything to your Delco/GM radio because AMAX is automatic.

Comfort Controls & Audio Systems

AM/FM Stereo with Cassette Player and Graphic Equalizer (CONT.)

FADE: The control ring behind the lower knob adjusts the front/rear speaker balance. The digital display shows the degree of fade selected.

◀SEEK▶: Press to seek and stop on the next station higher or lower on the radio band.

RCL: Press to alternate the display between the time and station frequency.

EQUALIZER: Boost the bass, emphasize a voice in a song, brighten the treble—your equalizer gives you freedom to adjust five separate frequencies of sound to your individual taste. Move a lever up to emphasize a frequency, move it down to de-emphasize. It's best to begin with the levers in the middle position, then adjust each lever as you like.

To Preset Radio Stations:



The five pushbuttons under the digital display can be used to preset up to 15 radio stations (five AM, five FMI and five FM2). The buttons have other uses when you are playing a tape (see *Tape Player*).

1. Tune the digital display to the station you want.
2. Press **SET**. The **SET** indicator will appear on the digital screen for five seconds.
3. While the **SET** indicator is displayed, press one of the five pushbuttons.
4. Repeat steps 1-3 for each of five AM, five FMI and five FM2 stations.



To Play a Cassette Tape:

Press **PWR** to turn the radio on. The radio will play until a cassette is pushed into the cassette entry door (the tape side goes in first). Do not use tapes that are longer than 90 minutes (45 minutes on each side).

This audio system has automatic  Dolby® B Noise Reduction to reduce background noise on Dolby® B encoded tapes. Dolby® B Noise Reduction is manufactured under license from Dolby Laboratories Licensing Corporation. Dolby® and the  symbol are trademarks of Dolby Laboratories Licensing Corporation.

PROG (Program): Press to change the side of tape being played. When the end of a tape is reached, the other side will then play.

CrO₂: This button sets tape bias. When playing high bias chrome or metal tapes, press the button to turn the CrO₂ display on. When playing standard tapes, press again to turn the display off.

REV (Reverse): Press to reverse the tape rapidly; press again to play the tape. (The radio plays while a tape is rewinding.)

FWD (Fast Forward): Press to advance the tape rapidly; press again to play. (The radio plays while the tape is advancing.)

PREV (Previous): Press **PREV** to repeat a passage. The tape will back up and stop at the first four-second quiet spot in the tape, or when you press **PREV** or **PROG** again.

NEXT: Press to go to the next selection on the tape. The tape will stop at the first four-second quiet spot in the tape, or if you press **NEXT** or **PROG** again.

ST-PL (Stop-Play): Press to switch from the tape to the radio. Press again to resume playing the tape.

EJECT: Press to eject the cassette tape (the radio will then play).

Comfort Controls & Audio Systems



AM/FM Stereo with Compact Disc Player

The digital display indicates information on time or radio station frequency, the AM or FM radio band, whether the station is in stereo, and other radio functions.

PWR (Power): Turns the unit on and off when the ignition is on.

Upper Knob (VOL): This knob does two things:

- Rotate it slightly to the left or right to control the volume.
- Press it to mute the radio or tape player. Press again to listen.

BAL (Balance): The control ring behind the upper knob adjusts the left/right speaker balance. The digital display shows the balance selected.

Lower Knob (TUNE): This knob does two things:

- Rotate it slightly to the left or right to tune in radio stations. If you hold it to the left or right, it will tune rapidly. You can also rotate it one stop at a time to fine-tune a specific frequency.
- Press to change between the AM, FMI or FM2 bands. (FMI allows you to preset five stations, FM2 allows you to preset another five stations.)

Your radio has an AMAX-certified receiver. It can produce quality AM stereo sound and receive C-Quam® stereo broadcasts. AMAX reduces noise without reducing the high frequencies you need for the best sound. You don't have to do anything to your Delco/GM radio because AMAX is automatic.

FADE: The control ring behind the lower knob adjusts the front/rear speaker balance. The digital display shows the degree of fade selected.

◀SEEK▶: Press to seek and stop on the next station higher or lower on the radio band.

RCL: Press to alternate the display between the time and station frequency.

EQUALIZER: Boost the bass, emphasize a voice in a song, brighten the treble—your equalizer gives you freedom to adjust five separate frequencies of sound to your individual taste. Move a lever up to emphasize a frequency, move it down to de-emphasize. It's best to begin with the levers in the middle position, then adjust each lever as you like.



Compact Disc Controls

Many of the controls for the radio also have functions for the compact disc player, as explained here.

To Play a Compact Disc:

Don't use mini-discs that are called singles. They won't eject. Use only full-size compact discs.

1. Press **PWR** to turn the radio on.
2. Insert a disc part-way into the slot, with the label side up. The player will pull it in. In a few seconds, the disc should play.

If the disc comes back out and/or **Err** appears on the display:

- The disc may be upside down.
- The disc may be dirty, scratched or wet.
- There may be too much moisture in the air (wait about one hour and try again).
- The player may be too hot, or the road may be too rough for the disc to play. As soon as things get back to normal, the disc should play.

The five pushbuttons at the lower right can be used to preset up to 15 radio stations (five AM, five FM1 and five FM2). The buttons have other uses when you are playing a compact disc (see *Compact Disc Controls*).

To Preset Radio Stations:

1. Tune the digital display to the station you want.
2. Press **SET**. The **SET** indicator will appear on the digital screen for five seconds.
3. While the **SET** indicator is displayed, press one of the five pushbuttons.
4. Repeat steps 1-3 for each of five AM, five FM1 and five FM2 stations.

Comfort Controls & Audio Systems

Compact Disc Controls (CONT.)

While a disc is playing, the CD indicator is displayed on the digital screen, as is the clock.

RCL (Recall): Press once to see which track is playing. Press again while the track number is displayed to see how long your selection has been playing. The track number also will be displayed when the volume is changed or a new track starts to play.

COMP (Compression): Depressing this button makes soft and loud passages more equal in volume. Press again to resume normal play.

RDM (Random): Press to play tracks in random order.

REV (Reverse): Press and hold to rapidly back up to a favorite passage. Release to resume playing.

FWD (Fast Forward): Press and hold to rapidly advance the disc. Release to resume playing.

PREV (Previous): Press to play a track again. If you keep pressing the **PREV** button, the disc will keep backing up to previous tracks.

NEXT: Press when you want to hear the next track. If you keep pressing the **NEXT** button, the disc will keep advancing to other tracks.

When Finished with the Compact Disc Player:

If you press **PWR** or turn off the ignition, the disc will stay in the player and start again when you turn on the ignition or power switch. The disc will begin playing at the point where it had been stopped.

ST/PL (Stop/Play): Press to stop the disc player; the radio will play. Press again to play the disc (the player will start playing the disc where it was stopped earlier).

EJECT: Press to eject the disc; the radio will play. After eject, if you turn the ignition off with the disc part-way out, the player will pull the disc back in after about 30 seconds. When the player is turned on, it will begin play on the first track.

CD Player Anti-Theft Feature

Delco LOC II is a security feature for the compact disc player. It can be used or ignored. If ignored, the system plays normally. If it is used, your player won't be usable if it is ever stolen, because it will go to **LOC** mode any time battery power is removed. Until an unlock code is entered, it will not turn on.

The instructions below tell you how to enter a secret code into the system. If your vehicle loses battery power for any reason, you must unlock the system with the secret code before the radio will turn on.

1. Write down any six-digit number and keep it in a safe place.
2. Turn the ignition to the **Accessory** or **Run** position.

3. Press the **PWR** button to turn the radio off.
4. Press the **1** and **4** buttons together. Hold them down until "--" shows on the display. You are ready to enter your secret code.

NOTE: If you allow more than 15 seconds to elapse between any steps, the radio automatically reverts to time and you must start the procedure over at step 4.

5. Press **SET** and **000** will appear on the display.
6. Press the **SEEK▶** button to make the first number of your code appear.

7. Rotate the **TUNE** knob right or left to make the second and third numbers agree with your code.
8. Press the lower (**BAND**) knob and **000** will appear again. Now you are ready to enter the last three digits of your code.
9. Repeat steps 6 and 7 for the last three digits of your code.
10. Press the lower (**BAND**) knob and **REP** will appear for five seconds and then **000** will appear.
11. Repeat steps 6 through 10. This time **SEC** will appear, indicating that the radio is secure.

Comfort Controls & Audio Systems

CD Player Anti-Theft Feature

(CONT.)

To Unlock the System After a Power Loss:

When battery power is reapplied to a secured radio, the radio won't turn on and **LOC** will appear on the display. Enter your secret code as follows; pause no more than 15 seconds between steps.

1. Turn the ignition on. (Radio off.)
2. Press the **SET** button. The display will show **000**.
3. Enter the six digits of the code following steps 6-9 above. The display will show the numbers as entered.
4. Press the lower (**BAND**) knob and **SEC** appears, then the time, indicating that the disabling sequence was successful.

Disabling the Anti-Theft System:

1. Press the **1** and **4** buttons together for five seconds with ignition on and radio power off. The display will show **SECURED**, indicating the unit is in the secure mode.
2. Press the **SET** button. The display will show **000**.
3. Enter the first three digits of the code following steps 6-7 earlier in this section. The display will show the numbers as entered.

4. Press the lower (**BAND**) knob. The radio will display **000**.
5. Enter the second three digits of the code. The display will show the numbers as entered.
6. Press the lower (**BAND**) knob. If the display shows "- - -," the disabling sequence was successful (the numbers matched the user-selected code or the factory back-up code) and the unit is in the **UNSECURED** mode. If the display shows **SEC**, the disabling sequence was unsuccessful and the numbers did not match either of the codes and the unit will remain in the **SECURED** mode.



Steering Wheel Controls for Audio System

Some audio functions can be operated with these controls:

AM/FM: Press to select either the AM or FM1 and FM2 radio bands. The band you select will be displayed on the digital screen. The frequency of the station will be displayed, and if the station is in stereo, the stereo indicator will also be displayed.

SEEK: Each time you press an up or down arrow on **SEEK**, you will tune in the next station up or down the AM or FM radio band.

When listening to a cassette tape or compact disc, you can change to the previous or next selection by pressing the **SEEK** up or down arrow.

RCL (Recall): When the radio is on, press to change between the clock and the radio station frequency displayed on the digital screen.



PRE-SET: Press this to hear the radio stations that are set on your system.

VOL (Volume): Press ▲ to increase volume. Press ▼ to lower the volume.

PWR: Turns the unit on and off when the ignition is on.

Comfort Controls & Audio Systems



Gain Control

Some models have this control below the audio system.

To get more bass sound, move the **GAIN** control to adjust the amount of bass.

Understanding Radio Reception

FM Stereo

FM stereo will give you the best sound, but FM signals will reach only about 10 to 40 miles (16 to 65 km). Tall buildings or hills can interfere with FM signals, causing the sound to come and go.

AM

The range for most AM stations is greater than for FM, especially at night. The longer range, however, can cause stations to interfere with each other. AM can also pick up noise from things like storms and power lines. To lower this noise, try reducing the treble level.

AM Stereo

Your Delco® system may be able to receive C-Quam® stereo broadcasts. Many AM stations around the country use C-Quam® to produce stereo, though some do not. C-Quam® is a registered trademark of Motorola, Inc. If your Delco® system can get C-Quam® signals, your stereo indicator light will come on when you are receiving it.



Care of Your Cassette Tape Player

A tape player that is not cleaned regularly can cause reduced sound quality, ruined cassettes, or a damaged mechanism. Cassette tapes should be stored in their cases away from contaminants, direct sunlight, and extreme heat. If they aren't, they may not operate properly or cause failure of the tape player.

Your tape player should be cleaned regularly each month or after every 15 hours of use. If you notice a reduction in sound quality, try a known good cassette to see if the tape or the tape player is at fault. If this other cassette has no improvement in sound quality, clean the tape player.

Clean your tape player with a wiping-action, non-abrasive cleaning cassette, and follow the directions provided with it.

Cassettes are subject to wear and the sound quality may degrade over time. Always make sure that the cassette tape is in good condition before you have your tape player serviced.



Care of Your Compact Discs

Handle discs carefully. Store them in their original cases or other protective cases and away from direct sunlight and dust. If the surface of a disc is soiled, dampen a clean, soft cloth in a mild, neutral detergent solution and clean it, wiping from the center to the edge.

Be sure never to touch the signal surface when handling discs. Pick up discs by grasping the outer edges or the edge of the hole and the outer edge.

Comfort Controls & Audio Systems



Fixed Mast Antenna

The fixed mast antenna can withstand most car washes without being damaged. If the mast should ever become slightly bent, you can straighten it out by hand. If the mast is badly bent, as it might be by vandals, you should replace it.

Check every once in a while to be sure the mast is still tightened to the fender.

Power Antenna Mast Care

Your power antenna will look its best and work well if it's cleaned from time to time.

To Clean the Antenna Mast:

1. Turn on the ignition and radio to raise the antenna to full mast extension.
2. Dampen a clean cloth with mineral spirits or equivalent solvent.
3. Wipe the cloth over the mast sections, removing any dirt.
4. Wipe dry with a clean cloth before retracting.
5. Make the antenna go up and down by turning the radio or ignition on and off.
6. Then repeat if necessary.

NOTICE

Don't lubricate the power antenna. Lubrication could damage it.

NOTICE

Before entering an automatic car wash, turn off your radio to make the power antenna go down. This will prevent the mast from possibly getting damaged. If the antenna does not go down when you turn the radio off, it may be damaged or need to be cleaned. In either case, lower the antenna by hand by carefully pressing the antenna down.

If the mast portion of your antenna is damaged, you can easily replace it. See your dealer for a replacement kit, and follow the instructions in the kit.

Notes



PH0013

Here you'll find information about driving on different kinds of roads and in varying weather conditions. We've also included many other useful tips on driving.

Part **4**

Your Driving and the Road

Road Signs	146
Defensive Driving	150
Drunken Driving	151
Control of a Vehicle	
Braking	154
Anti-Lock Brakes	155
Steering Tips	160
Steering in Emergencies	161
Passing	163
Driving at Night	165
Driving in the Rain	168
Driving in Fog, Mist and Haze	170
City Driving	171
Freeway Driving	172
Driving a Long Distance	174
Hill and Mountain Roads	176
Parking on Hills	177
Winter Driving	179
Towing a Trailer	183

Your Driving and the Road

■ Road Signs

The road signs you see everywhere are coded by color, shape and symbols. It's a good idea to know these codes so that you can quickly grasp the basic meaning or intent of the sign even before you have a chance to read it.



STOP

DO NOT
ENTER

WRONG
WAY

Color of Road Signs

Red means **Stop**. It may also indicate that some movement is not allowed. Examples are **Do Not Enter** and **Wrong Way**.



X3011

Green is used to guide the driver. Green signs may indicate upcoming freeway exits or show the direction you should turn to reach a particular place.



RR ADVANCE
CROSSING

NARROW
BRIDGE

NO PASSING
ZONE

Yellow indicates a general warning. Slow down and be careful when you see a yellow sign. It may signal a railroad crossing ahead, a no-passing zone, or some other potentially dangerous situation. Likewise, a yellow solid line painted on the road means **Don't Cross**.



X3012

HOSPITAL

INFORMATION

Blue signs with white letters show motorists' services.



LOW SHOULDER WORKERS AHEAD FLAGGER AHEAD

Orange indicates road construction or maintenance. You'll want to slow down when you see an orange sign, as part of the road may be closed off or torn up. And there may be workers and maintenance vehicles around, too.



X3014

Shape of Road Signs

The shape of the sign will tell you something, too.

An **octagonal** (eight-sided) sign means **Stop**. It is always red with white letters.



X3015

A **diamond**-shaped sign is a warning of something ahead—for example, a curve, steep hill, soft shoulder, or a narrow bridge.



CANOEING SWIMMING

Brown signs point out recreation areas or points of historic or cultural interest.



X3016

A **triangle**, pointed downward, indicates **Yield**. It assigns the right of way to traffic on certain approaches to an intersection.



X3017

A **triangular** sign also is used on two-lane roads to indicate a **No Passing Zone**. This sign will be on the left side of the roadway.

Your Driving and the Road

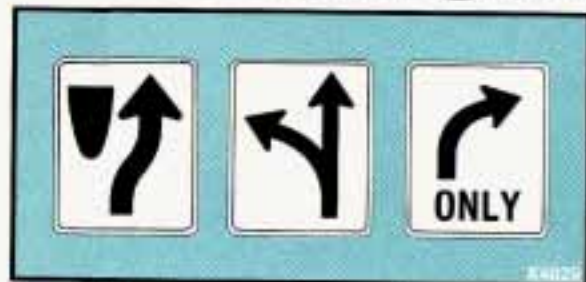

KEEP
RIGHT

LEFT OR
THROUGH

RIGHT TURN
ONLY

Shape of Road Signs (CONT.)

Rectangular (square or oblong) signs show speed limits, parking regulations, give directions, and such information as distances to cities.



Symbols on Road Signs

There are many international road signs in use today.



NO U
TURN

NO
PARKING

NO
BICYCLES

The basic message of many of these signs is in pictures or graphic symbols. A picture within a circle with a diagonal line across it shows what **not** to do.



Traffic Lights

We're all familiar with traffic lights or stop lights. Often green arrows are being used in the lights for improved traffic control. On some multilane roads, green arrows light up, indicating that traffic in one or more lanes can move or make a turn. Green arrows don't mean "go no matter what." You'll still need to proceed with caution, yielding the right of way to pedestrians and sometimes to other vehicles.

Some traffic lights also use red arrows to signify that you must stop before turning on red.

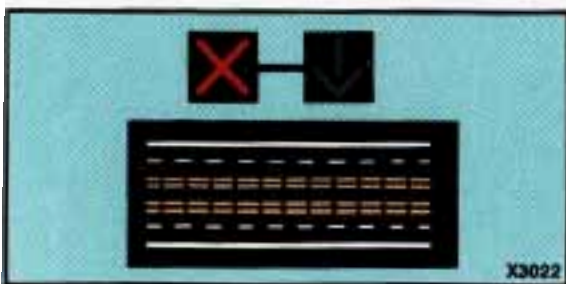

REVERSIBLE LANE ON MULTILANE ROADWAY



NO PASSING ZONE

Many city roads and expressways, and even bridges, use reversible-lane traffic control during rush hours. A red X light above a lane means no driving in that lane at that time. A green arrow means you may drive in that lane. Look for the signs posted to warn drivers what hours and days these systems are in effect.

Pavement Markings

Pavement markings add to traffic signs and signals. They give information to drivers without taking attention from the roadway. A solid yellow line on your side of the road or lane means **Don't Cross**.

Your Own Signals

Drivers signal to others, too. It's not only more polite, it's safer to let other drivers know what you are doing. And in some places the law requires driver signals.

Turn and Lane Change Signals:

Always signal when you plan to turn or change lanes.

If necessary, you can use hand signals out the window: Left arm straight out for a left turn, down for slow or about-to-stop, and up for a right turn.

Slowing Down: If time allows, tap the brake pedal once or twice in advance of slowing or stopping. This warns the driver behind you.

Disabled: Your four-way flashers signal that your vehicle is disabled or is a hazard. See the *Index* under *Hazard Warning Flashers*.

Traffic Officer

The traffic police officer is also a source of important information. The officer's signals govern, no matter what the traffic lights or other signs say.

The next section discusses some of the road conditions you may encounter.

Your Driving and the Road

Defensive Driving

The best advice anyone can give about driving is: Drive defensively.

Please start with a very important safety device in your Pontiac: Buckle up. (See the *Index* under *Safety Belts*.)

Defensive driving really means "be ready for anything." On city streets, rural roads, or freeways, it means "always expect the unexpected."

Assume that pedestrians or other drivers are going to be careless and make mistakes. Anticipate what they might do. Be ready for their mistakes.

Expect children to dash out from behind parked cars, often followed by other children. Expect occupants in parked cars to open doors into traffic. Watch for movement in parked cars—someone may be about to open a door.

Expect other drivers to run stop signs when you are on a through street. Be ready to brake if necessary as you go through intersections. You may not have to use the brake, but if you do, you will be ready.

If you're driving through a shopping center parking lot where there are well-marked lanes, directional arrows, and designated parking areas, expect some drivers to ignore all these markings and dash straight toward one part of the lot.

Pedestrians can be careless. Watch for them. In general, you must give way to pedestrians even if you know you have the right of way.

Rear-end collisions are about the most preventable of accidents. Yet they are common. Allow enough following

distance. It's the best defensive driving maneuver, in both city and rural driving. You never know when the vehicle in front of you is going to brake or turn suddenly.

Here's a final bit of information about defensive driving. The most dangerous time for driving in the U.S. is very early on Sunday morning. In fact, GM Research studies show that the most and the least dangerous times for driving, every week, fall on the same day. That day is Sunday. The most dangerous time is Sunday from 3 a.m. to 4 a.m. The safest time is Sunday from 10 a.m. to 11 a.m. Driving the same distance on a Sunday at 3 a.m. isn't just a little more dangerous than it is at 10 a.m. It's about 134 times more dangerous!

That leads to the next section.

Drunken Driving

Death and injury associated with drinking and driving is a national tragedy. It's the number one contributor to the highway death toll, claiming thousands of victims every year. Alcohol takes away three things that anyone needs to drive a vehicle:

- Judgment
- Muscular Coordination
- Vision

Police records show that half of all motor vehicle-related deaths involve alcohol—a driver, a passenger or someone else, such as a pedestrian, had been drinking. In most cases, these deaths are the result of someone who was drinking and driving. Over 25,000 motor vehicle-related deaths occur each year because of alcohol, and thousands of people are injured.

Just how much alcohol is too much if a person plans to drive? Ideally, no one should drink alcohol and then drive. But if one does, then what's "too much"? It can be a lot less than many might think. Although it depends on each person and situation, here is some general information on the problem.

The Blood Alcohol Content (BAC) of someone who is drinking depends upon four things:

- How much alcohol is in the drink.
- The drinker's body weight.
- The amount of food that is consumed before and during drinking.
- The length of time it has taken the drinker to consume the alcohol.



According to the American Medical Association, a 180-pound (82 kg) person who drinks three 12-ounce (355 ml) bottles of beer in an hour will end up with a BAC of about 0.06 percent. The person would reach the same BAC by drinking three 4-ounce (120 ml) glasses of wine or three mixed drinks if each had 1½ ounces (45 ml) of a liquor like whiskey, gin or vodka.

It's the amount of alcohol that counts. For example, if the same person drank three double martinis (3 ounces or 90 ml of liquor each) within an hour, the person's BAC would be close to 0.12 percent. A person who consumes food just before or during drinking will have a slightly lower BAC level.

Your Driving and the Road

Drinking that Will Result in a BAC of .05% in the Time Shown

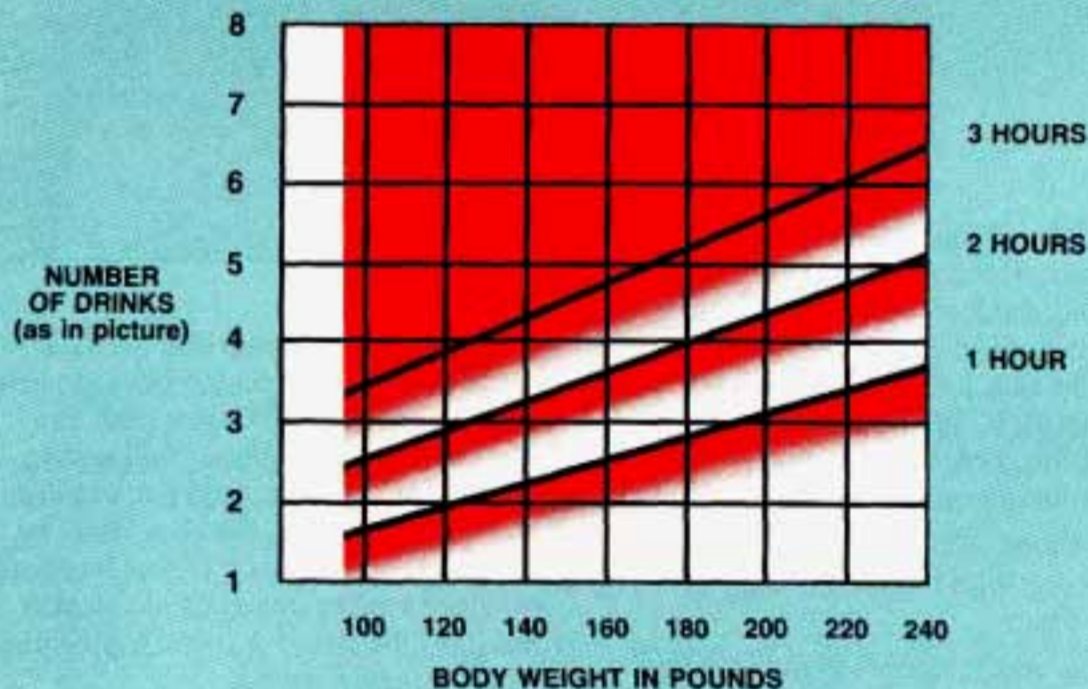

people are impaired at a BAC approaching 0.05 percent, and that the effects are worse at night. All drivers are impaired at BAC levels above 0.05 percent. Statistics show that the chance of being in an accident increases sharply for drivers who have a BAC of 0.05 percent or above. A driver with a BAC level of 0.06 percent (three beers in one hour for a 180-pound or 82 kg person) has doubled his or her chance of having an accident. At a BAC level of 0.10 percent, the chance of that driver having an accident is six times greater; at a level of 0.15 percent, the chances are twenty-five times greater! And, the body takes about an hour to rid itself of the alcohol in one drink. No amount of coffee or number of cold showers will speed that up.

Drunken Driving (CONT.)

The law in most U.S. states sets the legal limit at a BAC of 0.10 percent. In Canada the limit is 0.08 percent, and in some other countries it's lower than that. The BAC will be over 0.10 percent after three to six drinks (in one hour).

Of course, as we've seen, it depends on how much alcohol is in the drinks, and how quickly the person drinks them.

But it's very important to keep in mind that the ability to drive is affected well below a BAC of 0.10 percent. Research shows that the driving skills of many

“I’ll be careful” isn’t the right answer. What if there’s an emergency, a need to take sudden action, as when a child darts into the street? A person with a higher BAC might not be able to react quickly enough to avoid the collision.

There’s something else about drinking and driving that many people don’t know. Medical research shows that alcohol in a person’s system can make crash injuries worse. That’s especially true for brain, spinal cord and heart injuries. That means that if anyone who has been drinking—driver or passenger—is in a crash, the chance of being killed or permanently disabled is higher than if that person had not been drinking. And we’ve already seen that

the chance of a crash itself is higher for drinking drivers.

CAUTION



Drinking and then driving is very dangerous. Your reflexes, perceptions, and judgment will be affected by even a small amount of alcohol. You could have a serious—or even fatal—accident if you drive after drinking. Please don’t drink and drive or ride with a driver who has been drinking. Ride home in a cab; or if you’re with a group, designate a driver who will not drink.

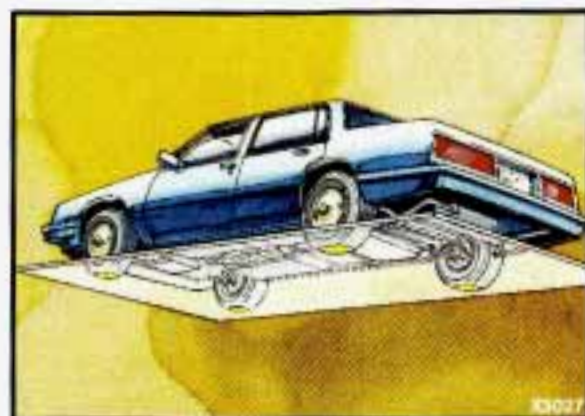

■ *Control of a Vehicle*

You have three systems that make your vehicle go where you want it to go. They are the brakes, the steering and the accelerator. All three systems have to do their work at the places where the tires meet the road.

Sometimes, as when you’re driving on snow or ice, it’s easy to ask more of those control systems than the tires and road can provide. That means you can lose control of your vehicle.

Your Driving and the Road

Braking

Braking action involves **perception time** and **reaction time**.

First, you have to decide to push on the brake pedal. That's **perception time**. Then you have to bring up your foot and do it. That's **reaction time**.

Average **reaction time** is about $\frac{3}{4}$ of a second. But that's only an average. It might be less with one driver and as long as two or three seconds or more with another. Age, physical condition, alertness, coordination, and eyesight all play a part. So do alcohol, drugs and frustration. But even in $\frac{3}{4}$ of a second, a vehicle moving at 60 mph (100 km/h) travels 66 feet (20 m). That could be a lot of distance in an emergency, so keeping enough space between your vehicle and others is important.

And, of course, actual stopping distances vary greatly with the surface of the road (whether it's pavement or gravel); the condition of the road (wet, dry, icy); tire tread; and the condition of your brakes.

Most drivers treat their brakes with care. Some, however, overwork the braking system with poor driving habits.

- Avoid needless heavy braking. Some people drive in spurts—heavy acceleration followed by heavy braking—rather than keeping pace with traffic. This is a mistake. Your brakes may not have time to cool between hard stops. Your brakes will wear out much faster if you do a lot of heavy braking.



- Don't "ride" the brakes by letting your left foot rest lightly on the brake pedal while driving.

CAUTION



"Riding" your brakes can cause them to overheat to the point that they won't work well. You might not be able to stop your vehicle in time to avoid an accident. If you "ride" your brakes, they will get so hot they will require a lot of pedal force to slow you down. Avoid "riding" the brakes.

NOTICE

"Riding" the brakes wears them out much faster. You would need costly brake replacement much sooner than normal, and it also reduces fuel economy.

If you keep pace with the traffic and allow realistic following distances, you will eliminate a lot of unnecessary braking. That means better braking and longer brake life.

- If your engine ever stops while you're driving, brake normally but don't pump your brakes. If you do, the pedal may get harder to push down. If your engine stops, you will still have some power brake assist. But you will use it when you brake. Once the power assist is used up, it may take longer to stop and the brake pedal will be harder to push.



Anti-Lock Brakes

Your Pontiac has an advanced electronic braking system that will help prevent skidding.

Your Driving and the Road

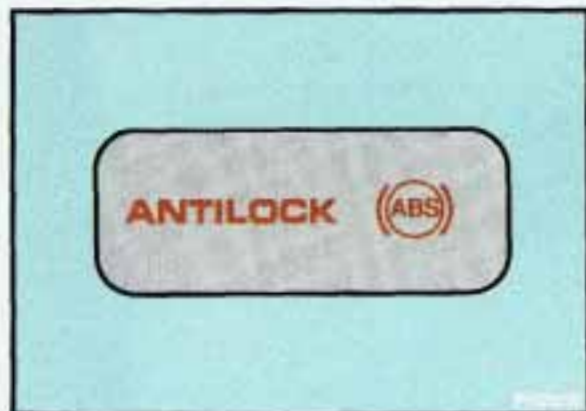

Anti-Lock Brakes (CONT.)

This light on the instrument panel will go on when you start your vehicle. See the *Index* under *Anti-Lock Brake System Warning Light*.



Here's how anti-lock works. Let's say the road is wet. You're driving safely. Suddenly an animal jumps out in front of you.

You slam on the brakes. Here's what happens with ABS.

A computer senses that wheels are slowing down. The computer separately works the brakes at each front wheel and at the rear wheels.

The anti-lock system can change the brake pressure faster than any driver could. The computer is programmed to make the most of available tire and road conditions.



You can steer around the obstacle while braking hard. As you brake, your computer keeps receiving updates on wheel speed and controls braking pressure accordingly.

CAUTION



Anti-lock doesn't change the time you need to get your foot up to the brake pedal. If you get too close to the vehicle in front of you, you won't have time to apply your brakes if that vehicle suddenly slows or stops. Always leave enough room up ahead to stop, even though you have anti-lock brakes.



Traction Control (OPTION)

Your vehicle may have a traction control system that limits wheel spin. This is especially useful in slippery road conditions. The traction control system works at low speeds only, such as when you accelerate from a stop. It applies brake pressure to an individual wheel that the system senses is about to spin.

You may feel the system working, or you may notice some noise, but this is normal.

A **TRACTION OFF** warning light in the instrument cluster lets you know if your traction control system is not working. See the *Index* under *Traction Control System Warning Light*.

To turn the system off, press the **TRACTION CONTROL** switch on the center console while the vehicle is stopped. The **TRACTION OFF** warning light will come on and stay on. To turn the system back on, bring the vehicle to a stop and press the switch again. The warning light should go off. The system will also turn itself on if you turn your ignition off and back on again.

To Use Anti-Lock: Don't pump the brakes. Just hold the brake pedal down and let anti-lock work for you.

When you start your vehicle and begin to drive away, you may hear a momentary motor or clicking noise and you may even notice that your brake pedal moves a little while this is going on. This is the ABS system testing itself. You also may hear this during a hard stop.

Your Driving and the Road

Disc Brake Wear Indicators

Your Pontiac has front disc brakes and rear drum brakes. Disc brake pads have built-in wear indicators that make a high-pitched warning sound when the brake pads are worn and new pads are needed. The sound may come and go or be heard all the time your vehicle is moving (except when you are pushing on the brake pedal firmly).

CAUTION



The brake wear warning sound means that sooner or later your brakes won't work well. That could lead to an accident. When you hear the brake wear warning sound, have your vehicle serviced.

NOTICE

Continuing to drive with worn-out brake pads could result in costly brake repair.

Some driving conditions or climates may cause a brake squeal when the brakes are first applied or lightly applied. This does not mean something is wrong with your brakes.

Rear Drum Brakes

Your rear drum brakes don't have wear indicators, but if you ever hear a rear brake rubbing noise, have the rear brake linings inspected. Also, the rear brake drums should be removed and inspected each time the tires are removed for rotation or changing. When you have the front brakes replaced, have the rear brakes inspected, too.

Brake linings should always be replaced as complete axle sets.

Brake Pedal Travel

See your dealer if the brake pedal does not return to normal height, or if there is a rapid increase in pedal travel. This could be a sign of brake trouble.

Brake Adjustment

Every time you make a moderate brake stop, your brakes adjust for wear. If you rarely make a moderate or heavier stop, then your brakes might not adjust correctly. If you drive in that way, then—very carefully—make a few moderate brake stops about every 1,000 miles (1 600 km), so your brakes will adjust properly.

Braking In Emergencies

Use your anti-lock braking system when you need to. With anti-lock, you can steer and brake at the same time. In many emergencies, steering can help you more than even the very best braking.

Your Driving and the Road

Power Steering

If you lose power steering assist because the engine stops or the system fails to function, you can steer but it will take much more effort.

Variable Effort Steering

If your vehicle is equipped with this option, you have a variable effort steering system that eases steering effort at speeds less than 20 mph (32 km/h). This is particularly useful when parking your vehicle.

Steering Tips—Driving on Curves

It's important to take curves at a reasonable speed.

A lot of the “driver lost control” accidents mentioned on the news happen on curves. Here's why:

Experienced driver or beginner, each of us is subject to the same laws of physics when driving on curves. The traction of the tires against the road surface makes it possible for the vehicle to change its path when you turn the front wheels. If there's no traction, inertia will keep the vehicle going in the same direction. If you've ever tried to steer a vehicle on wet ice, you'll understand this.

The traction you can get in a curve depends on the condition of your tires and the road surface, the angle at which the curve is banked, and your speed. While you're in a curve, speed is the one factor you can control.

Suppose you're steering through a sharp curve. Then you suddenly accelerate. Those two control systems—steering and acceleration—can overwhelm those places where the tires meet the road and make you lose control.

What should you do if this ever happens? Let up on the brake or accelerator pedal, steer the vehicle the way you want it to go, and slow down.

Speed limit signs near curves warn that you should adjust your speed. Of course, the posted speeds are based on good weather and road conditions. Under less favorable conditions you'll want to go slower.

If you need to reduce your speed as you approach a curve, do it before you enter the curve, while your front wheels are straight ahead.

Try to adjust your speed so you can "drive" through the curve. Maintain a reasonable, steady speed. Wait to accelerate until you are out of the curve, and then accelerate gently into the straightaway.

When you drive into a curve at night, it's harder to see the road ahead of you because it bends away from the straight beams of your lights. This is one good reason to drive slower.



Steering in Emergencies

There are times when steering can be more effective than braking. For example, you come over a hill and find a truck stopped in your lane, or a car suddenly pulls out from nowhere, or a child darts out from between parked cars and stops right in front of you. You can avoid these problems by braking—if you can stop in time. But sometimes you can't; there isn't room. That's the time for evasive action—steering around the problem.

Your Pontiac can perform very well in emergencies like these. First apply your brakes. It is better to remove as much speed as you can from a possible collision. Then steer around the problem, to the left or right depending on the space available.

Your Driving and the Road

Steering in Emergencies (CONT.)

An emergency like this requires close attention and a quick decision. If you are holding the steering wheel at the recommended 9 and 3 o'clock positions, you can turn it a full 180 degrees very quickly without removing either hand. But you have to act fast, steer quickly, and just as quickly straighten the wheel once you have avoided the object. You must then be prepared to steer back to your original lane and then brake to a controlled stop.

Depending on your speed, this can be rather violent for an unprepared driver. This is one of the reasons driving experts recommend that you use your safety belts and keep both hands on the steering wheel.

The fact that such emergency situations are always possible is a good reason to practice defensive driving at all times.



Off-Road Recovery

You may find sometime that your right wheels have dropped off the edge of a road onto the shoulder while you're driving.

If the level of the shoulder is only slightly below the pavement, recovery should be fairly easy. Ease off the accelerator and then, if there is nothing in the way, steer so that your vehicle straddles the edge of the pavement. You can turn the steering wheel up to $\frac{1}{4}$ turn until the right front tire contacts the pavement edge. Then turn your steering wheel to go straight down the roadway.

If the shoulder appears to be about four inches (100 mm) or more below the pavement, this difference can cause

problems. If there is not enough room to pull entirely onto the shoulder and stop, then follow the same procedures. But if the right front tire scrubs against the side of the pavement, do **not** steer more sharply. With too much steering angle, the vehicle may jump back onto the road with so much steering input that it crosses over into the oncoming traffic before you can bring it back under control. Instead, ease off again on the accelerator and steering input, straddle the pavement once more, then try again.

Passing

The driver of a vehicle about to pass another on a two-lane highway waits for just the right moment, accelerates, moves around the vehicle ahead, then goes back into the right lane again. A simple maneuver?

Not necessarily! Passing another vehicle on a two-lane highway is a potentially dangerous move, since the passing vehicle occupies the same lane as oncoming traffic for several seconds. A miscalculation, an error in judgment, or a brief surrender to frustration or anger can suddenly put the passing driver face to face with the worst of all traffic accidents—the head-on collision.

So here are some tips for passing:

- “Drive ahead.” Look down the road, to the sides, and to crossroads for situations that might affect your passing patterns. If you have any doubt whatsoever about making a successful pass, wait for a better time.

- Watch for traffic signs, pavement markings, and lines. If you can see a sign up ahead that might indicate a turn or an intersection, delay your pass. A broken center line usually indicates it’s all right to pass (providing the road ahead is clear). Never cross a solid line on your side of the lane or a double solid line, even if the road seems empty of approaching traffic.
- If you suspect that the driver of the vehicle you want to pass isn’t aware of your presence, tap the horn a couple of times before passing.
- Do not get too close to the vehicle you want to pass while you’re awaiting an opportunity. For one thing, following too closely reduces your area of vision, especially if you’re following a larger vehicle. Also, you won’t have adequate space if the vehicle ahead suddenly slows or stops. Keep back a reasonable distance.
- When it looks like a chance to pass is coming up, start to accelerate but stay in the right lane and don’t get too close. Time your move so you will be increasing speed as the time comes to move into the other lane. If the way is clear to pass, you will have a “running start” that more than makes up for the distance you would lose by dropping back. And if something happens to cause you to cancel your pass, you need only slow down and drop back again and wait for another opportunity.
- If other cars are lined up to pass a slow vehicle, wait your turn. But take care that someone isn’t trying to pass you as you pull out to pass the slow vehicle. Remember to glance over your shoulder and check the blind spot.
- Check your mirrors, glance over your shoulder, and start your left lane change signal before moving out of the

Your Driving and the Road

Passing (CONT.)

right lane to pass. When you are far enough ahead of the passed vehicle to see its front in your inside mirror, activate your right lane change signal and move back into the right lane. (Remember that your right outside mirror is convex. The vehicle you just passed may seem to be farther away from you than it really is.)

- Try not to pass more than one vehicle at a time on two-lane roads. Reconsider before passing the next vehicle.
- Don't overtake a slowly moving vehicle too rapidly. Even though the brake lights are not flashing, it may be slowing down or starting to turn.
- If you're being passed, make it easy for the following driver to get ahead of you. Perhaps you can ease a little to the right.

Loss of Control

Let's review what driving experts say about what happens when the three control systems (brakes, steering and acceleration) don't have enough friction where the tires meet the road to do what the driver has asked.

In any emergency, don't give up. Keep trying to steer and constantly seek an escape route or area of less danger.

Skidding

In a skid, a driver can lose control of the vehicle. Defensive drivers avoid most skids by taking reasonable care suited to existing conditions, and by not "overdriving" those conditions. But skids are always possible.

The three types of skids correspond to your Pontiac's three control systems. In the braking skid your wheels aren't rolling. In the steering or cornering skid, too much speed or steering in a curve causes tires to slip and lose cornering force. And in the acceleration skid too much throttle causes the driving wheels to spin.

A cornering skid and an acceleration skid are best handled by easing your foot off the accelerator pedal. If your vehicle starts to slide (as when you turn

a corner on a wet, snow- or ice-covered road), ease your foot off the accelerator pedal as soon as you feel the vehicle start to slide. Quickly steer the way you want the vehicle to go. If you start steering quickly enough, your vehicle will straighten out. As it does, straighten the front wheels.

Of course, traction is reduced when water, snow, ice, gravel, or other material is on the road. For safety, you'll want to slow down and adjust your driving to these conditions. It is important to slow down on slippery surfaces because stopping distance will be longer and vehicle control more limited.

While driving on a surface with reduced traction, try your best to avoid sudden steering, acceleration, or braking (including engine braking by shifting to a lower gear). Any sudden changes could cause the tires to slide. You may not realize the surface is slippery until your vehicle is skidding. Learn to recognize warning clues—such as enough water, ice or packed snow on the road to make a “mirrored surface”—and slow down when you have any doubt.

Remember: Any anti-lock braking system (ABS) helps avoid only the braking skid. Steer the way you want to go.



Driving at Night

Night driving is more dangerous than day driving. One reason is that some drivers are likely to be impaired—by alcohol or drugs, with night vision problems, or by fatigue.

Here are some tips on night driving.

- Drive defensively. Remember, this is the most dangerous time.
- Don't drink and drive. (See the *Index* under *Drunken Driving* for more on this problem.)
- Adjust your inside rearview mirror to reduce the glare from headlights behind you.

Your Driving and the Road

Driving at Night (CONT.)

- Since you can't see as well, you may need to slow down and keep more space between you and other vehicles. It's hard to tell how fast the vehicle ahead is going just by looking at its taillights.
- Slow down, especially on higher speed roads. Your headlights can light up only so much road ahead.
- In remote areas, watch for animals.
- If you're tired, pull off the road in a safe place and rest.

Night Vision

No one can see as well at night as in the daytime. But as we get older these differences increase. A 50-year-old driver may require at least twice as much light to see the same thing at night as a 20-year-old.

What you do in the daytime can also affect your night vision. For example, if you spend the day in bright sunshine you are wise to wear sunglasses. Your eyes will have less trouble adjusting to night.

But if you're driving, don't wear sunglasses at night. They may cut down on glare from headlights, but they also make a lot of things invisible that should remain visible—such as parked cars, obstacles, pedestrians, or even trains blocking railway crossings. You may want to put on your sunglasses after you have pulled into a brightly-lighted service or refreshment area. Eyes

shielded from that glare may adjust more quickly to darkness back on the road. But be sure to remove your sunglasses before you leave the service area.

You can be temporarily blinded by approaching lights. It can take a second or two, or even several seconds, for your eyes to readjust to the dark. When you are faced with severe glare (as from a driver who doesn't lower the high beams, or a vehicle with misaimed headlights), slow down a little. Avoid staring directly into the approaching lights. If there is a line of opposing traffic, make occasional glances over the line of headlights to make certain that one of the vehicles isn't starting to move into your lane. Once you are past the bright lights, give your eyes time to readjust before resuming speed.

High Beams

If the vehicle approaching you has its high beams on, signal by flicking yours to high and then back to low beam. This is the usual signal to lower the headlight beams. If the other driver still doesn't lower the beams, resist the temptation to put your high beams on. This only makes two half-blinded drivers.

On a freeway, use your high beams only in remote areas where you won't impair approaching drivers. In some places, like cities, using high beams is illegal.

When you follow another vehicle on a freeway or highway, use low beams. True, most vehicles now have day-night mirrors that enable the driver to reduce glare. But outside mirrors are not of this type and high beams from behind can bother the driver ahead.

A Few More Night Driving Suggestions

Keep your windshield and all the glass on your vehicle clean—inside and out. Glare at night is made much worse by dirt on the glass. Even the inside of the glass can build up a film caused by dust. Tobacco smoke also makes inside glass surfaces very filmy and can be a vision hazard if it's left there.

Dirty glass makes lights dazzle and flash more than clean glass would, making the pupils of your eyes contract repeatedly. You might even want to keep a cloth and some glass cleaner in your vehicle if you need to clean your glass frequently.

Remember that your headlights light up far less of a roadway when you are in a turn or curve.

Keep your eyes moving; that way, it's easier to pick out dimly lighted objects.

Just as your headlights should be checked regularly for proper aim, so should your eyes be examined regularly. Some drivers suffer from night blindness—the inability to see in dim light—and aren't even aware of it.

Your Driving and the Road



Driving in the Rain

Rain and wet roads can mean driving trouble. On a wet road you can't stop, accelerate or turn as well because your tire-to-road traction isn't as good as on dry roads. And, if your tires don't have much tread left, you'll get even less traction.

It's always wise to go slower and be cautious if rain starts to fall while you are driving. The surface may get wet suddenly when your reflexes are tuned for driving on dry pavement.

The heavier the rain, the harder it is to see. Even if your windshield wiper blades are in good shape, a heavy rain can make it harder to see road signs and traffic signals, pavement markings, the edge of the road, and even people

walking. Road spray can often be worse for vision than rain, especially if it comes from a dirty road.

So it is wise to keep your wiping equipment in good shape and keep your windshield washer tank filled. Replace your windshield wiper inserts when they show signs of streaking or missing areas on the windshield, or when strips of rubber start to separate from the inserts.



Driving too fast through large water puddles or even going through some car washes can cause problems, too. The water may affect your brakes. Try to avoid puddles. But if you can't, try to slow down before you hit them.

CAUTION



Wet brakes can cause accidents. They won't work well in a quick stop and may cause pulling to one side. You could lose control of the vehicle.

After driving through a large puddle of water or a car wash, apply your brake pedal lightly until your brakes work normally.

Hydroplaning

Hydroplaning is dangerous. So much water can build up under your tires that they can actually ride on the water. This can happen if the road is wet enough and you're going fast enough. When your vehicle is hydroplaning, it has little or no contact with the road.

You might not be aware of hydroplaning. You could drive along for some time without realizing your tires aren't in constant contact with the road. You could find out the hard way: when you have to slow, turn, move out to pass—or if you get hit by a gust of wind. You could suddenly find yourself out of control.

Hydroplaning doesn't happen often. But it can if your tires haven't much tread or if the pressure in one or more is low. It can happen if a lot of water is standing on the road. If you can see reflections from trees, telephone poles, or other vehicles, and raindrops "dimple" the water's surface, there could be hydroplaning.

Hydroplaning usually happens at higher speeds. There just isn't a hard and fast rule about hydroplaning. The best advice is to slow down when it is raining, and be careful.

Some Other Rainy Weather Tips

- Turn on your headlights—not just your parking lights—to help make you more visible to others.
- Look for hard-to-see vehicles coming from behind. You may want to use your headlights even in daytime if it's raining hard.
- Besides slowing down, allow some extra following distance. And be especially careful when you pass another vehicle. Allow yourself more clear room ahead, and be prepared to have your view restricted by road spray. If the road spray is so heavy you are actually blinded, drop back. Don't pass until conditions improve. Going more slowly is better than having an accident.
- Use your defogger if it helps.
- Have good tires with proper tread depth. (See the *Index* under *Tires*.)

Your Driving and the Road



Driving in Fog, Mist and Haze

Fog can occur with high humidity or heavy frost. It can be so mild that you can see through it for several hundred feet (meters). Or it might be so thick that you can see only a few feet (meters) ahead. It may come suddenly to an otherwise clear road. And it can be a major hazard.

When you drive into a fog patch, your visibility will be reduced quickly. The biggest dangers are striking the vehicle ahead or being struck by the one behind. Try to “read” the fog density down the road. If the vehicle ahead starts to become less clear or, at night, if the taillights are harder to see, the fog is probably thickening. Slow down to give traffic behind you a chance to slow down.

Everybody then has a better chance to avoid hitting the vehicle ahead.

A patch of dense fog may extend only for a few feet (meters) or for miles (kilometers); you can't really tell while you're in it. You can only treat the situation with extreme care.

One common fog condition—sometimes called mist or ground fog—can happen in weather that seems perfect, especially at night or in the early morning in valley and low, marshy areas. You can be suddenly enveloped in thick, wet haze that may even coat your windshield. You can often spot these fog patches or mist layers with your headlights. But sometimes they can be waiting for you as you come over a hill or dip into a shallow valley. Start your windshield wipers and washer to help clear accumulated road dirt. Slow down carefully.

Tips on Driving in Fog

If you get caught in fog, turn your headlights on low beam, even in daytime. You'll see—and be seen—better. Use your fog lights.

Don't use your high beams. The light will bounce off the water droplets that make up fog and reflect back at you.

Use your defogger. In high humidity, even a light buildup of moisture on the inside of the glass will cut down on your already limited visibility. Run your windshield wipers and washer occasionally. Moisture can build up on the outside glass, and what seems to be fog may actually be moisture on the outside of your windshield.

Treat dense fog as an emergency. Try to find a place to pull off the road. Of course you want to respect another's property, but you might need to put



City Driving

One of the biggest problems with city streets is the amount of traffic on them. You'll want to watch out for what the other drivers are doing and pay attention to traffic signals.

Here are ways to increase your safety in city driving:

- Know the best way to get to where you are going. Try not to drive around trying to pick out a familiar street or landmark. Get a city map and plan your trip into an unknown part of the city just as you would for a cross-country trip.
- Try to use the freeways that rim and crisscross most large cities. You'll save time and energy. (See the next section, *Freeway Driving*.)

something between you and moving vehicles—space, trees, telephone poles, a private driveway, anything that removes you from other traffic.

If visibility is near zero and you must stop but are unsure whether you are away from the road, turn your lights on, start your hazard warning flashers, and sound your horn at intervals or when you hear approaching traffic.

Pass other vehicles in fog only if you can see far enough ahead to pass safely. Even then, be prepared to delay your pass if you suspect the fog is worse up ahead. If other vehicles try to pass you, make it easy for them.

- Treat a green light as a warning signal. A traffic light is there because the corner is busy enough to need it. When a light turns green, and just before you start to move, check both ways for vehicles that have not cleared the intersection or may be running the red light.
- Obey all posted speed limits. But remember that they are for ideal road, weather and visibility conditions. You may need to drive below the posted limit in bad weather or when visibility is especially poor.
- Pull to the right (with care) and stop clear of intersections when you see or hear emergency vehicles.

Your Driving and the Road



Freeway Driving

Mile for mile, freeways (also called thruways, parkways, expressways, turnpikes, or superhighways) are the safest of all roads. But they have their own special rules.

The most important advice on freeway driving is: Keep up with traffic and keep to the right. Drive at the same speed most of the other drivers are driving. Too-fast or too-slow driving breaks a smooth traffic flow. Treat the left lane on a freeway as a passing lane.

Entering the Freeway

At the entrance there is usually a ramp that leads to the freeway. If you have a clear view of the freeway as you drive along the entrance ramp, you should begin to check traffic. Try to determine where you expect to blend with the flow. If traffic is light, you may have no problem. But if it is heavy, find a gap as you move along the entering lane and time your approach. Try to merge into the gap at close to the prevailing speed. Switch on your turn signal, check your rearview mirrors as you move along, and glance over your shoulder as often as necessary. Try to blend smoothly with the traffic flow.

Driving on the Freeway

Once you are on the freeway, adjust your speed to the posted limit or to the prevailing rate if it's slower. Stay in the right lane unless you want to pass. If you are on a two-lane freeway, treat the right lane as the slow lane and the left lane as the passing lane.

If you are on a three-lane freeway, treat the right lane as the slower-speed through lane, the middle lane as the higher-speed through lane, and the left lane as the passing lane.

Before changing lanes, check your rearview mirrors. Then use your turn signal. Just before you leave the lane, glance quickly over your shoulder to make sure there isn't another vehicle in your "blind" spot.

If you are moving from an outside to a center lane on a freeway having more than two lanes, make sure another vehicle isn't about to move into the same spot. Look at the vehicles two lanes over and watch for telltale signs: turn signals flashing, an increase in speed, or moving toward the edge of the lane. Be prepared to delay your move.

Once you are moving on the freeway, make certain you allow a reasonable following distance. Expect to move slightly slower at night.

Leaving the Freeway

When you want to leave the freeway, move to the proper lane well in advance. Dashing across lanes at the last minute is dangerous. If you miss your exit do not, under any circumstances, stop and back up. Drive on to the next exit.

At each exit point is a deceleration lane. Ideally it should be long enough for you to enter it at freeway speed (after signaling, of course) and then do your braking before moving onto the exit ramp. Unfortunately, not all deceleration lanes are long enough—some are too short for all the braking. Decide when to start braking. If you must brake on the through lane, and if there is traffic close behind you, you can allow a little

extra time and flash your brake lights (in addition to your turn signal) as extra warning that you are about to slow down and exit.

The exit ramp can be curved, sometimes quite sharply. The exit speed is usually posted. Reduce your speed according to your speedometer, not to your sense of motion. After driving for any distance at higher speeds, you may tend to think you are going slower than you actually are. For example, 40 mph (65 km/h) might seem like only 20 mph (32 km/h). Obviously, this could lead to serious trouble on a ramp designed for 20 mph (32 km/h)!

Your Driving and the Road

Driving a Long Distance

Although most long trips today are made on freeways, there are still many made on regular highways.

Long-distance driving on freeways and regular highways is the same in some ways. The trip has to be planned and the vehicle prepared, you drive at higher-than-city speeds, and there are longer turns behind the wheel. You'll enjoy your trip more if you and your vehicle are in good shape. Here are some tips for a successful long trip.

Before Leaving on a Long Trip

Make sure you're ready. Try to be well rested. If you must start when you're not fresh—such as after a day's work—don't plan to make too many miles that first part of the journey. Wear comfortable clothing and shoes you can easily drive in.

Is your vehicle ready for a long trip? If you keep it serviced and maintained, it's ready to go. If it needs service, have it done before starting out. Of course, you'll find experienced and able service experts in Pontiac dealerships all across North America. They'll be ready and willing to help if you need it.

Here are some things you can check before a trip:

- **Windshield Washer Fluid:** Is the reservoir full? Are all windows clean inside and outside?
- **Wiper Blades:** Are they in good shape?
- **Fuel, Engine Oil, Other Fluids:** Have you checked all levels?
- **Lights:** Are they all working? Are the lenses clean?
- **Tires:** They are vitally important to a safe, trouble-free trip. Is the tread good enough for long-distance driving? Are the tires all inflated to the recommended pressure?
- **Weather Forecasts:** What's the weather outlook along your route? Should you delay your trip a short time to avoid a major storm system?
- **Maps:** Do you have up-to-date maps?

On the Road

Unless you are the only driver, it is good to share the driving task with others. Limit turns behind the wheel to about 100 miles (160 km) or two hours at a sitting. Then, either change drivers or stop for some refreshment like coffee, tea or soft drinks and some limbering up. But do stop and move around. Eat lightly along the way. Heavier meals tend to make some people sleepy.

On two-lane highways or undivided multilane highways that do not have controlled access, you'll want to watch for some situations not usually found on freeways. Examples are: stop signs and signals, shopping centers with direct access to the highway, no passing zones and school zones, vehicles turning left and right off the road, pedestrians, bicyclists, parked vehicles, and even animals.

Highway Hypnosis

Is there actually such a condition as "highway hypnosis"? Or is it just plain falling asleep at the wheel? Call it highway hypnosis, lack of awareness, or whatever.

There is something about an easy stretch of road with the same scenery, along with the hum of the tires on the road, the drone of the engine, and the rush of the wind against the vehicle that can make you sleepy. Don't let it happen to you! If it does, your vehicle can leave the road in **less than a second**, and you could crash and be injured.

What can you do about highway hypnosis? First, be aware that it can happen.

Then here are some tips:

- Make sure your vehicle is well ventilated, with a comfortably cool interior.

- Keep your eyes moving. Scan the road ahead and to the sides. Check your rearview mirrors frequently and your instruments from time to time. This can help you avoid a fixed stare.

- Wear good sunglasses in bright light. Glare can cause drowsiness. But don't wear sunglasses at night. They will drastically reduce your overall vision at the very time you need all the seeing power you have.

- If you get sleepy, pull off the road into a rest, service, or parking area and take a nap, get some exercise, or both. For safety, treat drowsiness on the highway as an emergency.

As in any driving situation, keep pace with traffic and allow adequate following distances.

Your Driving and the Road

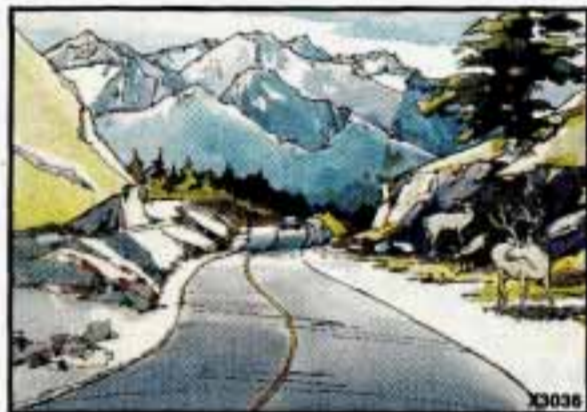

Hill and Mountain Roads

Driving on steep hills or mountains is different from driving in flat or rolling terrain. If you drive regularly in steep country, or if you're planning to visit there, here are some tips that can make your trips safer and more enjoyable.

- Keep your vehicle in good shape. Check all fluid levels and also the brakes, tires, cooling system and transaxle. These parts can work hard on mountain roads.
- Know how to go down hills. The most important thing to know is this: let your engine do some of the slowing down. Don't make your brakes do it all. Shift to a lower gear when you go down a steep or long hill. That way, you will slow down without excessive use of your brakes.

CAUTION



If you don't shift down, your brakes could get so hot that they wouldn't work well. You would then have poor braking or even none going down a hill. You could crash. Shift down to let your engine assist your brakes on a steep downhill slope.

CAUTION



Coasting downhill in N (Neutral) or with the ignition off is dangerous. Your brakes will have to do all the work of slowing down. They could get so hot that they wouldn't work well. You could crash. Always have your engine running and your vehicle in gear when you go downhill.

- Know how to go uphill. Shift down to D (Drive). This will help cool your engine and transaxle, and you can climb the hill better.
- Stay in your own lane when driving on two-lane roads in hills or mountains. Don't swing wide or cut across the center of the road. Drive at speeds that let you stay in your own lane. That way, you won't be surprised by a vehicle coming toward you in the same lane.
- It takes longer to pass another vehicle when you're going uphill. You'll want to leave extra room to pass. If a vehicle is passing you and doesn't have enough room, slow down to make it easier for the other vehicle to get by.



Parking on Hills

Hills and mountains mean spectacular scenery. But please be careful where you stop if you decide to look at the view or take pictures. Look for pull-offs or parking areas provided for scenic viewing.

Another part of this manual tells how to use your parking brake (see the *Index* under *Parking Brake*). But on a mountain or steep hill, you can do one more thing. You can turn your front wheels to keep your vehicle from rolling downhill or out into traffic.

Here's how:



Parking Downhill

Turn your wheels to the right.

You don't have to jam your tires against the curb, if there is a curb. A gentle contact is all you need.

- As you go over the top of a hill, be alert. There could be something in your lane, like a stalled car or an accident.
- You may see highway signs on mountains that warn of special problems. Examples are long grades, passing or no passing zones, a falling rocks area, or winding roads. Be alert to these and take appropriate action.
- Winter driving can present special problems. See the *Index* under *Winter Driving*.

Your Driving and the Road



Parking on Hills (CONT.)

Parking Uphill

If there is a curb, turn your wheels to the left if the curb is at the right side of your vehicle.



If you're going uphill on a one-way street and you're parking on the left side, your wheels should point to the right.



If there is no curb when you're parking uphill, turn the wheels to the right.

If there is no curb when you're parking uphill on the left side of a one-way street, your wheels should be turned to the left.



Torque Lock

If you are parking on a hill and you don't shift your transaxle into **P** (Park) properly, the weight of the vehicle may put too much force on the parking pawl in the transaxle. You may find it difficult to pull the shift lever out of **P** (Park). This is called "torque lock." To prevent torque lock, always be sure to shift into **P** (Park) properly before you leave the driver's seat. To find out how, see the *Index* under *Shifting Into P (Park)*.

When you are ready to drive, move the shift lever out of **P** (Park) **before** you release the parking brake.

If torque lock does occur, you may need to have another vehicle push yours a little uphill to take some of the pressure from the transaxle, so you can pull the shift lever out of **P** (Park).

Winter Driving

Here are some tips for winter driving:

- Have your Pontiac in good shape for winter. Be sure your engine coolant mix is correct.
- Snow tires can help in loose snow, but they may give you less traction on ice than regular tires. If you do not expect to be driving in deep snow, but may have to travel over ice, you may not want to switch to snow tires at all.

- You may want to put winter emergency supplies in your trunk. Include an ice scraper, a small brush or broom, a supply of windshield washer fluid, a rag, some winter outer clothing, a small shovel, a flashlight, a red cloth, and a couple of reflective warning triangles. And, if you will be driving under severe conditions, include a small bag of sand, a piece of old carpet or a couple of burlap bags to help provide traction. Be sure you properly secure these items in your vehicle.

Your Driving and the Road



Driving on Snow or Ice

Most of the time, those places where your tires meet the road probably have good traction.

However, if there is snow or ice between your tires and the road, you can have a very slippery situation. You'll have a lot less traction or "grip" and will need to be very careful.

What's the worst time for this? "Wet ice." Very cold snow or ice can be slick and hard to drive on. But wet ice can be even more trouble because it may offer the least traction of all. You can get "wet" ice when it's about freezing (32°F; 0°C) and freezing rain begins to fall. Try to avoid driving on wet ice until salt and sand crews can get there.

Whatever the condition—smooth ice, packed, blowing or loose snow—drive with caution. Accelerate gently. Try not to break the fragile traction. If you accelerate too fast, the drive wheels will spin and polish the surface under the tires even more. If you have the traction control system, it will improve your ability to accelerate when driving on a slippery road. Even though your vehicle has a traction control system, you'll want to slow down and adjust your driving to the road conditions. See the *Index* under *Traction Control*.

Your anti-lock brakes improve your ability to make a hard stop on a slippery road. Even though you have the anti-lock braking system, you'll want to begin stopping sooner than you would

on dry pavement. See the *Index* under *Anti-Lock Brake System*.

- Allow greater following distance on any slippery road.
- Watch for slippery spots. The road might be fine until you hit a spot that's covered with ice. On an otherwise clear road, ice patches may appear in shaded areas where the sun can't reach: around clumps of trees, behind buildings, or under bridges. Sometimes the surface of a curve or an overpass may remain icy when the surrounding roads are clear. If you see a patch of ice ahead of you, brake before you are on it. Try not to brake while you're actually on the ice, and avoid sudden steering maneuvers.



If You're Caught in a Blizzard

If you are stopped by heavy snow, you could be in a serious situation. You should probably stay with your vehicle unless you know for sure that you are near help and you can hike through the snow. Here are some things to do to summon help and keep yourself and your passengers safe:

- Turn on your hazard flashers.
- Tie a red cloth to your vehicle to alert police that you've been stopped by the snow.

- Put on extra clothing or wrap a blanket around you. If you have no blankets or extra clothing, make body insulators from newspapers, burlap bags, rags, floor mats—anything you can wrap around yourself or tuck under your clothing to keep warm.
- You can run the engine to keep warm, but be careful.



CAUTION



Snow can trap exhaust gases under your vehicle. This can cause deadly CO (carbon monoxide) gas to get inside. CO could overcome you and kill you. You can't see it or smell it, so you might not know it was in your vehicle. Clear away snow from around the base of your vehicle, especially any that is blocking your exhaust pipe. And check around again from time to time to be sure snow doesn't collect there.

Open a window just a little on the side of the vehicle that's away from the wind. This will help keep CO out.

Your Driving and the Road

If You're Caught in a Blizzard ***(CONT.)***

Run your engine only as long as you must. This saves fuel. When you run the engine, make it go a little faster than just idle. That is, push the accelerator slightly. This uses less fuel for the heat that you get and it keeps the battery charged. You will need a well-charged battery to restart the vehicle and possibly for signaling later on with your headlights. Let the heater run for a while.

Then, shut the engine off and close the window almost all the way to preserve the heat. Start the engine again and repeat this only when you feel really uncomfortable from the cold. But do it as little as possible. Preserve the fuel as long as you can.

To help keep warm, you can get out of the vehicle and do some fairly vigorous exercises every half-hour or so until help comes.

If You're Stuck in Deep Snow

This manual explains how to get the vehicle out of deep snow without damaging it. See the *Index* under *Rocking Your Vehicle*.

Towing a Trailer

CAUTION



If you don't use the correct equipment and drive properly, you can lose control when you pull a trailer. For example, if the trailer is too heavy, the brakes may not work well—or even at all. You and your passengers could be seriously injured. Pull a trailer only if you have followed all the steps in this section.

NOTICE

Pulling a trailer improperly can damage your vehicle and result in costly repairs not covered by your warranty. To pull a trailer correctly, follow the advice in this section.

Your Pontiac can tow a trailer, unless it is equipped with the 3800 Supercharged Engine (Code 1). Do not attempt to tow a trailer if equipped with the 3800 Supercharged Engine (Code 1). To identify what the vehicle trailering capacity is for your vehicle, you should read the information in *Weight of the Trailer* that appears later in this section. But trailering is different than just driving your vehicle by itself. Trailering means changes in handling, durability, and fuel economy. Successful, safe

trailering takes correct equipment, and it has to be used properly.

That's the reason for this section. In it are many time-tested, important trailering tips and safety rules. Many of these are important for your safety and that of your passengers. So please read this section carefully before you pull a trailer.

Load-pulling components such as the engine, transaxle, wheel assemblies, and tires are forced to work harder against the drag of the added weight. The engine is required to operate at relatively higher speeds and under greater loads, generating extra heat. What's more, the trailer adds considerably to wind resistance, increasing the pulling requirements.

Your Driving and the Road

If You Do Decide to Pull a Trailer

If you do, here are some important points.

- There are many different laws having to do with trailering. Make sure your rig will be legal, not only where you live but also where you'll be driving. A good source for this information can be state or provincial police.
- Consider using a sway control if your trailer will weigh 2,000 pounds (900 kg) or less. You should always use a sway control if your trailer will weigh more than 2,000 pounds (900 kg). You can ask a hitch dealer about sway controls.
- Don't tow a trailer at all during the first 500 miles (804 km) your new vehicle is driven. Your engine, axle or other parts could be damaged.

- Then, during the first 500 miles (804 km) that you tow a trailer, don't drive over 50 mph (80 km/h) and don't make starts at full throttle. This helps your engine and other parts of your vehicle wear in at the heavier loads.
- Three important considerations have to do with weight:

Weight of the Trailer

How heavy can a trailer safely be? It should never weigh more than 1,000 pounds (450 kg) unless you have the special optional 3,000 pound (1 360 kg) towing package. But even that can be too heavy. It depends on how you plan to use your rig. For example, speed, altitude, road grades, outside temperature and how much your vehicle is used to pull a trailer are all important. And, it can also depend on any special equipment that you have on your vehicle. You can ask your dealer for our trailering information or advice, or write us at:

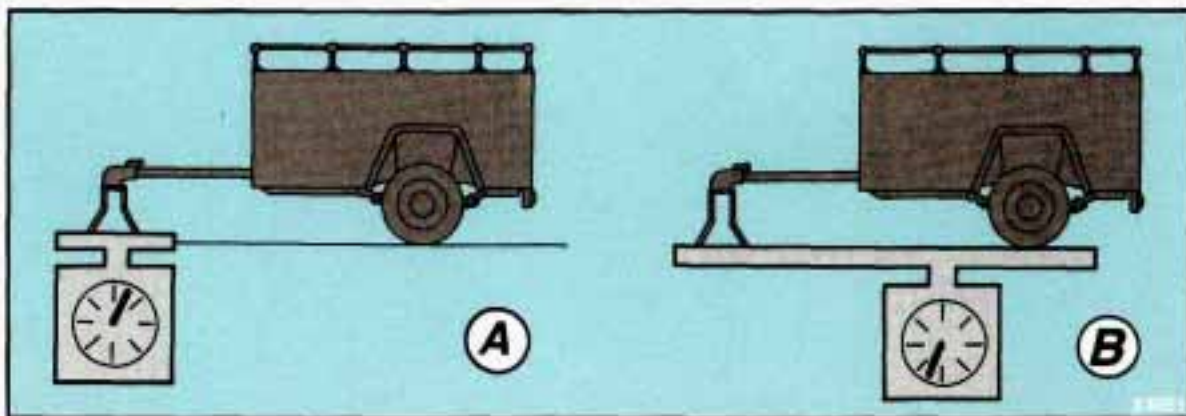

Pontiac Customer Services
Department
One Pontiac Plaza
Pontiac, Michigan 48340-2952

In Canada, write to:

General Motors of Canada Limited
Customer Assistance Center
1908 Colonel Sam Drive
Oshawa, Ontario, L1H 8P7

Weight of the Trailer Tongue

The tongue load (A) of any trailer is an important weight to measure because it affects the total, gross weight of your vehicle. The gross vehicle weight (GVW) includes the curb weight of the vehicle, any cargo you may carry in it, and the people who will be riding in the vehicle. And if you will tow a trailer, you must add the tongue load to the GVW because your vehicle will be carrying that weight, too. See the *Index* under *Loading Your Vehicle* for more information about your vehicle's maximum load capacity.

If your vehicle is **not** equipped to tow a trailer weighing more than 2,000 pounds (900 kg), the trailer tongue (A) should weigh 10% of the total loaded trailer weight (B). If your vehicle **is** equipped with the optional 3,000 pound (1 360 kg) towing package, and you're using a "dead-weight" hitch, the trailer tongue (A) should weigh 10% of the total loaded trailer weight (B). Or, if you have a "weight-distributing" hitch, the trailer tongue (A) should weigh 12% of the total loaded trailer weight (B).

After you've loaded your trailer, weigh the trailer and then the tongue, separately, to see if the weights are proper. If they aren't, you may be able to get them right simply by moving some items around in the trailer.

Your Driving and the Road

If You Do Decide to Pull a Trailer (CONT.)

Total Weight on Your Vehicle's Tires

Be sure your vehicle's tires are inflated to the limit for cold tires. You will find these numbers on the Certification label at the rear edge of the driver's door (or, see the *Index* under *Tire Loading*). Then be sure you don't go over the GVW limit for your vehicle.

Hitches

It's important to have the correct hitch equipment. Crosswinds, large trucks going by, and rough roads are a few reasons why you'll need the right hitch. Here are some rules to follow:

- If you'll be pulling a trailer that, when loaded, will weigh more than 2,000 pounds (900 kg), be sure to use a properly mounted, weight-distributing hitch and sway control of the proper size. This equipment is very important for proper vehicle loading and good handling when you're driving.

- Will you have to make any holes in the body of your vehicle when you install a trailer hitch? If you do, then be sure to seal the holes later when you remove the hitch. If you don't seal them, deadly carbon monoxide (CO) from your exhaust can get into your vehicle. (See the *Index* under *Carbon Monoxide in Exhaust*.) Dirt and water can, too.
- The bumpers on your vehicle are not intended for hitches. Do not attach rental hitches or other bumper-type hitches to them. Use only a frame-mounted hitch that does not attach to the bumper.

Safety Chains

You should always attach chains between your vehicle and your trailer. Cross the safety chains under the tongue of the trailer so that the tongue will not drop to the road if it becomes separated from the hitch. Instructions about safety chains may be provided by the hitch manufacturer or by the trailer manufacturer. Follow the manufacturer's recommendation for attaching safety chains. Always leave just enough slack so you can turn with your rig. And, never allow safety chains to drag on the ground.

Trailer Brakes

If your trailer weighs more than 1000 pounds (450 kg) loaded, then it needs its own brakes—and they must be adequate. Be sure to read and follow the instructions for the trailer brakes so you'll be able to install, adjust and maintain them properly.

Because you have anti-lock brakes, do not try to tap into your vehicle's brake system. If you do, both brake systems won't work well, or at all.

Driving with a Trailer

Towing a trailer requires a certain amount of experience. Before setting out for the open road, you'll want to get to know your rig. Acquaint yourself with the feel of handling and braking with the added weight of the trailer. And always keep in mind that the vehicle you are driving is now a good deal longer and not nearly so responsive as your vehicle is by itself.

Before you start, check the trailer hitch and platform, safety chains, electrical connector, lights, tires and mirror adjustment. If the trailer has electric brakes, start your vehicle and trailer moving and then apply the trailer brake controller by hand to be sure the brakes are working. This lets you check your electrical connection at the same time. During your trip, check occasionally to be sure that the load is secure, and that the lights and any trailer brakes are still working.

Your Driving and the Road

Driving with a Trailer (CONT.)

Following Distance

Stay at least twice as far behind the vehicle ahead as you would when driving your vehicle without a trailer. This can help you avoid situations that require heavy braking and sudden turns.

Passing

You'll need more passing distance up ahead when you're towing a trailer. And, because you're a good deal longer, you'll need to go much farther beyond the passed vehicle before you can return to your lane.

Backing Up

Hold the bottom of the steering wheel with one hand. Then, to move the trailer to the left, just move that hand to the left. To move the trailer to the right, move your hand to the right. Always back up slowly and, if possible, have someone guide you.

Making Turns

When you're turning with a trailer, make wider turns than normal. Do this so your trailer won't strike soft shoulders, curbs, road signs, trees, or other objects. Avoid jerky or sudden maneuvers. Signal well in advance.

Turn Signals When Towing a Trailer

When you tow a trailer, your vehicle has to have a different turn signal flasher and extra wiring. The green arrows on your instrument panel will flash whenever you signal a turn or lane change. Properly hooked up, the trailer lights will also flash, telling other drivers you're about to turn, change lanes or stop.

When towing a trailer, the green arrows on your instrument panel will flash for turns even if the bulbs on the trailer are burned out. Thus, you may think drivers

behind you are seeing your signal when they are not. It's important to check occasionally to be sure the trailer bulbs are still working.

Vehicles with the optional Lamp Monitor System will warn you when a bulb burns out. But when you plug trailer lights into your vehicle's lighting system, its bulb warning lights may not let you know if one of your lights goes out. So, when you have trailer lights plugged in, be sure to check your vehicle and trailer lights from time to time to be sure they're all working. Once you disconnect the trailer lights, your Lamp Monitor System again can tell you if one of your vehicle lights is out.

Driving on Grades

Reduce speed and shift to a lower gear **before** you start down a long or steep downgrade. If you don't shift down, you might have to use your brakes so much that they would get hot and no longer work well.

On a long uphill grade, shift down to **D** (Drive) and reduce your speed to around 45 mph (70 km/h) to reduce the possibility of engine and transaxle overheating.

If you are towing a trailer that weighs more than 1,000 pounds (454 kg), and you have an automatic transaxle with Overdrive, it's best to drive in **D** instead of Overdrive (or, as you need to, a lower gear). This will minimize heat build-up and extend the life of your transaxle.

Parking on Hills

You really should not park your vehicle, with a trailer attached, on a hill. If something goes wrong, your rig could start to move. People can be injured, and both your vehicle and the trailer can be damaged.

But if you ever have to park your rig on a hill, here's how to do it:

1. Apply your regular brakes, but don't shift into **P** (Park) yet.
2. Have someone place chocks under the trailer wheels.
3. When the wheel chocks are in place, release the regular brakes until the chocks absorb the load.

4. Reapply the regular brakes. Then apply your parking brake, and then shift to **P** (Park).
5. Release the regular brakes.

When You Are Ready to Leave After Parking on a Hill

1. Apply your regular brakes and hold the pedal down while you:
 - Start your engine;
 - Shift into a gear; and
 - Release the parking brake.
2. Let up on the brake pedal.
3. Drive slowly until the trailer is clear of the chocks.
4. Stop and have someone pick up and store the chocks.

Your Driving and the Road

Maintenance When Trailer Towing

Your vehicle will need service more often when you're pulling a trailer. See the Maintenance Schedule for more on this. Things that are especially important in trailer operation are automatic transaxle fluid (don't overfill), engine oil, belts, cooling system, and brake adjustment. Each of these is covered in this manual, and the *Index* will help you find them quickly. If you're trailering, it's a good idea to review these sections before you start your trip.

Check periodically to see that all hitch nuts and bolts are tight.



Here you'll find out what to do about some problems that can occur on the road.

Part **5** **Problems on the Road**

Hazard Warning Flashers	192
Jump Starting	193
Towing Your Pontiac	197
Engine Overheating	202
If a Tire Goes Flat	208
Changing a Flat Tire	210
Compact Spare	217
If You're Stuck: In Sand, Mud, Ice or Snow	218

Problems on the Road



Hazard Warning Flashers

Your hazard warning flashers let you warn others. They also let police know you have a problem. Your front and rear turn signal lights will flash on and off.



Press the button in to make your front and rear turn signal lights flash on and off.

Your hazard warning flashers work no matter what position your key is in, and even if the key isn't in.



To turn off the flashers, pull out on the collar.

When the hazard warning flashers are on, your turn signals won't work.

Other Warning Devices

If you carry reflective triangles, you can set one up at the side of the road about 300 feet (100 m) behind your vehicle.

Jump Starting

If your battery has run down, you may want to use another vehicle and some jumper cables to start your Pontiac. But please follow the steps here to do it safely.

CAUTION



Batteries can hurt you. They can be dangerous because:

- They contain **acid** that can burn you.
- They contain **gas** that can explode or ignite.
- They contain enough **electricity** to burn you.

If you don't follow these steps exactly, some or all of these things can hurt you.

NOTICE

Ignoring these steps could result in costly damage to your vehicle that wouldn't be covered by your warranty.

Trying to start your Pontiac by pushing or pulling it won't work, and it could damage your vehicle.

To Jump Start Your Pontiac:

1. Check the other vehicle. It must have a 12-volt battery with a negative charge system.

NOTICE

If the other system isn't a 12-volt system with a negative ground, both vehicles can be damaged.

Problems on the Road

Jump Starting (CONT.)

2. Get the vehicles close enough so the jumper cables can reach, but be sure the vehicles aren't touching each other. If they are, it could cause a ground connection you don't want. You wouldn't be able to start your Pontiac, and the bad grounding could damage the electrical systems.

CAUTION



You could be injured if the vehicles roll. Set the parking brake firmly on each vehicle. Put an automatic transaxle in **P** (Park) or a manual transaxle in **N** (Neutral).

3. Turn off the ignition on both vehicles. Turn off all lights that aren't needed, and radios. This will avoid sparks and help save both batteries. And it could save your radio!

NOTICE

If you leave your radio on, it could be badly damaged. The repairs wouldn't be covered by your warranty.

4. Open the hoods and locate the batteries.

CAUTION



An electric fan can start up even when the engine is not running and can injure you. Keep hands, clothing and tools away from any underhood electric fan.

Find the positive (+) and negative (-) terminals on each battery.

CAUTION

 Using a match near a battery can cause battery gas to explode. People have been hurt doing this, and some have been blinded. Use a flashlight if you need more light.

Be sure the batteries have enough water. You don't need to add water to the Delco Freedom[®] battery installed in every new GM vehicle. But if a battery has filler caps, be sure the right amount of fluid is there. If it is low, add water to take care of that first. If you don't, explosive gas could be present.

Battery fluid contains acid that can burn you. Don't get it on you. If you accidentally get it in your eyes or on your skin, flush the place with water and get medical help immediately.

5. Check that the jumper cables don't have loose or missing insulation. If they do, you could get a shock. The vehicles could be damaged, too.

Before you connect the cables, here are some things you should know. Positive (+) will go to positive (+) and negative (-) will go to negative (-) or a metal engine part. Don't connect (+) to (-) or you'll get a short that would damage the battery and maybe other parts, too.

CAUTION

 Fans or other moving engine parts can injure you badly. Keep your hands away from moving parts once the engines are running.

Problems on the Road



Jump Starting (CONT.)

6. Connect the red positive (+) cable to the positive (+) terminal of the vehicle with the dead battery. Use a remote positive (+) terminal if the vehicle has one.



7. Don't let the other end touch metal. Connect it to the positive (+) terminal of the good battery. Use a remote positive (+) terminal if the vehicle has one.

8. Now connect the black negative (-) cable to the good battery's negative (-) terminal.

Don't let the other end touch anything until the next step. The other end of the negative cable **doesn't** go to the dead battery. It goes to a heavy unpainted metal part on the engine of the vehicle with the dead battery.



9. Attach the cable at least 18 inches (45 cm) away from the dead battery, but not near engine parts that move. The electrical connection is just as good there, but the chance of sparks getting back to the battery is much less.

10. Now start the vehicle with the good battery and run the engine for a while.

11. Try to start the vehicle with the dead battery. If it won't start after a few tries, it probably needs service.

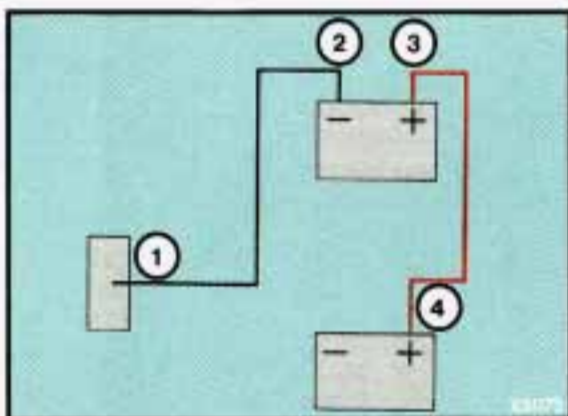

12. Remove the cables in reverse order to prevent electrical shorting. Take care that they don't touch each other or any other metal.

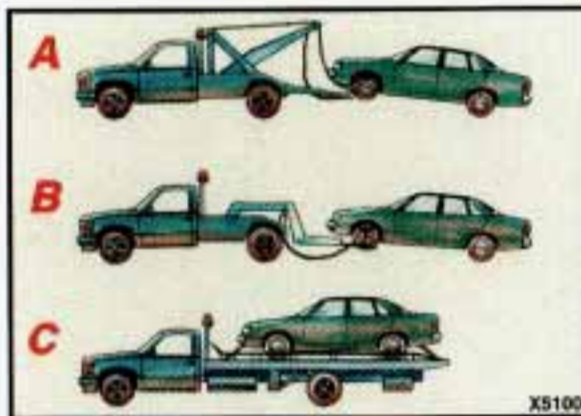

Towing Your Pontiac

Try to have a GM dealer or a professional towing service tow your Pontiac. The usual towing equipment is:

- (A) Sling-type tow truck
- (B) Wheel-lift tow truck
- (C) Car carrier

If your vehicle has been changed or modified since it was factory-new by adding aftermarket items like fog lamps, aero skirting, or special tires and wheels, these instructions and illustrations may not be correct.

Before you do anything, turn on the hazard warning flashers.

When you call, tell the towing service:

- That your vehicle can only be towed with certain equipment, as described later in this section.
- That your vehicle has front-wheel drive.
- The make, model, and year of your vehicle.
- Whether you can still move the shift lever.
- If there was an accident, what was damaged.

When the towing service arrives, let the tow operator know that this manual contains detailed towing instructions and illustrations. The operator may want to see them.

Problems on the Road

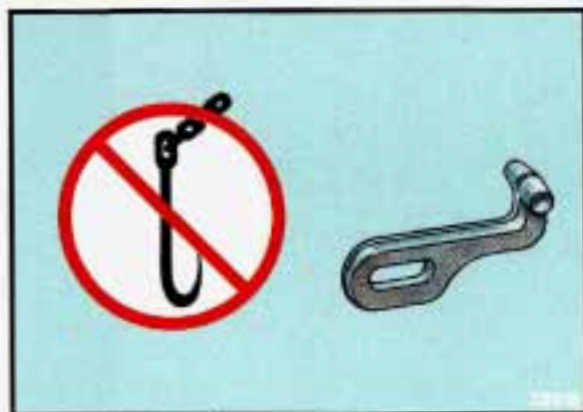

Towing Your Pontiac (CONT.)

CAUTION



To help avoid injury to you or others:

- Never let passengers ride in a vehicle that is being towed.
- Never tow faster than safe or posted speeds.
- Never tow with damaged parts not fully secured.
- Never get under your vehicle after it has been lifted by the tow truck.
- Always use separate safety chains on each side when towing a vehicle.
- Never use "J" hooks. Use T-hooks instead.

When your vehicle is being towed, have the ignition key off. The steering wheel should be clamped in a straight-ahead position, with a clamping device designed for towing service. Do not use the vehicle's steering column lock for this. The transaxle should be in Neutral and the parking brake released.

Don't have your vehicle towed on the front wheels, unless you must. If the vehicle must be towed on the front wheels, don't go more than 35 mph (56 km/h) or farther than 50 miles (80 km) or your transaxle will be damaged. If these limits must be exceeded, then the front wheels have to be supported on a dolly.

CAUTION



A vehicle can fall from a car carrier if it isn't properly secured. This can cause a collision, serious personal injury and vehicle damage. The vehicle should be tightly secured with chains or steel cables before it is transported.

Don't use substitutes (ropes, leather straps, canvas webbing, etc.) that can be cut by sharp edges underneath the towed vehicle.

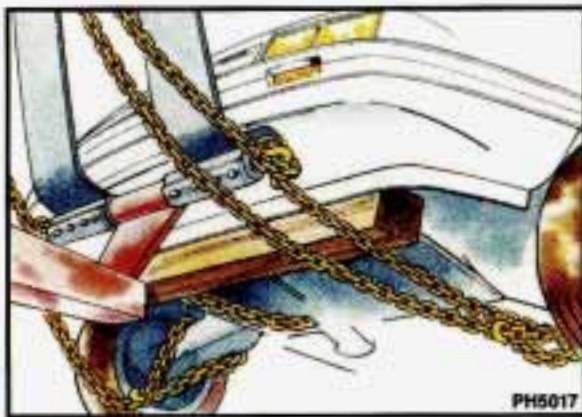

Towing from the Front— Vehicle Hook-up (EXCEPT SSE & SSEi)

Before hooking up to a tow truck, be sure to read all the information on *Towing Your Pontiac* earlier in this section.

1. Attach T-hook chains into the bottom slots in the cradle behind the front wheels, on both sides.

2. Across sling chains, position a 4x4 wood beam against bottom of radiator support behind the front bumper.

3. Attach a separate safety chain around the outboard end of each control arm.

Problems on the Road

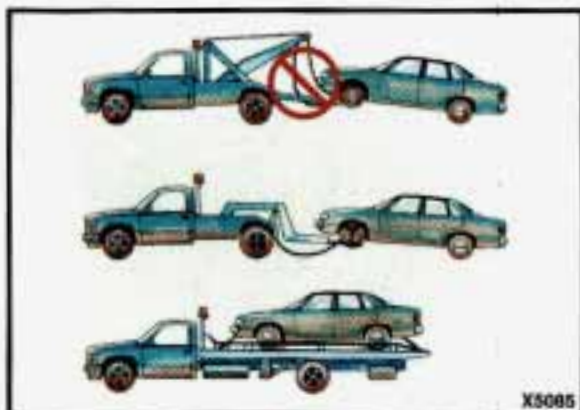

Towing from the Front— Vehicle Hook-up (SSE & SSEI ONLY)

Before hooking up to a tow truck, be sure to read all the information on *Towing Your Pontiac* earlier in this section.

NOTICE

Do not tow with sling-type equipment or fascia/fog light damage will occur. Use wheel-lift or car carrier equipment (additional ramping may be required for car carrier equipment). Use safety chains and wheel straps.



Attach a separate safety chain around the outboard end of each control arm.

NOTICE

To help avoid damaging a vehicle during a tow over rough surfaces, install a towing dolly beneath the wheels that would otherwise be on the ground during the tow. This will increase clearance between the wheel-lift equipment and the underbody of the towed vehicle.

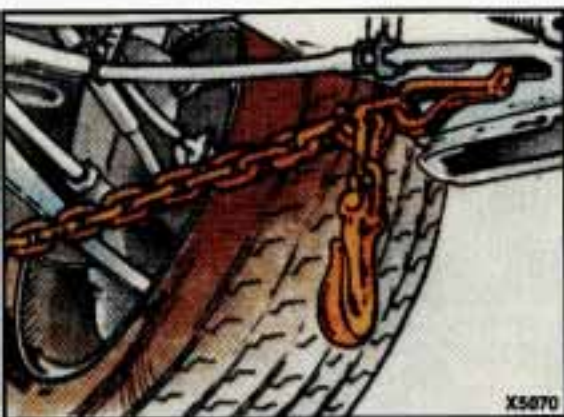

Towing from the Rear— Vehicle Hook-up (ALL)

Before hooking up to a tow truck, be sure to read all the information on *Towing Your Pontiac* earlier in this section.

1. Attach T-hook chains on both sides in the slotted holes in the floor pan support rails just ahead of the rear wheels.



2. Position the lower sling crossbar directly under the rear bumper.



3. Attach a separate safety chain around the outboard end of each lower control arm.

Problems on the Road



If Steam is Coming from Your Engine:

Engine Overheating

You will find a coolant temperature gage or the warning light about a hot engine on your Pontiac's instrument panel. See the *Index* under *Coolant Temperature Gage* and *Coolant Temperature Warning Light*.

NOTICE

If your engine catches fire because you keep driving with no coolant, your vehicle can be badly damaged. The costly repairs would not be covered by your warranty.

CAUTION



Steam from an overheated engine can burn you badly, even if you just open the hood. Stay away from the engine if you see or hear steam coming from it. Just turn it off and get everyone away from the vehicle until it cools down. Wait until there is no sign of steam or coolant before opening the hood. If you keep driving when your engine is overheated, the liquids in it can catch fire. You or others could be badly burned. Stop your engine if it overheats, and get out of the vehicle until the engine is cool.

If No Steam is Coming from Your Engine:

If you get the overheat warning but see or hear no steam, the problem may not be too serious. Sometimes the engine can get a little too hot when you:

- Climb a long hill on a hot day.
- Stop after high speed driving.
- Idle for long periods in traffic.
- Tow a trailer.

If you get the overheat warning with no sign of steam, try this for a minute or so:

1. Turn off your air conditioner.
2. Turn your heater to full hot at the highest blower speed and open the window as necessary.
3. If you're in a traffic jam, shift to N (Neutral).

If you no longer have the overheat warning, you can drive. Just to be safe, drive slower for about ten minutes. If the warning doesn't come back on, you can drive normally.

If the warning continues, pull over, stop, and park your vehicle right away.

If there's still no sign of steam, you can idle the engine for two or three minutes while you're parked, to see if the warning stops.

But then, if you still have the warning, **TURN OFF THE ENGINE AND GET EVERYONE OUT OF THE VEHICLE** until it cools down. You may decide not to lift the hood but to get service help right away.

Problems on the Road

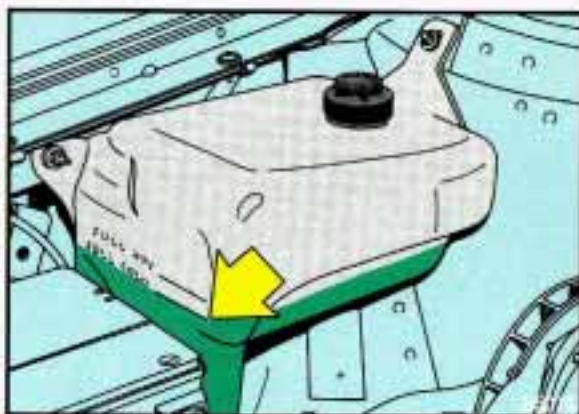
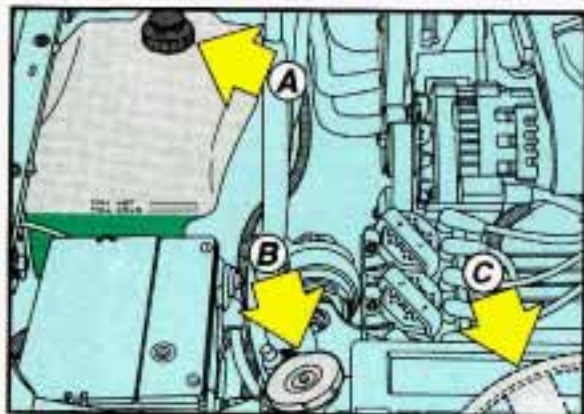

Engine Overheating (CONT.)

Cooling System

When you decide it's safe to lift the hood, here's what you'll see:

- (A) Coolant recovery tank
- (B) Radiator pressure cap
- (C) Electric engine fan

CAUTION



An electric fan under the hood can start up even when the engine is not running and can injure you. Keep hands, clothing and tools away from any underhood electric fan.

If the coolant inside the coolant recovery tank is boiling, don't do anything else until it cools down.

The coolant level should be at or above the **FULL COLD** mark. If it isn't, you may have a leak in the radiator hoses, heater hoses, radiator, water pump or somewhere else in the cooling system.

CAUTION



Heater and radiator hoses, and other engine parts, can be very hot. Don't touch them. If you do, you can be burned.

Don't run the engine if there is a leak. If you run the engine, it could lose all coolant. That could cause an engine fire, and you could be burned. Get any leak fixed before you drive the vehicle.

NOTICE

Engine damage from running your engine without coolant isn't covered by your warranty.

If there seems to be no leak, check to see if the electric engine fan is running. If the engine is overheating, the fan should be running. If it isn't, your vehicle needs service.

How to Add Coolant to the Coolant Recovery Tank:

If you haven't found a problem yet, but the coolant level isn't up to the **FULL COLD** mark, add a 50/50 mixture of **clean water** (preferably distilled) and a proper antifreeze at the coolant recovery tank. See the *Index* under *Coolant* for more information about the proper coolant mix.

CAUTION



Adding only plain water to your cooling system can be dangerous. Plain water, or some other liquid like alcohol, can boil before the proper coolant mix will. Your vehicle's coolant warning system is set for the proper coolant mix. With plain water or the wrong mix, your engine could get too hot but you wouldn't get the overheat warning. Your engine could catch fire and you or others could be burned. Use a 50/50 mix of **clean water** and a proper antifreeze.

NOTICE

In cold weather, water can freeze and crack the engine, radiator, heater core and other parts. Use the recommended coolant.

CAUTION



You can be burned if you spill coolant on hot engine parts. Coolant contains ethylene glycol and it will burn if the engine parts are hot enough. Don't spill coolant on a hot engine.

When the coolant in the coolant recovery tank is at or above **FULL COLD**, start your vehicle. If the overheat warning continues, there's one more thing you can try. You can add the proper coolant mix directly to the radiator, but be sure the cooling system is cool before you do it.

Problems on the Road



Engine Overheating (CONT.)

CAUTION

 Steam and scalding liquids from a hot cooling system can blow out and burn you badly. They are under pressure, and if you turn the radiator pressure cap—even a little—they can come out at high speed. Never turn the pressure cap when the cooling system, including the radiator pressure cap, is hot. Wait for the cooling system and radiator pressure cap to cool if you ever have to turn the pressure cap.

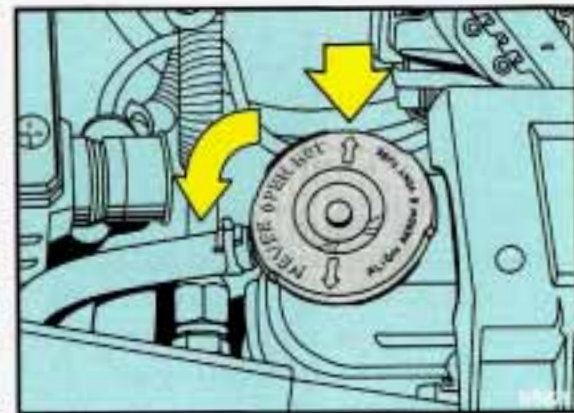
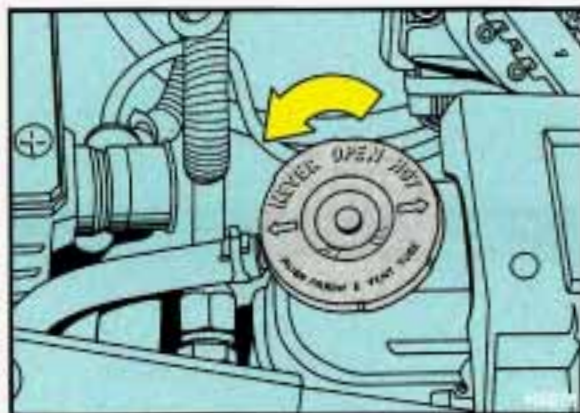

How to Add Coolant to the Radiator:

1. You can remove the radiator pressure cap when the cooling system, including the radiator pressure cap and upper radiator hose, is no longer hot. Turn the pressure cap slowly to the left until it first stops. (Don't press down while turning the pressure cap.)

If you hear a hiss, wait for that to stop. A hiss means there is still some pressure left.

2. Then keep turning the pressure cap, but now push down as you turn it. Remove the pressure cap.



3. Fill the radiator with the proper mix, up to the base of the filler neck.

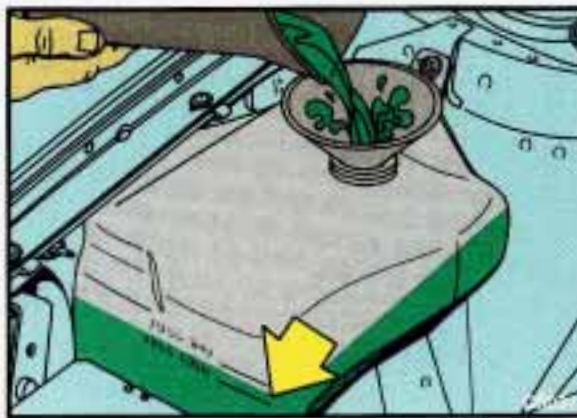

4. Then fill the coolant recovery tank to the **FULL COLD** mark.

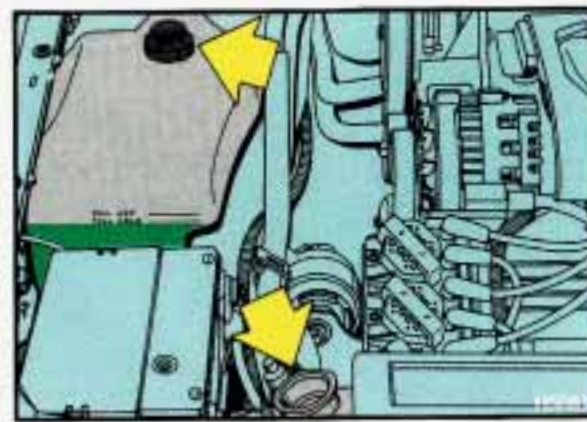

5. Put the cap back on the coolant recovery tank, but leave the radiator pressure cap off.

Problems on the Road



Engine Overheating (CONT.)

6. Start the engine and let it run until you can feel the upper radiator hose getting hot. Watch out for the engine fan.
7. By this time, the coolant level inside the radiator filler neck may be lower. If the level is lower, add more of the proper mix through the filler neck until the level reaches the base of the filler neck.

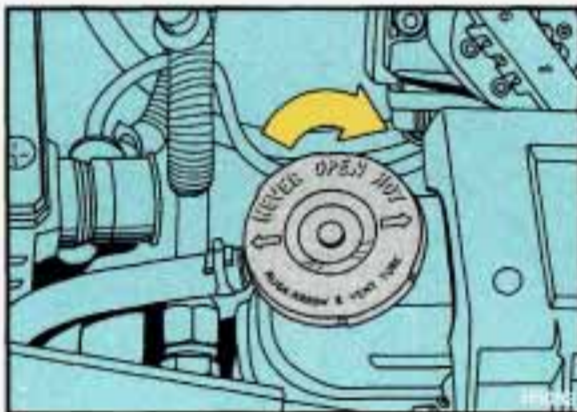

8. Then replace the pressure cap. Be sure the arrows on the pressure cap line up like this.

■ ***If a Tire Goes Flat***

It's unusual for a tire to "blow out" while you're driving, especially if you maintain your tires properly. If air goes out of a tire, it's much more likely to leak out slowly. But if you should ever have a "blowout," here are a few tips about what to expect and what to do:

If a front tire fails, the flat tire will create a drag that pulls the vehicle toward that side. Take your foot off the accelerator pedal and grip the steering wheel firmly. Steer to maintain lane position, then gently brake to a stop well out of the traffic lane.

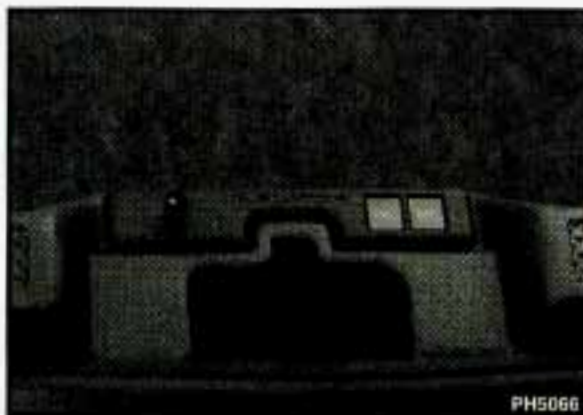

Air Inflator System

Some vehicles have an air inflator for use in bringing tires up to the proper pressure. The air inflator is located in the trunk. The **ON** switch will work even with the ignition off.

A rear blowout, particularly on a curve, acts much like a skid and may require the same correction you'd use in a skid. In any rear blowout, remove your foot from the accelerator pedal. Get the vehicle under control by steering the way you want the vehicle to go. It may be very bumpy and noisy, but you can still steer. Gently brake to a stop, well off the road if possible.

If your tire goes flat, the next section shows how to use your jacking equipment to change a flat tire safely.

The air inflator comes with a kit that includes a 20-foot hose and an air pressure gage, as well as instructions and special adapters for inflating things like an air mattress or basketball.

CAUTION



Inflating something too much can make it explode, and you or others could be injured. Be sure to read the inflator instructions, and inflate any object only to its recommended pressure.

Problems on the Road



Changing a Flat Tire

If a tire goes flat, avoid further tire and wheel damage by driving slowly to a level place. Turn on your hazard warning flashers.

CAUTION



Changing a tire can cause an injury. The vehicle can slip off the jack and roll over you or other people. You and they could be badly injured. Find a level place to change your tire. To help prevent the vehicle from moving:

1. Set the parking brake firmly.
2. Put the shift lever in **P** (Park).
3. Turn off the engine.

To be even more certain the vehicle won't move, you can put chocks at the front and rear of the tire farthest away from the one being changed. That would be the tire on the other side of the vehicle, at the opposite end.

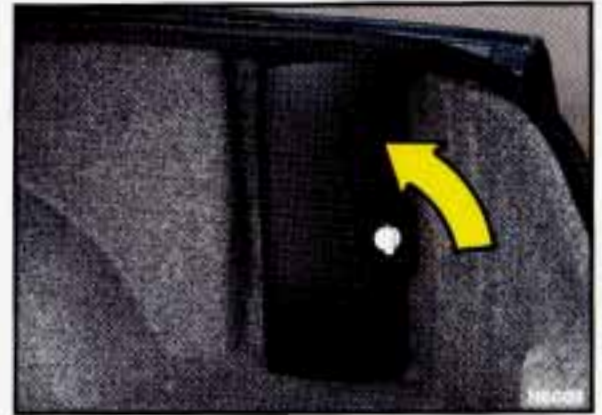

The following steps will tell you how to use the jack and change a tire. The equipment you'll need is in the trunk.

1. Turn the center retainer bolt on the spare tire cover counterclockwise to remove it, then lift the tire cover.
2. Remove the spare tire from the trunk.

3. Open the jack storage cover by twisting the knob $\frac{1}{4}$ turn counterclockwise.

Problems on the Road



Changing a Flat Tire (CONT.)

4. Remove the jack and wheel wrench.

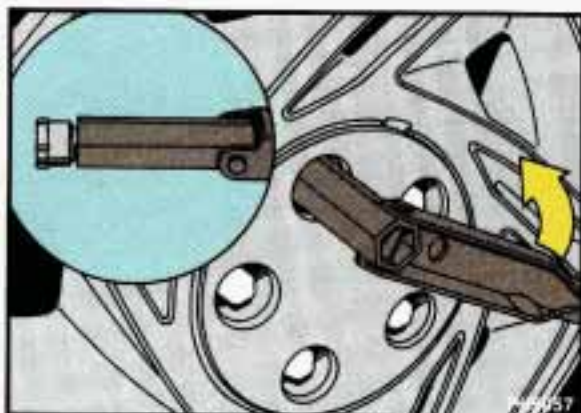

5. If you have wheel nut caps, remove them.

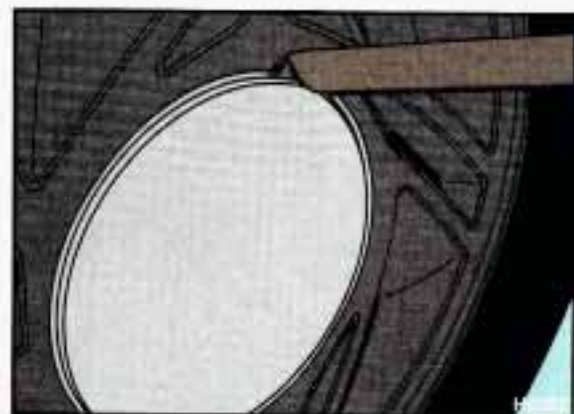

6. If you have aluminum wheels, remove the center cover that conceals the wheel nuts by using the flat end of the wheel wrench to pry it off. Do not drop the cover or lay it face down, as it could be scratched or damaged.

Do not use a hammer or mallet to install the cover.

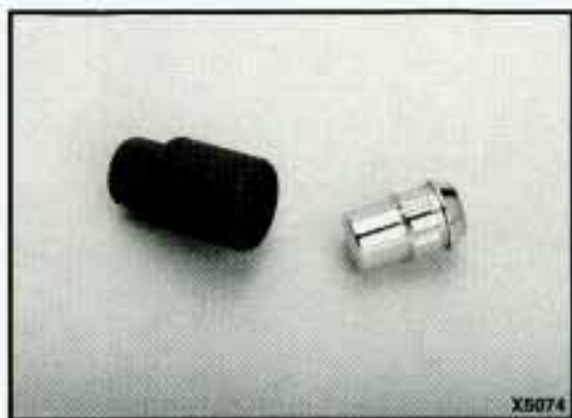

7. If your wheel has the special locking lug nut, use the special adapter supplied with your vehicle to remove the locking wheel nut by turning counterclockwise.

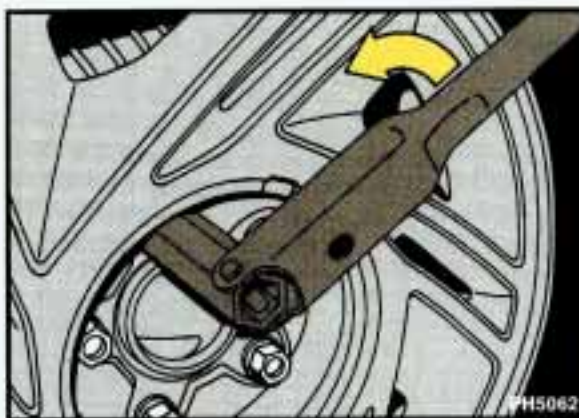

8. Use the wheel wrench to loosen the wheel nuts, but don't remove them.

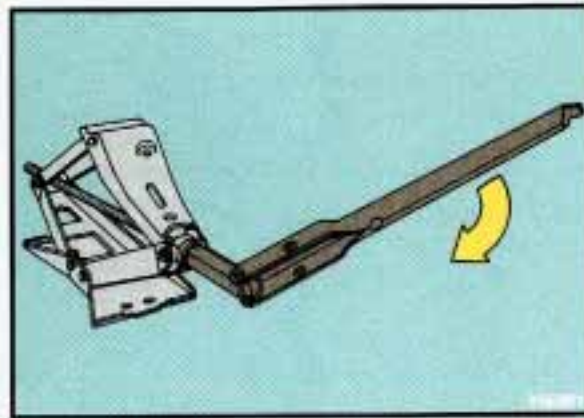

9. Attach the wheel wrench to the jack, and rotate the wrench clockwise to raise the jack head a few inches.

Problems on the Road

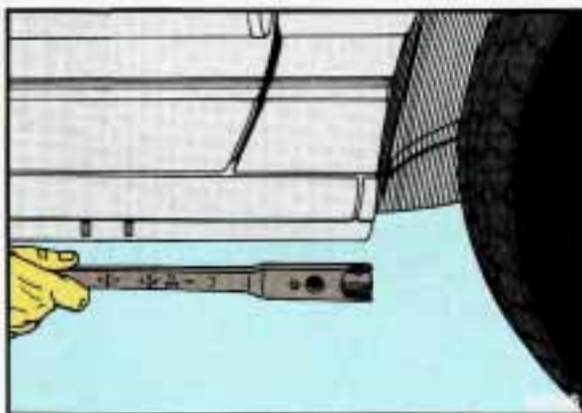

Changing a Flat Tire (CONT.)

10. Near each wheel well is a notch in the frame into which to put the jack head. The front notch is 10 inches back from the front wheel well. The rear notch is 8 inches forward from the rear wheel well. The wheel wrench has these 8 and 10 inch distances stamped on the handle. Use the wheel wrench to measure to the notch by flipping the socket into the handle, then measuring from the socket end of the wrench.

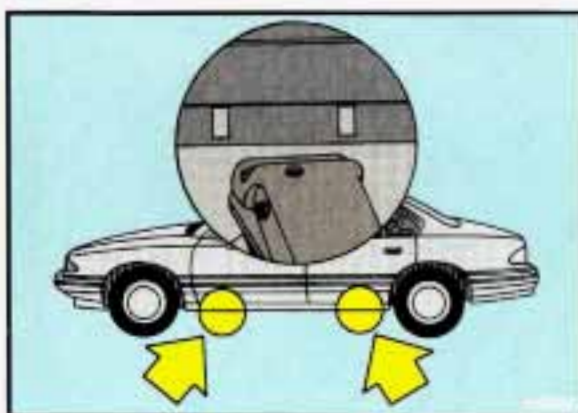

11. Position the jack and raise the jack head until it fits firmly on the ridge in the vehicle's frame nearest the flat tire. Do not raise the vehicle yet. Put the compact spare tire near you.

CAUTION

 Getting under a vehicle when it is jacked up is dangerous. If the vehicle slips off the jack, you could be badly injured or killed. Never get under a vehicle when it is supported only by a jack.

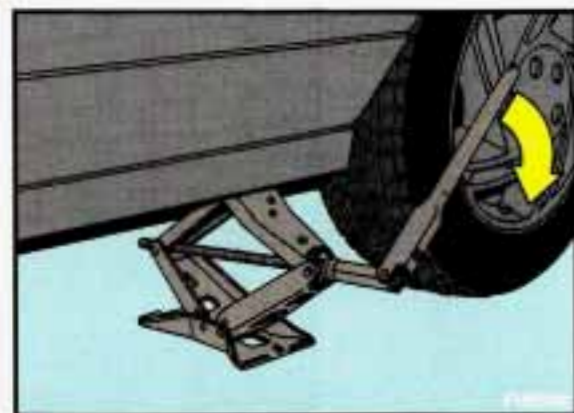

12. Raise the vehicle by rotating the wheel wrench clockwise in the jack. Raise the vehicle far enough off the ground so there is enough room for the spare tire to fit.

NOTICE

Raising your vehicle with the jack improperly positioned will damage the vehicle or may allow the vehicle to fall off the jack. Be sure to fit the jack lift head into the proper location before raising your vehicle.

13. Remove all the wheel nuts and take off the flat tire.

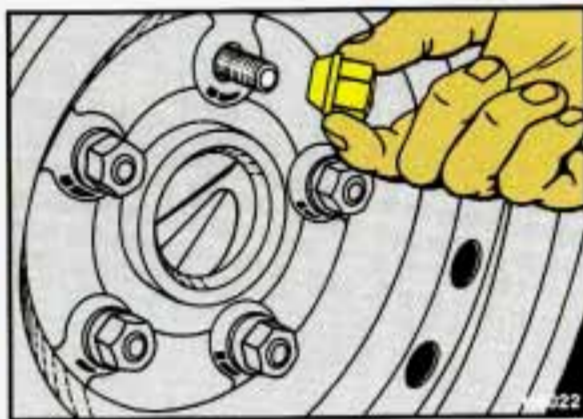
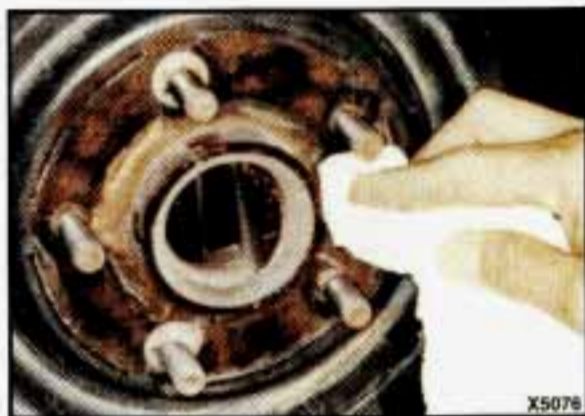

CAUTION

 Rust or dirt on the wheel, or on the parts to which it is fastened, can make the wheel nuts become loose after a time. The wheel could come off and cause an accident. When you change a wheel, remove any rust or dirt from the places where the wheel attaches to the vehicle. In an emergency, you can use a cloth or a paper towel to do this; but be sure to use a scraper or wire brush later, if you need to, to get all the rust or dirt off.

14. Remove any corrosion from the wheel bolts, mounting surface or spare wheel.
15. Place the spare tire on the mounting surface.

CAUTION

 Never use oil or grease on studs or nuts. If you do, the nuts might come loose. Your wheel could fall off, causing a serious accident.

16. Replace the wheel nuts with the rounded end of the nuts toward the wheel. Tighten each nut by hand until the wheel is held against the hub.

Problems on the Road

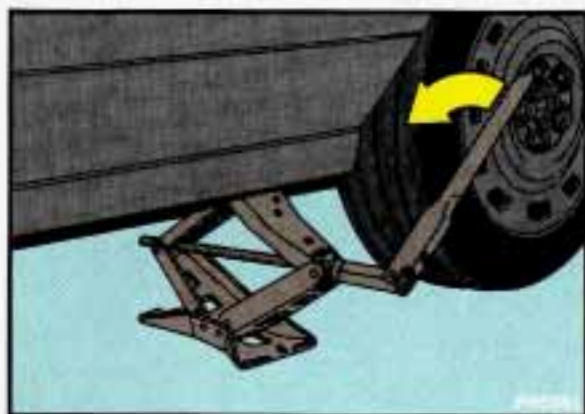

Changing a Flat Tire (CONT.)

17. Lower the vehicle by rotating the wheel wrench counterclockwise on the jack. Lower the jack completely.

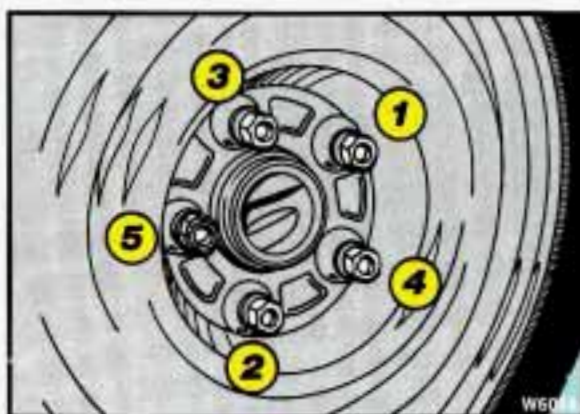

18. In a criss-cross sequence, tighten the wheel nuts firmly.

CAUTION



Incorrect wheel nuts or improperly tightened wheel nuts can cause the wheel to become loose and even come off. This could lead to an accident. Be sure to use the correct wheel nuts. If you have to replace them, be sure to get the right kind.

Stop somewhere as soon as you can and have the nuts tightened with a torque wrench to 100 pound-feet (140 N•m).

Don't try to put the wheel cover on the compact spare tire. It won't fit. Store the wheel cover in the trunk until you have replaced the compact spare tire with a regular tire.

NOTICE

Wheel covers won't fit on your compact spare. If you try to put a wheel cover on your compact spare, you could damage the cover or the spare.



19. Store the flat tire as far forward in the trunk as possible. Store the jack and wheel wrench in their compartment in the trunk.

CAUTION

 Storing a jack, a tire, or other equipment in the passenger compartment of the vehicle could cause injury. In a sudden stop or collision, loose equipment could strike someone. Store all these in the proper place.

The compact spare is for temporary use only. Replace the compact spare tire with a full-size tire as soon as you can. See *Compact Spare Tire* later in this section.

Compact Spare Tire

Although the compact spare was fully inflated when your vehicle was new, it can lose air after a time. Check the inflation pressure regularly. It should be 60 psi (420 kPa). The compact spare is made to go up to 3,000 miles (5 000 km), so you can finish your trip and have your full-size tire repaired or replaced where you want. Of course, it's best to replace your spare with a full-size tire as soon as you can. Your spare will last longer and be in good shape in case you need it again.

Problems on the Road

Compact Spare Tire (CONT.)

Your anti-lock brake system warning light may come on when you are driving with a compact spare. See the *Index* under *Anti-Lock Brake System Warning Light*.

NOTICE

Don't take your compact spare through an automatic car wash with guide rails. The compact spare can get caught on the rails. That can damage the tire and wheel, and maybe other parts of your vehicle.

Don't use your compact spare on some other vehicle.

And don't mix your compact spare or wheel with other wheels or tires. They won't fit. Keep your spare and its wheel together.

NOTICE

Tire chains won't fit your compact spare. Using them will damage your vehicle and destroy the chains too. Don't use tire chains on your compact spare.

If You're Stuck: In Sand, Mud, Ice or Snow

What you **don't** want to do when your vehicle is stuck is to spin your wheels. The method known as "rocking" can help you get out when you're stuck, but you must use caution.

CAUTION



If you let your tires spin at high speed, they can explode and you or others could be injured. And, the transaxle or other parts of the vehicle can overheat. That could cause an engine compartment fire or other damage. When you're stuck, spin the wheels as little as possible. Don't spin the wheels above 35 mph (56 km/h) as shown on the speedometer.

NOTICE

Spinning your wheels can destroy parts of your vehicle as well as the tires. If you spin the wheels too fast while shifting your transaxle back and forth, you can destroy your transaxle.

Rocking Your Vehicle to Get it Out:

First, turn your steering wheel left and right. That will clear the area around your front wheels. Then shift back and forth between **R** (Reverse) and a forward gear, spinning the wheels as little as possible. Release the accelerator pedal while you shift, and press lightly on the accelerator pedal when the transaxle is in gear. If that doesn't get you out after a few tries, you may need to be towed out. If you do need to be towed out, see the *Index* under *Towing Your Pontiac*.

Notes



Here you will find information about the care of your Pontiac. This part begins with service and fuel information, and then it shows how to check important fluid and lubricant levels. There is also technical information about your vehicle, and a section devoted to its appearance care.

Part **6**

Service & Appearance Care

Service	222
Fuel	222
Hood Release	227
Engine Oil	231
Air Cleaner	233
Transaxle Fluid	236
Engine Coolant	238
Power Steering Fluid	242
Windshield Washer Fluid	242
Brakes	243
Battery	245
Bulb Replacement	246
Windshield Wiper Blade Replacement	248
Loading Your Vehicle	248
Tires	250
Appearance Care	257
Vehicle Identification Number (VIN)	264
Add-On Electrical Equipment	265
Fuses & Circuit Breakers	266
Capacities & Specifications	270
Normal Maintenance Replacement Parts	271
Fluids & Lubricants	272
Replacement Bulbs	273

Service & Appearance Care



Service

Your Pontiac dealer knows your vehicle best and wants you to be happy with it. We hope you'll go to your dealer for all your service needs. You'll get genuine GM parts and GM-trained and supported service people.

We hope you'll want to keep your GM vehicle all GM. Genuine GM parts have one of these marks.

Doing Your Own Service Work

If you want to do some of your own service work, you'll want to get the proper Pontiac Service Manual. It tells you much more about how to service your Pontiac than this manual can. To order the proper service manual, see the *Index* under *Service Publications*.

You should keep a record with all parts receipts and list the mileage and date of any service work you perform. See the *Index* under *Maintenance Record*.

CAUTION

 You can be injured if you try to do service work on a vehicle without knowing enough about it.

- Be sure you have sufficient knowledge, experience, and the proper replacement parts and tools before you attempt any vehicle maintenance task.
- Be sure to use the proper nuts, bolts, and other fasteners. "English" and "metric" fasteners can be easily confused. If you use the wrong fasteners, parts can later break or fall off. You could be hurt.

NOTICE

If you try to do service work without knowing enough about it, your vehicle could be damaged.



Fuel

The eighth digit of your Vehicle Identification Number (VIN) shows the code letter for your engine. You will find the VIN at the top left of your instrument panel. (See the *Index* under *Vehicle Identification Number*.)

3800 Engine (Code L):

Use regular unleaded gasoline rated at 87 octane or higher. It should meet specifications ASTM D4814 in the U.S. and CGSB 3.5-92 in Canada. These fuels should have the proper additives, so you should not have to add anything to the fuel.

In the U.S. and Canada, it's easy to be sure you get the right kind of gasoline (unleaded). You'll see "UNLEADED" right on the pump. And only unleaded nozzles will fit into your vehicle's filler neck.

Be sure the posted octane is at least 87. If the octane is less than 87, you may get a heavy knocking noise when you drive. If it's bad enough, it can damage your engine.

If you're using fuel rated at 87 octane or higher and you still hear heavy knocking, your engine needs service. But don't worry if you hear a little pinging noise when you're accelerating or driving up a hill. That's normal, and you don't have to buy a higher octane fuel to get rid of pinging. It's the heavy, constant knock that means you have a problem.

3800 Supercharged Engine (Code I):

Use premium unleaded gasoline rated at 91 octane or higher. It should meet specifications ASTM D4814 in the U.S. and CGSB 3.5-92 in Canada. These fuels should have the proper additives, so you should not have to add anything to the fuel.

In the U.S. and Canada, it's easy to be sure you get the right kind of gasoline (unleaded). You'll see "UNLEADED" right on the pump. And only unleaded nozzles will fit into your vehicle's filler neck.

Be sure the posted octane is at least 91. If the octane is less than 91, you may get a heavy knocking noise when you drive. (In an emergency, you may be able to use lower octane—as low as 87—if heavy knocking does not occur.) If you're using 91 or higher octane unleaded gas and you still get heavy knocking, your engine needs service.

What about gasoline with blending materials that contain oxygen, such as MTBE or alcohol?

- **MTBE** is "methyl tertiary-butyl ether." Fuel that is no more than 15% MTBE is fine for your vehicle.
- **Ethanol** is ethyl or grain alcohol. Properly-blended fuel that is no more than 10% ethanol is fine for your vehicle.
- **Methanol** is methyl or wood alcohol.

Service & Appearance Care

Fuel (CONT.)

NOTICE

Fuel that is more than 5% methanol is bad for your vehicle. Don't use it. It can corrode metal parts in your fuel system and also damage plastic and rubber parts. That damage wouldn't be covered under your warranty. And even at 5% or less, there must be "cosolvents" and corrosion preventers in this fuel to help avoid these problems.

Fuel Capacity: 18 U.S. Gallons (68L).
Use unleaded fuel only.

Gasolines for Cleaner Air

Your use of gasoline with detergent additives will help prevent deposits from forming in your engine and fuel system. That helps keep your engine in tune and your emission control system working properly. It's good for your vehicle, and you'll be doing your part for cleaner air.

Many gasolines are now blended with materials called oxygenates. General Motors recommends that you use gasolines with these blending materials, such as MTBE and ethanol. By doing so, you can help clean the air, especially in those parts of the country that have high carbon monoxide levels.

In addition, some gasoline suppliers are now producing reformulated gasolines. These gasolines are specially designed to reduce vehicle emissions. General Motors recommends that you use reformulated gasoline. By doing so, you can help clean the air, especially in those parts of the country that have high ozone levels.

You should ask your service station operators if their gasolines contain detergents and oxygenates, and if they have been reformulated to reduce vehicle emissions.



Fuels in Foreign Countries

If you plan on driving in another country outside the U.S. or Canada, unleaded fuel may be hard to find.

Do not use leaded gasoline. If you use even one tankful, your emission controls won't work well or at all. With continuous use, spark plugs can get fouled, the exhaust system can corrode, and your engine oil can deteriorate quickly. Your vehicle's oxygen sensor will be damaged. All of that means costly repairs that wouldn't be covered by your warranty.

To check on fuel availability, ask an auto club, or contact a major oil company that does business in the country where you'll be driving.

You can also write us at the following address for advice. Just tell us where you're going and give your Vehicle Identification Number (VIN).

General Motors of Canada Ltd.
International Export Sales
P. O. Box 828
Oshawa, Ontario L1H 7N1, Canada

Fuel Door Lock (OPTION)

On SSE and SSEi models equipped with the Theft-Deterrent System option, the fuel door is locked and unlocked together with the power door locks. Therefore, to unlock the fuel filler door, you may use the outside door key lock, the inside power door lock button, or the Remote Keyless Entry key chain transmitter. To unlock the fuel door, just unlock the driver's door.

Service & Appearance Care



Filling Your Tank

The cap is behind a hinged door on the left side of your vehicle.

CAUTION

 Gasoline vapor is highly flammable. It burns violently, and that can cause very bad injuries. Don't smoke if you're near gasoline or refueling your vehicle. Keep sparks, flames, and smoking materials away from gasoline.

To take off the cap, turn it slowly to the left (counterclockwise).

While refueling, hang the cap inside the fuel door.

CAUTION

 If you get gasoline on you and then something ignites it, you could be badly burned. Gasoline can spray out on you if you open the fuel filler cap too quickly. This spray can happen if your tank is nearly full, and is more likely in hot weather. Open the fuel filler cap slowly and wait for any "hiss" noise to stop. Then unscrew the cap all the way.

When you put the cap back on, turn it to the right until you hear a clicking noise.

NOTICE

If you need a new cap, be sure to get the right type. Your dealer can get one for you. If you get the wrong type, it may not fit or have proper venting, and your fuel tank and emissions system might be damaged.

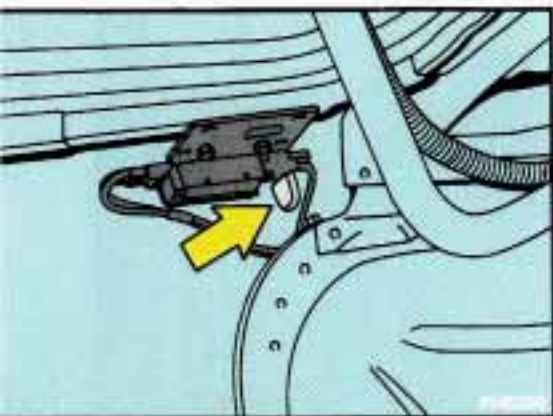

Fuel Door Manual Release

If your vehicle has a fuel door lock, the fuel door can be opened manually in case of an electrical power failure. To do so, first open the trunk. The release mechanism is on the driver's side of the vehicle, at the top of the trunk compartment. Pull the tab to release the fuel door.

NOTICE

Prying on a locked fuel filler door can damage it. Use the remote fuel door manual release located in the trunk.

■ **Checking Things Under the Hood**

The following sections tell you how to check fluids, lubricants and important parts underhood.



Hood Release

To open the hood, first pull the hood release handle inside the vehicle.

Service & Appearance Care

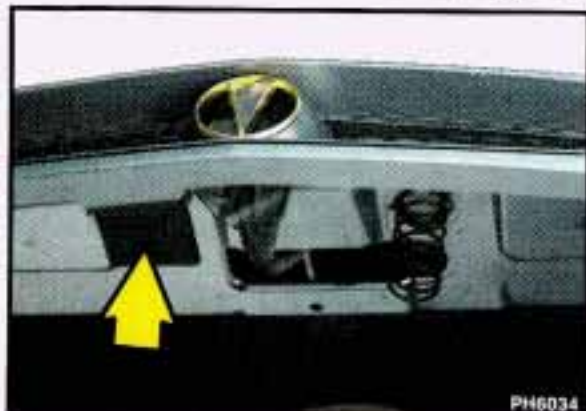

Hood Release (CONT.)

Then go to the front of the vehicle and pull up on the underhood release. Lift the hood.

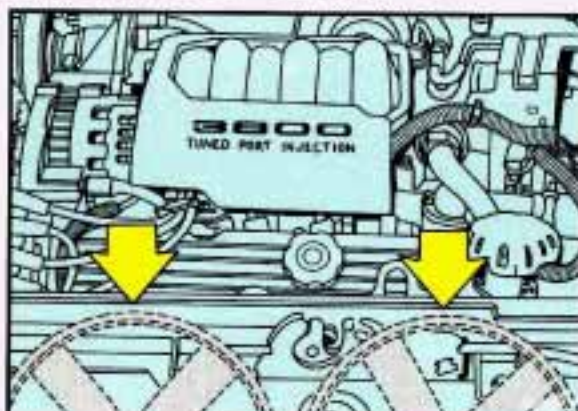

CAUTION



An electric fan under the hood can start up and injure you even when the engine is not running. Keep hands, clothing and tools away from any underhood electric fan.

CAUTION



Things that burn can get on hot engine parts and start a fire. These include liquids like gasoline, oil, coolant, brake fluid, windshield washer and other fluids, and plastic or rubber. You or others could be burned. Be careful not to drop or spill things that will burn onto a hot engine.

Before closing the hood, be sure all the filler caps are on properly. Then just pull the hood down and close it firmly.

Underhood Light

Your parking lights or headlights must be on for the underhood light to function when you open the hood.

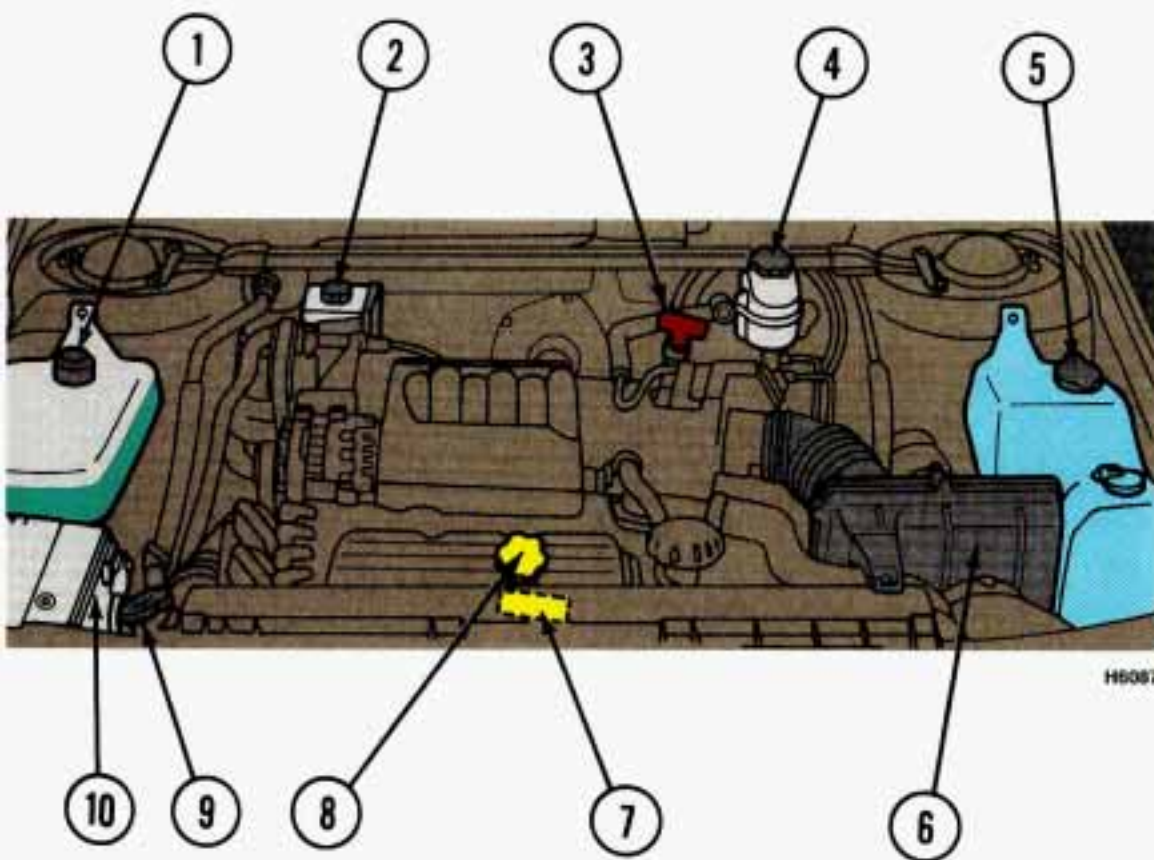

3800 Engine (CODE L)

When you open the hood, you'll see:

1. Engine Coolant Recovery Tank
2. Power Steering Fluid Reservoir
3. Automatic Transaxle Fluid Dipstick
4. Brake Fluid Reservoir
5. Windshield Washer Fluid Reservoir
6. Air Cleaner
7. Engine Oil Dipstick
8. Engine Oil Fill Cap
9. Radiator Pressure Cap
10. Battery

Service & Appearance Care

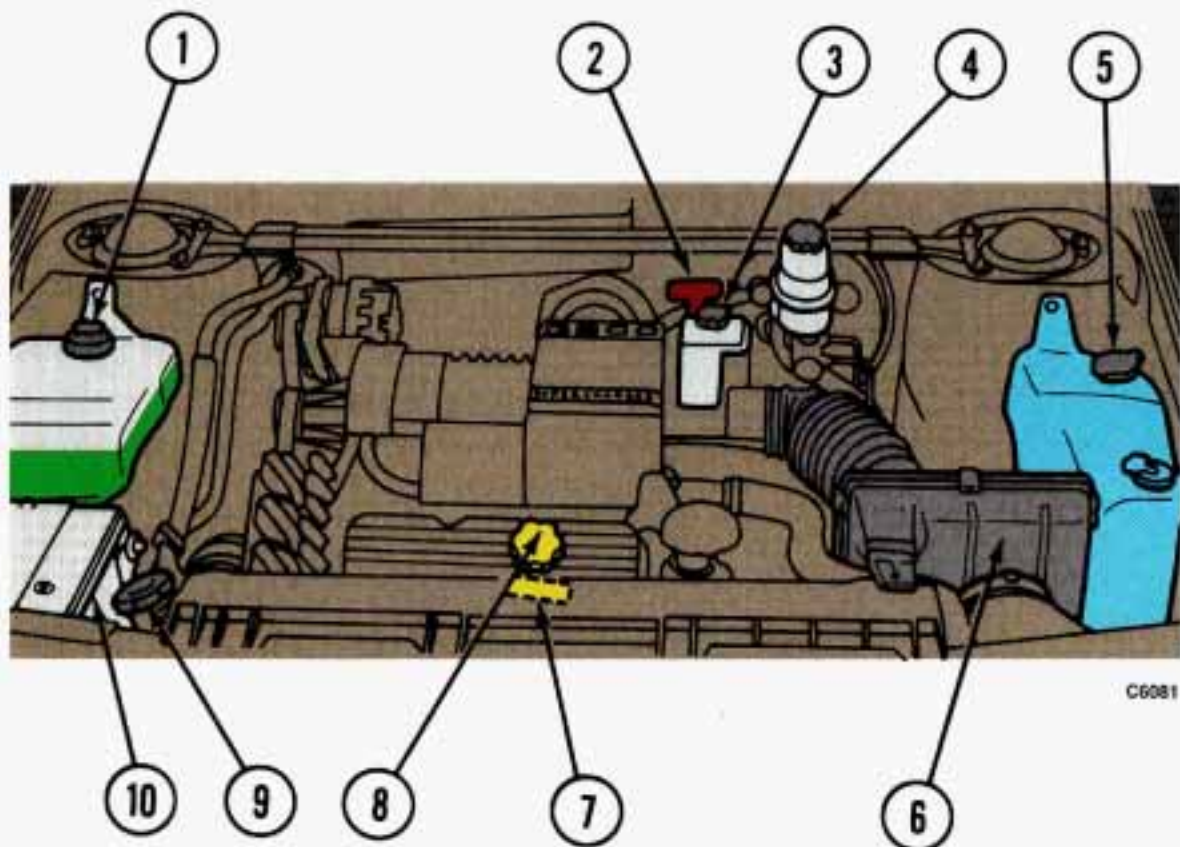

3800 SC Engine (CODE 1)

When you open the hood, you'll see:

1. Engine Coolant Recovery Tank
2. Automatic Transaxle Fluid Dipstick
3. Power Steering Fluid Reservoir
4. Brake Fluid Reservoir
5. Windshield Washer Fluid Reservoir
6. Air Cleaner
7. Engine Oil Dipstick
8. Engine Oil Fill Cap
9. Radiator Pressure Cap
10. Battery

C6081

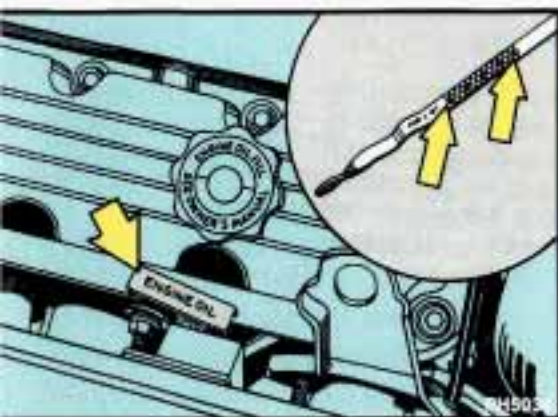

Engine Oil

It's a good idea to check your engine oil every time you get fuel. In order to get an accurate reading, the oil must be warm and the vehicle must be on level ground. Turn off the engine and give the oil a few minutes to drain back into the oil pan. If you don't, the oil dipstick might not show the actual level.

To Check Engine Oil:

Pull out the dipstick and clean it with a paper towel or cloth, then push it back in all the way. Remove it again, keeping the tip lower.

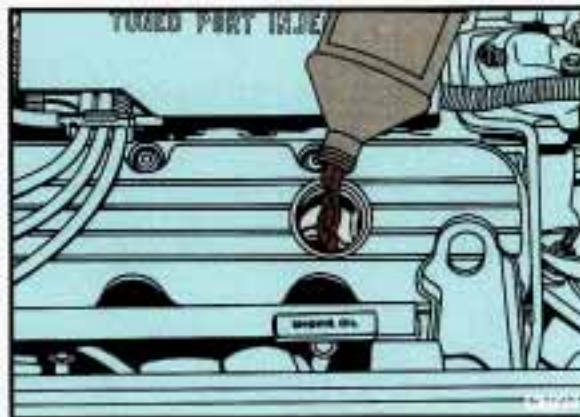

When to Add Oil:

If the oil is at or below the **ADD** line, then you'll need to add some oil. But you must use the right kind. This section explains what kind of oil to use.

For crankcase capacity, see the *Index* under *Capacities & Specifications*.

NOTICE

Don't add too much oil. If your engine has so much oil that the oil level gets above the cross-hatched area that shows the proper operating range, your engine could be damaged.

Just fill it enough to put the level somewhere in the proper operating range. Push the dipstick all the way back in when you're through.

Service & Appearance Care



What Kind of Oil to Use

Look for Three Things:

- **SG**

"SG" must be on the oil container, either by itself or combined with other quality designations, such as "SG/CC," "SG/CD," "SF, SG, CC," etc. These letters show American Petroleum Institute (API) levels of quality.

NOTICE

If you use oils that don't have the "SG" designation, you can cause engine damage not covered by your warranty.

Recommended SAE Viscosity Grade Engine Oils

For best fuel economy and cold starting, select the lowest SAE viscosity grade oil for the expected temperature range.

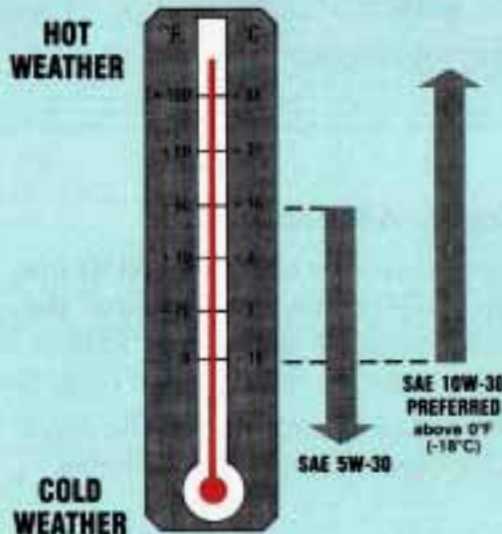

IF NEITHER SAE 5W-30 NOR SAE 10W-30 GRADE OILS ARE AVAILABLE, SAE 30 GRADE MAY BE USED AT TEMPERATURES ABOVE 40 DEGREES F (4 DEGREES C).

DO NOT USE SAE 10W-40, SAE 20W-50 OR ANY OTHER GRADE OIL NOT RECOMMENDED.

- **SAE 10W-30**

As shown in the viscosity chart, SAE 10W-30 is best for your vehicle. However, you can use SAE 5W-30 if it's going to be colder than 60°F (16°C) before your next oil change. When it's very cold, below 0°F (-18°C), you should use SAE 5W-30. These numbers on an oil container show its viscosity, or thickness. Do not use other viscosity oils such as SAE 10W-40 or SAE 20W-50.

- **Energy Conserving II**

Oils with these words on the container will help you save fuel.

This doughnut-shaped logo (symbol) is used on most oil containers to help you select the correct oil.

You should look for this on the oil container, and use **only** those oils that display the logo.

GM Goodwrench® Oil (in Canada, GM Engine Oil) meets all the requirements for your vehicle.

Engine Oil Additives

Don't add anything to your oil. Your Pontiac dealer is ready to advise if you think something should be added.

When to Change Engine Oil

See if any one of these is true for you:

- Most trips are less than 4 miles (6 km).
- It's below freezing outside and most trips are less than 10 miles (16 km).
- The engine is at low speed most of the time (as in door-to-door delivery, or in stop-and-go traffic).
- You tow a trailer often.
- Most trips are through dusty places.

If any one of these is true for your vehicle, you need to change your **oil and filter** every 3,000 miles (5 000 km) or 3 months—whichever comes first.

If none of them is true, change the oil every 7,500 miles (12 500 km) or 12 months—whichever comes first. Change the filter at the first oil change and at every other oil change after that.

Engine Block Heater

An engine block heater can be a big help if you have to park outside in very cold weather, 0°F (-18°C) or colder. If your vehicle has this option, see the *Index* under *Engine Block Heater*.

What to Do with Used Oil

CAUTION



Used engine oil contains things that have caused skin cancer in laboratory animals. Don't let used oil stay on your skin for very long. Clean your skin and nails with soap and water, or a good hand cleaner. Wash or properly throw away clothing or rags containing used engine oil.

Used oil can be a real threat to the environment. If you change your own oil, be sure to drain all free-flowing oil from the filter before disposal. Don't ever dispose of oil by pouring it on the ground, into sewers, or into streams or bodies of water. Instead, recycle it by taking it to a place that collects used oil. If you have a problem properly disposing of your used oil, ask your dealer, a service station or a local recycling center for help.

Air Cleaner

Refer to the Maintenance Schedule to determine when to replace the air filter. See the *Index* under *Scheduled Maintenance Services*.

CAUTION



Operating the engine with the air cleaner off can cause you or others to be burned. The air cleaner not only cleans the air, it stops flame if the engine backfires. If it isn't there, and the engine backfires, you could be burned. Don't drive with it off, and be careful working on the engine with the air cleaner off.

NOTICE

If the air cleaner is off, a backfire can cause a damaging engine fire. And, dirt can easily get into your engine, which will damage it. Always have the air cleaner in place when you're driving.

Service & Appearance Care

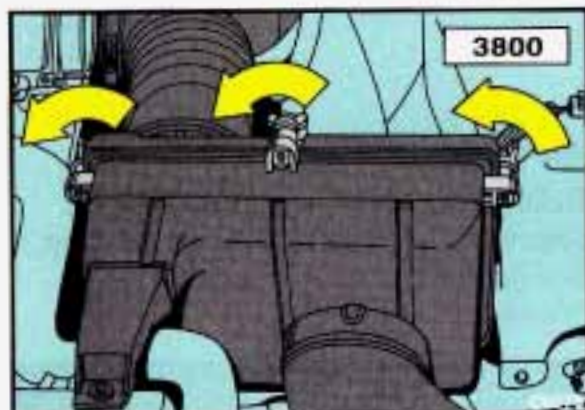

Air Cleaner (CONT.)

To Check or Replace (3800 Engine):

1. Unscrew the three wing screws in the housing cover and pull back.



2. Unscrew the clamp on the air intake hose where the hose attaches to the throttle body near the top of the engine. Detach the hose from the throttle body, then pull back the rear of the housing cover.

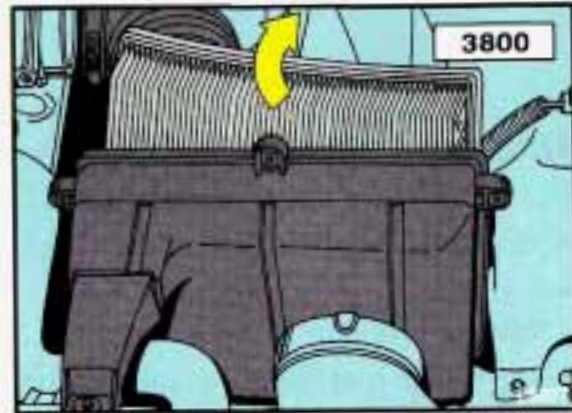

3. Remove the air filter.
4. Be sure to install the air filter and replace the cover tightly.
5. Reattach the air intake hose and tighten the clamp.



To Check or Replace (3800 Supercharged Engine):

1. Unsnap the three clips in the housing cover and pull back.

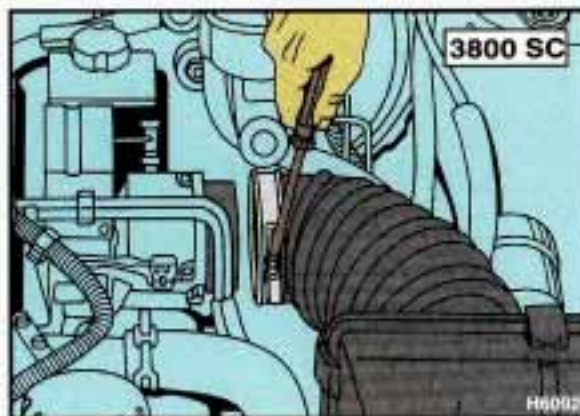

2. Unscrew the clamp on the air intake hose where the hose attaches to the throttle body near the top of the engine. Detach the hose from the throttle body, then pull back the rear of the housing cover.



3. Remove the air filter.
4. Be sure to install the air filter and replace the cover tightly.
5. Reattach the air intake hose and tighten the clamp.

Service & Appearance Care

Automatic Transaxle Fluid

When to Check and Change:

A good time to check your automatic transaxle fluid level is when the engine oil is changed. Refer to the Maintenance Schedule to determine when to change your fluid. See the *Index* under *Scheduled Maintenance Services*.

How to Check:

Because this operation can be a little difficult, you may choose to have this done at a dealership Service Department. If you do it yourself, be sure to follow all the instructions here, or you could get a false reading on the dipstick.

NOTICE

Too much or too little fluid can damage your transaxle. Too much can mean that some of the fluid could come out and fall on hot engine parts, starting a fire. Be sure to get an accurate reading if you check your transaxle fluid.

Wait at least 30 minutes before checking the transaxle fluid level if you have been driving:

- When outside temperatures are above 90°F (32°C).
- At high speed for quite a while.
- In heavy traffic—especially in hot weather.
- While pulling a trailer.

To get the right reading, the fluid should be at normal operating temperature, which is 180°F to 200°F (82°C to 93°C).

Get the vehicle warmed up by driving about 15 miles (24 km) when outside temperatures are above 50°F (10°C). If it's colder than 50°F (10°C), you may have to drive longer.

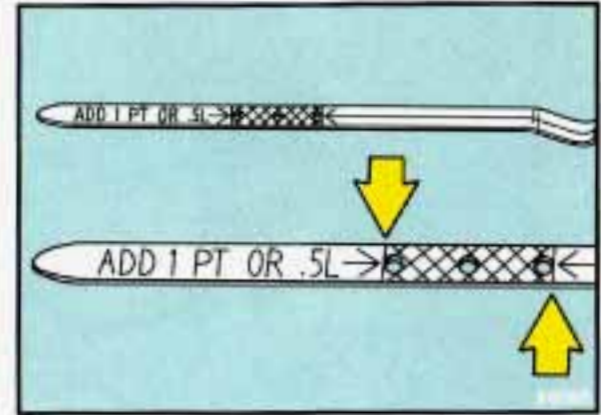
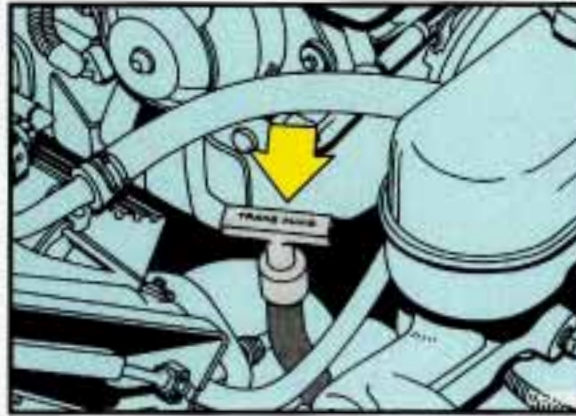

To Check the Fluid Level:

- Park your vehicle on a level place.
- Place the shift lever in **P** (Park) with the parking brake applied.
- With your foot on the brake pedal, move the shift lever through each gear range, pausing for about three seconds in each range. Then, position the shift lever in **P** (Park).
- Let the engine run at idle for three to five minutes.

Then, Without Shutting Off the Engine, Follow These Steps:

1. Pull out the dipstick and wipe it with a clean rag or paper towel.
2. Push it back in all the way, wait three seconds and then pull it back out again.

3. Check both sides of the dipstick, and read the lower level. The fluid level must be in the crosshatched area.
4. If the fluid level is where it should be, push the dipstick back in all the way.

Service & Appearance Care

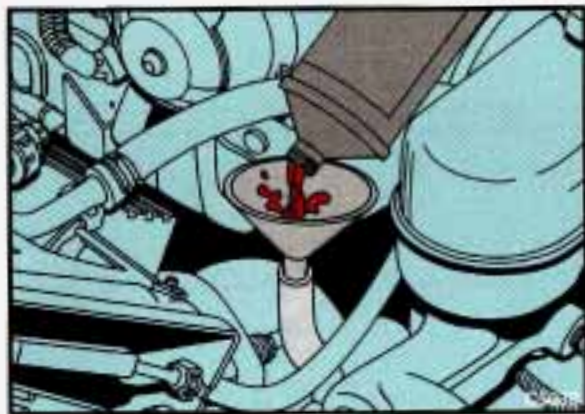

Automatic Transaxle Fluid (CONT.)

How to Add Fluid:

Refer to the Maintenance Schedule to determine what kind of transaxle fluid to use. See the *Index* under *Fluids & Lubricants*.

If the fluid level is low, add only enough of the proper fluid to bring the level up into the cross-hatched area on the dipstick. It doesn't take much fluid, generally less than a pint (0.5 L). Don't overfill. We recommend that you use only fluid labeled DEXRON®-III, because fluids with that label are made especially for your automatic transaxle. Damage caused by fluid other than DEXRON®-III is not covered by your new vehicle warranty.

After adding fluid, recheck the fluid level as described under *How to Check*.

When the correct fluid level is obtained, push the dipstick back in all the way.

Engine Coolant

The following explains your cooling system and how to add coolant when it is low. If you have a problem with engine overheating, see the *Index* under *Engine Overheating*.

The proper coolant for your Pontiac will:

- Give freezing protection down to -34°F (-37°C).
- Give boiling protection up to 262°F (128°C).
- Protect against rust and corrosion.
- Help keep the proper engine temperature.
- Let the warning lights work as they should.

What to Use:

Use a mixture of one-half **clean water** (preferably distilled) and one-half antifreeze that meets “GM Specification 1825-M,” which won’t damage aluminum parts. You can also use a recycled coolant conforming to GM Specification 1825-M with a complete coolant flush and refill. If you use this mixture, you don’t need to add anything else.

CAUTION



Adding only plain water to your cooling system can be dangerous. Plain water, or some other liquid like alcohol, can boil before the proper coolant mix will. Your vehicle’s coolant warning system is set for the proper coolant mix. With plain water or the wrong mix, your engine could get too hot but you wouldn’t get the overheat warning. Your engine could catch fire and you or others could be burned. Use a 50/50 mix of clean water and a proper antifreeze.

NOTICE

If you use an improper coolant mix, your engine could overheat and be badly damaged. The repair cost wouldn’t be covered by your warranty. Too much water in the mix can freeze and crack the engine, radiator, heater core and other parts.

Service & Appearance Care

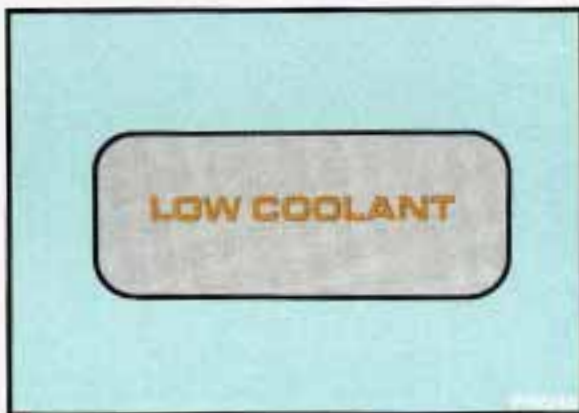
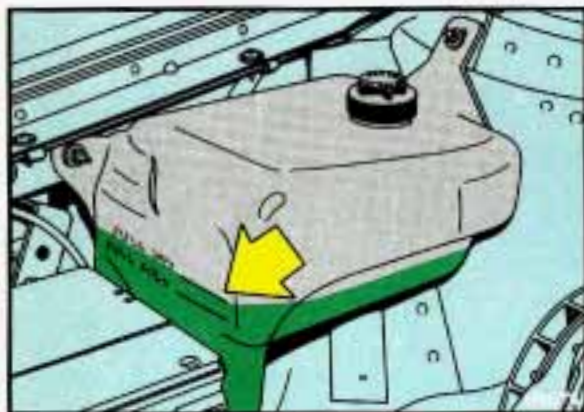

Adding Coolant

To Check Coolant:

When your engine is cold, the coolant level should be between the **FULL COLD** mark and **FULL HOT**. When your engine is warm, the level should be up to **FULL HOT**, or a little higher.

If you have the optional low coolant warning light and it comes on when your engine is running, you're low on coolant. Or, if you have the optional Driver Information Center and the warning **LOW COOLANT** appears, you're low on coolant.

To Add Coolant:

If you need more coolant, add the proper mix **at the coolant recovery tank**.

CAUTION



Turning the radiator pressure cap when the engine and radiator are hot can allow steam and scalding liquids to blow out and burn you badly. With the coolant recovery tank, you will almost never have to add coolant at the radiator. Never turn the radiator pressure cap—even a little—when the engine and radiator are hot.

Add coolant mix at the recovery tank, but be careful not to spill it.

CAUTION



You can be burned if you spill coolant on hot engine parts. Coolant contains ethylene glycol, and it will burn if the engine parts are hot enough. Don't spill coolant on a hot engine.

Radiator Pressure Cap

NOTICE

Your radiator pressure cap is a 15 psi (105 kPa) pressure-type cap and must be tightly installed to prevent coolant loss and possible engine damage from overheating. Be sure the arrows on the cap line up with the overflow tube on the radiator filler neck.

When you replace your radiator pressure cap, an AC® cap is recommended.

Thermostat

Engine coolant temperature is controlled by a thermostat in the engine coolant system. The thermostat stops the flow of coolant through the radiator until the coolant reaches a preset temperature.

When you replace your thermostat, an AC® thermostat is recommended.

Service & Appearance Care

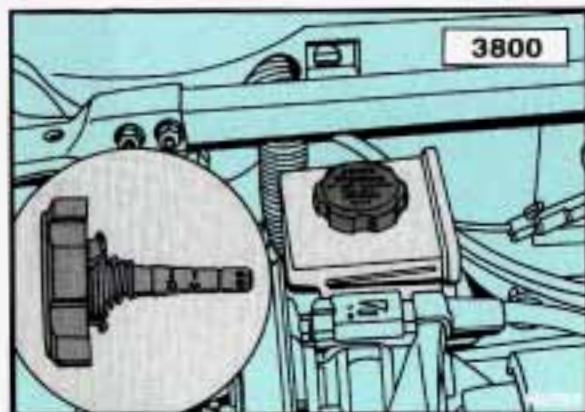

Power Steering Fluid

How to Check Power Steering Fluid:

Unscrew the cap and wipe the dipstick with a clean rag. Replace the cap and completely tighten it. Then remove the cap again and look at the fluid level on the dipstick.

- When the engine compartment is hot, the level should be at the **H** mark.
- When the engine compartment is cool, the level should be at the **C** mark.

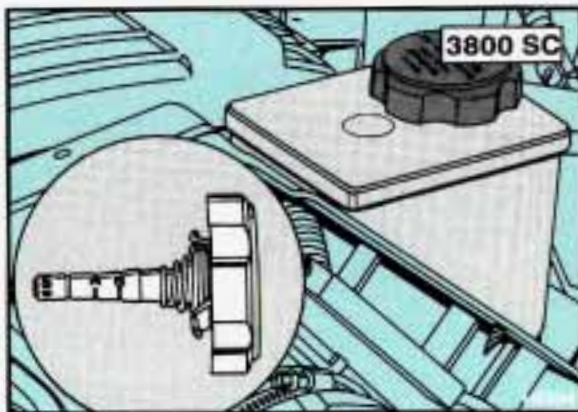

What to Add:

Refer to the Maintenance Schedule to determine what kind of fluid to use. See the *Index* under *Fluids & Lubricants*.

NOTICE

When adding power steering fluid or making a complete fluid change, always use the proper fluid. Failure to use the proper fluid can cause leaks and damage hoses and seals.

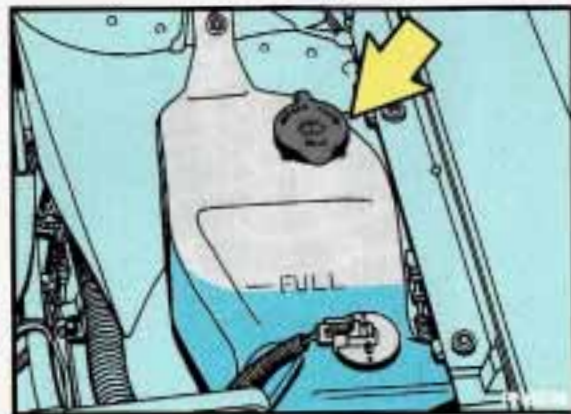

Windshield Washer Fluid

To Add:

Open the cap labeled **WASHER FLUID ONLY**. Add washer fluid until the bottle is full.

NOTICE

- When using concentrated washer fluid, follow the manufacturer's instructions for adding water.
- Don't mix water with ready-to-use washer fluid. Water can cause the solution to freeze and damage your washer fluid tank and other parts of the washer system. Also, water doesn't clean as well as washer fluid.
- Fill your washer fluid tank only $\frac{3}{4}$ full when it's very cold. This allows for expansion, which could damage the tank if it is completely full.
- Don't use radiator antifreeze in your windshield washer. It can damage your washer system and paint.

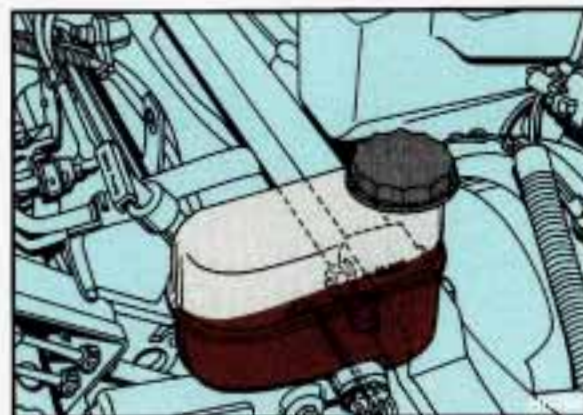

Brake Master Cylinder

Your brake master cylinder is here. It is filled with DOT-3 brake fluid.

There are only two reasons why the brake fluid level in your master cylinder might go down. The first is that the brake fluid goes down to an acceptable level during normal brake lining wear. When new linings are put in, the fluid level goes back up.

The other reason is that fluid is leaking out of the brake system. If it is, you should have your brake system fixed, since a leak means that sooner or later your brakes won't work well, or won't work at all.

So, it isn't a good idea to "top off" your brake fluid. Adding brake fluid won't correct a leak. If you add fluid when

Service & Appearance Care

Brake Master Cylinder (CONT.)

your linings are worn, then you'll have too much fluid when you get new brake linings. You should add (or remove) brake fluid, as necessary, only when work is done on the brake hydraulic system.

CAUTION



If you have too much brake fluid, it can spill on the engine. The fluid will burn if the engine is hot enough. You or others could be burned, and your engine could be damaged. Add brake fluid only when work is done on the brake hydraulic system.

When your brake fluid falls to a low level, your brake warning light will come on. A continuous chime will sound if you try to drive with this warning light on. See the *Index* under *Brake System Warning Light*.

What to Add:

When you do need brake fluid, use only DOT-3 brake fluid—such as Delco Supreme II® (GM Part No. 1052535). Use new brake fluid from a sealed container only.

NOTICE

- DOT-5 silicone brake fluid can damage your vehicle. Don't use it.
- Don't let someone put in the wrong kind of fluid. For example, just a few drops of mineral-based oil, such as engine oil, in your brake system can damage brake system parts so badly that they'll have to be replaced.
- Brake fluid can damage paint, so be careful not to spill brake fluid on your vehicle.

Replacing Brake System Parts

The braking system on a modern vehicle is complex. Its many parts have to be of top quality and work well together if the vehicle is to have really good braking. Vehicles we design and test have top-quality GM brake parts in them, as your Pontiac does when it is new. When you replace parts of your braking system—for example, when your brake linings wear down and you have to have new ones put in—be sure you get new genuine GM replacement parts. If you don't, your brakes may no longer work properly. For example, if someone puts in brake linings that are wrong for your vehicle, the balance between your front and rear brakes can change, for the worse. The braking performance you've come to expect can change in many other ways if someone puts in the wrong replacement brake parts.

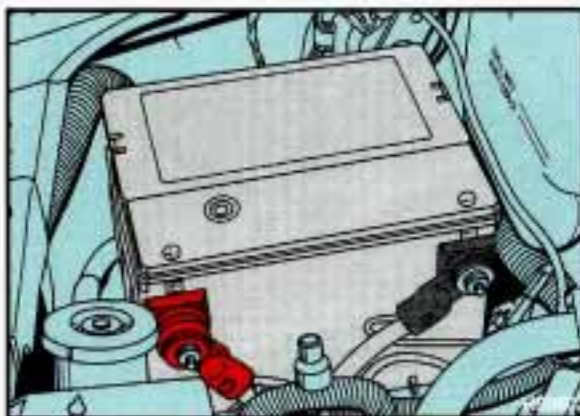

Battery

Every new Pontiac has a Delco Freedom® battery. You never have to add water to one of these. When it's time for a new battery, we recommend a Delco Freedom® battery. Get one that has the catalog number shown on the original battery's label.

Jump Starting

For jump starting instructions, see the *Index* under *Jump Starting*.

Vehicle Storage

If you're not going to drive your vehicle for 25 days or more, take off the black negative (–) cable from the battery. This will help keep your battery from running down.

CAUTION



Batteries have acid that can burn you and gas that can explode. You can be badly hurt if you aren't careful. See the *Index* under *Jump Starting* for tips on working around a battery without getting hurt.

Contact your dealer to learn how to prepare your vehicle for longer storage periods.

Service & Appearance Care

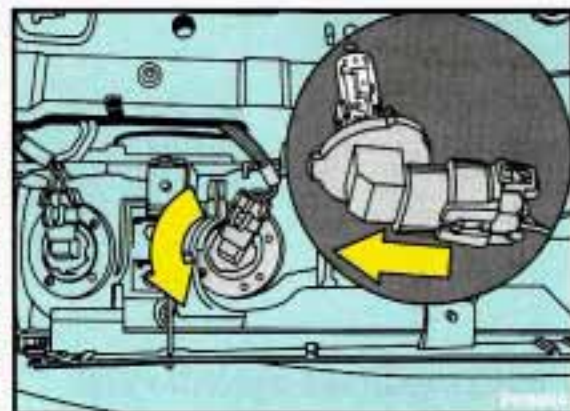
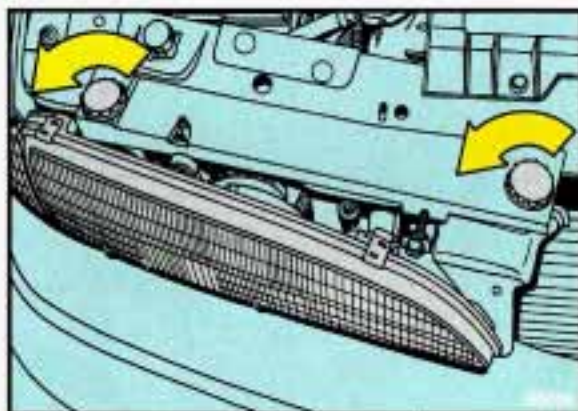

Halogen Bulbs

CAUTION

 Halogen bulbs have pressurized gas inside and can burst if you drop or scratch the bulb. You or others could be injured. Take special care when handling and disposing of halogen bulbs.

Headlight Bulb Replacement

For the type of bulb, see the *Index* under *Replacement Bulbs*.

1. Remove the two screws from the top of the headlight housing.
2. Lift the entire headlight housing and tilt it forward.
3. Twist the bulb assembly $\frac{1}{8}$ turn and pull out the bulb assembly.
4. Unclip the bulb assembly from the wiring harness and replace the bulb assembly.

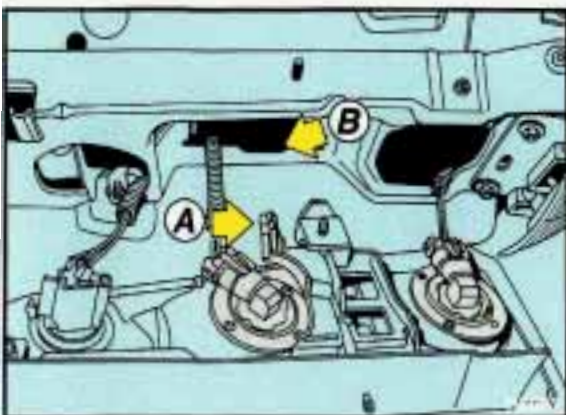

5. Reverse steps 1-3 to replace the bulb assembly and headlight housing. Make sure the tab (A) is locked into the slot (B) in the radiator support before tightening the screws.

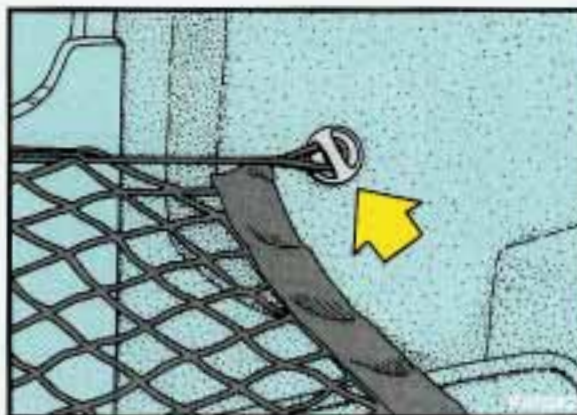

Taillight Bulb Replacement

For the type of bulb, see the *Index* under *Replacement Bulbs*.

1. In the trunk, remove the two plastic nuts holding the carpeting in place.
2. Pull the carpet away from the rear corner of the trunk.

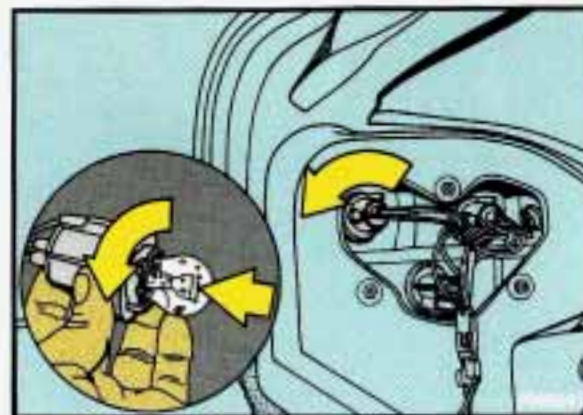

3. Rotate the bulb housing $\frac{1}{8}$ turn and remove it.
4. To remove bulb, push in and rotate it counterclockwise.
5. Replace the bulb.
6. Reverse the steps to reassemble the taillight.

Fog Light Bulb Replacement

If you have fog lights, don't change your fog light bulbs unless you have the proper aiming equipment. See your Pontiac dealer if you have any further questions.

Service & Appearance Care

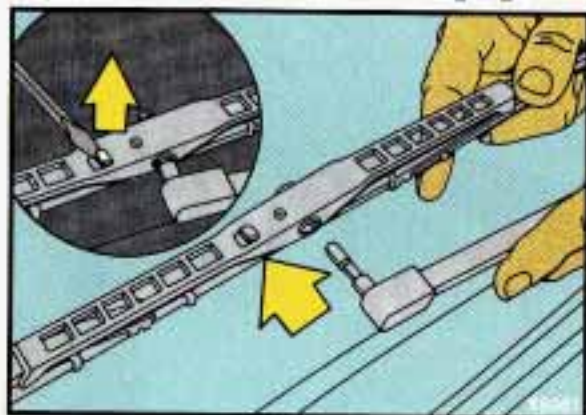

Windshield Wiper Blade Replacement

Replacement blades come in different types and are removed in different ways. Here's how to remove the type with a release clip:

1. Pull the windshield wiper arm away from the windshield.
2. Lift the release clip with a screwdriver and pull the blade assembly off the wiper arm.
3. Push the new wiper blade securely on the wiper arm.



Loading Your Vehicle

Two labels on your vehicle show how much weight it may properly carry. The Tire-Loading Information label found on the rear edge of the driver's door tells you the proper size, speed rating and recommended inflation pressures for the tires on your vehicle. It also gives you important information about the number of people that can be in your vehicle and the total weight that you can carry. This weight is called the Vehicle Capacity Weight and includes the weight of all occupants, cargo, and all nonfactory-installed options.

The other label is the Certification label, also on the rear edge of the driver's door. It tells you the gross weight capacity of your vehicle, called

the GVWR (Gross Vehicle Weight Rating). The GVWR includes the weight of the vehicle, all occupants, fuel and cargo. Never exceed the GVWR for your vehicle, or the Gross Axle Weight Rating (GAWR) for either the front or rear axle.

And, if you do have a heavy load, you should spread it out. Don't carry more than 176 lbs. (80 kg) in your trunk.

On vehicles equipped with electronic level control, the rear of the vehicle is automatically kept level as you load or unload your vehicle.

CAUTION



Do not load your vehicle any heavier than the GVWR or the maximum front and rear GAWRs. If you do, parts on your vehicle can break, or it can change the way your vehicle handles. These could cause you to lose control. Also, overloading can shorten the life of your vehicle.

NOTICE

Your warranty does not cover parts or components that fail because of overloading.

If you put things inside your vehicle—like suitcases, tools, packages, or anything else—they will go as fast as the vehicle goes. If you have to stop or turn quickly, or if there is a crash, they'll keep going.

CAUTION



Things you put inside your vehicle can strike and injure people in a sudden stop or turn, or in a crash.

- Put things in the trunk of your vehicle. In a trunk, put them as far forward as you can. Try to spread the weight evenly.
- Never stack heavier things, like suitcases, inside the vehicle so that some of them are above the tops of the seats.
- When you carry something inside the vehicle, secure it whenever you can.
- Don't leave a seat folded down unless you need to.

Service & Appearance Care

■ Tires

We don't make tires. Your new vehicle comes with high quality tires made by a leading tire manufacturer. These tires are warranted by the tire manufacturers and their warranties are delivered with every new Pontiac. If your spare tire is a different brand than your road tires, you will have a tire warranty folder from each of these manufacturers.

CAUTION



Poorly maintained and improperly used tires are dangerous.

- Overloading your tires can cause overheating as a result of too much friction. You could have an air-out and a serious accident. See the *Index* under *Loading Your Vehicle*.
- Underinflated tires pose the same danger as overloaded tires. The resulting accident could cause serious injury. Check all tires frequently to maintain the recommended pressure. Tire pressure should be checked when the tires are cold.
- Overinflated tires are more likely to be cut, punctured, or broken by sudden impact, such as when you hit a pothole. Keep tires at the recommended pressure.
- Worn, old tires can cause accidents. If your tread is badly worn, or if your tires have been damaged, replace them.

Inflation—Tire Pressure

The Tire Loading Information label which is on the rear edge of the driver's door shows the correct inflation pressures for your tires, when they're cold. "Cold" means your vehicle has been sitting for at least three hours or driven no more than a mile.

NOTICE

Don't let anyone tell you that underinflation or overinflation is all right. It's not. If your tires don't have enough air (underinflation), you can get:

- Too much flexing
- Too much heat
- Tire overloading
- Bad wear
- Bad handling
- Bad fuel economy.

If your tires have too much air (overinflation), you can get:

- Unusual wear
- Bad handling
- Rough ride
- Needless damage from road hazards.

When to Check:

Check your tires once a month or more. Don't forget your compact spare tire. It should be at 60 psi (420 kPa).

How to Check:

Use a good quality pocket-type gage to check tire pressure. Simply looking at the tires will not tell you the pressure, especially if you have radial tires—which may look properly inflated even if they're underinflated.

If your tires have valve caps, be sure to put them back on. They help prevent leaks by keeping out dirt and moisture.

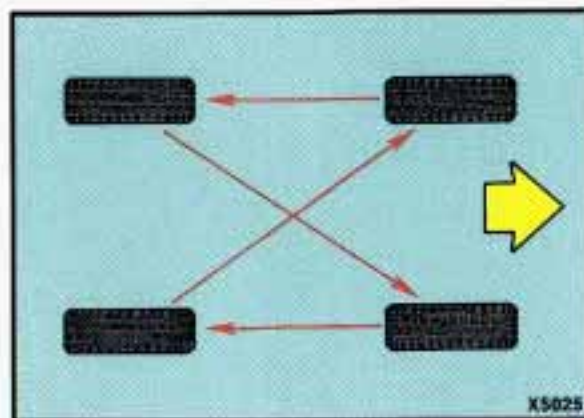

Tire Inspection and Rotation

To make your tires last longer, have them inspected and rotated at the mileages recommended in your Maintenance Schedule. See the *Index* under *Scheduled Maintenance Services*.

Use this rotation pattern.

After the tires have been rotated, adjust the front and rear inflation pressure as shown on the Tire-Loading Information label. Make certain that all wheel nuts are properly tightened. See the *Index* under *Wheel Nut Torque*.

Service & Appearance Care

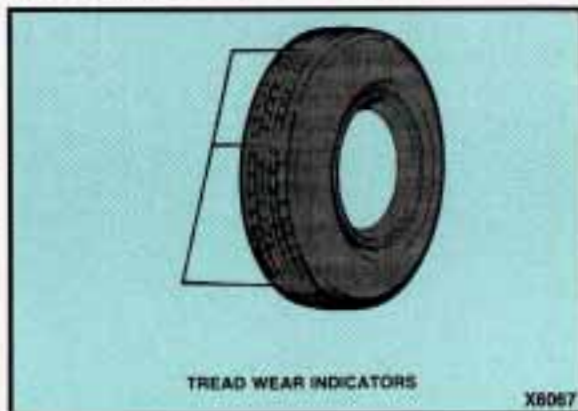

Tire Inspection and Rotation (CONT.)

CAUTION

 Rust or dirt on a wheel, or on the parts to which it is fastened, can make the wheel nuts become loose after a time. The wheel could come off and cause an accident. When you change a wheel, remove any rust or dirt from places where the wheel attaches to the vehicle. In an emergency, you can use a cloth or a paper towel to do this; but be sure to use a scraper or wire brush later, if you need to, to get all the rust or dirt off. See the *Index* under *Changing a Flat Tire*.

When It's Time for New Tires

One way to tell when it's time for new tires is to check the treadwear indicators, which will appear when your tires have only 2/32 inch (1.6 mm) or less of tread remaining.

You need a new tire if:

- You can see the indicators at three places around the tire.
- You can see cord or fabric showing through the tire's rubber.
- The tread or sidewall is cracked, cut or snagged deep enough to show cord or fabric.
- The tire has a bump, bulge or split.
- The tire has a puncture, cut, or other damage that can't be repaired well because of the size or location of the damage.

Buying New Tires

To find out what kind and size of tires you need, look at the Tire-Loading Information label. The tires installed on your vehicle when it was new had a Tire Performance Criteria Specification (TPC Spec) number on each tire's sidewall. When you get new tires, get ones with that same TPC Spec number. That way, your vehicle will continue to have tires that are designed to give proper endurance, handling, speed rating, traction, ride and other things during normal service on your vehicle.

If your tires have an all-season tread design, the TPC number will be followed by a "MS" (for mud and snow).

If you ever replace your tires with those not having a TPC Spec number, make sure they are the same size, load range, speed rating and construction type (bias, bias-belted or radial) as your original tires.

CAUTION



Mixing tires could cause you to lose control while driving. If you mix tires of different sizes or types (radial and bias-belted tires), the vehicle may not handle properly, and you could have a crash. Be sure to use the same size and type tires on all wheels. It's all right to drive with your compact spare, though. It was developed for limited use on your vehicle.

■ *Uniform Tire Quality Grading*

The following information relates to the system developed by the United States National Highway Traffic Safety Administration which grades tires by treadwear, traction and temperature performance. (This applies only to vehicles sold in the United States.)

Treadwear

The treadwear grade is a comparative rating based on the wear rate of the tire when tested under controlled conditions on a specified government test course. For example, a tire graded 150 would wear one and a half (1½) times as well on the government course as a tire graded 100. The relative performance of tires depends upon the actual conditions of their use, however, and may depart significantly from the norm due to variations in driving habits, service practices and differences in road characteristics and climate.

Service & Appearance Care

Traction—A, B, C

The traction grades, from highest to lowest are: A, B, and C. They represent the tire's ability to stop on wet pavement as measured under controlled conditions on specified government test surfaces of asphalt and concrete. A tire marked C may have poor traction performance.

Warning: The traction grade assigned to this tire is based on braking (straight-ahead) traction tests and does not include cornering (turning) traction.

Temperature—A, B, C

The temperature grades are A (the highest), B, and C, representing the tire's resistance to the generation of heat and its ability to dissipate heat when tested under controlled conditions on a specified indoor laboratory test wheel. Sustained high temperature can cause the material of the tire to degenerate and reduce tire life, and excessive temperature can lead to sudden tire failure. The grade C corresponds to a level of performance which all passenger car tires must meet under the Federal Motor Vehicle Safety Standard No. 109. Grades B and A represent higher levels of performance on the laboratory test wheel than the minimum required by law.

Warning: The temperature grade for this tire is established for a tire that is properly inflated and not overloaded. Excessive speed, underinflation, or excessive loading, either separately or in combination, can cause heat buildup and possible tire failure.

Those grades are molded on the sidewalls of passenger car tires.

While the tires available as standard or optional equipment on General Motors vehicles may vary with respect to these grades, all such tires meet General Motors performance standards and have been approved for use on General Motors vehicles. All passenger type (P Metric) tires must conform to Federal safety requirements in addition to these grades.

Wheel Alignment and Tire Balance

The wheels on your vehicle were aligned and balanced carefully at the factory to give you the longest tire life and best overall performance.

In most cases, you will not need to have your wheels aligned again. However, if you notice unusual tire wear or your vehicle pulling one way or the other, the alignment may need to be reset. If you notice your vehicle vibrating when driving on a smooth road, your wheels may need to be rebalanced.

Wheel Replacement

Replace any wheel that is bent, cracked or badly rusted. If wheel nuts keep coming loose, the wheel, wheel bolts, and wheel nuts should be replaced. If the wheel leaks air out, replace it (except some aluminum wheels, which can sometimes be repaired). See your Pontiac dealer if any of these conditions exist.

Your dealer will know what kind of wheel you need.

Each new wheel should have the same load carrying capacity, diameter, width, offset, and be mounted the same way as the one it replaces.

If you need to replace any of your wheels, wheel bolts, or wheel nuts, replace them only with **new** GM original equipment parts. This way, you will be sure you have the right wheel, wheel bolts, and wheel nuts for your Pontiac model.

CAUTION



Using the wrong replacement wheels, wheel bolts, or wheel nuts on your vehicle can be dangerous. It could affect the braking and handling of your vehicle, make your tires lose air and make you lose control. You could have a collision in which you or others could be injured. Always use the correct wheel, wheel bolts, and wheel nuts for replacement.

Service & Appearance Care

Wheel Replacement (CONT.)

NOTICE

The wrong wheel can also cause problems with bearing life, brake cooling, speedometer/odometer calibration, headlight aim, bumper height, vehicle ground clearance, and tire or tire chain clearance to the body and chassis.

Used Replacement Wheels

CAUTION



Putting a used wheel on your vehicle is dangerous. You can't know how it's been used or how many miles it's been driven. It could fail suddenly and cause an accident. If you have to replace a wheel, use a **new GM original equipment wheel**.

Tire Chains

NOTICE

Use tire chains only when you must. Use only SAE Class "S" type chains that are the proper size for your tires. Install them on the front tires and tighten them as tightly as possible with the ends securely fastened. Drive slowly and follow the chain manufacturer's instructions. If you can hear the chains contacting your vehicle, stop and retighten them. If the contact continues, slow down until it stops. Driving too fast with chains on will damage your vehicle.



■ Appearance Care

CAUTION

 Cleaning products can be hazardous. Some are toxic. Others can burst into flame if you strike a match or get them on a hot part of the vehicle. Some are dangerous if you breathe their fumes in a closed space. When you use anything in a container to clean your Pontiac, be sure to follow the instructions. And always open your doors or windows when you're cleaning the inside.

Never use these to clean your vehicle:

- | | | |
|------------|------------------------|-----------------------|
| ● Gasoline | ● Carbon Tetrachloride | ● Turpentine |
| ● Benzene | ● Acetone | ● Lacquer Thinner |
| ● Naphtha | ● Paint Thinner | ● Nail Polish Remover |

They can all be hazardous—some more than others—and they can all damage your vehicle, too.

NOTICE

Don't use any of these unless this manual says you can. In many uses, they will damage your vehicle:

- Laundry Soap
- Bleach
- Reducing Agents

Service & Appearance Care

Cleaning the Inside of Your Pontiac

Use a vacuum cleaner often to get rid of dust and loose dirt. Wipe vinyl with a clean, damp cloth.

Your Pontiac dealer has two GM cleaners—a solvent-type spot lifter and a foam-type powdered cleaner. They will clean normal spots and stains very well.

Here are some cleaning tips:

- Always read the instructions on the cleaner label.
- Clean up stains as soon as you can—before they set.
- Use a clean cloth or sponge, and change to a clean area often. A soft brush may be used if stains are stubborn.

- Use solvent-type cleaners in a well-ventilated area only. If you use them, don't saturate the stained area.
- If a ring forms after spot cleaning, clean the entire area immediately or it will set.

Using Foam-Type Cleaner on Fabric

- Vacuum and brush the area to remove any loose dirt.
- Always clean a whole trim panel or section. Mask surrounding trim along stitch or welt lines.
- Mix Multi-Purpose Powdered Cleaner following the directions on the container label.
- Use suds only and apply with a clean sponge.

- Don't saturate the material.
- Don't rub it roughly.
- As soon as you've cleaned the section, use a sponge to remove the suds.
- Rinse the section with a clean, wet sponge.
- Wipe off what's left with a slightly damp paper towel or cloth.
- Then dry it immediately with an air hose, a hair dryer or a heat lamp.

NOTICE

Be careful with a hair dryer or heat lamp. You could scorch the fabric.

- Wipe with a clean cloth.

Using Solvent-Type Cleaner on Fabric

First, see if you have to use solvent-type cleaner at all. Some spots and stains will clean off better with just water and mild soap.

If you need to use it, then:

- Gently scrape excess soil from the trim material with a clean, dull knife or scraper. Use very little cleaner, light pressure and clean cloths (preferably cheesecloth). Cleaning should start at the outside of the stain, “feathering” toward the center. Keep changing to a clean section of the cloth.
- When you clean a stain from fabric, immediately dry the area with an air hose, hair dryer, or heat lamp to help prevent a cleaning ring. (See the previous NOTICE.)

Special Cleaning Problems

Greasy or Oily Stains:

Like grease, oil, butter, margarine, shoe polish, coffee with cream, chewing gum, cosmetic creams, vegetable oils, wax crayon, tar and asphalt.

- Carefully scrape off excess stain.
- Then follow the solvent-type instructions above.
- Shoe polish, wax crayon, tar and asphalt will stain if left on a vehicle seat fabric. They should be removed as soon as possible. Be careful, because the cleaner will dissolve them and may cause them to bleed.

Non-Greasy Stains:

Like catsup, coffee (black), egg, fruit, fruit juice, milk, soft drinks, wine, vomit, urine and blood.

- Carefully scrape off excess stain, then sponge the soiled area with cool water.
- If a stain remains, follow the foam-type instructions above.
- If an odor lingers after cleaning vomit or urine, treat the area with a water/baking soda solution: 1 teaspoon (5 ml) of baking soda to 1 cup (250 ml) of lukewarm water.
- Finally, if needed, clean lightly with solvent-type cleaner.

Combination Stains:

Like candy, ice cream, mayonnaise, chili sauce and unknown stains.

- Carefully scrape off excess stain, then clean with cool water and allow to dry.
- If a stain remains, clean it with solvent-type cleaner.

Service & Appearance Care

Cleaning Vinyl or Leather

Just use warm water and a clean cloth.

- Rub with a clean, damp cloth to remove dirt. You may have to do it more than once.
- Things like tar, asphalt and shoe polish will stain if you don't get them off quickly. Use a clean cloth and solvent-type vinyl/leather cleaner.

Cleaning the Top of the Instrument Panel

Use only mild soap and water to clean the top surfaces of the instrument panel. Sprays containing silicones or waxes may cause annoying reflections in the windshield and even make it difficult to see through the windshield under certain conditions.

Care of Safety Belts

Keep belts clean and dry.

CAUTION



Do not bleach or dye safety belts. If you do, it may severely weaken them. In a crash they might not be able to provide adequate protection. Clean safety belts only with mild soap and lukewarm water.

Glass

Glass should be cleaned often. GM Glass Cleaner (GM Part No. 1050427) or a liquid household glass cleaner will remove normal tobacco smoke and dust films.

Don't use abrasive cleaners on glass, because they may cause scratches. Avoid placing decals on the inside rear window, since they may have to be scraped off later.

If abrasive cleaners are used on the inside of the rear window, an electric defogger element may be damaged. Any temporary license should not be attached across the defogger grid.

Cleaning the Outside of the Windshield and Wiper Blades

If the windshield is not clear after using the windshield washer, or if the wiper blade chatters when running, wax or other material may be on the blade or windshield.

Clean the outside of the windshield with GM Windshield Cleaner, Bon-Ami Powder® (GM Part No. 1050011). The windshield is clean if beads do not form when you rinse it with water.

Clean the blade by wiping vigorously with a cloth soaked in full strength windshield washer solvent. Then rinse the blade with water.

Wiper blades should be checked on a regular basis and replaced when worn.

Cleaning the Outside of Your Pontiac

The paint finish on your vehicle provides beauty, depth of color, gloss retention and durability.

Washing Your Vehicle

The best way to preserve your vehicle's finish is to keep it clean by washing it often with lukewarm or cold water.

Don't wash your vehicle in the direct rays of the sun. Don't use strong soaps or chemical detergents. Use liquid hand, dish or car washing (non-detergent) soaps. Don't use cleaning agents that contain acid or abrasives. All cleaning agents should be flushed promptly and not allowed to dry on the surface, or they could stain. Dry the finish with a soft, clean chamois or a 100% cotton towel to avoid surface scratches and water spotting.

High pressure vehicle washes may cause water to enter your vehicle.

Service & Appearance Care

Finish Care

Occasional waxing or mild polishing of your Pontiac may be necessary to remove residue from the paint finish. You can get GM approved cleaning products from your dealer. (See the *Index* under *Appearance Care*.)

Your Pontiac has a "basecoat/clearcoat" paint finish. The clearcoat gives more depth and gloss to the colored basecoat.

NOTICE

Machine compounding or aggressive polishing on a basecoat/clearcoat paint finish may dull the finish or leave swirl marks.

Aluminum Wheels (IF SO EQUIPPED)

Your aluminum wheels have a protective coating similar to the painted surface of your Pontiac. Don't use strong soaps, chemicals, chrome polish, or other abrasive cleaners on them because you could damage this coating. After rinsing thoroughly, a wax may be applied.

NOTICE

If you have aluminum wheels, don't use an automatic vehicle wash that has hard silicon carbide cleaning brushes. These brushes can take off the protective coating.

White Sidewall Tires

Your Pontiac dealer has a GM White Sidewall Tire Cleaner. You can use a stiff brush with it.

Weatherstrips

These are places where glass or metal meets rubber. Silicone grease there will make them last longer, seal better, and not squeak. Apply silicone grease with a clean cloth at least every six months.

Sheet Metal Damage

If your vehicle is damaged and requires sheet metal repair or replacement, make sure the body repair shop applies anti-corrosion material to the parts repaired or replaced to restore corrosion protection.

Foreign Material

Calcium chloride and other salts, ice melting agents, road oil and tar, tree sap, bird droppings, chemicals from industrial chimneys, and other foreign matter can damage your vehicle's finish if they remain on painted surfaces. Use cleaners that are marked safe for painted surfaces for these stains.

Finish Damage

Any stone chips, fractures or deep scratches in the finish should be repaired right away. Bare metal will corrode quickly and may develop into a major repair expense.

Minor chips and scratches can be repaired with touch-up materials available from your dealer or other service outlets. Larger areas of finish damage can be corrected in your dealer's body and paint shop.

Service & Appearance Care

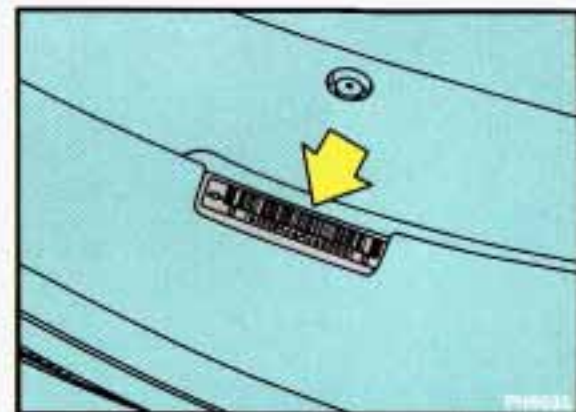

Underbody Maintenance

Chemicals used for ice and snow removal and dust control can collect on the underbody. If these are not removed, accelerated corrosion (rust) can occur on the underbody parts such as fuel lines, frame, floor pan, and exhaust system even though they have corrosion protection.

At least every spring, flush these materials from the underbody with plain water. Clean any areas where mud and other debris can collect. Dirt packed in closed areas of the frame should be loosened before being flushed. Your dealer or an underbody vehicle washing system can do this for you.

Chemical Paint Spotting

Some weather and atmospheric conditions can create a chemical fallout. Airborne pollutants can fall upon and attack painted surfaces on your vehicle. This damage can take two forms: blotchy, ringlet-shaped discolorations, and small irregular dark spots etched into the paint surface.

Although no defect in the paint job causes this, Pontiac will repair, at no charge to the owner, the surfaces of new vehicles damaged by this fallout condition within 12 months or 12,000 miles (20 000 km) of purchase, whichever comes first.

Vehicle Identification Number (VIN)

This is the legal identifier for your Pontiac. It appears on a plate in the front corner of the instrument panel, on the driver's side. You can see it if you look through the windshield from outside your vehicle. The VIN also appears on the Vehicle Certification and Service Parts labels and the certificates of title and registration.

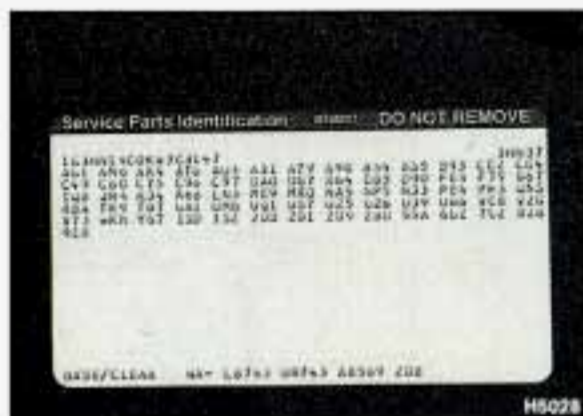

Engine Identification

The eighth character in your VIN is the engine code for your GM engine. This code will help you identify your engine, specifications, and replacement parts in this section.

Service Parts Identification Label

You'll find this label on your spare tire cover. It's very helpful if you ever need to order parts. On this label is:

- Your VIN.
- Its model designation.
- Paint information.
- A list of all production options and special equipment.

Be sure that this label is not removed from the vehicle.

Add-On Electrical Equipment

NOTICE

Don't add anything electrical to your Pontiac unless you check with your dealer first. Some electrical equipment can damage your vehicle and the damage wouldn't be covered by your warranty. Some of it can just keep other things from working as they should.

Service & Appearance Care

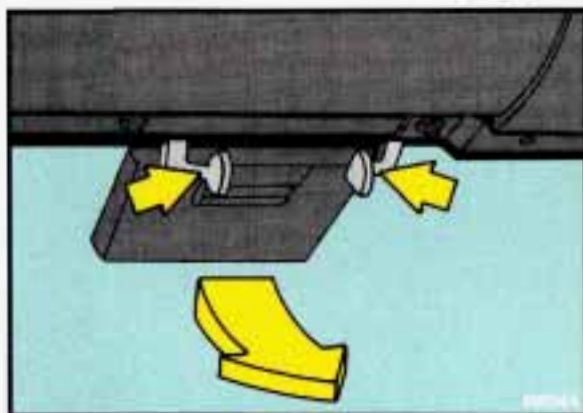

Fuses & Circuit Breakers

The wiring circuits in your vehicle are protected from short circuits by a combination of fuses and circuit breakers.

The main fuse panel is located to the left of the steering wheel, under the instrument panel. Pinch the release levers to lower the fuse panel for ease of viewing, then pull the fuse panel toward you to lock it down.

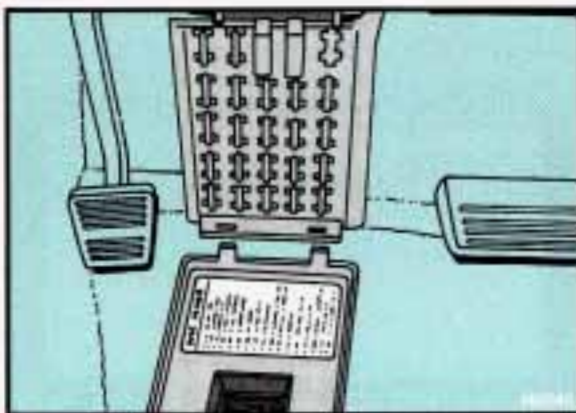

Snap off the cover to reveal the fuses. You'll find a fuse puller clipped to the inside of the cover. Place the wide end of the fuse puller over the plastic end of the fuse. Squeeze the ends over the fuse and pull it out.

Spare fuses are located in the slots labeled "Spare" on the following chart.

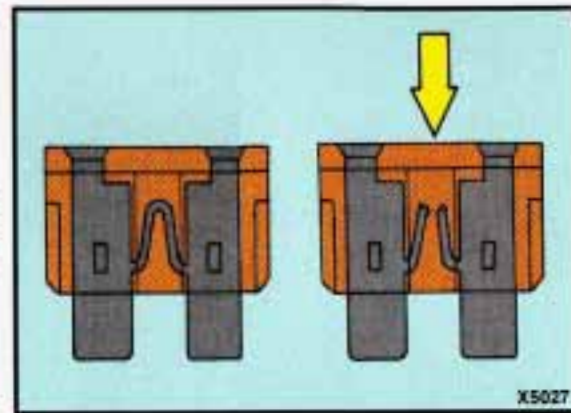

Look at the silver-colored band inside the fuse. If the band is broken or melted, replace the fuse. Be sure you replace a bad fuse with a new one of the correct size.

When finished, replace the cover and pinch the release levers again to unlock the panel. Press it back up into place.

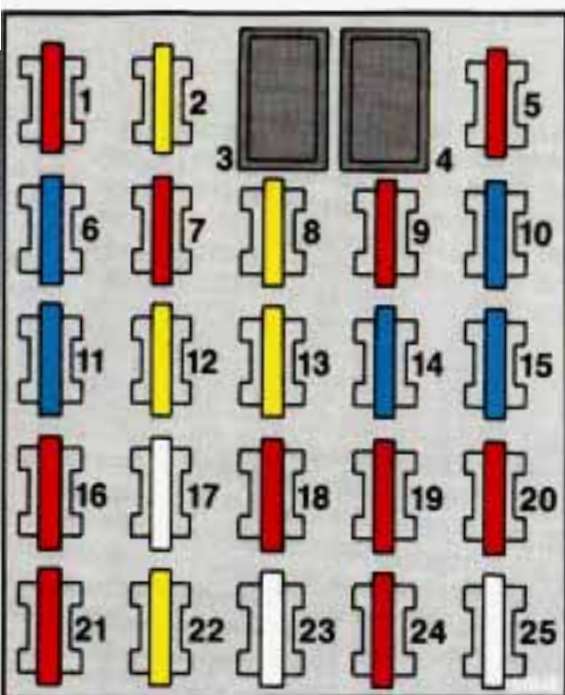

Left Side Fuse Panel

Fuses & Circuit Breakers

Position	Rating (AMP.)	Circuitry
1	10	Start-Up Signal—SIR
2	20	Trunk Release/Back-Up Lights/Brake-Shift Interlock (with Retained Accessory Power Option)
3	30	Breaker-Power Window/Sunroof
4	30	Breaker-Power Accessory
5	10	Heated Mirror/Compass
6	15	Ignition/Retained Accessory Power/Illuminated Entry/Keyless Entry
7	10	Supplemental Inflatable Restraint (Air Bag)
8	20	Cornering Lights/Turn Signals/(Back-Up Lights/Trunk Release/Brake-Shift Interlock without Retained Accessory Power Option)
9	10	Spare
10	15	Spare
11	15	Battery/Radio/Instrument Panel/Oil Level
12	20	Electronic Level Control
13	20	Brake/Hazard Warning Flashers
14	15	Parking Lights
15	15	Courtesy Lights/Power Mirrors
16	10	Cooling Fan/Transaxle
17	25	Air Conditioning
18		Blank
19	10	Anti-Lock Brake System
20	10	Low Coolant/Light Monitor/Oil Level/HUD/Compass
21	10	Instrument Panel Lighting
22	20	Spare
23	25	Spare
24	10	Ignition/Radio
25	25	Wiper/Washer

Service & Appearance Care

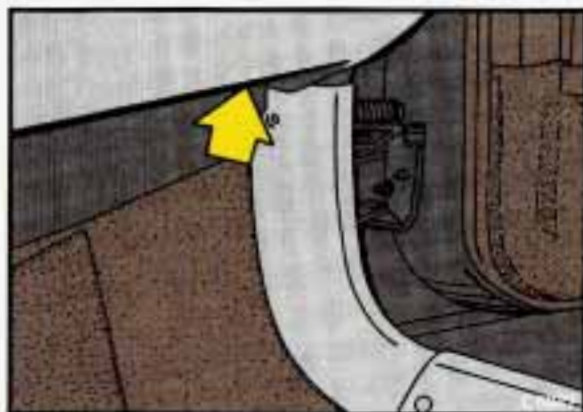

Right Side Fuse Panel

Additional fuses are located in the relay center, on the far right side, below the instrument panel. You must remove the sound insulator on the right side of the passenger foot well to replace these fuses.

Replacing these fuses is difficult. We recommend that you see your dealer if you need one replaced.

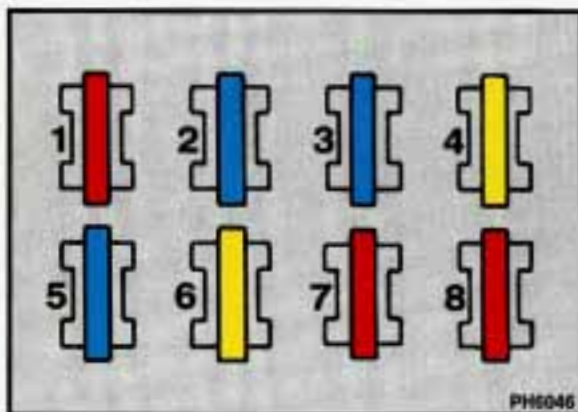

Fuses

Position	Rating (AMP.)	Circuitry
1	10	A/C Programmer
2	15	Fog Lamps
3	15	Power Antenna/Door Locks
4	20	Horns
5	15	Engine Relays and Miscellaneous Engine Content
6	20	Fuel Pump
7	10	Fuel Injectors
8	10	Engine Control Module, PASS-Key™

Maxifuse/Relay Center

To check the fuses in this underhood fuse center, turn the two knobs ¼ turn counterclockwise and loosen the metal wing nut on the passenger side of the cover. Then remove the cover. The inside of the cover has a chart that explains the features and controls governed by each fuse and relay.

Headlight Wiring

The headlight wiring is protected by a circuit breaker in the light switch. An electrical overload will cause the lights to go on and off, or in some cases to remain off. If this happens, have your headlight system checked right away.

Windshield Wipers

The windshield wiper motor is protected by a circuit breaker and a fuse. If the motor overheats due to heavy snow, etc., the wiper will stop until the motor cools. If the overload is caused by some electrical problem, have it fixed.

Power Windows and Other Power Options

Circuit breakers in the fuse panel protect the power windows and other power accessories. When the current load is too heavy, the circuit breaker opens and closes, protecting the circuit until the problem is fixed.

Service & Appearance Care

Capacities & Specifications

Automatic Transaxle AT 440-T4 (Overdrive)

When draining or replacing torque converter, more fluid may be needed.

Pan Removal and Replacement	6½ quarts	6.00 L
After Complete Overhaul	11 quarts	10.50 L

Cooling System	13 quarts	12.00 L
----------------------	-----------	---------

Refrigerant, Air Conditioning	See refrigerant charge label under hood.	
-------------------------------------	--	--

Not all air conditioning refrigerants are the same. If the air conditioning system in your vehicle needs refrigerant, be sure the proper refrigerant is used. If you're not sure, ask your Pontiac dealer.

Engine Crankcase	4 quarts	3.75 L
------------------------	----------	--------

When changing filter, up to 1 quart (1 liter) more oil may be needed.

Fuel Tank	18 gallons	68.00 L
-----------------	------------	---------

Power Steering

Pump Only	1 pint	0.50 L
Complete System	1½ pints	0.75 L

Tire Pressures, Sizes	See Tire-Loading Information label on driver's door.	
-----------------------------	--	--

Wheel Nut Torque	100 pound-feet (140 N·m)	
------------------------	--------------------------	--

NOTE: All capacities are approximate. When adding, be sure to fill to the appropriate level, as recommended in this manual.

Engine Specifications

3800 Tuned Port Injection and 3800 Supercharged Engines

VIN Engine Code (Tuned Port)	L
VIN Engine Code (Supercharged) . . .	1
Type	V6
Displacement	3.8 Liters
Compression Ratio	8.5:1 (Code L) 9.0:1 (Code 1)
Firing Order	1-6-5-4-3-2
Thermostat Temperature Specification	195° F (91° C)

Normal Maintenance Replacement Parts

Air Cleaner Element	AC Type A-1096C
Engine Oil Filter	AC Type PF-47
PCV Valve	AC Type CV-892C
Remote Lock Control Battery (2)	2016
Spark Plugs	AC Type 41-600 Gap: 0.060 inch (1.52 mm)

Service & Appearance Care

Fluids & Lubricants

ITEM	APPLICATION	GM PART NUMBER	SIZE
Antifreeze Coolant (Ethylene Glycol Base)	Year-round antifreeze for coolant mixtures	1052753	1 gal. (3.8 L)
Chassis Lubricant (Grease Gun Insert)	General chassis lube, etc.	1052497	14 oz. (397 g)
Delco Supreme 11 [®] Brake Fluid	Brake System	1052535	16 oz. (0.5 L)
DEXRON [®] IIE Automatic Transmission Fluid	Automatic Transaxle	12345881 12345006	32 oz. (1.0 L) 1 gal. (3.8 L)
Engine Oil	Engine lubrication	See <i>Engine Oil</i> in this section.	
GM Engine Oil Supplement (E.O.S.)	See your dealer for advice	1052367	16 oz. (0.5 L)
Engine Oil	Hood, trunk and door hinges		
Windshield Washer Solvent	Windshield washer fluid		
Power Steering Fluid (Normal)	Power Steering System	1050017 1052884	32 oz. (1.0 L) 16 oz. (0.5 L)
Power Steering Fluid (Cold Climate) (System must be drained and refilled with it.)	Power Steering System	12345867 12345866	32 oz. (1.0 L) 16 oz. (0.5 L)
Silicone Grease	Weatherstrips	12345579	1 oz. (28 g)
Spray-A-Squeak Silicone Lubricant	General purpose silicone lubricant	1052276 (aerosol) 1052277	4.5 oz. (127 g) 12 oz. (0.35 L)
Supercharger Oil	Supercharger lubricant	12345982	4 oz. (113 g)

Replacement Bulbs

OUTSIDE LIGHTS	BULB	LAMP (Light) MONITOR MESSAGE (OPTION)
Halogen Headlights		
Low Beam	9006	HEAD LAMP
High Beam	9005	HIGH BEAM LAMP
Front Park/Turn		
Front Park	2057NA	PARK LAMP
Front Turn	2057NA	TURN SIGNAL LAMP
Front Side Marker	194	PARK LAMP
Taillights		
Taillights	194/2057	TAIL LAMP
Stoplights	2057	BRAKE LAMP
Rear Turn	1156	TURN SIGNAL LAMP
Rear Side Marker	194	TAIL LAMP
Back-Up Lights	1141	BACK UP LAMP
Center High-Mounted Stop Light	1156	BRAKE LAMP
License Plate Light	194	TAIL LAMP
Fog Light	880	
Trunk Light	93	
Underhood Light	561	

Service & Appearance Care

Replacement Bulbs (CONT.)

INSIDE LIGHTS	BULB
Courtesy Lights	74
Front Courtesy/Reading Lights	563
Rail Courtesy/Reading Lights	A3173B
Glove Compartment Light	194
Turn Signal Indicators	74
Visor Vanity Light	7065
Hush Panel (Lower Floor Lighting)	168
Ash Tray	161

IMPORTANT
KEEP ENGINE OIL
AT THE PROPER
LEVEL AND CHANGE AS
RECOMMENDED

Part **7**

Maintenance Schedule

Section

This part covers the maintenance required for your Pontiac. Your vehicle needs these services to retain its safety, dependability and emission control performance.



Have you purchased the
GM Protection Plan?
The Plan supplements your
new vehicle warranties.
See your Pontiac dealer for details.

Introduction

A Word About Maintenance	276
Your Vehicle and the Environment	276
How This Part is Organized	277
A. Scheduled Maintenance Services	
Using Your Maintenance Schedules	278
Selecting the Right Schedule	278
Schedule I	280
Schedule II	282
Explanation of Scheduled Maintenance Services	284
B. Owner Checks & Services	
At Each Fuel Fill	287
At Least Once a Month	287
At Least Once a Year	288
C. Periodic Maintenance Inspections	290
D. Recommended Fluids & Lubricants	291
E. Maintenance Record	294

Maintenance Schedule

Introduction

A Word About Maintenance

We at General Motors want to help you keep your vehicle in good working condition. But we don't know exactly how you'll drive it. You may drive very short distances only a few times a week. Or you may drive long distances all the time in very hot, dusty weather. You may use your vehicle in making deliveries. Or you may drive it to work, to do errands or in many other ways.

Because of all the different ways people use their GM vehicles, maintenance needs vary. You may even need more frequent checks and replacements than you will find in the schedules in this part. So please read this part and note how you drive. If you have any questions on how to keep your vehicle in good condition, see your Pontiac dealer, the place many GM owners choose to have their maintenance work done. Your dealer can be relied upon to use proper parts and practices.

Your Vehicle and the Environment

Proper vehicle maintenance not only helps to keep your vehicle in good working condition, but also helps the environment. All recommended maintenance procedures are important. Improper vehicle maintenance or the removal of important components can significantly affect the quality of the air we breathe. Improper fluid levels or even the wrong tire inflation can increase the level of emissions from your vehicle. To help protect our environment, and to help keep your vehicle in good condition, please maintain your vehicle properly.

How This Part is Organized

The remainder of this part is divided into five sections:

Section A: Scheduled Maintenance Services shows what to have done and how often. Some of these services can be complex, so unless you are technically qualified and have the necessary equipment, you should let your dealer's service department or another qualified service center do these jobs.

CAUTION



Performing maintenance work on a vehicle can be dangerous. In trying to do some jobs, you can be seriously injured. Do your own maintenance work only if you have the required know-how and the proper tools and equipment for the job. If you have any doubt, have a qualified technician do the work.

If you are skilled enough to do some work on your vehicle, you will probably want to get the service information GM publishes. You will find a list of publications and how to get them in this manual. See the *Index* under *Service Publications*.

Section B: Owner Checks & Services tells you what should be checked whenever you stop for fuel. It also explains what you can easily do to help keep your vehicle in good condition.

Section C: Periodic Maintenance Inspections explains important inspections that your Pontiac dealer's service department or another qualified service center should perform.

Section D: Recommended Fluids & Lubricants lists some products GM recommends to help keep your vehicle properly maintained. These products, or their equivalents, should be used whether you do the work yourself or have it done.

Section E: Maintenance Record provides a place for you to record the maintenance performed on your vehicle. Whenever any maintenance is performed, be sure to write it down in this section. This will help you determine when your next maintenance should be done. In addition, it is a good idea to keep your maintenance receipts. They may be needed to qualify your vehicle for warranty repairs.

Maintenance Schedule

Section A: Scheduled Maintenance Services

Using Your Maintenance Schedules

This section tells you the maintenance services you should have done and when you should schedule them. Your Pontiac dealer knows your vehicle best and wants you to be happy with it. If you go to your dealer for your service needs, you'll know that GM-trained and supported service people will perform the work using genuine GM parts.

These schedules are for vehicles that:

- carry passengers and cargo within recommended limits. You will find these limits on your vehicle's Tire-Loading Information label. See the *Index* under *Loading Your Vehicle*.
- are driven on reasonable road surfaces within legal driving limits.
- use the recommended unleaded fuel. See the *Index* under *Fuel*.

Selecting the Right Schedule

First you'll need to decide which of the two schedules is right for your vehicle. Here's how to decide which schedule to follow:

Schedule I

Is any one of these true for your vehicle?

- Most trips are less than 4 miles (6 km).
- Most trips are less than 10 miles (16 km) when outside temperatures are below freezing.
- The engine is at low speed most of the time (as in door-to-door delivery, or in stop-and-go traffic).
- You operate your vehicle in dusty areas.
- You tow a trailer. (With some models, you shouldn't ever tow a trailer. See the *Index* under *Towing a Trailer*.)

If any one (or more) of these is true for your driving, follow Schedule I.

Schedule II

Follow Schedule II **only** if none of the above conditions is true.

Maintenance Schedule

Section A: Scheduled Maintenance Services [Cont.]

Schedule I

Follow Schedule I if your vehicle is **MAINLY** driven under one or more of the following conditions:

- When most trips are less than 4 miles (6 kilometers).
- When most trips are less than 10 miles (16 kilometers) and outside temperatures remain below freezing.
- When most trips include extended idling and/or frequent low-speed operation, as in stop-and-go traffic.
- When towing a trailer. (With some models, you shouldn't ever tow a trailer. See the *Index* under *Towing a Trailer*.)
- When operating in dusty areas.

Schedule I should also be followed if the vehicle is used for delivery service, police, taxi or other commercial applications.

ITEM NO.	TO BE SERVICED <i>See Explanation of Scheduled Maintenance Services following Schedules I and II.</i>	WHEN TO PERFORM <i>Miles (kilometers) or Months (whichever occurs first).</i>
1	Engine Oil Change & Oil Filter Change*	Every 3,000 Miles (5 000 km) or 3 Months.
2	Chassis Lubrication	Every other oil change.
3	Throttle Body Mounting Bolt Torque*	At 6,000 Miles (10 000 km) only.
4	Tire and Wheel Rotation & Inspection	At 6,000 Miles (10 000 km) and every 15,000 Miles (25 000 km) or as necessary.
5	Engine Accessory Drive Belt Inspection*	Every 30,000 Miles (50 000 km) or 24 Months.
6	Cooling System Service*	Every 30,000 Miles (50 000 km) or 24 Months.
7	Transaxle Service	<i>See Explanation of Scheduled Maintenance Services following Schedules I and II.</i>
8	Spark Plug Replacement*	Every 30,000 Miles (50 000 km).
9	Spark Plug Wire Inspection* :-	Every 30,000 Miles (50 000 km).
10	Air Cleaner Filter Replacement*	Every 30,000 Miles (50 000 km).
11	Fuel Tank, Cap & Lines Inspection* :-	Every 30,000 Miles (50 000 km).
12	Supercharger Oil Check (3.8L Code I engine only)	Every 30,000 Miles (50 000 km) or 36 Months.

Maintenance Schedule

Section A: Scheduled Maintenance Services (Cont.)

Schedule II

Follow Schedule II ONLY if none of the driving conditions specified in Schedule I apply.

ITEM NO.	TO BE SERVICED <i>See Explanation of Scheduled Maintenance Services following Schedules I and II.</i>	WHEN TO PERFORM <i>Miles (kilometers) or Months (whichever occurs first).</i>
1	Engine Oil Change *	Every 7,500 Miles (12 500 km) or 12 Months.
	Oil Filter Change *	At first and every other oil change.
2	Chassis Lubrication	Every 7,500 Miles (12 500 km) or 12 Months.
3	Throttle Body Mounting Bolt Torque*	At 7,500 Miles (12 500 km) only.
4	Tire and Wheel Rotation & Inspection	At 7,500 Miles (12 500 km) and then every 15,000 Miles (25 000 km) or as necessary.
5	Engine Accessory Drive Belt Inspection*	Every 30,000 Miles (50 000 km) or 24 Months.
6	Cooling System Service*	Every 30,000 Miles (50 000 km) or 24 Months.
7	Transaxle Service	<i>See Explanation of Scheduled Maintenance Services following Schedules I and II.</i>
8	Spark Plug Replacement *	Every 30,000 Miles (50 000 km).
9	Spark Plug Wire Inspection* ☺	Every 30,000 Miles (50 000 km).
10	Air Cleaner Filter Replacement*	Every 30,000 Miles (50 000 km).
11	Fuel Tank, Cup and Lines Inspection* ☺	Every 30,000 Miles (50 000 km).
12	Supercharger Oil Check (3.8L Code I engine only)	Every 30,000 Miles (50 000 km) or 36 Months.

The services shown in this schedule up to 45,000 miles (75 000 km) are to be performed after 45,000 miles at the same intervals.

MILES (000)

7.5	15	22.5	30	37.5	45
KILOMETERS (000)					
12.5	25	37.5	50	62.5	75
•	•	•	•	•	•
•		•		•	
•	•	•	•	•	•
•					
•		•		•	
			•		
			•		
			•		
			•		
			•		
			•		
			•		

*An Emission Control Service.

☆ The U.S. Environmental Protection Agency has determined that the failure to perform this maintenance item will not nullify the emission warranty or limit recall liability prior to the completion of vehicle useful life. General Motors, however, urges that all recommended maintenance services be performed at the indicated intervals and the maintenance be recorded in Section E: Maintenance Record.

Maintenance Schedule

Section A: Scheduled Maintenance Services [Cont.]

Explanation of Scheduled Maintenance Services

Below are explanations of the services listed in Schedule I and Schedule II.

ITEM

NO. SERVICE

- 1 Engine Oil and Filter Change***—Always use SG Energy Conserving II oils of proper viscosity. The “SG” designation may be shown alone or in combination with others, such as “SG/CC,” “SG/CD” or “SF, SG, CC,” etc. To determine the preferred viscosity for your vehicle’s engine (e.g., SAE 5W-30 or SAE 10W-30), see the *Index* under *Engine Oil*.
- 2 Chassis Lubrication**—Lubricate the transaxle shift linkage, parking brake cable guides, underbody contact points and linkage. Lubricate the front and rear suspension and steering linkage.

*An Emission Control Service.

☆ The U.S. Environmental Protection Agency has determined that the failure to perform this maintenance item will not nullify the emission warranty or limit recall liability prior to the completion of vehicle useful life. General Motors, however, urges that all recommended maintenance services be performed at the indicated intervals and the maintenance be recorded in Section E: Maintenance Record.

The proper fluids and lubricants to use are listed in Section D. Make sure whoever services your vehicle uses these. All parts should be replaced and all necessary repairs done before you or anyone else drives the vehicle.

ITEM

NO. SERVICE

- 3 Throttle Body Mounting Bolt Torque***—Check the torque of the mounting bolts and/or nuts.
- 4 Tire and Wheel Rotation and Inspection**—For proper wear and maximum tire life, rotate your tires following the instructions in this manual. See the *Index* under *Tires, Inspection & Rotation*. Check the tires for uneven wear or damage. If you see irregular or premature wear, check the wheel alignment. Check for damaged wheels also.

**ITEM
NO. SERVICE**

- 5 Engine Accessory Drive Belt Inspection***—Inspect the belt for cracks, fraying, wear and proper tension. Replace as needed.
- 6 Cooling System Service***—Drain, flush and refill the system with new or approved recycled coolant conforming to GM Specification 1825M. Keep coolant at the proper mixture as specified. See the *Index* under *Coolant*. This provides proper freeze protection, corrosion inhibitor level and engine operating temperature.
- Inspect hoses and replace if they are cracked, swollen or deteriorated. Tighten screw-type hose clamps. Clean the outside of the radiator and air conditioning condenser. Wash the pressure cap and neck.
- To help ensure proper operation, we recommend a pressure test of both the cooling system and the pressure cap.

**ITEM
NO. SERVICE**

- 7 Transaxle Service**—Change both the fluid and filter every 15,000 miles (25 000 km) if the vehicle is mainly driven under one or more of these conditions:
- In heavy city traffic where the outside temperature regularly reaches 90°F (32°C) or higher.
 - In hilly or mountainous terrain.
 - When doing frequent trailer towing.
 - Uses such as found in taxi, police car or delivery service.
- If you do not use your vehicle under any of these conditions, change both the fluid and filter every 100,000 miles (160 000 km).
- 8 Spark Plug Replacement***—Replace spark plugs with the proper type. See the *Index* under *Replacement Parts*.

Maintenance Schedule

Section A: Scheduled Maintenance Services [Cont.]

ITEM NO.	SERVICE
----------	---------

- | | |
|----|--|
| 9 | Spark Plug Wire Inspection* ☆—Inspect for burns, cracks or other damage. Check the boot fit at the coils and at the spark plugs. Replace wires as needed. |
| 10 | Air Cleaner Filter Replacement* —Replace every 30,000 miles (50 000 km) or more often under dusty conditions. Ask your dealer for the proper replacement intervals for your driving conditions. |

ITEM NO.	SERVICE
----------	---------

- | | |
|----|--|
| 11 | Fuel Tank, Cap and Lines Inspection* ☆—Inspect fuel tank, cap and lines (including fuel rails and injection assembly) for damage or leaks. Inspect fuel cap gasket for an even filler neck imprint or any damage. Replace parts as needed. Periodic replacement of the fuel filter is not required. |
| 12 | Supercharger Oil Check —Check oil every 30,000 miles (50 000 km) or 36 months. Add the proper synthetic oil. See the <i>Index</i> under <i>Recommended Fluids & Lubricants</i> . |

*An Emission Control Service.

☆ The U.S. Environmental Protection Agency has determined that the failure to perform this maintenance item will not nullify the emission warranty or limit recall liability prior to the completion of vehicle useful life. General Motors, however, urges that all recommended maintenance services be performed at the indicated intervals and the maintenance be recorded in Section E: Maintenance Record.

Section B: Owner Checks & Services

Listed below are owner checks and services which should be performed at the intervals specified to help ensure the safety, dependability and emission control performance of your vehicle.

Be sure any necessary repairs are completed at once. Whenever any fluids or lubricants are added to your vehicle, make sure they are the proper ones, as shown in Section D.

At Each Fuel Fill (It is important for you or a service station attendant to perform these underhood checks at each fuel fill.)

CHECK OR SERVICE	WHAT TO DO
Engine Oil Level	Check the engine oil level and add the proper oil if necessary. See the <i>Index</i> under <i>Engine Oil</i> for further details.
Engine Coolant Level	Check the engine coolant level in the coolant recovery tank and add the proper coolant mix if necessary. See the <i>Index</i> under <i>Coolant</i> for further details.
Windshield Washer Fluid Level	Check the windshield washer fluid level in the windshield washer tank and add the proper fluid if necessary. See the <i>Index</i> under <i>Windshield Washer Fluid</i> for further details.

At Least Once a Month



CHECK OR SERVICE	WHAT TO DO
Tire Inflation	Check tire inflation. Make sure they are inflated to the pressures specified on the Tire-Loading Information label located on the rear edge of the driver's door. See the <i>Index</i> under <i>Tires</i> for further details.

Maintenance Schedule

Section B: Owner Checks & Services (Cont.)

At Least Once a Year

CHECK OR SERVICE	WHAT TO DO
Key Lock Cylinders	Lubricate the key lock cylinders with the lubricant specified in Section D.
Body Lubrication	Lubricate all body door hinges. Also lubricate all hinges and latches, including those for the hood, rear compartment, glove box door, console doors and any folding seat hardware. Section D tells you what to use.
Starter Switch	CAUTION
	 When you are doing this check, the vehicle could move suddenly. If it does, you or others could be injured. Follow the steps below. <ol style="list-style-type: none">1. Before you start, be sure you have enough room around the vehicle.2. Firmly apply both the parking brake (see the <i>Index</i> under <i>Parking Brake</i> if necessary) and the regular brake. NOTE: Do not use the accelerator pedal, and be ready to turn off the engine immediately if it starts.3. Try to start the engine in each gear. The starter should work only in P (Park) or N (Neutral). If the starter works in any other position, your vehicle needs service.
Steering Column Lock	While parked, and with the parking brake set, try to turn the key to Lock in each shift lever position. <ul style="list-style-type: none">• The key should turn to Lock only when the shift lever is in P (Park).• The key should come out only in Lock.

CHECK OR SERVICE	WHAT TO DO
Brake-Transaxle Shift Interlock (BTSI)	<p>CAUTION</p> <p> When you are doing this check, the vehicle could move suddenly. If it does, you or others could be injured. Follow the steps below.</p> <ol style="list-style-type: none"> 1. Before you start, be sure you have enough room around the vehicle. It should be parked on a level surface. 2. Firmly apply the parking brake (see the <i>Index</i> under <i>Parking Brake</i> if necessary). NOTE: Be ready to apply the regular brake immediately if the vehicle begins to move. 3. With the engine off, turn the key to the Run position, but don't start the engine. Without applying the regular brake, try to move the shift lever out of P (Park) with normal effort. If the shift lever moves out of P (Park), your vehicle's BTSI needs service.
Parking Brake and Automatic Transaxle P (Park) Mechanism Check	<p>CAUTION</p> <p> When you are doing this check, your vehicle could begin to move. You or others could be injured and property could be damaged. Make sure there is room in front of your vehicle in case it begins to roll. Be ready to apply the regular brake at once should the vehicle begin to move.</p> <p>Park on a fairly steep hill, with the vehicle facing downhill. Keeping your foot on the regular brake, set the parking brake.</p> <ul style="list-style-type: none"> • To check the parking brake: With the engine running and transaxle in N (Neutral), slowly remove foot pressure from the regular brake pedal. Do this until the vehicle is held by the parking brake only. • To check the P (Park) mechanism's holding ability: Shift to P (Park). Then release all brakes.
Underbody Flushing	At least every spring, use plain water to flush any corrosive materials from the underbody. Take care to clean thoroughly any areas where mud and other debris can collect.

Maintenance Schedule

Section C: Periodic Maintenance Inspections

Listed below are inspections and services which should be performed at least twice a year (for instance, each spring and fall). You should let your GM dealer's service department or other qualified service center do these jobs. Make sure any necessary repairs are completed at once.

INSPECTION OR SERVICE	WHAT SHOULD BE DONE
Steering, Suspension and Front-Wheel-Drive Axle Boot and Seal Inspection	Inspect the front and rear suspension and steering system for damaged, loose or missing parts, signs of wear, or lack of lubrication. Inspect the power steering lines and hoses for proper hookup, binding, leaks, cracks, chafing, etc. Clean and then inspect the drive axle boot seals for damage, tears or leakage. Replace seals if necessary.
Exhaust System Inspection	Inspect the complete exhaust system. Inspect the body near the exhaust system. Look for broken, damaged, missing or out-of-position parts as well as open seams, holes, loose connections, or other conditions which could cause a heat build-up in the floor pan or could let exhaust fumes into the vehicle. See the <i>Index</i> under <i>Engine Exhaust</i> .
Throttle Linkage Inspection	Inspect the throttle linkage for interference or binding, and for damaged or missing parts. Replace parts as needed.
Brake System Inspection	Inspect the complete system. Inspect brake lines and hoses for proper hookup, binding, leaks, cracks, chafing, etc. Inspect disc brake pads for wear and rotors for surface condition. Also inspect drum brake linings for wear and cracks. Inspect other brake parts, including drums, wheel cylinders, calipers, parking brake, etc. Check parking brake adjustment. You may need to have your brakes inspected more often if your driving habits or conditions result in frequent braking. NOTE: A low brake fluid level can indicate worn disc brake pads which may need to be serviced. Also, if the brake system warning light stays on or comes on, something may be wrong with the brake system. See the <i>Index</i> under <i>Brake System Warning Light</i> . If your anti-lock brake system warning light stays on or comes on, something may be wrong with the anti-lock brake system. See the <i>Index</i> under <i>Anti-Lock Brake System Warning Light</i> .

Section D: Recommended Fluids & Lubricants

NOTE: Fluids and lubricants identified below by name, part number or specification may be obtained from your GM dealer.

USAGE	FLUID/LUBRICANT
Engine Oil	GM Goodwrench Motor Oil or equivalent for API service SG Energy Conserving II oils of the proper viscosity. The "SG" designation may be shown alone or in combination with others, such as "SG/CC," "SG/CD," or "SF, SG, CC," etc. To determine the preferred viscosity for your vehicle's engine, see the <i>Index</i> under <i>Engine Oil</i> .
Engine Coolant	A 50/50 mixture of water (preferably distilled) and good quality ethylene glycol base antifreeze (GM Part No. 1052753 or equivalent) conforming to GM Specification 1825M or approved recycled coolant conforming to GM Specification 1825M.
Hydraulic Brake System	Delco Supreme II [®] Brake Fluid (GM Part No. 1052535) or equivalent DOT-3 brake fluid.
Parking Brake Guides	Chassis lubricant meeting requirements of NLGI Grade 2, Category LB or GC-LB (GM Part No. 1052497 or equivalent).
Power Steering System	GM Hydraulic Power Steering Fluid (GM Part No. 1052884) or equivalent.
Automatic Transaxle	DEXRON [®] -III Automatic Transmission Fluid (GM Part No. 12345881).
Supercharger	Supercharger Oil (GM Part No. 12345982).

Maintenance Schedule

Section D: Recommended Fluids & Lubricants [Cont.]

USAGE	FLUID/LUBRICANT
Key Lock Cylinders	Lubricate with Multi-Purpose Lubricant (GM Part No. 12345120), synthetic SAE 5W-30 engine oil or silicone lubricant (GM Part No. 1052276 or 1052277).
Automatic Transaxle Shift Linkage	Engine oil.
Floor Shift Linkage	Engine oil.
Chassis Lubrication	Chassis lubricant meeting requirements of NLGI Grade 2, Category LB or GC-LB (GM Part No. 1052497 or equivalent).
Windshield Washer Solvent	GM Optikleen [®] Washer Solvent (GM Part No. 1051515) or equivalent.

USAGE	FLUID/LUBRICANT
Hood Latch Assembly a. Pivots and Spring Anchor b. Release Pawl	a. Engine oil. b. Chassis lubricant meeting requirements of NLGI Grade 2, Category LB or GC-LB (GM Part No. 1052497 or equivalent).
Hood and Door Hinges, Fuel Door Hinge, Rear Compartment Lid Hinges	Engine oil or Lubriplate Lubricant (GM Part No. 1050109).
Weatherstrips	Dielectric Silicone Grease (GM Part No. 12345579 or equivalent).

See the *Index* under *Replacement Parts* for recommended replacement filters, valves and spark plugs.

Maintenance Schedule

Section E: Maintenance Record

After the scheduled services are performed, record the date, odometer reading and who performed the service in the columns indicated. When completing the Maintenance Performed column, insert the numbers from the Schedule I

or Schedule II maintenance charts which correspond to the maintenance performed. Also, you should retain all maintenance receipts. Your owner information portfolio is a convenient place to store them.

<i>DATE</i>	<i>ODOMETER READING</i>	<i>SERVICED BY</i>	<i>MAINTENANCE PERFORMED</i>



Part **8**

Customer Assistance Information

Here you will find out how to contact Pontiac if you need assistance. This part also tells you how to obtain service publications and how to report any safety defects.

Customer Satisfaction Procedure	298
Customer Assistance for the Hearing or Speech Impaired	299
BBB Mediation/Arbitration Program	300
Reporting Safety Defects	302
Pontiac Roadside Assistance Program	303
Service Publications	304

Customer Assistance Information



Customer Satisfaction Procedure

Your satisfaction and goodwill are important to your dealer and Pontiac. Normally, any concern with the sales transaction or the operation of your vehicle will be resolved by your dealer's Sales or Service Departments. Sometimes, however, despite the best intentions of all concerned, misunderstandings can occur. If your concern has not been resolved to your satisfaction, the following steps should be taken:

STEP ONE: Discuss your concern with a member of dealership management. Complaints can often be quickly resolved at that level. If the matter has already been reviewed with the Sales, Service, or Parts Manager, contact the owner of the dealership or the General Manager.

STEP TWO: If after contacting a member of Dealership Management, it appears your concern cannot be resolved by the dealership without further help, contact the Pontiac Customer Assistance Center by calling 1-800-PM CARES. In Canada, contact GM of Canada Customer Assistance Centre in Oshawa by calling 1-800-263-3777 (English) or 1-800-263-7854 (French).

In Mexico, call (525) 254-3777. In Puerto Rico or U.S. Virgin Islands, call 1-809-763-1315. In all other overseas locations, contact GM International Export Sales in Canada by calling 1-416-644-4112.

For prompt assistance, please have the following information available to give the Customer Assistance Representative:

- Your name, address, telephone number
- Vehicle Identification Number (This is available from the vehicle registration or title, or the plate attached to the left top of the instrument panel and visible through the windshield.)
- Dealership name and location
- Vehicle delivery date and present mileage
- Nature of concern

We encourage you to call the toll free number listed previously in order to give your inquiry prompt attention. However, if you wish to write Pontiac, write to:

United States

Pontiac Division
Customer Assistance Center
One Pontiac Plaza
Pontiac, MI 48340

Canada

General Motors of Canada Limited
Customer Assistance Centre
1908 Colonel Sam Drive
Oshawa, Ontario L1H 8P7

A listing of all Pontiac Zone Offices and offices outside the U.S. which can assist you can also be found in the warranty booklet.

When contacting Pontiac, please remember that your concern will likely be resolved in the dealership, using the dealership's facilities, equipment and personnel. That is why we suggest you follow Step One first if you have a concern.

Customer Assistance For the Hearing or Speech Impaired (TDD)

To assist owners who have hearing difficulties, Pontiac has installed special TDD (Telecommunication Devices for the Deaf) equipment at its Customer Assistance Center. Any hearing or speech impaired customer who has access to a TDD or a conventional teletypewriter (TTY) can communicate with Pontiac by dialing: 1-800-TDD-PONT. (TDD users in Canada can dial 1-800-263-3830.)

Customer Assistance Information

GM Participation In Better Business Bureau Mediation/Arbitration Program*

Our experience has shown that the Customer Satisfaction Procedure described earlier in this part has been very successful in achieving customer satisfaction. However, if you have not been substantially satisfied, Pontiac wants you to be aware of GM's voluntary participation in a no-charge mediation/arbitration program called BBB AUTO LINE. This program is administered by the Council of Better Business Bureaus through local Better Business Bureaus. It can resolve individual disputes involving vehicle repairs and the interpretation of your New Vehicle Limited Warranty.

We prefer that you not resort to BBB AUTO LINE until after a final decision is made under the Customer Satisfaction Procedure. However, you may file a claim at any time by contacting your local Better Business Bureau (BBB) at the following toll-free number: 1-800-955-5100. For further information about filing a claim, you may also write to:

BBB AUTO LINE
Council of Better Business Bureaus
4200 Wilson Boulevard
Suite 800
Arlington, VA 22203

In order to file a claim, you will have to provide your name and address, the vehicle identification number (VIN) of your vehicle, and a statement of the nature of your complaint. BBB staff may try to help resolve your dispute through mediation. If mediation is not successful, or if you do not wish to participate in mediation, eligible customers may present their case to an impartial third-party arbitrator at an informal hearing. The arbitrator will render a decision in your case, which you may accept or reject. If you accept a valid arbitrator decision, GM will be bound by that decision. The entire dispute settlement process should ordinarily take about 40 days from the

time you file your complaint to the time a decision is rendered (or 47 days if you did not first contact your dealer or Pontiac).

We encourage you to use this program before or instead of resorting to the courts. We believe it offers advantages over courts in most jurisdictions because it is fast, free of charge, and informal (lawyers are not usually present, although you may retain one at your expense if you choose). Arbitrators make decisions based on the principles of fairness and equity, and are not required to duplicate the functions of courts by strictly applying state or federal law. If you wish to go to court, however, we do not require that you first file a claim with BBB AUTO LINE** unless state law provides otherwise.

Whatever your preference may be, remember that if you are unhappy with the results of BBB AUTO LINE, you can still go to court because an arbitrator's decision is binding on GM but not on you, unless you accept it.

Eligibility is limited by vehicle age/mileage and other factors. For further information concerning the program, call the BBB at 1-800-955-5100. You may also call the Pontiac Customer Assistance Center.

** This program may not be available in all states, depending on state law. Canadian owners refer to your warranty booklet. General Motors reserves the right to change eligibility limitations and/or to discontinue its participation in this program.*

*** Some states may require that you file a claim with BBB AUTO LINE before resorting to state-operated procedures (including court).*

Customer Assistance Information

Reporting Safety Defects to the United States Government

If you believe that your vehicle has a defect which could cause a crash or could cause injury or death, you should immediately inform the National Highway Traffic Safety Administration (NHTSA), in addition to notifying General Motors.

If NHTSA receives similar complaints, it may open an investigation, and if it finds that a safety defect exists in a group of vehicles, it may order a recall and remedy campaign. However, NHTSA cannot become involved in individual problems between you, your dealer, or General Motors.

To contact NHTSA, you may either call the Auto Safety Hotline toll-free at 1-800-424-9393 (or 366-0123 in the Washington, D.C. area) or write to:

NHTSA
U.S. Department of Transportation
Washington, D.C. 20590

You can also obtain other information about motor vehicle safety from the Hotline.

Reporting Safety Defects to the Canadian Government

If you live in Canada, and you believe that your vehicle has a safety defect, you should immediately notify Transport Canada, in addition to notifying General Motors of Canada Limited. You may write to:

Transport Canada
Box 8880
Ottawa, Ontario K1G 3J2

Reporting Safety Defects to General Motors

In addition to notifying NHTSA (or Transport Canada) in a situation like this, we certainly hope you'll notify us. Please call us at **1-800-PM-CARES**, or write:

Pontiac Division
Customer Assistance Center
One Pontiac Plaza
Pontiac, MI 48340

In Canada, please call us at 1-800-263-3777 (English) or 1-800-263-7854 (French). Or, write:

General Motors of Canada Limited
Customer Assistance Centre
1908 Colonel Sam Drive
Oshawa, Ontario L1H 8P7



■ **Pontiac Roadside Assistance Program**

Security While You Travel

1-800-ROADSIDE 1-800-762-3743

As the proud owner of a new Pontiac vehicle, you are automatically enrolled in the Pontiac Roadside Assistance Program.* This value-added service is intended to provide you with peace of mind as you drive in the city or travel the open road.

Pontiac's Roadside Assistance toll-free number is staffed by a team of technically trained advisors, who are available 24 hours a day, 365 days a year.

We take anxiety out of uncertain situations by providing minor repair

information over the phone or making arrangements to tow your vehicle to the nearest Pontiac dealer.

We will provide the following services for 3 years/36,000 miles, at no expense to you:

- Vehicle out of fuel
- Keys locked in vehicle
- Tow to nearest dealer for warranty
- Change a flat tire
- Jump starts

We have quick, easy access to telephone numbers of the following services depending on your needs:

- Hotels
- Glass replacement
- Rental vehicles or taxis
- Police, fire department or hospitals

In many instances, mechanical failures are covered under Pontiac's comprehensive warranty. However, when other services are utilized, our advisors will explain any payment obligations you might incur.

Pontiac reserves the right to limit services or reimbursement to an owner or driver when in Pontiac's judgement the claims become obsessive in frequency or type of occurrence.

** In Canada, call 1-800-268-6800 for details on Roadside Assistance.*

Customer Assistance Information

■ *Pontiac Roadside Assistance Program (Cont.)*

For prompt and efficient assistance when calling, please provide the following information to the advisor:

- Location of vehicle
- Telephone number of your location
- Vehicle model, year and color
- Mileage of vehicle
- Vehicle identification number
- Vehicle license plate number

While we hope that you never have the occasion to use our service, it is added security while travelling for you and your family. Remember, we're only a phone call away. Pontiac Roadside Assistance—1-800-ROADSIDE or 1-800-762-3743.

■ *Service Publications*

Information on how to obtain Product Service Publications and Indexes as described below is applicable only in the fifty U.S. states (and the District of Columbia) and only for cars and light trucks with GVWR less than 10,000 pounds (4536 kg).

In Canada, information pertaining to Product Service Bulletins and Indexes can be obtained by writing to:

General Motors of Canada Limited
Service Publications Department
1908 Colonel Sam Drive
Oshawa, Ontario L1H 8P7

Pontiac regularly sends its dealers useful service bulletins about Pontiac products. Pontiac monitors product performance in the field. We then prepare bulletins for servicing our products better. Now, you can get these bulletins too.

Bulletins cover various subjects. Some pertain to the proper use and care of your vehicle. Some describe costly repairs. Others describe inexpensive repairs which, if done on time with the latest parts, may avoid future costly repairs. Some bulletins tell a technician how to repair a new or unexpected condition. Others describe a quicker way to fix your vehicle. They can help a technician service your vehicle better.

Most bulletins apply to conditions affecting a small number of cars or trucks. Your Pontiac dealer or a qualified technician may have to determine if a specific bulletin applies to your vehicle.

Individual PSP's

If you don't want to buy all the PSP's issued by Pontiac for all models in the model year, you can buy individual PSP's, such as those which may pertain to a particular model. To do this, you will first need to see our index of PSP's. It provides a variety of information. Here's what you'll find in the index and how you can get one:

What You'll Find in the Index

- A list of all PSP's published by Pontiac in a model year (1990 or later). PSP's covering all models of Pontiac vehicles are listed in the same index.
- Ordering information so you can buy the specific PSP's you may want.
- Price information for the PSP's you may want to buy.

Customer Assistance Information

How You Can Get an Index

Indexes are published periodically. Most of the PSP's which could potentially apply to the most recent Pontiac models will be listed in the most recent publication for that model year. This means you may want to wait until the end of the model year before ordering an index, if you are interested in buying PSP's pertaining to a current model year car or truck.

Some PSP's pertaining to a particular model year vehicle may be published in later years, and these would be listed in the later year's index. When you order an index for a model year that is not over yet, we'll send you the most recently published issue. Check the order form for indexes for earlier model years.

Cut out the order form, fill it out, and mail it in. We will then see to it that an index is mailed to you. There is no charge for indexes for the 1990-1993 model years.

Toll-Free Telephone Number

If you want an additional order form for an index, just call toll-free and we'll be happy to send you one. Automated recording equipment will take your name and mailing address. The number to call is 1-800-551-4123.

A Very Important Reminder

These PSP's are meant for technicians. They are not meant for the "do-it-yourselfer." Technicians have the equipment, tools, safety instructions, and know-how to do a job quickly and safely.

Pontiac Service Publications

You can get these by using the following order form.

Pontiac Division service manuals are intended for use by professional, qualified technicians. Attempting repairs or service without the appropriate training, tools, and equipment could cause injury to you or others and damage to your vehicle that may cause it not to operate properly.

1993 PONTIAC SERVICE PUBLICATIONS ORDERING INFORMATION

The following publications covering the operation and servicing of your vehicle can be purchased by filling out the Service Publications Order Form in this book and mailing it with your check, money order or credit card information to Helm, Incorporated (address listed below).

CURRENT PUBLICATIONS FOR 1993 PONTIAC BONNEVILLE

PRODUCT SERVICE PUBLICATIONS

Product Service Publications (PSP's), are bulletins, letters and articles published for trained dealer service personnel. See Service Publications listed previously in this section.

A cumulative index is published quarterly during the current model year. The indexes list all PSP's published by Pontiac in the model year.

PSP Index

Year	Form Number	Price
1993	PSP1-93-P	Free
1992	PSP1-92-P	Free
1991	PSP1-91-P	Free
1990	PSP1-90-P	Free

NOTE: Form Numbers for individual Product Service Publications may be found in the PSP Index. Prices are \$4.00 for the first PSP and \$2.00 for each additional PSP on the same order.

PSP Bound Bulletin Book (Complete Year Bulletins)

Year	Description	Form Number	Price
1991	All PSP's	S-91-PSP-4	15.00
1990	All PSP's	S-90-PSP-4	15.00

For subscription information call Helm, Incorporated.

CURRENT & PAST MODEL ORDER FORMS

Service Publications are available for current and past model Pontiac vehicles. To request an order form, please specify year and model name of vehicle.

SERVICE MANUALS

Service Manuals have the diagnosis, repair and overhaul information on engines, transmission, axle, suspension, brakes, electrical, steering, body, etc.

Model	Form Number	Price
1993 Pontiac Bonneville	S-9310-H	\$43.00

*Please specify special body or engine types on order form. Write information in the Form Number column. For example: Turbo, Convertible.

OWNER'S INFORMATION

Owner publications are written directly for owners and intended to provide basic operational information about the vehicle. The Owner's Manual includes the Maintenance Schedule for all models.

1993 Pontiac Bonneville Owner's Manual

In Portfolio: Includes Portfolio, Owner's Manual and Warranty Booklet.

1993	Pontiac Bonneville SE In-Portfolio . . .	10202134	\$15.00
1993	Pontiac Bonneville SSEI In-Portfolio . . .	10215984	\$15.00

Without Portfolio: Includes Owner's Manual.

1993	Pontiac Bonneville Without Portfolio . . .	10202135	\$11.00
------	--	----------	---------

Address all inquiries to: HELM, INCORPORATED
P.O. Box 07130
Detroit, MI 48207

Credit Card Orders ONLY: 1-800-782-4356

For information and inquiries call: (313) 883-1430

Notes

PONTIAC SERVICE PUBLICATIONS ORDER FORM

NOTE: Please complete form below (Print or Type) and MAIL TO:

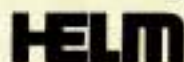

Post Office Box 07130, Detroit, Michigan 48207

<p style="text-align: center;">ORDER TOLL FREE (NOTE: For Credit Card Holder Orders Only) 1-800-782-4356 (Monday-Friday 8:30 A.M.-6:00 P.M. EST)</p>	<p>•Minimum Credit Card Order \$10.00</p> <p>If further information is needed, write Helm or call (313) 883-1430.</p> <p>ORDER INFORMATION NOT AVAILABLE THROUGH THE TOLL FREE NUMBER.</p>
---	---

PUBLICATION FORM NUMBER**	ITEM DESCRIPTION	VEHICLE MODEL		QTY.	PRICE EACH*	TOTAL PRICE
		NAME	YEAR			
S-9310-H	Service Manual	Pontiac Bonneville	1993		\$43.00	
10202134	Owner's Manual In-Portfolio	Pontiac Bonneville SE	1993		\$15.00	
10215984	Owner's Manual In-Portfolio	Pontiac Bonneville SSEI	1993		\$15.00	
10202135	Owner's Manual Without-Portfolio	Pontiac Bonneville	1993		\$11.00	

SHIP TO

NOTE: Dealers and Companies please provide dealer or company name, and also the name of the person to whose attention the shipment should be sent. For purchases outside U.S.A. please write to the above address for quotation.

(CUSTOMER NAME) (ATTENTION)

(STREET ADDRESS—NO P.O. BOX NUMBERS) (APT. NO.)

(CITY) (STATE) (ZIP CODE)

DAYTIME TELEPHONE NO. AREA CODE () _____

PAYMENT

Check or Money
Order payable to Helm, Inc. (USA funds only — do not send cash.)

MasterCard

VISA

Account Number:

Expiration Date mo/yr:

Check here if your billing address is different from your shipping address shown.

(CUSTOMER SIGNATURE)

TOTAL MATERIAL	
Michigan Purchasers add 4% sales tax	
Handling Charge	\$3.50
Canadian Postage/Handling (U.S. Funds)	\$6.50
GRAND TOTAL	

* Prices are subject to change without notice and without incurring obligation.
 ** Orders for Individual Product Service Publications cannot be filled without the appropriate bulletin numbers. These numbers may be found in the PSP Index. Your first Product Service Publication costs \$4.00; each additional PSP costs \$2.00.

NOTE: All listed prices are quoted in U.S. funds. Canadian residents are to make checks payable in U.S. funds and are to include \$6.50 for additional postage and handling. Requests for manuals printed in French should be directed to Canadian General Motors dealerships.
Please allow adequate time for postal service.

- A**BS Warning Light 106
Accessory Outlet 93
Adding
 Brake Fluid 243
 Electrical Equipment . . . 93, 126, 265
 Engine Coolant 238
 Engine Oil 231
 Power Steering Fluid 242
 Sound Equipment 126
 Transaxle Fluid 238
 Windshield Washer Fluid 243
Adjustable Support Seat 11
Air Bag 22
Air Cleaner Filter 233, 271
Air Conditioner 120, 123
Air Conditioner Refrigerant 270
Air Inflator System 209
Alcohol, Driving Under the Influence
 of 151
Alcohol in Gasoline 223
Aluminum Wheels
 Cleaning 262
 Removing 212
Antenna
 Fixed 142
 Power 142
Antifreeze . . . 205, 206, 239, 240, 270, 272
Anti-Lock Brake System (ABS) 155
 Warning Light 106
Appearance Care 257
Armrest, Storage 90
Ashtrays & Lighter 91, 92
Audio Systems 126
 AM/FM Stereo Radio 128
 AM/FM Stereo Radio with
 Cassette Player 129
 AM/FM Stereo with Cassette
 Player and Graphic Equalizer . . . 131
 AM/FM Stereo with Compact
 Disc Player 134
 Care of Audio Systems 141
 CD Player Anti-Theft Feature 137
 Gain Control 140
 Hearing Damage Warning 126
 Radio Reception,
 For the Best 140
 Setting the Clock 127
 Steering Wheel Controls 139
Automatic Transaxle
 Adding Fluid 238
 Checking Fluid 236
 Shifting 61
Battery 245
 Jump Starting 193
Battery Warning Light 104
Blizzard 181
Block Heater, Engine 60
"Blowout," Tire 208
Boost Gage 111
Brakes
 Adjustment 159
 Anti-Lock 155
 Drums 159
 Fluid 243, 272
 Master Cylinder 243
 Parking 67
 Pedal Travel 159
 Replacement 245
 Warning Light 105
 Wear Indicators—Front Brakes . . . 158
Brake System Warning Light
 Standard Brakes 105
 Anti-Lock Brake System 106
Braking 154
Braking in Emergencies 159
Braking Technique 154
"Break-In," New Vehicle 57
Buckling Up (see *Safety Belts*)

Index

- Bulb Replacement
 - Headlight 246, 273
 - Taillight 247, 273
- Bulbs, Replacement 273

Capacities & Specifications 270

- Carbon Monoxide
 - in Exhaust 71, 72, 181
- Cassette Tape Player
 - (see *Audio Systems*)
- Center Front Lap Belt
 - (see *Safety Belts*)
- Center Passenger Position 30
- Chains, Tire 218, 256
- Changing a Flat Tire 210
- Check Gages Warning Light 108
- Checking
 - Brake Fluid 243
 - Engine Coolant 205, 239
 - Engine Oil Level 231
 - Power Steering Fluid 242
 - Restraint Systems 44
 - Transaxle Fluid 236
- Checking Things Under the Hood . . . 227

- Check Oil Level Warning Light . . . 103
- Chemical Paint Spotting 264
- Child Restraints 34
- Children and Safety Belts 33, 42
- Cigarette Lighter 92
- Circuit Breakers & Fuses 266
- City Driving 171
- Cleaner, Air 233, 271
- Cleaning
 - Aluminum Wheels 262
 - Cassette Player 141
 - Fabric 258, 259
 - Finish Care 262
 - Glass 261
 - Head-Up Display 118
 - Inside of Your Pontiac 258
 - Outside of Your Pontiac 261
 - Power Antenna 142
 - Safety Belts 260
 - Special Problems 259
 - Underbody Maintenance 264
 - Vinyl or Leather 260
 - Warnings 257, 258, 260, 262
 - Weatherstrips 262
 - White Sidewall Tires 262
 - Windshield and Wiper Blades . . . 261

- Climate Control
 - Electronic 123
 - Standard 120
- Clock, Setting the 127
- Clusters, Instrument Panel 96
- Comfort Controls
 - Electronic Climate Control 123
 - Standard Climate Control 120
- Compact Spare Tire 217
- Compass 113
- Control of a Vehicle 153
- Convenience Net 56
- Convex Outside Mirror 87
- Coolant
 - Checking &
 - Adding 205, 206, 239, 240
 - Function Monitor 111
 - "Low" Warning Light 101
 - Proper Mixture to Use 239
 - Safety Warnings About . . . 202, 204, 205, 206, 228, 240, 241
 - Temperature Gage 109
 - Temperature Warning Light 101
- Cruise Control 77
- Curves, Driving on 160
- Customer Assistance Information . . 297

D aytime Running Lights	83
Dead Battery: What to Do	193
Defects, Safety (See <i>Safety Defects, Reporting</i>)	
Defensive Driving	150
Defogger, Rear Window	122, 124
Defogging Windows	121, 124
Defrosting	121, 124
Delco LOC II	137
Door Cup Holder	90
Door Locks	47
Downshifting	65, 176, 189
Driver Information Center	111
Driver Position	18
Driving	
At Night	165
City	171
Controlling a Skid	164
Defensively	150
Drunken	151
Freeway	172
Hill and Mountain	176
In a Foreign Country	225
In Fog, Mist and Haze	170
In the Rain	168
Long Distance	174
Loss of Control	164

On Curves	160
Passing	163
Through Deep Standing Water	60
Winter Driving	179
Drunken Driving	151

Electrical Equipment,

Adding	93, 126, 265
Electronic Climate Control	123
Electronic Compass	113
Emergencies, Braking	159
Emergencies on the Road	191
Emergencies, Steering in	161
Emergency Starting	193
Emergency Towing	197
Engine Block Heater	60, 233
Engine Coolant	238
Engine Coolant Temperature Gage	109
Engine Coolant Temperature Warning Light	101
Engine Exhaust	71, 181
Engine Identification	265
Engine Oil	231
Additives	232
Checking & Adding	231
Check Level Light	103

Disposing of Used Oil	233
Energy Conserving	232
Oil Warning Light	102
Pressure Gage	110
Warning, Used	233
When to Change	233
Engine Overheating	202
Engine Specifications	271
Engine, Starting Your	58
Ethanol in Gasoline	223
Exhaust	
Dangerous Gas in	71, 72, 181
Parking with the Engine Running	70, 72
Expectant Mothers, Use of Safety Belts	29
Express Open Sunroof	89
Expressway Driving	172
Extender, Safety Belt	43
Exterior Appearance (see <i>Appearance Care</i>)	
F abric Cleaning (see <i>Appearance Care</i>)	
Fan Warnings	194, 195, 204
Filling Your Tank	226

Index

Filter
 Air Cleaner 233, 271
 Fuel 271
 Oil 233, 271
Finish Damage 263
Flashers, Hazard Warning 192
Flat Tire 208
Flooded Engine 59
Flow-Through Ventilation 125
Fluid
 Brake 243, 272
 Capacities 270
 Power Steering 242, 270, 272
 Transaxle 238, 270, 272
 Windshield Washer . 76, 242, 272, 292
Fluids & Lubricants 272
Fog, Driving in 170
Fog Lights 85, 247
Foreign Material 263
Foreign Operation 225
Freeway Driving 172
French Language Manual 2
Fuel 222, 223
 Alcohol in Fuel 223
 Capacity 224
 Door Lock 225

 Door Release, Manual 227
 Door Release, Remote 225
 Exhaust Warnings 71, 72, 181
 Filling Your Tank 226
 Fuels with Alcohol 223
 Gage 109
 In Foreign Countries 225
 Low, Warning 109
 Requirements 222, 223
Function Monitor 111
Fuse Panel 267
Fuses & Circuit Breakers 266

Gages 108
 Fuel 109
 Coolant Temperature 109
 Oil Pressure 110
 Voltmeter 110
Gasoline 222
Gasoline Tank, Filling Your 226
Gas Station Information 320
Gear Positions
 (see *Shifting the Transaxle*)
Gearshift Lever
 (see *Shifting the Transaxle*)

Glove Box 56
Graphic Equalizer (see *Audio Systems*)

Halogen Bulb Replacement . . . 246, 273
Hazard Warning Flashers 192
Headlight & Taillight, Removing
 and Replacing 246, 247
Headlight Washers 77
Head-Up Display 116
Headlights 81
 High-Low Beam Changer 83
 Instrument Panel Intensity
 Control 84
 Lamp Monitor 112
 "On" Reminder 82
 Replacement Bulb 273
 Washers 77
 Wiring 269
Head Restraints 13
Heater (see *Comfort Controls*)
Heater, Engine Block 60
High Beams 83, 167
"Highway Hypnosis" 175
Hill and Mountain Roads 176
Hills, Parking on 177, 189

Hood Release	227
Safety Warning	194, 195, 204, 228
Warning, Overheated Engine	196, 204, 205, 206, 228, 240, 241
Horn	72
Hot Engine, Safety Warnings	196, 204, 205, 206, 228, 240, 241
How the Anti-Lock Brake System Works	156
Hydroplaning	169
I dentification Number, Vehicle	264
Idling Your Engine	70, 72
If You're Stuck in Sand, Mud, Ice, or Snow	218
Ignition Key	46
Positions	57
Illuminated Entry	55
Indicator Lights (see <i>Warning Lights</i>)	
Infant Restraint (see <i>Child Restraints</i>)	
Inflation, Tires	250
Inside Rearview Mirror	86
Instrument Panel	94
Instrument Panel Clusters	96

Instrument Panel Warning Lights	99
Intensity Control	84
J ack, Tire	211
Jump Starting	193
K eyless Entry, Remote	49
Keys	46
L amp Monitor	112
Lane Change Indicator	72
Lap-Shoulder Safety Belt	19
Front	30
Rear	31
Use by Children	33
Light Controls	81
Lighters	92
Lights	
Air Bag System	24
Daytime Running Lights	83
Fog Lights	85
Headlights	81, 83, 246
"On" Reminder	82

Parking	81
Reading	85
Removing & Replacing	
Bulbs	246, 247, 273
Replacement Bulbs	273
Taillights	247, 273
Turn Signal	74
Underhood	228
Warning Lights	100
Loading Your Vehicle	248
Locks	47
Locks, Rear Door Security	50
Locks, Remote Control	48
Long Distance Driving	174
Low Battery	193
Low Fuel Warning	109
Low Oil Pressure Warning	102
Low Washer Fluid Warning Light	105
Lubricants & Fluids	272
M aintenance Record	294
Maintenance Schedule	275
Maintenance Services, Scheduled	278
Malfunction Indicator Lamp	104

Index

Manual Front Seat	10
Manual Reclining Seatback	12
Manual Remote Control Mirror	87
Maxifuse/Relay Center	268
Methanol in Gasoline	223
Mileage Indicator (see <i>Odometer & Speedometer</i>)	
Mirrors	
Convex Outside	87
Electrochromic Day/Night	86
Inside Manual Day/Night	86
Manual Remote Control	87
Power Remote Control	88
Visor Vanity	88
Mountain Driving	176

N ew Vehicle "Break-In" Requirements	57, 184
Night Driving	165

O ctane Requirements (see <i>Fuel Requirements</i>)	
Odometer and Speedometer	98

Oil, Engine	231
Capacity	270
Pressure Gage	110
Quality	232
Thickness	232
Used Oil	233
Warning Lights	102, 103
When to Change	233
Oil Level Warning	103
Operation of Lights	82
Outside Rearview Mirrors	87
Overdrive, Automatic	64
Overheated Engine Warnings	202, 204, 205, 206, 228, 240, 241
Overheated Engine Coolant Warning	202, 204, 205, 206, 228, 240, 241
Owner Checks & Services	287

P ark	62
Park, Shifting Into	68, 69
Park, Shifting Out of	70
Parking On Hills	177, 189

Over Things That Burn	71
With the Engine Running	70, 72
Parking Brake	67
PASS-Key II™	52
Passenger Belts (see <i>Safety Belts</i>)	
Passing	163
Performance Shifting	66
Polishing and Waxing (see <i>Appearance Care</i>)	
Power Antenna	142
Power Door Locks	48
Power Mirrors	88
Power Seat	11
Power Steering	160
Power Steering Fluid	242, 270, 272
Power Windows	73, 269
Pregnancy, Use of Safety Belts During	29
Publications (see <i>Service Publications</i>)	

R adiator Overheating (see <i>Overheated Engine</i>)	
Radiator Pressure Cap	206, 241
Radio (see <i>Audio Systems</i>)	

Reading Lights	85	Rocking Your Vehicle	182, 219	Smaller Children and Babies	33
Rearview Mirror	86	Rotation, Tire	251	Top Strap	36
Rear Window Defogger	121, 124	S afety Belts	13	Torn	44
Reclining Seatbacks	12	Adults	18	Twisted	22
Remote Keyless Entry	49	Center Passenger Position	30	Why Your Should Wear	
Remote Fuel Door Lock	225	Checking	44	Safety Belts	15
Remote Trunk Release	56	Children	33, 42	Safety Defects, Reporting	302
Replacement Bulbs	273	Child Restraints	34	Scheduled Maintenance Services	278
Replacement Parts	271	Child Restraints—How to		Seat Belts (see <i>Safety Belts</i>)	
Replacement, Windshield Wiper	248	Install Them	36	Seat Controls	10
Replacing Brake System Parts	245	Child Restraints, Where to Put	34	Adjustment	10
Replacing Safety Belts	44	Cleaning	260	Adjustable Support Seat	11
Replacing Tires	252	Driver Position	18	Head Restraints	13
Replacing Wheels	255	Extender	43	Manual Front Seat	10
Reporting Safety Defects	302	Lap-Shoulder Belt	19	Manual Reclining Seatback	12
Restraints, Child	34	How to Wear	18	Power Seat	11
Restraints, Head	13	Passenger Belts	29	Reclining Seatback	12
Retained Accessory Power	58	Pregnancy, Use During	29	Service Engine Soon Light	
Roads, Hill and Mountain	176	Questions &		(Malfunction Indicator Lamp)	104
Road Signs	145	Answers	17, 21, 22, 43, 44	Service Information	222
Color	146	Rear Safety Belts	31	Service Parts Identification Label	265
Shape	147	Reminder Light	18	Service Publications	304
Symbols	148	Replacement	44	Service Publications Order Form	307
Traffic Lights	148	Right Front, Adult Passenger	29	Service Station Information	320
Your Own Signals	149			Setting the Clock	127
Roadside Assistance Program	303			Setting the Trip Odometer	98

Index

- Sheet Metal Damage263
Shifting Into P (Park)68, 69
Shifting Out of P (Park)70
Shifting the Transaxle61
Signaling Turns74, 149
Signs, Road146
SIR (Air Bag)22
Skidding164
Snowstorm, If You're Caught in a...181
Sound Equipment, Adding126
Sound Systems (see *Audio Systems*)
Spare Tire, Compact218
Specifications & Capacities271
Speed Control (see *Cruise Control*)
Speedometer and Odometer98
Stains, Removing259
Standard Climate Control120
Starting Your Engine58
Starting Your Vehicle if the Battery
is "Dead" (see *Jump Starting*)
Steering
 In Emergencies161
 Off-Road Recovery162
 Power160
 Tips160
 Variable Effort160
Steering Wheel Controls139
Steering Wheel, Tilt73
Stereo Sound Systems (see *Audio Systems*)
Storage
 Armrest90
 Convenience Net56
 Door Cup Holder90
 Glove Box56
 Rear Compartment91
 Sunglasses93
Storing Your Vehicle245
Stuck; If You Are218
Sunroof, Express Open89
Sun Visors88
Supplemental Inflatable Restraint
 System22
Tachometer99
Tape Player (see *Audio Systems*)
Technical Facts & Specifications
 Bulbs273
 Electrical Equipment,
 Add-On93, 126, 265
 Fluid Capacities & Types270, 272
 Fuses & Circuit Breakers266
 Service Parts Identification
 Label265
Vehicle Identification Number
 (VIN)264
Temperature Warning101, 109
Theft-Deterrent System51
 Security Light53
Thermostat241
Tilt Steering Wheel73
Time, Setting the127
Tires250
 Air Inflator System209
 Blowout208
 Buying New252
 Chains218, 256
 Flat, Changing210
 Inflation250
 Inspection & Rotation251
 Loading250
 Pressure218, 250
 Quality Grading253
 Spare, Compact218
 Wear Indicators253
Wheel Alignment &
 Tire Balance255
Wheel Replacement255
When to Replace Wheels255
Winter Driving179
Torque Lock179

Towing a Trailer	183
Towing Your Pontiac	197
Traction Control	157
Traction Control System	
Warning Light	107
Traffic Lights	148
Trailer Towing	183
Transaxle, Automatic	
<i>(see Automatic Transaxle)</i>	
Transmission, Automatic	
<i>(see Automatic Transaxle)</i>	
Trip Odometer	98
Trunk	
Lock	55
Release, Remote Power	56
Turn Signal Indicator	74
Turn Signal/Headlight Beam	
Lever	73
Cruise Control	77
Headlight High-Low	
Beam Changer	83
Lane Change Signals	74
Turn Signal Indicator	74
Windshield Washer	76
Windshield Wipers	75
Twilight Sentinel	84

U nderhood Light	228
Unleaded Gasoline	222
Upholstery Care	258
Urban Driving	171

V ariable Effort Steering	160
Vehicle Identification Number	
(VIN)	264
Vehicle Loading	248
Vehicle Storage	245
Ventilation	121, 125
VIN	264
Visor Vanity Mirrors	88
Voltmeter	110

W arning Flashers, Hazard	192
Warning Lights	100
Anti-Lock Brake System	106
Battery	104
Brake	105
Check Gages	108
Coolant Temperature	101
Low Washer Fluid	105
Malfunction Indicator Lamp	104

Oil	102, 103
Service Engine Soon	104
Traction Control System	107
Washer, Windshield	76
Weight	
Gross Axle Weight Rating	
(GAWR)	248
Gross Vehicle Weight Rating	
(GVWR)	248
Wheel Alignment & Tire Balance	255
Wheel Covers,	
How to Remove	212
Wheel Nut Torque	216, 270
Wheel Replacement	255
Windows, Power	73
Windshield Washer	76
Fluid	76, 242
Low Fluid Warning Light	105
Windshield Wiper Replacement	248
Windshield Wipers	75, 261, 269
Winter Driving	179
If Your Vehicle is Stuck in	
Deep Snow	182
If You're Caught in a Blizzard	181
Wrecker Towing	197

Service Station Information

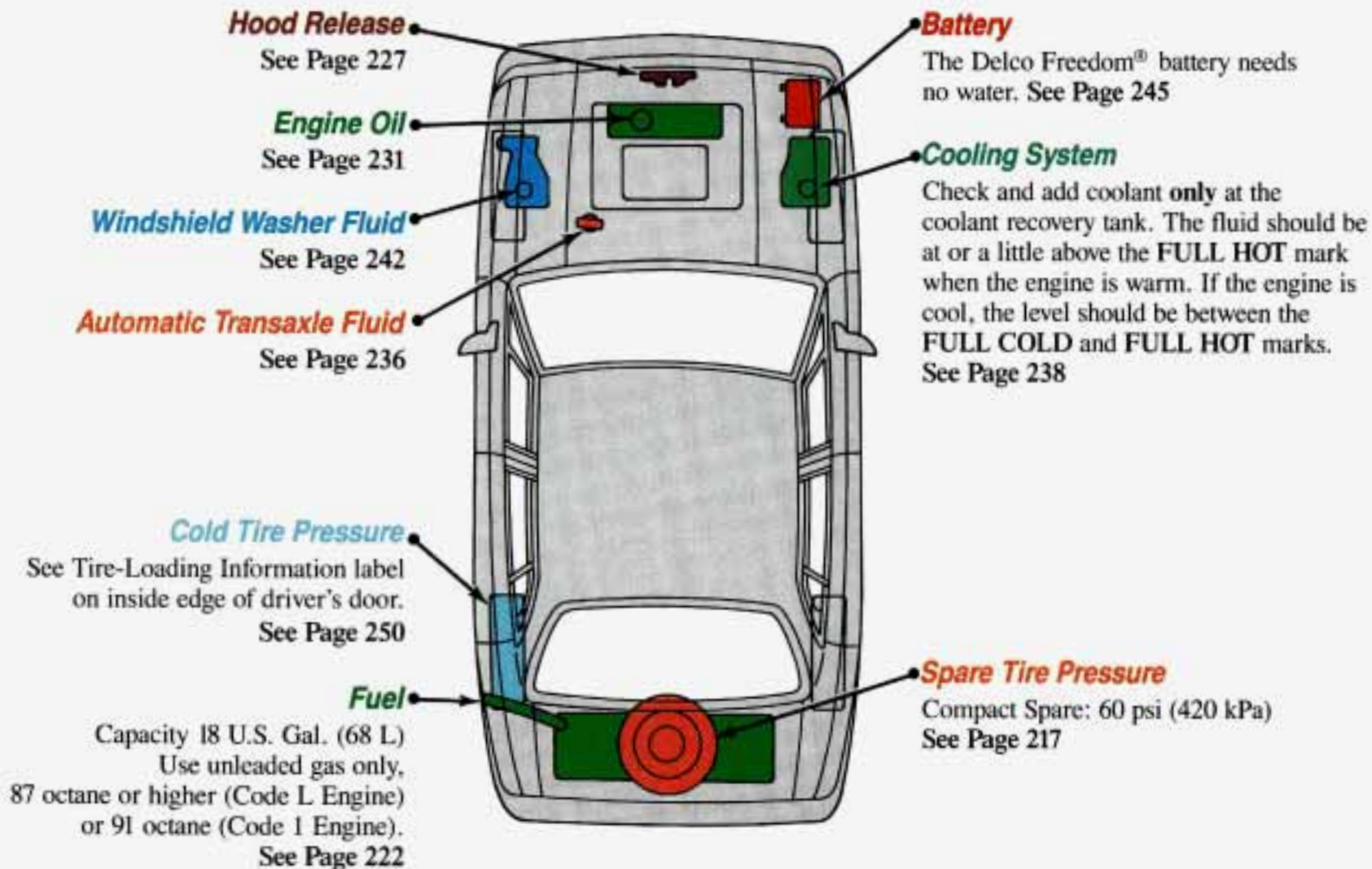



WE SUPPORT
VOLUNTARY TECHNICIAN
CERTIFICATION THROUGH

National Institute for
**AUTOMOTIVE
SERVICE
EXCELLENCE**



PONTIAC

