



# GREAT SCOT!

FRANCHITTI BREAKS HIS AMERICAN DUCK

www.autosportmag.com

20 AUGUST 1998 EVERY WEEK £2.40



# AUTOSPORT

**F1 TITLE THRILLER**

# HOW DID SCHUEY DO THAT?



**We explain Ferrari's sensational Hungary win**

- Schumacher's best-ever drive
- Where McLaren went wrong
- Championship race blown wide open



US \$4.95, DM 12.00, CS 6.95, 31 FF, 170 LF, 180 BF, 69.00 Asch, 9.000 IL



9 770269 946128



**BTCC**

## WARWICK HITS TOP FORM — AND HIS TEAM MATE!







**NEWS AND COMMENT**

- Schumacher's Hungarian miracle** ..... 4  
The full story behind the Ferrari driver's incredible win
- Pit & Paddock** ..... 6  
Ferrari blasts cheat allegations; Ralf set to quit Jordan; Grand Prix at Indianapolis on the cards
- Special Stage** ..... 22  
Makinen lines up a historic fifth win at home
- Fifth Column** ..... 27  
F1 on autopilot, by Nigel Roebuck
- Inside Line** ..... 28  
Jaimes Baker looks at the lack of British stars in F3000
- Dario Franchitti's driver column** ..... 63  
It's great to get that first win, says AUTOSPORT-backed CART ace
- Last Lap** ..... 118  
Adam Faith in praise of his mate Bernie Ecclestone

**FEATURES AND REPORTS**

- Hungarian Grand Prix** ..... 30  
Full report from the Hungaroring **Plus** complete qualifying rundown, lap-by-lap record, technical focus, Martin Brundle's view, team guide and postcard
- Fantasy GP** ..... 46  
Did scintillating Schuey give you a superb score?
- Crash helps Warwick to Knockhill win** ..... 48  
Former F1 star wins BTCC race after shunting team mate
- Heidfeld takes charge in F3000** ..... 56  
McLaren protege scores third win in Hungary to lead title race
- Can Subaru bounce back?** ..... 64  
Colin McRae is off to Ford for '99 but the team is still confident
- Franchitti realises American dream** ..... 66  
Scot plays it cool for CART glory at Road America
- Welsh win puts Haberfeld top of F3** ..... 70  
Brazilian hits title lead with one-two at Pembrey
- Luck changes for Patrick Simon** ..... 74  
German takes Hungaroring Porsche Supercup victory
- Letters 24, Jim Bamber cartoon 25**
- TV listings 28, Armchair Enthusiast 29**

**30 Simply brilliant Schuey** Ferrari ace ignites championship in Hungary



**64 Subaru stays positive for '99**



Burns to spearhead new attack

**66 Dario's first at last**



Franchitti wins at Road America

**EXCLUSIVE 116 Palmer Audi**



We get first test in one-make chassis

**48 Warwick scot on** Derek breaks his touring car duck at Knockhill

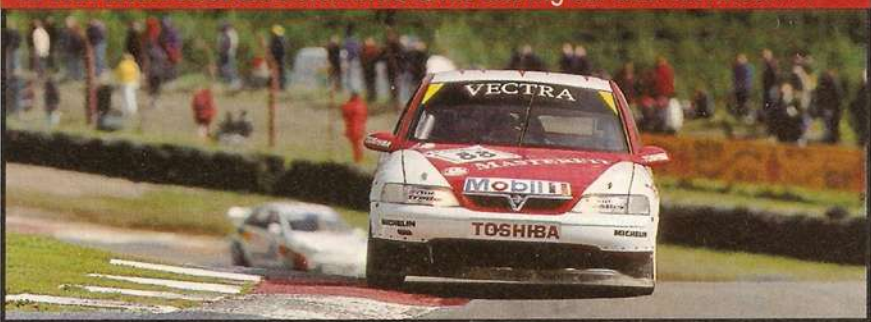

**CLUB AUTOSPORT**

- Damon to join Goodwood stars** ..... 97  
Hill to race his farther's Ferrari at Revival meeting
- Pizzonia heads for FRS with Manor** ..... 98  
Brazilian FVauxhall Junior star set to join crack Renault outfit
- Hill tops 180mph at Snetterton** ..... 101  
Supersprinter Chris Hill hits the heights at Norfolk track
- All the National racing reports** ..... 104  
Full coverage of a bumper weekend of motorsport
- EXCLUSIVE First Palmer Audi test** ..... 116  
What's the stunning one-make racer like to drive – we find out

**HOW TO CONTACT US** Editorial 0181-943 5998 (fax: 943 5922; telex: 895 2440) Advertising 0181-943 5858 Ads production 0181-943 5909 (fax: 5850)  
**Editorial, advertising and circulation:** 38-42 Hampton Road, Teddington, Middlesex TW11 0JE  
**Customer Services:** 01795 414817; **Back numbers:** 01235 534323; Publishing, trade and further subscription details on page 118  
 AUTOSPORT is published by Haymarket Specialist Motoring Ltd, a subsidiary of Haymarket Magazines Ltd, 38-42 Hampton Road, Teddington, Middx

**Online:** www.autosportmag.com or for AOL: keyword autosport  
 Printed by St Ives (Peterborough) plc & BR Hubbard Printers Ltd, Sheffield  
**COPYRIGHT:** Reproduction in whole or part of any text, photograph or illustration without the written permission of the publisher is strictly prohibited  
**ISSN 0269-946X**  
**Main cover photo:** Sutton Images **Other cover photos:** Ralph Hardwick; Gavin Lawrence/LAT  
**Contents photos:** Sutton, Ralph Hardwick, Mick Walker, Gavin Lawrence/LAT  
 Printed in England **MEMBER OF THE ADVERTISING REGULATION AUTHORITY** **ABC**



# Schumacher's greatest race?

Hungary looked like being the usual McLaren success story, then the German intervened. By Andrew Benson

**M**ichael Schumacher produced one of his greatest drives in last weekend's Hungarian Grand Prix, and has blown this year's World Championship wide open.

The 29-year-old German was helped on his way to the 32nd victory of his career by brilliant tactics from his Ferrari team and errors made by McLaren.

Ferrari technical director Ross Brawn, who has worked with Schumacher for all but three of his Grand Prix wins, said the drive ranked among the most spectacular of the German's career. 'It's certainly at the top,' he said.

The victory moves Schumacher ahead of Nigel Mansell in the Formula 1 all-time winners' list. Only Alain Prost, with 51, and Ayrton Senna, on 41, are ahead.

The win, and the fact that McLaren title rival Mika Hakkinen only scored a single point, means the gap

between the two is just seven points, with four races to go. Hakkinen suffered handling problems caused by a breakage in his car's suspension.

'What happened is obviously ideal for my championship hopes,' Schumacher said. 'You dream about the ideal result and that was one of the dreams I had. Before the race, I thought it would have to stay a dream because the best I could hope to achieve was for Mika to be first and me to be second. Some of the circuits coming up will be good for us, some not so good. But I think we have a pretty good chance.'

Hakkinen's McLaren team mate, David Coulthard, finished second to Schumacher. He accepted that the team made errors. The Scot could have won, even with the speed difference between the Ferrari and McLaren, but for strategic decisions that turned out to be mistakes. McLaren was also hamstrung by its Bridgestone tyres, which were not a match for Ferrari's Goodyears. This

was exacerbated in Coulthard's last stint by a wrongly-pressured tyre.

The McLaren driver said: 'If we'd been a bit sharper, maybe it would have turned out slightly differently. We didn't expect Michael to do a three-stop. You have to say that for Michael to win on a three-stop, having been behind us most of the time is quite remarkable, so I'm still a little bit in shock as to how we lost our performance towards the end.'

Schumacher said he thought his team's three-stop strategy was a mistake when he got trapped behind Jacques Villeneuve's Williams after his first pit visit. However, Ferrari's clever strategy, plus an error by McLaren (see panel right), allowed



Tech boss Brawn masterminded strategy

**“ You dream about the ideal result, and that was one of the dreams I had ”**

MICHAEL SCHUMACHER



Schumacher soaks up the applause from the crowd after one of his best performances



The German put David Coulthard's McLaren under pressure in the early part of the race

him to get out ahead of Hakkinen and Coulthard after his second stop.

After that, he had to make up 25 seconds on the McLaren pair in 19 laps. He managed it, despite sliding off once at the last corner.

The German said: 'It was a waiting game until we could play our strategy. After my second stop, I had a clear run. Ross told me: "You have 19 laps to pick up 25 seconds, go ahead." I said: "Thank you, I will try my best." It was enough, so I'm pleased.'

Brawn said: 'When I told him what he had to do, I'm sure he took a deep breath. He just said "Okay", which is what he normally says.'

## The ups and downs of Hungary

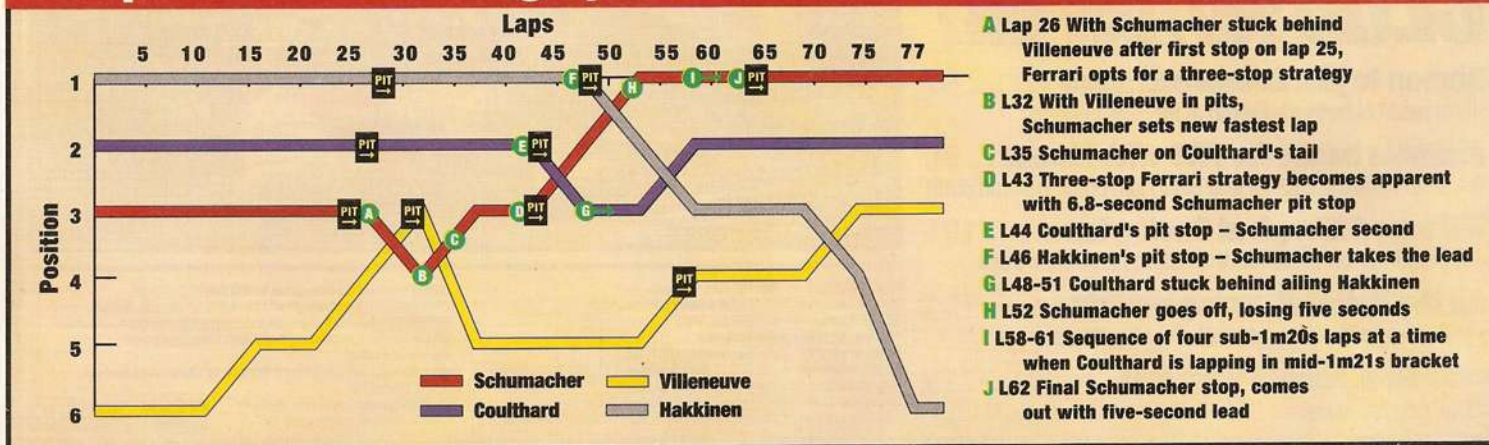



## How McLaren lost the race

**M**cLaren could have won the Hungarian Grand Prix with David Coulthard, even taking into account Michael Schumacher's ability to lap well over a second quicker. However, a series of errors, along with poor tyre performance, cost it the race.

- When Schumacher made his second pit stop, the team brought in Coulthard when it should have got Mika Hakkinen in. The Finn had a four-second lead over the Ferrari and was more likely to come out ahead. Coulthard was unlikely to beat Schumacher out because the Ferrari was quicker. Schumacher had proved this on his only lap not spent behind another car in the first half of the race. When Jacques Villeneuve pulled into the pits, Schumacher set a 1m19.952s on his next lap, the first time anyone had got below 1m20s. McLaren boss Ron Dennis said: 'You can look back and say we should have done this or that. But we thought we were doing the right thing or we wouldn't have done it.' Ferrari technical director Ross Brawn said: 'I'm sure they had their reasons. I don't understand what they were, I must admit.'
- Hakkinen encountered his handling problem immediately after his second pit stop on lap 46, two laps after Coulthard's stop and three after Schumacher's. Coulthard was stuck behind Hakkinen, who was between 1.5s and two seconds off the pace, for four laps. McLaren had a problem with its radio which meant Hakkinen could not tell the team of his problem as early as he might have. Dennis said: 'We didn't know



Bryn Williams

### Hakkinen was delayed by handling ills

why Mika was slowing. It was an extremely confusing situation.'

- Coulthard found that after his third stop he could not run at his previous pace. The rear tyre turned out to be incorrectly inflated. The Scot said: 'If I had been able to run at the same pace after my last stop as I did before, it would have been much closer, but in the end it was easy for Michael to tow out the 25 seconds he needed to come out in front of me (from his last stop). I'm surprised he was able to pull out enough. We hit a wall in performance and he was able to keep going more quickly.'

'We'll learn from this. The tyres were pretty badly worn at the end of the race. It was the softer of the two tyres. If we'd used the harder one, I don't think we would have been on pole. He would have been in front of us, so you have to say we have a bit of work to do on the tyre front.'



Aisling

### The Prancing Horse's masterplan swings into action as Schuey beats DC out of the pits



McLaren tried to frustrate Ferrari's tactic by bringing Coulthard in immediately after Schumacher. It didn't work. The Scot came out behind him and also lost vital time behind the struggling Hakkinen which could have let him get ahead of Schumacher when he pitted for the final time (see above right).

Coulthard said: 'Mika had a problem. We waited too long when Michael came out in front. I lost too much time behind Mika, and by the time we got our arse in gear it was six or seven seconds. The damage was done. We got well beaten.'

McLaren boss Ron Dennis said that tyres were to blame for his team losing the race. 'We were struggling with tyre performance a lot and our pace wasn't as we predicted. That

## Schuey's class

- European GP '95: in a wet-dry race, Schumacher makes three pit stops to the one of Jean Alesi's Ferrari. Makes up 24 seconds on Alesi in 13 laps and passes him with three laps to go.
- Spain '96: German annihilates the field in soaking wet conditions.
- Belgium '96: Schumacher wins with loose steering. Early safety car helps by closing gap between him and leader Jacques Villeneuve.
- Belgium '97: Ferrari star builds a lead of a minute in seven racing laps on a drying track, sometimes lapping over 10 seconds faster than anyone else.

cost us the race,' said Dennis. 'Any chance of winning was wiped out by not such a good tyre performance. There was no indication of that before the race.'

Dennis's assessment was borne out by the pace of Williams, which also uses Goodyear's rubber. Jacques Villeneuve and Heinz-Harald Frentzen set quicker laps than Hakkinen and Coulthard in the race.

Villeneuve said: 'Goodyear made the difference today for Michael, because the Bridgestones seemed to give up a lot. The McLaren is definitely a better car, but they couldn't seem to keep their tyres working and that helped every Goodyear runner.'

Hakkinen described his afternoon as 'bloody frustrating'. He said: 'It definitely made it more exciting. The



Sutton Images

### Ferrari enjoys a well-deserved celebration

idea was to come here and get the 10 points. Everything looked good, but just before my second stop I started getting some kind of problem. The car started to go really weird and I was not able to control it. Really unusual. I did my second stop and then everything turned into a nightmare. But I got the one point. It's not the best but it could be useful.' ■



# McLaren allegations 'bullshit', says Ferrari

Ferrari technical boss Ross Brawn has dismissed as 'bullshit' claims by McLaren that the team has revised its F300 following complaints from its rival.

McLaren boss Ron Dennis last week admitted that he had complained to Ferrari at the Austrian Grand Prix at the end of last month about an illegal pre-programmable braking system he believed the Italian team was using.

He said that the behaviour of the Ferrari since then suggests to him that the team has either 'optimised' the system or has 'changed' it.

Brawn said: 'It's just bullshit. You can't defend yourself against an accusation like that, so it's a very nasty, malicious thing to say. If someone says you have a fantastic system that no one can detect, how can you prove them wrong?'

Following Ferrari's poor performance in the German GP early this month, conspiracy theories suggested that the team was spooked by McLaren's actions and had turned its systems off. However, Brawn pointed out that Ferrari was competitive again with McLaren in Hungary last weekend.

'If we've turned the system off,

he said, 'where has the time come from now? Circumstances played into his hands. He had his whinge in Austria and then we had a problem in Germany.'

Dennis said that the Ferraris were locking up their loaded wheels under braking in Austria. Vehicle dynamics dictate that, normally, the unloaded, inside wheel would lock. He believed this betrayed that Ferrari was gathering data for the programming of an illegal intelligent brake-balance system.

He said: 'During the practice sessions of the Austrian GP, the wrong wheels were locking up (on the Ferrari) on the entrance to corners. It's not the unloaded wheel that's locking, it's the loaded one.'

'We believe or can now see that either there has been an optimisation, or something has changed. We now have every reason to believe that the system, if there is a system, is in accordance with the regulations. And to substantiate that view we have, over the past four weeks, asked many questions of the FIA (the

sport's governing body) and sought clarification.'

Dennis has told the FIA that he is also concerned that it is impossible to police traction control in F1. But he emphasised that he had not

discussed the system, which reduces wheelspin under acceleration, with Ferrari.

Brawn said: 'Nobody is applying any logic. At the French GP (in June), I heard one of McLaren's drivers say that at the second start it was just amazing, the Ferraris came past them as if they were standing still. Yet

at the first start, McLaren led us away from the line. So the logic of that is that we turned it off for the first start, and turned it on for the second. It's ludicrous.'

Brawn emphasised that Ferrari's car has been given a clean bill of health by the FIA. He said: 'We are one of the few teams that has our software scrutinised before we actually use it. So we are very sure, and the FIA is very sure, that our software is completely legal.'



Dennis: complaint

Fifth column  
Page 27

## Schuey refutes '94 cheating charge

Ferrari driver Michael Schumacher has denied that he cheated his way to the World Championship with Benetton in 1994.

The German's remarks came in the middle of the simmering controversy between Ferrari and McLaren on illegal driver-aid systems. The argument became public for the first time at the Hungarian Grand Prix last weekend (see above).

Benetton was cleared in 1994 of using an illegal traction control system on the B194, which beat Damon Hill's Williams to the title.

Schumacher said: 'I would never use an illegal system because there

are too many big players involved in Formula 1. I would not believe that there is an illegal strategy in any car.'

'I know in 1994 that we didn't have anything illegal, but there was so much talk about it that it became like the truth. I was really upset, after victories that we fought and worked for really hard.'

'You will always have engineers trying to get the best out of what you are legally allowed to do. You try to develop something that gives you a little support, and it may come out to something similar to traction control, but it is not traction control.'

## Williams engine switch denied

Suggestions that Williams could switch to Ford engines next year have been dismissed.

Rumours say Ford could supply customer engines to Williams in 1999 at the same time as smoothing the path to Williams of Stewart-Ford driver Rubens Barrichello. The Brazilian is trying to buy himself out of his contract to go to Williams. However, as AUTOSPORT closed for press, a source said that

there is 'no truth' in the claims.

Frank Williams said: 'We have a two-year contract with Mecachrome, and we stick by our contracts 99.9% of the time.'



Rubens: buy-out

Williams has a contract to use customer Renault engines next year, but it is unhappy about the involvement of former Benetton boss Flavio Briatore with the French company. Briatore is marketing the V10s, which are supplied by Mecachrome, but Williams refuses to deal with him.

Ford is unhappy about the performance of Stewart this season, and the idea of supplying customer engines to a top team could be attractive. Ford's European Motorsport boss, Martin Whitaker, refused to comment.

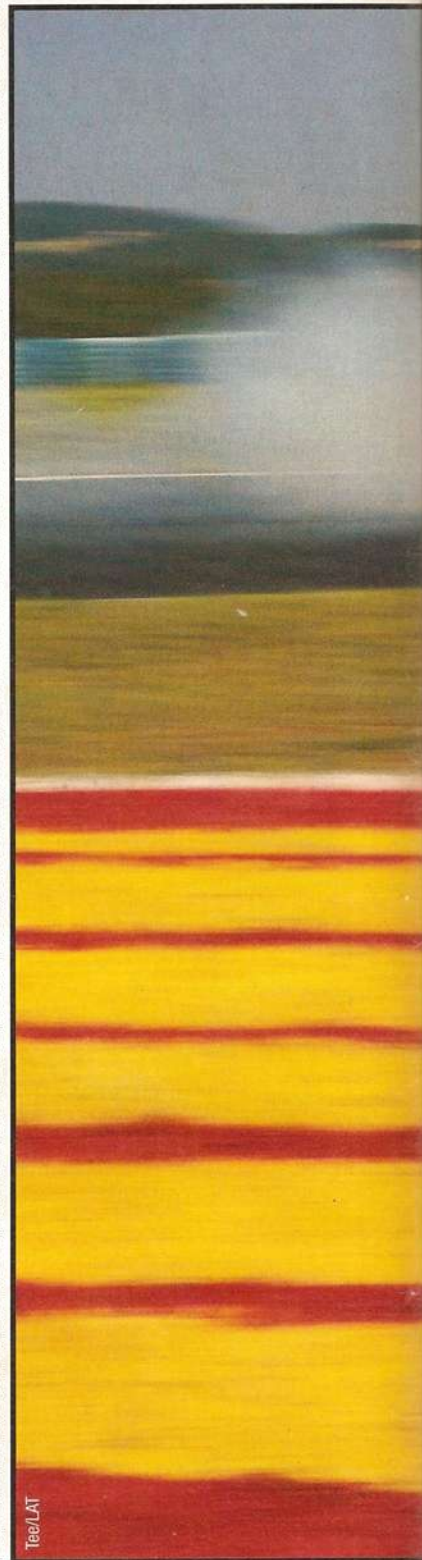

Teo/LAT

## Salo key to Arrows

Arrows driver Mika Salo has moved into the frame at British American Racing for next season.

The 31-year-old Finn has a contract with Arrows, but it is rumoured team boss Tom Walkinshaw is prepared to sell him to raise money for a Mecachrome engine. Salo has been mentioned in connection with Williams for the same reason.

Walkinshaw is said to have offered Salo to BAR boss Craig Pollock for a price. Rumours, however, suggest a swap deal has been proposed to Williams, with Salo joining it and Walkinshaw taking its Mecachrome V10s.



Sutton

Accused of cheating to win the 1994 Championship, Schumacher is in the headlines again





**In his two years in Formula 1, Ralf Schumacher has earned himself a reputation of being a fast but erratic driver. BAR has said it is not prepared to pay the salary he wants, but is Ralf's profile really Williams's style?**

## Schuey Jr eyes Williams drive for next year

Ralf Schumacher looks increasingly likely to quit Jordan to drive for Williams next season.

The 23-year-old is tipped for Williams even though he is also weighing up a drive with British American Racing and the chance to stay with Jordan. However, a Jordan insider said that the chances of him



**Schuey: quitting**

leaving the team are 'over 90%'.

Schumacher has had a chequered two years in Formula 1, gaining a reputation as a fast but erratic driver. That adds to confusion over why he would be

attractive to a top team like Williams.

Team boss Frank Williams is said to rate Schumacher highly, and with Williams starting testing of its BMW engines next year prior to racing them in 2000, signing a high-profile German could appeal.

BMW's motorsport director and former Grand Prix driver Gerhard Berger is said to have been pushing the younger Schumacher's case at Williams for several months.

A source said that the German is asking for more money than BAR is prepared to pay. Meanwhile, Jordan, which has to pay Damon Hill £5 million, cannot afford to pay him more than the £1.25 million he is reputed to earn this season.

Williams prefers to spend its money on its cars rather than drivers and may be reluctant to top Schumacher's 1998 earnings. However, it has several German sponsors that might be prepared to chip in.

Should Schumacher choose to drive for Williams, he would partner Champ Car star Alex Zanardi, who is considered almost certain to lead the team. He and Williams are understood to have agreed terms last month on a £5 million-per-year deal.

Hill is staying at Jordan, even though team boss Eddie Jordan is said to be trying to force him take a cut in salary.

## 99 power supply

Walkinshaw is said to want a better engine to reassure Pedro Diniz, who brings over £6 million in sponsorship to Arrows. The Brazilian is looking at BAR and has had contact with Jordan.

Williams, it is said, would then switch to the Hart engine Arrows is using this season, but boost it with input from BMW, which is developing a works engine for Williams to race in 2000.

Williams bosses Frank Williams and Patrick Head have poured cold water on the idea. They have ruled out bringing the BMW project forward, and insist the team will use Mecachrome engines.

## Herbert linked with Stewart

Briton Johnny Herbert is tipped to move to the Stewart team for 1999.

Sauber has offered Herbert a contract to stay with team mate Jean Alesi, but their relationship has deteriorated since the Frenchman joined this year.

Stewart is known to be interested in the 34-year-old, whose experience would be valuable as it struggles to make its mark in F1. Its works deal with Ford runs out at the end of 2000, and it needs to convince the US giant that its F1 future is in safe hands. Ford is said to be likely to strike a deal with Benetton for 2000.



**Herbert: valuable**

Stewart wants to hold on to Rubens Barrichello, who is trying to raise the funds to buy himself out of his contract and go to Williams.

Sauber is interested in Tyrrell's Toranosuke Takagi, who is expected to drive for Honda. Team boss Peter Sauber said the chances of test driver Jorg Muller are 'all-but zero'. He said: 'He is a good reserve driver. But it would make no sense to exchange him for Herbert.'

Heinz-Harald Frentzen said at the weekend that his talks with the Sauber team are now over.

## Drivers' parade

### McLAREN



• MIKA HAKKINEN • DAVID COULTHARD

### FERRARI



• MICHAEL SCHUMACHER • EDDIE IRVINE

### WILLIAMS



+ Alex Zanardi  
\* Ralf Schumacher, Rubens Barrichello, Juan Pablo Montoya, Mika Salo  
Heinz-Harald Frentzen

### BENETTON



• GIANCARLO FISICHELLA • ALEX WURZ

### JORDAN



• Damon Hill  
\* Ralf Schumacher, Pedro de la Rosa, Heinz-Harald Frentzen, Pedro Diniz

### BAR

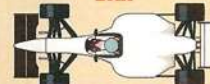

• JACQUES VILLENEUVE  
\* Ralf Schumacher, Mika Salo, Rubens Barrichello, Ricardo Zonta, Pedro Diniz, Heinz-Harald Frentzen, Jimmy Vasser, Pedro de la Rosa, Tom Kristensen

### SAUBER



• Jean Alesi  
\* Johnny Herbert, Toranosuke Takagi, Jorg Muller, Heinz-Harald Frentzen

### ARROWS



\* Mika Salo, Pedro Diniz, Pedro de la Rosa

### PROST



• Jarno Trulli • Olivier Panis

### STEWART



\* Rubens Barrichello, Johnny Herbert, Jos Verstappen, Juan Pablo Montoya, Pedro de la Rosa

### MINARDI



• Esteban Tuero  
\* Shinji Nakano, Oliver Martini

• Confirmed  
• Staying  
\* possible  
+ Almost certain





*Tested in almost every corner of the country.*

*Thruxton, Brands Hatch, Silverstone, Snetterton. They're just some of the places you'll  
the A303 in Dorset, or the A686 in Cumbria. No, our motorsport boys haven't decided to indulge in a*



*The Esses*



*Luffield Corner*

*Granted, it's a little less spartan under the skin; there's now air conditioning, sports seats, ABS, and a free option  
lowered suspension, 2.5 litre engine, and 16 inch alloys. A word of caution, though. Tempting though it may be to burn up*



find our Vectra SRi V6 24v powering through the bends. Oh, and the B3135 in Somerset,  
 spot of illegal road racing. It's just that we've launched a road-going version of the race-bred V6 Challenge car.

Hingston Down



Druids Bend



CD player. But outwardly, our V6 SRi has lost little in the way of muscularity, thanks to the stiffened,  
 the tarmac, race day antics are best left to the Vectra's more distinguished cousin.

THE VECTRA SRi FROM VAUXHALL   
 Feel the road.





News In Brief

FORMULA 1

**Peugeot has refused to** rule out quitting F1 before the end of its contract with the Prost team in 2000. Peugeot Sport boss Corrado Provera said: 'We will stay in F1 with Alain (Prost), provided the results are as good as we would like.' AUTOSPORT exclusively predicted last month that the company could quit Prost at the end of next year if its performance was not up to scratch. Provera added: 'Peugeot has won in every racing category it has entered except F1. It dislikes that exception. In my opinion, it will keep going (after 2000).'

**Peugeot will continue its** exclusive contract with Prost next season, according to Provera, despite stories that it could supply customer engines to Arrows.

**Damon Hill was one of** three drivers given a severe reprimand for not slowing down sufficiently for waved yellow warning flags during the warm-up for the Hungarian Grand Prix. Hill, Johnny Herbert and Toranosuke Takagi set their fastest laps of the session when Giancarlo Fisichella's Benetton had spun. The Italian had been avoiding Pedro Diniz's Arrows, which eventually stopped on the pit straight.

**Ferrari technical director** Ross Brawn has denied stories that Ferrari is planning to build a V12 engine. An Italian newspaper claimed last week that the team could revert to the format it abandoned in 1995. Brawn said: 'If they are working on it, they are doing so without my knowledge, and we work pretty closely together. The V12 format still has problems with size, fuel consumption and packaging.'

**Craig Pollock, the boss** of the new British American Racing team, has denied that he could buy Arrows. 'It's unrealistic when trying to set up a new team to think of setting up another one,' he said. Sources suggested that BAR tobacco sponsor BAT wanted to buy another team to promote more than the two brands it can with BAR.

**Minardi is said to be trying** to convince Ford to give it a semi-works engine deal for next season. The Italian team would like engines only one evolution behind works team Stewart, which has a contract saying that any customer V10 must be two specifications behind. The idea could appeal to Ford. Minardi's 1999 car, to be designed by the respected Gustav Brunner, could provide a benchmark for Stewart's performance.

**Williams has dismissed** wild speculation that Nigel Mansell could buy into the team. Technical director Patrick Head said: 'There's no substance to that at all. Why people bother making these things up, I don't know.'

# Panis will stay at Prost for '99

Frenchman Olivier Panis will stay at Prost next season despite interest from team boss Alain Prost in Williams star Heinz-Harald Frentzen. Prost was keen to take on the German to partner Jarno Trulli, who has committed to the team until the end of 2000. Title sponsor Gauloises, a French cigarette giant, is understood to have demanded it keeps hold of Panis. The 31-year-old has signed for 1999 only.

Prost denied he was under any pressure to sign a Frenchman, but he did admit it was 'preferable to have a French driver' from the point of view of 'one sponsor'.

The four-time World Champion said: 'I was interested in Frentzen, because it could have been very difficult to keep Olivier if he was not really committed to the team.'

Panis had doubts about the performance of the team, which has not scored a championship point in 1998. It is understood that he decided to stay after Prost told him that he is set to link up next year with former Ferrari designer John Barnard (see below).

'Olivier's motivation was my biggest problem,' Prost said. 'He was not confident about what was

happening in the team. I can understand that. It is difficult to motivate a driver if you don't have the results, but he saw we are making a lot of changes.'

Panis - whose contract, like Trulli's, was announced last weekend - said: 'We spoke about it a lot, and in the end I trusted in taking on the project for another year. Alain is going to organise the technical side of the team differently next year and that was important for me.'

It is understood that this year will be the last time Prost's sponsors will have such a strong influence in the team's driver line-up.

Prost has succeeded in convincing Trulli to stay until the end of 2000, despite the Italian driver's reservations.

Trulli is contracted to Benetton until 2003, but, according to Prost, the 24-year-old is on a firm contract with him. Benetton has an option to take him back for 2001.

Trulli said: 'When I started in F1, I was very young. Alain Prost gave me the chance to drive for him. I believe in the team and it is a good idea for me to stay for another two years. I still have a lot to learn.'



Panis, Prost, Trulli and Peugeot Sport's Corrado Provera shake on another year at Prost

## French team looks at UK design base

The Prost team is drawing up plans to design its cars in Britain.

Team boss Alain Prost is expected to sign up designer John Barnard to lead work on the team's 1999 car. Prost said that, even if his talks with the Englishman do not work out, he is likely to set up a base in England.

Barnard is locked in a legal dispute with Arrows, for which he designed this year's A19 car, after splitting with the team. Prost said that 'it should not be too difficult' to sort out the problems.

'I am talking to John,' said Prost, 'and the fact he no longer works with Arrows is certainly

interesting for the future.'

Prost said that if talks with Barnard fail, it is 'not impossible that I could set up my own place in England in the future, although not in time for next year'. He denied that he would buy Barnard's B3 technical centre.

'There are only two options,' he said. 'Either I work with John's company, or I set up my own. There is no point in buying B3.'

Prost has embarked on a major restructuring of his team's technical department. The position of incumbent technical director Bernard Dudot is understood to be under serious threat.

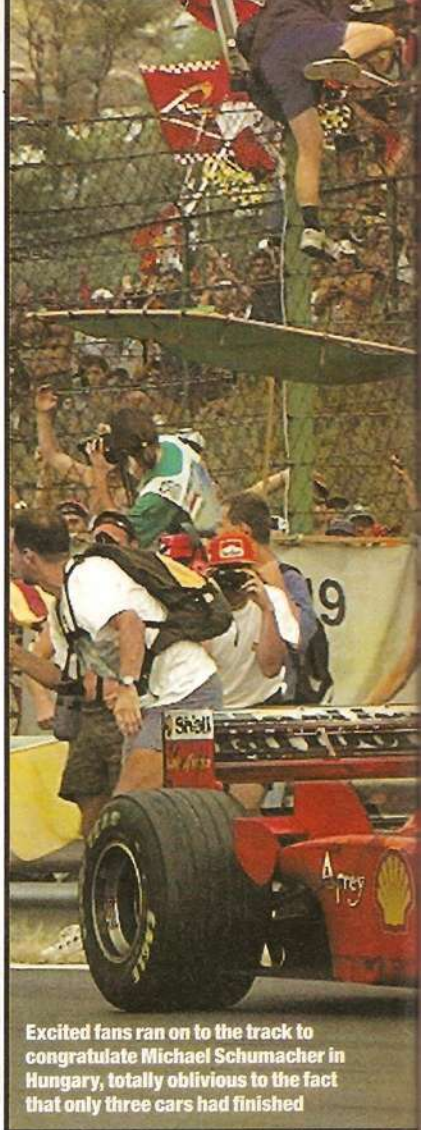

Excited fans ran on to the track to congratulate Michael Schumacher in Hungary, totally oblivious to the fact that only three cars had finished

## Arrows likely for Anderson

Jordan technical director Gary Anderson looks increasingly likely to switch to the Arrows team.

The Irishman has been asked to stay at Jordan, but sources say that a dispute between Anderson and the team over working methods could see him quit the outfit.

Jordan is expanding and wants Anderson, who has carried the team's technical department largely by himself, to free up some of his work to other people. Sources say that he is reluctant to agree.

He is understood to have had an offer from Arrows, which is in need of a technical director following its split with John Barnard, who looks to be heading to work with Prost (see story left).

Team boss Eddie Jordan is still trying to find ways to keep hold of Anderson, who is off work following a minor operation. He wants him to work alongside new chief designer Mike Gascoyne, who he recruited from Tyrrell in July.

Sources at Jordan say the team would like Anderson to stay but they would not be surprised if he left.

Eddie Jordan said: 'There are few high-quality engineers and Gary Anderson is one of them. He's been at Jordan all through his career, and I don't see any reason to change that.' ● Walkinshaw is still trying to land a Mecachrome engine for next year (see page six).





## Hungary faces fine over fans

A track invasion by fans at the end of the Hungarian Grand Prix could land the race organiser with a massive fine.

Hundreds of fans broke through debris fencing to celebrate Michael Schumacher's victory while cars were still on the track on Sunday. Tyrrell driver Toranosuke Takagi spun off avoiding fans on his slowing-down lap.

The Japanese said: 'I arrived at the back of the circuit only to find people all over the track. Happily, I didn't hit anybody, but in taking avoiding action, the engine stalled.'

The organiser of the San Marino Grand Prix was fined £625,000 in 1996 for a similar invasion. It only had to pay a quarter of the fine - the rest was suspended to become payable should there be another invasion within two years.

Some have speculated that a fine of that magnitude could risk ruining financially the Hungarian event.

Fans stormed into the pit lane to applaud Schumacher on the rostrum and some tried to steal team equipment. The sport's governing body, the FIA, is expected to look into the matter. It could demand that the Hungaroring strengthens its security for next year's race.

The FIA said it would not have an indication of what might happen until it receives the official report from the race.

**ONLINE**

**KEEP ON TRACK**

**FOLLOW THE NEWS AS IT HAPPENS AUTOSPORT ON AOL**

**Watch out for all the news Online first. To get your free AOL pack call**

**0800 279 1234**

**and don't forget to mention**

**AUTOSPORT!**

**(please allow 2 weeks for delivery)**

To receive **AUTOSPORT** Online, all you need is a PC and a modem. Simply call AOL on **0800 279 1234** mentioning **AUTOSPORT** and they will send you your free software. Because this is not a web site, there is no address as such. You merely type in keyword '**AUTOSPORT**' or find us in the sport section on the main AOL menu. With your free disc comes 10 hours free. Costs for AOL are £4.95 per month with 3 hours free, £2.35 per hour. Unlimited monthly access £16.95, unlimited annual access £179.40

## Indianapolis leads race for US F1

The USA's highest-profile motor racing circuit has moved into pole position to be the venue for Formula 1's return to America.

F1 boss Bernie Ecclestone is said by top-level sources to be 'getting closer' to a £15 million deal with the boss of the Indianapolis Motor Speedway for a contract starting in the year 2000.

The idea of a race at Indy is of enormous interest to Ecclestone: in the eyes of Americans, F1 could not race at a more prestigious venue.

A Grand Prix at Indy would ensure that the category's return to the US for the first time since 1991 would

be as high-profile as possible. Even the other mooted events, at San Francisco or Las Vegas, would not guarantee the same cachet.

The USA has been ambivalent at best about F1 and the prestige of a race at Indy could be the boost an American GP would need.

Indy is also enormously rich and would likely be able to pay a much larger fee than either the California or Nevada tracks.

Indy boss Tony George is bidding for a GP to boost the profile of his circuit. The Indy 500 has lost

prestige value since George split from the country's premier single-seater series, Champ Cars, and ran the race for his breakaway Indy Racing League.

He said: 'We have a good chance of getting it this time. I'm optimistic.'

Indy is proposing to build a road course on the infield of the 2.5-mile IMS. The GP track would run clockwise through Turn 1 of the superspeedway and turn off the main straight into the infield before Turn 4. It would rejoin the oval between Turns 1 and 2.



George: optimistic

## Frentzen taken to hospital after GP

Heinz-Harald Frentzen was taken to hospital after the Hungarian Grand Prix with stomach problems.

The Williams driver, sixth in last weekend's race despite doubts over his fitness to drive, had been ill all weekend. He was dehydrated and was put on a drip after the race before being taken to hospital in Austria on Sunday evening for further treatment.

A Williams spokeswoman said: 'They're keeping him in for observation. The signs point to food poisoning. But if he could do the race in that condition, he'll be fine for Spa (in 10 days' time).'

**LAS VEGAS PROMOTERS** hoping to bring F1 back to the city will learn next month whether they can proceed. The local authority will decide if plans for a temporary road course next to the famous Strip (artist's impression below) can go ahead





# BAR to test stock car ace

American NASCAR Winston Cup star Jeff Gordon could try out Formula 1 in a test for the new British American Racing team.

The 27-year-old admits he is interested in driving an F1 car and BAR boss Craig Pollock is keen to let him fulfil his wish.

Pollock said: 'We've been in contact with Jeff for over a year. We believe he's one of the best drivers in the world in a certain series. He's very talented. I'd like to have him test. I think he'd like to try it, too.'

He would not be drawn on when the test could take place.

Gordon is the dominant driver in the US series, the country's top racing category, and earns millions. Were he to enter F1, he would have to do so as an unproven beginner.

The NASCAR driver played down any chance of racing in F1. He told the *Winston Cup News*: 'If I was making a serious effort at F1, I would have been doing Formula Ford about 10 years ago. You need somebody with experience in that type of car on that type of track. You don't just

go and compete with those guys. 'As much as I'd like to drive an F1 car, I don't plan on doing it.

'My worst season was my first in the Winston Cup. I won the Rookie of the Year title, but I can't imagine doing another season as a rookie. Psychologically, it's too difficult.'

Gordon may also test a Champ Car in the future, a move that could be facilitated by Pollock, who has close links with Team Green in the US series.



Gordon: F1 test

## Bridgestone hits out at rival

Japanese tyre supplier Bridgestone has hit out at rival Goodyear for not clearing up the confusion around whether it will quit Formula 1.

Goodyear announced last November that it would pull out of Grand Prix racing at the end of 1998, but there have been consistent rumours that the company will change its mind.

Teams are now in the process of designing their 1999 cars and Bridgestone is faced with having to supply the entire field if Goodyear pulls out. The Japanese manufacturer's competitions boss, Hiroshi Yasukawa, said: 'Time is running out for us.'

He added: 'Due to procrastination by Goodyear, we are not yet in a position to make important decisions regarding next year. Goodyear's intentions have become increasingly obscure. Most recently we have heard suggestions that Goodyear will stay, provided that Williams and/or Ferrari agree to race on their tyres.'

Goodyear's F1 boss Perry Bell refused to rule out a U-turn.

He said: 'We said that we were pulling out at the end of this season. Right now, our chief executive officer, Sam Gibara, says we will be standing by the original decision. There is dialogue taking place. (But) if you asked him, he would say there is no doubt.'

## Rosset blames Tyrrell for poor form

Grand Prix backmarker Ricardo Rosset slammed his Tyrrell team after failing to qualify for the Hungarian GP.

The 30-year-old Brazilian, who has failed to qualify for four of the season's 12 races, said that the team is in limbo between its former Tyrrell identity and its 1999 guise of British American Racing.

He pointed to the rumours that say Tyrrell managing director Harvey Postlethwaite has won the deal to run the Formula 1 assault being planned by Honda, claiming that 'most of the technical staff at Tyrrell are now working on a separate project at Honda'.

Rosset said that the team is 'doing all it can to help' his team mate, Toranosuke Takagi, who is expected to drive for Honda. 'I am left with my engineer, who is inexperienced. I won races in Formula 3000. I can do a lot better than this.'

Tyrrell moved to deny Rosset's comments at the beginning of the week. 'Relevant team personnel are present at every team debriefing and all technical information is freely available,' it said. 'Despite Rosset's reported comments, he can be assured Tyrrell personnel will make every effort to help him qualify for the remaining four GPs.'



Rosset failed to qualify in Hungary and has put the blame squarely at Tyrrell's door

## Michelin rules out any early return

French tyre giant Michelin will not be returning to Formula 1 before 2001 at the earliest.

The company's competitions boss, Pierre Dupasquier, dismissed rumours linking it to an F1 entry with Williams, Prost or Ferrari in the next couple of years.

'Nothing allows us to say that F1 is our next objective, either in 1999 or 2000,' he said last week. 'Certainly, Michelin's financial situation has improved, but our bosses are afraid - perhaps rightly - about severe consequences from the Asian economic crisis.'

Last year, Michelin was believed to be making an F1 comeback in

1999, but the manufacturer decided against a return to motorsport's highest echelon, which it left in 1984.

Michelin cited Goodyear's decision to quit at the end of this season (see above) as being instrumental in that decision.

If both Goodyear and Bridgestone, its two main market rivals, were in F1, said the French manufacturer, it would have to consider returning seriously because of the promotional benefits of potentially beating them both on the race track. However, if only one was racing, the promotional benefits would not be so great.

## Honda set to defer comeback to 2000

Japanese manufacturing giant Honda is expected to delay its return to Formula 1 until 2000.

Sources say Honda has decided that racing next year would be too ambitious. It does not want to take on too much too soon.

Honda is thought likely to test extensively next season in preparation for racing in 2000.

Italian manufacturer Dallara is to deliver four chassis commissioned by Honda to England in November.

It is thought that Tyrrell managing director Harvey Postlethwaite has been put in charge of the project.

## Menu in third major shunt...

Williams Renault touring car ace Alain Menu has suffered his third heavy crash in 18 days.

The Swiss shunted in testing last week at Knockhill when the rear suspension failed. Once again, he escaped uninjured.

The latest incident followed on from a crash at Snetterton, when Menu unavoidably T-boned John Cleland's Vauxhall in the feature race, and an accident in testing at Thruxton when a tyre blew.

The Knockhill incident started at the fast Butcher's right-hander and ended at the following chicane.

'Something broke exiting Butcher's,' said Menu. 'I spun and hit the barriers at the chicane.'

The Swiss aggravated an existing neck injury, which has been painful throughout the

Thruxton weekend after the previous two accidents. 'The impact was over 6g,' he said. 'It's not too bad, but the problem was I wasn't fully recovered.'

The Williams team fabricated new parts for its Lagunas' suspension systems before qualifying. Menu was again forced to race the spare, in which he won at Thruxton.



Menu: 6g impact





# Warwick notches up first BTCC career win

Former Grand Prix driver Derek Warwick savours the moment of his return to the winners' circle in top-flight motorsport, after victory in the BTCC feature race at Knockhill on Sunday



British racing veteran Derek Warwick has ended a run of three seasons in the British Touring Car Championship without a win by scoring his first touring car victory.

Warwick, 43, triumphed in a dramatic BTCC feature race at Knockhill last weekend, during which he benefited from an inspired pit stop call from works Vauxhall team Triple Eight.

Ironically, the stop, which almost certainly won Warwick the race, was made while the safety car was on the track as wreckage from an accident in which he had been involved was cleared.

Warwick hit his Vauxhall team mate, John Cleland, after the start as the midfield avoided the stalled Honda of James Thompson.

Cleland's Vectra backed heavily into the tyre wall, but he escaped without injury.

The Scot is understood to be furious about the accident, but he was unwilling to be drawn into criticism of Warwick, who part-owns Triple Eight.

'I can't say much about it,' he said immediately afterwards. 'He got me on the left rear, and it was a much bigger impact than I anticipated.'

Warwick, who may have been tagged by a Peugeot before hitting Cleland, explained: 'There were four cars going for the same piece of road. It was one of those things - a racing incident.'

A BTCC insider indicated that, had Warwick hit anyone other than Cleland, he may not have been allowed to keep his win. He said it would have been 'too close to call'.

The win was set up when the Triple Eight crew gambled by fitting wet-weather tyres to Warwick's Vectra, which was at the back of the safety car queue. When it rained heavily later on, he took a clear lead as others pitted.

For Warwick it was his first victory since winning the 1992 Sportscar World Championship. In nearly three BTCC seasons, he had scored just one podium finish.

There is still doubt as to whether Vauxhall will retain Warwick for 1999. If it doesn't, he may retire.

'I want to stay and this has probably done me no harm,' he said. 'If I do finish at the end of the year, at least I've had a win.'



Cleland: upset

**Knockhill race report Page 48**

## ...and could face race ban threat

British Touring Car Championship racer Alain Menu will have to tread carefully to avoid a ban before the end of the season.

That's the verdict of BTCC title rival Anthony Reid, who was spun out of the lead by Menu's Renault Laguna in the series's feature race at Knockhill on Sunday.

Reigning BTCC Champion Menu was fined £500 and had his licence endorsed for the third time this season, an action which can lead to a ban. However, because one endorsement was for the relatively innocuous offence of straight-lining the Thrupton chicane in qualifying, the Swiss is unlikely to be forced on to the sidelines.

A fourth endorsement, on the other hand, might be viewed in a less favourable light by the RACMSA, British motorsport's governing body.

Reid said: 'The fact that he's got two driving offences against him might help keep him quiet in the remaining races.'

Audi racer Yvan Muller was also fined £500 and had his licence endorsed at the Knockhill meeting for a move on Honda driver Peter Kox, which spun the Dutchman down to seventh.

Muller said: 'What can I do? If you can't touch (another car) a little bit, then we should stop the meeting after qualifying.'

## Nissan powerplant supplier breaks duck

Nissan tuner Engine Developments has scored its first touring car win.

Title challenger Anthony Reid commandeered the ED motor raced by team mate David Leslie in the previous meeting to win Sunday's sprint race at Knockhill.

The John Judd-run company's powerplants were dropped from the works Primers earlier this year, and all five Nissan wins in the British Touring Car Championship so far had been taken by '97-spec International Engine Services units.

'The problems we had have been addressed,' said Reid. 'We'll move further forward for the next round.'

Audi's participation in next year's British Touring Car Championship could be in jeopardy.

A different interpretation of next season's touring car rules in the German Super Touring Championship may mean that the manufacturer's cars won't race in Britain.

The problem is a hangover from the days of the four-wheel-drive Audi A4 quattro, which, at the end of 1996, was given just one year left to compete.

Any manufacturer using the bodysheet and suspension from its four-wheel-drive model in 1996



Cleland crashed out of the Knockhill BTCC feature race after a collision with Warwick

# Rule confusion could force Audi out

could continue with them on its front-wheel-drive racers until the end of '98. For '99 companies will have to utilise front-wheel-drive models as the basis of their race cars.

Motorsport's governing body, the FIA, has ratified some minor rule changes for next season, and has left it to the discretion of each national championship as to whether this year's cars are allowed to compete in '99.

That has given the green light to manufacturers in the German championship to keep the rules as

they have been, meaning that the quattro can be used as the basis for the '99 Audi.

BTCC organiser TOCA is known to be against the idea, except in the independents' class.

Audi sports boss Wolfgang Ullrich said: 'The FIA ruling is a rubber paragraph which causes different regulations in different countries. The cars can't be transferred into '99 spec, and I won't be forced into deciding what to do with them.'



Ullrich: unhappy



# Menu linked with BTCC Fords

Reigning British Touring Car Champion Alain Menu holds the key to the 1999 driver market.

The 35-year-old Swiss has been strongly linked to the new alliance between Ford and top motorsports company Prodrive, as well as his current team, Williams Renault.

Menu, who is known to have visited Prodrive boss David Richards at the Benetton Formula 1 team within the last two weeks, said: 'I'm not going to deny it. It's obvious they are going to talk to me.'

Menu drove BMWs for Prodrive in 1992. He was also on the verge of

quitting Renault at the end of '94 to race a Prodrive-run Alfa Romeo when the French make completed a BTCC deal with Williams.

Rumour suggests that Menu has been offered £700,000 - around twice the going rate for a top-liner - to drive a Mondeo, or that this is the figure he is asking from Williams. He dismissed this as speculation. 'I would never ask for a silly amount like that,' said Menu, who has also been talking to works Vauxhall team Triple Eight. 'This is a national series - not a World Championship.' Richards said: 'All I know is that

(the company) is talking to a number of drivers.'

Menu's Williams team mate, Jason Plato, is reported to have four offers to consider if team boss Frank Williams does not take up his option for next season. Three are from within the BTCC, and are thought to be Vauxhall, Ford and either Honda or Volvo.

If either driver leaves Williams, the team could sign Honda ace Gabriele Tarquini. The team wanted the Italian BTCC

Champion in 1994, two years ago, but lost out to Honda. Although Tarquini has been tipped to remain there, he admitted at last weekend's German Super Touring round at Zweibrücken that he has a couple of alternatives.

Williams is thought likely to firm up its drivers in the next few weeks.

'We are discussing our driver situation for next year,' said the Williams team principal. 'We will announce the result in adequate time.'



Tarquini: in talks

## Peugeot may go in-house

Peugeot's British touring car fortunes could depend on whether the make centralises its worldwide Super Touring effort for next year.

It is believed that the French marque is considering taking the build of all 406s in-house to its base in Velizy, and that it would then supply the cars to be run by local teams in series such as the British Touring Car Championship.

To date Peugeot France has only built cars for one series at a time - it won the German Super Touring title last year. Meanwhile, Peugeot UK has been forced to go it alone because its French counterpart is worried about its secrets being learnt by a team which might switch to a different manufacturer in the future.

New Peugeot France sports boss Corrado Provera is thought to favour the centralised approach, similar to that successfully used by Honda and Nissan.

That could mean that Peugeot UK works team Motor Sport Developments, which has not achieved the expected results with its self-built 406s, could stay on with just a race-team deal.

MSD chief David Whitehead said: 'We'd have no objection to that at all. We want the French engine, and if that's a possibility, it must be accommodated in the best way.'

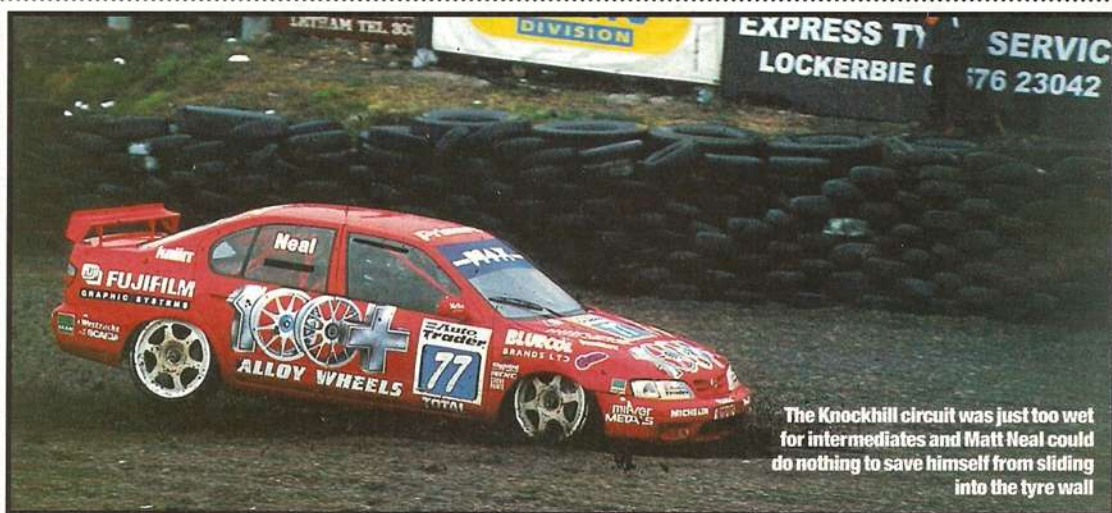

The Knockhill circuit was just too wet for intermediates and Matt Neal could do nothing to save himself from sliding into the tyre wall

## Neal loses indie jackpot in the wet

Touring car independent Matt Neal is 'gutted' after having a £100,000 jackpot snatched away from him by a wrong tyre choice.

The AUTOSPORT Cup contender was within a lap of taking the lead in Sunday's British Touring Car Championship feature race at Knockhill when he slid off the road into the tyre wall, costing him the big-money prize on offer from BTCC organiser TOCA to any independent driver who wins a race outright.

Neal, 31, was forced to the back

of the grid when his Team Dynamics Nissan Primera was found to be 9kg underweight after qualifying. The team gambled on a pit stop to switch from slick tyres to intermediates during an early safety-car period, allowing Neal to climb up the order. The leading Ford of Craig Baird was there for the taking, but Neal never got the chance to take the lead.

'I was thinking of ways I was going to spend it,' said Neal, 'and I already had 50 grand spent before I

went off. It just got too wet for the intermediates. I'm feeling a bit sick, because if we'd gone for full wets we'd have won by a country mile.'

● BTCC preparation expert Andy Rouse pulled the plug on Monday on plans to enter his Toyota Corolla Liftback in the indie class in the next round at Brands Hatch for former Peugeot driver Patrick Watts. Rouse said: 'We've taken a decision not to run because of a lack of suitable finance.'

Watts disagreed. 'There was money,' he said. 'I'm disappointed and annoyed, and I've wasted nine months of hard work.'



Neal: bad decision



Needell (right), with fellow Nissan drivers Reid and Leslie, is gunning for Mansell at Brands

## Needell to race Nissan tourer

Former Formula 1 racer Tiff Needell is to make another touring car comeback with Nissan.

Needell, 46, will contest the British Touring Car Championship races at Brands Hatch on August 31 as a one-off in a third Primera, alongside regular drivers Anthony Reid and David Leslie.

Latterly known more as a TV personality-cum-driver, Needell is competing in the races on behalf of the BBC's *Top Gear Motorsport*, which is celebrating 40 years of the BTCC. In September, he will follow up by racing a Jaguar Mk2, similar to the car which won the inaugural 1958 title, at Goodwood.

'Unfortunately, last time I drove a Nissan, it wasn't the best,' said Needell, whose previous BTCC experience was with Nissan in 1994. 'I've always wanted to have a go in a good car, and I'll be intrigued to drive this - it's so much more technologically advanced.'

Needell, who will test at Pembrey on Monday, says he aims to get in the top 10 and beat Nigel Mansell to avenge the 1993 TOCA Shoot-Out at Donington Park, after which Mansell claimed the former pushed him off. 'He'll be behind me on the grid,' Needell said. 'Mind you, he was at Donington, too, and he managed to overtake me.'



# Mill House Books

Mike, Sarah and John of MILL HOUSE BOOKS offer a unique personal service. We send out orders by return-of-post (subject to availability); our books are double wrapped for added protection; and our post & packing charge for UK customers is only £3.25 for orders up to £50 and FREE over £50.

Space does not permit us to list all of our books. Suffice to say we can supply virtually any motoring (or motorcycling) book generally available plus many motor sporting titles from overseas publishers

## STUPENDOUS SALE BARGAINS

- AUTOCOURSE 1996/97** (Henry). 272 pages devoted to the 1996 Formula 1 season and other major categories. Was £30. **£14.99**
- AUTOCOURSE 1995/96** (Henry). 272 pages covering 1995 Formula 1 season and other major categories. Was £30. **£14.99**
- FORMULA 1 YEARBOOK 1997/98** (Donjon). Excellent 222-page large-format annual covering the 1997 Grand Prix season. Recommended price £25. Unbeatable value at **£9.99**
- F1 MAGIC '97** (Schlitten). 176 pages, many stunning colour photos. Was £29.99. **£12.99**
- GRAND PRIX YEAR '97** (Aherne & Aron). Concise 144-page account of the 1997 Formula 1 season. Was £12.99. **£6.99**
- MURRAY WALKER'S 1996 GRAND PRIX YEAR** (Walker). All colour 144-page review of 1996 season. Was £12.99. **£6.99**
- MURRAY WALKER'S 1995 GRAND PRIX YEAR**. Was £11.99. **£3.99**
- THE OFFICIAL ITV FORMULA ONE 1997 GRAND PRIX GUIDE** (Jones). 128-page preview of last season's World Championship covers teams, drivers and events. Was £14.99. **£2.99**
- THE ULTIMATE ENCYCLOPEDIA OF FORMULA ONE**. The Definitive Illustrated Guide To Grand Prix Motor Racing (Jones). 256 pages offering information on teams, drivers, races, cars, statistics, etc. Was £18.99. **£5.99**
- GRAND PRIX: The Complete Guide** (Griffiths). New third edition gives full results of all World Championship races 1950-1997, 593 pages. Normally £18.99, to you **£4.99**
- GRAND PRIX DATA BOOK 3: Complete Record Of The Formula 1 World Championship From 1950** (Hayhoe & Holland). Full results of every race, grid positions, championship points, driver data, etc. 587 pages, including circuit diagrams. 100 b/w and 24 colour illustrations. Was £29.50. **£14.99**
- FORMULA ONE: The Complete Facts, Stats & Records Of Grand Prix Racing** (Jones). 304 pages covering drivers, teams, races, circuits, etc. Promotional price. **£2.99**
- GENERATION TURBO** (Assel & Rives). Covers the F1 turbocharged era. 160 pages, 200 colour photos. Text in English & French. Was £39.95. **£17.99**
- GRAND PRIX FASCINATION OF FORMULA 1** (Schlegelmich). 400 pages, 1000s of photos. Promotional price. **£19.99**
- LIFE AT THE LIMIT: Triumph & Tragedy In Formula 1** (Professor Sid Watkins). 256 pages. Was £16.99. **£6.99**
- THE NEW VILLENEUVE** (Collings). Updated paperback edition includes 1997 season. 256 pages. Was £6.99. **£3.99**
- VILLENEUVE: My First Season In Formula 1** (Jacques Villeneuve/Donaldson). 224 pages on Jacques' dynamic debut Grand Prix season. Was £20. **£8.99**
- DAMON HILL: On Top Of The World** (Henry). 160-page story up to winning the world title. Was £12.99. **£2.99**
- DAMON HILL WORLD CHAMPION: The Triumphant Story Of A British Sporting Hero** (Tremayne). Promotional price. **£3.99**
- JEANALESI: Beating The Odds** (Hilton). 176-page biography. Was £9.99. **£2.99**
- MICHAEL SCHUMACHER: Formula For Success** (Allsop). Own story includes race-by-race account of 1996 season. 144 pages, 125 colour photos. Was £17.99. **£5.99**
- MICHAEL SCHUMACHER: defending The Crown** (Hilton). 208 pages covers story to mid-1995. Was £9.99. **£4.99**
- NIGEL MANSELL: The Lion At Bay** (Hilton). Was £9.99. **£2.99**
- NIGEL MANSELL: The Complete Pictorial Record** (Sutton). Photographic tribute. Was £18.99. **£4.99**
- AYRTON SENNA: A Tribute** (Rendall). 174 pages probing the legend and the myth. Was £20. **£5.99**
- AYRTON SENNA: A Passion**. 218-page book with 300 colour photos taken by top lensman Keith Sutton, who had followed Senna's career from his karting days. Was £16.99. **£6.99**
- INDY RACING LEGENDS** (Sakkis). Profiles of 25 all-time greats of Indy car racing - drivers, builders and owners. 160 pages, 200 b/w photos. Was £15.95. **£6.99**
- THE 50 GREATEST GRAND PRIX WINNERS** (Cowland). 112 pages. Was £8.99. **£1.99**
- FORMULA 1 PORTRAITS** (Schlegelmich). 218-page book with 300 colour photos featuring over 500 b/w photos. Promotional price. **£19.99**
- CHAMPIONS: Hawthorn, Hill, Clark, Surtees, Stewart, Hunt, Mansell** (Hilton & Blunsden). 320 pages. Was £19.95. **£3.99**

## RACING

- THE CONCISE ENCYCLOPEDIA OF FORMULA 1** (Tremayne). 256 pages, over 350 colour and b/w photos. **£10.00**
- F1 50: Formula 1 - 50 Golden Years** (Tremayne). Colourful overview of half a century of World Championship racing. 118 pages packed with colour and b/w photos. **£4.95**
- FORMULA ONE THROUGH THE LENS: Four Decades Of Motor Sport Photography**. Nigel Snowden's superb black-and-white photos from the 1960s to the 1990s capture the atmosphere of Grand Prix racing from the days of Clark, Lotus and individual circuits up to the modern era. 160 pages, over 250 photos printed in duo-tone. **£5.00**
- FRANK WILLIAMS: The Inside Story Of The Man Behind Williams-Renault** (Hamilton). 292-page biography. **£16.99**
- MICHAEL SCHUMACHER: Controversial Genius** (Hilton). **£12.99**
- MIKA HAKKINEN: Doing What Comes Naturally** (Hilton). **£12.99**
- JACQUES VILLENEUVE: A Champion In Pictures** (Giantsanti). Taken by his official photographer a 160-page photographic record of the 1997 World Champion on and off the track. **£25.00**
- JACQUES VILLENEUVE: Champion Of Two Worlds** (Hilton). Second edition includes 1996 and 1997 seasons. **£12.99**
- GREEN RACED** (Eddie Irvine & Hamilton). Updated paperback edition, 304 pages. **£5.99**
- GOING FASTER: Mastering The Art Of Race Driving** (Lopez). 278 pages of information from Skip Barber Racing School. **£24.95**
- BATHURST: Cradle Of Australian's Motor Racing** (Medley). Wonderful in-depth history of Australia's famous racing circuit from 1938-1971. 476 pages and many b/w photos. **£49.95**
- SUN ON THE GRID: Grand Prix & Endurance Racing In South Africa** (Stewart). Reprint of a 1960s book covering F1 and endurance racing. 240 pages many b/w and colour photos. **£49.99**
- 1000KM DI MONZA: Trofeo Filippo Caracciola**. Full history of sports cars races held between 1953-56 and 1965-92. **£24.99**
- WATKINS GLEN 1948-1952: The Definitive Illustrated History** (Defechenaux). 160 pages. **£19.99**
- THRUXTON: The First 30 Years** (Lawrence). **£12.00**
- GOODWOOD FESTIVAL OF SPEED** (Lambot). 256 pages, many colour photos covering Festival up to 1997. **£35.00**
- THE ATLANTIC CHAMPIONSHIP: A Quarter Century On The Road To Stardom** (Zimmermann). 216-page book on US series. **£22.99**
- GOLDEN AGE OF THE AMERICAN RACING CAR** (Borgheson). 367 large pages on Duesenberg, Chevrolet, Miller, Offenhauser, etc. Many period b/w photos. **£28.99**
- VINTAGE & HISTORIC INDIANAPOLIS RACE CARS** (Owen). 96 pages, 80 colour photos. **£9.95**
- NASCAR 50 1948-1998: The Thunder Of America**. 200 large colourful pages on NASCAR's half-century. **£27.50**
- AMERICAN STOCK CAR RACERS** (Hunter & White). A-Z of NASCAR greats, 160 pages, 200 b/w and 100 colour photos. **£24.95**
- THE BOBBY ALLISON STORY: Circle Of Triumph** (White). 302 pages on NASCAR racer. **£28.99**
- THE BMC/BL COMPETITIONS DEPARTMENT: 25 Years In Motorsport - The Cars, The People, The Event** (Price). Re-issue. **£29.95**

**POST & PACKING DETAILS:** Britain & Northern Ireland: £3.25 for orders up to £50, FREE over £50. British customers should meet by cheque or PO or write, telephone or fax using MASTERCARD/VISA/AMERICAN EXPRESS/SWITCH. Please quote expiry date and in case of SWITCH issue number. **Channel Islands & BFPO:** £3.25 up to £32.50, 10% of book value £32.50-£150, 7% over £150. **Overseas:** inc Republic of Ireland - £5 up to £33.33 book value, 15% of value of books £33.33 to £150, 10% over £150. Air mail rates on application. Overseas customers should remit by E-sterling bank draft, Euro cheque or international money order or write or telephone using VISA, AMERICAN EXPRESS, EUROCARD or MASTERCARD number plus expiry date. US\$ cheques/drafts also accepted.

**MILL HOUSE BOOKS, The Mill House, Eastville, Boston, Lincolnshire, PE22 8LS**  
Tel: 01205 270377, Fax: 01205 270551, E-Mail: MHBooks2@aol.com

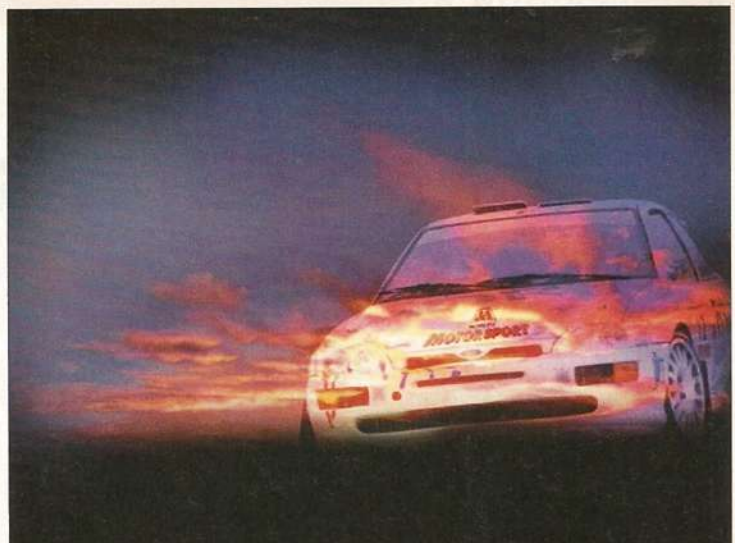

## Pour yourself a quick one

Over 20 Racing and Rally Champions use full synthetic Millers XFS engine oils to give themselves the edge with extra BHP and mechanical protection. You could do the same in your own road car.

Independent tests undertaken on a dynamometer with competition engines, have proved that Millers XFS delivers from up to 5 BHP advantage over six of the world's leading race-bred engine oils, whilst still maintaining or enhancing torque levels (if you need proof, freephone for a copy of the test results). You can expect even better performance with low friction Millers XFS, when comparing it to your normal engine oil.

Use all that extra power for faster acceleration for safer overtaking or benefit from increased MPG, either way Millers XFS is the ultimate oil for engine protection.

Call FREE on 0800 281 053 for the name of your local Millers Oils performance lubricant stockist.



Release more power from your road car with Millers race-proven synthetic lubricants





News In Brief

FORMULA 1

**McLaren is testing at** two circuits this week as it battles to stay ahead of Ferrari in the World Championship. Mika Hakkinen is going to Silverstone, with David Coulthard heading for Monza, where Ferrari will also be running. Benetton, Jordan and Prost are going to Monza, too, with Williams, Arrows and Stewart at Silverstone. Sauber and Minardi will be at Mugello.

TOURING CARS

**Nigel Mansell is due to test** with works Ford team West Surrey Racing at Pembrey at the end of this week. Mansell races a Mondeo at Brands Hatch in 11 days' time – his second British Touring Car Championship outing this season.

**Vauxhall BTCC veteran** John Cleland raced with acupuncture needles in his right ear at Knockhill. The 'New Age' remedy was a bid to fight off pain from a rib broken in his crash at Snetterton last month. Cleland, who missed the previous meeting at Thruxton, said: 'It does work and it's taken my mind off things. With all these bits of metal needle I can pick up Radio Luxembourg!'

**Cleland has indicated that** if Vauxhall doesn't retain him for an 11th season in the BTCC, he would be happy to line up alongside championship leader Rickard Rydell in the TWR Volvo team next year. The Scot is a Volvo dealer.

**Volvo BTCC driver Gianni Morbidelli** left independent racer Robb Gravett fuming after taking the Honda man out of the sprint race at Knockhill. 'I've spoken to him,' said Gravett. 'He said: "I thought you were letting me through". But no, Gianni, it's a race.' The Italian was reprimanded for the move.

**GT Porsche racer Michael Bartels** made his seasonal German Super Touring Championship debut at Zwiibrucken on Sunday, finishing eighth in the main race in a third works Peugeot 406 (below). Bartels will contest the remaining three rounds of the season.



**Former Bathurst 1000 winner** Tomas Mezera is trying to sign reigning BTCC Champion Alain Menu to race his V8 Holden Commodore in the Australian 1000 at Mount Panorama in November. Menu said: 'I'm keen to do it and Tomas is a nice guy, but I don't know what I'm doing next year and I might not be able to go.' BTCC colleague Tim Harvey is also linked to the drive.

Maiden CART win for Scot

Scottish Champ Car ace Dario Franchitti has finally broken his CART duck, with his first US victory.

The 25-year-old benefited from slick pit work from his Team Green crew to triumph on the four-mile Elkhart Lake road course in Wisconsin last weekend.

Franchitti, who broke into the CART Championship Series last season, had failed to win a race despite taking four pole positions.

His biggest disappointment had come in the Toronto street race in Canada last month, when the former McLaren AUTOSPORT Young Driver spun his Reynard-Honda out of a clear lead in the closing stages.



Franchitti: perfect

'After I spun in Toronto, I had the attitude: "What have I got to do to win?";' said Franchitti. 'In Mid-Ohio a couple of weeks ago, I couldn't believe it when we crashed at the first turn. To

win a race you've got to get everything right.'

Franchitti added that the first win is always the hardest. 'Now I've finally got it, it's not a big mystery any more,' he said. 'It gives the team the quiet confidence they need to know they can all do their job.'

The victory was Franchitti's first since he scored for Mercedes in the 1996 International Touring Car Championship. It also broke a drought for Team Green stretching back to July 1995, when Jacques Villeneuve won at Cleveland.

Team owner Barry Green said: 'It was just a matter of time with Dario, and what a perfect race he drove. I'm just emotionally drained. To get that second win is going to be very hard, but easier than this one.'

Driver column Page 63

Dario Franchitti drove a perfect race at Elkhart Lake last weekend and says now that the mystery of winning has gone, he can do it again

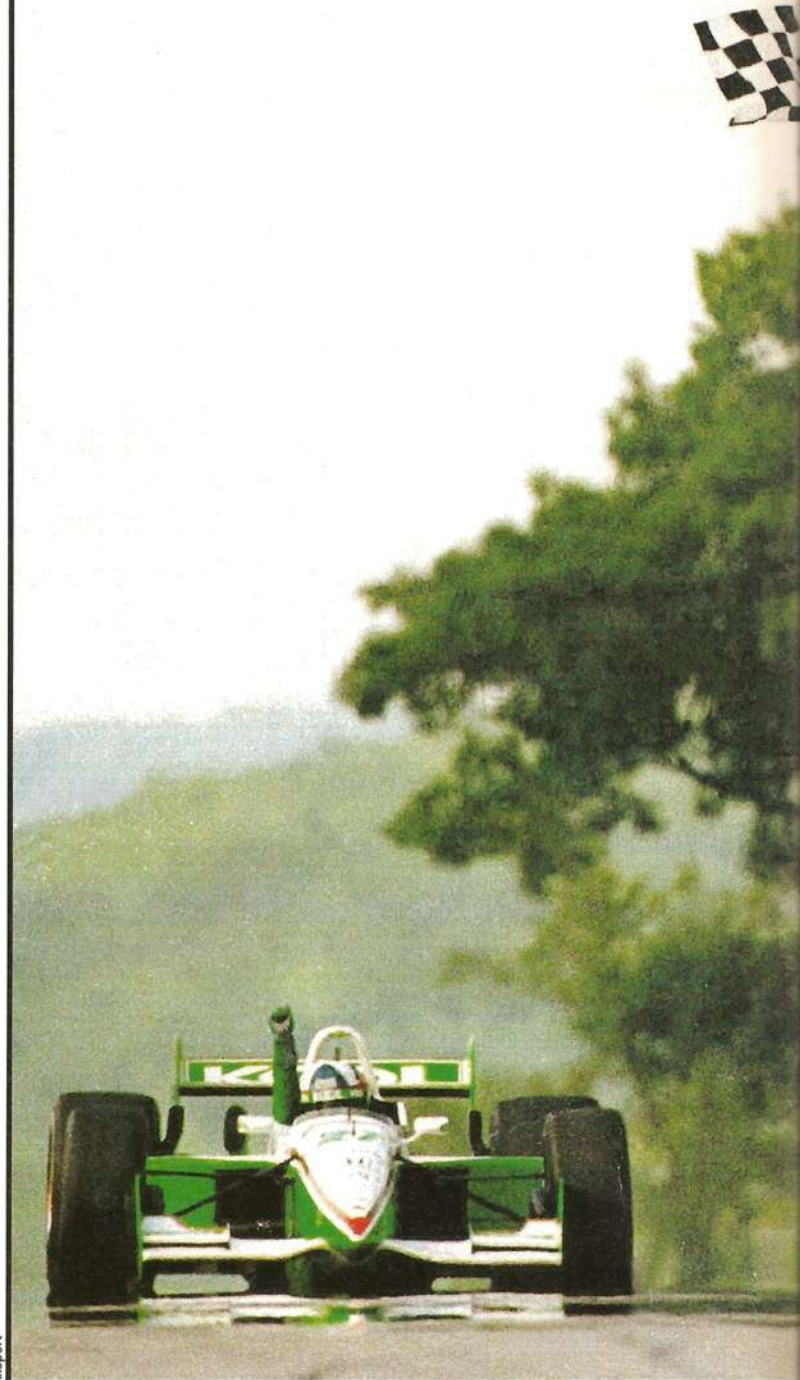

Alisport

BTCC bids for more independent runners

Touring car manufacturers are being cajoled to boost the number of independent runners in the British Touring Car Championship.

The makes are being encouraged by BTCC organiser TOCA to lease or give cars to teams in the AUTOSPORT Cup, which has shrunk to three cars in recent races.

TOCA chief Alan Gow has said that motorsport bosses have shown increased willingness to go along with the plan, especially as indie runners are more competitive thanks to revised tyre rules. 'A good independent is a cheap way to have three competitive cars,' he said.

Adelaide back for endurance race

The Adelaide Grand Prix street track could be revived for an Australian touring car endurance race next season.

The track, which Formula 1 teams last visited in 1995, is tipped to play host to an Easter "speed week", topped by a long-distance five-litre V8 Supercar round. Tin-top star Mark Skaife and series boss Tony Cochrane are among those to have recently visited Adelaide, but Cochrane would only say that the '99 calendar will be unveiled next month.

For the first time in recent years, the series will include the enduro classics at Sandown and Bathurst.

Major practice crash puts Cook out of race

British Formula 3000 racer David Cook was forced out of action at the Hungaroring on Saturday following a violent practice crash.

Cook's Redman Bright Lola careered into the tyre wall at a fast right-hander and he was taken for a check-up in hospital, where doctors advised him to take a 10-day break from driving.

Team boss John Bright said: 'He was feeling a little shaken, but he's basically fine. The car got slightly out of shape, slid one way and then snapped back the other before it hit the wall. It was a pretty big impact and the car is badly damaged.'



# Warring US series in peace talks

America's two rival top-level single-seater series are discussing ways to end their three-year war.

The CART Championship Series and Indy Racing League, which split from CART in 1996 taking the showcase Indy 500 with it, have admitted that an accommodation is being sought.

CART team owners Pat Patrick and Derrick Walker are at the head of a group willing to look for compromise with the IRL party, led by team boss Brad Calkins.

A CART spokesman admitted that the two sides are having 'conversations' and keeping an

open dialogue. The IRL is aware that its teams, considerably poorer than those in CART, mustn't be priced out of the competition.

IRL executive director Leo Mehl said: 'We're sticking with our basic principles. The equipment has to be available to everyone. We're going to run on oval tracks and cost-contain as much as we possibly can.'

Top IRL team owner Tom Kelley, who runs inaugural champion Scott Sharp, believes a union can be achieved. 'We've got to sing together instead of biting one another on the back,' he said. 'In the

past 90 days, I've seen more willingness on the part of CART owners to talk.'

Rival AJ Foyt said: 'We're too far apart. We're two leagues with two different types of cars.'

The biggest problem is the differing engine formulas. The CART teams's cars use turbocharged 2.65-litre units, while the IRL is based on naturally-aspirated four-litre motors.

CART insiders suggest that there is little possibility of any major changes occurring to the engine formula, which comes up for review in 2000.



## Zanardi can wrap up series

Italian Alex Zanardi could become champ or chump in the next round of the CART Championship Series.

Zanardi can wrap up his second successive title at the Canadian street race in Vancouver, but is still on probation for a series of incidents at Mid-Ohio 11 days ago and may face a ban if he offends again.

He escaped any penalty at Elkhart Lake on Sunday after a first-lap incident which forced two-time champion Al Unser Jr out of the race.

A furious Unser said: 'Whoever hit me obviously wasn't thinking.' Zanardi, who went on to finish second, said: 'I slammed on the brakes to try to stop and I couldn't see where I was going. I'm sorry I ruined his race.'

CART chief steward Wally Dallenbach, who studied video tapes and interviewed drivers, termed it 'a racing incident'.

That leaves Zanardi free to try to extend an 80-point advantage over Chip Ganassi Racing team mate Jimmy Vasser in Vancouver on September 6. Zanardi needs to build an extra eight-point advantage, equivalent to three or four places, to secure his second successive title with four rounds to go.



Zanardi: title bid



Ralph Hardwick

**PENSE RACER Andre Ribeiro competed in the Champ Car round at Elkhart Lake, despite having a broken leg. The Brazilian crashed in qualifying and sustained a hairline fracture, but raced with a carbon-fibre shinguard. He went out after eight laps with ignition failure**

## Pruett move opens silly season

Champ Car veteran Scott Pruett has switched teams for 1999 and opened the floodgates to this year's silly season.

Pruett, 38, will end a five-year relationship in the CART Championship Series with successful team owner Pat Patrick and line up with the less prominent Arciero-Wells squad next year.

Patrick and Pruett decided earlier this summer to split, giving the latter plenty of time to find another drive. 'I talked to everybody,' said Pruett. 'I had to look at where I was going to go and I feel that this is my best opportunity.'

Pruett, who will replace the

disappointing Robby Gordon, shrugged off doubts over the team's Toyota engines, which are the least competitive in Champ Cars.

'I truly believe Toyota is going to turn this thing around and be the engine to have in the new millennium,' said Pruett, who with Bobby Rahal's retirement this winter will become the oldest CART driver.

The move means seats are available at three top teams - Patrick, Chip Ganassi Racing (to replace Formula 1-bound Alex Zanardi) and Team Rahal. Gordon, meanwhile, is trying to put his own Toyota-powered team together for 1999.

## F3000 racers sick of 'yellow' peril

Formula 3000 drivers are tiring of what they see as draconian penalties for failing to heed yellow flags.

British ace Jamie Davies, one of several to have qualifying times disallowed at the Hungaroring, said: 'The situation is getting silly. There were yellow flags out virtually all the time in second practice.'

'You don't want to cause a dangerous situation, but it's hard to judge how much they expect you to back off.'

Czech Tomas Enge said: 'I accept the penalty because I did wrong, but there were so many spins there were nearly always yellow flags.'

**CRASH-PRONE CHAMP CAR racer Bryan Herta escaped injury from this shunt at Elkhart Lake. Herta spun and came to rest facing the track, only for backmarker Alex Barron to run straight on and launch his Eagle over the top of the Reynard. 'Luckily I saw him coming,' said Herta. 'I was able to duck down in the cockpit, I'm sure it looked scarier from the outside. I dinged my hands, but nothing serious'**



LATIMER



Next week in  **AUTOSPORT**

# WILLIAMS

**A dynasty in decline, or ready to rule again?**



They've lost their champion, chief designer and world titles.  
**WHERE NEXT FOR THE DREAM TEAM?**

**BELGIAN GRAND PRIX PREVIEW**

**PLUS** 1000 Lakes Rally • Behind the scenes at BMW  
Your guide to all the Bank Holiday racing

Contents correct at time of going to press



# GT rule changes to close field

A series of rule changes designed to make racing closer will be in place for next month's Donington Park round of the FIA GT Championship.

However, it appears unlikely that anything will be done to close the gap between the dominant AMG Mercedes team and Porsche, its only factory rival.

The FIA, which organises the series, announced last week that it will exercise its right to 'maximise the equality of performance'. Series rules permit this by way of changes to the power-regulating engine air-restrictors, the Formula 1-style skid-plank and minimum weight.

The FIA looks set to concentrate on bringing the second-string teams from Mercedes and Porsche - Persson and Zakspeed respectively - closer to their factory counterparts.

One possibility is that Persson's long-running campaign to race its year-old Merc CLK-GTRs without the performance-sapping skid-plank could bear fruit. That would be opposed by Porsche.

Porsche motorsport boss Herbert Ampferer said that because Persson was a true factory team it shouldn't receive a performance break, designed for privateers. He said he saw 'a clear difference between

Persson and Zakspeed, which is a privately-funded team'.

Ampferer was quick to point out that Porsche had in no way lobbied for any performance boost in the wake of the factory's three straight defeats by Mercedes since June.

Mercedes sports boss Norbert Haug said that he could 'not accept' moves to limit the performance of AMG's CLK-LMs. 'Racing is about pushing to the limits,' he said. 'It's not the job of the FIA to penalise us because we are winning.'

The privateer DAMS Panoz team will also be subject to the performance review.

## News In Brief

### TOURING CARS

**Audi star Yvan Muller** said after finishing second at Knockhill that he wants to stay in the British Touring Car Championship next year. 'I've raced in France, Italy, Germany and Britain,' said the Frenchman. 'But of all the championships I've competed in I like Britain the most.'

**BMW folk hero Joachim Winkelhock** has hit out at critics who slated him for moving over and allowing team mate Johnny Cecotto to win both German Super Touring races at Zweibrücken. The act allowed the Venezuelan to extend his series lead for the Schnitzer team. 'Should I have said I had a brake problem, or trouble with tyres?' Winkelhock said. 'Whatever I do, people say it's wrong. If I didn't help him, people would say that we are completely mad. We all drive for BMW and want the best result for our team.'

### CART

**Champ Car comingman** Richie Hearn is tipped to remain at his current team, Della Penna Motorsports, rather than join Team Rahal. Della Penna is looking for a bigger budget to retain Hearn.

**Belgian former Formula 3000** racer Wim Eyckmans has joined the crack Brian Stewart Racing team for the remainder of the Indy Lights Championship. Eyckmans, who last year tried to set up a Formula 1 team, replaces Brazilian Sergio Paese, who is concentrating his efforts on breaking into Champ Cars and will test with the Payton-Coyne team at the end of the season.

**Omar Martinez, who leads** Argentina's TC2000 series for silhouette touring cars, will race in Indy Lights next season. Martinez and fellow TC2000 racer Guillermo Ortelli tested a Lights car at Portland last week, and will drive for a new Argentinian-owned team.

### FORMULA 3000

**Frenchman Cyrille Sauvage**, who has struggled for a budget this season, will continue with the Italian GP Racing team for next week's race at Spa. But he is not sure whether he will retain his seat after the race.

### SPORTSCARS

**Former touring car driver** Patrick Watts could make a full-time return to the cockpit in the FIA GT Championship. He will drive a Saleen Mustang Ford, sister car to his mount for the British Grand Prix GT race, in next month's Donington Park round of the FIA series. Further outings in the car, run by the GP Motorsport team, are envisaged.

**GT irregular Max Angelelli** will race the Japanese SARD team's Toyota Supra in this weekend's FIA GT series round at Suzuka.



**BRITON STEVE SOPER (3)** gave the BMW Rafanelli team its first pole in the International Sports Racing Series at Anderstorp. Although Soper and Pierluigi Martini, deputising for Hans Stuck, finished third in their Riley & Scott, the team was happy it had solved the problems with its BMW V8 engine that blighted its early season. The race was won by the JB Racing Ferrari. ● Full report page 77

## Euroseries under threat

The future of the new-for-1998 GTR Euroseries looks bleak after the cancellation of two end-of-season rounds in Britain.

Races at Brands Hatch and Donington Park, in September and October respectively, have been called off through fears of a low entry. So far this year, the GTR has struggled to top the 20-car mark.

Donington boss Robert Fearnall said: 'We have been forced to cancel because we don't have a promotable event. The series started badly and hasn't got much better.'

The British Racing & Sports Car Club, which was running the Brands event, cited similar reasons. A statement said the series organiser had been 'unable to guarantee a sufficiently high-quality entry'.

GTR boss Patrick Peter, one of the founders of the now-defunct Global Endurance GT Series, had claimed he expected a large number of entries from the domestic British GT championship. Fearnall, however, said few British teams had expressed interest in competing. 'We suggested two 50-minute races. When they said it had to be four hours, we said: "Thanks but no thanks".'

## Viper superiority penalised again

The Chrysler Vipers that dominate the second division of the FIA GT Championship are to be penalised for the second time in four races.

From next month's Donington Park round the two ORECA team Viper GTS-Rs will have a 50kg weight penalty in an attempt by the series organiser, the FIA, to spice up the competition in the class. This follows on from last month's decision to give its rivals more power.

The news was welcomed by teams running the Porsche 911 GT2, the Viper's closest competitor. Fabian Rook, boss of Rook Racing, said: 'This seems fair. The FIA has clearly looked at all the data

- the corner speeds, as well as the straight-line speeds.'

ORECA accepted the FIA's decision, but denied the rules favoured the seven-litre Viper over the turbo Porsches. The team's sporting director, Pierre Dieudonne, said: 'We think we are the most competitive team with the best drivers, so it should be up to the other teams to raise their game.'

● The privateer Chamberlain Viper squad has received a performance break in time for this weekend's Suzuka FIA round. The team will now be able to run with the extra power allowed to the Viper's rivals before July's Dijon race.

## Neal eyes assault on Daytona 24 Hours

British touring car stalwart Matt Neal is considering contesting next year's Daytona 24 Hours sportscar classic.

Team Dynamics, the outfit which prepares Neal's Nissan Primera, could send the Porsche 911 GT1 it ran for him in the British GT round at the Silverstone Grand Prix meeting. Dynamics boss Steve Neal, Matt's father, said: 'Why not? There's nothing else to do in the winter.'

Neal Sr said that Swede Carl Rosenblad, who races a Primera in his domestic tin-top series, is interested in joining the squad. Factory Nissan star David Leslie may also be asked to drive.

## Bitter unlikely to make comeback

The Dutch Bitter team, which ducked out of the FIA GT Championship in June, looks unlikely to return.

Team boss Toine Hezemans was not available for comment, but the news that he has placed his son, Mike, with another team has confirmed suspicions that the series has seen the last of the Bitter GT1. Hezemans Jr will race a Rook Porsche 911 GT2 for the rest of '98.

Fabian Rook, boss of his eponymous team, said: 'I'm glad to have Mike back; we had some good results when he drove for us in the Porsche Supercup.'



Peter: cancel races

Marr/Sutton





Derek Warwick – Winner of  
Round 20 of the 1998 British Touring Car  
Championship at Knockhill



*Congratulations Derek on your first BTCC victory*

**TOSHIBA**

Electronic Imaging



Division

*Toshiba, racing ahead with Vauxhall Sport*  
0990 862802



# Bernoldi title lead evaporates

Brazilian Enrique Bernoldi has lost the lead of the AUTOSPORT British Formula 3 Championship he once seemed certain to win.

Bernoldi, whose lead stood at 39 points (with 20 for a win) in May, finished only fourth and seventh in the races at Pembrey on Sunday. He is now 13 points behind compatriot Mario Haberfeld with four rounds left.

Bernoldi, 19, singled out Haberfeld and Briton Warren Hughes to blame for two incidents which cost him places.



Haberfeld: leader

'Mario braked early at the first corner,' said the Promatecme driver, 'and in avoiding him I was forced to go straight on. When I rejoined I was seventh.'

Haberfeld claimed his rival merely braked too late on cold tyres.

Bernoldi was particularly angry with Hughes, whose challenge for second place midway through race two left both cars stationary across the track.

'He came from a long way back and just hit me,' he said. 'It was a hard weekend for me, but I'm still

confident. Now we are moving to some real drivers' circuits like Thruxton and Spa, where I won last year, so that should suit me better.'

Haberfeld, first and second in Sunday's two races, was careful not to let his optimism run too high. 'We came here to get the lead of the championship,' said the 22-year-old. 'The team has improved a lot since the start of the year and I have definitely improved my driving. All that makes me confident for the remaining races.'

**Pembrey F3 race report Page 70**



Bernoldi's title lead went up in smoke with two controversial incidents at Pembrey

Bellanca/LAT

## Comeback for Craven stalls

Accident-prone Ricky Craven has lost his NASCAR Winston Cup drive just four races into his comeback.

Despite taking pole position at the New Hampshire International Speedway on his return in July, he has had a poor run of results since.

The 32-year-old had come back after a four-month lay-off because of an ear problem which affected his balance. It was the legacy of his heavy crash at the Texas Motor Speedway in April last year.

Wally Dallenbach Jr replaced him in the Hendrick Motorsports Chevrolet Monte Carlo at the Michigan Speedway last weekend, and will complete the season.

Craven refused to comment, but team boss Rick Hendrick said his inability to regain good race form caused the dismissal. 'Looking back at the performance in these last four races, not qualifying for example, the chemistry had just faded,' he said.

Meanwhile, NASCAR's "Mr Excitement", Jimmy Spencer, has taken a sabbatical to recover from head injuries he suffered in a crash at Indianapolis on August 1.

The 41-year-old, who drives the Travis Carter Racing Ford Taurus, wants to learn from Craven's experience. 'Ricky got a raw deal, but he had rushed his recovery and that ultimately cost him his ride,' he said.

## Madras racer adds spice to the F3 mix

Indian Narain Karthikeyan stunned British Formula 3 Championship insiders on his return to the series at Pembrey.

The 22-year-old from Madras finished fourth and sixth in Sunday's two races, on his debut with the Carlin Motorsport team. He qualified third and fifth. His previous best was just 12th.

Karthikeyan had missed the previous six rounds because of budget problems which forced him to split from the Intersport team. He is confident of finishing the season.

'The team has a lot of experience and did a great job,' he said.

## Cook Portman Arrows debut hit by misfire

Formula 3 racer Paula Cook had a miserable debut with the Portman Arrows team at Pembrey.

Cook, 28, missed a qualifying session because of an electrical fault on her Dallara-Renault, and then had a best finish of 14th on Sunday.

'I had a misfire in both races and the dash went down in the first,' said a disconsolate Cook. She joined the team from the family DC Cook Motorsport outfit.

The problem was a recurrence of troubles that have blighted the team recently, and which it tried to eradicate in a test at French track Lurcy-Levis last week.

## News In Brief

### SPORTSCARS

The American Dyson sportscar team could trade in its Riley & Scotts for the new Lola T98/10 sports racer. The team, winner of last year's Daytona 24 Hours, is expected to undertake a development programme with a Ford-powered version of the car before deciding. The car is expected to have a brief shakedown in the UK next month.

The final round of this year's US SportsCar GT and World Sports Car series will dovetail with the FIA GT Championship season closer at Laguna Seca on October 24/25. The US series had been expected to end with Petit Le Mans on October 10.

### FORMULA 3

DC Cook Motorsport team manager Paul Haigh has said that driver Paula Cook's swap to Portman Arrows may not be the end of the road for the team in the British F3 Championship. 'We will hopefully be back next year with two fully-financed drivers,' he said.

Formula Ford frontrunner Craig Murray had his maiden F3 test with the Carlin Motorsport team at Pembrey on Tuesday. Murray hopes to race next season, possibly under the wing of the new Motor Racing Developments scheme.



Australian Phillip Scifleet, winner of the National Class in this year's British F3 Championship, received his trophy (above) at the Pembrey round last weekend.

Dane Kristian Kolby could be forced to sit out the next two British F3 rounds, if doctors insist on operating on a hernia. Kolby raced his Fortec Motorsport Dallara at Pembrey with the injury.

### INTERNATIONAL

The historic New Zealand Grand Prix is being revived after a three-year hiatus. Cars from the Australian Formula Holden Championship, for Holden-engined ex-Formula 3000 cars, will contest the race at Ruapuna on December 6.

Knockhill, Scotland's only race circuit, has applied for a National Lottery grant to help fund its £3m revamp. The project includes widening the track by three metres and laying tarmac on the paddock.



BRITISH FORMULA 3 ACE Darren Manning was foiled on his All-Japan series debut by clutch problems forcing him to jump the start. Manning was eighth on the TI Circuit when he got a stop-go penalty. 'It's a shame. I was confident of getting fourth,' he said

Tsuboi



# Makinen close to unique win

Tommi Makinen stands on the brink of a unique achievement this weekend. Should he win the Neste Rally Finland, he will be the first driver ever to win the same event five times in succession. Crucially, however, he needs that fifth win to remain a contender in the World Championship title race with three events to go.

The Finn is currently 13 points behind series leader Carlos Sainz and 10 adrift of Colin McRae. He must quickly close the gap if he is to have any hope of claiming a third world title this season.

While Sainz and McRae lead the points race, Ford's Juha Kankkunen is the only driver to have threatened Makinen in recent years. Equally, Subaru's "guest" star, Jarmo Kytölehto, has finished third on each of the last three Finnish events, while Sainz and Toyota team mate Didier Auriol are the only two non-Scandinavians to win this event.

This is a rally where running order matters and often it is best to take a tactical penalty to avoid opening the road for later runners.

A spectacular entry, including 40 seeded drivers, will line up in Jyväskylä for the start tomorrow afternoon (Friday).

Further interest centres on the competition debut of the SEAT WRC in the hands of Harri Rovanpera and Oriol Gomez.

SEAT's Formula 2 campaign passes into the hands of Toni Gardemeister and Gwyndaf Evans, who leads a massive contingent of British Rally Championship entrants. Mark Higgins drives the Nissan Almera, Alister McRae his VW Golf and Tapio Laukkanen a Renault Maxi Megane, taking on the Hyundai of Kenneth Eriksson and the Ford Escort Maxi of Olli Harkki.

#### LEADING ENTRIES

- 5 Sainz/Moya .....Toyota Corolla WRC
- 3 McRae/Grist .....Subaru Impreza WRC98
- 1 Makinen/Manisenmaki .....Mitsubishi Lancer E5
- 7 Kankkunen/Repo .....Ford Escort WRC
- 6 Auriol/Giraudet .....Toyota Corolla WRC
- 2 Burns/Reid .....Mitsubishi Carisma GT/5
- 8 Thiry/Prevot .....Ford Escort WRC
- 4 Kytölehto/Kapanen .....Subaru Impreza WRC98
- 9 Rovanpera/Pietilainen .....SEAT WRC
- 10 Gomez/Marti .....SEAT WRC
- 11 Vatanen/Gallagher .....Ford Escort WRC
- 12 Gronholm/Rautainen .....Toyota Corolla WRC
- 13 Lindholm/Hantunen .....Ford Escort WRC
- 14 Radstrom/Barth .....Toyota Corolla WRC
- 15 Nittel/Thorner .....Mitsubishi Carisma GT/5

#### TIMETABLE

**Leg 1:** Friday August 21, Jyväskylä-Laajavuori, 1300-2128, nine stages. **Leg 2:** Saturday August 22, Laajavuori-Laajavuori, 0700-2004, nine stages. **Leg 3:** Sunday August 23, Laajavuori-Jyväskylä, 0700-1610, six stages.

Tommi Makinen must take a unique fifth Rally Finland victory to stay in this year's World title hunt



Freddy Loix has enjoyed great success with Toyota and wants to stay if at all possible

## Loix: 'Toyota still my first choice'

Freddy Loix might be being touted as a likely driver at both Mitsubishi and Subaru, but the rising Belgian ace says he would prefer to stay on at Toyota.

Over the past three seasons, he has developed into a talented driver on all surfaces and can now hold down a regular place in anyone's World Rally Championship campaign.

He has been bankrolled by Marlboro Belgium and he told AUTOSPORT two weeks ago that he is determined to continue his link with the cigarette company wherever he goes next season.



Loix: third Corolla

However, recent suggestions that Toyota is talking with Winfield for 1999 sparked discussions that Loix would have to look elsewhere for work next year if he is to have his way.

'I want to stay with Toyota if possible,' he said on Monday. 'I'm prepared to drive a third Corolla, but it has to be for 14 rounds. The matter is out of my hands now, it has to be decided between (Toyota Team Europe boss) Ove Andersson and Philip Morris Belgium.'

Loix is under contract to Toyota until the end of September.

## Jim Clark joins British series

The Jim Clark Memorial Rally has been confirmed as a British Championship round for 1999, with SEAT agreeing to back it.

'I'm delighted that we are able to accept the invitation from the RACMSA (British motorsport's governing body) to join the British Championship,' said clerk of the course Colin Pagan. 'We've been striving for this for years.' Based in Duns, the rally runs on July 2-4.

SEAT is recognised for its distinctive marketing strategies, and it plans to make a special effort in promoting the Jim Clark. 'I won't give details and spoil the surprise, but we're going to have a unique

and innovative marketing drive,' said a SEAT spokesman. 'If you think of the effort SEAT puts in on normal rallies, imagine what it will do on its own event.'

The rally will cover 170 stage miles, yet will never travel more than 15 miles from Duns. 'There's fantastic local support for the event,' said Pagan. 'A main factor in deciding whether to accept the MSA's invitation was the feelings of the local people, who are overwhelmingly in favour.'

SEAT and Jim Clark have been linked before when the Formula 1 champion won the SEAT Trophy at the 1967 Madrid Grand Prix.



Ford's Focus, the car that tempted Colin McRae away from Subaru for £6.3 million, is unveiled this week although the World Rally Car version won't be seen until October



News in Brief

**This weekend's Neste Finland Rally** marks a milestone in Ari Vatanen's career as it is his 100th World Championship rally start. The Finn will drive a Malcolm Wilson-prepared Ford Escort WRC for the third time this season. However, unlike Safari and Portugal, where he deputised for Bruno Thiry, he is not registered to score points for the official Ford team.

**Juha Kankkunen becomes** the second most experienced driver in the World Rally Championship when he starts the Neste Finland event. It will be his 124th event (including the non-championship 1000 Lakes event of 1995). Only his fellow Finn Markku Alen has a better record.

**Martin Brundle's hopes of driving** a factory Toyota Corolla WRC on November's Network Q RAC Rally could come closer to fruition within a few weeks. Toyota has set a mid-September target date for sorting the financial package required, while working on the logistics in the meantime. While it is hoped to include the former Formula 1 driver in its official factory squad, the quest for the World Championship may force Toyota to farm out the running of the car to one of its satellite teams, such as Grifone or Toyota Team Sweden.

**The New Zealand Rally organisers** are increasingly confident of persuading their government to help with the financial assistance needed to save it for future years. The recent running of the rally saw a much larger turn-out of fans than had been expected despite the appalling weather. This may have helped convince the authorities to put together a rescue package for the cash-strapped event.

**Citroen has ruled out plans** to enter the British Rally Championship in 1999. A Citroen spokeswoman said: 'The British Championship is not part of our plans for next year. We have had a lot of success outside of Britain, and do not feel that any further action is necessary here.' However, an assault on the British series has not been excluded for 2000 and beyond. Citroen's plans do not include Robbie Head, who is now looking elsewhere for a 1999 championship programme.

**Proton plans to rebuild** both the cars which were initially feared destroyed after the Ulster Rally. Jenny Davies's car has been straightened and rebuilt after a high-speed impact with a tree. Mats Andersson's car was gutted by fire, but the chassis was found to be salvageable. Both works Protons will enter the Cambrian Rally in North Wales on October 3 as preparation for the World Championship Network Q RAC Rally on November 22-24.

## Subaru backs McRae's push

Subaru has insisted that it has every intention of concluding its relationship with both Colin McRae and sponsor 555 as 1998 World Rally Champions. McRae's eight-year link with Subaru ends this season, as does BAT's six-year sponsorship of the rally team.

David Lapworth, motorsport director at Prodrive, from where the Subaru team is run, insisted last week that McRae's defection to



McRae: title hope

Ford for '99 (announced last week) would not affect the team's determination to win the title this season and that McRae was equally committed. 'Colin is our best points scorer,' said Lapworth. 'The best way we could win the title is by backing him all the way and that's what we will do.'

McRae currently sits three points adrift of series leader Carlos Sainz, with four events still to run in this season's title race. While this weekend's Neste Finland Rally is his toughest challenge, McRae has won all three remaining events in the past, a similar "three from four" win record to that of Sainz.

**Subaru fights on Page 64**



Pascal Hunt

## Peugeot will reveal drivers in november

Peugeot is planning to wait until early November before announcing its driver line-up for next season.

A team spokesman told us on Monday that detailed negotiations have been put on hold during the French holidays.

Recent rumour suggests that Francois Delecour has publicly claimed that he and Gilles Panizzi will be retained for the team's six-round programme with the new 206WRC. The team spokesman said he was expecting no surprises. 'Of course,' he added cryptically, 'that depends on what you are expecting us to say.'



DPP1

Peugeot is planning to keep its duo of 206WRC drivers a secret until early November

## Vauxhall plans WRC attack

Jarmo Kytölehto will continue to drive Vauxhall's Astra in the British Rally Championship next year, together with four world rounds, including the RAC Rally, and probably Sweden and Finland.

Vauxhall confirmed Kytölehto's contract has only a one-sided option, which it has taken up.

However, Kytölehto's long-time manager, Mika Sohlberg, interprets the Finn's contract differently: 'There is a gentleman's agreement in place between ourselves and Mike Nicholson (boss of Vauxhall Sport) that Jarmo can get out of his contract if he has an opportunity to

drive in the World Championship.'

Nicholson refused to elaborate on the subject, confining himself to saying, 'If certain conditions are met and suitable compensation arranged, we might agree to release Jarmo from his contract. I don't really believe in holding a driver to a contract against his will.'

Recent speculation has linked Kytölehto with Subaru, especially as the Finn is driving the second Impreza on this week's Neste Rally Finland. Subaru team manager David Lapworth said that Kytölehto joining the Prodrive-run team next year was 'not impossible'.

'We will be talking to many manufacturers after Finland,' insisted Sohlberg.

He ruled out the possibility that Kytölehto could contest next year's British series with Vauxhall while driving in selected WRC rounds for another manufacturer. 'That is very unlikely,' said Sohlberg.

Ray Mallock Limited, which will run two Astras for Vauxhall Sport next year, is to take at least one car to the foreign rounds and hopefully both. Speculation still surrounds the identity of the second driver, although Martin Rowe and Neil Wearden are still in the frame.



# AUTOSPORT

## SCHUMACHER'S MIDAS TOUCH

Can recall a time when pop songs had proper lyrics; when motorways, rather than sportsmen, cost £16 million; and when a "great" race meant the winner had overtaken another car.

Perhaps I'm just old-fashioned. After all, Sunday's Hungarian Grand Prix was - in the context of an era largely devoid of wheel-to-wheel combat - a thriller. It turned this season's title race on its head. In years to come, perhaps it should also be remembered as the scene of one of the sport's truly great drives.

Do I hear snorts of indignation?

Most people's imagination is fired by a swashbuckling fight through the field, like Ayrton Senna's at Donington Park in 1993, rather than the mathematical exercise upon which Sunday's suspense was based. Yet Michael Schumacher's awesome performance is surely no less deserving of elevation to Formula 1's pantheon.

Schumacher was racing the clock, as much as the McLarens, but the style with which he amassed an advantage sufficient to cover his extra pit stop left the impression that we had witnessed a conjuring trick. Tellingly, rivals found themselves scrapping not just for points but for superlatives.

Ross Brawn, the brains behind Ferrari's strategy, is rightly acknowledged as a master tactician. Maranello's technical director is the first to acknowledge that a game plan is only as good as its execution, however. In Schumacher, he has a star with the Midas touch.

With four races to run, the destiny of the crown is again uncertain. The German's brilliance is beyond doubt.

Editor **Mark Skewis**  
 Deputy editor **James Baker**  
 Managing editor **Stewart Williams**  
 Grand Prix editors **Nigel Roebuck**, **Andrew Benson**  
 International news editors **Gary Watkins**, **Marcus Simmons**  
 Rallies editor **Keith Oswin**  
 Club Autosport editor **Damon Smith**  
 Art editor **Ben Martin**  
 Chief sub-editor **John Leach**  
 Sub-editor **Euan Doig**  
 Editorial Manager **Laura Coppin**  
 Club Autosport assistant **Tim Scott**  
 Designer **Neil Epp**  
 Picture editor **Mike Weston**  
 Editorial assistant **Anthony Peacock**  
 Editorial secretary **Samantha Jempson**

National editor-at-large **Marcus Pye**  
 Grand Prix editor-at-large **Adam Cooper**  
 Editor-at-large **Bruce Jones**  
 Technical editor **Giorgio Piola**  
 American editor **Gordon Kirby**  
 Special Projects editor **Andy Halliwell**  
 Art editors **Peter Charles**, **Julia Gordon**  
 Designer **Liz Wallace**  
 Managing editor **Robin Shute**  
 Assistant editor **Simon Strang**  
 On-line editor **Toby Gurnton**  
 On-line assistant **Matt Pardo-Williams**  
 Photographers **LAT Photographic**  
 CORRESPONDENTS  
 International photo contributors  
**Sutton Images**  
 Argentina **Antonio Watson**  
 Australia **Bob Jennings**  
 Austria **Gerhard Kumschik**  
 Belgium **Dick Suter**  
 Brazil **Lito Cavalcanti**

Finland **Esa Moinen**  
 France **Daniel Ortelli**  
 Germany **Ian Brown**, **Rene de Boer**  
 Holland **Willem Staat**  
 Italy **Pino Allievi**, **Julian Thomas**  
 Japan **Iro Takahashi**  
 Mexico **Rosa Elena Torres**  
 South Africa **Colin Windell**  
 Spain **Raimon Duran**  
 USA **Jonathan Ingram**, **Jeremy Shaw**  
 UK **Bud Candler**, **Julian Carter**, **Allison Lock**, **Tim Baggs**, **Bill Henderson**, **Korry Dunlop**, **Peter Hughes**, **Paul Lawrence**, **Peter Scherer**, **Jerry Starman**, **Tim Whittington**, **Richard Wright**, **Richard Young**  
 Eire **Linda Keen**  
 Group Advertisement manager **Ian Havard**  
 Advertisement manager **Gordon Henderson**  
 Display sales executives **Garoth Mulley**, **Guy Barnes**, **Calum MacDougall**  
 Classified advertising **Ed Hole**, **Ben Watt**, **Giles Robinson**, **Tania Wakeford**, **Charlie Masters**

Autosport Directory **Rachel Burdekin**, **Sean Worrall**  
 Special Projects managers **Joe Wheeler**, **Julie Hamilton**  
 Subscriptions manager **Paul Shoemith**  
 Group Production Manager **Mourig Evans**  
 Production Manager **Darren Jones**  
 Design director **Paul Harpin**  
 Advertisement director **Derek Redfern**  
 Publisher **Jeremy Vaughan**  
 Sales director **John Chambers**  
 Publishing directors **Tony Schulz**, **Peter Foubister**

AUTOSPORT is published by Haymarket Specialist Motoring Ltd, a subsidiary of Haymarket Magazines Ltd, 38-42 Hampton Road, Teddington, Middlesex TW11 0JE. Editorial director: Mel Nichols, Managing Director: Eric Verdon-Roe, Chairman: Simon Taylor

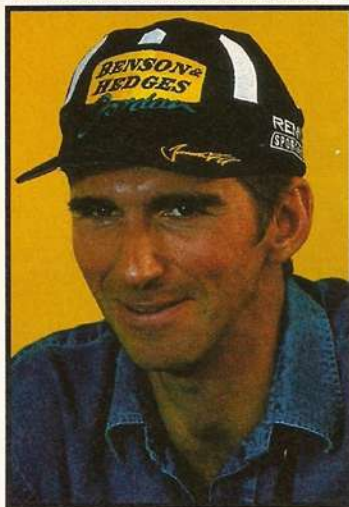

Give credit to Damon, but in proportion

### Jingoistic nonsense

Imagine my surprise when I tuned into ITV last Saturday to discover that the qualifying session for the Hungarian Grand Prix had been replaced with the 'Damon Hill Show'. Yes, Damon does race well at Hungary and, yes, he is a very good driver on that particular track and as a former World Champion he does deserve a mention, but Saturday's display from Messrs Rosenthal and Walker was laughable.

Please! We've put up with the adverts, Murray is just about bearable, but enough is enough. There are other drivers out there and although many people may find it difficult to believe, some of them are even better than our Damon.

I have been fortunate enough to see Formula 1 in three countries this year and while the television companies obviously pay attention to their compatriots, they have not lost track of the real reason they are there. So ITV, we watch F1 to see the best drivers and teams, not to be united under the same flag.

Please get back to the reason most of us watch F1, the cars and the drivers, not the 'Britain versus the world' competition ITV is trying to propagate.

**Peter Secci**  
London

### Tyred out

If Formula 1 front tyres get any wider, the teams may as well bolt on rears all round. That would be logistically easier for them, given that the cars today are beginning to look like the four-wheel-drive machines of the late 1960s.



Dario Franchitti finally delivered the race win he has been promising since his debut

More seriously, I was surprised to hear that experimental tyres with lateral grooves failed to cut lap times. If circumferential grooves have failed to cut lap times and lateral grooves have also failed, it begs the question of why slick tyres were needed in the first place. Perhaps tyre construction techniques have now overtaken the original idea of the slick tyre. As the presence of a treaded tyre has not seemed to degrade performance, wouldn't it now be more logical to have a single all-weather treaded tyre? It would be safer as well as cheaper, because the drivers would risk fewer accidents from wets overheating or slicks aquaplaning.

**Peter O'Donnell**  
Worcester Park

### Scot Free

I have just watched the latest CART Champ Car race live from Elkhart Lake where Dario Franchitti has, at last, taken the first win of his US racing career.

After threatening this feat ever since he first got into Carl Hogan's car last year, Dario has been a real star in the CART series, looking like winning on so many occasions, only to have bad luck befall him at the last minute.

I'm sure that now he has crossed this bridge it will open the way to regular visits to the top step of the podium, and with Craig Pollock managing Dario's career path, could we be seeing Dario next to Jacques in the next couple of seasons?

Now that really would be a Superteam. Well done, Dario!  
**Matt Winstone**  
Watford

### First to the Finnish

It was interesting to read Stephen Hendry's comments (AUTOSPORT July 30) which pointed out the disproportionate number of Scots in motor racing. Well, how about the tiny nation of Finns (only about five million in total)? They've not done badly. Perhaps they have even fewer traffic jams than they do in Scotland?

**Helmuth Gripenroth**  
Helsinki, Finland

### Weathering the storm

To the hundreds of race fans who were turned away from Knockhill last weekend we offer our sincere apologies, and to the thousands of you who came in droves, a big thank you for enduring some of the most gruelling weather we've seen for





years. Many of you stood for hours in torrential rain determined to support the event and enjoy some fantastic racing.

The operational and management side of the event was the most difficult we've endured for the past six years. The wettest July and August for 15 years had made the surrounding land completely waterlogged for several miles. In addition to that, the bad weather caused a stone bridge on one of our feeder roads to collapse, thus reducing us to just one access road. The constant rain compounded the gridlock situation and eventually we had nowhere left to park any vehicles. Both the BTCC and Knockhill thank you all for being so supportive and understanding.

**Derek Butcher**  
Knockhill

### Memories are made of this

I wish to thank the organisers of the Knockhill BTCC meeting for an experience which I shall never forget. An outstanding feature of the event was the unlimited access to the paddock. It allowed the spectator to meet the stars and

watch the cars being fine-tuned. I met Alain Menu, Derek Warwick and had my picture taken with a mobile phone-shod Jason Plato. It was a contrasting scene to the modern, high-security Formula 1 paddocks. I believe that all motor racing should go back to its roots

and reward the paying public with something to remember.

**Jonathan Crawford**  
Falkirk

### Thanks to Carlos

As Ford celebrates Colin McRae signing on the dotted line, their

memories seem to be incredibly short. Credit where credit is due. As the team fix their sights on future success with the former World Champion, let it not be forgotten that without the recent efforts of Carlos Sainz it would not have been in a position to vie for McRae's signature at all.

Sainz, almost single-handedly, pulled Ford from the doldrums and made them an outfit to be reckoned with once again. Only cruel luck in last November's API Rally Australia robbed him and the team of the opportunity to fight for the 1997 World titles.

While I wish the British alliance of Ford and McRae luck - Japanese manufacturers have dominated the series for too long - the Ford team, as it presently stands, have a lot to thank a certain Spaniard for.

**Melanie Richards**  
Essex

### Calling all Herbert fans

We are currently producing a new series of docu-dramas called *Without Warning* to be screened on BBC 1 TV during this October and November.

Made by BBC Bristol Features department, *Without Warning* tells remarkable tales of recovery.

One of the films we are making is Johnny Herbert's story. His crash at Brands Hatch in 1988, his recovery and his British Grand Prix win at Silverstone in 1995. Johnny as well as many other people involved in the story have agreed enthusiastically to take part.

I am very keen to hear from any of your readers who may have played a part in this story (it doesn't matter how small). I am also very keen to get any footage, be it film, video or stills of Johnny Herbert before or after his accident. We will pay for anything used.

I can be contacted on 01179 747526; fax: 01179 706036 or e-mail: ben.duncan@bbc.co.uk  
**Ben Duncan**  
BBC Bristol



Collins/Sutton

It wasn't just the drivers braving the elements when the BTCC gang poured into Knockhill

## What the papers say with Keith Oswin

I'm quite prepared to stand corrected if someone can put up a sufficiently strong argument against this, but I doubt that any team/driver combination than Michael Schumacher and Ferrari under Jean Todt could have pulled off that Hungarian Grand Prix result.

Throughout qualifying there seemed little hope that this would be anything other than a McLaren whitewash. Sunday's papers were a clear indication that the pit-lane hacks felt the same.

Even as the race began to unfold, there was little hint of what was to come, but one should never forget the tactical



excellence of the combination of German *wunderkind* and former rally co-driver 'Napoleon' Todt.

Oh boy, what a masterstroke in opting for three pit stops. It got Schumi ahead of Mika Hakkinen, and even without the McLaren going sick, few seemed to doubt that the battle was over.

Just to run it in that the Red Baron had just lopped nine points off Hakkinen's lead, the whole affair took place at what is as close to a Finnish GP as possible.

Of course, if McLaren wants to rain on Ferrari's parade in return, it could do no better than to give it a bloody nose at Spa, the scene of the Italian team's 600th GP. The Asti Spumante would go a bit flat should that happen.

While Schumacher had his hands full on the track, it seems that Damon's were otherwise occupied in the pits if Monday's *Daily Telegraph* had anything to do with it. Once again, Jordan brought Melinda Messenger

along to raise the spirits and underline any lingering Eastern Bloc opinions about the decadent West. It was a fnaar-fnaar piece worthy of inclusion in *The Sun* and even chucked in a reference to Haymarket's now defunct 'laddish' GPX for good measure. Still, the piece had a couple of outstanding points.

Sunday's *Sport First* continued to analyse why Colin McRae is worth £6 million to Ford. It might have been better wondering what happens to the transfer market now as the other drivers pitch their demands against McRae's target figure. At least 'Col' can now sit back and watch the fun.



Just  
**£39.99**  
plus p&p

# The Lotus Europa Special



The Lotus Europa, brainchild of Lotus founder Colin Chapman, was every bit as much an icon of the swinging sixties as George Best, Twiggy and the Kings Road.

But unlike flared trousers, platform heels and shoulder length perms, the Europa has stood the test of time and is today a genuine classic.

## THE EUROPA SPECIAL

It was, however, the early 1970s, 1972 to be precise that the ultimate and now most collectable version of the Europa was launched: the Europa Special.

With the big valve Lotus twin-cam engine, developing 126bhp at 6,500rpm and driving through a new 5 speed gearbox, the Special delivered performance which was really, well, special!

0 - 60mph in 6.6 seconds and a near 125mph top speed were highly creditable for the day, especially for a car costing less than £3,000!



## A NEW REPLICA

This new 1:18 scale die-cast metal replica, some 10" in length is a wonderful tribute to the Europa and a masterpiece of modern model engineering.

Handmade by perhaps the world's leading high quality die-cast manufacturer, the level of finish and detailing are quite amazing.

The paintwork alone goes through eleven stages of preparation. Take a look at the interior and the wood veneer dashboard. It's so real you would think you are looking at the real thing. The engine bay is similarly impressive.

Of course, the bonnet, boot and doors all open and as you would expect the steering wheel actually turns the front wheels.

There has never been a more accurate replica of the Lotus Europa and at just £39.99 owning one has never been easier.

## ORDERING YOUR EUROPA

The Lotus Europa replica is now in stock and can be despatched immediately without delay.

It is available in green only at this point in time but we are taking orders for this model in black and white both of which are expected to arrive in late September.



You can place your order by phoning the Orderline on 0171-616 1900 anytime between 9.00am and 8.00pm Monday to Friday or between 9.00am and 5.00pm on Saturdays.

Alternatively, you can fill in the form below and send it to us at GPL, PO Box 2989, London W10 6GH or fax it to us on 0171-727 8054.

You can pay by cheque, Postal Order, credit card or Switch.

But do not delay as we have received only a small allocation of cars and do not expect these to last long.



**☎ PRIORITY ORDERLINE 0171 616 1900 ☎**

Please complete the coupon and send it to GPL, PO Box 2989, LONDON W10 6GH or fax us on 0171 727 8054.

Please send me \_\_\_\_\_ (qty.) Lotus Europa Special in Green (MC1158 Available Now)

\_\_\_\_\_ (qty.) Lotus Europa Special in Black (MC1165)

\_\_\_\_\_ (qty.) Lotus Europa Special in White (MC1151)

P&P inclusive price per car in UK is £44.99. EC £49.99. Rest of World £54.99.

I will pay by Credit Card     I enclose a Cheque/PO, payable to 'Grand Prix Legends'

Card no:

Exp. end:       Switch Issue no:      We accept: Visa, Mastercard, Amex, Switch.

Signature: \_\_\_\_\_

Mr/Mrs/Ms: \_\_\_\_\_

Address: \_\_\_\_\_  
\_\_\_\_\_

Post Code:          Country: \_\_\_\_\_

Tel. (day): \_\_\_\_\_ **ASLE34**



# Formula 1 on autopilot



**NIGEL ROEBUCK**

**N**o doubting the pulling power of Ferrari, is there? After Michael Schumacher's victory in Hungary, we saw an eruption of lunacy from the crowds reminiscent of Montreal in 1995 – where Jean Alesi scored his first, and only, Grand Prix win for Maranello.

On Sunday, thousands climbed the fences as Schuey took the flag, so that by the time Damon Hill and Heinz-Harald Frentzen – battling for fourth place – arrived at the last corner, they found cretins all over the road. As in Canada, an FIA stewards' report has gone in; presumably, a sizeable fine – or worse – awaits the Hungarian organisers.

On the track, it was Ferrari's turn to defeat McLaren-Mercedes. Off it, too, the feud between them reached a new level of intensity. All weekend, the gentlemen in red were on the offensive, suggesting in effect that Ron Dennis should either put up or shut up.

This situation arose after the McLaren chief visited the Ferrari motorhome in Austria last month, and there suggested that his team felt that one aspect of the F300 – its braking system – did not comply with the regulations.

At the next race, Hockenheim, the Ferraris were so far from their usual pace that some were heard mischievously to murmur that Dennis's call on Jean Todt may have been the turning point of the season. Ron did not, in fact, protest, but merely suggested that, in certain circumstances, he might.

Last week, Todt said he wished Dennis would do it, because this would enable the air to be cleared. Then, in Thursday's FIA press conference, Schumacher said he had never used any illegal system on a racing car, and he was hurt by suggestions – particularly rife in 1994 – that he might have done.

Next day, at another FIA conference, Ross Brawn, who has worked with Schumacher at both Benetton and Ferrari, went somewhat further, describing Dennis's allegations as 'nasty and malicious'.

By the time of his press briefing, on Saturday afternoon, Ron was trying to dampen the flames. 'Ten or 15 years ago, there was a gentlemen's agreement that if you felt another team had something on its car that didn't comply with the regulations, then you discussed it with them; they could either agree with you, and do something about it, or be prepared to accept some form of official protest.'

Unfortunately, Dennis went on, that "gentlemen's agreement" had fallen into disuse. 'However,' he said, 'prior to the Brazilian GP, Luca di Montezemolo and I agreed that that would be the practice between our two teams.'

'Then they informed us at Interlagos that they were intending to protest our braking system; we at no stage ran that system throughout the

weekend, and then went through a process to determine whether it was, or was not, in accordance with the regulations. And you all know the outcome of that, which was contrary to the guidance we had previously received from the FIA.'

In Austria, the situation was reversed, with Dennis now informing Todt that McLaren was considering a protest against Ferrari's braking system. 'Anybody can rerun the tapes from the practice sessions in Austria,' he said on Saturday, 'and you can see that the wrong wheels are locking up into corners – it's not the unloaded wheel that's locking up, but the loaded one.'

'We believe that now there has been either an optimisation of the system – or something has changed – because now there's every reason to believe that the system is in accordance with the regulations.'

Dennis said he couldn't understand why Brawn had chosen to bring up the subject of traction control, as if that were the subject of his complaint against Ferrari. 'The only time traction control has come up in these meetings is when we've discussed a view – which is widely held – that it's extremely difficult, if not impossible, to police it. But it was braking systems, not traction control, that were the issue between myself and Todt.'

'As far as McLaren is concerned, the whole issue could have been dealt with quietly, behind closed doors; we didn't tell the media about it – Ferrari chose to do that. And we haven't discussed it in press conferences, either.'

A more worrying aspect of the weekend was the buzz that certain "gizmos", banned by the FIA at the end of 1993, might be permitted to return next year, for no other reason than they cannot be adequately policed.

There's always integrity, of course. Ha!

Schumacher put it this way: 'Unless you have guidelines about what you're allowed to do, and what not, you will always have engineers trying to get the best out of what you're allowed to do to develop something that gives you a little support. It may come out as something similar to traction control – but it is not traction control.'

Hmmm. Back to traction control again. 'At the end of the day,' Michael said, 'it would save

money, and make things more clear, if you just gave the freedom for that situation.' Make it legal, in other words, as it was five years ago.

If pressure mounts on the FIA to go this route, Max Mosley will be placed in a most difficult situation. One of the cornerstones of his presidency has been to keep to a minimum in Formula 1 what he calls "driver aids" – and what more effective "driver aid" could there be than the facility to put your foot to the floor out of a tight corner – even in the wet – in the sure knowledge that software will control the power going to the rear wheels?

Schumacher conceded that, while traction control (and other gizmos) took away 'certain skills', a superior driver would remain a superior driver. That goes without saying, but anything

which reduces the driver's contribution is surely to be deplored: it was not by chance, after all, that the two most opposed to traction control in 1993 were Ayrton Senna and Alain Prost.

'Throttle control,' Ayrton said, 'is supposed to be part of a racing driver's art. If computers do it for you, everyone is the same. In fact,' he added, 'even that is not true – because one team's computer could do it better than another's.'

Whenever the question of cheating is raised in F1, folk invariably get terribly holier-than-thou about it, which is a little ridiculous, frankly, for if it did not exist, there would be no need to worry about the FIA's "policing" abilities. Speak to people retired from the business, and they will happily regale you with cheating stories from 10 and 15 years ago.

The difference, of course, is that this is the electronic age. It wasn't too difficult to smell a rat when you watched four mechanics struggling to heft a new rear wing towards a car (in preparation for a post-qualifying weight check), but computers... ah, well, you can do anything with computers, can't you?

I can understand Ron Dennis's call for systems such as traction control to be legalised again. Such a move would certainly forestall a deal of paddock paranoia. As a simple racing fan, though, the return of the gizmos is the last thing I want to see, and I hope – and trust – that Mosley will stick to his original guns. ■

**“Rerun the tapes from Austria and you can see the wrong wheels are locking up”**

RON DENNIS



The crowd were so ecstatic over Schumacher's win they stormed the Hungaroring after only three cars had taken the flag



What's on...

...the track

**Fri Aug 21-Sun Aug 23**  
**Neste Rally Finland (SF)**  
 Round 10 of 13

**Sat Aug 22**  
**NASCAR Winston Cup**  
 Bristol (USA), round 23 of 33

**Sun Aug 23**  
**FIA GT Championship**  
 Suzuka (J), round six of 10  
**US Road Racing Championship**  
 Watkins Glen (USA), final round of five  
**British GT Championship**  
 Silverstone (GB), round seven of nine  
**SudAm Touring Car Championship**  
 Curitiba (BR), round seven of 12

...the box

**BBC 1**  
**Sun Aug 23** 1340-1435 BTCC highlights from Knockhill

**BBC2**  
**Mon Aug 24** 1455-1525 *Top Gear Motorsport*

**ITV**  
**Sat Aug 22** 1310-1415 *Meridian Motorsport* magazine

**EUROSPORT**  
**Thu Aug 20** 2300-0000 *Motors*  
**Fri Aug 21** 2230-2300 Highlights of Neste Rally Finland  
**Sat Aug 22** 0930-1000 Neste Rally Finland highlights  
 1000-1100 Truck Racing  
 2230-2300 Neste Rally Finland  
**Sun Aug 23** 0700-1000 FIA GT race from Suzuka, LIVE  
 1400-1530 FIA GT highlights  
 1800-1930 NASCAR highlights from Bristol (USA)  
 2230-2300 Finland Rally highlights  
**Mon Aug 24** 1100-1230 NASCAR 1645-1800 Stock Carracing from Paris-Bercy (F)  
 1800-1900 FIA GT highlights  
 2100-2200 Truck Racing  
**Tue Aug 25** 0800-0900 GT highlights  
 0000-0030 Rally highlights  
**Wed Aug 26** 1300-1430 *Speedworld* magazine  
 2300-0030 *Speedworld* (repeat)

**SKY SPORTS 1**  
**Thu Aug 20** 2215-2245 Formula 3  
**Mon Aug 24** 2330-0000 V-Max  
**Wed Aug 26** 2215-2245 *Full Throttle*

**SKY SPORTS 3**  
**Sat Aug 22** 1900-2200 *World Motorsport* magazine  
**Sun Aug 23** 1200-1230 Porsche Supercup from Silverstone  
 1730-1800 Drag Racing

**CEEFAX**  
 See page 360 for motorsport news

**INTERNET**  
 www.autosportmag.com

**AOL**  
 Keyword AUTOSPORT

Dumbreck, seen here on his way to victory at Sugo, has clinched the All-Japan F3 series title for TOM'S



Sekine/Sutton

# Where have all the 'young guns' gone?

**W**here are all the rising British stars? If you look down the Formula 3000 entry list this season, you will see one,

possibly two drivers who could be described as "young guns".

It's not that there is none. You just have to look a bit farther afield. You are more likely to find the next British Formula 1 star in Japanese Formula 3 or on an Indy Lights grid than in a home-grown series.

So what is the reason for the Brits shunning the traditional route to the top of the motorsport tree?

Traditionally, winning the British F3 title guaranteed a driver's step into F3000. In recent years, this has not been the case. Britons Kelvin Burt, Ralph Firman Jr, Oliver Gavin and Jonny Kane all did everything that could be asked of them in the category, but still couldn't manage a full season of F3000.

Money is a big factor. The rising challenge of the Renault-backed Promatecme team in British F3 cost Scot Peter Dumbreck his Paul Stewart Racing seat as the team was forced to take paying drivers to keep pace with development.

Dumbreck and Volvo touring car driver Kelvin Burt ended up in Japan after being offered free drives. British Grand Prix F3 support race winner Darren Manning is now also racing in the land of the rising sun without forking out a bean.

It's not that they want to race in foreign championships, but the Japanese are much more likely to offer a free ride to a talented driver to win races. Manning's manager, Mike O'Brien, explains it perfectly.

Inside line



**JAMES BAKER**  
 DEPUTY EDITOR

'The team sets you up with a telephone, a flat, a car and lets you keep the prize money, which is quite substantial. They take away the constant pressure to search for sponsorship and that can only be good for a driver,' says O'Brien.

Since the likes of Johnny Herbert were lured out there in 1990, the Japanese option has been well established as an alternative route back into F1 for drivers with no money. The free drives and vast salaries (now a thing of the past) could explain that exodus.

Far more worrying is the talent drain to America, which is only a recent phenomenon.

Guy Smith's reason for heading to Indy Lights this year was not financial (he had the budget for a

full season of F3000), but career advancement. As he says, 'I looked at F3000, but getting into F1, even if you win the title, just would not happen without taking £3-4 million to a team. Getting into Champ Cars is a more realistic goal.' So it has proved, as the Yorkshireman currently sits second in the Indy Lights series, behind fellow British F3 refugee Cristiano da Matta.

The trickle to the US may become a torrent in the near future. Especially with high prize money and the previously disjointed American racing scene now having a clear progression structure.

So what can be done? The Japanese championship rewards talent with free drives, while the American series gives a real possibility to progress to its premier category. Why can't that happen in Europe?

With F3000 now once again a series with real potential, we are all saddened that more of our young stars are not able to fight with the best in the world to get to F1.

Some suggest that the influx of F1 teams to F3000 will bring with them a bevy of free drives. Outside the West Competition team, that is looking unlikely. Drivers just have to find their own way.

While Britain has one of the strongest national racing scenes in the world, it is also one of the worst for supporting its local talent. We have to accept that. It's a culture that's not going to change, certainly not in the near future.

The point is, instead of moaning about them not being in F3000, we should be applauding them for finding any route to the top. ■



## Armchair enthusiast

**The Touring Car Drivers' Supporters' Club**, organised by Club 89. **Membership price £20.00 for AUTOSPORT readers**

Get a life. Your bog-standard road saloon is not a touring car, and your feeble attempts to bounce it off speed humps do not make you Frank Biela. However, until recently, these kerb-hopping activities were the only form of release available to frustrated tin-top fanatics. Now there is a simpler (not to mention legal) solution.

Step forward the Touring Car Drivers' Supporters' Club. It's administered by those brave men from Club 89, who use British Touring Car Championship drivers as instructors. Activities the club partakes of include high-speed laps

of the track sitting alongside a touring car driver, karting events and visits to test days. The TCDCS is designed to allow fans to get closer to their preferred environment. For £20 AUTOSPORT readers can buy membership up until the end of December, 1999. For that you get to meet the drivers, experience some hot laps and receive a regular newsletter. There are also opportunities to save money on a range of team clothing.

A number of visits has been planned to test days and to some of the BTCC teams' headquarters.

We're told that the next visit will be to Audi Sport UK in September, and there are more planned.

For further information contact Peter Coleman on 01953 456789. This year is gearing up to be one of the most exciting finales in the BTCC's history, so this is a great chance to grab a slice of the action for yourself.

● Anthony Peacock



Have the ride of your life with a BTCC driver

## Anniversaries



Wilson: 24

- Aug 20:** Pat Bedard (born 1941), Eric Cheli (b 1966), Richard Evans (b 1970), Alfred Neubauer (died 1980)
- Aug 21:** Ettore Bugatti (d August 21, 1947), Gene Force (d 1983), Stefan Gopel (b 1965), Thomas Wagenstetter (b 1973)
- Aug 22:** Peter Collins (b 1950), Mike Mills (b 1970), Soames Langton (b 1967), Ian Scheckter (b 1947), Max Wilson (b 1974)
- Aug 23:** Patrick Huisman (b 1966), Didier Pironi (d 1987)
- Aug 24:** Eric Bernard (b 1964), Vincenzo Lancia (b 1881, d February 15, 1937),

Achim Strauss (b 1961)

**Aug 25:** Jean-Luc Chereau (b 1948), Michel Jourdain (b 1947), Henri Toivonen (b 1956, d May 2, 1986)

**Aug 26:** Oreste Berta (b 1938), Alex Burgstaller (b 1969), Dominique Dupuy (b 1957), Sepp Haider (b 1953), Swede Savage (b 1946, d July 2, 1973)



Bernard: 34

## Then as now

### 10 YEARS AGO

Johnny Herbert was seriously injured in a Brands Hatch Formula 3000 crash – he still feels the effects today (AUTOSPORT, August 25, 1988). Michel Trolle had already been hurt in a practice shunt. In the race, there was a multi-car pile-up when Herbert and Gregor Foitek collided. Just six cars took the restart, with Martin Donnelly claiming a hollow victory from Pierluigi Martini.

The GM Lotus Euroseries support event was an altogether more successful affair. Allan McNish won by six-tenths of a second from his team mate – one Mika Hakkinen.



Carnage at Brands in the F3000 race

### 20 YEARS AGO

Hannu Mikkola and Russell Brookes won the Burmah International Rally with the first (and only) dead heat in British stage rallying (AUTOSPORT, August 24, 1978). It had to come down to a tie-break, which Mikkola took by virtue of his quicker time over the final stage. Brookes held a fairly comfortable lead going into it, but the steering rack jammed after an engine mounting broke on his Escort, giving the advantage to the similar car of Mikkola. The legendary Roger Clark was third, while Brian Culcheth clinched the G1 title in his Opel Kadett.

Juan Manuel Fangio announced he would race his old Mercedes W196 in a historic event supporting the Australian Grand Prix, while Barry Sheene said he would swap two wheels for four to contest the Aurora AFX Formula 1 series.

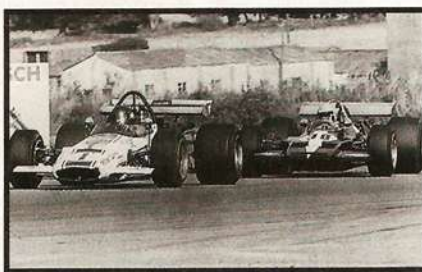

The new Formula 5000 was launched to the press

### 30 YEARS AGO

We announced the launch of a new category: Formula 5000 (AUTOSPORT, August 16, 1968). The rules were for single-seaters with pure racing engines up to two litres, or stock block units of up to five litres capacity.

David Piper took his Ferrari P3/4 to another victory, this time at the Swedish Grand Prix for Sports Cars at Karlskoga,

where he narrowly beat Jo Bonnier in the new McLaren M6B. The supporting Formula 3 race was won by Reine Wissell. Gijs van Lennep finished 11th in the DAF car, which sported the Variomatic transmission system.

### 40 YEARS AGO

The United States figured prominently in our issue, with the news that the building of the Scarab Sports Racing Car by Reventflow Automobiles Inc might open the way for Formula 1 racing to officially make its way from Europe to the USA for the first time (AUTOSPORT, August 22, 1958). The Indy people had already "crossed the pond" to contest the Monza 500 and the possibility of a reciprocal agreement with F1 seemed to be on the cards. We also carried details of the first American International Rally – to be run in November. There were to be eight start venues, with crews facing a 3200-mile route before the finish in Los Angeles.

We also previewed the Oporto Grand Prix, Portugal's first genuine GP on the twisty 4.6-mile circuit. The entry list was excellent in theory, but it was doubtful that all the contenders would make it there on time.

## From the archives... This isn't what we meant when we said Gerhard Berger needed to get his skates on!





## HUNGARIAN GRAND PRIX

A charging Michael Schumacher took full advantage of Ferrari's superior race strategy to head home his World Championship rivals in Hungary



# Schumacher pit-stop s





# Strategy sinks McLaren

*Ferrari's three-stop pit ploy brought its number one driver victory in Hungary, while a hobbled Hakkinen could only scrape home sixth. By Nigel Roebuck*





The McLarens of Hakkinen and Coulthard lead the Ferraris of Schumacher and Irvine, with Hill and the pack in hot pursuit at the start of the Hungarian Grand Prix

**Y**ou dream of the ideal result,' said Michael Schumacher on Sunday afternoon, 'and this is it. Before the race, I'd hoped I might win, with Mika second, but this is unbelievable. I think now we have a very good chance in the World Championship.'

Schumacher had every reason to be exhilarated after the Hungarian Grand Prix. While a virtuoso drive brought him victory, Hakkinen, the championship leader from the first GP on, scraped but a single point. The Finn's McLaren-Mercedes, after starting from the pole and leading more than half the race, was hobbled by a mysterious handling problem and slid down the order.

Ferrari, emphatically back from the dead (after an abysmal performance at Hockenheim), won by virtue not only of its number one driver's skills but also of a superior strategy. 'We could have gone for either two or three stops,' said Schumacher, 'and Ross Brawn (Ferrari's technical director) decided to go for three. At the time, I was worried about it, but it turned out to be the right choice.'

So it was - but, for success, it

depended on the German being able to run for a long time at an extraordinary pace, so as to build up enough of a lead to permit the third stop. 'For me it was like a qualifying race,' he said.

The McLarens, which stopped only twice, ran one-two for the first 44 laps. They looked like winning again, albeit narrowly, but Ferrari's revised strategy allowed Schumacher to get ahead of Hakkinen and David Coulthard at the second stops. When the Finn eventually began to fall back, the issue was settled.

'We had a problem today,' said McLaren boss Ron Dennis crisply, 'and whenever we have a problem, Michael's there, ready to pounce.'

No disputing that. He was aided by having the right tyres for the job. Twelve months ago, Bridgestone had the upper hand in Hungary, but this time Goodyears were the thing to have. Although Coulthard finished second, he was never able to threaten Schumacher, and admitted he was all out of grip.

Third was Jacques Villeneuve, and a great third it was - the World Champion lost his power steering



The race over, Schumacher is quick to acknowledge his team's contribution to the win



Sutton

Alex Wurz makes a very public retirement

after 10 of the 77 laps, and the Hungaroring is a tiring place. The Williams couldn't frighten Ferrari or McLaren, but the Canadian was pleased by its balance and grip at a track where his expectations had not been high.

Fourth and fifth, ahead of the unfortunate Hakkinen, were Damon Hill, thereabouts for Jordan-Mugen Honda all weekend, and Heinz-Harald Frentzen, who was weakened by a bout of gastric flu. The Williams man deserved some kind of gallantry award simply for finishing what was a long, hot race.





There were worries over reliability at Ferrari, when Irvine went out after only 13 laps

the opening corner, it was Hakkinen, Coulthard, Schumacher, Irvine, Hill and Villeneuve. This being the Hungaroring, where overtaking is an endangered species, that was also the order at the end of the opening lap.

It was to stay that way for some considerable time. Actually, that's not strictly true: on lap five, Shinji Nakano and Tora Takagi passed Esteban Tuero.

That apart, there was no movement whatever until lap 13, when Irvine brought his Ferrari into the pits - too early, one thought, for routine service, and so it proved. The Irishman was clearly in no hurry. His car was immediately pushed into its garage, its gearbox short of fourth and fifth. Astonishingly, it was his first mechanical failure of the year, and only the second Ferrari has suffered all season long (the first being Schumacher's engine breakdown at the opening round in Melbourne).



The track invasion left Takagi stranded

apart, and Schumacher continued to keep a close watching brief.

From the outset it had been clear that this was to be another contest exclusively between McLaren-Mercedes and Ferrari; after 15 laps, Hill, running fourth, was 14 seconds behind Schumacher and consistently dropping virtually a second a lap to him.

Nor were the McLarens stroking. 'The early part of the race was fine for me,' Hakkinen said. 'I had David in my mirrors all the time, so I was driving more or less flat out, but I felt quite comfortable about that. Then I decided to push even harder, as my first stop was approaching, and I built up a small gap.'

The significant pit stops began with Hill, who was running the softer Goodyears, and came in on lap 24. Next time round, it was the turn of Schumacher, then Coulthard (on lap 26), and finally Hakkinen, two laps after that. No significant problems were encountered by any of them. However, while the McLaren pair duly kept their first and second places, Schumacher came out behind Villeneuve's Williams, which was not to pit until lap 31.

'We'd gone into the race with the possibility of making either two or three stops,' Schumacher said, 'and when Ross (Brawn) decided to

Schumacher may not have been able to threaten the McLaren drivers for pole position, but he saw no reason why he couldn't run with them in the GP. 'I'm sure,' he said, 'that we'll be better in the race than in qualifying.' He had good grounds for thinking that way: Ferrari's tyre choice was the harder of the Goodyear compounds on offer, whereas McLaren had gone for the softer of the Bridgestones.

In the warm-up, Hakkinen and Coulthard duly duplicated their qualifying performances, with the courageous Frentzen third, then the Schumachers (Michael ahead of Ralf), Villeneuve, Hill, Eddie Irvine, Giancarlo Fisichella and Johnny Herbert. Seven of the top 10 cars were on Goodyears.

The McLaren boys were happy enough, however, and had a trouble-free session. Hakkinen admitted to a touch of understeer. He said it could have been dialled out, but he preferred to live with it, so as to preclude any possibility of tyre-destroying oversteer in the early part of the event.

If anyone had cause to worry before the race, it was the unfortunate Frentzen, who said he

felt a little better than in practice, but was still seriously debilitated, having eaten nothing for two days. He would take the start, it was decided, but there were doubts that he would be able to make it through to the end.

There had been predictions that it might rain, but there was no sign of any such thing as the cars went to the grid. In fact, it would stay dry, hot and sticky all afternoon.

The grid at the Hungaroring has always been problematical for those with even-numbered qualifying slots. They start on the right, where the cars rarely run, and thus the surface there is dusty, which is not what you need for good traction when the lights go out.

The suspicion had been that Schumacher, starting third, directly behind poleman Hakkinen, would be able to get the better of Coulthard on the sprint down to the first turn. In fact, the Ferrari driver made a very middling start, not only failing to pass DC, but coming close to losing places.

This was bad news for Hill, who got away well, then had to back off for the German, which, in turn, allowed Irvine to get by him. Into

**“ Whenever we have a problem, Michael is there, ready to pounce ”**

RON DENNIS

At the time his problem struck, Irvine had been running fourth, and actually gaining slightly on his team leader, who was now left to fight the two McLarens on his own.

Not that Schumacher was showing signs of panic, mind you. If we had expected, from their qualifying and warm-up performances, that Hakkinen and Coulthard would ultimately ease away from the rest, such was not the case. After 10 laps, the Finn had led the Scot by three seconds, with the lead Ferrari a second or so further back. Fifteen laps in, and the McLarens were only two seconds



Hill had a relatively trouble-free run to record his second fourth place in a row







time before his crew was able to understand what he was saying.

After four frustrating laps behind his team mate, Coulthard finally went past, but by now the Ferrari was 14 seconds up the road, and apparently beyond reach. 'Michael had a lot less fuel,' DC explained, 'and I simply couldn't stay with his pace.' It didn't help that the Scot's car was not handling as it should, one of the rear tyres on his final set being incorrectly pressured.

Schumacher, of course, knew nothing of these dramas at the time. Indeed, he did not even know he was in the lead! 'On lap 52,' he said, 'I went off the road at the last corner, simply because I was pushing so hard.' The Ferrari got sideways, and slithered briefly off, then rejoined without problem.

The German made his third, and final, stop on lap 62, coming in with a lead of 29 seconds - rather more than he needed. Prior to pitting, he put in an amazing sequence of four sub-1m20s laps. On his way again after just 7.7 seconds stationary, he

now led Coulthard by five. Given the latter's predicament, he swiftly extended this by a couple of seconds a lap or so.

For Hakkinen the closing stages were heartbreaking. As his car became progressively more difficult to drive, so he fell into the successive clutches of Villeneuve, Hill and Frentzen. By the end of the race he was glad to come away with a point.

Hill, fourth for the second time in a fortnight, maintained Jordan's recently-acquired points-scoring habit, and was pleased with his day. The Williams folk had every reason to applaud Villeneuve for a fighting drive (without power steering, remember) and the tormented Frentzen for simply taking part in the race, never mind scoring.

Four races to go, seven points only between Hakkinen and Schumacher, Spa the next port of call. 'I love Spa,' Michael said. 'It's near where I was born, and I think of it as my home circuit.' He has won there four times already. ■



# BRUNDLE'S Talking Point

Hungary provided another memorable moment in Formula 1 history

I was looking forward to the race because the Hungaroring usually throws up an unpredictable result. I was actually thinking of the scrap for 'best of the rest' rather than the fight for the lead, but we had a double measure on Sunday, thanks to that incredible performance from Michael Schumacher.

Once again, here was proof that boring tracks can make for great races. Everyone criticises the Hungaroring for being slow and too tight. The fact is the drivers like the circuit. It's quite a thrill pushing a car around there.

It's hard work, though. In so many places, the exit of one corner is the approach to the next. There's no respite and that's what makes it tough. The corners keep coming at you and there is a very small margin for error. As soon as you are off the racing line, the track is grey and completely unforgiving - as both

to get his car onto the second row. Every lap was a new adventure and to be three-tenths off pole was very impressive. It was difficult to believe that he could keep that up for 77 laps, particularly with the McLarens looking so good.

In fact, it seemed to me that the Ferrari team leader, instead of thinking about attacking Hakkinen and Coulthard, would be looking over his shoulder at Damon Hill's Jordan and Jacques Villeneuve's Williams. Goodyear has been doing a very good job of late and the benefits of that would be seen in the race, when Bridgestone was somehow pushed onto the back foot.

We know Schumacher and Ferrari made some changes overnight and they seemed to work - certainly during the later stages of the race. The team's success was also due to a very clever strategy, even though I didn't think it was going to work



The pit-stop pay-off: the Prancing Horse's number one takes his fifth win of the year



Ross Brawn's strategic genius was at the heart of a brilliant Ferrari performance

Schumacher and Mika Hakkinen were to prove in the race.

I drove eight Grands Prix in Hungary and it always amazed me how slow the race was; how little grip you always seemed to have. You could never believe the lap times you were doing in the race compared to the warm-up. It does throw up some interesting drives and Schumacher's was no exception.

Austria seemed to show that McLaren hadn't actually lost its advantage. It had somehow got it all wrong for a couple of races; stood on its own tail thanks to problems with reliability, the refuelling rig and various incidents; and you began to convince yourself that Ferrari had closed the gap. Then the pendulum swung the other way. Now Ferrari seemed to lose momentum.

That looked like being the way of it after qualifying on Saturday, as Schumacher performed acrobatics

initially. The traffic didn't go Schumacher's way and he got tucked up behind Villeneuve. His first call in the pits made it look like he was two-stopping. Ultimately, he went for three, which was the really smart move.

There is no doubt that Ferrari will feel it won the race, and McLaren will feel it lost it, partly because of the decisions the teams took during the race. Certainly some of McLaren's decisions were reactions to what Ferrari was doing rather than concentrating on its own game plan.

Whatever the cause of this result, the effect has been to open up the championship and make sure it runs for at least another two rounds. The next event is Belgium. Schumacher really likes Spa and the McLaren will be tidy there, too. But, as Sunday showed, you can't make confident predictions. Not even when the race has reached the halfway mark.

## Hungaroring

57	58	59	60	61	62	63	64	65	66	67	68	69	70	71	72	73	74	75	76	77
3	3	3	3	3	3	3	3	3	3	3	3	3	3	3	3	3	3	3	3	3
7	7	7	7	7	7	7	7	7	7	7	7	7	7	7	7	7	7	7	7	7
8	8	8	8	8	8	8	8	8	8	1	1	1	1	1	1	1	1	1	1	1
1	1	1	1	1	1	1	1	1	1	8	8	8	8	9	9	9	9	9	9	9
9	9	9	9	9	9	9	9	9	9	9	9	9	9	2	2	2	2	2	2	2
2	2	2	2	2	2	2	2	2	2	2	2	2	2	8	8	8	8	8	8	8
6	6	6	6	6	6	6	6	6	6	6	6	6	6	14	14	14	14	14	14	14
14	14	14	14	14	14	14	14	14	14	14	14	14	14	5	5	5	5	5	5	5
5	5	5	5	5	5	5	5	5	5	5	5	5	5	15	15	15	15	15	15	15
15	15	15	15	15	15	15	15	15	15	15	15	15	15	10	10	10	10	10	10	10
10	10	10	10	10	10	10	10	10	10	10	10	10	10	16	16	16	16	16	16	16
16	16	16	16	16	16	16	16	16	16	16	16	16	16	11	11	11	11	11	11	11
19	19	19	11	11	11	11	11	11	11	11	11	11	11	19	19	19	19	19	19	19
11	11	11	19	19	19	19	19	19	19	19	19	19	19	21	21	21	21	21	21	21
21	21	21	21	21	21	21	21	21	21	21	21	21	21	22	22	22	22	22	22	22
22	22	22	22	22	22	22	22	22	22	22	22	22	22	22	22	22	22	22	22	22



Jump jockey: Michael Schumacher celebrates another top-step Sunday with his customary leap

John Marsh/Empics

Eric/lat



# HUNGARIAN GRAND PRIX

## '98 so far...

### TEAM QUALIFYING

8	Villeneuve	Frentzen	4
11	M Schumacher	Irvine	1
8	Fisichella	Wurz	4
3	Coulthard	Hakkinen	9
5	Hill	R Schumacher	7
5	Panis	Trulli	7
7	Alesi	Herbert	5
4	Diniz	Salo	8
7	Barrichello	Magnussen	0
4	Barrichello	Verstappen	1
1	Rosset	Takagi	11
7	Nakano	Tuero	5

### SUPERGRID

Pos	Driver	Average
1	Hakkinen	1.50
2	Coulthard	3.00
3	M Schumacher	3.50
4	Irvine	5.92
5	Fisichella	6.75
6	Villeneuve	7.00
7	Frentzen	7.17
8	Wurz	8.75
9	Hill	9.00
10	R Schumacher	9.42
11	Alesi	10.58
12	Herbert	11.42
13	Barrichello	13.00
14	Trulli	14.25
15	Salo	14.75
16	Panis	15.58
17	Verstappen	15.60
18	Diniz	16.33
19	Takagi	17.06
20	Magnussen	18.71
21	Tuero	19.75
21	Nakano	19.75
23	Rosset	21.08

### TYRE WAR

	Bridgestone	Goodyear
Wins	7	5
Poles	12	0
Points	166	145
Laps led	605	193
Fastest laps	8	4

### FIRST LAP POSITION

Driver	gained/lost season
Coulthard	0
Hakkinen	0
Fisichella	-2
M Schumacher	+2
Frentzen	+1
Wurz	+1
Irvine	+1
Salo	+1
Herbert	+1
Trulli	+1
Alesi	+2
Diniz	+1
Villeneuve	0
Barrichello	-2
Hill	-1
R Schumacher	-3
Magnussen	0
Panis	-1
Nakano	0
Rosset	0
Takagi	-2
Tuero	+3
Verstappen	0

### DRIVER STATS

Driver	laps led/completed
Villeneuve	0/769
Frentzen	0/574
M Schumacher	192/745
Irvine	1/697
Fisichella	24/643
Wurz	0/707
Coulthard	111/664
Hakkinen	472/685
Hill	0/644
R Schumacher	0/510
Panis	0/616
Trulli	0/500
Alesi	0/645
Herbert	0/621
Diniz	0/417
Salo	0/395
Barrichello	0/467
Verstappen	0/256
Rosset	0/376
Takagi	0/503
Nakano	0/617
Tuero	0/461
Magnussen	0/257



At the lights, Schumacher had a very ordinary start nearly losing third and blocking in Hill, who dropped behind Irvine as a result



Villeneuve savours his second podium finish in a row with a champagne shower for the assembled throng



Elford/LAT

Hungary was a race lost in the pits for McLaren. Coulthard (above) lost out to Schumacher on his second stop; Hakkinen was bumped from the lead in similar circumstances

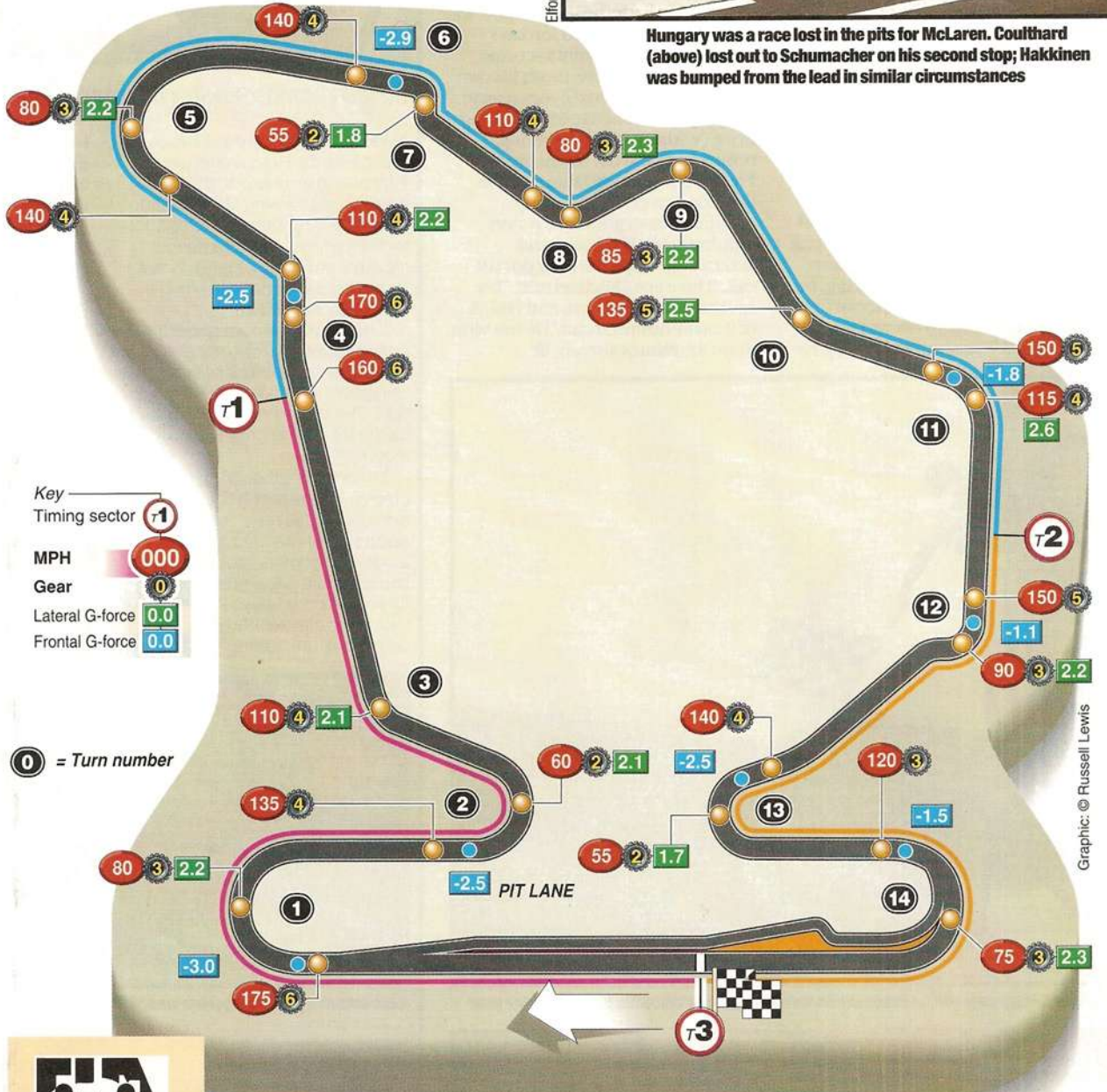

Graphic: © Russell Lewis



© 1998 Federation Internationale de l'Automobile, 8 Place de la Concorde, Paris 75008 France



## START GRID

23: Tuero 1:21.725	22: Nakano 1:20.635	19: Verstappen 1:20.198	15: Herbert 1:19.878	17: Salo 1:19.712	14: Ales
11: Panis 1:20.663	21: Takagi 1:20.354	12: Trulli 1:20.042	18: Barrichello 1:19.876	16: Diniz 1:19.876	
20: Rosset DNQ					



# Hungarian GP

Round 12, Hungaroring, August 16, 1998

Lap distance: 2.466 miles. Lap record: Nigel Mansell - Williams FW14B, 1992, 1m18.308s @ 113.349mph  
Weather: Hot, cloudy and bright



## Title chase

DRIVERS	
1 Hakkinen	77
2 M Schumacher	70
3 Coulthard	48
4 Irvine	32
5 Villeneuve	20
6 Wurz	17
7 Fisichella	15
8 Frentzen	10
9 Hill	6
10 Barrichello/R Schumacher	4
12 Alesi/Salo	3
14 Herbert/Diniz/Magnussen	1

CONSTRUCTORS	
1 McLaren-Mercedes	125
2 Ferrari	102
3 Benetton-Playlife	32
4 Williams-Mecachrome	30
5 Jordan-Mugen Honda	10
6 Stewart-Ford	5
7 Arrows/Sauber-Petronas	4

TOTAL WINS	DRIVER	CAREER	1998
M Schumacher	32	5	
Hill	21		
Villeneuve	11		
Hakkinen	7	6	
Coulthard	4	1	
Herbert	2		
Alesi	1		
Frentzen	1		
Panis	1		

TOTAL POLES	DRIVER	CAREER	1998
Hill	20		
M Schumacher	17		
Villeneuve	13		
Hakkinen	9	8	
Coulthard	8	3	
Alesi	2		
Barrichello	1		
Frentzen	1		
Fisichella	1	1	

FASTEST LAPS	DRIVER	CAREER	1998
M Schumacher	32	4	
Hill	19		
Villeneuve	9		
Frentzen	6		
Coulthard	8	4	
Hakkinen	5	4	
Alesi	4		

## Results

POS	DRIVER	CAR	TYRES	LAPS	TIME/REASON	MPH
1	Michael Schumacher (D)	Ferrari	Goodyear	77	1:45:25.550	108.162
2	David Coulthard (GB)	McLaren-Mercedes	Bridgestone	77	1:45:34.983	108.001
3	Jacques Villeneuve (CDN)	Williams-Mecachrome	Goodyear	77	1:46:09.994	107.407
4	Damon Hill (GB)	Jordan-Mugen Honda	Goodyear	77	1:46:20.626	107.228
5	Heinz-Harald Frentzen (D)	Williams-Mecachrome	Goodyear	77	1:46:22.060	107.204
6	Mika Hakkinen (SF)	McLaren-Mercedes	Bridgestone	76	1:45:29.932	106.683
7	Jean Alesi (F)	Sauber-Petronas	Goodyear	76	1:45:41.961	106.481
8	Giancarlo Fisichella (I)	Benetton-Playlife	Bridgestone	76	1:45:56.357	106.240
9	Ralf Schumacher (D)	Jordan-Mugen Honda	Goodyear	76	1:46:15.311	105.924
10	Johnny Herbert (GB)	Sauber-Petronas	Goodyear	76	1:46:20.059	105.845
11	Pedro Diniz (BR)	Arrows	Bridgestone	74	1:45:27.272	103.919
12	Olivier Panis (F)	Prost-Peugeot	Bridgestone	74	1:45:29.999	103.868
13	Jos Verstappen (NL)	Stewart-Ford	Bridgestone	74	1:45:53.909	103.484
14	Torosuke Takagi (J)	Tyrrell-Ford	Goodyear	74	1:46:08.141	103.252
15	Shinji Nakano (J)	Minardi-Ford	Bridgestone	74	1:47:45.727	101.694
16	Alexander Wurz (AUT)	Benetton-Playlife	Bridgestone	69	DNF/Gearbox	106.387
R	Rubens Barrichello (BR)	Stewart-Ford	Bridgestone	54	Gearbox	103.221
R	Jarno Trulli (I)	Prost-Peugeot	Bridgestone	28	Engine	103.613
R	Mika Salo (SF)	Arrows	Bridgestone	18	Gearbox	103.187
R	Eddie Irvine (GB)	Ferrari	Goodyear	13	Gearbox	106.891
R	Esteban Tuero (RA)	Minardi-Ford	Bridgestone	13	Engine	101.466
DNQ	Ricardo Rosset (BR)	Tyrrell-Ford	Goodyear			

Fastest pit stop 28.938s, Michael Schumacher

## Fastest laps

### SECOND TIMED - HOT, SUNNY

1 Hakkinen	1:17.337
2 Coulthard	1:17.495
3 M Schumacher	1:18.588
4 Fisichella	1:18.792
5 Villeneuve	1:19.016
6 Hill	1:19.091
7 Frentzen	1:19.107
8 R Schumacher	1:19.183
9 Irvine	1:19.252
10 Wurz	1:19.286
11 Alesi	1:19.449
12 Herbert	1:19.800
13 Barrichello	1:19.936
14 Salo	1:20.552
15 Diniz	1:20.589
16 Verstappen	1:20.883
17 Panis	1:20.920
18 Nakano	1:21.373
19 Trulli	1:21.585
20 Takagi	1:21.634
21 Tuero	1:22.008
22 Rosset	1:23.279

### QUALIFYING - HOT, SUNNY

1 Hakkinen	1:16.973
2 Coulthard	1:17.131
3 M Schumacher	1:17.366
4 Hill	1:18.214
5 Irvine	1:18.325
6 Villeneuve	1:18.337
7 Frentzen	1:19.029
8 Fisichella	1:19.050
9 Wurz	1:19.063
10 R Schumacher	1:19.171
11 Alesi	1:19.210
12 Diniz	1:19.706
13 Salo	1:19.712
14 Barrichello	1:19.876
15 Herbert	1:19.878
16 Trulli	1:20.042
17 Verstappen	1:20.918
18 Takagi	1:20.354
19 Nakano	1:20.635
20 Panis	1:20.663
21 Tuero	1:21.725
DNQ Rosset	1:23.140

### WARM UP - WARM, SUNNY

1 Hakkinen	1:18.694
2 Coulthard	1:19.555
3 Frentzen	1:19.967
4 M Schumacher	1:20.325
5 R Schumacher	1:20.385
6 Villeneuve	1:20.580
7 Hill	1:20.906
8 Irvine	1:20.935
9 Fisichella	1:21.334
10 Herbert	1:21.441
11 Alesi	1:21.799
12 Trulli	1:21.920
13 Wurz	1:21.924
14 Barrichello	1:22.095
15 Salo	1:22.119
16 Panis	1:22.344
17 Takagi	1:22.704
18 Verstappen	1:22.961
19 Nakano	1:22.991
20 Diniz	1:23.231
21 Tuero	1:23.685

### RACE - HOT, CLOUDY, BRIGHT

1 M Schumacher	1:19.286
2 Villeneuve	1:20.078
3 Frentzen	1:20.356
4 Hakkinen	1:20.545
5 Coulthard	1:20.546
6 Hill	1:20.680
7 R Schumacher	1:20.875
8 Irvine	1:20.984
9 Fisichella	1:21.060
10 Herbert	1:21.329
11 Alesi	1:21.439
12 Wurz	1:21.479
13 Takagi	1:22.495
14 Panis	1:22.538
15 Barrichello	1:23.294
16 Trulli	1:23.318
17 Diniz	1:23.429
18 Nakano	1:23.573
19 Verstappen	1:23.644
20 Salo	1:23.716
21 Tuero	1:25.450

1:19.210 8: Wurz 1:19.063 2: Frentzen 1:19.029 4: Irvine 1:18.325 3: M Schumacher 1:17.366 8: Hakkinen 1:16.973



9:706 10: R Schumacher 1:19.171 5: Fisichella 1:19.050 1: Villeneuve 1:18.337 9: Hill 1:18.214 7: Coulthard 1:17.131





# Qualifying

by Andrew Benson

## McLaren edges it

**T**he warning signs for Michael Schumacher's victory in the Hungarian Grand Prix were there after qualifying, but you had to look hard.

McLaren drivers Mika Hakkinen and David Coulthard qualified ahead of him, but the German gave a hint on Saturday afternoon of what was to come the following day with what might have seemed an inconsequential comment.

'They have a gap in qualifying, but the race is a different story,' he said.

It would have been easy to dismiss that as the Ferrari man talking up his chances in the race and putting pressure on McLaren, but Sunday afternoon proved that he was deadly serious.

The Ferrari-Schumacher combination was quicker than the

cars in front of him in Hungary, but that was disguised by the fact that the German chose the harder of Goodyear's two tyre compounds and McLaren the softer Bridgestone.

The Ferrari man found little difference in lap times between the hard and soft tyres, so he chose the hard one because he knew it was better for the race.

McLaren, meanwhile, felt that the softer Bridgestone was better in race and qualifying. However, its choice may have been coloured by an admission made after the event by Coulthard. 'If we had used the harder one,' the Scot said, 'I don't think we'd have been in pole position. You have to say there's a bit of work to do on the tyre front.'

That was not so obvious after qualifying, when the McLaren had the edge on Ferrari.



Rose/Sutton

Hakkinen signals V for victory after qualifying. The race was a different story

Schumacher always goes well in Hungary. The dusty, low-grip surface allows him to grab the car by the scruff of the neck and the slow average speed negates the McLaren's advantage in aerodynamic efficiency cannot show itself to the same extent as at quicker tracks.

It was not enough. Schumacher was briefly fastest - because he had been baulked by Heinz-Harald Frentzen's Williams on his first run. More rubber had therefore been laid down by the time he set his first quick time - on his second run - than for the McLarens, which were out earlier.

Schumacher's first flying lap of 1m17.505s put him ahead of Hakkinen by 0.289s, but shortly afterwards Coulthard set a 1m17.131s, which was followed by a 1m16.973s for the Finn.

Neither McLaren was to improve, but they did not need to, for Schumacher set a 1m17.366s on his third run, and his last-ditch attempt

in the dying minutes was wrecked when he ran wide at the penultimate corner.

Hakkinen had suffered a minor spin on his first run. He tried again on a final set of tyres, but was 0.009s slower than



Teel/LAT

Coulthard suffered a minor spin in practice

his best. Coulthard, meanwhile, was heading for a faster time on his third run - which he thought might have sneaked him ahead of his team mate - when he bounced over the kerbs at the last chicane. His fourth attempt was ruined by traffic.

Hakkinen said: 'I could maybe have gone a little quicker on my last run by taking big risks. But there



Chapman/LAT

The flying Finn topped the timesheets on Saturday yet again. It's becoming his speciality

### Hungary team by team... Hungary team by team... Hungary team by team... Hungary team by team...

#### WILLIAMS

Williams FW20, Mecachrome V10



**1** Villeneuve FW20/5

FW20/4 **2** Frentzen

Jacques Villeneuve was fourth on the first day, and held the same spot in qualifying for a while. He slipped to sixth when Damon Hill and Eddie Irvine went quicker, admitting that he hadn't quite got the last run right. Heinz-Harald Frentzen was suffering with what he thought was a stomach upset, but by Sunday night it was diagnosed as something more serious. He tapped the barrier on Saturday morning, and his qualifying strategy of running sets

of two timed laps rather than one did not pay off. He ended 0.692s down on Villeneuve. That translated into a difference of just one position, and he started seventh. The Canadian ran sixth at the start, but gained a spot when Irvine retired. He got ahead of Hill at the second stops and then took third from Mika Hakkinen, despite suffering a power steering failure. Not far behind for much of the race, Frentzen finished a groggy fifth.

#### FERRARI

Ferrari F300, Ferrari V10



**3** M Schumacher F300/188 F300/185 **4** Irvine

As in Hockenheim, Michael Schumacher had a frustrating qualifying session, having been held up by Frentzen on his first run, and having to abort his last after making several mistakes. In between, he did a time which was good enough for third. Eddie Irvine found his car difficult on the bumps, but was happier in qualifying, when he earned fifth. Schumacher made a so-so start and couldn't take advantage of David

Coulthard starting on the dirty line. He stayed with the Scot through the first half of the race, and, after his second stop, jumped into the lead after the McLarens pitted. A three-stop strategy worked perfectly and he opened up enough of a lead to stay ahead of Coulthard while Hakkinen took care of himself. Irvine was fourth and less than three seconds behind Schumacher when his gearbox broke on lap 13.





the track, it was worse at others.' The Finn said he had hoped he could extend the margin over the second-placed Coulthard, but 'with the speed David was going today - he was very fast - it was difficult to make that gap any bigger.'

Coulthard said: 'It was extremely disappointing not to get the last run, but qualifying is all about getting a lap in. I started my last run, but there was just so much traffic. I was late getting out of the pits and I came up behind a Minardi at the last corner before starting my lap. I tried to leave a gap, but he was held up by a Jordan which was doing the same, and I had to overtake it in the first corner. There's a lot of dust off the line here, and after I'd done that, I was never going to get pole.'

The McLaren drivers used the slightly wider tyre that Bridgestone brought to Hungary. 'We think it's definitely better,' Coulthard said. 'It gives a little more stability, on our car at least.'

Schumacher, despite being third, was not entirely unhappy. He knew that his position would give him the clean line off the start. 'Starting third,' he said, 'I can have a good race. With the right strategy we can have a chance tomorrow.'

How prophetic those words would prove to be. ■

was no point. It was an unusual qualifying session for me. We made more changes to the car than we would usually do to try to improve it in certain areas, but if we managed to make it better at some places on



Schumacher had the Ferrari right on the ragged edge in qualifying. It paid dividends

## Jordan fightback

# Hill keeps up the momentum

Damon Hill shrugged and smiled. He did not know, he said, why he had developed such a special and successful relationship with the Hungaroring.

There was no question that the love affair he has enjoyed with the dusty little track a few miles outside Budapest was very much alive.

Jordan has traditionally gone badly in Hungary and the team was expecting to experience a slight fall-

aerodynamic improvements and the new E-spec Mugen engine, which is a little better in driveability and has more horsepower - and which we will have for the race - has helped us.'

Hill was ahead of Eddie Irvine's Ferrari and Jacques Villeneuve's Williams. He was probably helped a little in qualifying by the fact that he had chosen the softer of the two Goodyear tyres, even if engineers did not think there was much



Hill always goes well at the Hungaroring, no matter what the car. Jordan benefited

off in its excellent form of late. For Hill it did not happen, and he lined up a competitive-looking fourth.

'You can't drive well here unless the car is right,' Hill said, 'and we have made progress with the car. It's a bit like Monaco and Argentina here, in that you need a lot of downforce, and the car is getting better in that respect.'

Pre-race testing at Jerez in Spain, which is similar to Hungary in terms of heat and dust, had boosted Hill's confidence, he said, but he was still wary of how the Jordan would go.

Hill said: 'I was more optimistic after Jerez, but I still had a big question mark over whether the car would go well. But a combination of

difference between them. But there was cause for optimism at Jordan because Irvine had the same tyres, although Villeneuve had gone for the harder ones.

Team mate Ralf-Schumacher had a less happy time. On the harder tyres, he could only manage 10th, nearly a second down on Hill.

'I had expected to be slower than Damon,' he said, 'because I chose different tyres from him. He did a great job. I struggled with understeer, and I lost 0.35s in the last corner of my penultimate run (after running wide). That probably cost me seventh place. On the last run, there was just too much traffic to make a good time.'

## team... Hungary team by team... Hungary team by team... Hungary team by team... Hunga

### BENETTON

Benetton B198, Playlife V10



**5** Fisichella B198/6

Benetton's form gave the clearest indication that Goodyear had the upper hand. The new long-wheelbase car had been tested successfully at Silverstone, so was raced for the first time. Giancarlo Fisichella had an eventful weekend. He lost time when he spun off on Saturday morning, and then had a heavy impact with the tyre wall on his first lap in qualifying. He returned to take the spare, with which he lined up eighth, although he wasn't

**6** Wurz B198/7

too comfortable in it. He kept the same chassis for the race. Alex Wurz had never seen the track before, and after a difficult first day he qualified ninth, just 0.013s behind his Italian team mate. Fisichella made a bad start and dropped to 10th. He spent much of the race battling with Jean Alesi, and finished a place behind him in eighth. Wurz ran ahead of both of them until retiring on the pit straight with a gearbox failure on lap 70.

### McLAREN

McLaren MP4-13, Mercedes V10



**7** Coulthard MP4-13/7

It was business as usual as the team hopped the front row for the eighth time this season. Mika Hakkinen had few worries as he put in a pole lap in the 1m16s, which was well out of reach of Michael Schumacher. David Coulthard had been marginally quickest on Friday, but lost track time with a spin into the gravel on Saturday morning. He had a difficult qualifying session, and was held up on his promising last run. His best was still

**8** Hakkinen MP4-13/5

only 0.158s shy of the Finn. Both men made good starts and settled into a one-two formation, while Schumacher kept Coulthard on his toes. Hakkinen held the lead after his stop on lap 28, but felt a handling problem just before his second stop on lap 46, at which point Schumacher got ahead. Thereafter he tumbled down the order to an eventual sixth. Coulthard stopped on laps 26 and 46 and could do nothing about Schumacher.



# 1998 ITALIAN GRAND PRIX

13TH SEPTEMBER **MONZA**

Day return flight from **Stansted** including transfers, taxes, **race ticket** and after race time at leisure in **MILAN** prior to return flight home.

**£279** P/PERSON  
TICKET  
UPGRADES  
AVAILABLE

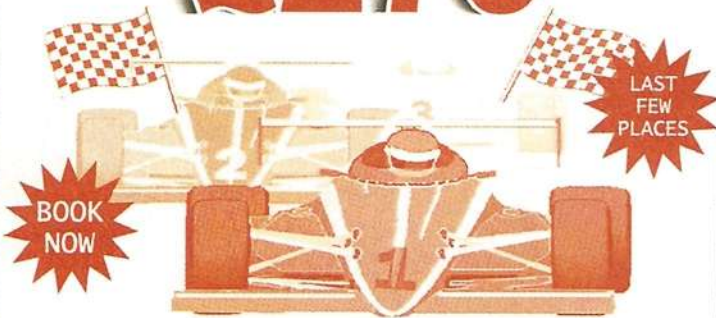

**Flight Options**

**0171 976 5600**

28 CHURTON STREET, LONDON, SW1V 2LP

the luxury of  
**Leather**

**RED HOT EXCLUSIVE!  
OUT NOW!**

the look of  
**Carbon  
Fibre**

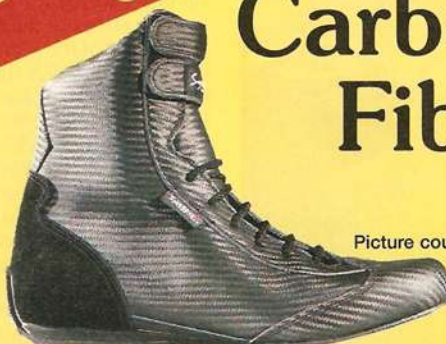

Picture courtesy of CCC.

All you ever wanted from your boots, but were afraid to ask for.

- Waterproof
- Fully Breathable
- Abrasion Resistant
- Wipe-Clean Finish
- Nomex Lined
- F.I.A. Approved
- Drivers, Co-Drivers, Pit Lane, Short or Tall boots available
- Corporate Colours and logos (to order)

**System<sup>7</sup>**  
RACEWEAR

System 7 Racewear Ltd  
Tel: +44 (0) 161-725-8199  
Fax: +44 (0) 161-725-9265  
Web: [www.system7.co.uk](http://www.system7.co.uk)  
E-Mail: [sales@system7.co.uk](mailto:sales@system7.co.uk)  
Agencies Available Worldwide

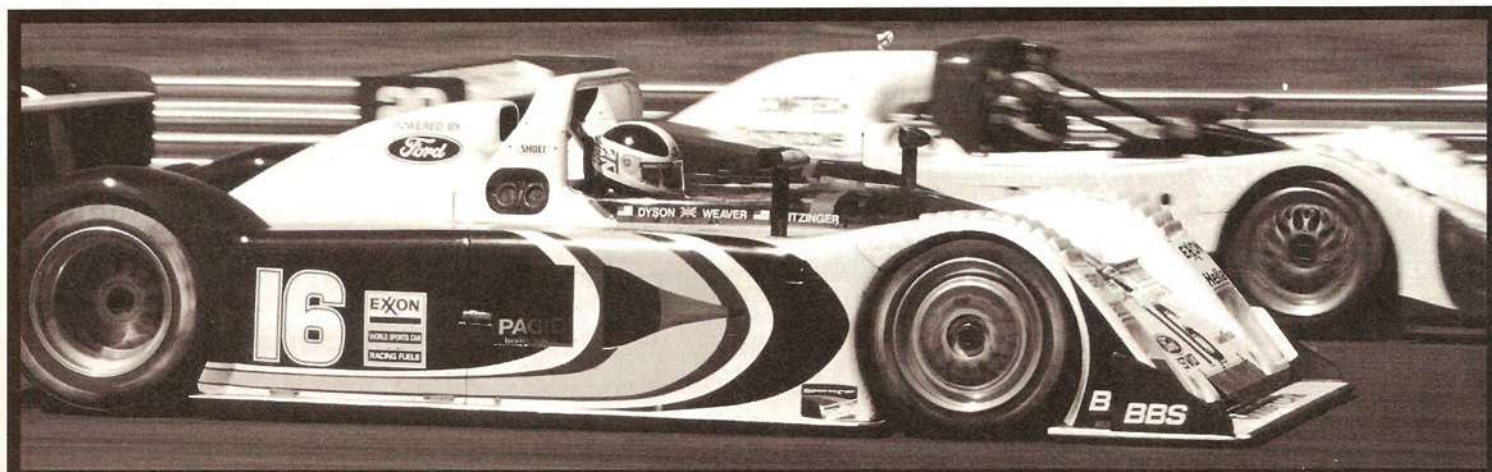

**WORLD'S  
LARGEST  
HARDCORE  
RACING  
TRADE  
SHOWS**

NEW FALL DATES! EXCITING NEW HOST CITY!  
**Performance  
Racing Industry**  
6TH ANNUAL TRADE SHOW **SACRAMENTO**

OCTOBER 22-24, 1998

**SACRAMENTO, CA**

THE TRADE SHOW FOR THE EXPLODING WEST COAST RACING MARKETPLACE!  
350 RACING PRODUCT MANUFACTURERS EXHIBITING IN 550 BOOTHS!

NOW IN THE WORLD CAPITAL OF MOTORSPORTS!  
**Performance  
Racing Industry**  
11TH ANNUAL TRADE SHOW **INDIANAPOLIS**

THURSDAY, FRIDAY, SATURDAY SHOW DAYS!  
DECEMBER 3-5, 1998

**INDIANAPOLIS, IN**

THE TRADE SHOW FOR THE WORLDWIDE HARDCORE RACING MARKET!  
900 RACING PRODUCT MANUFACTURERS EXHIBITING IN 1,950 BOOTHS!

**AVOID LONG LINES & DELAYS. PRE-REGISTER TODAY—IT'S EASY!**

Send or fax for pre-registration credentials, hotel and travel information. Only legitimate members of the racing trade will be allowed into the show.  
*Attendees must submit racing business identification to obtain credentials.*

**CALL TODAY!**

P.O. BOX 9327 • SOUTH LAGUNA, CA 92677 • USA • FAX 949/499-0410

**949/499-5413**

PRODUCED BY THE PUBLISHERS OF PERFORMANCE RACING INDUSTRY

©1998 by Laguna Coast Publishing, Inc.



# Williams more competitive, but drivers fail to capitalise

Williams proved that lap times set in Formula 1 testing should be taken with a degree of scepticism by falling short of the stunning pace set by Heinz-Harald Frentzen while warming up for the Hungarian Grand Prix.

At Jerez, Spain, the previous week, Frentzen had topped the best times set by McLaren. However, while Williams is undoubtedly in better shape than at the start of the season, both Frentzen and team mate Jacques Villeneuve were over a second slower than the McLarens when it counted last Saturday.

That was no surprise to technical director Patrick Head. He conceded that, while Williams had made some progress in Hungary, it had not, in his own words, 'changed anything that justified expecting a significant improvement in performance'.

Williams was treating Hungary as an arbiter of how much progress it had made with a troublesome car because the FW20 has struggled on high-downforce tracks. So, while there has not been a revolution, there were positive signs.

Villeneuve may have been sixth, and beaten by Damon Hill's Jordan and Eddie Irvine's Ferrari, but the three cars were covered by only 0.123s. The World Champion really should have been ahead of both his immediate rivals. He was 0.3s up on his last lap until the last chicane, where he got out of shape.

That was still his best lap, but the moment cost him a place on the second row. Add in the fact that Villeneuve was on the hard Goodyears and Hill and Irvine the soft ones, and his performance looks even more respectable.

With Schumacher and the two McLarens over a second ahead, it is nothing for a team like Williams to get too excited about. It was, though, better than might have been expected in Hungary.

Frentzen also failed to get the best out of his qualifying session. He was down in 10th until his last run and only a good effort on his very last lap moved him up into a more respectable position. It might have been better had he run all of the three available flying laps in his last run at full speed, instead of easing off on the second one and then going for it again on the third, when the tyres would have lost a bit of their edge.

'I am happy with my car, but not my performance,' said the German, who was suffering with a seriously upset stomach.

## Benetton changes fail to arrest slide

Benetton, the surprise of the early season, looks increasingly likely to see its year fizzle out in frustration and disappointment.

The team introduced a revised car for the Hungarian Grand Prix, but it failed to halt a run of races in which it is sliding down the top 10.

Benetton last weekend proved the truth of the Formula 1 cliché that, if you stand still, you go backwards. It fell into line with this year's trend by trying out a car with a lengthened wheelbase in Hungary. While this proved to be a



John Marsh/Emplies

Fisichella hit the tyres on his first flying lap

step forward in pre-race testing, Giancarlo Fisichella and Alexander Wurz qualified eighth and ninth, two seconds off the pace.

The two were split by just 0.013s. Both felt it would have been possible to do better - Fisichella crashed on his first run and admitted to 'making a few small mistakes after that', while Wurz, who took some time to come to terms with a circuit that was new to him, complained of traffic. Even taking that into account, and the fact that both men chose the harder of the two Bridgestone tyres, the bottom end of the top 10 was a disappointing result. Neither the revised car nor the new, wider Bridgestone tyres had shifted the team in relation to its opposition.

Technical director Pat Symonds said: 'I don't think we have come to terms with our new car and tyre combination this weekend.'



Patrick Head consults Frentzen over the state of the track, the car, the tyres... and his innards

Tele/LAT

## Hungary team by team... Hungary team by team... Hungary team by team... Hungary team by team...

### JORDAN

Jordan 198, Mugen Honda V10



**9 Hill** 198/3      198/4 **R Schumacher** 10

Jordan continued its good run with a fourth consecutive points finish, which has put the team in a secure fifth in the constructors' battle. Damon Hill was quick throughout practice. He was sixth on Friday, and qualified an excellent fourth, matching team mate Ralf Schumacher's performance at Hockenheim. While Hill went for the soft option Goodyear, his team mate chose the harder tyre. The German struggled with understeer, and was

down in 10th, almost a second behind Hill. The Briton handed a place to Eddie Irvine at the start, but regained it when the Ferrari man retired. He then lost a spot to Jacques Villeneuve after the second stops. However, he moved back up to fourth when he passed a slowing Mika Hakkinen, and then held off Heinz-Harald Frentzen to the flag. Ralf was forced wide at the first corner and slipped down to 13th. Despite a spin, he recovered to ninth.

### PROST

Prost AP01, Peugeot V10



**11 Panis** AP01/7      AP01/6 **Trulli** 12

Alain Prost's announcement that his drivers are staying on for 1999 coincided with one of the team's poorest showings in what has already been a dismal season. Jarno Trulli had a disastrous time on Friday, spinning off early in the afternoon and missing all the dry running, in addition to feeling unwell. On Saturday, he did well to salvage 16th. Meanwhile, Olivier Panis was struggling over the bumps, and could do no better than a

lowly 20th, between the two Minardis. The Frenchman was much happier with a fuel load on board the car in the warm-up, but managed to drop behind Esteban Tuero to last at the start. From there he plugged away and after two pit stops and a reliable run he had risen to 12th by the flag. Despite gearbox problems, Trulli had a solid run and had hauled himself up to 12th before his engine failed on lap 29, just after his first stop.



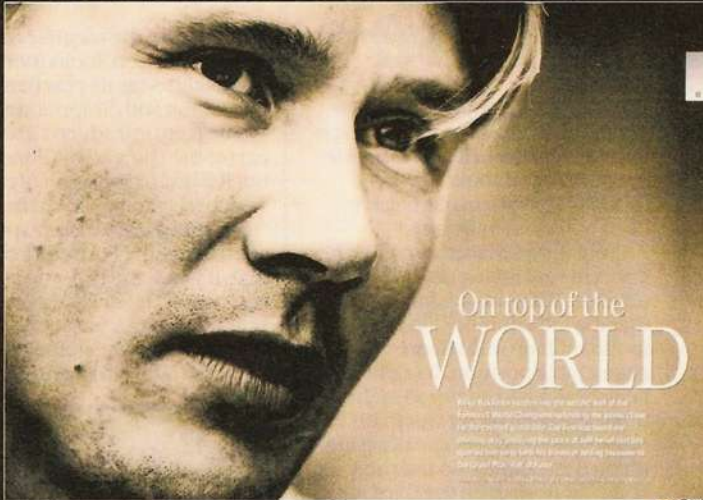

## On top of the WORLD

With a focus on capturing the essence of his subjects, Michael Chabon's new book, 'The American Dream', follows the path of a young man who has spent his life in a small town in the heart of California. The book is a collection of short stories and essays that explore the complexities of life in a small town and the challenges of growing up in a world that is often hostile to those who are different.



## Every picture tells a story



The silver beauty of extraordinary control just with the latest French coupe...

But we also realized that collaboration...

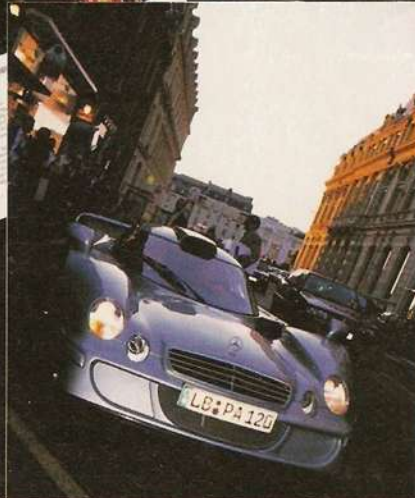

## ONE FOR THE ROAD

An excursion to the ancient city of Le Mans in the new Mercedes CLK-AM turned out to be a Tour d'Emotion for all photographers, film crew, passers-by and even nonstop parked just to be near the silver neoclassic.

POWERED BY MERCEDES-BENZ SUMMER 1998

# STARS & CARS

Powered by Mercedes-Benz

**THREE WAYS - ONE TARGET**

- FORMULA 1 - In the lead at the start of the second half
- GT - A metre high, silver, and sensational: the CLK-AM
- CHAMP CARS - 200mph and then you start to overtake

# ON SALE NOW

AVAILABLE FROM ALL GOOD NEWSAGENTS



# Benetton's long shot

The B198 was the latest car to join the trend to longer wheelbases, but with minimal effect. By Giorgio Piola

**W**hile Ferrari and McLaren battled it out at the front, the rest worked hard on trying to catch up. Benetton introduced its own version of the hottest trend of the year - a longer wheelbase. Despite high hopes for the revised car (pictured bottom) before the race, this proved disappointing.

The wheelbase had been stretched by only 3.5cm. The team had achieved this by changing the angle of the rear suspension, as can be seen by the different pick-up points for the top wishbone (1). The extra length of the car is betrayed by the floor of the B198. It is made in two pieces, and the addition can be seen at the join (2).

Moving the rear wheels back meant that the flip-ups in front of the tyres needed to be moved, too. This was made easier for Benetton because its rear bodywork is in three pieces; a central portion that just covers the engine, plus two at the sides. These have been remade so the flip-ups remain in their ideal position.

The driveshaft (1) in the shorter car (at the

bottom of the drawing below) was at 90 degrees to the centre line, but the new suspension angles it back 10 degrees, the maximum tolerance. The front attachment point of the wishbones remains the same (2), but relocating the rear wheels caused a problem with the rear wing, which needed to be moved back to ensure the aerodynamics were not affected.

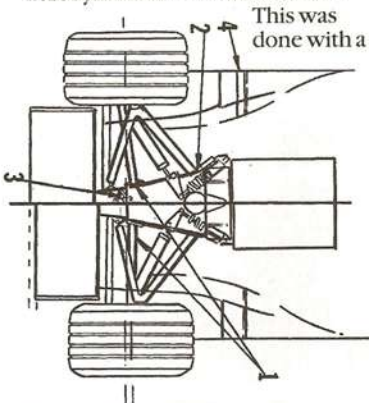

The new Benetton's driveshaft has been angled back by 10 degrees (above top)

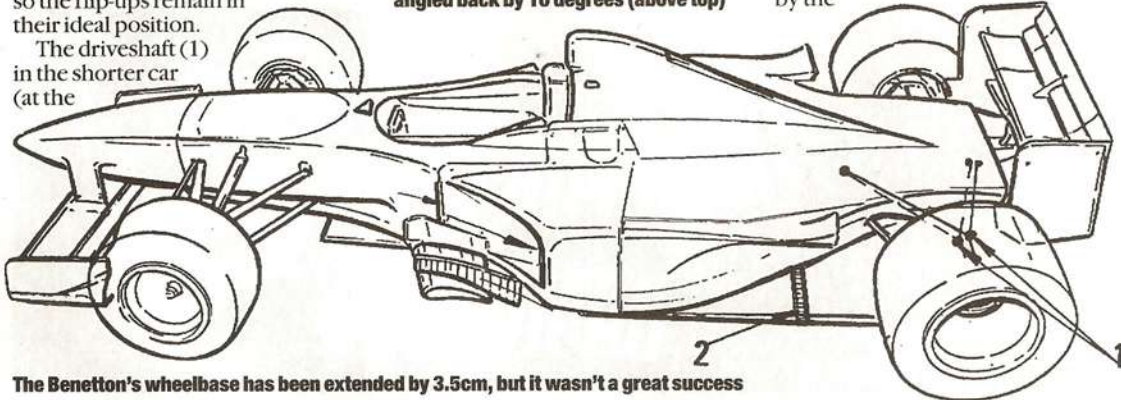

The Benetton's wheelbase has been extended by 3.5cm, but it wasn't a great success

spacer (3) between the rear wing and gearbox. The extra length of the floor can be seen again in (4).

To make sure the front tyres could still be heated to the right temperature Benetton used a lot of ballast in the knife-edge of the chassis at the front.

Ferrari had new front and rear wings, as well as extra holes carved into the rear bodywork to improve cooling (right). All holes illustrated were used in practice, qualifying and race, except those on the top of the bodywork.

Ferrari also continued to work hard on its suspension to try to emulate the superb ride of the McLarens. At the moment, the Italian team has to run its cars very stiff for aerodynamic stability. A longer rear rocker was used at the back for that very reason.

McLaren, like all the other Bridgestone teams, was faced with the problem of making sure that its car's aerodynamics were not ruined by the

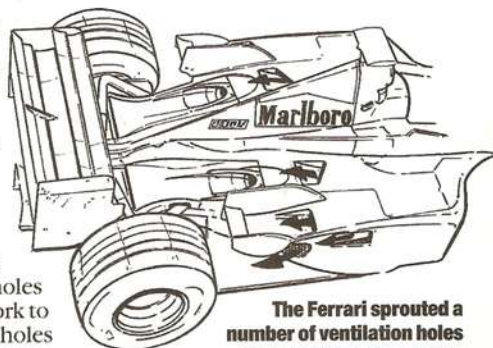

The Ferrari sprouted a number of ventilation holes to improve engine cooling

introduction of wider front Bridgestone tyres, which had a contact patch 18mm bigger than the previous ones. To do this the team produced a new front wing, with a sculpted endplate (below),

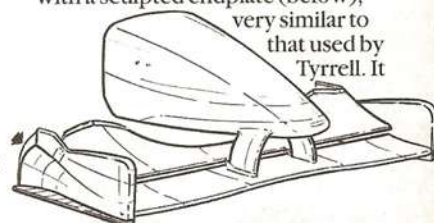

McLaren's new sculpted front wing endplate only appeared on Friday

was only used on Friday. McLaren also had slightly lower-mounted rear bodywork flip-ups.

Williams changed its front suspension geometry, which also let its cars run more steering lock. Jordan tried an alternative front wing flap, but removed it after Friday. Sauber had a new exhaust and diffuser system, with revised side sections to the diffuser, and different fins. ■

## Hungary team by team... Hungary team by team... Hungary team by team... Hungary team by team...

### SAUBER

Sauber C17, Petronas V10



**14** Alesi C17/6

For the sixth race in a row Jean Alesi outqualified team mate Johnny Herbert. The Frenchman hit traffic on his final run, and had to settle for 11th. Herbert had an off in the morning which damaged the undertray. He then spun off again in the middle of qualifying. The Briton ended up in a frustrated 15th, 0.668s behind Alesi. The French driver jumped up to ninth at the start of the race after passing Ralf Schumacher and Giancarlo

C17/1 **15** Herbert



Fisichella. He gained another spot when Eddie Irvine retired. However, he then lost a place to Alex Wurz when the throttle blipper caught him out on a downchange and he went onto the dirt. When the Austrian retired, he rose to seventh. After a change of set-up, Herbert was much happier with the car on race day, but was caught in traffic throughout. After a late spin ('the tyres were completely dead'), he finished in 10th place.

### ARROWS

Arrows A19, Arrows V10



**16** Diniz A19/1

Although there was no repeat of last year's sensational second for Damon Hill, Arrows had a better than average weekend and its cars ran strongly in the race. Pedro Diniz did not have an easy time through Friday and Saturday, but managed to match his best qualifying position of the season. After struggling to find a set-up on the first day, he had to deal with an eye problem over Saturday lunchtime, but was still able to qualify 12th. Mika Salo

A19/5 **17** Salo



did not have any particular problems to report, and was 0.006s behind in 13th. The pair settled into 11th and 12th at the start, and the lack of retirements ahead meant that they made little progress up the order. Salo disappeared from the fray with a gearbox problem on lap 19. Diniz had difficulties with oversteer. Lack of straightline speed allowed Herbert and Ralf Schumacher to pass. The Brazilian finished 11th.



# Postcard

by Adam Cooper

## F1 hits the streets

On Friday morning, Michael Schumacher and Jacques Villeneuve happened to leave the underground garage of their downtown hotel at the same time. The German was aboard an Alfa Romeo, the Canadian at the wheel of a Mercedes. Racing drivers are always in a hurry to get to circuits (although, for most, getting away quickly is even more important). It did not take long for a little friendly competition to build up. The matter of who made it to the Hungaroring first became a priority.

Not long after their arrival, stories about a mad dash through Budapest circulated around the paddock. By the time everyone had put their spin on the tale, it had become something akin to *Bullitt* or *The Italian Job*. In a press conference, a British journalist asked Schumacher if his alleged feats were appropriate for a man charged by the FIA with promoting road safety. After awkwardly trying to wriggle out of an answer, a grinning Ferrari driver

saved himself with the inspired suggestion that he was merely driving like everyone else in Hungary.

Schumi subsequently invited the hack to join him for a ride to the track on race morning. By all accounts the double World Champion could have been chauffeuring his granny around, so carefully did he make his way from the city centre. Press room cynics suggested our colleague was disappointed to find that the race winner had left without him on Sunday afternoon.

Drivers and other VIPs can save time travelling to the circuit by taking 'Bernie Avenue', a road constructed across the fields to avoid the time-consuming trip through a nearby village. It's not an option to the fans, who have to sit in traffic jams. This year's crowd was noticeably different from what we've seen in previous seasons. Mikamania has taken hold in Finland, and, since Budapest is relative easy to reach from Helsinki, the Finns were out in force. White and pale blue flags seemed to outnumber the Schumacher red and yellow for most of the weekend, although they drooped a little towards the end of the race.

That's when Schumacher's mob reminded us of their presence. Delight at his victory was reflected in the suicidal dash onto the track which began even before the finish, although not all were consumed in the sheer joy of the moment. 'There were a couple of Germans being stupid with Jacques,' reported a bemused Johnny Herbert. 'They stood right in front of him and gave him the finger!' ■



F1 photographers reach rock bottom

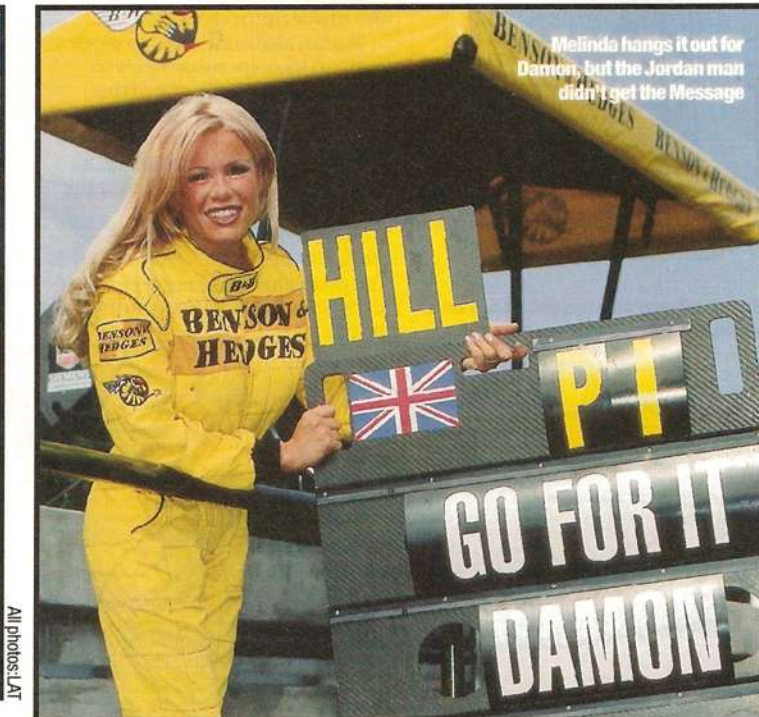

Melinda hangs it out for Damon, but the Jordan man didn't get the Message



High-profile meeting: EJ talks to Uncle Tom



F1's 'Big Man' finds someone his own size to pick on

Hungary team by team... Hungary team by team... Hungary team by team... Hungary team by team...

### STEWART

Stewart SF-2, Ford V10



**18** SF-2/4 Barrichello

Rubens Barrichello was a promising 10th on Friday, but couldn't repeat it when it mattered. After hitting traffic on his final run, the Brazilian was 14th. Jos Verstappen had an awful time on Saturday morning, blowing an engine and then tangling with Ricardo Rosset on his first lap out after a lightning change by the mechanics. With only eight laps under his belt, he struggled to find a set-up, and could not better

**19** SF-3 Verstappen

17th. His front wing was then damaged on the scrutineering weighbridge! Barrichello made a bad start in the race and slipped to 16th, just ahead of Verstappen. Lacking grip, he made little progress and was 13th when high gearbox temperatures forced him out on lap 54. His team mate had problems with his first set of tyres and complained of heavy steering throughout. He finished 13th.

### TYRRELL

Tyrrell 026, Ford V10



**20** Rosset 026/4

After a positive test session at Silverstone, Tyrrell had a disappointing time in Hungary. Seventeenth on Friday, Tora Takagi lost much of Saturday morning after spinning off into a tyre barrier. Despite finding one second on his final run, he could still only manage 18th. Intriguingly, the Tyrrell was fastest of all through the speed trap. Meanwhile, for the fourth time this year, Ricardo Rosset failed to make the race,

**21** 026/5 Takagi

missing the 107% mark by a hefty 0.779s. However, his absence meant Takagi could try different set-ups on all three cars in the warm-up! He chose to stick with his race car. After his shunt in Austria, the Japanese preferred a cautious approach to the first corner in the race, and thus dropped to one from last. Thereafter, he had a low-key journey to 14th. On the slowing down lap, he went off line to avoid the crowd invasion, spun and stalled.





'But Damon, shouldn't you wait until *after* the race to give me this?' asks Sly Stallone

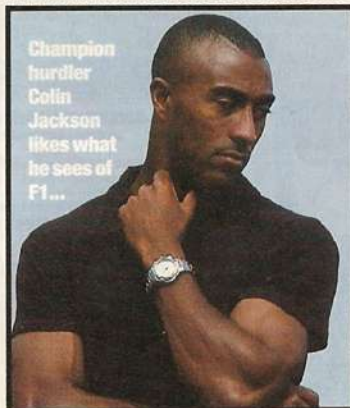

Champion hurdler Colin Jackson likes what he sees of F1...



McLaren's lost can of silver paint turns up in an unusual spot



Verstappen makes his own travel plans



Mikamania hits the Hungaroring, as the Flying Finn's fans make their feelings clear



Things go better with Coca-Cola...



David and Damon gave the British a lift



Salo's grid girl faints at the thought of having him in front of her. Lucky it was just a practice session



Cap'n Irvine failed to plunder any points for the Ferrari treasure chest



Birthday boy: the FIA's Charlie Whiting

Team... Hungary team by team... Hungary team by team... Hungary team by team... Hungary

**MINARDI**

Team by team written by Adam Cooper

Minardi M198, Ford V10

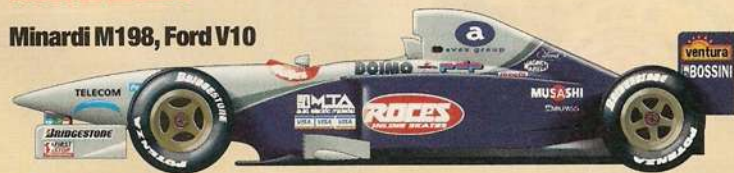

**22** Nakano M198/4 **23** M198/5 Tuero

Minardi had not tested Bridgestone's new front tyres prior to Friday, so the team took time to get used to them. Shinji Nakano, sixth for Prost last year, qualified 19th, while track rookie Esteban Tuero was 21st and last of those to make the 107% qualifying margin. The Argentinian lost time on Saturday morning with a gearbox problem and a trip into a gravel trap. In the race, Tuero made a good start and rose to 18th. After making a couple of

mistakes, he was told to let Nakano through - Takagi barged by at the same time, dropping him to 20th. He held off Panis for a while before an engine problem stopped him on lap 14. Nakano was behind Verstappen early on, but his race was spoiled when a jammed refuelling valve developed into a Keystone Cops scenario stretching his second pit stop to 39.2s. Hampered by oversteer, the Japanese finished 15th.

**BELGIAN GRAND PRIX**

**PREVIEW AUGUST 27  
REPORT SEPTEMBER 3**



# FANTASY Grand Prix

**SCALEXTRIC**

**Silverstone**



# PULLING A FAST ONE

## HOW DID YOU DO IN HUNGARY?

DRIVERS								
1	M Schumacher	30	23	E Tuero	-5	44	Benetton	11
2	J Villeneuve	18	24	J-P Montoya	0	45	Jordan	13
3	M Hakkinen	17	25	P de la Rosa	0	46	Prost	-2
4	D Coulthard	21	26	J Muller	0	47	Sauber	12
5	H-H Frentzen	18	27	L Badoer	0	48	Stewart	-1
6	D Hill	13	28	D Franchitti	0	49	Arrows	-3
7	E Irvine	-4	29	N Minassian	0	50	Tyrrell	0
8	O Panis	8	30	S Ayari	0	51	Minardi	-5
9	G Fisichella	0	31	N Heidfeld	0			
10	J Alesi	4	32	J Davies	0			
11	J Trulli	-2	33	A Zanardi	0			
12	M Salo	-3	34	M Blundell	0			
13	R Schumacher	3	35	M Wilson	0			
14	J Herbert	5	36	R Zonta	0			
15	A Wurz	0	37	E Collard	0			
16	R Barrichello	-1	38	N Larini	0			
17	J Magnussen	0	39	T Kristensen	0			
18	J Verstappen	4	40	G de Ferran	0			
19	P Diniz	1						
20	T Marques	0						
21	S Nakano	4						
22	T Takagi	4						

ENGINES			
52	Mecachrome (Renault)	14	
53	Ferrari	20	
54	Mercedes	16	
55	Peugeot	0	
56	Mugen Honda	13	
57	Ford V10 (works)	0	
58	Sauber Petronas	12	
59	Yamaha/Hart V10	11	
60	Ford V10 (customer)	0	

CHASSIS			
41	Williams	14	
42	Ferrari	16	
43	McLaren	16	

TYRES			
61	Goodyear	10	
62	Bridgestone	5	

**FINAL ENTRIES: FRIDAY NOON BEFORE EACH GRAND PRIX. DIAL 0891 891800**

**Dial 0891 891 802**  
Top 50 teams and race results



**TEAM POSITION CHECKLINE 0891 891 801**

UPDATED MON PM AFTER THE RACE. CALLS ARE CHARGED AT 50p MIN CHEAP RATE



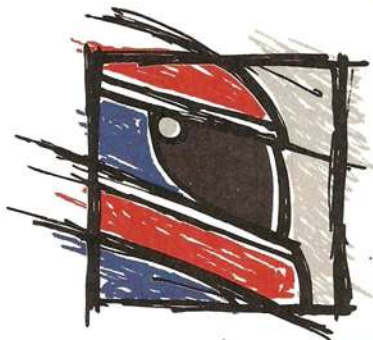

**vodafone**  
**NISSAN**  
R A C I N G



official merchandise **NISSAN**

**order form**

Item	Code	Sizes	Quantity	Retail price	Total price
1 T-shirt Touring Car one size only, xl	VNR206			£ 12.00	
2 T-shirt navy s,m,l,xl	VNR205			£ 15.00	
3 Poloshirt red m,l,xl	VNR223			£ 20.00	
4 Poloshirt white m,l,xl	VNR203			£ 20.00	
5 Framed Car Print 17 x 11 inches	VNR221F			£ 20.00	
6 Model Car with display case, scale 1:24	VNR227			£ 156.00	
7 Umbrella	VNR213			£ 30.00	
8 Rain Jacket m/l and xl/xxl only	VNR222			£ 15.00	
9 Baseball Cap navy	VNR208			£ 10.00	
10 Baseball Cap white	VNR218			£ 10.00	
11 Fleece Jumper s,m,l,xl	VNR202			£ 35.00	
12 Performance Jacket s,m,l,xl,xxl	VNR201			£ 150.00	
13 Ski Hat one size only	VNR207			£ 8.00	

Size guidelines: British s=36" m=38" l=40" xl=42-44" xxl=48" (chest): European s=46 m=48 l=51 xl=54-56 xxl=61  
 Post & packing £ 2.95  
 Total value

**DELIVERY ADDRESS - PLEASE COMPLETE IN BLOCK CAPITALS**

Name: \_\_\_\_\_  
 Address: \_\_\_\_\_  
 \_\_\_\_\_  
 \_\_\_\_\_  
 Postcode: \_\_\_\_\_  
 Daytime telephone number: \_\_\_\_\_ Date: \_\_\_\_\_

I enclose a cheque made payable to Nissan Merchandise, or  
 Please debit my Visa or Mastercard for £ \_\_\_\_\_ (total amount)

Name of card holder: \_\_\_\_\_  
 Credit card number:              
 Expiry date:

Signature: \_\_\_\_\_

To order from the Nissan Motorsport Portfolio simply complete this order form and send to the following address:  
**Nissan Merchandise, PO Box 30, Alton, Hants Telephone: 01420 22990 Fax: 01420 23043 Email: nissan.prom@mmcltd.com**

Please send me the Motorsport Portfolio brochure

**IMPORTANT** - please read carefully: 1 Please allow 28 days for delivery. 2 All prices and details are correct at time of going to press. 3 If you are not completely satisfied with your merchandise please return it within 14 days of receipt for a full refund. This does not affect your statutory rights. 4 Produced by Nissan Motor (GB) Ltd, The Rivers Office Park, Denham Way, Maple Cross, Rickmansworth, Herts WD3 2YS. Website: www.nissan.co.uk



One of the oldest entries in the book of trite motorsport clichés says that you make your own luck. If that's the case, Derek Warwick has a very unusual method of manufacturing it.

Not many drivers have got away with hitting their own team mate, making a pit stop to rectify the damage and a further visit due to a change of mind on tyre strategy. That would normally spell the end. In Warwick's case, it meant his Triple Eight Vauxhall Vectra emerged with a lead of more than a third of a lap, which he was easily able to control over the magnificent Yvan Muller's Audi A4.

This, then, was one of the weirdest British Touring Car Championship races of all time, and it owed much to the dismal climate at Scotland's ever-windswept Knockhill. Warwick had started 11th, suffering, like team mate John Cleland, with a car which had poor

**“ It's about timing, it's about luck and it's about doing our homework ”**

**DEREK WARWICK**

traction in qualifying. He then nerfed the Scot into the barriers on the left of the pit straight when the stalled Honda of James Thompson confused the midfield. As the pack reconverged after skirting both sides of the Accord, the two Vauxhalls came together, Cleland cannoning backwards into the tyres.

The safety car emerged as the wreck was cleared up, enabling Warwick to visit the pits to repair the Vectra's right front corner which had been pushed on to its tyre. He caught up the rest of the field just as rain started to fall again. By now, the Triple Eight team had received information that this was going to get heavier, so why not take advantage of the Grand Prix veteran's lowly position by gambling on fitting grooved wet-weather tyres? 'We'd been in touch with the

All photos: Lawrence & Bloxham/LAT

# The luck of the old devil

*A bizarre turn of events, the weather and a fair portion of luck gave Derek Warwick his first win since '92. Marcus Simmons braved the elements*

Met Office, and they turned out to be right,' he grinned afterwards.

It didn't look like a good idea for a long time. Warwick clambered up to seventh place in the four laps after the safety car withdrew to the pits, but was elbowed back down the midfield battle to 12th as the rain refused to take hold. Then, at half distance, an incessant drizzle set in, sending nearly everyone ahead of him into the pits for grooved Michelines. Because of the, shall we say, primitive facilities at Knockhill, this particular BTCC feature race had been designated the sole non-compulsory-stop clash of the season. Ironically, it was to be decided on pit strategy.



**Baird led the race, but it was short-lived**

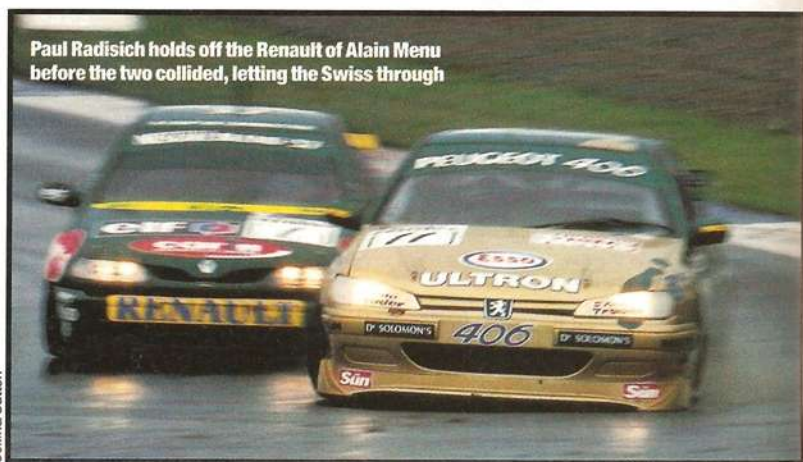

Collins/Sutton

**Paul Radisich holds off the Renault of Alain Menu before the two collided, letting the Swiss through**





The Triple Eight team cheers Derek Warwick home after the Grand Prix veteran's first win since his World Sportscar Championship-winning season

By this time the race had already had two different leaders. Poleman Anthony Reid, who had won the earlier sprint race in his Ray Mallock Limited Nissan Primera, took advantage of Thompson's misfortune at the start. 'The clutch started to drag,' recalled Thompson. 'I could either go (early and make a jump-start) or stall it, but I thought I might just catch it, so I put my foot on the brake, but it stalled. Eventually, I found neutral and started it, but I was last.'

Even better news for Reid came at Duffus Dip. Thompson's Honda team mate, Peter Kox, wasted his front row grid position by spinning, and clipped David Leslie's Nissan as

he came back across the track. That enabled Alain Menu, fifth on the grid in his Williams Renault Laguna, to take an early second place from championship leader Rickard Rydell's TWR Volvo S40.

Soon after the restart, Reid made a mistake at the chicane. 'There was a lot of oil on the circuit and it was like driving on black ice,' he said. 'That made me get a bit sideways at the chicane. I moved to the right to defend into Clark (the next corner), but Menu hit me up the back and I spun nearly into the barriers.' The Swiss, who emerged in the lead, saw it differently. 'I got a run on Anthony, he closed the door, but he was too late. I touched him



Reid celebrates his fourth win in the last five sprints with Menu (left) and Thompson



# TOURING CARS

## '98 so far

### TEAM QUALIFYING

16	Muller	Bintcliffe	4
13	Hoy	Baird	5
1	Hoy	Mansell	1
18	Thompson	Kox	2
14	Reid	Leslie	6
11	Harvey	Radisich	9
13	Menu	Plato	7
11	Cleland	Warwick	7
2	Warwick	Figueiredo	0
18	Rydell	Morbidelli	2

### SUPERGRID

Pos	Driver	Average
1	Thompson	3.8
2	Reid	4.05
3	Rydell	5
4	Leslie	5.15
5	Menu	6.25
6	Plato	6.35
7	Kox	8.2
8	Muller	9
9	Cleland	9.61
10	Warwick	10
11	Morbidelli	10.95
12	Neal	11
13	Mansell	11
14	Hoy	12.1
15	Bintcliffe	13.5
16	Rustad	14.4
17	Radisich	15.05
18	Harvey	15.65
19	Gravett	16
20	Baird	16.28
21	Lemmer	18.13
22	Figueiredo	18.5
23	Moen	19.29

### DRIVER STATS

Driver	laps led
Reid	127
Rydell	116
Thompson	68
Menu	66
Leslie	65
Cleland	37
Hoy	23
Warwick	22
Plato	17
Morbidelli, Muller, Baird	6
Mansell	5
Gravett, Harvey	2
Rustad, Bintcliffe	1



Anthony Reid leads the sprint race as Richard Fittall goes off after bumping with Jason Plato and Will Hoy



Plato T-bones Rydell's Volvo, ending the Swede's points chances in the sprint. 'It was a push-off', he said



Collins Sutton

twice and he was off. For this manoeuvre he was fined and had his licence endorsed - something of a Knockhill tradition these days.

He was, nevertheless, running away with the race when the rain increased, but the Williams stop was botched when a wheelnut got stuck. 'One of those things,' shrugged Menu.

Muller, on inspired form all day, moved into the lead before he pitted the Audi, whereupon Craig Baird, who had driven his Ford Mondeo beautifully from the back of the grid on a set of intermediate Michelins, took the lead. For a few laps it looked as though the West Surrey Racing team's gamble was going to pay off, but as the rain intensified further, the New Zealander found his grip advantage was not going to last long.

At first, it looked like independent runner Matt Neal, who had pitted under the safety car for intermediates, was going to catch the Mondeo, but he threw his Nissan off the track at the hairpin. That meant Warwick, with 20 laps to go, was able to take the lead off Baird into Duffus Dip and stroke to a 7.5s win. Incredibly, such was Warwick's advantage that he was able to cruise home, despite setting



Rydell gets ready to rumble (left); as the Nissan boys look for a spot of bother with the Old Bill (above); Hoy, meanwhile, is still trying to decide which tyres to use



## Knockhill team by team... Knockhill team by team... Knockhill team by team... Knockhill



**7 John Bintliffe** **Yvan Muller** **12**  
Brilliant Muller deserved to win feature race, but took second - best of 'conventional' pit-stoppers. Fourth in sprint after controversial drive, during which he collided with Menu and Kox. Bintliffe retired from sprint when alternator belt came off. Then in feature, he survived a trip into the tyres at the chicane to take 10th, lapping as quickly as Muller, but losing a place to resurgent Leslie three laps from home.



**32 Will Hoy** **Craig Baird** **33**  
Baird had a glorious six laps in front in the feature race before his intermediate tyres became a liability, the Mondeo plummeting to a lapped 13th. Hoy, who had run third after pitting for inters, plummeted only into the gravel trap at Clark. The veteran had a good sprint race, surviving clash with Rydell to take sixth. Baird, out of sorts in qualifying, was stuck in lower-midfield scrap and took 12th.



**5 James Thompson** **Peter Kox** **50**  
Team work saw Thompson and Kox heading for two-three in sprint race, before Muller tipped the Dutchman into a spin down to seventh. Thompson stalled at start of feature, then pitted for wet/inter mix. Kox got up to third on inters after spin at start, but soon slid down order. Eventually, Thompson aquaplaned off while passing Kox, who slithered to last. A poor reward after two front-row grid positions.



**8 David Leslie** **Anthony Reid** **23**  
Yet another sprint race win for Reid, controlled as ever from pole position in a masterly drive. Leslie lost out to Menu and then Muller before taking fifth. Reid led feature, too, but spun off in collision with Menu and had slow pit stop. Then he had further brushes with Menu and Radisich, taking seventh with 'knackered' suspension. Leslie had incidents with Kox and Radisich, and another on his own, but took ninth.



Qualifying

For Reid and Kox the start to the weekend was a dream come true

Yvan Muller drove with a vengeance, finishing fourth in the sprint and second in the feature



the slowest fastest lap of the race. 'It looked like we were going to be wrong,' grinned Warwick, a victor for the first time since his 1992 World Sportscar Championship-winning season. 'Then the rain came and we inherited first place. It's about timing, it's about luck and it's about doing our homework. We had nothing to lose and our strategy was correct. I just decided to throttle back and didn't have too much to do in the last 15 laps. I was 17 seconds ahead when I took the lead and I was happy to give Muller half a second a lap.'

Muller, a man on a mission all day, forced Rydell - mindful that in this race he was ahead of all his title rivals - to concede second place at the tight McIntyres right-hander with 11 laps to go. 'I didn't want to be pushed off, so I was quite happy to let him past,' he acknowledged.

Behind them, Menu fought through to fourth, despite a second collision with Reid exiting the hairpin and another with Paul Radisich - hauling the Peugeot up the order in the wet - at the same place. It was finally left to the reigning champion's Renault team mate, Jason Plato, to move over and enable Menu to take fourth. Meanwhile, Reid had driven a

fantastic race after his spin, but then lost time with a wheelclip problem in his stop. His suspension had been weakened in the two shunts with Menu, and he finished it off barging through to take sixth from Radisich on the final lap. The stricken Nissan ran wide at the next corner and Radisich went back ahead. 'Serves him right!' joked the New Zealander. Reid finished seventh.

It had been a happier start to the day for the Scot, who won his fourth sprint race out of the last five as Rydell went out on the first lap. The Swede, who had a poor



Morbidelli suffers after hitting Cleland

qualifying day, was involved in a collision at Duffus with Plato and Will Hoy's Mondeo, his Volvo coming to rest at the bottom of the hill with suspension and splitter damage. 'It was a push-off, not just an accident,' said Rydell, although most were of the opinion that it was a predictable first-corner accident in the wet.

Thompson gave chase, and was given a buffer from the rest of the pack by Kox. That was until Muller came tearing through the field. The Frenchman passed Leslie for fifth when the Scot made a mistake at

If Anthony Reid had any dreams on Friday night about the ideal outcome of Saturday's qualifying, they would have been pretty similar to what actually happened. The Nissan driver, just as he had three weeks earlier at Snetterton, inched ahead of Alain Menu for second in the championship, thanks to two bonus points for his pole positions. As he did so, series leader Rickard Rydell, clearly the quickest in testing, struggled in his Volvo and ended up only sixth and seventh after the two sessions.

'It's only the start of a long, hard weekend,' warned Reid after his first pole in the conventional qualifying session, which put him a large - by Knockhill standards - 0.352s clear of his closest rival. The Scot then went on to pay tribute to unsung engineer Stuart Ayling and the Ray Mallock Limited outfit that runs his Primera. 'It was awesome team work,' he enthused. 'At the beginning of the session, the car didn't feel good, but we made detail adjustments which made all the difference.'

Ironically, Reid was indirectly helped by an off at the chicane in testing, which damaged the Nissan's splitter and radiator. He was forced into the spare car for a while, and the comparison between that and his race machine enabled the RML outfit to get to the bottom of the handling bugs that had initially hampered him.

In the one-shot showdown, Reid maintained his superiority and ended up 0.317s to the good for his eighth pole of the season. He felt he had driven much better than in the previous showdown session at Thruxton, where he 'tightened up too much'. However, he still believed his better performance had been in the opening half-hour. 'That was the best, in the sense that I didn't know what the car would do,' he said. 'It was critical all the way round, but it came together just right.'

Joining Reid on the front row for both races was Peter Kox, the Dutchman at last getting up to speed in his Prodrive Honda Accord and, for the first time this season, outqualifying team mate James Thompson. 'From Donington (in mid-

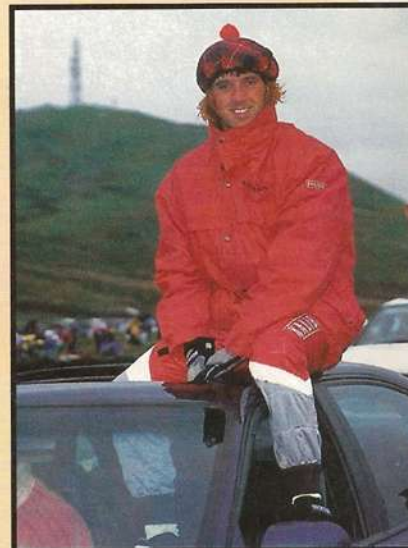

Peter Kox tries to blend with the natives

June) onwards, I've felt I could be competitive,' smiled the front-wheel-drive rookie, 'but it's taken so bloody long to get there. When there's something wrong with the car, I struggle, but if it has a reasonable balance, I'm there or thereabouts. This circuit suits our car.'

It was a good effort from Kox, racing at Knockhill for the first time, and showed what might have been had Thompson not dropped his Accord in the gravel at the hairpin on his third lap of qualifying. The Englishman had already set a time good enough for third fastest, which he emulated in the showdown. More significantly, he felt that this time the Honda, normally terrible over a race distance, would be better on Sunday than any of the opposition. 'My race runs were better in testing than anyone else's,' he said. 'We've done no qualifying runs this week at all - just race runs all the time.'

Reid's team mate, David Leslie, backed him up with fourth in both sessions, ahead of reigning champion Menu's Williams Renault Laguna. Rydell was off the pace, feeling that the balance of his Volvo S40 had gone to pot due to the change in conditions, which induced severe understeer.



Thompson leaves it up to team mate Kox

team by team... Knockhill team by team... Knockhill team by team... Knockhill team



9 Tim Harvey Paul Radisich 11

Highlight was battling sixth for Radisich in feature race, despite knocks with Leslie, Menu and Reid. Peculiar problem for 406s - some substance on their windscreens was mixing with the rainwater to make visibility a problem. Harvey, 15th and 11th in the two races, had to pit in both to try and clear his screen. Radisich was 10th in sprint, unable to find a way past Warwick, who led midfield train.



1 Alain Menu Jason Plato 3

Not a bad points haul for Menu, who crashed in testing through no fault of his own and took third and fourth in the races - plus his normal Knockhill endorsement for his move on Reid to take the lead in the feature. Plato out of sprint at start when he collected Rydell and broke a wishbone on the Laguna's suspension. He was fifth in feature, letting Menu by, but losing loads of time baulked by backmarker Gravett.



88 Derek Warwick John Cleland 99

Unexpected and dramatic win for Warwick in feature, but the Vectra had bad traction problems in qualifying. Changes made for race day seemed to make it better, but conditions were different. 'Delboy' took ninth in the sprint, holding off the midfield pack. Bad day for Cleland. Started from pits in sprint when engine died on grid and finished lowly 13th. Then pitched into tyre wall in feature by team mate.



4 Rickard Rydell Gianni Morbidelli 14

Curious loss of balance after dominating test, but series leader Rydell rescued the weekend with a third in the feature race, cautiously letting Muller by into second. Sprint saw Rydell out at start after collision with Hoy and Plato. Morbidelli screwed up one-shot showdown and could only make it up to 11th in sprint. Dropped out of feature with accident damage after Cleland shunt at start.





**THE ONLY  
TIME WE  
CUT CORNERS.**

When your Vauxhall needs looking at, why hang about? You don't need an appointment when you come to MasterFit and your car is handled by experts - whether it's for a service, repairs or even a quick tyre change.

Why stop anywhere else? For details of your nearest MasterFit, ring 0800 588 588.



**MASTERFIT**  
*The only service fit for your Vauxhall.*





Kox, here leading Thompson, had his most competitive showing, but ultimately earned poor results

the chicane. Then the Audi tapped Menu into a big slide at McIntyres and nipped through into fourth. After that, the Alsatian savaged Kox at the same corner and took third, earning himself a fine and licence endorsement, as the Dutchman spun down to seventh.

Two laps from the end, Muller tried a McIntyres move on Thompson, but the lead Honda had the line well covered. The Audi tried around the outside, got on to the slippery stuff and lost third to a grateful Menu.

Behind Muller, Leslie held off Hoy - revelling in the wet conditions - for fifth. The bearded Scot was the fastest man in the race, but couldn't find a way past anyone ahead.

Like Hoy and Thompson, fortune

did not smile on Leslie in the feature race. He still made it home ninth, despite several incidents. Hoy, on intermediates, lost it at Clark and went into the gravel trap.

Thompson, with inters on the front and wets on the rear, aquaplaned off at the same place while passing



Plato moved over for Menu to take fifth

Kox. 'Being on intermediates, it just wouldn't deal with the water,' he grimaced. 'I T-boned the barrier at 80 or 90mph. I'm really gutted.'

So Rydell, who had started this race behind title rivals Reid, Thompson and Menu, finished ahead of them all to go some way to making up for his sprint race misfortune. In doing so, he restored his points lead to 35, with three meetings to go. Maybe there was luck involved here, too. Luck which wins championships. ■



John Bintcliffe makes his way back on to the track after hitting the tyre wall in the feature

Collins Station

# AUTOSPORT CUP

A change of tyres could have won Matt Neal a £100,000 prize

On the circuit he least expected to do well on, Matt Neal found himself heading for the BTCC's £100,000 independents' jackpot for winning a race outright.

Neal's Team Dynamics Nissan Primera had been forced to start the Knockhill feature race from the back of the grid when it had been found 9kg underweight after qualifying. Then, under the early-race safety car, he took the opportunity to pit for intermediate tyres as the rain began.

By lap 19 of the 45 he was hauling in the Ford Mondeo of Craig Baird, who had started the race on intermediates. On the 24th, he was almost within striking range. Then he went off at the hairpin.

'It just got too wet,' groaned a gutted Neal, who probably would have won the race had his team fitted full-wet tyres. 'Craig had backed off and I thought I was going to win. But I locked up all four wheels into the hairpin and, although I cadence braked, I couldn't stop. I came here with no expectation of doing well - so I suppose I've lived up to it.'

Neal, whose week began badly when he got caught for speeding on the way to the circuit, is being a bit harsh on himself. He'd driven an excellent race to win the AUTOSPORT Cup division in the sprint, a fine

eighth overall. It was scary, though - looming behind was his mid-season nemesis, Derek Warwick. 'The back windows were steamed up and all I could see was this glow, but I managed to hold him off.'

Robb Gravett was turfed out of second when his Brookes Motorsport Honda Accord was hit at Clark Corner by Gianni Morbidelli's Volvo, leaving points leader Tommy Rustad to fill the gap in the DC Cook Motorsport Renault Laguna. The Norwegian was lucky to keep the spot, because he had tipped Baird into a spin under waved yellow flags.

Rustad drove his best race in a long while in the feature and inherited the win when Neal went off. It was a tonic after the heavy shunt at Thruxton in which he hurt his foot and seriously damaged the car. 'I've had quite a difficult mid-season period,' Rustad acknowledged. 'The team did a very good job with the car and my wife did a good job to repair my body!'

Gravett took second, his Honda a lap down after its pit stop, during which a wheelclip got jammed. For the rest of the race he made himself unpopular with works Renault driver Jason Plato, who was trying to lap him, but to be fair it was difficult to tell who was where in this race, and there was scarcely a blue flag to be seen.



So near, yet so far. Wet tyres would probably have kept Neal on the track at the hairpin

## Knockhill (GB)

August 16, **Auto Trader RAC British Touring Car Championship**, rounds 19 & 20 of 26, 1x22 laps and 1x45 laps - 1x28.6 miles and 1x58.5 miles

### SPRINT RACE

Pos	Driver (Nat)	Tyres	Car	Team	Result	Best lap	Qual	Grid
1	Anthony Reid (GB)	M	Nissan Primera	Ray Mallock Limited	22:38.846	58.397	52.509	1
2	James Thompson (GB)	M	Honda Accord	Prodrive	22:41.040	58.538	52.885	3
3	Alain Menu (CH)	M	Renault Laguna	Williams Touring Car Eng	22:41.687	58.114	53.119	5
4	Yvan Muller (F)	M	Audi A4	Audi Sport UK	22:42.038	58.104	53.264	7
5	David Leslie (GB)	M	Nissan Primera	Ray Mallock Limited	22:42.496	57.994	53.040	4
6	Will Hoy (GB)	M	Ford Mondeo	West Surrey Racing	22:45.585	58.125	53.582	10
7	Peter Kox (NL)	M	Honda Accord	Prodrive	22:46.636	58.349	52.861	2
8 (I)	Matt Neal (GB)	M	Nissan Primera	Team Dynamics	22:48.223	58.489	53.495	9
9	Derek Warwick (GB)	M	Vauxhall Vectra	Triple Eight Race Eng	22:52.050	58.747	53.744	11
10	Paul Radisich (NZ)	M	Peugeot 406	Motor Sport Developments	22:53.534	58.771	53.804	13
11	Gianni Morbidelli (I)	M	Volvo S40	TWR Racing	22:54.354	58.622	58.327	19
12	Craig Baird (NZ)	M	Ford Mondeo	West Surrey Racing	22:54.669	58.597	54.246	18
13	John Cleland (GB)	M	Vauxhall Vectra	Triple Eight Race Eng	22:55.390	58.576	53.857	14
14 (I)	Tommy Rustad (N)	M	Renault Laguna	DC Cook Motorsport	23:05.080	59.170	53.751	12
15	Tim Harvey (GB)	M	Peugeot 406	Motor Sport Developments	23:33.958	58.530	53.995	16
R (I)	Robb Gravett (GB)	M	Honda Accord	Brookes Motorsport	8 laps-off	59.478	53.871	15
R	John Bintcliffe (GB)	M	Audi A4	Audi Sport UK	7 laps-alt'nor	59.878	54.006	17
R	Jason Plato (GB)	M	Renault Laguna	Williams Touring Car Eng	0 laps-acc dam-		53.391	8
R	Rickard Rydell (S)	M	Volvo S40	TWR Racing	0 laps-acc dam-		53.229	6

### FEATURE RACE

Pos	Driver	Result	Best lap	Qual	Grid
1	Warwick	47:48.716	59.123	53.538	11
2	Muller	47:56.223	57.601	53.062	8
3	Rydell	47:59.444	58.124	52.992	7
4	Menu	48:09.168	58.132	52.906	5
5	Plato	48:10.361	57.633	52.939	6
6	Radisich	48:13.073	58.142	53.576	13
7	Reid	48:14.746	57.836	52.465	1
8 (I)	Rustad	48:31.888	58.224	53.680	17
9	Leslie	48:32.510	57.935	52.889	4
10	Bintcliffe	48:34.737	57.864	53.618	15
11	Harvey	48:41.651	58.305	53.665	16
12 (I)	Gravett	44 laps	58.945	53.588	14
13	Baird	44 laps	58.431	53.693	18
14	Kox	44 laps	58.197	52.782	2
R	Hoy	26 laps-off	58.081	53.423	10
R (I)	Neal	23 laps-acc	58.457	no time	19
R	Thompson	21 laps-acc	58.050	52.881	3
R	Morbidelli	21 laps-acc dam 1	14.329	53.083	9
R	Cleland	0 laps-acc	-	53.570	12

(I) = Independent. M=Michelin, D=Dunlop. **Winner's average speed** Race 1-75.77mph; Race 2-73.41mph. **Fastest Laps** Race 1 - Leslie, 57.994, 80.698mph; Race 2 - Muller, 57.601, 81.249mph. **Laps led** Race 1: 1-22 Reid; Race 2: 1-8 Reid; 9-17 Menu; 18 Muller; 19-24 Baird; 25-45 Warwick. **Championship positions after 20 of 26 rounds** 1, Rydell, 196; 2, Reid, 161; 3, Menu, 159; 4, Thompson, 149; 5, Plato, 120; 6, Leslie, 118; 7, Cleland, 98; 8, Muller, 73; 9=, Warwick & Hoy, 57. **Manufacturers' Championship** 1, Nissan, 219; 2, Renault, 213; 3, Volvo, 203; 4, Honda, 173; 5, Vauxhall, 145; 6, Audi, 117; 7, Ford, 101; 8, Peugeot, 80. **AUTOSPORT Cup for Independents** 1, Rustad, 202; 2, Gravett, 170; 3, Neal, 154; 4, Moen, 92; 5, Lemmer, 70. **Scoring system** 15-12-10-8-6-5-4-3-2-1. Pole Position-1. Lap leader in feature race-1. **Next round** Brands Hatch, August 31.



# If we don't know about you...

# **AUTOSPORT** DIRECTORY

# Your presence is essential

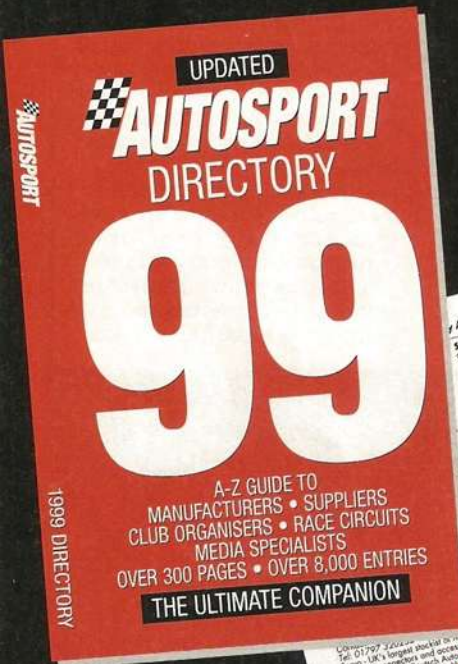

**Company logo £70 +VAT**

The 1999 AUTOSPORT Directory has the answers you need. It has been completely updated from last year, and now features a vastly-improved international content, all neatly contained in a comprehensive, easy-to-use, pocket-size format. This indispensable companion for competitors, industry and race fans provides unrivalled information on who does what, addresses, telephone and fax numbers

**Company profile**  
(up to 20 words)  
**£70 +VAT**

**Log plus profile for just**  
**£120 +VAT**  
**SAVE £20**

# For the ultimate impact in 1999 . . .

Contact Rachel Burdekin or Sean Worrell for display advertising options on:  
**Tel: 0181 943 5053 Fax: 0181 943 5850**



# the rest of the world won't!

Inclusion for your company in the 1999 Directory is **FREE**. Just fill in your company's details (right). However, to maximise the impact of your listing, the following additional facilities are available:

## PRICES

- **Company logo £70 + VAT.**

Please send black & white artwork or disk.

- **Company profile (up to 20 words) £70 + VAT.**

Additional words £2 + VAT each (see below)

- **Logo plus profile for just £120 + VAT.**

**SAVE £20**

Company name:.....

Address:.....

Postcode:..... Country:.....

Contact name:.....

Telephone:..... Fax:.....

e-mail:..... web site:.....

I enclose payment of £..... by cheque/postal order

(payable to Haymarket Publishing Ltd) or please debit my

Access  Visa  Amex

Credit card no:.....

Expiry date:.....

Name of card holder:.....

Signature:.....

AUTOSPORT offers you the opportunity to receive information from other organisations about their products and services. Please tick if you do not wish to participate.   
Please tick boxes as appropriate. All above rates are fixed and pre-payment is required

## CLOSING DATE NOVEMBER 1

- |  |   |   |   |  |
|--|---|---|---|--|
| <input type="checkbox"/> Accessory shops               | <input type="checkbox"/> Computers                      | <input type="checkbox"/> Helicopters & aviation     | <input type="checkbox"/> Motor manufacturers      | <input type="checkbox"/> Seatbelts & harnesses   |
| <input type="checkbox"/> Accountants                   | <input type="checkbox"/> Consultancies                  | <input type="checkbox"/> Helmets & accessories      | <input type="checkbox"/> Motorsport accessories   | <input type="checkbox"/> Seats                   |
| <input type="checkbox"/> Aerofoils                     | <input type="checkbox"/> Cooling equipment              | <input type="checkbox"/> Historic racing & rallying | <input type="checkbox"/> Moulding & moulds        | <input type="checkbox"/> Security                |
| <input type="checkbox"/> Air filters                   | <input type="checkbox"/> Couriers                       | <input type="checkbox"/> Honing                     | <input type="checkbox"/> Museums                  | <input type="checkbox"/> Spares & accessories    |
| <input type="checkbox"/> Air lines and tools           | <input type="checkbox"/> Data acquisition and telemetry | <input type="checkbox"/> Hose fittings & pipings    | <input type="checkbox"/> Nuts & bolts             | <input type="checkbox"/> Spark plugs & leads     |
| <input type="checkbox"/> Alloy products                | <input type="checkbox"/> Designers                      | <input type="checkbox"/> Hospitality services       | <input type="checkbox"/> Oil & fuel               | <input type="checkbox"/> Spherical joints        |
| <input type="checkbox"/> Artists                       | <input type="checkbox"/> Diagnostics equipment          | <input type="checkbox"/> Hotels                     | <input type="checkbox"/> Oil tanks                | <input type="checkbox"/> Sponsorship services    |
| <input type="checkbox"/> Auctioneers                   | <input type="checkbox"/> Differentials                  | <input type="checkbox"/> Ignition services          | <input type="checkbox"/> One make specialists     | <input type="checkbox"/> Storage                 |
| <input type="checkbox"/> Awnings                       | <input type="checkbox"/> Driver management              | <input type="checkbox"/> Industrial cleaners        | <input type="checkbox"/> Paint                    | <input type="checkbox"/> Supporters clubs        |
| <input type="checkbox"/> Axles                         | <input type="checkbox"/> Dynamometers                   | <input type="checkbox"/> Instruments                | <input type="checkbox"/> Photographers            | <input type="checkbox"/> Suspension & steering   |
| <input type="checkbox"/> Balancing services            | <input type="checkbox"/> Electrical systems             | <input type="checkbox"/> Insurance services         | <input type="checkbox"/> Plant hire               | <input type="checkbox"/> Teams, race & rally     |
| <input type="checkbox"/> Batteries & chargers          | <input type="checkbox"/> Engine components              | <input type="checkbox"/> Intercoms                  | <input type="checkbox"/> Plastics                 | <input type="checkbox"/> Television & video      |
| <input type="checkbox"/> Bearings                      | <input type="checkbox"/> Engineering services           | <input type="checkbox"/> Kart circuits              | <input type="checkbox"/> Plating                  | <input type="checkbox"/> Temperature monitoring  |
| <input type="checkbox"/> Belts                         | <input type="checkbox"/> Engine manufacturers           | <input type="checkbox"/> Karting schools            | <input type="checkbox"/> PR & promotion           | <input type="checkbox"/> Testing & circuit hire  |
| <input type="checkbox"/> Blast cleaning                | <input type="checkbox"/> Engineering manufacturers      | <input type="checkbox"/> Kart manufacturers         | <input type="checkbox"/> Printers                 | <input type="checkbox"/> Tickets                 |
| <input type="checkbox"/> Bodyshells                    | <input type="checkbox"/> Exhausts                       | <input type="checkbox"/> Kart specialists           | <input type="checkbox"/> Propshafts               | <input type="checkbox"/> Timing equipment        |
| <input type="checkbox"/> Body styling                  | <input type="checkbox"/> Exhibitions                    | <input type="checkbox"/> Lamps & lights             | <input type="checkbox"/> Quick release fittings   | <input type="checkbox"/> Tools                   |
| <input type="checkbox"/> Brake systems                 | <input type="checkbox"/> Fabrications                   | <input type="checkbox"/> Legal services             | <input type="checkbox"/> Race & rally car dealers | <input type="checkbox"/> Trailers & transporters |
| <input type="checkbox"/> Cables                        | <input type="checkbox"/> Fasteners                      | <input type="checkbox"/> Liveries                   | <input type="checkbox"/> Race car construction    | <input type="checkbox"/> Transportation          |
| <input type="checkbox"/> Car covers                    | <input type="checkbox"/> Finance                        | <input type="checkbox"/> Maps                       | <input type="checkbox"/> Race & rally car hire    | <input type="checkbox"/> Travel companies        |
| <input type="checkbox"/> Car/van hire                  | <input type="checkbox"/> Finishes                       | <input type="checkbox"/> Marquees                   | <input type="checkbox"/> Race & rally preparation | <input type="checkbox"/> Trophies                |
| <input type="checkbox"/> Castings                      | <input type="checkbox"/> Fire extinguishers             | <input type="checkbox"/> Marshals                   | <input type="checkbox"/> Race & rally schools     | <input type="checkbox"/> Tuning                  |
| <input type="checkbox"/> Carburettors & fuel injection | <input type="checkbox"/> Flight cases                   | <input type="checkbox"/> Media & publications       | <input type="checkbox"/> Racewear                 | <input type="checkbox"/> Turbocharger systems    |
| <input type="checkbox"/> Championship organisers       | <input type="checkbox"/> Foundries                      | <input type="checkbox"/> Medical/First Aid          | <input type="checkbox"/> Racking systems          | <input type="checkbox"/> Tyre companies          |
| <input type="checkbox"/> Chemicals                     | <input type="checkbox"/> Freight forwarding & carnet    | <input type="checkbox"/> Memorabilia                | <input type="checkbox"/> Restoration              | <input type="checkbox"/> Valves                  |
| <input type="checkbox"/> Circuits                      | <input type="checkbox"/> Fuel tanks                     | <input type="checkbox"/> Merchandising              | <input type="checkbox"/> Rod ends                 | <input type="checkbox"/> Wheel manufacturers     |
| <input type="checkbox"/> Clothing                      | <input type="checkbox"/> Glass & carbon fibre           | <input type="checkbox"/> Metal stockholders         | <input type="checkbox"/> Roll cages               | <input type="checkbox"/> Windscreens             |
| <input type="checkbox"/> Clutches                      | <input type="checkbox"/> Gearbox specialists            | <input type="checkbox"/> Models                     | <input type="checkbox"/> Rolling roads            | <input type="checkbox"/> Wind tunnels            |
| <input type="checkbox"/> Communication systems         | <input type="checkbox"/> Heat exchangers                | <input type="checkbox"/> Monocoques                 | <input type="checkbox"/> Radiators                | <input type="checkbox"/> Wings                   |
| <input type="checkbox"/> Component & kit cars          | <input type="checkbox"/> Heat treatment                 | <input type="checkbox"/> Motor clubs                | <input type="checkbox"/> Sealing technology       | <input type="checkbox"/> Wiring                  |
|  |   | <input type="checkbox"/> Motor homes                |   | <input type="checkbox"/> Workshop & equipment    |

**If you want a company profile, fill in the boxes below as required**

→					

**Return to: AUTOSPORT Directory, 38-42 Hampton Road, Teddington, Middlesex, TW11 0JE**



## FORMULA 3000

**H**e looks just about old enough to drink champagne, but Nick Heidfeld is certainly getting a taste for the stuff. The 21-year-old German's second successive FIA

Formula 3000 victory - and his third of the season - was the product of a fantastic start and, perhaps, just a touch of luck.

From third on the grid Heidfeld sprinted alongside poleman Stephane Sarrazin as they shaped up for Turn One.

'I was a bit surprised,' said Sarrazin, 'because I made a pretty good start myself. I think I was just about in front when we got to the corner, but I was on the dustier part of the track and Nick got round me.'

Overtaking is a rare commodity at the Hungaroring, so Heidfeld had achieved more than he dared hope for within the first 200 metres. It wasn't to be a particularly easy afternoon, however.

'Physically, it's very difficult here,' he said. 'It's hot, it's a long race and there is absolutely no time to rest; the circuit is like one big, long corner. On top of that, I could never relax because Stephane never gave up. I thought that by mid-race he might ease off a bit, but he was always there, pushing hard.'

The leader's biggest fright was provided not by the man behind



Sutton

Heidfeld edges past Sarrazin at Turn One

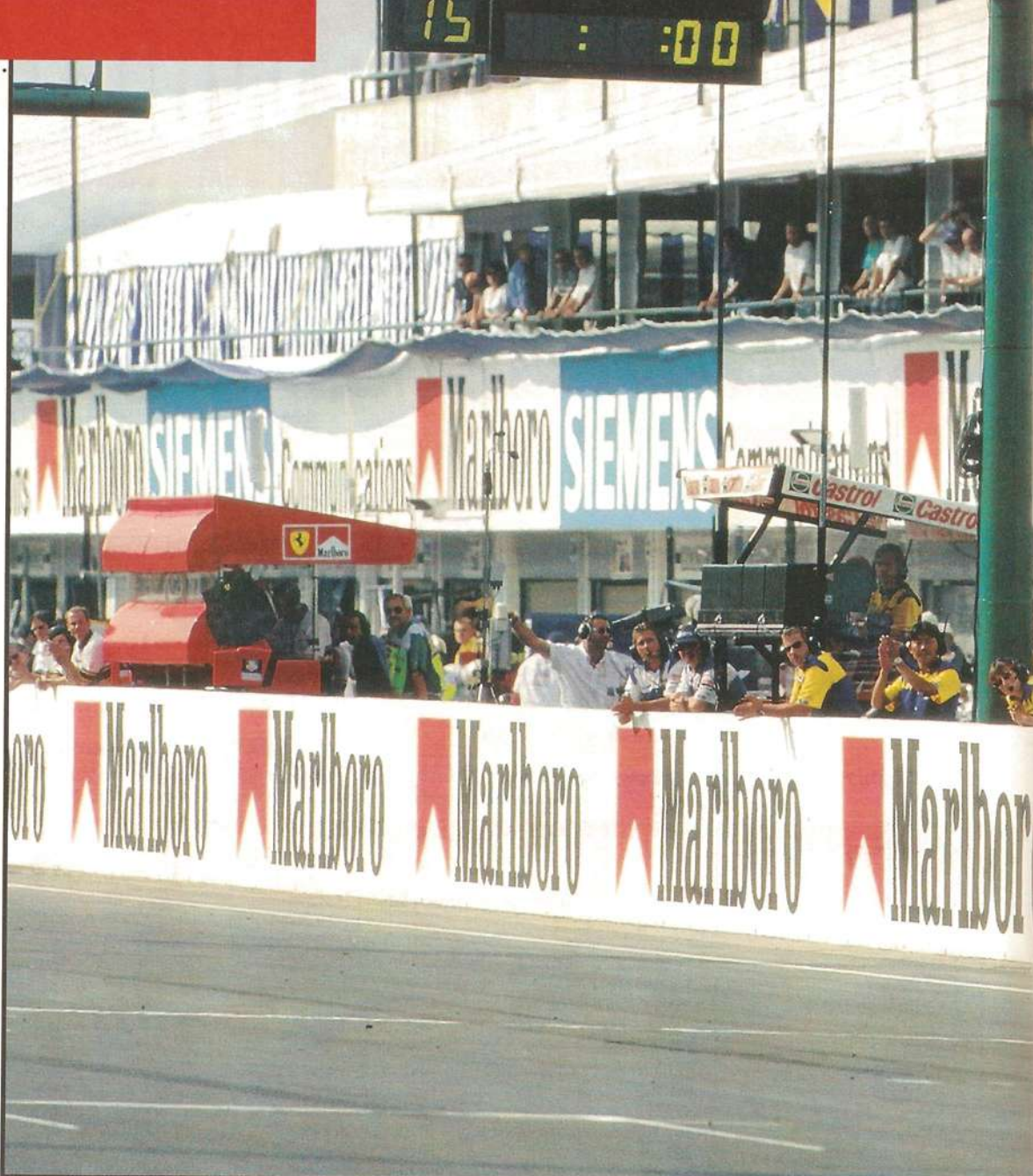

# Heidfeld Hungary

him, but by one in front. On lap 31, the leaders were working their way through the stragglers when Heidfeld's compatriot, Alex Muller, spun in front of him. As Muller attempted to rejoin, he rolled across the leader's path and Heidfeld veered sharply onto the grass to avoid him.

'It was a scare,' said Heidfeld. 'I thought there was room to pass and then his car started to move. From where I was it felt like I was pretty close to hitting him.'

Even so, the incident cost him relatively little. Sarrazin closed to within a second, but the vagaries of lapped traffic soon allowed the

leader to double an advantage he kept to the end.

'It wasn't so much that the backmarkers were a problem,' said Sarrazin, 'it's just that overtaking in general is a problem here - no matter how much faster you are over the course of a lap. I was just very careful in the traffic. I wanted

to keep Nick under pressure, but I also wanted to make sure I finished.'

The two were in a class of their own and the result handed the championship initiative back to Heidfeld, as erstwhile points leader Juan Pablo Montoya trailed home a lonely third.

The Colombian had started from the dirtier side of the grid, and slipped from second to fourth as Heidfeld and the on-form Oliver Martini sprinted past. Martini showed his finest F3000 form yet, and held on to third until lap six when he spun at Turn 12. The incident cost him only six seconds - enough to drop him to seventh, though he eventually recovered to take his first point of the year.

'My best hope was that I could push him into a mistake,' said Montoya. 'When he spun, I had a clear road, so I pushed to see if I could catch the first two. I was

getting nearer for a couple of laps, but with full tanks the effort completely killed my tyres. After that, there was nothing I could do.'

In public, the Colombian denied that the amount of time he has spent in the Williams Formula 1 car recently has affected his F3000 preparations, but there were factions within the Super Nova team which felt his current familiarity with superior braking distances is leading him to overwork his tyres a little.

After Martini's spin, the top five places remained unchanged all afternoon. Nicolas Minassian made another good start - fast becoming a trademark - and spent most of the race straining to keep Andre Couto behind him.

'It was real pressure,' said Minassian. 'This was one of the most demanding events I have driven, because Couto was there for



Juan Pablo Montoya (left) fights hard to keep Nicolas Minassian at bay

Sutton



## Qualifying

*Sarrazin sneaked his first pole from under Heidfeld's nose*

It would, in all probability, have been one hell of a lap. Championship leader Juan Pablo Montoya was certainly convinced of as much and was riled that archrival Nick Heidfeld had held him up in the last couple of corners.

'It was totally deliberate,' stormed the Colombian. 'He saw me coming and blocked my path.'

Montoya was forced to slow and stretched as far out of the cockpit as his belts would allow to give Heidfeld a traditional gesture of annoyance. Even so, his time on that lap would have placed him fourth on the grid.

'I don't know why he was so upset,' said Heidfeld. 'I was only doing what he and everyone else was doing, trying to create some room for a fast lap of my own. It was a problem for everyone out there - and he is still on the front row.'

The series pacesetters lined up second and third as Stephane Sarrazin stole in to take his first Formula 3000 pole.

'We seem to have found a very



Sarrazin: 'The car feels really good'

good balance for hot conditions,' said the Frenchman. 'The year has been up and down, but in the past few weeks we have really got on top of the situation and the car feels really good now. I'm not worried about the two guys racing for the championship lining up behind me. I'm just going to concentrate on making a good start and hope I'll be able to get away.'

Not for the first time this year, race stewards took a dim view of drivers failing to take sufficient notice of yellow flags, with the result that seven of them had their fastest practice times disallowed.

Among the offenders was Jamie Davies, who had been the quickest Brit until he was summoned to see the stewards. He entered their room in 14th place and left it 25th.

Gareth Rees started 20th in a car built up around a new tub after a practice off. Gravel traps beckoned for Kevin McGarrity, who missed the first session because of a clutch fluid leak, and Christian Horner, who was caught out when his rear axle locked. Mark Shaw lined up 27th, but his team mate, David Cook, failed to start after crashing heavily and wrecking his chassis.



The West driver takes the flag in a race he led from the first corner after a superb overtaking manoeuvre

# for success

*A brilliant start at the Hungaroring gave Nick Heidfeld his third F3000 win. Simon Arron reports*

over half the race, right behind me. I could not shake him off at all until the closing stages, but eventually I managed to get away a bit. It was only when I crossed the line and relaxed that I suddenly realised how tiring it had been.'

One man on the move in one of the most static sporting events of

the 20th century was Gonzalo Rodriguez. The Uruguayan started 11th and picked his way through to seventh, but he felt he could have done more if his final conquest had not been a little costly.

'The last place I gained was when I passed Cyrille Sauvage,' he explained. 'We touched - and it was

quite a big touch. I climbed up over his sidepod and he went across the kerbs. I think I must have bent something in the steering because the car was getting heavier and heavier to drive in the final laps. I got quite close to Martini, but the way the car was I was never going to be able to pass him. It was so

**“ It was a scare. From where I was it felt like I was pretty close to hitting Muller ”**

NICK HEIDFELD



Splash it all over. The winner takes his penance from Sarrazin (left) and Montoya (right)



Czech it out

Newcomer Thomas Enge proved he'll be a man to watch in future

Formula 3000's only Czech, Thomas Enge, finished an inconspicuous 12th at the Hungaroring last weekend – but his overall performance was enough to set tongues wagging.

Modest though the final result was, Enge had shown a surprising turn of speed during qualifying for what was only his second F3000 race.

He was fifth after the opening practice session and seventh after the second, so was invited to attend the pole position press conference as this week's special guest/novelty item. Sadly, he missed the unexpected PR opportunity as he had already been hauled away by the stewards as one of several drivers estimated to have lapped too quickly under yellow flags.

By the time he emerged from his dressing-down the conference had finished and he found himself relegated to 15th on the grid.

'I am sad and happy at the same time,' he said. 'Obviously, it is not good to be pushed back, but I accept the decision completely. I was one of several drivers to be

punished and that's just part of life. I didn't deliberately do anything wrong and I will know better next time.

'At least I can draw satisfaction from the fact that I know how fast I could go.'

In the race, the Auto Sport Racing driver was happy to finish 12th after a tardy start.

'I know that this isn't the result we could have achieved,' he said, 'but to me today it was important just to finish. Every kilometre I cover is absolutely vital because I have not done any testing at all yet – and there is no prospect of my doing any until after the Enna race in September.'

Most people assumed that Enge's perky performance had something to do with previous circuit experience, but the recent German Formula 3 Championship refugee winced at the suggestion.

'I admit I have been here once before,' he said, 'but that was five years ago – in a Ford Fiesta. I have to tell you that I was a little apprehensive about coming back because last time I was here I was really hopeless.'



Enge could have qualified as high as fifth had the stewards not penalised him



Having lost his lead at the off, Sarrazin kept the pressure on Heidfeld to finish second

'hard to drive at the end, I've got blisters all over my fingers, which has never happened to me before.'

Sauvage trailed in a distant eighth ahead of Oliver Tichy, who never recovered from a truly appalling start, and the unusually subdued Jason Watt, who simply never had the car balanced to his liking.

Luckiest escape of the day went to Soheil Ayari who somersaulted out of the race after tangling with Max Wilson on lap 10.

'When a weekend starts badly, it ends badly,' said Soheil, contemplating the wreckage while devouring a spectacularly rich-looking chocolate mousse. The Frenchman was down in the lower midfield after missing the opening qualifying session with a fuel pressure problem and he moved to pass Wilson after the Brazilian ran wide at the previous corner.

The French version of the story was that Wilson had turned in while Ayari was already alongside; the Brazilian counterpoint was that Ayari had tried a crazy move.

'I think Soheil liked our car so much when he tested last year that he was trying to get in it again,' said Peter Briggs, head of Wilson's team, Edenbridge, as he surveyed the tyre marks on Wilson's roll-hoop.

Once again, it was a bad race for the Brits. Gareth Rees didn't get to start after a driveshaft began leaking oil as he drove out of the paddock; this was believed to be an after-effect of the previous day's accident, which had the team up until 3.00am carrying out repairs.

Jamie Davies and Mark Shaw both made good starts, though Davies reckoned his would have been better still had he not been forced to run wide to avoid the spinning Gaston Mazzacane at the first corner. Thereafter, the two ran together all afternoon to finish 15th and 16th. Shaw enjoyed the chase in his most convincing F3000 race to date. 'I got close to Jamie a couple of times,' he said, 'but as soon as you ran a bit wide you got dirt all over your tyres.'

Kevin McGarrity tried the set-up

Hungaroring (H)

August 16, FIA Formula 3000 International Championship, round 9 of 11, 52 laps – 128.232 miles

No	Driver	Team	Result	Best lap	Qualifying	Grid
1	Nick Heidfeld (D)	West	1h 20m 14.689s	1m 31.174s	1m 29.576s	3
2	Stephane Sarrazin (F)	Apomatox	1h 20m 17.407s	1m 31.607s	1m 29.471s	1
3	Juan Pablo Montoya (COL)	Super Nova	1h 20m 43.145s	1m 31.460s	1m 29.532s	2
4	Nicolas Minassian (F)	West	1h 20m 52.686s	1m 32.170s	1m 30.614s	7
5	Andre Couto (MAC)	Prema	1h 20m 58.174s	1m 32.419s	1m 30.375s	6
6	Oliver Martini (I)	Auto Sport	1h 21m 01.147s	1m 32.217s	1m 30.298s	5
7	Gonzalo Rodriguez (UR)	Astromega	1h 21m 02.822s	1m 32.360s	1m 30.751s	11
8	Cyrille Sauvage (F)	GP Racing	1h 21m 19.507s	1m 32.902s	1m 30.615s	8
9	Oliver Tichy (A)	Coloni	1h 21m 27.460s	1m 32.386s	1m 30.195s	4
10	Jason Watt (DK)	Den Bla Avis	1h 21m 29.824s	1m 32.853s	1m 30.670s	10
11	Marcelo Battistuzzi (BR)	Apomatox	1h 21m 30.775s	1m 32.828s	1m 30.820s	12
12	Thomas Enge (CZ)	Auto Sport	1h 21m 30.978s	1m 32.732s	1m 30.943s	15
13	Thomas Biagi (I)	Prema	1h 21m 35.457s	1m 33.215s	1m 31.074s	18
14	Bertrand Godin (CDN)	Durango	1h 21m 35.783s	1m 33.215s	1m 31.245s	21
15	Jamie Davies (GB)	DAMS	51 laps	1m 33.260s	1m 31.657s	25
16	Mark Shaw (GB)	Redman Bright	51 laps	1m 33.308s	1m 31.974s	27
17	Werner Lupberger (ZA)	Edenbridge	51 laps	1m 33.304s	1m 31.489s	24
18	Dominik Schwager (D)	RTL Oreca	51 laps	1m 33.260s	1m 31.123s	22
19	Giovanni Montanari (I)	Draco	51 laps	1m 33.345s	1m 31.680s	26
20	Alex Muller (D)	RTL Oreca	51 laps	1m 33.043s	1m 31.394s	23
21	Giorgio Vinella (I)	Coloni	50 laps	1m 33.994s	1m 32.163s	29
22	Kevin McGarrity (GB)	Nordic	48 laps - spin	1m 33.485s	1m 32.253s	31
R	Gaston Mazzacane (ARG)	Astromega	42 laps - brakes	1m 32.258s	1m 30.958s	16
R	Gregoire de Galzain (F)	DAMS	38 laps - spin	1m 33.494s	1m 32.073s	28
R	Fabrizio Gollin (I)	GS Team	34 laps - spin	1m 33.643s	1m 32.193s	30
R	Fabrice Walfisch (F)	Nordic	30 laps - accident	1m 32.900s	1m 30.877s	13
R	Christian Horner (GB)	Arden	27 laps - spin	1m 33.372s	1m 32.413s	32
R	Boris Derichebourg (F)	Super Nova	20 laps - accident	1m 32.775s	1m 30.618s	9
R	Bruno Junqueira (BR)	Draco	19 laps - accident	1m 32.675s	1m 30.928s	14
R	Max Wilson (BR)	Edenbridge	9 laps - accident	1m 32.913s	1m 31.045s	17
19	Soheil Ayari (F)	Durango	9 laps - accident	1m 33.038s	1m 31.129s	19
NS	Gareth Rees (GB)	Den Bla Avis	oil leak		1m 31.190s	20
NS	David Cook (GB)	Redman Bright	practice accident		1m 33.063s	3

All drivers using Lola T96/50 chassis powered by Zytek V8 engines.

Winner's average speed: 95.964mph. Fastest lap: Heidfeld, 1m 31.174s, 97.455mph. Championship positions: 1 Heidfeld 49; 2 Montoya 45; 3 Watt 24; 4 Sarrazin 19; 5 Molllekens 16; 6 Rodriguez 13; 7 Ayari 12; 8 Wilson 9; 9 Davies 8; 10 Rees 7; 11 Derichebourg, Minassian and Couto 5; 14 Biagi, McGarrity, Junqueira and Schwager 3; 18 Sauvage and Mazzacane 2; 20 Martini 1. Next race: Spa, Aug 29.



All in a day's work. The top three can relax

which had propelled team mate Fabrice Walfisch to previously unseen heights in qualifying, but it wasn't long before the Ulsterman realised it wasn't to his taste. Late in the race, he came under fire from Alex Muller and opted for a trip through the gravel rather than a collision. 'It wasn't worth it for 20th place,' he said. He went to the pits as a precaution with four laps to go, though he was classified 22nd.

Christian Horner was troubled by locking rear brakes, as in practice, and trailed around near the back until they jammed once too often, pitching him into the gravel. ■



#### SUPER RESIN POLISH

Widely acclaimed, this is the ultimate easy to use combination cleaner, polish and sealant. For all vehicle paintwork types, colours and finishes, including metallic and clearcoats.



#### EXTRA GLOSS PROTECTION

Super tough sealant for all paint types. Provides extra protection and durability of shine for clean and blemish-free paintwork, especially after using Autoglym Super Resin Polish.



#### CAR GLASS POLISH

Contains specialist cleaning and polishing constituents which quickly and easily remove all common contaminants leaving a crystal clear finish, inside and out.



#### INSTANT TYRE DRESSING

Spray onto soiled or weathered tyres for a new look natural sheen. Use on wet or dry tyres. For a less glossy finish wipe tyres with a cloth before drying occurs.



#### BODYWORK SHAMPOO CONDITIONER

Removes traffic film and grime without harm to polished paintwork. Forms a glossy water repellent barrier which protects and beautifies.



#### BUMPER CARE

Simple to use protective gel. Removes polish stains and ingrained grime from all unpainted exterior plastic and rubber trim, restoring original colour. Suitable for all colours.



#### LEATHER CARE CREAM

Contains natural oils and conditioners in purified water to gently clean, moisturise and protect leather upholstery against ageing, bleaching and cracking.



#### CAR INTERIOR SHAMPOO

A low foam cleaner with exceptional versatility. Removes stains and grime from upholstery, carpets, roof linings, vinyl, soft tops, leather and plastics.



#### CLEAN WHEELS

Super effective cleaner. Rapidly dissolves brake dust, traffic film, salt, grease and various forms of corrosion from alloy, steel and painted wheels and wheel trims.



#### VINYL & RUBBER CARE

Gently cleans all interior and exterior plastic, vinyl and rubber. Leaves a protective sheen to enhance appearance on fascias, vinyl roofs and similar areas.



#### ENGINE CLEANER

A powerful, non-corrosive, multi-surface cleaner for engines, components, wheels and machinery. Dissolves oil, grease, grime and traffic film from treated surfaces.



#### FAST GLASS

For rapid cleaning of glass, plastic, perspex and acrylic windows. Free of abrasives and silicones. Easily removes insects and bird droppings from paintwork and glass.



#### PERFECT POLISHING CLOTH

Specially developed, 100% cotton, lightweight material, free of synthetic fibres and exactly the right degree of weave density for polishing fine surfaces.



#### METAL POLISH

Imparts a brilliant long lasting finish on polishable metal surfaces, including chromium, stainless steel, copper, brass, aluminium and alloys.



#### AQUA-DRY

A unique material which actually out-performs natural chamois. Super absorbent, faster to use, longer lasting and less expensive. Store wet or dry.



#### INTENSIVE TAR REMOVER

Instantly dissolves tar spots on paintwork, plastics and synthetic fabrics. Use to remove oil, grease, silicones, fuel stains and resinous tree sap.



# Call Freephone 0800 515779



## Autoglym Premium Car Care

The Autoglym Premium Car Care range is internationally respected by enthusiasts and professionals alike.

That is why motor manufacturers such as Aston Martin, Jaguar, Lotus, McLaren, Mercedes-Benz UK and Rolls-Royce use Autoglym extensively for vehicle preparation and display. It also explains why over 600 cars at The British International

Motor Show are prepared for public scrutiny and media attention using Autoglym products.

To help you find the products you are looking for just telephone the Freephone number above.

Be ready to tell us your postcode and we will give you the name, address and telephone number of your nearest 5 Star Stockist who carries the widest Autoglym Premium Car Care range.

Phone anytime between 9am and 5pm, Monday to Friday and one of our operators will be ready to help.







# W I N T E R C H A

- ❑ Identical Van Diemen chassis
- ❑ Identical Audi 1.8 litre turbo engine
- ❑ 250 bhp with 20 sec of race overboost to 280bhp
- ❑ All cars prepared and run by Formula Palmer Audi
- ❑ Identical testing opportunity for all drivers
- ❑ Drivers can adjust wings, anti-roll bars, dampers, tracking
- ❑ Comprehensive Stack data acquisition system
- ❑ Data print-outs overlaid with fastest at every test, qual & race



## Overseas Drivers' Travel Package

- ❑ Met at London airport
- ❑ Transfer to hotel
- ❑ 25 nights' accommodation
- ❑ FPA transport provided
- ❑ Returned to London airport

Price: £1,500 + VAT







**FORMULA**  
**Palmer**



**Where talent comes first!**



# CHAMPIONSHIP

## Winter Series package includes:

- ❑ 5 races
- ❑ 2 circuits - Brands Hatch and Snetterton
- ❑ Separate qualifying session for each race
- ❑ 3 exclusive tests
- ❑ All races televised on Sky Sports, Eurosport, Star, Globosat
- ❑ Every driver with car featured on TV
- ❑ Extensive branding space on car and overalls
- ❑ Hospitality for driver and guest at each race
- ❑ 16 page A3 colour magazine including every driver
- ❑ One day Formula Palmer Audi technical training programme
- ❑ Tour of Benetton Formula One facility
- ❑ Formula Palmer Audi race overalls
- ❑ Formula Palmer Audi paddock jacket
- ❑ Formula Palmer Audi sweatshirt
- ❑ Discount at Grand Prix Racewear
- ❑ Awards Dinner with two places free of charge
- ❑ Prize fund £40,000
- ❑ Championship winner £20,000, 2nd £10,000, 3rd £5,000
- ❑ Shell Cup Award of £5,000 for best driver with no wings experience
- ❑ Minimum licence requirement National B

**Fixed Price £16,000 + VAT**

**Contact Gary Church**

**Tel: 01403 733233 Fax: 01403 733222**

## Schedule:

Seat Fitting at FPA Workshops	23 October
Car Livery at FPA Workshops	23 October
FPA Technical Training Day	26 October
Test 1	Brands Hatch 27 October
Round 1	Brands Hatch 1 November
Round 2	Brands Hatch 1 November
Test 2	Brands Hatch 4 November
Round 3	Brands Hatch 8 November
Round 4	Brands Hatch 8 November
Visit to Benetton Formula One Facility	10 November
Test 3	Snetterton 13 November
Round 5	Snetterton 15 November
Winter Championship Awards Dinner	16 November



**Formula Palmer Audi**  
ウインター・シリーズ

- ❑ 全5レース - 5回の予選 - 3回の独占テスト走行
- ❑ Van Diemen社のシャシーに、250馬力のAudiのエンジン
- ❑ 車のメンテナンス、修理はFormula Palmer Audiが受託
- ❑ 全戦テレビ放映
- ❑ シリーズチャンピオンの賞金は、20,000ポンド、2位は10,000ポンド、3位には5,000ポンド
- ❑ レース参加費用は、18,000ポンド+ 税金

詳細は Gary Church 電話番号  
Tel: +44 1403 733233 Fax: +44 1403 733222



**Séries de Inverno da**  
"Formula Palmer Audi"

- ❑ 5 Corridas - 5 Qualificações - 3 Testes Exclusivos.
- ❑ Chassi Van Diemen - Motores Audi com Resistência de Freio de 250 CV.
- ❑ Carros preparados e corridos por "Formula Palmer Audi".
- ❑ Cobertura de TV para todas as corridas.
- ❑ 1º Prêmio de £ 20.000, 2º Prêmio de £ 10.000 e 3º Prêmio de £ 5.000.
- ❑ Preço Fixo de £ 16.000 (+ imposto onde for aplicável).

Contactar: Gary Church  
Telephone: +44 1403 733233  
Tel: +44 1403 733233 Fax: +44 1403 733222



**Série Hiver**  
"Formula Palmer Audi"

- ❑ 5 courses - 5 de qualification - 3 essais exclusifs.
- ❑ Chassis Van Diemen, moteurs Audi - puissance au frein 250 de chevaux.
- ❑ Voitures préparées et engagées par "Formula Palmer Audi".
- ❑ Couverture télévisée de toutes les courses.
- ❑ 1er prix : £20 000, 2ème prix : £10 000, 3ème prix : £5 000.
- ❑ Tarif fixe de £16 000 (+ TVA quand il y a lieu).

Contactar: Gary Church  
Telephone: +44 1403 733233  
Tel: +44 1403 733233 Fax: +44 1403 733222



**"Formula Palmer Audi"-**  
Winterserie

- ❑ 5 Rennen - 5 Qualifikationsläufe - 3 Exklusiv-Tests.
- ❑ Van Diemen-Chassis, Audi-Motoren 250 Brems-PS.
- ❑ Vorbereitung und Management der Wagen durch "Formula Palmer Audi".
- ❑ Fernsehberichterstattung bei allen Rennen.
- ❑ 1. Preis 20000 GBP, 2. Preis 10000 GBP, 3. Preis 5000 GBP.
- ❑ Festpreis 16000 GBP (zzgl. MwSt. falls zutreffend).

Anspruchspartner Gary Church  
Tel: +44 1403 733233 Fax: +44 1403 733222



**Serie invernale**  
"Formula Palmer Audi"

- ❑ 5 corse - 5 eliminatorie - 3 test esclusivi.
- ❑ Chassis Van Diemen, motori Audi da 250 CV eff.
- ❑ Macchine preparate e gestite da "Formula Palmer Audi".
- ❑ Servizi televisivi per tutte le corse.
- ❑ Primo premio £Stg. 20.000, secondo premio £Stg. 10.000, terzo premio £Stg. 5.000.
- ❑ Prezzo fisso di £Stg. 16.000 (+ I.V.A. se pertinente).

Contactare Gary Church al n.  
Tel: +44 1403 733233 Fax: +44 1403 733222



See Nigel Mansell  
at the Finals

Book now!  
01327 857273

(Lines open Mon - Fri 8am - 7pm; Sat, Sun, Bank Hols 10am - 2pm)

Silverstone International Raceday

featuring the Auto Trader RAC

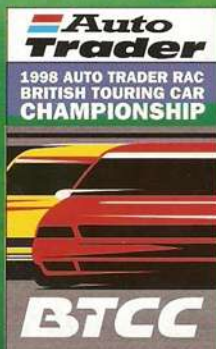

# British Touring Car Championship Finals

Sunday 20 September 1998

- Take advantage of our advanced ticket offer today – save money and secure the best seats.
- See and hear all the action on giant screens with live and unique Silverstone TV and Radio all day.
- Exciting track and air displays including the fabulous Red Arrows.
- Child admission (under 16) and Parking FREE!

in association with

**96.6**  
Today's Better Music Mix  
Northants



**Silverstone**™





Franchitti stroked his Team Kool Green Reynard-Honda to his maiden Champ Car victory at Road America last weekend. He now firmly believes that it will be the first of many

# I've got that first win at last

It was lovely to win my first Champ Car race at Road America, because it's my favourite course in the USA. We could have done it last year, but I went off under the yellow when I couldn't see because my visor was fogged up. I was trying to take the lead from Mark Blundell, but I slid off and crashed. Then I found out it was yellow.

Now I've finally got the first victory, I hope more will come because it definitely gives the team the quiet confidence it needs to know it can do the job. We need to get ourselves into gear for the 1999 season so we can be strong straight out of the box.

Having only got together last November, it took us a little while to fit in with each other well enough to be able to win races. We've been up there in most events, but little things have been getting in the way of wins. This one was for all the guys at Team Kool Green. I just hope it's the first of many.

It's nice to know you can win because, at the end of the day, we're not here to qualify, we're here to race. Next year, I feel we can do very well right from the start.

This is also the first year Team Green has run two cars. My team mate, Paul Tracy, did a good job last weekend, coming from the back of the grid to finish sixth. Once he gets qualifying sorted, everyone will have to watch out for him.

In Toronto last month, after I

**“This win was for all the guys at Team Kool Green. I just hope it's the first of many”**

**DARIO FRANCHITTI**



**DARIO FRANCHITTI  
CHAMP CAR DRIVER**

spun, I had the attitude, 'What have I got to do to win?' In Mid-Ohio two weeks ago, I couldn't quite believe it when I crashed at the first turn. It wasn't as bad as Toronto, but you've got all these guys out there trying to win and everyone's got their own idea how to go about it. Sometimes people get together like in Mid-Ohio. To come home in front you've got to get everything right.

When I got out of the pit lane after my last stop at Road America last weekend, I was looking for Michael Andretti in my mirrors and he wasn't there, so I put my foot down. Then, at the end of that lap when I saw the gap to Michael, I backed off a little bit.

It reminded me of Toronto, so I really slowed it down and left a lot of margin for error under braking. I

was slowing it down all the time, being really cautious with the brakes, watching for problems of any kind.

The only difficulty I had was when the throttle stuck in the Carousel. I turned in and lifted to get the front back in and the throttle pedal stuck. The car just kept charging to the outside. I got back on the straight and went down to Canada Corner as hard as usual, and it worked. It didn't do it again. That and the long brake pedal were the only dramas.

I was having a great time out there. I was just driving and enjoying it. I was savouring the feeling of being out front. It's nice when you can have a cushion and can relax. Then you can just concentrate on driving smoothly and not worrying about anyone behind you. Full marks to my engineer, Don Halliday. He's a genius. He translates what I say and so far we've got a very good language going.

The slowing-down lap was a great feeling. I really let the emotions go. It was also great after the event. Quite a few of the other drivers came past and gave me the thumbs up sign and a lot of guys from the other teams were coming up and congratulating me. That was nice. We had a great party on Sunday evening with all the guys from Team Green.

Now, we've just got to try to do it again and again. ■



# Is there life after McRae?

*Subaru has lost its star driver and its sponsor for 1999. Has the Banbury bubble burst? asks Keith Oswin*

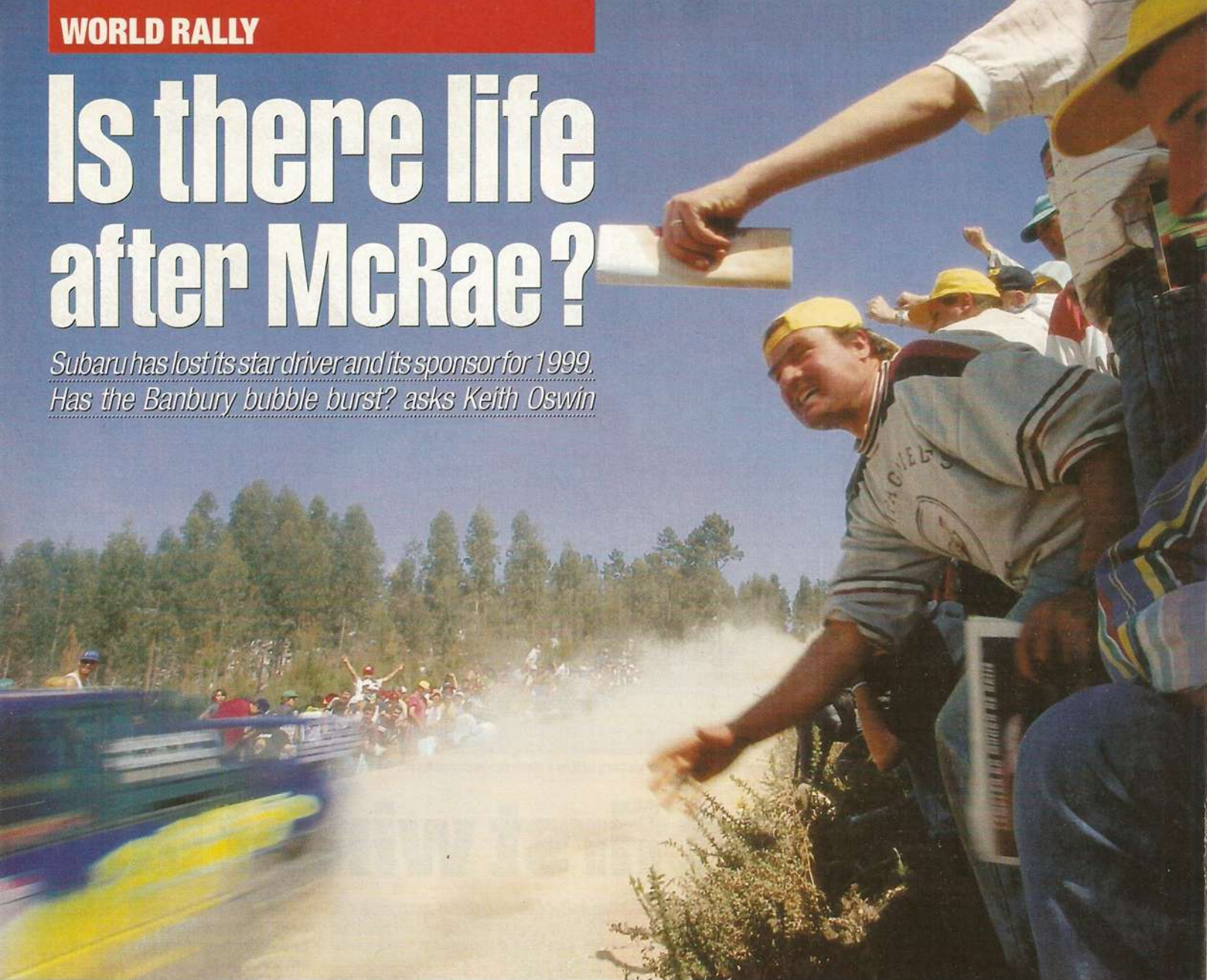

**W**hen Prodrive signed up a raw, uncultured Colin McRae for its 1991 British Rally Championship attack in the new Subaru Legacy RS, it was at best brave, at worst a folly. For all the hype about harnessing his talent, helping him mature and letting him develop into a star there were more than a few sceptical looks.

As has been proved several times since, Prodrive boss David Richards's incredible vision and the Japanese manufacturer's faith in his judgement were richly rewarded.

Two British titles for the Scot came immediately, Richard Burns added a third a year later. Then Subaru burst onto the World Rally scene with a vengeance. McRae won in New Zealand (in 1993) and two years later the car maker took the first of its three successive world manufacturers' titles.

Now the party's over. Carlos Sainz came and went, McRae confirmed last week that he too has flown the nest for Ford's bag of gold in 1999 and, with British American Tobacco backing the BAR Formula 1 team next year, the 555 cash is fading away to nothing. On the face of it, the team can't hope to stay at the front of the pack, but the Anglo-Japanese part-

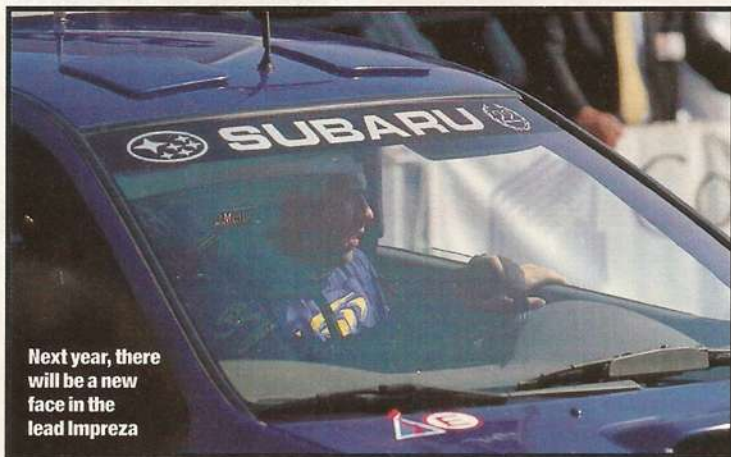

Next year, there will be a new face in the lead Impreza

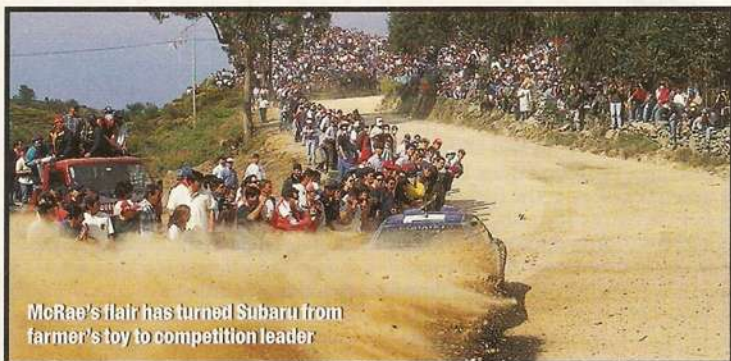

McRae's flair has turned Subaru from farmer's toy to competition leader

nership doesn't see things quite that way. In fact, not that way at all.

'The wheels most certainly haven't come off the wagon,' insists Prodrive's motorsport director, David Lapworth. 'It's true we've lost one of the best drivers in the world, no one would deny that. However, while we are only too willing to acknowledge the way that Colin has been crucial to our current position, you also have to remember that he's not the only driver to have won in our cars. Carlos Sainz, Kenneth Eriksson and Piero Liatti have all played their parts. The drivers for next season will as well.'

Lapworth is equally adamant that the likely departure of 555 from the flanks of the '99 car will not affect the team's performance. 'We've got several options available and we're talking to several people,' he says. 'Even if the car appears in plain white, we have the funds available to take on our rivals. Subaru has won the past three championships, we're working together to make sure we take a fourth this year and the company is already talking about a fifth, sixth and whatever. There's no lack of commitment and the money will be there, have no fear.'

With McRae, Sainz and Tommi Makinen already signed up to drive



for its rivals, will money be enough for the Imprezas to take on and beat the competition?

'I think so,' says Lapworth. 'We're all feeling pretty upbeat about the task ahead. There's nothing wrong with a team of up-and-coming drivers, we've proved that in the past, so just watch this space.'

McRae has said that one of the attractions of his move to Ford was to get his hands on a new car. Lapworth rails at this a little, suggesting that the Scot has been a touch naive if he doesn't think his current mount is a



Prodrive motorsport director David Lapworth is bullish, despite losing his star driver



The Impreza has shone in all conditions

new car. 'Of course it's been an Impreza for a while, but underneath it's every bit as new as the Ford or the Toyota or whatever. We had an Impreza WRC97, a WRC98 and we'll have a WRC99. It will have a new engine, new suspension, new transmission and a new bodyshell. That sounds like a new car to me.'

The team's driver line-up for 1999 will become known in the next few weeks. Richard Burns is virtually certain to take over McRae's role and the likes of Freddy Loix or Jarmo Kytölehto are rumoured to be joining him. One thing is for sure, however, Subaru is still fully focused on this year's championship, but is it still committed to the defecting Scot?

**“ We're feeling pretty upbeat about the task ahead, so watch this space ”**

DAVID LAPWORTH

ed, we can separate testing for this year from development of future parts or specification. Colin will be fully involved in the 1998 work, but, obviously, as we turn our attention to the '99 specification, he will be asked to step away from it. It's a logical thing to do and he would expect nothing less. But there's no question of us turning our backs on him just because he's leaving.

'We both want to part company as World Champions and that's what we're committed to for the rest of the season.' ■

'Absolutely,' insists Lapworth. 'Colin is our best points-scorer and so, if we want to win the title, we've got to give him nothing less than full support. If he wins the drivers' title, then it should give us a great chance of taking our fourth manufacturers' championship along with it, so we're not about to give up on him.'

'The way our team is structur-

**David Richards (right) gave McRae a break and reaped rich rewards**



The flying Scot has been a favourite with the fans, but will they defect to Ford with him?

All photos: McKelvie/LAT

## View from the top

Subaru is far from ready to throw in the towel. The company's chairman underlines his commitment to continuing the marque's winning ways

A familiar face on the World Rally Championship scene is that of Ryuichiro Kuze, chairman and founder of Subaru Tecnica International. Its successes have been a source of personal pride and he intends for them to continue.

'For Subaru the World Rally Championship is the best way to demonstrate product superiority. It uses all kinds of road surfaces around the world as its test fields, and demonstrates a superior technological prowess. The technology is then fed back to the mass-production vehicles to benefit the consumer.'

'Our achievement through this kind of competition is much better than just advertising.'

'Participation in the WRC is also an important element for making all the people involved, from the customers and the developers through to the sales people, feel proud of the company. Many years ago, our cars were just used as utility vehicles for farms and the countryside. Now our brand image has changed



Chairman Kuze collects one of four AUTOSPORT awards from the late Roger Clark

completely through the WRC. Our customers have the strong feeling that Subarus are highly desirable, attractive and a status symbol for their owners. This has all happened because our car has been constantly winning many rallies.

'I believe that owners of our cars worldwide share the honour of our world titles.'

'To be honest I did not expect any glimpse of the World Championship when we started with the Legacy in 1990, because of our lack of

experience and limited budget. Although it was not an easy route to success, we tried to gain knowledge with each event that passed, but this success was earlier than we expected and we began to build on our achievements.'

'In 1995, we gained the ultimate accolade as double World Champions, winning the drivers' and manufacturers' titles. We feel especially proud to win the manufacturers' championship. Subaru is not a giant automobile

company, but has competed with bigger manufacturers and I am very proud we won the trophy three times.

'I am sorry to lose Colin because he is a big part of the Subaru family and has helped us to achieve what we have today.'

'The World Rally Championship is a big investment for us and we intend to win our next title this year and many more after that. We are lucky to have had good partners who have shared in our success, and we will be sad to lose British American Tobacco (555). We have enjoyed much success together, but there are many more exciting rallies ahead with new partners.'

Our commitment to the World Rally Championship will continue and we will be making the same level of investment for the future. This will guarantee our status as a winning manufacturer and our right to be regarded as a successful car maker throughout the world.'

'Subaru has proved three times that it is the best in the world. We intend to carry on proving it!'



# FLYING SCOTSMAN

*Dario Franchitti drove a perfect race at Road America to take his first-ever Champ Car victory. By Gordon Kirby*



**D**ario Franchitti drove flawlessly from start to finish at Road America to finally take his first Champ Car laurels. The Scot has come close to winning a few times this year, but his luck held and was helped by rapid pit work from Team Green and exceptional fuel mileage.

The AUTOSPORT-backed 25-year-old beat championship leader Alex

Zanardi by seven seconds, as Barry Green's team took its first victory since Jacques Villeneuve's at Cleveland in 1995.

Franchitti said: "The first win is great. I hope it is one of many. It really dawned on me I could take this thing after the last pit stop, when I looked at the board and it said P1 +10 to Michael (Andretti). I said: "I've seen this before, in

Toronto!" I just slowed down. I had a long brake pedal, but it was consistent and I was cautious with the brakes. I kept an eye on the gap and I was slowing it down. The guys gave me great pit stops. That's what enabled me to get away from everyone else."

Another factor in the win was superb fuel mileage, which allowed the Scot to run one or two laps

longer than most of the other top contenders. "I was running very lean from the first lap to the last stop," he said. "The first time I ran full power was after the last stop. The fuel mileage was great, so were the tyres. I could run as fast as possible without having to worry."

Tyre warmers are not permitted in CART, and Franchitti said he put special effort into his first lap after





All photos: Ralph Harwick

**Dario Franchitti celebrates his first-ever Champ Car win, ending Team Green's three-year drought**

## CART World Series ● Rd 14: Rd America



**Greg Moore led part of the race but when his clutch failed his challenge ended in the pits**

out of the pits by him. The Scot's second stop was even better - he emerged with a 10-second lead over Andretti, who whittled away at the gap before a rear tyre blew halfway through the last lap, causing him to crash. The accident was nothing like as bad as the one he had experienced the previous Sunday at Mid-Ohio, but it cost him a valuable points-earning finish and handed second place to Zanardi.

'This is very, very disappointing,' he said. 'The tyre went down and I crashed. We're not sure whether debris caused the puncture. The car was good the entire race. We just lost the lead because we had to pit early because of tyre wear. We have been looking forward to this race because we had a car that could have won.'

Championship leader Zanardi enjoyed a strong race after starting from the sixth row and surviving an opening-lap collision with Al Unser Jr. The Italian ran into the back of Unser's car as the field funnelled into the second turn. Gil de Ferran collided with Scott Pruett as they braked for the corner. Although de Ferran and Pruett got safely through, the rest had to brake more heavily than normal. In the resulting smoke and excitement, Zanardi ran into the back of Unser, knocking the Penske driver into a spin. Patrick Carpentier also hit Unser's spinning car, eliminating both on the spot.

Zanardi had badly flat-spotted a tyre in the incident and immediately began to fade. He fell to 14th before having to stop under the green for fresh tyres after seven of the 50 laps. Thereafter, he used the subsequent yellows to work his way back into contention and was running third behind Andretti going into the last lap. His eventual second meant he was able to further pad his championship lead to 80 points over team mate Jimmy Vasser.

'It was a great race after the first lap,' Zanardi said. 'In the short run between turns one and two, I saw a puff of smoke. I slammed on the brakes and I couldn't see

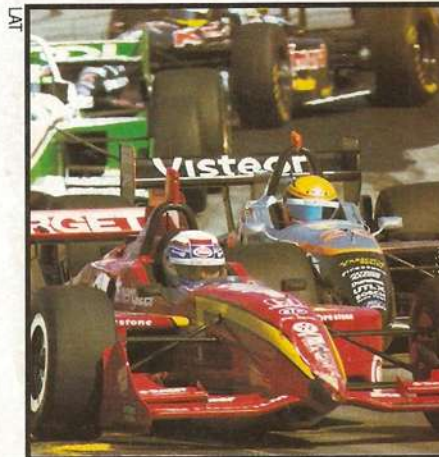

**Zanardi admits he was lucky to get second**

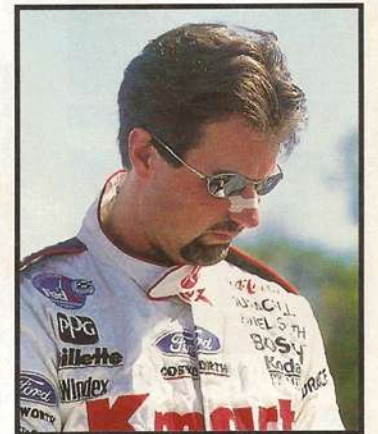

**Andretti crashed when a tyre blew out**

**“ It really dawned on me I could win this thing after the last pit stop ”**  
**DARIO FRANCHITTI**

leaving the pits each time on cold tyres. 'On each out lap, I went as fast as possible. I was just trying to keep the car on the track.'

The Scot has said a number of times that he believes he will be able to score more victories if he took one. Does he still believe that's true? 'I hope so. After the first, it isn't a big mystery anymore.'

He only had one scary moment

during the race. 'One time in the Carousel the throttle pedal stuck open and the car went wider and wider,' he said. 'I was able to keep it under control and at the next corner I was a little bit careful, but it didn't happen again.'

Polewinner Michael Andretti led the first half of the race before stopping for fuel one lap before Franchitti and then being beaten



**Having already been shunted by Zanardi, Unser's race was finished by Carpentier**



## RACING



HONDA CADET



COMER CADET



DEAVINSON FORMULA PRD



C.I.K. HOMOLGATED CHASSIS



98 EVO-II RACING PRO-KART



98 FORMULA TKM & YAMAHA

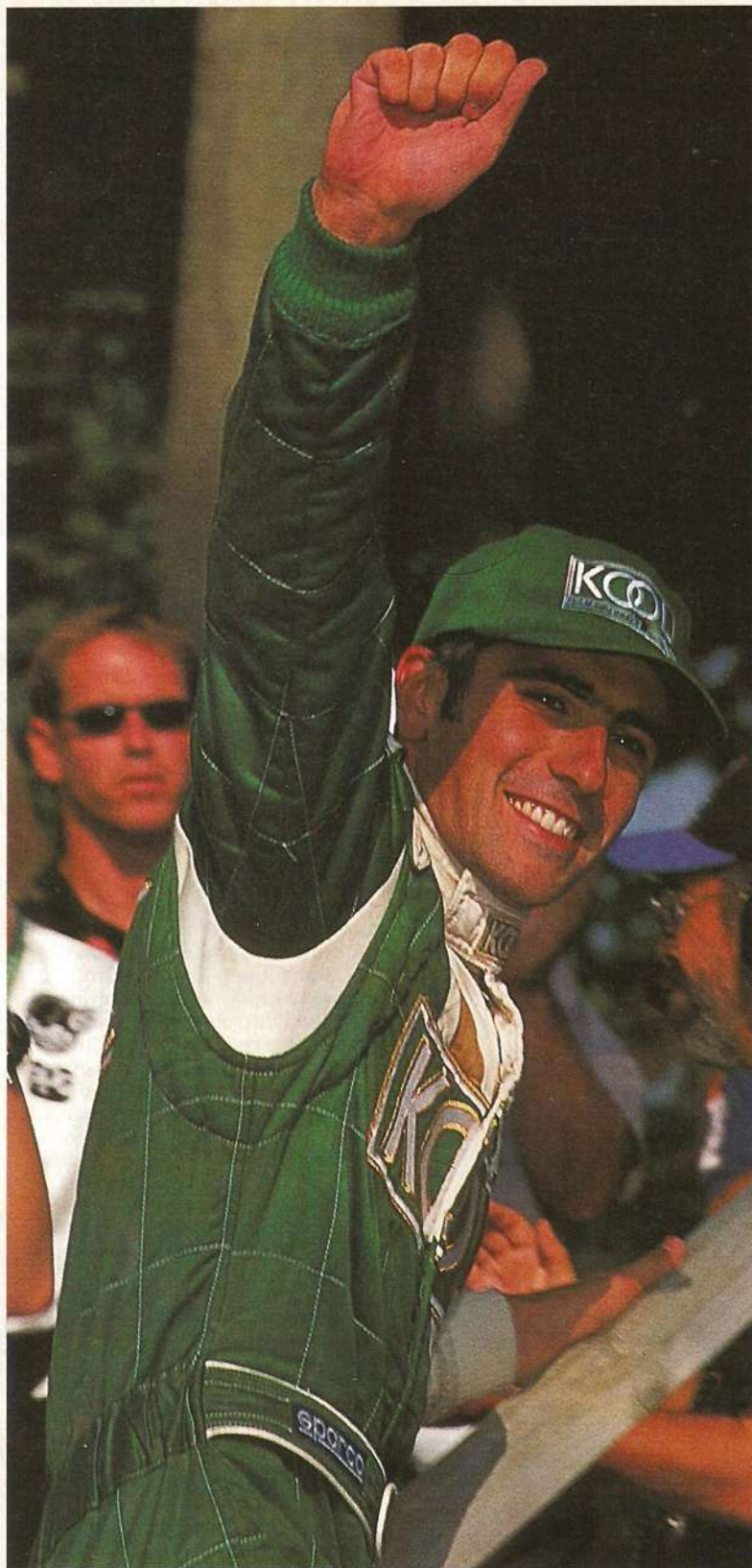

## LEISURE



RENTAL PRO-KART



INDOOR RENTAL KART



CHIEFTAN ATV



MUD BLASTER



JUNIOR GRASS KART



TWO SEATER

**Congratulations to Dario Franchitti  
on his first CART victory at Road America  
on August 16th  
From all at Deavinsons**



DEAVINSONS RACING, RYE HOUSE KART RACEWAY, RYE ROAD, HODDESDON, HERTS EN11 0EH, UK  
TEL: +44 (0) 1992 460895 • FAX: +44 (0) 1992 468812 • INTERNET: [www.deavinsons.co.uk](http://www.deavinsons.co.uk)

**ALL DRIVERS START SOMEWHERE...SOME START HERE**



Franchitti's pit stop brought him out 10s ahead of Andretti and won him the race

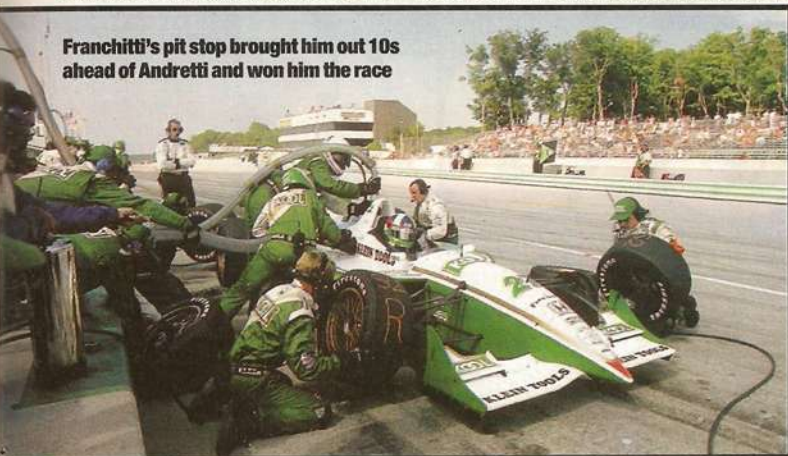

Top rookie Kanaan impressed in fourth

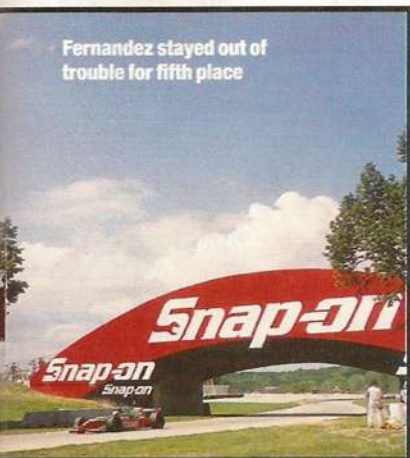

Fernandez stayed out of trouble for fifth place

without damage and continued to extend his lead in this year's rookie of the year standings over his primary rival Helio Castro Neves. The Mid-Ohio winner, Adrian Fernandez, finished fifth after suffering a stop-go penalty for speeding in the pit lane, while Franchitti's team mate, Paul Tracy, drove a steady, fast race to finish sixth from 17th on the grid.

Accidents eliminated a handful of frontrunners, including Bryan Herta. He was running third behind Andretti and Bobby Rahal in the opening laps when he spun and was hit by rookie Alex Barron. Greg Moore was running a strong second about a third of the way through the race when his clutch failed, ending his race in the pits. Gil de Ferran lost fifth with seven laps to go when his engine blew.

Zanardi can now wrap up his second Champ Car title at either of the next two races, in Vancouver or Laguna Seca next month. If he completes Vancouver with an 88-point cushion over Vasser, Fernandez or Moore, he will be this year's champion. ■

where I was going. In the next second, I ran into AJ Jr's car, and I'm very sorry I ruined his race. He had a good car and didn't get a chance to show it. I'm very disappointed, but it was just one of those things.

'I flat-spotted my tyres and all I could do was hang on and hope for a yellow,' Zanardi added. 'When I came in, my boys were very fast and Chip made the right call. After our early stop, we had to adopt a very aggressive race strategy and, fortunately, it paid off for us. I was very lucky today.'

A distant third went to Andretti's team mate, Christian Fittipaldi, who enjoyed his best race of the year. He was competitive, despite suffering a stiff neck. It started to stiffen up during the morning warm-up and required some medical attention and an ice pack prior to the start. He also had a problem on his first pit stop with the refuelling system that dropped him from sixth to 14th place before working his way back to third. This was Fittipaldi's best result since finishing in the same spot at Portland two years ago.

Rookie Tony Kanaan drove another impressive race to finish close behind Fittipaldi in fourth. Kanaan slid off the road at one point

## Qualifying

Michael Andretti was on cloud nine as he took his first pole in three years

An exciting battle for the pole at Road America was won by Michael Andretti, ahead of Rahal team mates Bryan Herta and Bobby Rahal.

It was Andretti's first pole position in 59 races, since the Long Beach GP in 1995 and was the first for an American-built car in 16 years.

'I'm so happy,' Andretti grinned. 'This feels as good as a win to me.'

Andretti had a clean, trouble-free qualifying session, something he's enjoyed rarely. 'It seemed like every time we were ready to get going, there was a yellow or something,' said the man who took Goodyear's first pole this year. 'That's the way it usually seems to go for me in qualifying and when that happened again at the beginning of the session, I said: "When am I going to catch a break?" But then it happened. Every lap I did was a clear one. Nobody got in my way and we were able to do it.'

'We had a great test here,' Andretti added. 'The tyre Goodyear developed for this race is fantastic, and the top four cars today are all powered by Ford. This is a bit of a horsepower track, so that should tell you something.'

Andretti and some other Goodyear-shod drivers had minor problems with blistering front tyres during practice and qualifying, but this appeared to have been cured by shaving the inside shoulder of the tyres.

'It doesn't seem to be a problem,' Michael said. 'It's only a little blister and we seem to have cured that. I feel my biggest problem tomorrow is going to be fuel mileage. This race is always about fuel mileage and we'll be trying to run the race on two rather than three stops, but a lot will depend on the yellows. We'll have to play our strategy based on how the yellows play out.'

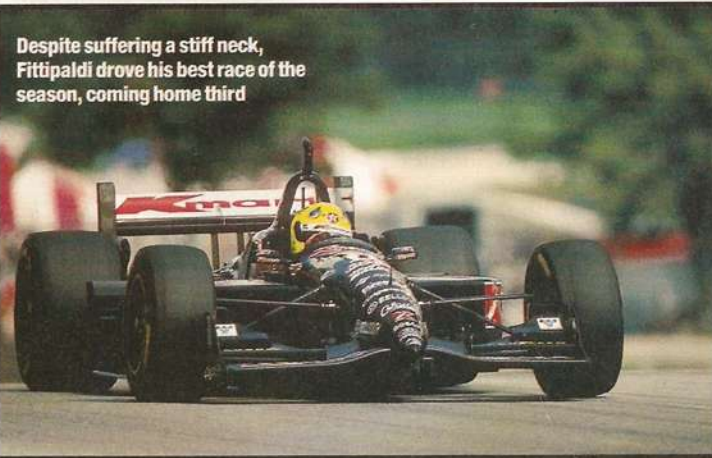

Despite suffering a stiff neck, Fittipaldi drove his best race of the season, coming home third

## Road America (USA)

August 16, FedEx CART Championship Series, round 14 of 19, 50 laps – 202.400 miles

Pos	Driver (Nat)	Team	Chassis/Engine	tyres	Result	Qual
1	Dario Franchitti (GB)	Team KOOL Green	Reynard-Honda 98I	F	1h35m30.767s	6
2	Alex Zanardi (I)	Target/Chip Ganassi	Reynard-Honda 98I	F	+7.102s	11
3	Christian Fittipaldi (BR)	Newman-Haas	Swift-Ford 009.c	G	+43.922s	7
4	Tony Kanaan (BR)	Tasman Motorsports	Reynard-Honda 98I	F	+46.134s	12
5	Adrian Fernandez (MEX)	Patrick Racing	Reynard-Ford 98I	F	+47.097s	9
6	Paul Tracy (CDN)	Team KOOL Green	Reynard-Honda 98I	F	+52.003s	17
7	Mark Blundell (GB)	PacWest Racing	Reynard-Mercedes 98I	F	+52.167s	15
8	Bobby Rahal (USA)	Team Rahal	Reynard-Ford 98I	F	+1m06.372s	3
9	Jimmy Vasser (USA)	Target/Chip Ganassi	Reynard-Honda 98I	F	+1m07.084s	14
10	Arnd Meier (D)	Davis Racing	Lola-Ford T98/00	G	+1m07.598	27
11	Max Papis (I)	Arciero-Wells	Reynard-Toyota 98I	F	+1m14.329s	19
12	Robby Gordon (USA)	Arciero-Wells	Reynard-Toyota 98I	F	+1m15.697s	23
13	Richie Hearn (USA)	Della Penna Motorsports	Swift-Ford 007.i	F	+1m19.338s	25
14	Michel Jourdain Jr (MEX)	Payton/Coyne	Reynard-Ford 98I	F	+1m38.024s	24
15	Michael Andretti (USA)	Newman-Haas	Swift-Ford 009.c	G	49 laps - contact	1
16	Gil de Ferran (BR)	Walker Racing	Reynard-Honda 98I	G	43 laps - engine	5
17	Gualter Salles (BR)	Payton-Coyne	Reynard-Ford 98I	F	41 laps - engine	20
18	JJ Lehto (FIN)	Hogan Racing	Reynard-Mercedes 98I	F	32 laps - exhaust	18
19	Mauricio Gugelmin (BR)	PacWest Racing	Reynard-Mercedes 98I	F	29 laps - brakes	21
20	Scott Pruett (USA)	Patrick Racing	Reynard-Ford 98I	F	24 laps - engine	4
21	Greg Moore (CDN)	Players Forsythe Racing	Reynard-Mercedes 98I	F	18 laps - transmission	8
22	PJ Jones (USA)	All American Racers	Reynard-Toyota 98I	G	14 laps - off course	28
23	Bryan Herta (USA)	Team Rahal	Reynard-Ford 98I	F	10 laps - contact	2
24	Alex Barron (USA)	All American Racers	Reynard-Toyota 98I	G	10 laps - contact	26
25	Andre Ribeiro (BR)	Marlboro Team Penske	Penske-Mercedes PC27	G	7 laps - engine	13
26	Helio Castro Neves (BR)	Bettenhausen M'sports	Reynard-Mercedes 98I	G	2 laps - header	22
27	Al Unser Jr (USA)	Marlboro Team Penske	Penske-Mercedes PC27	G	0 laps - contact	10
28	Patrick Carpentier (CDN)	Player's/Forsythe Racing	Reynard-Mercedes 98I	F	0 laps - contact	16

Winner's average speed 127.145mph. Scoring system 20-16-14-12-10-8-6-5-4-3-2-1. Championship positions 1, Alex Zanardi, 206; 2, Jimmy Vasser, 126; 3, Adrian Fernandez, 120; 4, Greg Moore, 118; 5, Michael Andretti, 93; 6, Scott Pruett 92; 7, Dario Franchitti, 88; 8, Bobby Rahal 80; 9, Bryan Herta & Gil de Ferran, 67; 11, Tony Kanaan, 58; 12, Paul Tracy, 54; 13, Al Unser Jr, 48; 14, Richie Hearn 36; 15, Helio Castro Neves, 33; 16, Christian Fittipaldi 32; 17, Mauricio Gugelmin 30; 18, Mark Blundell, 25, etc. Next round Vancouver (CDN), Sep 6. (G=Goodyear, F=Firestone)



**J**ust six races ago, Mario Haberfeld was floundering 54 points behind AUTOSPORT British Formula 3 Championship leader Enrique Bernoldi in third place in the table. At Pembrey on Sunday, the two Brazilians swapped at the head of the points.

Three non-finishes from Bernoldi had left him vulnerable and under pressure. On top of that, last weekend proved nearly perfect for Paul Stewart Racing's Haberfeld, and anything but so for Bernoldi.

The differing fortunes were obvious right from the start of race one. The tight Hatchets Hairpin first corner is always an accident blackspot at the 1.465-mile Welsh circuit, but usually it's the midfield that gets decimated. This time, it was Bernoldi's series lead that was the victim. Off the line, poleman Haberfeld and the Portman Arrows Dallara-Renault of Warren Hughes got away perfectly, but for the first time this season Bernoldi was tardy.

Into the braking area, Karthikeyan, who had also been slow away from third, locked up on the inside, but Bernoldi's Promatecme UK Dallara was on the grass on the exit and tumbled down the order. 'I could see he was behind me,' explained Haberfeld. 'I stayed inside and braked late. He went outside and braked too late on cold tyres.'

Bernoldi claimed he had been forced to go off. 'He braked too early, and for me to avoid him I had to go straight,' he shrugged. The Brazilian rejoined in seventh, with a lot of work to do.

Kristian Kolby had another nightmare start and was passed by three cars on the drag down to Hatchets. 'My initial getaway is fine,' he said. 'but when I apply the throttle, the back's just not sitting down and the wheels are spinning.'

The big winner in the first-corner-

# Masterful

*Mario Haberfeld finally overhauled erstwhile title leader Enrique Bernoldi with two fine drives. By Jaimes Baker*



Third in race one was a high for Spence



Second-placed Bernoldi ahead of Hughes in race two. Unfortunately, they would clash

shuffle was Jamie Spence, who leapt from a disappointing eighth on the grid to third. The Martin Donnelly Racing driver claimed he just 'drove round the outside of everyone' at Hatchets.

The annual midfield clash meant that Alan Docking Racing's Yudai Igarashi spun out for his first retirement of the year after a clash with new Intersport signing Adam Wilcox at Spitfires.

The cars were off in dangerous spots, and it looked as though the race would be stopped. In fact, the

red flag flew momentarily and the Renault team was jubilant that Bernoldi would get a second chance. Suddenly, the decision was changed and the safety car despatched instead.

Haberfeld had built up a significant lead over Hughes, and was now forced to do it all again. The safety car led the pack around for five laps and released them with 10 remaining. On the final safety car lap, Jamie Spence slowed to almost walking pace out of the Brooklands Hairpin to make sure he was up with the leaders and at racing speed at the point that the pace car pulled in. He misjudged it and was not up with Hughes until the first corner.

'Burti (behind) wasn't too happy with me,' he admitted. 'But I was trying to get past Warren.'

Bernoldi was immediately forcing the pace. Straight away the Brazilian squeezed by Karthikeyan to take sixth. 'I wasn't going to block him,' admitted the Indian. 'I just wanted to make sure I finished the race.'

Paul Stewart Racing's Luciano Burti was Bernoldi's next victim. The rookie was struggling with deteriorating tyres and Bernoldi

**“I stayed inside and braked late. He went outside and braked too late on cold tyres”**

MARIO HABERFELD

performed a textbook move. He got right under the PSR Dallara's rear wing through the fast Honda right-hander on to the main straight, then merely pulled to the inside and was later on the brakes into Hatchets. 'That move is really difficult,' Bernoldi pointed out afterwards, 'because through Honda, to get close enough to pass on the straight, you have to be so close that you lose half your downforce.'

As the 19-year-old reeled in Spence in third, Hughes seemed to be closing in on Haberfeld, but the Brazilian had just throttled back.



## Qualifying

*Even in qualifying, the two title chasers were neck-and-neck*

Championship leader Enrique Bernoldi had been satisfied after the qualifying sessions on Saturday. The Brazilian had finished second in each half-hour to plant his Dallara-Renault F397/8 on the front row for both races.

After his second place at Zandvoort in the Marlboro Masters the previous weekend, he had said his confidence would be high going into Pembrey following three non-finishes in Britain. It looked like he was right.

The title race was poised perfectly, with rival Mario Haberfeld on pole for race one and third for race two. Third Brazilian Luciano Burti's Paul Stewart Racing Dallara-Mugen Honda claimed top spot second time around. 'We went so well in the test a few weeks ago that I was disappointed after first qualifying,' admitted the 23-year-old. 'The conditions were very different from the test so we had to make quite a few changes. I'm sure Mario and Enrique will be careful with me. They have the title at stake, so they are probably the best people to have around me on the grid.'

The shock of qualifying was the spectacular form of Indian Narain



**Karthikeyan stunned in qualifying**

Karthikeyan. The 22-year-old Madras-born driver had missed most of the season with financial difficulties, but stepped in to the Carlin Motorsport team – which was also making its seasonal debut – and took third and fifth for the two races. 'My best-ever grid place in Formula 3 was 12th,' he said, 'so I'm really happy. The team has a lot of experience and did a great job.'

Warren Hughes was the only British interloper in the Brazilian-dominated grids. The Geordie got his towel on fourth spot both times, despite suffering from niggling problems in his Portman Arrows Dallara-Renault.

Other Briton Martin O'Connell had a miserable time in qualifying. The Walsall driver had arrived at Pembrey third in the title race. However, his swap back to the Rowan Racing squad began from ninth and 12th on the grid. 'The red flag came out on my flying lap in the second session,' he said. 'It wasn't a brilliant lap, but I could have been in the top six. Unless a miracle happens, it's a waste of time tomorrow.'

# Mario



**A jubilant Mario Haberfeld took the championship lead with a race win and second place at Pembrey**



**Third in second race was Marc Hynes's best finishing place since the third race of the year**

'Actually I was surprised to finish,' said Hughes. 'I had a throttle problem from the second lap. When I pressed it up to halfway I got nothing, then it all came in at once. Worse, it was intermittent.'

Bernoldi put massive pressure on Spence. He, though, was not about to relinquish his best finish of the season. Once the Brazilian had tried the move out of Honda and failed, the Essex lad was ready for him and held on to the delight of the MDR team. 'It is a move,' sighed Bernoldi, 'that does require surprise. Once that is gone it is almost impossible.'

Haberfeld, while delighted to have won, was cautious not to allow himself to enjoy his win until after the second race.

He needn't have bothered, as it proved almost as successful.

Once again, the lights flicked to green almost instantly and both Bernoldi and Burti made poor starts from the front row. Haberfeld immediately closed up from third spot and looked like he would be following his team mate through.

'I saw him coming,' said Bernoldi. 'so I moved in behind Burti. I



**No hands! Burti celebrates in fine style after taking only his second victory this year**



EXCLUSIVE  
**AUTOSPORT**  
READER OFFER



**Silverstone**<sup>TM</sup>

# INTERNATIONAL RACEDAY

19/20 September 1998

Featuring the final round showdown of the  
BRITISH TOURING CAR CHAMPIONSHIP

**From the best seat in the house**

Come and join us at the AUTOSPORT Tower  
overlooking the start/finish grid

**Price: £35 (inc. VAT) which includes**

- General admission
- Reserved seat in private  
AUTOSPORT Grandstand
- Programme
- AUTOSPORT gift pack

**CAN NIGEL MANSELL  
REPEAT FORD'S  
SILVERSTONE WIN**

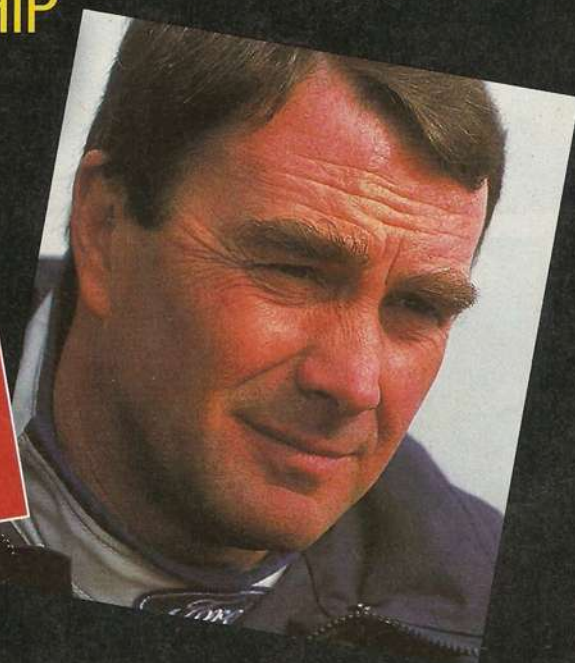

**AUTOSPORT  
TOWER**

**Don't forget the full TOCA support programme**  
Formula Fords, Renault Spiders, Formula Vauxhall Juniors,  
Vauxhall Vectras, Formula Renaults Sports

TELEPHONE THE TICKET HOTLINE NUMBER NOW ON

**0181 943 5076**

Places are strictly on a first come, first served basis



‘I don’t know what happened after that.’ What happened was that, having been right under his team mate’s rear wing, Haberfeld was suddenly on the grass. ‘Warren came alongside and I knew I had to finish, so I let him through,’ explained Mario.

So Burti led Bernoldi, from Hughes and Haberfeld. These four gradually began to pull away from Marc Hynes in fifth. He, in turn, had Karthikeyan and Alan Docking Racing’s Ricardo Mauricio for company, having lost Kristian Kolby, who was hit by an unknown assailant on the first lap.

The lead battle swung to and fro for nine laps as each driver took rests and then attacked again. Hughes made his move on Bernoldi into Hatchets on lap 10, and failed. ‘Enrique left a big gap,’ said the deflated Sunderland driver afterwards. ‘I could brake later than



Sutton Images

Hughes’s challenge on Bernoldi in race one at Hatchets ended with them both spinning, and left a very angry Brazilian

him, but when I got there the gap was gone. It was my fault.’

The Brazilian said he felt he was far enough ahead to not have to defend the line. ‘He was never in a position to pass,’ he said. ‘He came from a long way behind and hit me.’

Bernoldi rejoined in eighth, but Hughes had dropped to 13th.

The two PSR cars now circled together at the head of the field. Burti had said beforehand that there were no team orders, he was there to win. But still there was the chance that he may be ordered to

allow his team mate to go through.

However, even though Haberfeld towed right up to his sister car, the two Brazilians finished without any change of position. The end came three laps early, courtesy of Michael Bentwood’s stranded Dallara at Hatchets.

‘I backed off toward the end,’ said Burti, whose second win of the season it was. ‘I knew Mario wouldn’t try to pass me. He was leading the title and it was too much of a risk. Second was good for him.’

Bernoldi managed to get past Martin O’Connell for seventh, but Jamie Spence was too far away.

Marc Hynes will take heart from third. The Tetbury driver has had a miserable time since the clash with his team mate for the lead at Brands Hatch in April and he needed an injection of confidence to impress at the end of the season.

Karthikeyan, too, will be pleased with fourth, his best result of a difficult and disjointed season. John Ingram also deserves a mention. He started with a 10-second penalty, but still took the National Class win. He needed a fair chunk of luck to do so, as new champion and first race



A race win and the title lead. Not a bad day

winner Philip Scifleet required a new nose in the race and Steve Hayr was forced to start from the pit lane.

After the second round, Haberfeld finally allowed himself to relax. ‘Pembrey is the best circuit in the world right now,’ he joked. He had arrived with a 10-point deficit and was leaving with a 13-point lead. Bernoldi finds himself under real pressure for the first time this season. How he reacts to that in two weeks at Donington Park, where he won convincingly in the first race of the season, will probably dictate the destination of the title. ■



Pavicevic had his best weekend of 1998



Ryder/Sutton

No smoke without fire. Bernoldi demonstrates his determination to win behind Burti

## Pembrey (GB)



August 16, **AUTOSPORT British Formula 3 Championship**, rounds 11 & 12 of 16, 1x20 laps & 1x15 laps – 29.12 miles & 21.84 miles

### RACE 1

Pos	Driver (Nat)	Team	Chassis/Engine	Result	Best lap	Qual	Grid
1	Mario Haberfeld (BR)	Paul Stewart Racing	Dallara-Mugen Honda F397/8	20:27.416	50.696	50.287	1
2	Warren Hughes (GB)	Portman Arrows Racing	Dallara-Renault F397/8	20:29.471	50.826	50.926	4
3	Jamie Spence (GB)	Martin Donnelly Racing	Dallara-Mugen Honda F397/8	20:33.151	51.289	51.230	8
4	Enrique Bernoldi (BR)	Promatecme UK	Dallara-Renault F397/8	20:33.430	51.110	50.560	2
5	Luciano Burti (BR)	Paul Stewart Racing	Dallara-Mugen Honda F397/8	20:35.760	51.374	51.008	5
6	Narain Karthikeyan (IND)	Carlin Motorsport	Dallara-Mugen Honda F397/8	20:36.021	51.202	50.891	3
7	Ben Collins (GB)	Intersport	Dallara-Opel F398	20:37.011	51.437	51.199	7
8	Marc Hynes (GB)	Promatecme UK	Dallara-Renault F397/8	20:37.459	51.338	51.330	11
9	Kristian Kolby (DK)	Fortec Motorsport	Dallara-Mugen Honda F397/8	20:38.158	51.352	51.104	6
10	Ricardo Mauricio (BR)	Alan Docking Racing	Dallara-Mugen Honda F397/8	20:38.559	51.387	51.298	10
11	Martin O’Connell (GB)	Rowan Racing	Dallara-TOM’S Toyota F398	20:40.412	51.413	51.233	9
12 (N1)	Phillip Scifleet (AUS)	Rowan Racing	Dallara-TOM’S Toyota F395/6	20:47.771	52.125	52.022	18
13	Warren Hayr (NZ)	Rowan Racing	Dallara-TOM’S Toyota F398	21:20.855	52.839	52.316	19
14	Paula Cook (GB)	Portman Arrows Racing	Dallara-Renault F397/8	20:59.845	51.753	no time	23
15	Mark Boost (GB)	Speedsport	Dallara-Mugen Honda F397/8	21:12.762	52.385	51.942	17
16 (N2)	John Ingram (GB)	Speedsport	Dallara-HKS Mitsubishi F396	21:19.017	53.677	53.672	21
17 (N3)	Steve Hayr (NZ)	Tarry Falcon Racing	Dallara-Mugen Honda F396	21:20.855	54.528	54.939	22
18	Andrej Pavicevic (AUS)	Fortec Motorsport	Dallara-Mugen Honda F397/8	18 laps - running	51.614	51.668	15
R	Tim Spouge (GB)	SS Sport	Dallara-Mugen Honda F398	19 laps - spin	52.962	51.493	14
R	Lei Kit Meng (MAC)	Carlin Motorsport	Dallara-Mugen Honda F397/8	4 laps - spin	54.409	53.023	20
R	Yudai Igarashi (J)	Alan Docking Racing	Dallara-Mugen Honda F397/8	0 laps - accident	no time	51.399	12
R	Michael Bentwood (GB)	Speedsport	Dallara-Mugen F397/8	0 laps - accident	no time	51.463	13
R	Adam Wilcox (GB)	Intersport	Dallara-Opel F397/8	0 laps - spin	no time	51.898	16

### RACE 2

Pos	Driver	Result	Best lap	Qual	Grid
1	Burti	13:00.777	51.256	50.727	1
2	Haberfeld	13:01.179	51.181	50.819	3
3	Hynes	13:03.328	51.326	51.241	7
4	Karthikeyan	13:04.191	51.324	51.169	5
5	Mauricio	13:04.534	51.297	51.180	6
6	Spence	13:06.458	51.405	51.395	11
7	Bernoldi	13:08.680	51.278	50.763	2
8	O’Connell	13:09.989	51.475	51.451	12
9	Collins	13:10.918	51.588	51.267	9
10	Pavicevic	13:11.360	51.568	51.294	10
11	Igarashi	13:11.879	51.653	51.654	15
12	Bentwood	13:14.719	51.732	51.602	13
13	Hughes	13:14.863	51.232	50.861	4
14	Wilcox	13:17.890	51.977	51.730	16
15	Spouge	13:18.317	51.732	51.771	17
16	Cook	13:30.298	51.882	51.789	18
17	Carway	13:31.545	52.780	52.336	20
18	Meng	13:32.946	52.765	53.213	21
19 (N1)	Ingram	13:50.130	53.857	no time	23
20 (N2)	Hayr	14 laps - running	54.474	54.355	22
21	Kolby	14 laps - running	51.293	51.250	8
22 (N3)	Scifleet	12 laps - running	51.978	52.004	19
R	Boost	0 laps - accident	no time	51.654	14

Winner’s average speed Race 1: 85.40mph, Race 2: 100.69mph. Scoring system 20-15-12-10-8-6-4-3-2-1 +1 point for fastest lap. Championship positions after 12 of 16 rounds 1, Haberfeld, 146; 2, Bernoldi, 133; 3, Burti, 109; 4, Hughes, 107; 5, O’Connell, 99; 6, Mauricio, 63; 7, Spence, 54; 8, Darren Manning, 49; 9, Hynes, 47; 10, Kolby, 41; 11, Collins, 35; 12, Yong, 27; 13, Karthikeyan, 20; 14, Wilcox, 14; 15, David Cook, 10; 16= Igarashi & Pavicevic, 8; 18, P Cook, 7; 19, Spouge, 6; 20, Miku Santavirta, 1. National Class 1, Scifleet, 247; 2, Carway, 97; 3, Hayr, 54; 4, Ingram, 35; 5, Stephen White, 12. Next round Donington Park Aug 4.



# Simon bursts through for Supercup glory

*Germany's Patrick Simon shed his mantle of bad luck to win the Porsche Supercup race at the Hungaroring*

**G**erman driver Patrick Simon won last Sunday's Porsche Supercup race at the Hungaroring and in one fell swoop retrieved a season that had previously yielded nothing but disappointment.

Points leader Patrick Huisman was again the pacesetter in qualifying and secured his fifth consecutive pole position. At the same time though, 23-year-old Simon was serving notice of his intent by being second fastest.

Simon didn't hang around at the start of the race either. He rocketed his PZK Team Zakspeed past Huisman on the run down to the first corner, while Dirk Muller got the jump on Huisman's Manthey Racing team mate Oliver Mathai for third place.

This, believe it or not, was the order in which they remained for the full 16 laps, thanks to the Hungaroring's restrictive nature.



Huisman, race winner Simon and Muller

There was action behind them in the opening laps, though. Oberbayern Motorsport's Jurgen von Gartzen and his British team mate Johnny Mowlem were both caught up in the thick of it. What appeared to happen is that UPS Porsche Junior Team driver Marc Basseng made a move on von Gartzen and the pair touched. Mayhem then ensued, as the drivers following closely behind tried to guess which way the cars would spear. Dominique Dupuy took to the grass and then rejoined, only to be hit by Mowlem who was, in turn, hit by Marc Gindorf.

Mowlem was understandably unhappy about the proceedings. 'I tried to guess where the gap would be and was caught out by Dupuy coming back on to the track. After that and the subsequent impact the car had a bad vibration. When this was combined with a red warning light coming on, I retired to the pits.

'This was a real shame as I was going well until then and was right on the tail of Stephane Ortelli who went on to finish sixth. My one flying lap was faster than anything that race winner Patrick Simon managed to do.'

Ralf Kelleners led Ortelli home in fifth, with both having demoted Alfrid Heger as the trio closed on to the tail of the leading quartet.

**PORSCHE SUPERCUP, ROUND 6 OF 9, HUNGARORING (H), 16 LAPS - 39.49 MILES, AUG 16** 1 Patrick Simon, 28m52.15s, 82.08mph; 2 Patrick Huisman, 28m52.58s; 3 Dirk Muller, 28m53.84s; 4 Oliver Mathai, 28m54.58s; 5 Ralf Kelleners, 28m57.45s; 6 Stephane Ortelli, 28m58.61s; 7 Alfrid Heger, 28m58.95s; 8 Andrej Kulundzic, 29m09.34s; 9 Frank Schmickler, 29m09.46s; 10 Pedro Couceiro, 29m17.06s. **Fastest lap** Marc Basseng, 1m46.75s, 83.23mph. **Championship positions** 1 Huisman, 108pts; 2 von Gartzen, 73; 3 Ortelli, 63; 4 Mathai, 62; etc. **Next round** Spa Francorchamps, Aug 30.

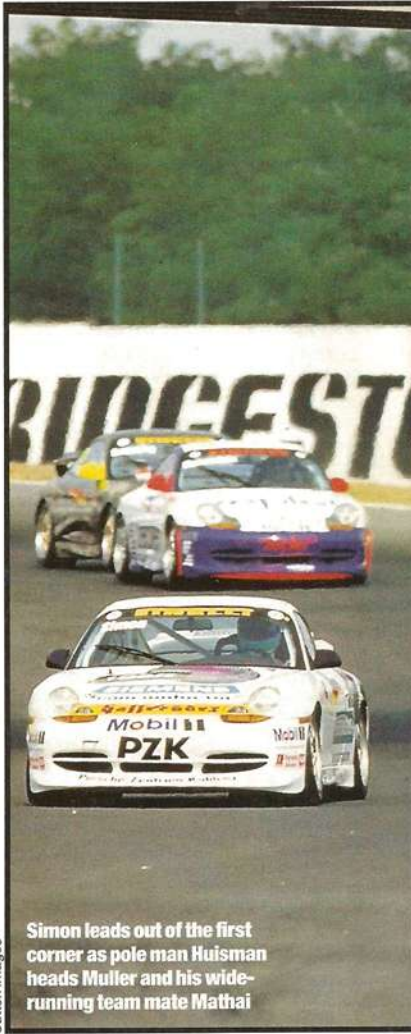

Simon leads out of the first corner as pole man Huisman heads Muller and his wide-running team mate Mathai

# Brack maintains the winning habit

Kenny Brack won Sunday's Radisson 200 at Pikes Peak International Raceway, his second straight Pep Boys Indy Racing League victory.

He won not by being the fastest, but by saving the most fuel.

Brack was running third behind Robbie Buhl and Tony Stewart with five laps to go, when Buhl ran out of fuel. He was able to pull into the pits for a splash of fuel and return to the race. Then, with Stewart in the lead and Brack second, Stewart also ran out of fuel and had to pit.

That put Brack back in the lead and his team owner, AJ Foyt, implored him to conserve fuel, put the car in sixth and use the clutch. It worked. Brack was able to squeeze enough fuel out of his car to win.

He said: 'On the last pit stop, we were lean on fuel, in sixth gear running half-throttle. I was trying to calculate how much fuel the car used per lap, then tried to pace myself. It wasn't easy. It came down to strategy at the end. I wasn't over 9500rpm in the last 10 laps and these engines rev at 10,500.'

Brack crossed the line 7.5s ahead of Buhl, with Stewart third, followed by Stephan Gregoire and Davey Hamilton.

The victory was worth \$112,950 to the Swede.

'It was pretty close, but close is good enough,' said Brack.

Brack passed the leader,



Kenny Brack made it two IRL wins on the trot when he came on strong late in the race

Hamilton, coming off Turn 4 with 35 laps remaining. Before Hamilton could get into Turn 1, Brack's team mate, Billy Boat, also made the pass to put Hamilton in third. Then, with 11 laps to go, Buhl shot past Brack and began to drive away from the field. On lap 195, he ran out of fuel.

Buhl said: 'We knew what our fuel window was and we were trying to stay out as long as we could because we knew what we had to have in the tank to go the distance. We came up probably two laps short of that and that was too bad. With five laps to go I was reading what I had on my dash and I was giving it to the guys. Then, they suddenly said, "Pit, pit, pit", but I

was too far through Turns 3 and 4 to pit. Luckily, it burred a little bit, but I was still able to get back to the pits.'

Jeff Ward dominated the race until crashing on lap 118.

Fortunately, he was uninjured.

● Bruce Martin

**INDY RACING LEAGUE, ROUND 8 OF 11, PIKES PEAK INTERNATIONAL RACEWAY (USA), 200 LAPS - 200 MILES, AUG 16** 1 Kenny Brack (Dallara-Aurora), 1h29m52.65s, 133.52mph; 2 Robbie Buhl (Dallara-Aurora), 1h30m00.19s; 3 Tony Stewart (Dallara-Aurora), 200 laps; 4 Stephan Gregoire (G-Force-Aurora), 199; 5 Davey Hamilton (G-Force-Aurora), 199; 6 Marco Greco (G-Force-Aurora), 199; 7 Buddy Lazier (Dallara-Aurora), 199; 8 Eddie Cheever (Dallara-Aurora), 199; 9 Billy Boat (Dallara-Aurora), 198; 10 Donnie Beechler (Dallara-Aurora), 197. **Next round** Atlanta, Aug 29.

## Super Swede

*Kenny Brack has developed a taste for winning in the IRL*

**W**ith two wins in a row, including Sunday's Radisson 200 at Pikes Peak International Raceway, Swedish driver Kenny Brack was asked if he was beginning to feel like an American racing hero. 'No, not yet,' Brack said. 'It takes more wins than that. AJ Foyt has 67 wins and he is an American racing hero. So I have 65 more to go.'

With two-straight victories in the Indy Racing League, however, Brack has gained in popularity in Sweden. 'They keep an eye on this,' Brack said. 'The races aren't broadcast live in Sweden, but there is a lot of exposure for the IRL in the Swedish media.'

At Pikes Peak, Brack drove a strategic race and was able to stretch his fuel mileage to the end. 'We started conserving fuel earlier than they did, so we were able to go a little further,' said Brack.

Instead of having to charge through the field at the final restart as he did at Charlotte, Brack had to baby the throttle to make it home.

'Charlotte was much tougher for me physically and mentally as you had to be flat-out all the time. Here, you had to drive accordingly. And I think we have a chance at Atlanta to make it three in a row.'

● Bruce Martin



# Lazzaro hits the front

Anthony Lazzaro and the Cal Wells-owned MCI/Precision Preparation Inc team won round 10 of the Toyota Atlantic Championship at Road America on Sunday.

The outfit has been knocking on the door of Victory Lane for a couple of years, and Lazzaro finally got it there with a flawless drive.

He started from the pole for the second time this year, but was beaten away from the start by early season points leader Memo Gidley. However, he fought back to regain the advantage before the completion of the first four-mile lap, then remained in control for the remainder of the distance.

'This is definitely the way to win the first race for this team - to do it in style by qualifying on pole and leading virtually the whole way,' said a delighted Lazzaro.

Gidley bounced back from a mechanical failure a week ago at Mid-Ohio to finish a strong second ahead of Canadian Kenny Wilden. Countrymen Alexandre Tagliani and points leader Lee Bentham also were in contention with their pair of Player's/Forsythe Swifts until both encountered trouble. Tagliani rose as high as second before losing out in a shuffle of positions immediately following a mid-race full-course caution.

He fell to seventh, then tangled with Andrew Bordin at Canada Corner. Bentham, meanwhile,



Sutton Images

Anthony Lazzaro fought back to triumph

made contact with a hard-charging Derek Hill while disputing third place. Bentham's car sustained a punctured rear tyre which dropped him to 14th at the finish.

Hill battled on despite having a badly deranged front wing and salvaged fifth for Bill Fickling and former baseball superstar Robin Yount's P-1 Racing team.

Lazzaro's rookie team mate, Jeff Shafer, continued his steep learning curve by finishing an excellent fourth in only his third start with the MCI/PPI team. For the first time, all of the top 10 finishers were equipped with Swift 008.a chassis.

● Jeremy Shaw

**TOYOTA ATLANTIC CHAMPIONSHIP, ROUND 10 OF 13, ROAD AMERICA (USA), 15 LAPS - 60.72 MILES, AUG 16** 1 Anthony Lazzaro, 37m07.25s, 98.14mph; 2 Memo Gidley, 37m11.27s; 3 Kenny Wilden, 15 laps; 4 Jeff Shafer, 15; 5 Derek Hill, 15; 6 Michael Conte, 15; 7 Rob MacDonald, 15; 8 David Rutledge, 15; 9 David Pook, 15; 10 Eric Lang, 15. **Fastest lap** Andrew Bordin, 2m04.02s, 117.50mph. **Championship positions** 1 Lee Bentham, 121pts; 2 Gidley, 114; 3 Alexandre Tagliani, 101; 4 Bordin, 98; 5 Lazzaro, 92; 6 Matt Sielsky, 87. **Next round** Vancouver, Sep 5.



# Jeff Gordon triumphs again as Ward Burton stumbles

Jeff Gordon took his fourth consecutive victory of '98, his first on the two-mile Michigan oval last Sunday.

He joins Mark Martin (who did so in 1993), Bill Elliott (1992), Harry Gant (1991), Dale Earnhardt (1987),

Darrell Waltrip (1981), and Cale Yarborough (1976) as the only drivers to complete the feat.

A win in Bristol this week would make Gordon the only driver to ever win five consecutive Winston Cup races in the modern era.

One thing's for sure, rival Mark Martin is scratching his head on how to beat Gordon.

It all started to go wrong for leader Martin when Ward Burton blew an engine with 22 laps to go.

Gordon ducked into the pits a distant fifth and exited third as crew chief Ray Evernham gambled with a two-tyre stop that included minor adjustments to the air pressure. Suddenly the handling ills Gordon had faced all day long were fixed.

'We were a bit loose, but once we tightened that thing up, bang, I started passing cars.' The win was Gordon's eighth of the year.

Martin's wishes were to win the race and dedicate the victory to his father, who died in an air crash the week before, along with his second wife and a daughter. However, he had to settle for fourth place.

Pole sitter Ernie Irvan led most of the day but fell to sixth as his team opted for a late two-tyre stop.

● Stan Creekmore

**NASCAR WINSTON CUP, ROUND 21 OF 33, MICHIGAN (USA), 200 LAPS - 400 MILES, AUG 16** 1 Jeff Gordon (Chevrolet Monte Carlo), 2h37m54.10s, 151.99mph; 2 Bobby Labonte (Pontiac Grand Prix), 2h37m55.93s; 3 Dale Jarrett (Ford Taurus), 200 laps; 4 Mark Martin (Ford Taurus), 200; 5 Jeff Burton (Ford Taurus), 200; 6 Ernie Irvan (Pontiac Grand Prix), 200; 7 Jeremy Mayfield (Ford Taurus), 200; 8 Wally Dallenbach (Chevrolet Monte Carlo), 200; 9 John Andretti (Pontiac Grand Prix), 200; 10 Chad Little (Ford Taurus), 200. **Championship positions** 1 Gordon, 3262pts; 2 Martin, 3165; 3 Jarrett, 3029; 4 Rusty Wallace, 2863; 5 B Labonte, 2839; 6 Mayfield, 2752. **Next round** Bristol, Aug 22.

## New Brazilian ace

*Brazilian star Nilton Rossoni comes good in Barber Dodge*

Brazilian teenager Nilton Rossoni served notice of his prodigious talent by running away from the field in Sunday's Barber Dodge Pro Series race at Road America.

This, Rossoni's first win, came in only his sixth start. He was competing under the guidance of former British F3 campaigner Placido Iglesias. He qualified easily on pole and was never seriously challenged during the race.

An entertaining battle for second place saw Italian Giovanni Anapoli emerge narrowly ahead of points leader Todd Snyder. Shane Donley, Nicolas Rondet and Jeff Simmons were also embroiled in that battle during the early stages before Donley's Rio Big Scholarship car suffered a mechanical failure and couldn't maintain the leading pace but still claimed fourth and fifth.

● Jeremy Shaw

**BARBER DODGE PRO SERIES, ROUND 8 OF 12, ROAD AMERICA (USA), 15 LAPS - 60.72 MILES, AUG 16** 1 Nilton Rossoni, 40m57.90s, 100.84mph; 2 Giovanni Anapoli, 41m01.83s; 3 Todd Snyder, 15 laps; 4, Nicolas Rondet, 15; 5 Jeff Simmons, 15; 6 Thomas Schie, 15; 7 Eric Treslar, 15; 8 Samer Hindi, 15; 9 Sepp Koster, 15; 10 Owen McAuley, 15. **Fastest lap** Rossoni, 2m13.42s, 109.23mph. **Championship positions** 1 Snyder, 99pts; 2 Schie, 92; 3 Simmons, 89; 4 Anapoli, 70; 5, Will Langhorne, 69; 6 Rondet, 67. **Next round** Laguna Seca, Sep 12.

Alsport USA

Jeff Gordon leads Ward Burton. Burton would go on to blow an engine; Gordon went on to win







## The Perfect Gift

Official Ferrari Merchandise from Evans Halshaw

Logo T Shirts, Various	Ferrari Mugs.....£6.99
Designs from.....£17.99	Large Sports Bag.....£75.00
Sweatshirts.....£39.99	Umbrellas from.....£29.99
Waterproof Jackets.....£79.99	Cufflinks.....£8.99
Casual Mens Shirts.....£45.00	Key Rings from.....£4.99
Polar Fleece.....£75.00	

These are just a small selection of a wide range of items available for you to choose from. Why not call in or telephone Martin Harvey for more details.

**Mail Order Line 0121 666 7363**

24 Hour Delivery • Major Credit Cards Accepted



**FREE Ferrari Mug**  
With every order over £100

**Evans Halshaw**

Monaco House, Bristol Street, Birmingham.



**STACK  
STACK  
STACK**

**SAVE 25%!**



**On selected Stack Dash systems with Predictive Lap Timing!**

**Ask about the Stack Advantage**

*"I would never have won both my F3 races this season without the Stack Predictive Lap Timing System!"*

**Darren Manning,  
Speedsport  
British F3  
Race Winner**



### **Darren the dominator**

*Darren Manning was in a class of his own in qualifying..... he extended the gap over his nearest opposition to more than half a second on Friday.*

**Motoring News July 15th, 1998  
British GP F3 support race report**

*"The first time we used the Stack data acquisition system it helped our student find over 1.5 seconds in one afternoon!"*

**Alan Longland  
Operations Manager  
Silverstone Driving Centre**

5% savings available on selected systems for a limited period only

<b>Stack, UK</b> Tel: 01869 240404 Fax: 01869 246600 Email:sales@stacktd.com	<b>GB</b> Demon Tweaks 01978 664466	<b>GB</b> P.J. Motorsport 01283 820625
<b>Stack, USA</b> Tel: 888 867 5183 Fax: 888 384 2609 Email:sales@stackinc.com	<b>B</b> Van Den Bossche 38 77 3040	<b>I</b> Gi Effe 0131 216 506
<b>CH</b> HORAG 071 644 8020	<b>D</b> ISA Racing 02651 96250	<b>J</b> SARD 0565 53 1166
<b>F</b> Danielson 86 21 22 55	<b>NL</b> Verinden Tech. 05654 27050	<b>USA</b> Epic Technologies 561 479 4766

**0-60  
IN NO TIME**



**FERRARI OWNERS TRACK DAY**

in association with

**GLENVARIGILL**

**From 9am-5pm  
on Saturday  
22nd August**

See all the action as £6million worth of Ferrari and Porsche supercars are put through their paces around the twists of Knockhill. Plus you too can experience the phenomenal acceleration and handling with our supercar passenger rides 2 flying laps for only **£15\***

**BE A WINNER**

and bring along this advertisement to enter our on - the - day

**FREE prize draw to win a passenger ride in the amazing Ferrari F40.**

KNOCKHILL CIRCUIT LTD,  
BY  
DUNFERMLINE KY12 9TF  
Tel: 01383 723337  
Fax: 01383 620167



e-mail:  
knockhill@dial.pipex.com  
Web site:  
www.knockhill.co.uk  
Open 7 days : 9am - 9pm

\* PASSENGER RIDES BOOKED ON DAY-SUBJECT TO AVAILABILITY



The JB-Giesse Ferrari 333SP shared by Emmanuel Collard and Vincenzo Sospiri won the International Sports Racing Series round at Anderstorp last weekend.

The car ended up a lap ahead of the second-placed Horag-Lista 333SP of Fredy Lienhard and Didier Theys after two and a half hours of racing at the former home of the Swedish Grand Prix.

It was the fourth consecutive win for the Franco-Italian pairing and gives them a 10-point lead over Lienhard and Theys.

It was a cold, windy and wet weekend, but the race was run in the dry, albeit under menacing clouds. Qualifying also enjoyed a dry spell, which allowed the returning BMW Team Rafanelli to secure first and third on the grid. The Pierluigi Martini/Steve Soper Riley & Scott took pole, outpacing the Collard/Sospiri Ferrari by 0.04s, with the Bill Auberlen/Didier de Radigues Riley & Scott third. Martini was standing in for Hans Stuck, who had promotional business elsewhere.

Crowds would have been swelled had a move to get Stefan Johansson to take part come off, but the Joest team couldn't get its Le Mans car ready in time. The Brums team lacked the capital to entice him to drive its Ferrari 333SP, so Marco Werner ended up as Giovanni Lavaggi's partner.

Soper led away, ahead of Collard and de Radigues, using his touring car circuit knowledge. They fell to fifth at the start, but was soon fourth. However, he could make no impression on the leading trio.

Centenari guest driver Stanley Dickens was stranded on the grid with a broken differential and both Arturo Merzario's Picchio and Jean-Claude de Castelli's Debona went off in the first few laps, reducing the 16-car field to just 13.

## Marcos takes gold at Assen

Local Dutch driver Cor Euser had a successful one-off outing in his Marcos, sharing victory with Herman Buurman and van Riet, when the Belcar series made its annual visit to Assen in Holland.

The FIA GT Championship regular qualified on pole by one second from the Marc Vannorum/Robert Dierick Callaway Corvette. However, they were surprised when the Kurt Thiers/Vincent Vosse Porsche led the race's early laps until a puncture dropped them down the order.

By then, the Callaway was out with gearbox failure and it was left to Jean-Francois Hemroulle to take the battle to Euser's car. This he did with his Audi A4, changing places sometimes as many as three times per lap. At flagfall, the Marcos was in front by just 0.38s.

Third place, almost a full lap in arrears, was taken by the Vincent Dupont/Fons Tael Porsche 911. ● Jurgen Evers

Vincenzo Sospiri and Emmanuel Collard cleaned up for the fourth race in succession



# Ferrari wins in Sweden

Collard and Sospiri score their fourth ISRS win at Anderstorp. Tege Tomvall reports

Fortunately, the rate of attrition slowed, and the field showed remarkable resilience as 10 cars were still running at the finish, including all four Ferraris. BMW Team Rafanelli lost one of its Riley & Scotts when Auberlen left the track after something broke, but the sister car came home a lapped third.

The JB-Giesse car was in a class of its own, though. Collard hit the front on lap three then set a fastest lap that was only 0.5s from Niki Lauda's 1978 Formula 1 record.

Fourth place went to Lavaggi and Werner, a further lap in arrears, with the Auto Sport Racing 333SP of Lilian Bryner/Enzo Calderari/Angelo Zadra being driven conservatively to fifth place. Sixth place went to the sweet-sounding Robbie Stirling/Klaas Zwart Lola-Judd.

The lighter CN class was won by the Fabio Mancini/Luca Riccitelli Tampolli after Thorkild Thyrring retired the Centenari he was sharing with Robin Donovan and Xavier Pompidou with a broken gearbox.

**INTERNATIONAL SPORTS RACING SERIES, ROUND 5 OF 8, ANDERSTORP (S), 96 LAPS - 240.48 MILES, AUG 16** 1 Emmanuel Collard/Vincenzo Sospiri (Ferrari 333SP), 2h30m23.38s, 95.94mph; 2 Fredy Lienhard/Didier Theys (Ferrari 333SP), 95 laps; 3 Pierluigi Martini/Steve Soper (Riley & Scott-BMW), 95; 4 Giovanni Lavaggi/Marco Werner (Ferrari 333SP), 94; 5 Lilian Bryner/Enzo Calderari/Angelo Zadra (Ferrari 333SP), 92; 6 Robbie Stirling/Klaas Zwart (Lola-Judd T881), 90; 7 Fabio Mancini/Luca Riccitelli (Tampolli RTA), 90; 8 Leonardo Maddalena/Piergiuseppe Peroni (Lucchini P1), 90; 9 Ranieri Randaccio/'Stingbrace' (Spice), 85; no other classified finishers. **Fastest lap** Collard, 1m24.92s, 106.19mph. **Championship positions** 1 Collard & Sospiri, 80pts; 2 Lienhard & Theys, 70; 5 Calderari & Zadra, 41; etc. **Next round** Nurburgring, Sep 6.

## Burt chases Sekiya home at Fuji

Masanori Sekiya and Kelvin Burt finished in formation for the TOM'S team in the 10th round of the Japanese Touring Car series at the TI circuit last Sunday.

Sekiya qualified on pole position and then led from start to finish to put himself on the brink of clinching the championship title.

Sekiya's major title rival is the

Cerumo team's Hironori Takeuchi, but he was able to finish only sixth. This means that he now has to score maximum points at the three remaining rounds and have Sekiya retire to beat Sekiya to the crown.

The race went Sekiya's way at the first corner on the first lap when Yuji Tachikawa, Katsutomo Kaneishi and Takeuchi touched, letting Sekiya escape for victory. This also helped Burt progress from fifth on the grid.

It was TOM'S team's first one-two of the season.

Sekiya said: 'Even if few cars take part in this series, I concentrate on winning. And I still have the same motivation for the final round in Fuji'. ● Jiro Takahashi



Kelvin Burt celebrates his second place

**JAPANESE TOURING CAR CHAMPIONSHIP, ROUND 10 OF 16, TI CIRCUIT (J), 25 LAPS - 57.85 MILES, AUG 16** 1 Masanori Sekiya (Toyota Chaser), 41m16.79s, 84.08mph; 2 Kelvin Burt (Toyota Chaser), 41m22.33s; 3 Yuji Tachikawa (Toyota Chaser), 41m26.84s; 4 Keiichi Tsuchiya (Toyota Chaser), 41m28.95s; 5 Ruben Derfler (Toyota Exiv), 41m36.50s; 6 Takeshi Tsuchiya (Toyota Exiv), 41m37.85s. **Fastest lap** Kaneishi, 1m36.94s, 85.94mph. **Next round** Sendai, Sep 6.

## Six for Dumbreck

New Japanese F3 champion Dumbreck keeps on winning

Peter Dumbreck took another win in the Japanese Formula 3 series, at the TI circuit. This was even though he had clinched the title at the previous round.

It was close in qualifying, with the top six drivers covered by a second. The Scottish driver landed pole and his team mate Shingo Tachi lined up alongside him on the front row.

Then, as in the touring car race, the TOM'S duo dominated. They were followed home by Hiroki Kato. ● Jiro Takahashi

**JAPANESE F3 CHAMPIONSHIP, ROUND 8 OF 10, TI CIRCUIT (J), 25 LAPS - 57.85 MILES, AUG 16** 1 Peter Dumbreck (Dallara-TOM'S F398), 37m40.81s, 92.94mph; 2 Shingo Tachi (Dallara-TOM'S F398), 37m43.64s; 3 Hiroki Kato (Dallara-Mugen F398), 37m44.69s; 4 Tatsuya Tanigawa (Dallara-TOM'S F397), 38m06.24s; 5 Haruki Kurosawa (Dallara-Mugen F397), 38m06.55s; 6 Ruben Derfler (Dallara-TOM'S F397), 38m08.41s. **Fastest lap** Kato, 1m29.60s, 92.97mph. **Next round** Sendai, Sep 6.



Donington Park



# FIA GRAND TOURING CAR CHAMPIONSHIP

Sunday September 6 1998

**Starts 12.00 Noon - 500 kms**

**Supported by:**

**FIA CUP FOR THOROUGHBRED GRAND PRIX CARS  
OPEN FORTUNA BY NISSAN  
LAMBORGHINI CUP**

**Admission: Adults £17 (£15 in Advance) - Accompanied Children (15 yrs and under) FREE  
3 Day Entrance/Paddock Pass: £25**

**Saturday 5th September: Qualifying & FIA European Historic Car Championship Races - Trackside admission £6**

**Friday 4th September: Qualifying for all races - Trackside admission FREE**



PHOTOS: MICK WALKER

**CREDIT CARD HOTLINE 0115 912 9124  
CIRCUIT OFFICE 01332 810048**

(Credit Card bookings may incur a handling/postage fee)



One-all

Leinders and Kaffer won a German Formula 3 race each

A week after the Marlboro Masters, which had been rather disappointing for the German Formula 3 Championship regulars, they were out to impress at Zweibrücken.

Bas Leinders had been one of the most disappointed in Holland, but he made up for this by claiming pole ahead of BSR's Pierre Kaffer and his van Amersfoort Racing team mate Christijan Albers.

The rival Benetton-backed KMS squad were in disarray, though, with Jeffrey van Hooydonk, Thomas Mutsch and Johnny Mislijevic qualifying 14th, 17th and 18th.

Leinders shot into a lead he wasn't to lose and was more than 2s clear at the end of the first lap. Kaffer gave chase but couldn't catch the Belgian. Albers, on the other hand, was demoted by the Kaufmann Racing Martinis of Timo Scheider and Wolf Henzler and then fell behind Yves Olivier, Robert Lechner and Johan Stureson after making a series of errors.

With a new clutch installed after some problems in the first race, Leinders made a poor start to the second race, falling back to sixth as Kaffer took the lead. The Martini driver then motored to his second win of the season at the venue where he took his first F3 win in 1997.

Driving in red-mist mode, Leinders charged to second place after 'one of my best races ever', and this extended his points lead over Henzler who finished third.

● Rene de Boer

**GERMAN F3 CHAMPIONSHIP, ROUND 7 OF 10, ZWEIBRÜCKEN (D), 2 x 29 LAPS - 2 x 50.28 MILES, AUG 16, Race 1** Bas Leinders (Dallara-Opel F398), 30m19.74s, 99.46mph; 2 Pierre Kaffer (Martini-Opel MK73), 30m23.26s; 3 Timo Scheider (Martini-Opel MK73), 30m24.33s; 4 Wolf Henzler (Martini-Opel MK73), 30m25.38s; 5 Yves Olivier (Dallara-Opel F398), 30m32.02s; 6 Robert Lechner (Dallara-Opel F397), 30m34.24s. **Fastest lap** Leinders, 1m02.06s, 100.57mph. **Race 2** 1 Kaffer, 30m20.23s, 99.44mph; 2 Leinders, 30m20.47s; 3 Henzler, 30m25.00s; 4 Lechner, 30m30.10s; 5 Olivier, 30m31.27s; 6 Christijan Albers, 30m31.80s. **Fastest lap** Lechner, 1m01.45s, 101.57mph. **Championship positions** 1 Leinders, 148pts; 2 Henzler, 133; 3 Lechner, 111; 4 Kaffer, 102; etc. **Next round** Salzburgring, Aug 30.

Winkelhock and Cecotto were the class act when the German Super Tourers visited the Zweibrücken airfield circuit



# Cecotto collects a pair

BMW's Johnny Cecotto extended his German Super Touring lead with a double win. Rene de Boer reports

The former military airbase of Zweibrücken in Germany's Saarland region close to the French border hosted the seventh round of the German Super Touring series. And it proved a very happy hunting ground for BMW's Johnny Cecotto who claimed a pair of wins to extend his points lead.

For the fourth time this year, an Opel was on pole, with Manuel Reuter pipping fellow Opel driver Uwe Alzen by 0.004s. And it was close throughout, as the top 10 were covered by 0.3s, with 17 of the 24 cars qualifying within 0.9s of pole.

BMW's Joachim Winkelhock lined up third, with Honda's Gabriele Tarquini fourth. But Winkelhock used the advantage of his 320i's rear-wheel drive to shoot through to lead the sprint race, heading Alzen and Tarquini into the first corner, with Reuter slipping to sixth behind Cecotto and Laurent Aiello's Peugeot.

Behind them, Tom Kristensen's Honda was pushed into Jorg van Ommen's Peugeot, with the Dane lasting four laps more than van Ommen before also pulling off.

Cecotto passed an increasingly gripping Tarquini on lap four, then overtook Alzen three laps later. Then, with three laps to go,

Winkelhock let his team mate past for maximum point and followed him home with Alzen a safe distance behind. However, Alzen was given a 30s penalty for having failed to come in for a stop-go for overtaking on the formation lap and this elevated Aiello to third, while Alzen plummeted to 15th.

Winkelhock led away again in the feature race, this time from Aiello, Tarquini and Cecotto, while Reuter got involved in a collision with Michael Krumm's Nissan and fell to last place.

Tarquini then swapped places on lap seven, with the Venezuelan moving past Aiello for second on lap 21. From then on, it was only a matter of time before Winkelhock dutifully moved over to let Cecotto win and extend his points lead over Aiello.

Roland Asch moved his Nissan into third place past Helary who had pitched Tarquini into a tyre wall.

**GERMAN SUPER TOURING CHAMPIONSHIP, ROUND 7 OF 10, ZWEIBRÜCKEN (D), 18 & 36 LAPS - 31.21 & 62.42 MILES, AUG 16, Race 1** 1 Johnny Cecotto (BMW 320i), 20m39.19s, 90.66mph; 2 Jo Winkelhock (BMW 320i), 20m40.19s; 3 Laurent Aiello (Peugeot 406), 20m44.30s; 4 Gabriele Tarquini (Honda Accord), 20m45.18s; 5 Manuel Reuter (Opel Vectra), 20m46.99s; 6 Roland Asch (Nissan Primera), 20m47.21s; 7 Michael Krumm (Nissan Primera), 20m57.23s; 8 Eric Helary (Opel Vectra), 21m00.39s; 9 Alex Burgstaller (Opel Vectra), 21m03.91s; 10 Stefano Modena (Alfa 156), 21m04.58s. **Fastest lap** Cecotto, 1m07.93s, 91.88mph. **Race 2** 1 Cecotto, 41m28.42s, 90.29mph; 2 Winkelhock, 41m29.32s; 3 Asch, 41m34.02s; 4 Helary, 41m35.58s; 5 Aiello, 41m36.62s; 6 Uwe Alzen, 41m47.66s; 7 Jorg van Ommen (Peugeot 406), 42m00.39s; 8 Michael Bartels (Peugeot 406), 42m02.52s; 9 Tom Kristensen (Honda Accord), 42m06.91s; 10 Modena, 42m10.49s. **Fastest lap** Asch, 1m07.91s, 91.91mph. **Championship positions** 1 Cecotto, 445pts; 2 Aiello, 362; 3 Helary, 347; 4 Alzen, 330; 5 Reuter & Winkelhock, 308. **Next round** Salzburgring, Aug 30.



Nissan's Roland Asch claimed third place in the main race when he passed Eric Helary



Pierre Kaffer took second and then a win

MVG Photographic

MVG Photographic

MVG Photographic



# AUTOSPORT

**TEL: 0181 943 5858**  
**FAX: 0181 943 5850**

## CLASSIFIED

Advertisements can be supplied by fax or in electronic format, preferably as Macintosh format floppy, Syquest, 3 1/2 or 5 1/4 optical or CD Rom. Other formats please check with us first. For urgent copy we have ISDN: 0181 742 2363, Email: [asclass@gnome.digitalpress.co.uk](mailto:asclass@gnome.digitalpress.co.uk)

Telephone advertisements must be pre-paid by credit card at £2.35 (inc vat) per word, minimum charge £47.00 (inc vat) for 20 words. All classified advertising closes Monday 4.30pm subject to space availability. **Pre-paid ads by post** - Cheques or PO with order. **Classified Display** - £27.03 (inc vat) per single column centimetre. Minimum space 4cm £108.10 (inc vat). Any photograph to be included in an advertisement, Black & White or Colour Print. **Appointments** - £31.72 (inc vat) per single column centimetre. Minimum space 6.5cm £206.21 (inc vat). **Box Numbers** - £58.75 (inc vat). **Replies should be addressed to Autosport Advertising, 38-42 Hampton Road, Teddington, Middlesex TW11 0JE.** Autosport reserves the right to refuse or withdraw advertisements at their discretion and does not accept liability for printer's or clerical errors, although every care is taken to avoid mistakes. **Trade Descriptions Act 1968.** Advertisers should pay close attention to the requirements of the Act, particularly regarding accurate descriptions of all goods offered for sale. **Cancellations.** Accepted no later than three weeks prior to copy date and by written confirmation.

For Sale

## '97 McLAREN GTR

LONG TAIL



EXCELLENT SPARES PACKAGE AVAILABLE

DAVID CLARK, TAYLOR & CRAWLEY LTD, 32 WILTON ROW, LONDON, SW1X 7NS.  
TEL +44 (0)171 823 2599 FAX +44 (0)171 235 7716



M  
C  
L  
A  
R  
E  
N  
F  
I  
G  
T  
R

### MARCUS DODD'S 1998 MINTER NATIONAL CHAMPIONSHIP CAR



Car can be seen at the Silverstone Rallyprint on August 22nd & 23rd

- Escort RS Cosworth Group A car, NIFMC.
  - Full works specification LHD car.
  - Available in tarmac or gravel specification.
  - Car is in immaculate condition and fully rebuilt, with build and life sheets.
  - Please phone or fax for specification and price.
  - Seriously for sale.
  - Please phone MARCUS DODD or IAN PLUMMER
- Phone (+44) 1202 666060 Fax (+44) 1202 666767**

7158

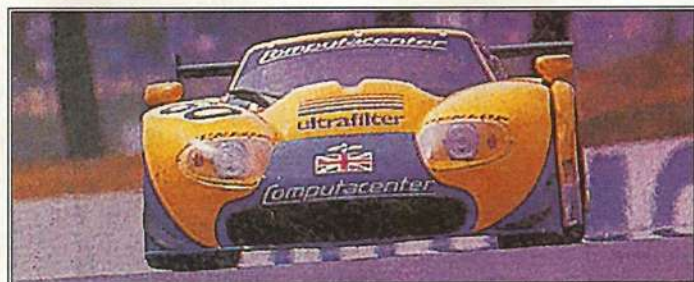

### MARCOS 600 LM

Privilege Insurance GT2 Championship winner and previous runner-up. Currently racing in this year's championship. Fresh engine and spares. Lease purchasing and car hire package available.

Serious enquiries to  
0171 237 6073, 09735 39387 Mach 1 Eng Ltd

71405



**HOT HATCH FIESTA**



Rust free lightened bodyshell, full welded roll cage. Ledo suspension. Full spec. engine and gearbox. Plumbed in fire extinguisher, race winner in the right hands. New RADICAL forces sale. £4,500.

**Tel: Mick Hyde on 01625 511100**  
71402

**Terry Nightingale**

offers his



Ex-Ray Mallock 1971 Mk11B Formula 3, 1600 Lotus Twin Cam, fully restored to the highest spec. Full FIA papers, many spares, 96 German & 97 British Championship winner. Eligible German/French/British Championships. Would p/x for Pre-71 F2 or Atlantic car. £12,000.

**Tel: 01799 524380 or 07050 185577**  
anytime 71224

**FOR SALE**

**1995 AMERICAN MOTORHOME/HOSPITALITY UNIT.**

6.5 T.D., 32FT, 6 BERTH, TWIN AIR CON, SATELLITE, TWIN TVs + ALL USUAL EXTRAS. PLUS 4 WHEEL TRAILER CARRYING:- EVERY CONCEIVABLE ITEM NEEDED TO OFFER HOSPITALITY TO THE HIGHEST LEVEL, FROM LARGE AWNING (TO SIT 40) TO THE VASES ON THE TABLES. JUST HAD MAJOR SERVICE + MOT. UNFORTUNATE CHANGE OF PLANS. PRICED TO SELL AT £37,000 + VAT. RING MR MORRIS FOR FULL SPEC LIST ON 01622 850944, 0831 220397



71431



**J R Motorsport**

**Arrows Show Car**  
Ideal for showroom or corporate display.

For information please call  
**J R Motorsport**  
**+46 705 927377**  
or fax  
**+46 586 55086**  
Sweden

71252

**LINE UP THE EUROPE'S LARGEST AND MOST PRESTIGIOUS MOBILE UNITS IS NOW AVAILABLE FOR HIRE FOR INTERNAL AND EXTERNAL EXHIBITIONS**



71016

The unit originally designed and built by The Russell Organisation has been successfully operated for owners in the finance and automotive industry. Maintained to the highest standard the unit provides an unrivalled temporary structure with areas for entertaining, catering preparation and high level internal and external viewing areas.

Further information is available from The Russell Organisation - Logistics Department  
**Contact Louise Garwood Telephone 01603 785 721 Fax 01603 785 752**



**BUCKMORE PARK**

INTERNATIONAL OUTDOOR KART CIRCUIT



"I started my career at Buckmore Park and I still rate it as the finest karting circuit in the country."

- Johnny Herbert,  
British Grand Prix winner

Located just off junction 3 of the M2 in Kent, only 40 minutes from central London and 15 minutes from the Dartford crossing.



**Forthcoming Events**  
**Hire Pro-kart Summer Championships**

**1 hr Individ. Enduro**

- 20th September
  - 18th October
- Cost: £79 per driver

**2 hr Team Enduro**

- 29th August (non-championship)
- Cost: £139 per team

**3 hr Team Enduro**

- 22nd August
  - 5th September
- Cost: £255 per team

**6 hr Team Enduro**

- 27th September (non-championship)
- Cost: £425 per team

**Individual Open Grand Prix League**

15mins timed qualifying. Three heats per driver. Grand Final.

- 19th August
  - 23rd September
  - 21st October
- Cost: £55 per driver

**New Enduro**  
Karts now in use



75mph 400cc twin Pro-karts - the fastest in the business

BPKC Ltd, Buckmore Park Kart Circuit,  
Maidstone Road, Chatham, Kent ME5 9QG.  
www.buckmore.co.uk E-mail: sales@buckmore.co.uk  
Tel: 01634 201562 Fax: 01634 686104



## AUTOCROSS

**AUTOCROSS CLASS 1D.** Special twin Kawasaki ZX 9R. £6,500. Also 2 spare engines for sale separately £1,500 o.n.o. for both. Tel: Martin Anns on 07970 728714. (27180)

## CARS FOR SALE

100 race cars  
photos &  
specs

[www.bdracing.com](http://www.bdracing.com)  
or call  
001.973.316.8444

## FORMULA 3000

### FORMULA 3000 REYNARD

92 D, DFY Mader engine, 400km + spares. Ready to race!  
PHONE FOR PRICE

### FORMULA 3 REYNARD 893

Alfa Romeo engine, 500km + many spares. Ex Mika Salo. Ready to race.

£9,000  
Tel/Fax: ++41 32 492 2837  
or ++41 32 497 9754  
SWITZERLAND

## FORMULA RENAULT

### FORMULA RENAULT SWIFT FR90

Eligible for BARC Formula Renault, Mono Posto, has also been 2nd overall & class winner at New Brighton Hillclimb. Spares include bodywork, wheels and many tyres.

£4,400 ono

many p/x road car or motorhome.  
Also no. plates for Subaru owners:

R555JHS + S55WRC  
Tel: 0151 604 1141

## HISTORIC

**BDG 2 LITRE ALLOY BLOCK ON WEBERS.** All original, around 100 miles since re-build, including new liners. Can be seen/heard Shelsley August 15/16, Prescott Sept. 5/6. Phone 01926 614257 eves. (70845)

### FORD MUSTANG 1965

Eligible for CTC/ICS/Anglo-American (with some mods). Cost £140,000 to build, unbelievable condition. See it for yourself and make sensible offers.

### FORD FALCON SPRINT V8 1963

Eligible for FIA appendix K, pre '65, Anglo-American and other classic series. Raced from new in U.S. Interesting history, ready to go. £9,995

CONTACT JOHN YOUNG  
0181 559 2533 0468 973343

### RALT RT-2

Second of 3 built, 1979 Formula 2 works car (Brian Henton and Rad Dougal), US Can-Am 2 litre Champ 1980 (Gary Gove) and '81 (Jim Trueman), restored by LP Racing in Indianapolis with fresh Cosworth BDA, many spares, US £37,500/OBO.

TEL: 314-394 3130  
FAX: 314-394 7090 MO

## LAMBORGHINI

### LAMBORGHINI DIABLO SVR

This very special limited edition car with chassis No. 007, was the winner of the 1997 Lamborghini Trophy. It has been fully maintained by Lamborghini, and has clocked 6,000 km. It can be viewed at Donnington on 4/5/6 September 1998.

For further details call  
John Stevens on  
0171 663 6666

£P.O.A.

## MAZDA

**MAZDA 323 GTR GROUP A FOR RALLIES.** 313hp, 549 Nm, excellent condition, all parts from Mazda Team Europe, X-Trac 6-gear, many replacement parts and tyres included. Fax: ++43-42283550. E-mail: ser@pewag.com

## RACING SALOONS

### 1996 SEAT IBIZA 2 LITRE 16V

Class Winner & Runner Up overall at Lydden Circuit Semsec 1997. B.R.M., 210 bhp, fully sorted by G. Tech. Ready to race in 1998 season.

Price £9,995

Daytime Tel: 01227 710590

Evening Tel: 01227 711862

### ALFA ROMEO 33



170 bhp, Leda Suspension, Apaltes, slicks + wets. Hot match or Autolitalia Championship. 1997 newcomer award in Autolitalia. Offers around £5,000. Call Geoff on 0498 604456

## RACING CARS

### RACE CAR CLEARANCE

**TIGA SF89.** Ex Paul Cope/John Pugsley. Complete with many spares, wheels etc. and excellent trailer. £10,000 as Sports 2000 with Nelson engine, or £12,000 as Castle Combe type GT with demon ultra short stroke Philipspeed Pinto all steel dry sump.

**MITSUBISHI STARION TURBO.** Ex 'Mad' Mike Jones rally car (Tulip, RAC etc.). Originally Prodsports, most recently raced in Combe Handy Gas. Many spares, wheels, tyres (slick, road and knobby). Never a road car, always raced or rallied. Some rally spares. Would make good cheap club rally car. £3,000.

**CHEVETTE 2600 HSR LOTUS 16V.** T/C special saloon racer. Rebuilt engine. ZF 5 speed box. Jaguar LSD axle. AP vented front brakes. New 15" Revolutions with new Avon slicks. Extensively raced, Combe, Thruxton etc. Ideal for series at Pembrey, Oulton, Knockhill. £3,000.

This is a retirement sale. All cars are near Bristol. I have owned them for many years. Will consider interesting part exchanges (road or race)

**MALCOLM STEVENS**  
TEL: 01749 860569



### Simpson Engineering offers for sale:

ISRS Sports car Project, honeycomb chassis utilising XJR12 suspension components, complete with new T85 gearbox.....£25,000

Ferrari 348 4.4 litre V8 engine, developed to produce 500 bhp, complete with management, engine harness and flywheel. Dyno time only.....£17,500

Ferrari engine, as above having done one race.....£16,500

Standard Ferrari 348 engine very low mileage, complete, excellent condition.....£8,500

Chevron B36 split rim sportscar wheels, uprights, do-nuts, FT/FG gear ratios and sundry other Chevron parts.....£P.O.A.

Contact: Robin Smith

Tel: 44-(0)1594-528185/6 Fax: 44-(0)1594-529411

To advertise your  
Racing Car  
please call  
0181 943 5858

## RALLY CARS

### F2 RS 2000

**FULL INTERNATIONAL GP 'A' SPEC** LHD GSE built to full int. GP 'A' spec. XTrac sequential gearbox late type, big VC, AP 4 pot 310 front brakes, AP 2 pot 285 rears, ATL bag tank, motordrive pro seats, 3" six point belts, plus all the rest of the parts you would expect on a works spec car. The car has just been repainted into Mk7 shape and fitted with works single headlights, and repainted white.

£47,995 - MAY TAKE P/X

Tel: 0411 685175 mobile, 01642 713290 home  
Spares to include wheels, tyres, rad & fans, rack, suspension etc. Available by separate negotiation

### SPECIFICATION OF SUBARU LEGACY J177 TVU - NO PRO/ST/0115

This car was built new by PRODRIVE in 1992 to full GpN specification and was purchased by us 2 years ago and has since been modified to Clubman GpA specification. **BODY:** Japanese spec WRXRA shell with multi-point cage, Recarro seats, electric fire eater system, Premier bag tank, Kevlar spare wheel holder and finished in white with multi-coloured graphics.

**ENGINE:** WRXRA engine with solid lifters, GpA large intercooler, Impreza turbo (40 miles only), GpA intake systems, GpA exhaust system, and GpA engine mountings running on Prodrive management system. **TRANSMISSION:** STI clutch cover with HELIX paddle clutch disc, new 5spd straight cut dog box with front LSD and uprated centre viscous coupling and rose jointed quick shift gear lever (cost over £10,000) plate type rear LSD with uprated output shafts.

**SUSPENSION/BRAKES:** Fully adjustable HI-TEC dampers with remote reservoirs (same as PRO-FLEX), WRXRA brakes with competition pads.

This is a genuine works built car and not to be confused with other "lookalikes", and has never been seriously damaged and is in exceptional condition for a competition car. The car comes complete with 8 spare wheels and some spares.

PRICE: £24,950 ono

For further details contact:

Charles Smith on  
01584 875443

## VINTAGE RACING



### 1972 MARCH 722-F2 2 Litre

Fresh motor, gearbox, paint. Tons of spares.

Very fast beautiful Red car

w/RMVR logbook. None better. £63K.

Kevin 303-457-9953/d;

940-1326/e/wkd. CO



### '90 NISSAN GTP

Brabham factory entry. Momo

Team '91-'92 Bell/Moretti.

NEW 3-litre twin-turbo V-6.

Easy to maintain. Many spares.

\$225,000.

Benton Bryan

(423) 637-6441. TN

## WESTFIELD

**1998 WESTFIELD SE 1700.** Championship specification, road registered. Complete with dry sump engine. £19,250 ono. Part exchange considered. Phone/Fax: 01636 636898. (71219)



**AWNINGS**



**HIGH QUALITY TRANSPORTER AWNINGS**

**FREESTANDING FRAME STRUCTURES**

TEL: 01962 736316  
FAX: 01962 735098

**ALRESFORD TECTONICS**  
ALUMINIUM & P.V.C. STRUCTURES

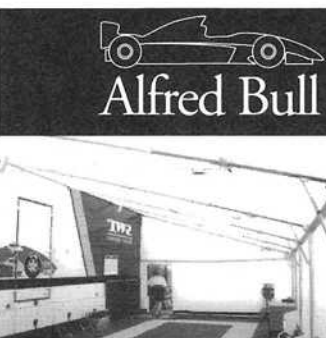

**Alfred Bull**

**Transporter Awnings**

WOODBRIDGE MEADOWS · GUILDFORD · SURREY GU1 1BB  
TEL 01483 561897 · FAX 01483 573448

**'SIMPLY THE BEST'**



- Quality
- Durability
- Flexibility
- UK and export enquiries welcome

**DEANS**  
TRANSPORTER AWNINGS

TEL: 01942 241399  
FAX: 01942 241904

**The #1 Best Selling Instant Shelter**

**E-Z UP INSTANT SHELTERS**

- Sets up in 60 seconds
- 4 sizes & 23 colours available
- Optional side walls & accessories
- Durable all-steel double truss design
- Over 300 in stock for next day delivery!

E-Z UP SHELTERS ARE PERFECT FOR:  
Boating • Picnics • Camping • Sales Booths • Race Pits  
Parties • Sports Events and More!

Authorised Distributor  
**MAYFLOWER MARQUEES**  
Unit 6, Penn Street Works, Penn Street, Nr Amersham,  
Bucks HP7 0PU

TEL: (Sales) 01494 712131 Fax: 01494 713337

**Chequered Flag Awnings**

Tele/Fax: 01694 781544 (24 hours)  
International agents and exports required  
Banners produced with sign writing and graphic services available.



A professional look at a Clubman price  
Free Standing specialists. Variety of Uses.

3x3x2.3	4.6x3x2.3	4.6x4.6x2.5
£525	£650	£950

Larger sizes available on request  
**SPECIAL SPRING OFFER**  
Free colour scheme with your awning.

**BRAKES**



**HAWK BRAKE**

**FERRO CARBON DISC PADS**

**CAMBRIDGE MOTORSPORT LTD.**  
Caxton Road, Great Gransden, Nr Sandy,  
Bedfordshire, SG19 3AH, England  
e mail cambridge.motorsport@dial.pipex.com

01767 677 969 Fax: 01767 677 026

**CIRCUIT TESTING**

**CIRCUIT TESTING IN WILTSHIRE**

**ON WEDNESDAY 26TH AUGUST**

2 mile tarmac, very smooth, huge run-off and medical back-up.

**£95**  
unlimited track time

Call 01222 704997 to book and future dates

**CORNER WEIGHT EQUIPMENT**

CORNER WEIGHT SCALES, SPRING TESTERS, INTERCOMP EQUIPMENT FROM ROLLCENTRE. Scales priced from £1000 to £1850. Rollcentre are the only authorised service agent for Intercomp. As used by first and second in the BTCC, supplied and serviced by Rollcentre. 01480 464052, fax: 01480 494547, e-mail: rollcentre@aol.com (61930)

**ALARMS**



**TOTALLY U.K. LEGAL**  
**cobra RADAR DETECTORS**

from just **£99**

<http://www.direct-express.co.uk>  
Call..01527.833212.....e:mail..radar@direct-express.co.uk

**DATA ACQUISITION**

**P. J. MOTORSPORT**  
Dashboard and data logging specialist



New and used equipment from stock.  
**Competitive Prices.**

Ring John Knapton: 01283 820625

**KARTRONIX**  
DATA LOGGING SYSTEMS

**DRIVE AVAILABLE**

**RENAULT SPIDER DRIVE AVAILABLE**

Remaining 3 TOCA rounds and/or Winter Test Programme. Very favourable deal for the right driver.

**CONTACT TIM SUGDEN**  
01274 662538 WORKSHOP  
0836 795900 MOBILE

**ENGINES**

**VAUXHALL 16 VALVE.** All steel, stainless valve, solid lifters, new crank and rods, steel flywheel, dry sumped, twin plate clutch, 48 webers, M.B.E. ignition, dyno run only. £6,750. Tel: 01963 362551 or 1963 363009. (27114)

**WANTED: 3 LTR. ESSEX TRIPLE INLET MANIFOLD** with Weber 42 DCFN carbs. Contact Chris 01527 854514, fax: 01527 852983. (71218)

**SCAT V4 ALUMINIUM RALLY ENGINE.** 280 bhp, 260 lbs, FT, dry sumped, totally complete. Geoff 01527 575355 anytime. (27182)

**BDG 2 LITRE ALLOY BLOCK ON WEBERS.** All original, around 100 miles since re-build, including new liners. Can be seen/heard Shelsley August 15/16, Prescott Sept. 5/6. Phone 01926 614257 eves. (70845)



Seeking suppliers for **CRANKSHAFTS** (made from billets)

Annual quantity 200 pieces  
Conrods in small quantities

**CONTACT HERBERT HARTGE**  
IN GERMANY  
Tel: 0049 6835 5060  
Fax: 0049 6835 506-17

**JAGUAR XJ220 ENGINES**

2 units, recently rebuilt and dyno tested, both in excellent condition.

Offers around **£29,950 considered**

**Contact:**  
**TWR ENGINES**  
Tel: (44) 1865 844621  
Fax: (44) 1865 841901

**EXHAUSTS**

**ROLLCENTRE EXHAUST SYSTEMS.** Specialist exhaust manufacture, silencing noise checks. Contact David Short on 01480 463104, fax: 01480 494547, e-mail: rollcentre@aol.com (68087)

**EXHAUST SYSTEMS**

**BTB EXHAUSTS.** Manufacturers of motorsport manifolds and systems. Mandrel tube bending, free noise testing. ISO 9002. Tel: 01327 261797, fax: 01327 263577. (68744)

**GEARBOXES**

**QUASFE 4 SPEED DOG BOX.** New and unused. £1,100 o.n.o. Tel: 01963 362551 or 01963 363009. (27115)

**BPA Engineering**

**SPECIALIST TRANSMISSION SERVICES**

Hewland Build & Rebuild  
New & S/H Spares

*Gearboxes & Axles Rebuilt  
Gears & Spares Manufactured*

**CONTACT: ANDREW BRITTEN**  
TEL: 01256 895757  
FAX: 01256 895151

**HEWLAND**

**Sales and Service**

- ★ Rebuilds, Repairs and Modifications
- ★ All gearboxes – current and historic
- ★ Prototype design and development projects

*Blueprint assembly is our standard*

**pds racing**  
153 BARNSELY ROAD  
HEMSWORTH, PONTEFRAC  
WEST YORKSHIRE WF9 4PQ  
Tel/Fax: (0977) 611928

**PowerHaus II**  
PORSCHE GEAR CENTRAL



COMPLETE SELECTION OF CLOSE RATIO GEARS, SPECIAL MAINSHAFTS (904, G-50, ETC.), RING AND PINIONS AND LIMITED SLIP AND LOCKED DIFFERENTIALS FOR ALL STREET AND RACE PORSCHES 1964 TO 1998

**PowerHaus II**  
PHONE 515.469.3063 FAX 515.469.6404  
ALL MAJOR CREDIT CARDS ACCEPTED • WEBSITE 300W  
1100 University Manor Suite 15 • Fairfield, Iowa 52556 USA



## INSURANCE

### Competition Car Insurance

Insurance for competitors by competitors

- Road use
- On event accident
- Storage & Transit
- Service vehicles including spares & tools
- Personal Injury

TEL: 0115 941 5255  
FAX: 0115 941 5215

For further information contact Richard Egger or Tracey Saucedo

## D.C.

Special & High Risk Motorsport Insurances

THE ONLY WORLDWIDE & EXCLUSIVE SPECIALISTS IN

PHYSICAL 'ON-TRACK' CRASH DAMAGE FOR CARS, BOATS & BIKES

There is someone near you ready and able to assist

Offices: Belgium • Switzerland • Holland • Canada • USA

Agents: Italy • Australia • Japan

Belgium: Tel 32.3/605.0433 Fax 32.3/605.2045

USA: Tel 1.888/322.3544 Fax 1.317/329.9996

Canada: Tel 1.888/322.3544 Fax 1.905/403.8760

Holland: Tel/Fax 31.33/494.8996

GSM 31.654/314533

Switzerland: Tel 41.71/644.8022 Fax 41.71/644.8030

## LAPTIMING EQUIPMENT

**ROLLCENTRE LT32 LAPTIMER.** The most reliable, affordable, simple and easy to fit Lap Timer available. It will work with Single seaters, Saloons, Karts, and Bikes. Instant Lap time as you do it. 32 Lap recall afterwards. 30 day money back guarantee if not satisfied. 1 years warranty. Rollcentre 01480 464052, Fax 01480 494547, E mail Rollcentre@aol.com., (68086)

## KARTING



**Richard Wilson MOTOR RACING**

TEL: 01423 567497  
FAX: 01423 563725

- Specialist 100cc 2-stroke Karting courses.
- One-to-One tuition on outdoor racing karts.
- Coaching for Novice and Experienced Drivers.
- 1 and 2 day courses for up to 3 people at R.A.C. Circuits throughout the U.K.
- A.R.K.S. Preparation and Consolidation.
- Our race winning Westfield S.E. 16-Valve Zetec is available for Race Hire/Testing during 1998.

Phone now for further details on race hire and karting services.

## BUCKMORE PARK

INTERNATIONAL OUTDOOR KART CIRCUIT



"I started my career at Buckmore Park and I still rate it as the finest karting circuit in the country."  
- Johnny Herbert, British Grand Prix winner

### Six-hour Autumn Hire Pro-kart Team Enduro



Sunday  
27th September 1998

- 75mph Twin hire Pro-karts.
- Timed qualifying.
- Mechanical and medical back-up.
- Computerised lap scoring.
- Electronic scoreboard and CCTV monitoring.
- Helmet, gloves and suits provided.
- Tactical fuel and driver changes.
- Three to ten members per team.
- Wet weather tyres and oversuits.
- Superb trophies and special prizes.

Entry Fee: £425 per team.

Contact: Buckmore Park Kart Club Ltd.  
Buckmore Park Kart Circuit, Maidstone Road, Chatham, Kent ME5 9QG.  
www.buckmore.co.uk E-mail: sales@buckmore.co.uk

Tel: 01634 201562 Fax: 01634 686104

## IN-CAR VIDEO

### IN-CAR CAMERA & VIDEO RECORDER

- Remote miniature camera
- Mount anywhere on car
- Helmet-microphone
- Driver training aid
- Impress sponsors
- Superb quality picture
- Integral 4" colour screen
- High quality TV playback
- Playback at track
- Race proven design

**Radical Motorsport**  
27 St. Davids Square,  
Peterborough PE1 5QA  
01733 344198  
www.radicalms.co.uk

## LIVERIES

### STICKERS

Suppliers to Racing Teams, Event Organisers, Sponsors, Competitors, Magazines, Trains and Planes

Ring **Robin Stretton**

**Boost**

Orchard Lane, Alton, Hampshire GU34 1DP  
01420 542722 Fax 542999

## MEMORABILIA

**GRAND PRIX TOPGEAR**  
# FOR F1 COLLECTORS ITEMS

WE BUY AND SELL ORIGINAL TEAM ITEMS ORIGINAL BODY PARTS, WHEELS, TEAM CLOTHING, RACE SUITS, HELMETS, SIGNED ITEMS, EVEN COMPLETE F1 CARS

HUGE STOCK OF DRIVER SIGNED PHOTOS, CAPS, AND OTHER INTERESTING ITEMS

WE SELL THE REAL THING!  
NOT "FAKE" MERCDHANDISE  
Visit our showroom weekdays - please phone first.  
Open Saturdays 10.30 till 3pm

**BROCHURE REQUEST LINE: (UK ONLY)**  
**0897 16 11 55**  
Call cost £1.50 covers cost of brochure and postage  
**GRAND PRIX TOP GEAR**  
THE OLD MILL, MILL END, STANDON, HERTS SG11 1LR  
Tel: (0)7000 553949 • Fax: (0)7000 727 929

## MINI-LITE WHEELS

### TECH-DEL Ltd.

manufacturer of the  
**MINILITE WHEEL**  
25b Chertsey Road  
Chobam, Surrey GU24 8PD, England  
Tel: +44 (0) 1276 855502  
Fax: +44 (0) 1276 857534

**MINILITE** the winning wheel

## MODELS

### F1 MOTORSPORT MODELS

1998 SEASON SPECIAL  
1.43 MINICHAMPS F1 CARS

**15.99** INC P+P IN UK

Plus win the chance to see  
**1999 BRITISH GP FREE**

Place your order now  
No need to send money until stocks arrive  
Offer ends 31.8.1998

90 Poplar Avenue, Bedford MK41 8BW  
Tel/Fax: 01234 348146 Mobile: 0589 875063  
MAIL ORDER SALES

## MOTORHOMES

**IVECO 79-14 CAMPER.** Diesel, 5 berth, 6x4 metre awning, fridge, cooker, toilet, shower, heating etc. Large storage. Ideal for karting/single seater. Trailer available. £7,000. Tel: 0468 490198. (71230)

## PARTS

## CITROEN 2CV

IF YOU'VE GOT THE CAR WE'VE GOT THE PARTS

PHONE FOR FREE CATALOGUE

### ECAS 2CV PARTS

TEL: 01785 282882  
FAX: 01785 282883

## RALLYING

### CHRIS HARDEN RALLYING

**Want to go Rallying?**

GPA 205/9 Available for hire with full back up. Just turn up and drive!  
Tel Chris for full details and prices

Tel/Fax: 01495 753481  
Mobile: 0836 225985

## RACEWEAR

### GRAND PRIX RACEWEAR

First for  
racewear  
**No.1 in Europe for Helmets**

Aral BELL SHOEI SIMPSON stand21 sporcoco

POWER ROAD • CHISWICK • LONDON W4 5PY

**0181 987 5500**



UK IMPORTER



Call us NOW with your requirements.  
Sport II, M2 RS; SR Pro, Mag 4, M3,  
XFM-1, Mag R, Mag 5, Vortex, helmet  
bags and accessories.

**demon  
tweeks**  
01978 664466

**ROLLCAGES**

ROLLCENTRE ROLL CAGES. Off the shelf cages or  
custom fit. Contact Peter on 01480 464052, fax: 01480  
494547, or e-mail: rollcentre@aol.com (43287)

To advertise in  
Marketplace  
please call  
0181  
943 5858

**RACING SCHOOLS**



**Start on  
Pole!**

Choose the International Racing  
Drivers Course that leads the  
field

Available in:

- Formula Vauxhall Juniors
- Vectra Super Touring Cars
- Caterham Sports Cars

Course Dates:

10 - 15 August  
7 - 12 September 29 September - 4 October  
2 - 8 November



For details phone:  
01332 811430



71015



**RACEWEAR & EMBROIDERY**

OUR EQUIPMENT COULD SAVE YOUR LIFE

**TOE TO HEAD PROTECTION**

- NOMEX BOOTS ..... from £75
- NOMEX GLOVES ..... from £35
- NOMEX CLAVA ..... from £16
- PROBAN SUIT ..... from £50
- FIA NOMEX 2 LAYER SUITS ..... from £250

ALL PRICES + VAT  
**HELMETS**



FROM £83 - ZERO RATES

DON'T SKIMP ON YOUR LIFE INSURANCE!

SEND FOR OUR FULL PRICE LIST

JAYBRAND RACEWEAR, 363 DOGSTHORPE ROAD,  
PETERBOROUGH PE1 3RD  
TEL: 01733 568247 FAX: 01733 568249



**MIDLAND AUTOMOBILE CLUB**

Founded & Associated with The Royal Automobile Club Since 1901

**Curborough Sprint School**

**Supported by Paul Matty Sports cars**

Learn the Art of Sprinting at Britain's best  
course in safety, in your own  
road car.

No previous experience required.

Qualified experienced Instructors.

Complete theoretical and practical one  
day course with all facilities from £100  
including an excellent lunch and free  
action photo!

**By popular demand an extra day is  
being run on September 29th.**

Contact Jim Robinson on

Tel: 01509 852253

Fax: 01509 852729

Curborough is situated approx 1 mile  
West of A38 nr Lichfield, Staffs.

71237

**RALLY SPECIALISTS**

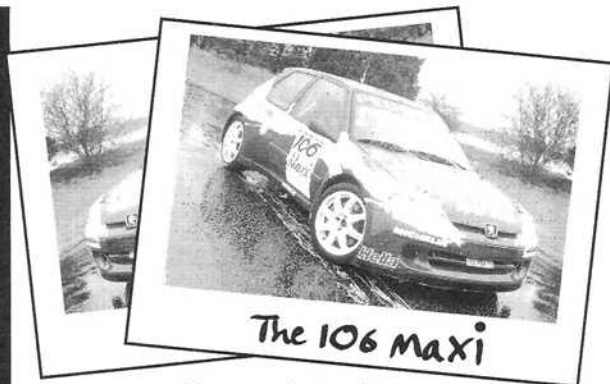

The 106 Maxi

Peugeot Sport Special Tuning

Race, Rally and Performance  
Specialists for Peugeot

**EXPERTS IN RALLYING FORMULA 2**

Peugeot 106 ▶ 205 ▶ 306 ▶ 309

Peugeot Group A, Group N, and Rally Club parts

**DEAL DIRECT WITH THE FACTORY**

Special Tuning, Humber Road, Coventry CV3 1BD  
Telephone: (01203) 884676 Fax: (01203) 884677

15310



**PEUGEOT SPORT**

**RACE PREPARATION**



WE OFFER A PROFESSIONAL PREPARATION SERVICE TO  
ALL COMPETITORS, FROM CLUBMAN TO INTERNATIONAL,  
AND FOR ALL MAKES AND CLASSES OF CAR.

*IF YOU WOULD LIKE TO EXPERIENCE  
WINNING IN A MITSUBISHI  
THEN GIVE US A CALL*

*WE HAVE AVAILABLE NOW FOR HIRE AND SALE  
GROUP 'N' LEFT AND RIGHT HAND DRIVE  
MITSUBISHI LANCER EVO 4'S*

OR

*LET US PREPARE YOUR OWN CAR TO BE A  
CHAMPIONSHIP WINNER*

*(WE HAVE A LARGE SELECTION OF  
PART USED AND TARMAC TYRES FROM £10.00)*



Unit 1 Hikers Way Crendon Ind Est Long Crendon Aylesbury Bucks HP18 9RW

Tel: (0)1844 201025 Fax: (0)1844 201359

SPECIALIST PREPARATION FOR SERIOUS COMPETITION

27279





# JTM RACING SERVICES

*Specialising in Preparation*

Restoration of Race/Rally Cars and Prototypes  
Full Fabrication, Engineering and Set-up Service.

## JTM SERVICES

Hurstfold, Fernhurst, Haslemere, Surrey GU27 3JG  
Tel: 01428 658865 Fax: 01428 661819

**SPARES & ACCESSORIES**



Champions  
1990-1996

## MARDI GRAS MOTORSPORT

SALOON CAR PREPARATION

DISTRIBUTORS AND AGENTS FOR:



Contact Martin Sharpe or Dick Richards

Unit 9/39, Silverstone Circuit, Towcester, Northampton NN12 8TL  
Tel/Fax 01327 858006



## Racer's Hardware

SOLE UK AGENT FOR AURORA RACING BEARINGS

ALSO:

COIL SPRINGS \* AVO SHOCKS \* WELLER WHEELS \* OUTLAW ALUMINIUM CALIPERS \* BRAKE PROP. VALES & BALANCE BARS \* TILTON MASTERS CYLINDER KITS \* REMOTE RESERVOIRS \* BRAIDED HOSE & FITTINGS \* ELLIOT, AUTOMETER, MURPHY RACETECH & TIM TACHOS & GAUGES \* QUICK RELEASE S/WHEELS (13"/15"/17") \* AIR CRAFT SWITCHES \* TOTAL SEAT BELTS \* SIMPSON & MORE

**CALL FOR FREE CATALOGUE**

**RAPID MAIL ORDER**

TEL (01733) 211311/211258 FAX (01733) 211258

# COBRA SEATS



## FACTORY SALE...

HUNDREDS OF ROAD AND RACE SEATS IN STOCK  
~END OF SEASON CLEARANCE~  
ALL RACE SEATS FIA APPROVED  
ALL STOCK AT REDUCED PRICES

**22nd - 29th AUGUST**

MON-FRI 3PM TO 7.30 P.M. SAT/SUN 10 A.M. TO 5.30 P.M. FOLLOW PINK SALE SIGNS FROM JUNCTION 4, M54 COBRA SEATS, HALESFIELD 23, TELFORD, TF7 4NY.

TELEPHONE 01952 684020

## RACEPARTS (UK) LTD

Unit 3, Rockfort Industrial Estate, Wallingford, Oxon OX10 9DA  
Tel: +44(0) 1491 837740/837142 Fax: +44(0) 1491 836689 E-Mail: sales@raceparts.co.uk

**Our Racetech Products Include:** Quick release steering wheel couplings and steering wheels - Electrical & Mechanical instruments - Electronic tachometers - Adjustable brake balance bar assemblies - Race mirrors - Thermal paint kits - Suspension springs - Refuelling eqpt.

**Official distributors for:** CASTROL SRF - Racing Brake Fluid  
ADA PRODUCTS - Corner weight gauges, Camber castor gauge  
AEROQUIP - Hose & Fittings : SYMETRICS - Dry Break Couplings  
SAENZ - Connecting Rods : HEWLAND - Gearboxes, Ratios & Spares GKN - CV Joints & Boots : MOLLART & APEX - Universal Joints SUPERTRAPP - Silencers : NMB - Rod Ends & Spherical Bearings FERODO - Brake Pads : AP - Brakes & Clutches : DZUS - Fasteners VARLEY - Batteries : SERCK - Oil Coolers : LZEL - Luminescence

Worldwide Export Service

## ICORE PTFE ProGold

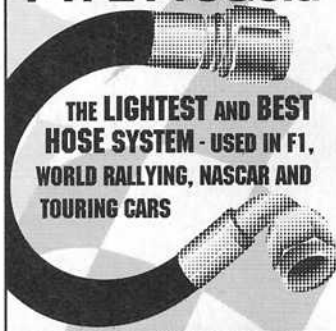

THE LIGHTEST AND BEST HOSE SYSTEM - USED IN F1, WORLD RALLYING, NASCAR AND TOURING CARS

FREE BROCHURE & STOCKIST  
CALL 44(0)1753 552266 EXT 225

## SAMCO Sport

1ST CHOICE FOR PERFORMANCE HOSE

Full range of coolant, fuel, turbo, vacuum, performance hose kits & lightweight kart hose available in tough temperature resistant silicone. Various colours available.

**demon tweeks**  
01978 664466

## Trident

Racing Supplies

### The Right Component

AN/NAS Bolts, Washers

Locknuts, K Nuts, Anchor Nuts

Heatshield Materials

Blue Silicon Water Hoses

Versachem Adhesives & Sealants

Silicon & Neoprene Ducting

Rod Ends, Instruments, Pit Equipment

Mintex, Advance Tapes, Camloc

Dzus, Würth, Alcon

Tilton, Earls



Every Time...



TEL: 01327 857822 FAX: 01327 858096  
Unit 31, Silverstone Circuit, Towcester, Northants NN12 8TN  
<http://www.tridentracing.co.uk>



**Graham Goode Racing**

Ford Cosworth & Subaru Impreza Specialists

• Performance is everything •



SUPPLIERS TO MANY TOP RACE AND RALLY TEAMS THROUGHOUT THE WORLD

SEND FOR OUR COSWORTH OR SUBARU BROCHURE. £3.00 INC P+P OR FOR FURTHER INFORMATION

VIEW OUR WEBSITE AT

<http://www.grahamgoode.com>

Visit our purpose built complex at: Lutterworth Road Leicester England LE2 8PH (just off M1 junc. 21) Fax: 0116 244 0140 E-mail: sales@grahamgoode.com

TORQUE TO THE PROFESSIONALS 0116 244 0080

MAIL ORDER 24 HOUR



TRANSAX

**TRAILERS & TRANSPORTERS**

**MERCEDES 307D ALUMINIUM BOX TYPE TRANSPORTER.** Carries 1 car, 1987, MoT & tax February 99, new engine, 5 speed, awning 240V facilities. Expansion forces sale. £3,295 o.n.o. Tel: 0850 656543 or 01977 612099. (27208)

**FOR SALE - CANCELLED ORDER.** Covered trailer 3,500kg gross. Over wheels, beaver, twin axle, 16ft x 7ft6", bflg, full ramp tail, aluminium tread plate, solid nose and canvas covered body. £3,000 + VAT. Tel: 0151 647 9100. (27177)

**BOX TRAILER.** Takes saloon plus sleeps 3 people, heating, cooking etc. Need's to go behind lorry or motorhome. Currently towed by Dave Longhurst. £3,000. Phone: 01243 586107, mobile: 0860 587363. (27199)

**SINGLE CAR TRANSPORTER.** Purpose built for racing, Talbot Express, 1986 2.5 litre diesel, ideal with trailer for carrying 2 cars £2,500. John Carter Tel: 01480 437210 (eves) 01536 744515 (days). (00000)

**TEST DAY**



**GENERAL PRACTICE**

Every Wednesday Morning £55.00.

Please phone to book

**01455 842931**

Off the A47, between Leicester & Hinckley.

**WEB SITES**



**racecar**

Whether you want a water-pump for a Ferrari F1 turbo engine  
A complete Formula Renault engine  
Or a Momo 3 spoke off-road steering wheel for a Shogun  
Go to [www.racecar.co.uk/racecarparts](http://www.racecar.co.uk/racecarparts)  
Our FREE service for people buying and selling race and specialist car parts  
Telephone + 44 (0) 1483 203781 Fax + 44 (0) 1483 203261

**WORLDWIDE CLOTHING**

• BOSS • CALVIN KLEIN • DOLCE & GABBANA

**WORLDWIDE CLOTHING LIMITED**

WORLDWIDE HOUSE • BROAD ST. • RAMSGATE • KENT CT11 BNQ • TEL 01843 588954 • FAX 01843 853947  
7 DAYS A WEEK 8am to 11pm

**Designer ...**

Pullovers, Sports Shirts, Jeans, Socks, Ties, Silk Underwear, Swimming Shorts, Jackets, Kate Winslet and Leonardo Dicaprio T-Shirts, 7 Choices of logo from Titanic, Baseball Caps., Leather Belts, Gucci, Benneton, Adidas, Nike, Timberland, Dolce & Gabbana, Tommy Hilfiger, Reebok, Lacoste, Nautica, Fila, Versace, Calvin Klein, Armani, Hugo Boss, Ralph Lauren and lots more!



ALL SIZES S/M/L/XL/XXL/XXXL

Telephone or Fax your address for a FREE colour brochure

**BUY AT WHOLESALE PRICES!**

**PRICES START AT £10.00**

**FREE Postage & Packaging**

• GUCCI • VERSACE • ARMANI • TOMMY HILFIGER • ADIDAS • FILA • LACOSTE • NAUTICA • NIKE • POLO • REEBOK • TIMBERLAND • HUGO

**WHEELS & TYRES**

FOR ALL YOUR **AVON** RACING TYRES  
Inc. ACB 10 Formula Ford Contact 62806

**BMTR LTD.**  
Tel: 0121 331 1122  
Fax: 0121 331 1144

**WALTHAM SERVICES FOR**

**AVON**  
COMPETITION TYRES  
WELLER & COMPOMOTIVE WHEELS  
TEL: 01245 491702  
0860 255312  
FAX: 01245 344172

**WIRING & TELEMETRY**

(longevity) n. long life l. lasting or extending over a long time  
2. well established.

**Longus Aevum**

Tony James is the longest established wiring harness manufacturer dedicated to motor sport

**TONY JAMES COMPONENT WIRING LTD**

E10 Speedwell Way - Harleston Industrial Estate - Harleston - Norfolk IP20 9EH - England  
Tel: 01379 854485 - Fax: 01379 852718



**CAR TRANSPORTER  
TRAILER SPECIALISTS.**

**BRIAN JAMES TRAILERS**

Est. 1979

Quality, value for money, choice and customer service really do count at Brian James Trailers.



**Auto Trailer**, a remarkable automatic tilt-bed system revolutionises trailer loading. Designed for ultimate ease of use.



**Race Shuttle**, unique fully enclosed GRP moulded body system keeps a large range of cars clean and dry.



**AD Series Evolution**, excellent loading performance from hydraulic tilt operation. High quality and versatile.



**A-Series**, quality design with low centre of gravity and excellent towing stability. Ready for many years of service.



**MINNO**, designed to transport small race and classic cars. Light and easy to handle. Can be stored in your garage.



**CLUB Tilt-bed**, light duty tilt-bed car transporter trailer. Includes full deck and spare wheel in an unrivalled value package.

Brian James Trailers .Silverstone area. Tel : (01327) 260733 Fax : (01327) 262438

**DASTLE RACEBOX**



- Lightweight Van Trailer/Working Facility
- From 12 to 20 ft floor length versions
- Worktop, cupboards and storage shelves
- Side access door

For your racing to realise its full potential, start with the right equipment. Talk to us about The Dastle Racebox.

Call or write for details:

Guildford, Surrey GU5 9QQ. Tel/Fax: (01483) 202813

<http://www.racecar.co.uk/dastle>

58418

**moose trailers**



Manufacturers of the Moose Workstation & Clubman Trailers. Prices start from £4,900 + VAT for the clubman - 2,600kg gross. Workstation prices dependent on Bespoke requirements. Quotations available on application.

For full details on both the Clubman and Workstation trailers, please call **0151 647 9100**

68950



**AMERICAN MOTOR HOMES DIRECT SALES + HIRE**

Hire a six berth motor home from only £100 per day

(01362) 858544 Chris (Sales)

(01494) 564357 Graham (Hire)

70666

**PRG**

Engineering

**TRAILER TECHNOLOGY**



**Millennium and Eurolite Series**

Superior by design all integral chassis, tilt and fixed bed car transporters giving excellent all-round performance.

**Race Hauler**



Quality fully enclosed car transporters, available in many sizes.

**WE MANUFACTURE ALL TYPES OF CAR TRANSPORTERS**

Phone for full details

TEL (01270) 812402 FAX (01270) 811293

26428

1988 Mercedes 811D 7.5T (non-HGV) with nicely built Luton body by W. H. Bence. Only 51,082 kms (31,600mils). Used by Team Gillard for Euro/World karting Championships. Repainted '97, new tyres, towbar, nice living area with fridge, stove, water, plenty of cupboards, 3 seater table and 2 bunks over cab. Rear portion configured as mobile workshop. Very suitable for independent racer at home or abroad. Good condition.

**£9,250 + VAT**

CALL MR TURNER

TEL: 01451 861042/FAX: 861044

71174

**H.G.C.H.**

AMERICAN MOTOR HOME HIRE



- ◆ Available for Motor Racing and Hospitality
- ◆ 8m x 5m awning available

For further details

Tel/Fax: 0161 456 4122 or 0385 111031

70685

**AMERICAN MOTORHOMES**

- SALES
- SERVICE
- PARTS
- HIRE



- ★ 'A' Class
- ★ New
- ★ Export
- ★ Slide-outs
- ★ 'C' Class
- ★ Used
- ★ USA Delivery
- ★ Pushers

The complete service only at

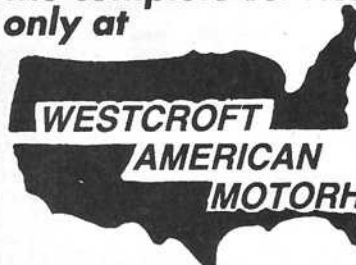

**NOBODY BEATS US FOR PRICE**

CANNOCK ROAD, WOLVERHAMPTON WV10 8QU, ENGLAND  
Tel: (01902) 731324 Fax: (01902) 724494

**CALL 01902 731324**



40ft Wilson double-deck trailer. Two stage tail lift freshly painted yellow and black. Will take six Caterhams or single seaters. Available with Alfred Bull awning (needs small repairs). MOT to April '99.

**£14,000**

Phone Clive 01327 858877

71178



**CASTLE MOTORS, KENT - 01227 472301 0831 818018**



**Maverick Diesel.** 1999 S reg. Diesel George Boy 31' C-class Motorhome, full Basement model on latest Ford Cab with Power stroke Turbo Diesel engine. Ducted Aircon, Microwave Generator, Tow pack Awning etc., etc. Superb floorplan, sleeps 8 with Rear Queen and open bathroom. Delivery mileage only **£41,950 + VAT**



**Dolphin Diesel.** Dolphin 199 33' Rear Diesel pusher Motorhome, full Basement 'Osh' Kosh chassis cummins Turbo Diesel, Twin roof, Aircon, Microwave Generator, Rear Camera, Tow pack Awning. Fantastic floorplan with rear Queen. This very upmarket Motorhome is presented in as new condition **£38,995 + VAT**



**Coachman Diesel.** 1995 Coachman 31' Rear Diesel pusher Motorhome, Basement Storage - spartan chassis Chevrolet Turbo Diesel, Roof and Cab, Aircon, Microwave Generator, Tow pack Awning Rear Queen, Sleeps 6, perfect inside and out. Unbeatable at **£31,995 + VAT**



**Damon Hornet.** 1993 Damon Hornet 27', C-class Petrol Motorhome on New Shape Ford Cab with fuel efficient engine, Microwave Generator, Roof Aircon, Awning etc. Spacious floor plan, sleeps 6, real value at **£18,495 + VAT**



**Green Day Van.** 1995, New Shape Dodge Dayvan, Dark Green Metallic, Beige cloth interior, Aircon, Auto, PAS, Air bag, Alloys, running boards arches 7 seater, Electric rear couch, beautiful conversion absolutely mint. Be quick at **£9,995 inc. VAT**

# NEED A SPONSOR?

## New sponsorship guide shows you how to find a cash sponsor for motorsport.

Based on years of experience finding money for young, unknown, sometimes unsuccessful drivers, this simple system saves time, money and heartache. It gets fast results without cold-calling or large amounts of wasted proposal preparation - perfect for the amateur sponsorship hunter.

The secret? It works because we understand the problem of getting noticed in a swamped sponsorship market, when you have so little time available, and perhaps not very much in the way of a racing background. Our basic assumptions are a) you want to drive a race car, and b) you're not wealthy or connected. No gimmicks, no nonsense, just straight talk, hard facts and good, quick results.

Sounds too good to be true? It might, but this guide is already used by racers in FF, FRS, F3, and even F1. Sounds a bit like a con? It might, but we've never once had a guide returned, and we also put money back into racing to prove our good faith - you can find our logos on cars in FF and F3.

**So why spend another season watching, when you could be out there racing?**

**Start your career today.**

**Send your name, address and cheque for £19.99 incl. P&P to:-**

**SportsWorks Publishing, Suite 525, 29-30 Warwick Street, London W1R 5RD, UK**

### SUPER WINCH



#### 12V D.C. ELECTRIC WINCHES

The ideal solution for pulling dead cars onto transporter trailers.

**Freephone 0800 525629**

**MAYWOOD GARAGE EQUIPMENT LTD**

### 40' STEPFRAME TRAILER

2 saloon cars + workshop + luxury living accommodation. Professionally converted to the highest standard 3 years ago. Virtually everything you could want including self seeking satellite.

**£55,000**

**Tel: 01423 870630**

**0836 524993**

**Dastle racebox, new tyres and suspension, lined roof, extended rear doors.**

**V. G. C. £4000**

**TEL: 01747 853296**

### AIRSTREAM 350

36ft tag axle, twin lounge hospitality motorhome.

In excellent condition. 1991 Cummins diesel 5.9 serviced by Cummins. Full safari room awning. Picture and floor plan on request.

**£39,500**

**Day 0181 572 3535  
Evening 04183 761308**

**Transporter, Renault Master 2.5 diesel low loader box van. With ramps suits FF2000 etc. No Tax/MOT but very reliable.**

**£850 ono**

**Hertfordshire  
Tel: 01727 841167 days  
01727 845276 eves**

To advertise in Trailers & Transporters please call

**0181 943 5858**



## SPORTS &amp; PERFORMANCE

## BMW

**BMW RARE 733i.** Manual, 1978, 36,000 genuine miles, 2 registered owners from new. White/blue velour/blue tinted windows. Full BMW service history. As new - Any Inspection. £5,500. Tel: 01653 698312. (27221)

## CATERHAM

Woodcote Sports Cars  
Caterham/Lotus 7 Specialist

1995 5 speed live 1700, BRG/alloy, cycle wings	£11,950
1997 5 speed 1600, BRG/yellow	£15,500
1997 4 speed 1600, red/alloy	£12,250
1997 5 speed live, 1600, red/alloy	£12,750
1994 5 speed 2.0 Vauxhall, BRG/yellow	£16,950
1998 4 speed 1700, red wings	£14,000
1993 5 speed 1700, anniversary green	£14,250
1996 5 speed 1700, anniversary green	£16,000

**PLUS MORE IN STOCK - WANTED: ANY 7**

7 Kits built to your specification  
Located 5 minutes from Caterham

Tel/Fax: 0181 641 9897 • Mobile: 0831 240733  
www.Racecar.co.uk/Woodcote 2724834

**CATERHAM 1700SS.** G reg, 9,700 miles, red, five speed, De-Dion, harnesses, leather, adjustable seats, full weather equipment etc. Excellent condition. £11,950. Tel: 0113 230 2104. A/V. Private Sale. (27100)

**CATERHAM SEVENS.** Authorised Centre for NEW AND PRE-OWNED CARS. Stock constantly changing. For SERVICE, REPAIRS, PARTS etc. call CLASSIC CARRIAGE CO. 01455 841616. (25468)

**CATERHAM SUPER 7 1700.** 155 bhp, G reg, pearl yellow, cycle wings, prisoner alloys, leather, chrome rollbar, high vis weather gear. £12,500. Tel: 01256 770575. Private. (27249)

## SUPER 7

2.0 litre turbo 240+ bhp. Unique factory built, every go faster, safety & comfort option. Ideal track day & road car. 4,000 miles only. Blindingly fast with no temperament.

**£22,000**

Tel: 01491 720850

CATERHAM 7  
SUPERSPRINT

1992 K, midnight blue with yellow '7' grille, 9,000 miles, 5-speed, De-Dion, cycle wings, prisoner alloys, black leather adjustable seats. Motolita, increased vis, weather equipment, Tonneau, sidescreens, heater, tinted head screen, 4-point harnesses, oil cooler, 'Lumention'. Just serviced by Caterham, new re-located battery, full history, always garaged, perfect condition.

**£12,995**

Tel: 0171 405 4545 W - 0171 731 5101 H

## EXOTIC SUPERCAR

THE WORLD'S MOST  
EXOTIC SUPERCAR  
McLAREN F1

Powered by a BMW V-12 engine, 627 bhp at 7,400 rpm, and more than 479 lbs of torque at 4,000-7,000 rpm. At 240 mph, the McLaren F1 is officially the world's fastest road car. Better acceleration over 130 mph than a Formula 1 car. Ask for pre-owned cars.

Contact: Joerg Schaefer  
Tel: 49 171 614 1044 mobile  
Fax: 49 6126 59640  
in Germany

## FERRARI

**FERRARI 355 F1 GTS.** 1998, LHD, perfect. Tel: France 33 612 455 218. Ferrari 355 Spyder. LHD, 1997, perfect. Tel: France 33 612 455 218. (26976)

**FERRARI ENGINE 365.** £7,000. V12. Tel: France 33 4 92 38 04 11, fax: 33 4 92 38 04 12. Ferrari 250 GT Drogo. 1962, LHD, FIA papers, 300CV, dry sump GTO engine, GTO gearbox. 1,200,000FF. Tel: France 33 4 92 38 04 11, fax: 33 4 92 38 04 12. Ferrari Daytona 1972. Red/cream. 545,000FF. LHD. Perfect. Tel: Belgium 32 4 247 47 42. (26975)

## FORD

**FORD CAPRI LAZER 2.0 LITRE.** Auto, red, 3 door saloon, C reg Feb 86, pas, colour co-ordinated bumpers, one owner from new. 14,000 miles only. Very good condition. £1,995 o.n.o. Tel: 01689 872371. (27134)

**FORD GT40.** Race car, 1965. Tel: France 33 4 92 38 04 11, fax: 33 4 92 38 04 12. (26979)

**FORD GT40, 1995, GTD 5000cc FORD V8 SV0.** 285 bhp, air con, silver, yellow leather trim, professionally built, all new parts, Clifford alarm, 3,500 miles. Stunning car, No joy riders. Tel: 01268 794070 or 0860 427650. (27021)

## JAGUAR

**JAGUAR XJ 220 S.** Race car, 700CV, LHD. Tel: France 33 4 92 38 04 11, fax: 33 4 92 38 04 12. Jaguar XJR 15. 1991. The \$1 Million Challenge. Only 50 built. Tel: France 00 33 4 92 38 04 11, fax: 00 33 4 92 38 04 12. (26977)

## LAMBORGHINI

**LAMBORGHINI LM 002.** Race car, Paris Dakar. 300,000FF. Tel: Lux 352 45 38 20. (26978)

## LANCIA

**LANCIA DELTA INTEGRALE EVOLUZIONE.** End 1992, metallic burgundy, genuine 31,000 miles, full Lancia service history, abs, a/c. Immaculate and original. £16,450. Tel: 07771 791336, London. (27251)

**LANCIA INTEGRALE EVO. VERDE YORK.** HR 91, world rally champion, 1992, 1 owner, history, excellent condition. £20,000. Tel: +32 3353 2224, fax: +32 3353 2719. (27062)

**LANCIA STRATOS STREET VERSION.** Yellow, 5,000 km only. Perfect original, LHD. Tel: Belgium 32 2 215 16 99 or 32 75 819 820, fax: 32 2 215 16 69. (26974)

## WALKERS

FACTORY APPOINTED INTEGRALE  
SPECIALISTS FOR UK

96 N Ferrari 355 GTS. rosso/nero, LHD	£67,500
New Evo "Martini 6", delivery miles	£90A
92 J Evo "Clubs Italia", no. 4 of 15	£27,000
94 L Evo Kat, Monza red/alcantara	£23,500
94 L Evo Kat, white/beige/alcantara	£23,500
94 L Evo Kat, pearl white/blue leather	£19,995
92 K Evo, met. black/sage/alcantara	£17,000
92 K Evo, Monza red/leather	£17,000
92 J Evo, white, sage/alcantara	£17,000
92 K Evo, met. black/leather	£16,000
92 J Evo, Monza red	£16,000
92 J Evo, met. black/alcantara	£15,000
91 Evo, Monza red, big seats	£14,000
90 G 16v, Winner red/alcantara	£9,995
89 F 16v, met. black/alcantara	£9,500
775 Lancia Beta Monte Carlo	£6,995

Prices include 12 months road fund  
Warranty & Breakdown Cover - Fully serviced  
http://www.walkers-garage.co.uk



**NORTHALLERTON**  
01609 777221

## LEFT HAND DRIVE

**LHD - BEST PRICES IN BELGIUM.** Mercedes/Porsche 966/Boxter/CLK/SLK. RHD Rovers. Tel: 0032 652 1418 or mobile: 0032 7546 1418, fax: 0032 3 321 5955. (27176)

## LOTUS

1967 LOTUS ELAN  
S3 SE DROPHEAD

Fabulous condition, Norfolk mustard, recent paint, rebuilt engine, box, new chassis, brakes etc.

11 months MoT, history and bills.

**£11,000 o.n.o.**

## ALSO 1978 MARCH F3

Fully rebuilt.

**£10,000**

Tel: 01335 350473

## MASERATI

## MASERATI MERAK S5

1983, blue, 29,000 miles, history. Very good condition.

**£14,950**

Tel: 0181 838 3535

Fax: 0181 838 3300

**MASERATI GHIBLI 2.8.** 1993, blue met., beige leather, full option, 1 owner, history, excellent condition. Price £15,500. Tel: +32 3353 2294, fax: +32 3353 2719. DVA Sport - Schilde - Belgium. (27061)

**MASERATI V8 REBODY 450 S.** 100% alloy, 340 CV, RHD, Borrani wheels. Tel: France 33 4 92 38 04 11, fax: 33 4 92 38 04 12. (26981)

## MITSUBISHI

**MITSUBISHI SCORPION:** Rare fast, beautiful turbo, mexican red, black leather seats, excellent condition, elderly lady owner. D reg, 51,000 miles. £2,950. Tel: 01483 531714 evenings. (27227)

## PORSCHE

**PORSCHE 928 S4 GTS STROSEK.** LHD, 95/96 European Championship winning car, ready to race. Phone for full spec. £18,000. Tel: W 07000 9911911. H 0121 686 1865. (27197)

**PORSCHE 959 GR B.** 1985, 400 CV, silver. Fax: France 33 1 47 45 76 59. (26980)

**PORSCHE GT2 993.** 1997, 9,000km, left hand drive, Bugatti blue with black/grey leather interior. A/c. 480 bhp. £90A. Tel: 0181 209 0481, 0836 560300. No canvassers. Private Sale. (27146)

## RENAULT

**RENAULT SPORT SPIDER.** P3 R55, blue, 200 bhp, Harlow Motorsports engine, comp exhausts, £6k spent. Spare OZ wheels with slicks. £24,950. Tel: 01273 455574. (71236)

## REPLICAS

**CRENDON CR427 COBRA.** 351 Cleveland, big valve, Ford top loader gearbox, Jaguar running gear, navy with black leather trim, 6,000 miles since build, tonneau. One of the best Cobra Replicas. £22,000. Full details Ken 01455 843014. (27156)

## RS200 REPLICA

Professionally built by Mercury Motorsport. Bills for parts exceeding £26,000. Metallic Blue, 17" wheels with new tyres, leather interior, CD player and new Cosworth engine.

**£20,000 ovno**

Tel: 01245 400 890

Mobile: 0797 0678 776

**FERRARI DAYTONA SPYDER REPLICA.** EG Autocraft Arrow Spyder, built by Emilio Garcia. Jaguar XJS HE based, stunning in red with magnolia hide. Power steering, e/windows. Full feature in Kit Car Magazine 7/98. £22,500. Tel: 01293 884030. (27048)

**FRAZER NASH:** 1938 Fraser Nash TT Replica Special. Original registration, Meadows engine, all in mint condition. Blue Form - £32,500. Fraser Nash Shelsley. Total rolling replica chassis. Body instruments, windscreen, aeroscreens, petrol tank, wings, undertrays - Offers. Miscellaneous engines to suit: Meadows 4ED, totally restored, twin bronze carburetors, restored mag., dynamo and starter. Supercharged single port head, 3-branch exhaust system - £6,500. AC 6-cylinder engine complete with carbs, dynamo, starter. Unknown entity - £2,000 plus. Tel: 01462 768532, fax: 01462 768824. (27070)

**FRAZER NASH:** 1934 Blackburn Engine TT Replica. Most original Nash, still factory fresh with no modifications, exceptionally fast. The first body built by AFN Ltd., first sloping radiator. My property for 35 years plus, raced, rallied successfully by Bill Bradley for many years, VSC plaques on body. Nash section now have Bill Bradley Cup Awards each year in his honour. 1971 - 3rd in the Lady's race at Nurburing, fastest time at Vaals hillclimb, 1 min 13.85 secs - only 17.4 secs behind the fastest man of the section. Known as the only prewar Continental - Thrilby's book. 1934 March Motorsport p.150. Engine totally restored by Robert's of Whitwell. Carburetors by Burlingtons, exceptionally rare, requires cosmetics. Blue Form - £65,000. Tel: 01462 768532, fax: 01462 768824. (27082)

**FRAZER NASH:** 1956 Continental V8 BMW Engine L Mans Replica. Exhibited on Frazer Nash's stand for the 1956 Motor Show. Purchased in chassis form by Paul Fletcher and entered for the '57 Le Mans 24-hour race. Kerwin Taylor designed a saloon body shell specifically for the race and Peels of Kingston made it in six weeks, the ancestry of the Lotus Elite is quite clear to see and the body is available. In the last 13 1/2 years of my ownership a MK I Le Mans Replica body has been fitted, totally rebuilt to concours d'elegance condition in British Racing Green with green hide trim. Highly polished aluminium engine. Full FIA papers with comprehensive study file and history, numerous letters from Jenks, AFN Ltd and previous owners. An extremely rare and desirable car. Pure '50s racing car with De Dion rear suspension, limited slip diff, standing on Dunlop Racing tyres. The first of only two Continentals made and the only one with dual chassis numbers - £110,000 o.n.o. Tel: 01462 768532, fax: 01462 768824. (27083)

**FRAZER NASH:** Jaguar SS100 Replica. Rolling chassis, fitted with engine, gearbox, back axle, radiator shell, reconditioned starter and dynamo, wheels etc. Body, petrol tank, full instrumentation, petrol pumps, cut out, windscreen, hood frame, V5. Large box of miscellaneous bits - Offers required. Tel: 01462 768532, fax: 01462 768824. (27084)

## SUBARU

H.D.C.  
SUBARU

Suppliers of new & used  
spares for Legacy/Impreza.  
Standard/modified.

Tel: 01422 846868  
Fax: 01706 812072

Specialising in Subaru's  
for over 14 years

## ARROWSTAR RACING

Centremead, Osney Mead, Oxford OX2 0ES  
Telephone: 01865 201155 Facsimile: 01865 201177

1998 R	1800 K Series	Mercedes, silver, 1,200 miles. As new	£18,995
1997 R	1600 S/S Anniversary	Metallic red with silver stripe. As new	£18,995
1997 P	1600 Supersport 6-sp	BRG/yellow nose	£17,995
1996 P	1600 Supersport 5-sp	Red, LSD etc. 5,000 miles	£17,995
1995 N	Vauxhall HPC Carb	Yellow with flared wings. As new, 2,000 miles	£18,495
1993 L	Vauxhall HPC Inj	Green/yellow with flared wings	£16,995
1993 K	Vauxhall HPC Carb	Blue/yellow anniversary, flared wings. Excellent	£17,995
1995 N	1400 Supersport 6-sp	Jaguar Racing Green, flared wings, leather	£15,995
1995 N	1400 Supersport	Metallic blue with silver anniversary stripe	£15,995
1996 P	1400 Supersport	Dark blue with cycle wings, race/road car	£14,995
1995 N	1400 Supersport	White with cycle wings, race/road car	£14,995
1992 J	1700 Supersprint	De Dion black with cycle wings, high spec	£13,495
1995-7	1400 Supersport	Choice from	£12,995
1990 H	1700 Supersprint	Live axle, red with cycle wings	£10,995
1997 Q	1700 Supersprint	Live axle, black with cycle wings	£9,995

PLEASE CALL FOR DETAILED SPECIFICATION SHEETS

MOST CARS ARE LOW MILEAGE AND HAVE 12 MONTHS WARRANTY. FINANCE AVAILABLE SUBJECT TO STATUS

Official Caterham 7 Centre



**SUBARU IMPREZA  
TURBO  
4-WHEEL DRIVE**

1 owner, full service history, 4 door, red, 1994 M reg, high mileage.

£Offers

Home 01799 599267  
Work 01992 565565, Ext. 512  
Mob 0836 298865

7151434

**TOYOTA**

**TOYOTA MR2 2.0 GT T BAR.** M reg, finished in black with black full leather trim. 18,000 miles, F1sh, CD, speedline alloys, garaged. Absolutely immaculate. £15,350. Tel: 0171 320 9172. Private Sale. (27040)

**TVR**

**TVR VIXEN.** 1972 with Rover V8 injection engine & 5 speed box. £1,000's spent to make this one of the best available. A real wolf in sheeps clothing. A credit to the clever dick who did the conversion! £6,950. Tel: 0121 743 5276/01564 779746. Bob Adams - Supply Affordable Classics for 20 Years. (27223)

**VARIOUS SALOONS**

**HUMPHREY'S  
& FOULKES**

Importers for Mitsubishi EVO5's and Subaru WRX for 15 years.

For best prices  
Tel: 01686 625316  
Fax: 01686 622192

2702031/0203034

**VENTURI**

**VENTURI 400 GT TROPHY.** LHD, number 34 of 50 produced. Road registered, brand new, never used. 400 bhp, 980 kg. Awesome performance, quicker than any Ferrari!! £49,500. Tel: 0181 209 0481 or 0836 560300. N/C. (27043)

**WESTFIELD**

**WESTFIELD SEI.** Wide red cycle wings, Vauxhall 16V, 175 bhp, 5-speed 15" rimstocks, h/back, Corbeau seats. New MoT, taxed, 2,500 miles. Superb. £9,250. Tel: Giles 01580 211172. (71234)

**SPORTS & CLASSICS**

**A**

**AC GREYHOUND.** BEF2517 Serial No., Reg No. JM6452. Bristol 110 engine and o/d box. Princess blue with original red interior, chrome wires, good condition. 12 months MoT. £9,750. Tel: 01642 722935. (27193)

**ALFA ROMEO GTA 613650.** Stunning example, correct gearbox, differential, brakes, suspension etc. FIA papers. £29,500. Tel/Fax: +35 656 4804/623 5353. Holland. (27175)

**ALFA ROMEO ORIGINAL PININFARINA.** Canvas softtops or famous Haartz 'Stayfast' canvas. Crafted by original supplier to Alfa in Italy. Also original material seat covers for Alfas from 1947-1996. Concurs correct vinyl or cloth, or a much nicer than original, vat dyed leather on request. Shipped direct from Italy, no customs duty on importation. Call USA office to arrange shipping. Re-Originals - Tel: 281 807 1945, fax: 807 1946. (26938)

**ALFA ROMEO SPIDER.** 1972. LHD. 1987 restoration, finished in dark metallic blue. Excellent cared for mechanics and suspension on rust free body shell. Great all round car. £6,250 o.n.o. Tel: 0171 349 0240 daytime. (26902)

**'IL MONSTRO' ALFA ROMEO ZAGATO RZ ROADSTER.** 1995, 'N' Giallo Fly/black hide, 12,000 kms. - 7,500 miles, fsh, ac, pas, CL. Speedline split rims etc. A rare opportunity to purchase 1 of only 250 ever made. All usual dealer facilities. Only £29,995. Tel: 01704 821012. T. (27273)

**ASTON MARTIN V8.** Auto, Series 3, 1974, superb condition. Factory electric sunroof and driving lights. A nice usable car. Full MoT. £17,000 o.n.o. Tel: 01327 843493. (27245)

**ASTON MARTIN V8 OSCAR INDIA SERIES 4.** Nov '78, Canterbury blue, full magnolia hide and walnut. Fabulous condition. H.W.M. maintained. S/s exhaust. £29,950. Tel: Camberley 01276 671009. (27173)

**ASTON MARTIN V8 VANTAGE.** 1983, blue with blue leather, 47k miles, manual. Superb condition throughout. Extensive history. £37,500. Tel: 01296 622022. (27133)

**ASTON MARTIN V8 VOLANTE.** 1981, repainted in metallic blue/beige hide. Auto, sports exhaust, latest wheels, elec. mirrors, chassis restored. Mohair hood, Aston agents history. Immaculate condition having had £12,000 restoration spent. £57,500. Tel: 0121 308 4332. (26896)

**ASTON MARTIN DB6 MK1.** 5 speed, lovely car in light blue metallic. New MoT, just serviced. £21,000 - No Offers. Tel: 0171 235 8913. Private. (27214)

**ASTON MARTIN VANTAGE VOLANTE.** 1988, white with black mohair hood. Magnolia trim piped with black. X pack, left hand drive, 1 owner, 4,000 miles, FSH, concours condition. £POA. Also left hand drive Lagonda 1986, 20,000n white, as new. £POA. Also LHD Virage, factory 6.3 conversion, 500 bhp, 5 speed, wide body, black/black leather, 12,000 km. £65,000. Tel: 0181 209 0481 or 0836 560300. (27045)

**AUSTIN HEALEY 100/4 B.N.I.** LHD, structurally superb California car for restoration. £8,950. Restored 3000 MI llls wanted. Tel: 01723 361227, fax: 500370. Visit our web site: murrayscott.nelson.com (27240)

**AUSTIN HEALEY 3000 MIII PHASE II.** Red with chrome wheels and black interior, no expense spared in restoration which can be appreciated when viewed. £25,000. Tel: Peter Locks 01892 783894. (27194)

**BIG HEALEY RESTORATIONS**

All aspects of Austin Healey repair undertaken, conversant with Big Healey since 1958 with many concours wins (1993 Australasian Healey, meet outright winner Perth Western Australia).

- Engine rebuilding
- Gearbox - overdrive rebuilding
- RHD steering conversion kits

**Cylinder Heads:**

- Unleaded - Gas Flowed - Polished and Ported - Go green 100/4 - 100/6 - 3000 - Sprite

• Austin Healeys bought and sold - usually a small selection available.

Full servicing, tuning and repair.

**Tel: (44) 01623 871908**

27192034

**AUSTIN HEALEY 3000 MK II.** 1961, LHD, red with black interior and hood/tonneau, c.w.w., overdrive restored in 1989, summer use only. A very nice driving car, ready to go. £16,500. Tel: Cambridge Motorsports 01767 677969. (27285)

**AUSTIN HEALEY TOADHALL SPECIAL.** Based on a 1957 Healey with a wonderful 1930's retro style alloy body. 2.6 litre engine with 4 speed gearbox & o/d. A marvellous car to drive, real flies in the teeth motoring for £9,750. Tel: 0121 743 5276/01564 779746. Bob Adams - Supplying Affordable Classics for 20 Years. (27224)

**AUSTIN HEALEY MARK III.** 1964, Series 1. Black with red leather trim, reconditioned by Brown & Gammons. Chrome wire wheels, ss exhaust. Excellent condition. £24,950. Tel: 01480 469776. Private Sale. (27074)

**B**

**BENTLEY**

1931, 8 litre,  
CHYF5012, ENYX51A,  
just run in since total  
mech restoration,  
counterbalanced crank,  
Swearingen rockers,  
shell mains, full flow  
oil filter, new two-seat  
body, fabric covered.

**\$395,000**

Ph.: 214 824 2851 days  
Fax: 214 824 2658, TX

19641733

**1927 BENTLEY.** 3 litre, red label, speed model, in lovely condition, continuous history with B.O.C. Please Tel: George K Dodds, 0181 366 7056 or fax: 0181 366 4711. (27218)

**1926 BENTLEY**



3L SS 100 mph mod, chassis LM 1350, reg UE 1354, Green Label, 1/18 built, 6 exist, 10'10" std w/b frame w. VDP replica 4-pass, 2-dr Weymann-Type fabric body, 6k mi on older total resto, Hoffman 6 Mountdort, UK eng, twin SU sloper G5s, 6.1:1 CR, drilled pistons, A-type gearbox, 3.79 rear, new top/side curtains, repainted 94, exc cond, owner's tech manuals.

**\$124,500 US Dollars o.b.o.**

Tel: 941 947 6700 days

Fax: 941 947 1126, FL., U.S.A.

27128033

**BENTLEY TURBO R.** Original factory LHD, 1992, 12,000 miles, FSH, 1 owner, virtually as new. £POA. Tel: 0181 209 0481 or 0836 560300. (27044)

**BIZZARRINI P538.** 'Ex Giolito'. Tel: France 33 4 92 38 04 11, fax: 33 45 92 38 04 12. (26983)

**D**

**DAIMLER 250 V8.** 1968, MOD, TAS, interesting history, BRG, very clean engine, recently rebuild, new exhaust, refurbished interior. MoT. Full documentation. £6,900. Tel: 01494 872902. (27195)

**DAIMLER DS420** State Landaulettes and Limousines for sale. The ultimate wedding carriages at affordable prices. Choice of colours. Own a classic limousine that pays for itself. 25 years experience. Bretton Wedding Car Specialists. Tel: 01226 206797. Fax: 01226 289575. (27277)

**DATSUN 2000 SPORT ROADSTER.** 1968, LHD, rare car with factory fitted, 150 bhp engine, less than 500 made in this spec. Period m.o.m.o., alloy wheels, manual 5 speed gearbox, original wheels available, unusual and fast roadster, ready for summer. £6,950. Tel: Cambridge Motorsport 01767 677969. (26949)

**DATSUN 240 Z.** 1970, LHD, silver/black interior, £1,000's spent on recent restoration. Excellent condition throughout, a superb example of this useable sports car. £7,750. Tel: Cambridge Motorsport 01767 677969. (27280)

**DATSUN 260 Z.** 1978, 2+2, MoT July '99, 240 carbs, Webasto fitted sunroof, collectors plate - reg no. KIB 2607. Spare set of alloys. £1,400. Tel: James 0121 744 9425, eves/weekends. (27144)

**F**

**Ferrari Specialist - Mobile Service**

Clutches from £345 fitted. Major servicing from £350. Vehicle inspection and valuations available at reasonable prices.

15 years experience in repairing Ferraris. All work guaranteed at fixed prices - So No Nightmares!

Any Ferrari problems contact Terry Keyes on 01923 822920 or 0468 363668

2380447/148148/65051

**FERRARI 308 GTS CARBU.** LHD, 1980, red with black hide, 27,500 km, air con. Excellent condition - One of the best. £24,000. Fax: 0049 6851 3332. (27117)

**FERRARI 328 GTS.** 1987, pre-abs, red/cream, 13,000 miles, fsh, CD, a/c. Immaculate condition. £45,950. Tel: 01932 846615 home, 01932 254025 office. Private Sale. (27207)

**FIAT 124 SPIDER.** BPB, 81k, 1972, 1600cc, red, wooden dash, mechanically absolutely sound, new gearbox. 1995, respray and new hood. £5,500. Tel: 0171 611 6667 W, 0171 223 2496 H. (27236)

**FIAT DINO 2.4 SPIDER.** 1971, silver engine rebuilt by Mike Elliott. Body de-rusted by Mal Nicholson, new paint. 12 months MoT. 84,000kms. £17,950. Tel: 01403 733400. Previously German owned. (27179)

**FIAT UNO 1300.** Just rebuilt, approx £2,000 receipts. Avanti big valve ultimate engine, Avanti CR box with LSD, disc brakes all round, spares package, approx 60 various tyres, all good - some new, 20 various wheels. £2,500. Tel: 01563 521687, 01292 260416. Ask for Tom. (27109)



**1939 FORD DELUXE COUPE**

All steel, total body off restoration, new s/trim, bumpers, rubber, glass, w.w.w., tyres, trim rings/caps, total stock appearance, 402 Chevy, 350 auto, Mustang front 8" Ford rear, air, heat, p.s., p.b., cruise, new mint car. Less than 1,000 miles, drives like a new 95 car.

**\$28,500**

Phone: 616 453 1920 - U.S.A.

2702731232

**FORD1968 MUSTANT GT FASTBACK.** Hollman & Moody special order. 289 cu.in. V8, red, 282 bhp, K series, hypo unit, Edel Brock manifold, cross flow exhaust system, 3 speed quick shift automatic box, LHD, beautiful condition. 40,000 miles. £12,000 o.n.o. Tel: 0181 688 7811, M: 07775 923752. (27121)

**FORD RS  
COLLECTION**

- 1 RS 200 # 166, 250 hp less than 60 miles **\$55,000**
- 1 RS 200 # 159, 350 hp less than 200 miles **\$65,000**
- 1 RS 200 # 104, 350 hp less than 500 miles **\$65,000**

All are LHD and have been in storage most of their lives. They are in the UK and can be viewed by appointment, these cars are NOT legal for the USA.

**DEREK CLARSON**  
Indianapolis, U.S.A.  
Tel: 317 271 0720  
Fax: 317 271 3879

2714133/030435

**I**

**INVICTA - THE BLACK PRINCE.** LHD, one of the last of only 16 built in 1949. Drophead Coupe, 3L meadow engine. 5-speed gearbox restored by Profeglio Nello. Make me an offer. Tel: +32 2251 1111, fax: +32 2252 5055. (27202)

**J**

**ADAMS JAGUAR 4.2L.** Auto, chassis No.4, prof constructed 1989. 8,000 miles, chrome wires. Splendid retro classic. O.i.r.o. £8,500. Tel: 01483 234732. (27200)

**FLYING CAT - MK2 SPECIALISTS.** 1963 MK II 3.8, manual overdrive, blue metallic wires - £16,950. 1965 MK II 3.4, manual overdrive, silver grey metallic, wires - £16,950. 1961 MK II 3.4, manual overdrive, green, chrome wires - £11,950. 1967 340, manual overdrive, grey, wires - £9,950. 1962 MK II 3.4, auto, gun metal, wires - £9,950. 1966 420, auto, brown - £6,950. 1967 240, manual overdrive, beige - £6,950. For details please contact: 01767 631731. (27143)

**JAGUAR D-TYPE REPLIC BY L&R.** 4.2 litre engine with 45 DCOE webers on Lynx manifold. Estimated 300 bhp, finished in BRG with leather interior. Looks stunning with outrageous performance, approximately 1,000 miles. £18,995 o.n.o. Tel: 01883 715943. Surrey. (27157)

**JAGUAR E-TYPE 4.2 2+2.** RHD, 1969, BRG, chrome wire wheels, manual, immaculate. £15,750. Tel: 0151 327 4219, Liverpool. (27217)



**JAGUAR E-TYPE ROADSTER**

1961, 5.8, Chassis 850207. Same owner last 50 years, original owners manual, history, professional restoration to concours. All photo's, bills, mohair, hood, factory hardtop.

**£52,000 o.n.o.**

Phone: 00618 9586 7255 Western Australia

27261024

**JAGUAR E-TYPE.** 1961, flat floor roadster, chassis number 850288, professional restoration, original engine and gearbox, Heritage Certificate. £47,000 o.n.o. Tel: 01202 700444. (27252)

**JAGUAR E-TYPE 3.8 FHC.** 1962, cream/black, English car, numbers match, bare metal restoration with photos/bills. £17,950. Tel: 01622 820554 - Kent. (27167)

**JAGUAR E-TYPE SIII V12 ROADSTER.** 1972, just restored, BRG, biscuit hide. Exceptional. £36,000. Fax: +33 0 4 93 77 37 90, Tel: +33 0 4 93 77 33 52. S. France. (27242)

**JAGUAR MK 7M.** Manual/o/d., indicated 40,000 miles from new. One owner for over 20 years. All original chrome. Battleship grey with excellent red leather interior. Fitted with period compass and inclinometer. Super to drive and looks beautiful. Must be one of the finest on offer. £12,950, consider p/x. Bobs Affordable Classics. Tel: 0121 743 5276/01564 779746. (27225)

**JAGUAR XJ6 4.2 SERIES 2.** 1974, 70,000 miles, all MoT's from new, burgundy/black, vinyl roof/sunroof, tan leather, mechanically excellent, body good but attention to paintwork needed. £1,995 o.n.o. Tel: 0468 206229. (27263)





## Sept 1967 Jaguar E-Type 4.2 Roadster

Finished in Canyon Red with Biscuit hide upholstery. Permanently stored in a humidity controlled garage since professional restoration by E-Type specialists (full photo journal). Only 3,062 recorded miles since rebuild. Recently fitted with uprated brakes by Cooper, along with a heavy duty sway bar.

### £33,000

Contact Ken Sleeth on 0191 261 4999 or Julian McGill on 01423 879236

**JAGUAR XK140 FHC.** BR Green, green leather, the subject of a nut & bolt restoration of £60k+, original RHD car. £42,500. Tel: Patric Carroll 01624 835000, fax: 833838. (27274)



**Retro Classics Limited** 19 Helport Estate, Lombard Road, London SW11 1RE

**XK120 ROADSTER.** Decent running and driving car. Red/black interior. Steel wheels. New interior/sidescreens. Some new chrome. New tyres. Very presentable. Value at £15,800

**XK120 ROADSTER LHD.** Silver/ret. int. spats. Newly rebuilt. Running in. Excellent. £28,500

**ALLOY XK120 ROADSTER "NUMBER 3".** Third RHD, 120 ever built. Numbers matching. Red. 41,000 miles only. Historic show car and a unique opportunity. Offers over £50,000

**XK120 DROPTOP SE.** Wire wheels. Complete. Needs thorough restoration. £6,900

**XK140 SE DROPTOP.** Excellent body/chassis. C Type engine, cream with matching wire wheels. New electrics. Very sound and attractive genuine ex-California car. £19,900

**XK150SE FIXED HEAD.** Well restored chassis/suspension/brakes/engine. Rust free body to be prepared and painted. Overdrive. Perfect winter project. £9,900

**XK120 SE ROADSTER.** Wire wheels, C-type head, Brooklands plus standard screen. Runs. For restoration. £10,800

We can locate the XK of your choice, or carry out XK inspections and reports on your behalf. Please call Paul at:

Retro Classics Limited, London  
0171 924 4150, fax: 0171 924 2140  
evenings Tel: 0171 937 1206

**JAGUAR XK150 DHC.** Genuine RHD, o/e white/red interior. Lovely condition. Superb driver, too much to list. Call for full spec. £29,750. Tel: Cambridge Motorsport 01767 677969. (27282)

## XK120 OTS or XK140 DHC

One must go. 120 is BRG/tan and lightly restored. 140 is BRG/tan, totally restored. Bucket seats, Getrag gearbox, c.w.w. Also bench seat, manual box and chrome trimmed disc wheels.

### £40,000 each

Tel: 01628 475565

**JAGUAR XK150 SE 3.8 DHC.** Original RHD, matching numbers with history and low mileage since full restoration. £29,500. Tel: Richard White 0116 240 4005 office, 0116 279 3300 home. (27231)



**JAGUAR XK150 Coupé 3.4**  
1956, restored new clutch, red/beige trim. Outstanding condition. JAG 150.

Tel: 0061 14 969 029  
or 0061 2 9358 1163  
+ 9 hours GMT - Australia

**JENSEN INTERCEPTOR CONVERTIBLE.** 1975, complete factory rebuild. Six concours wins, metallic burgundy, cream leather, walnut, electric hood. £35,000. Tel: 01494 526722. (27243)

**JENSEN INTERCEPTOR SERIES II.** 1971, air con, history, long MoT. Reasonably priced to sell - £6,995 no offers. Tel: 01462 815683. Beds. (27235)

## 1963 LANCIA FLAMINIA ZAGATO SPORT



Extremely rare covered headlight with outside filler cap. This car underwent a complete concours restoration and achieved a 1st Place Award at the prestigious Amelia Island Concours d'Elegance in 1997. Bordeaux with tobacco coloured Connolly leather interior. Car runs perfectly and has had a complete engine and transmission rebuild during complete restoration. Perfect for rally or concours.

David J. Mohman, U.S.A.  
Phone 305 582 9723 - Fax: 305 592 0035  
\$85,000 or best offer

**LANCIA LAMBDA SERIES 7.** Tipo 78, SWB 1927. £40,000. Engine No. 7205, chassis no. 17176. Purchased by me 1962, two previous owners. All original, mechanical instruments and body. Carefully restored in 1995. Castlemains Rally's 1995 & 1997. See Colour Gallery Classic & Sportscar October issue! John Davies, Perth, Western Australia. Tel: 0061 89 384 6999, fax: 0061 89 385 2488. (27253)

**LANCIA MONTE CARLO SPYDER.** Silver, 1981, Series II, 54k miles, original g/s/h, full MoT, taxed. 1 owner last 11 years. £6,500. Tel: 01730 892721. (27196)

**LANCIA SPARES AND RESTORATIONS.** Aurelia, Flaminia, Flavia, Fulvia, Stratos original, reproduction and secondhand parts full or part restorations. Fast international mail order service. Omicron Engineering, Mulbarton, Norwich, UK. Tel: +44 0 1508 570351, fax: +44 0 1508 570795. (27220)

**LOTUS CORTINA MK1.** 1964, in brand new condition, owned for last 20 years, never used or shown, would qualify for concours condition. £15,000. Tel: 01923 284893 or 0802 882302. (27085)

**LOTUS ELAN SPRINT FHC.** Oct 1972, red over white, 2 owners from new. £10,500. Tel: 0151 489 7639 eves. (27046)

**LOTUS ESPRIT S3.** 1985, ice blue metallic, half blue leather. Two owners only, 34,000 miles. Immaculate throughout. £10,500. Tel: 01244 544761 or 0831 326531. Chester. (27118)

**LOTUS ESPRIT TURBO SE 1989 F.** Northolt yellow, 51,000 miles, full service history, tan leather interior, stereo, remote alarm, central locking, air conditioning, electric windows, many modifications. A completely one off car, first to see will buy. Reluctant sale. £17,995. Tel: 0181 692 9350, 0410 718669. (27064)

**LOTUS EUROPA TWIN CAM 5-SPEED SPECIAL WANTED:** I would prefer a good car although a small amount of work not object to. Please help me in my search. Tel: 01695 421405. (26918)

## M

**MARCOS MANTIS 2+2.** 1971, 1 of only 33 produced, TR6 mechanics, 54,000 miles only, chrome wire wheels, finished in Aston Martin roman purple. Excellent original condition. £4,750. Tel: 01703 556300 office, 0836 263471 mobile. (27275)

**MARCOS STAGE III.** 1969, 3.1 litre for sale by the original owner, only 1,496 genuine miles. Professionally built. LSD, maroon. £8,000 o.n.o. Tel: 01206 573244. Private Sale. (27041)

**MERCEDES 230 SL.** Auto, 1965, metallic red, black hard top, black leather, leather seats. Restored an resprayed, immobiliser, CD, roof, trolley, car cover. MoT July 1999. £22,000. Tel: Adam 0171 565 0001. (27120)

**MERCEDES 250 CE PILLARLESS COUPE.** 1972, 1 owner from new, 47,000 miles only. Stunning condition with service history. £5,995. P/x possible. Tel: 01372 378069. T. (27042)

**MERCEDES 300 SE COUPE.** 1966, automatic electric everything, blue with grey leather, 89,000 miles, fsh. Beautiful and rare, unrestored. £15,900. Tel: 0181 658 6647. Private Sale. (27228)

**MERCEDES 350 SLC.** 1974, dark blue, concours condition, one owner from new, fsh, refurb seats. Reg No.: 248 NTT. £10,300. Tel: 01243 512286. (27203)

**MERCEDES BENZ 230 SL PAGODA.** Automatic, power steering, ivory, hard top, new Mercedes-Benz soft top. New MoT, garaged, beautiful condition. Recently serviced. £16,950. Tel: 0171 372 5488. (27276)

**MG J2.** 1933, full restoration almost complete - over £15,000 parts to date including £3,000+, new head assembly. £11,850. Tel: 01989 750417. (27256)

## PRE-WAR MG'S FOR SALE

**1930 MG 'M'.** Double 12 factory replica. Ground up restoration, 200 miles since.

**1937 MT TA.** One original owner prior to a total nut and bolt restoration, having only covered 250 miles since.

**1936 MG SA Saloon.** A rare opportunity to obtain this very rare model. 7 year restoration.

For complete details on any or all of the above please contact the following numbers

Tel: 01202 660622 Mobile 0836 734003

ONLY SERIOUS ENQUIRIES PLEASE

**MG MIDGET.** V reg, Carmine red, excellent condition. New bodywork/soft top, MoT Oct, tax Nov. Reluctant sale. £4,000. Tel: 0131 337 0943. (26895)

**MG ROADSTER.** 1973, uprated 1.9 engine and suspension, 5,000 miles on fully documented restoration, dry weather only. Finished in French blue with grey interior. C.w.w., o/d, tonneau. A really beautiful MG with stunning looks and performance to match. £9,250. For full details and spec Tel: 01276 685266 or mob: 0860 677189. Surrey. (27139)

**MG ROADSTER.** 1979, glacier white, bare metal respray, July 97, roadster wheels, chrome in trims, new mohair hood, new Monolite steering wheel, new black leather seats, Pioneer CD system. Day use only. Superb throughout. Only £3,995. Tel: 01268 752376 H or 0498 700016. (27183)

**MGBT.** Blaze red, 2,400 miles, as new. £10,000. Tel: 01624 835000 or 824155, fax: 833838. (27272)

**MGTD MKII SERIES II.** 1952, rare competition version. Ex-California, now RHD, no rot, just a nice Patina! New MoT. Heritage Certificate. Drives and looks superb. £12,500. Tel: 01273 890870. (27244)

## P

**PEERLESS HAS SEEN BETTER DAYS.** Fitted TR engine with twin webers, in running order, reg. no. 359 CKJ. Believed some competition history. £1,500 or near offer. Also a Devin bodysell imported from USA. £900. Tel: Bob Adams 0121 743 5276 or 01564 779746. Supplying Affordable Classics for 20 Years. (27097)

**PORSCHE 356 CARRERA 2 COUPE.** 1963, RHD, Ball blue, original black trim. Rebuilt 4-cam, annular brakes. Call Bill 01252 793120. (27201)



## Porsche 912

1967, original yellow. Bodywork in good condition. Californian import, as yet unregistered. Spent considerable time in San Diego Motor Museum. Ideal entry level Porsche or investment, as only 33,000 of this marque were made.

### £8,250

Phone 01865 864188  
evenings or weekends



**1988 PORSCHE 930 TURBO CABRIOLET**  
32,000 original miles. Black interior, black power top and factory Tonneau cover. 10 disc CD, 17" Kinross Racing wheels and 1 set 17" chrome RUF wheels. 500 miles on brand new 3.4L 450 bhp RUF engine! Andial intercooler and fuel enrichment. Beds exhaust w/B&B headers. HKS adj. boost. Racing suspension w/adj., sway bars, rear coil covers, bigger front torsion bar, raised spindle, strut brace. Front air dam w/Mocal oil cooler and brake cooling ducts. Sparco EVO seats 2/6 point harness, plus fact, 8-way seats in perfect condition. AIR leather covered tollbar.

### \$59,900

Tel: W 805 497 8888 ext. 14 H 818 707 6003

## PORSCHE SEARCH AND FIND SERVICE

Direct from their 'homeland' in Germany

Available now:

**1986 Porsche 911 (930) Carrera 3.2.** 103,000km, service history, platinmetall, fuchsweils, c windows, c sunroof, in good condition. DM 35,000 (£12,000)

TOP SHOOT:

**1993 Porsche 964 RS.** Renneneinrichtung. 52,000km, factory confirmed racer, 1 from 290 built in series 1992. Pirelli Cup Winner 1993, red, red, 2 owners service history, in best condition. Ready to race or have fun. Extremely rare. DM 96,000 (£33,000)

**1976 Porsche 911 2.7 Targa.** 230,000km, service history, 2 owners, green polar, silver metal, black, fuchsweils, radio. Engine overhauled by 225,000km, body and technically fully restored. DM 38,000 (£13,000)

**1966 Porsche 912 90S.** Fully restored, 5,000km, red, black, 1 owner, 5 speed. DM 35,000 (£12,000)

All cars in good collector condition with low kilometer ranges. All prices plus 10% commission.

Call me directly in Germany on

Tel: 0049 171 443 1655 or

Fax: 0049 221 941 4627

## R

**RENAULT R6.** 1965, LHD, 19,000 miles only. Original bill of sale and documents from first day. Superb interior. Drives as new. £3,750. Tel: Cambridge Motorsport 01767 677969. (27284)

**ROLLS ROYCE CLOUD 3.** 1965, new interior, exhaust, tyres, steering. Superb condition - must be seen. Used only for society functions. Tel: 01903 230202. Worthing. (27119)

## ROLLS ROYCE 1937 PHANTOM II



One of a kind, Henley Roadster by Brewster/Inskip, New York. Probably the most important PII in the world. 35,000 original miles, drive anywhere.

## PRIVATE SALE

BYRON J. YORK

203 431 0368 - CT, U.S.A.

or NORM HATHAWAY

914 669 8958, NY, U.S.A.

**ROVER 3 LITRE SALOON MK3.** 1967, auto, 79,000 miles from new. Silver birch with brown leather interior. Far above average condition. £2,950 for a quick sale due to imminent loss of premises. Tel: 0121 743 5276/01564 779746. Bob Adams - Supplying Affordable Classics for 20 Years. (27222)

## S

**SAAB SONNET III.** 1971, LHD, rear glass fibre bodied factory built sports coupe. 2 litre, Ford V.4. An unusual and interesting sports car that is great fun to drive. Be different for £6,750. Tel: Cambridge Motorsport 01767 677969. (27281)

**SUNBEAM TIGER MK1.** 1966, red, 53,000 miles, fully restored, Revo wheels, hard top. Full MoT. £10,000. Tel: 01909 476551. (27169)

## T

**TALBOT LAGO BARCHETTA.** 1959, BMW V8, 150CV, gearbox ZF, 4 speeds, eligible Mille Miglia. Only 2 Barchettas built with the V8 BMW 2500cc. Tel: France: 33 4 92 38 04 11, fax: 33 4 92 38 04 12. (26982)



## 1967 TOYOTA 2000 GT

This very rare and special model was imported only for Toyota franchise owners. This particular car was brought to the USA for the current owner. The car is completely original with the 6-cylinder dohc 1988-cc 150-bhp engine. This coupé is in pristine condition with 14,900 miles.

### \$120,000

Contact: Kim Stevens  
516 423 6644



**TRIUMPH STAG.** 1973, white, blue interior, h/s tops, manual, 88k miles, recon engine. All original, new tyres. Excellent condition. £5,750 o.n.o. Tel: 01242 862319. Private Sale. (27181)

**V**  
**VOLVO COUPE P1800.** 1963, reg 821 P00. Cowhorn bumpers, MoT. Excellent condition, body & engine. £5,500 o.n.o. Tel: 01280 848213. (27286)

**AMERICAN CARS IN UK**

**AMERICAN CARS**

We are the United Kingdom's largest and longest established dealers in classic American cars and trucks from the 1950's onwards. At our warehouse we have a huge selection of vehicles including several Cadillac convertibles. We also import specific vehicles to order from California including the Chevy Tahoe 4x4 LT, the ultimate vehicle in its class.

If you want a show winning piece of Detroit Iron, a late model daily driver or a rust free cruiser, call for details and stock list.

**Tel: 0171-627 5775**  
**Fax: 0171-498 7556**

**Dream Cars, 8-10 Ingate Place, London SW8 3NS, England**

**MUSTANGS**

**1966 Shelby Mustang GT 350**



Built by Shelby American, Los Angeles, California. Just completed a professional ground up restoration, there is none better, a real knock out. Sapphire blue with white stripes.

**Priced at \$48,000 F.O.B.**

OFFERED BY PRIVATE COLLECTOR  
Contact Dave at 305 661 0805 or Fax: 305 883 6606  
Serious enquiries only - Florida, U.S.A.

**MUSTANGS:** Sold together or separately. 1965 Shelby Mustang, 1965 Mustang Coupe. FIA papers. Fast and correct. Tel/Fax: 00 35 656 3636/656 0354. Holland. (27174)

**US COLLECTIONS**

*Vintage Racing Services Inc.*

- 1964 BOBSY MKII superb history and documentation, original
- 1988 BUICK/NASCAR restored, superb, Bobby Allison grand national
- 1966 CHEVRON B15 FORMULA B freshly restored, all steel twin cam, spares
- 1965 ELVA MK VIII/BMW beautiful, rare, fast, spares. The best available
- 1965 ELVA GT-160 COUPE one of 3 built, beautiful, race ready
- 1972 G.R.D. FORMULA B freshly restored, all steel twin cam, spares
- 1961 LOLA MKIII FORMULA JUNIOR very rare, beautiful and ready
- 1957 LOTUS II fresh FWB (1500cc) Sprite trans, attractive and very quick
- 1962 LOTUS 19 SPORTS RACER superb, Selzer restoration, 2.5 Climax
- 1959 LOTUS 18 FORMULA JUNIOR beautiful and race ready
- 1967 MCKEE MK7 CAN-AM SPORTS RACER simply the best available
- 1979 MARCH 792 FORMULA 2 superb fresh Hart 2 litre and FT ready
- 1957 MGA COUPE VSCCA log, very solid, race ready, attractive and reliable
- 1964 TRIUMPH SPITFIRE 1300 excellent, restored, very quick and cute
- 1959 TURNER CLIMAX fresh FWA alloy sports racer body unique
- 1965 LOTUS ELAN BDA fast and interesting
- 1958 MGA TWIN CAM excellent for road or race
- 1965 FORSGRINE D SPORTS RACER race ready
- 1960 BEACH MK IV SPORTS RACER 1st in class '96 SVRA Summit
- 1966 LOTUS 31 FORMULA FORD best of everything

**VINTAGE RACING SERVICES**  
1785 BARNUM AVENUE  
STRATFORD, CONNECTICUT 06497  
TEL: 203 377 6745 - FAX: 203 386 0486

**QUALITY CARS FOR SALE.** Holman Moody GT40 MkII, when only the best will do. POA. Ferrari 59/60 TR replica, exceptional quality, POA. Pantera GTS super, \$35,000. Pantera street legal, 190mph, \$38,000. '65 Corvette vintage racer, 7.5L, fastest in USA, \$70,000. Jaguar XK150S, good driver, \$35,000. Elva Formula Junior '59, excellent, \$35,000, and others. John Smolen. Agent. Tel/Fax: 303-306-6722. Col, USA. (26737)

**STEVES BRITISH CONNECTION U.S.A.**

- 1968 Lotus 7, Fiat twin cam drive train and components, LHD \$8,500
- 1965 Jaguar XKE Coupé, Series I, needs restoration, LHD \$6,500
- 1959 MGA Coupé, totally restored, w/w, LHD \$9,900
- 1962 MGA Deluxe, nice driver, LHD \$10,000

**WORLD WIDE SHIPPING**  
**OTHER EUROPEAN**  
**SPORTS CARS AVAILABLE**  
Tel: 630 553 9023 Fax: 815 786 3372  
ILL., U.S.A.



1965 CHEVROLET CORVETTE CONVERTIBLE. 396 CID/425 hp, 4-speed, posi-traction, red/red-white top, tele steering, am/fm, knock-off wheels, hard top - matching numbers. A very nice example of a repainted, unrestored car, showing very little use since completion \$54,000

1957 CORVETTE. 283 hp, S.I., 3 speed spd, polo white/red interior, hard top, radio, heater, soft top delete. A very nice older restoration, showing very little use, converted to 4 barrel carburettor, the 7014360 F.I. unit is included \$45,000

1963 CORVETTE SPLIT-WINDOW COUPE. 327-360 hp, F.I., four speed, radio, knock off wheels, silver blue with dark blue interior, body and frame restored, showing very little use, interior original. The original F.I. unit comes with the car. \$32,000

**Tel: 207 642 4610**  
**Maine, U.S.A.**

**MISCELLANEOUS**

- 1961 DB4 Ser III with o/d, chrome wires, beautiful condition inside & out, excellent mechanics, some factory history, last owner 10 years ... £36,950
- 1964 Healey 3000 MK III B/J8 Ph 1. Triple concours winner, nut and bolt restoration, photo history, magnificent car in every respect. Private collector 8 years ... £25,950
- 1995 MG TF 1500. Chrome wires. Reg: 9732 TF included. Ground up restoration & beautiful. Last owner 9 years, part of private collection ... £21,500
- 1935 Hudson Straight Eight Saloon. RHD, rare Earls Court Show car. Reg: CMD 524, total restoration in 1990 and absolutely superb throughout . £12,950
- 1990 (H) Virage. Manual, 37k, storm red ... £36,950
- 1980 Rolls Spirit. Cobalt blue, fRsh ... £10,950
- 1965 Mercedes 190. Auto, royal blue, 43k, fsh ... £6,950
- 1965 Rolls Cloud III. MPW convertible ... SOLD

**PART EX - OLD OR NEW**  
**PAUL COOMBES**  
**TEL: 0161 950 1182**  
**FAX: 0161 661 3789**

**PUBLICATIONS**

**MOTORAIL BOOKS**, specialising in all forms of literature relating to both classic & modern motor cars, phone or fax with your requirements, mail order our speciality. Tel: 01202 396469, fax: 01202 391572. Bournemouth. (27136)

**AUTOSPORT CLASSIFIED**

**WRITE YOUR AD IN BLOCK LETTERS BELOW:**



NAME \_\_\_\_\_  
ADDRESS \_\_\_\_\_

POST CODE \_\_\_\_\_  
DAYTIME TEL \_\_\_\_\_

ACCESS  VISA   
AMEX  DINERS

CARD NUMBER \_\_\_\_\_

EXPIRY DATE CHEQUE NUMBER \_\_\_\_\_

SIGNATURE \_\_\_\_\_

MARKETPLACE   
RACING AND COMPETITION   
SPORTS AND CLASSICS

A-Z DIRECTORY   
SUB-HEADING \_\_\_\_\_  
NO. OF INSERTIONS \_\_\_\_\_

Box No's UK £50.00 (replies by Airmail £6 extra)   
**AUTOSPORT RESERVES THE RIGHT TO REFUSE OR WITHDRAW ADVERTS AT ITS DISCRETION AND DOES NOT ACCEPT LIABILITY FOR CLERICAL OR PRINTERS' ERRORS**

**TELEPHONE 0181-943 5858 OR FAX (24 hrs) ON 0181-943 5850**

DEADLINE for all classified is 4.30pm on Monday preceding publication. To place advertisements out of office hours dial 0181-943 5858 and dictate advert onto answering machine giving name and address and telephone number clearly.  
WE REGRET NO ALTERATIONS, CANCELLATIONS OR REFUNDS POSSIBLE ON LINEAGE

**TICK SECTION AND FILL IN SUB-HEADING BOXED ADVERTISEMENTS**

**PRE-PAID ONLY.**



**WESTFIELD SET 7B**  
(TVR Works Tuscan spec. V8). Fortune spent. Only 2000 mls since professional build for circuit use (but never raced). Estimated 375bhp. Road legal with full MoT. Black, with white 16" alloys. Seriously fast and absolutely spotless. A gift at £15,950 ono. Too much detail to list. Please phone 01254 663777 or 0831 128013

**WHY NOT ADVERTISE IN A BOX?**  
**SINGLE INSERTION PRICES START AT**  
**£92 + VAT B&W**  
**£175.50 + VAT COLOUR**





AUTOSPORT is looking for experienced freelance sub-editors to work in its Teddington offices on busy Monday and Tuesday press days.

Motorsport experience appreciated, but not essential. Must be able to work in Word and Quark on an AppleMac. Good rates and opportunities for overtime.

Please call John Leach on  
**0181 943 5807**

71084/34

If you want to  
advertise in  
Appointments  
call Tania or  
Guy on  
**0181 943 5961**



### SHEET METAL WORKER/FABRICATOR

Conversant in the use of a wheeling machine, tig welding and gas aluminium welding. To manufacture one of panels, fuel and oil tanks etc for vintage and historic racing cars.

Please apply in writing to  
NDR Ltd, 4786 St Alban's Rd,  
Watford, Herts WD2 5QU or by  
phone to Neil Davies on  
**01923 220370**

71222/34



## STEWART GRAND PRIX

### Engineering Buyer – Ref: NB/1

Successful applicants will probably have a motorsport or aerospace background with a competent understanding of technical drawings and modern manufacturing techniques. They will be used to procuring complex machined and fabricated components to the highest standards whilst meeting aggressive delivery schedules.

### Production Manager – Ref: AM/1

The successful applicant will have an in-depth knowledge of composites manufacture and assembly gained preferably within the motorsport industry. Several years experience in a production management position are also required. This is a key role within the organisation and the ability to plan to meet tight deadlines under considerable pressure is vital as are excellent communication and interpersonal skills. Knowledge of current health and safety regulations relevant to composites manufacture would be an advantage.

### Production Manager – Metals – Ref: AM/2

The successful applicant will have an extensive knowledge of the machining and fabrication of metals including steel, titanium and aluminium gained within a motorsport or similar environment. Several years experience within a production management position are required along with excellent communication and interpersonal skills. The ability to work under pressure and to meet aggressive deadlines is essential. A knowledge of current Health and Safety legislation would be an advantage.

To apply for any of the above positions, please send your CV, quoting the reference number to:

**Stewart Grand Prix  
Bradbourne Drive, Tilbrook,  
Milton Keynes, MK7 8BJ.**

71083/34



### DRAFTSMAN

As a result of strong interest in our new MP84 sports car and other projects we are looking to recruit, initially on a 4 month contract basis, an experienced Draftsman to augment our existing Design team.

The successful candidate will have good basic qualifications and proven experience in motorsport mechanical design using CAD.

Interested? Please apply in writing enclosing your CV and current salary to:

**Andrew Ham, Pilbeam Racing Designs, Graham Hill Way,  
Cherry Holt Road, Bourne, Lincs, PE10 9PJ.**

PILBEAM RACING DESIGNS Innovation + Excellence THE WINNING FORMULA

71069/34

## WILLIAMS MOTORSPORT LIMITED



### ENGINEERING BUYER

A proactive member of the team responsible to the Production Manager for all proprietary race car components procurement. This will involve sourcing components and services with class leading suppliers to achieve the highest quality and value for money whilst meeting challenging project timescales.

Candidates should be CIPS trained, with several years motorsport purchasing experience and a proven track record gained over at least five years. Good interpersonal and negotiating skills are essential along with a thorough understanding of modern manufacturing processes. Knowledge of import/export procedures also an advantage.

The ability to rapidly develop your existing computer skills is essential, but above all, you will be a dedicated team player with a flexible approach to working hours.

Applications for the above position, including full career details and current salary, should be forwarded to:

**Terry Brice, Production Manager  
Williams Motorsport Ltd, c/o BMW Motorsport Ltd,  
Station Road, Grove, Wantage, Oxon, OX12 0JU**

71265/34



## Peter Ratcliffe

### GALLERY MANAGER/SALESPERSON

An opportunity has arisen for a person to manage our prestigious new gallery in Central Windsor. The ideal person will have a good knowledge of Formula 1 both past and present, and sales experience would be an advantage. Reliability, self-motivation and the ability to enjoy dealing directly with clients is a must.

Established for ten years our collection of signed motorsport prints are known worldwide and are highly regarded by enthusiasts. Some weekend work will be required. This is an excellent opportunity for the right candidate.

Telephone: 01344 874874

TTTTT04



**STEWART**  
GRAND PRIX

Stewart Grand Prix invites applications for the following position:

### Test Team Mechanic

Previous F1 or F3000 experience essential.

Please write with full CV to:

David Stubbs, Race Team Manager  
Stewart Grand Prix Ltd  
The Stewart Building, Bradbourne Drive, Tilbrook,  
Milton Keynes, MK7 8BJ.

71287/34



Jordan Grand Prix requires the following personnel:

## HEAD OF AERODYNAMICS

We are looking for a senior engineer who, reporting to the Chief Designer, is capable of running all aspects of a large aerodynamics development group.

The suitable candidate will have several years' aerodynamic experience at the top level of motorsport, and be able to demonstrate an ability to lead a large and committed team.

If you feel that you can meet these criteria, please apply in writing enclosing your CV and current salary to:

Drawing Office  
Jordan Grand Prix Ltd, Silverstone,  
Northants NN12 8TJ

All applications will be treated in the strictest confidence



The team's commitment to innovative technical progress has secured them an enviable reputation as one of the most successful and forward thinking companies in the motor racing industry. As part of this commitment, the company seeks dedicated professionals who share an enthusiasm for success.

### COMPOSITE DESIGN ENGINEER

We are currently looking for a professional Design Engineer to join our Composite Design Team.

The successful applicant must have relevant structural experience within the motor racing industry, with a knowledge of CAD being a distinct advantage. The role involves the layout, design and detailing of both primary and secondary composites components such as chassis, bodywork and wing assemblies. An understanding of current composite pre-preg materials and tooling techniques is essential.

### COMPOSITE LAMINATOR/FITTER

We are currently looking for a professional Laminator/Fitter to join our Composites Department.

Successful candidates will need to demonstrate an intelligent and flexible approach to technical problem solving and previous experience of Aerospace or Formula One environments would be beneficial. As an integral member of a team, applicants will also have experience in mould making, laminating and the assembly of final components, with the ability to maintain exceptionally high standards.

Please apply in writing with full CV and present salary to:

Human Resources  
Benetton Formula Ltd  
Enstone, Oxfordshire OX7 4EE

Closing date: 28 August 1998



## ADVERTISING SERVICES

**Fever Design.** High quality, low cost creative solutions with the finest digital equipment. We create ads to suit your specific needs. For the best position on the grid call Fever! Advertising/livery/promotional design. Fever: The podium team. Tel: (Michael) 0661 103566. (Ben) 0411 656581 or 0181-673 0665 (eve).

## AMERICAN MOTORHOMES HIRE

**36ft American Motorhome Hospitality/Hire.** For all your motoring events UK/Europe. 3M Awning. Full catering available. Includes driver. For details, call/fax RJC Leisure 01428 605252.

**American Motorhomes for Hire** with or without 5m x 8m hospitality awning. Delivered anywhere, many dates available. Phone/Fax H.G.C.H. on 01663 766871 or Mobile 0385 111031.

## BRAKES

**AFT Carbon Kevlar Brake Pads** to suit most applications, outperform other carbon pads. 'Brakes with attitude'. Call 01203 684179.

**HAWK RACING BRAKE PADS.** Latest ferro carbon compounds. O.E., AP, Alcon and Wilwood fittings. Cambridge Motorsport, Caxton Road, Great Gransden, Nr Sandy, Beds SG19 3AH. Tel: 01767 677969. Fax: 01767 677026.

## CAMSHAFTS

**Kent Performance Cams.** From Hot Rod to Formula 1 – used by championship winners! Units 2-4, Shorncliffe Industrial Estate, Folkestone, Kent, CT20 3SP. Tel: 01303 248666. Fax: 01303 252508.

**Piper Cams.** Europe's leading supplier of competition and performance camshafts. We offer everything from profile design and selection to the manufacture of race winning touring car cams. With the most comprehensive computerised profile design facilities in the country, backed up with the latest CNC manufacturing facilities, our service is unrivalled. Total confidentiality assured. Tel: 01233 500200.

## CARBON FIBRE COMPONENTS

**High quality Autoclave cured composite components.** All motorsport categories. From drawings to finished panels. Crosby Composites, Unit C, Nigel Court, Brackley, Northants. Tel: 01280 840630.

## CHAMPIONSHIPS

**Formula Palmer Audi.** Jonathan Palmer has created a new 250bhp single seater series competing for the ultimate prize of a fully funded F3000 drive in 1999. Contact Gary Church. Tel: 01403 733233. Fax: 01403 733222. Mobile: 0802 811044.

## CHASSIS BUILDERS

**Arch Motor & Manufacturing Co Ltd,** Redwings Way, Huntingdon, Cambs, OE18 7HD. Tel: 01480 459661. Fax: 01480 450923. Manufacturers of tubular and monocoque chassis, suspension and ancillaries. Rapid chassis repairs and full race car restorations.

## CLOTHING/SAFETY

**Demon Tweeks,** 75, Ash Road South, Wrexham Industrial Estate, Wrexham, Clwyd LL13 9UG. Tel: 01978 664466. Fax: 01978 664467.

## COMMERCIAL PROPERTY SERVICES

**A full commercial property service** provided to include lease renewal/rent review negotiations, development site appraisals, planning applications/appeals. Contact Tim Norris-Jones BA (Hons) ASVA. NJ Commercial. Tel: 01865 481408.

## COVERS

**Thoroughbred Covers Ltd.** Custom made for single seaters, karts, road cars, tool chests. Outdoor suitable for trailering and storage. Indoor dust covers. 349 Kirkstall Road, Leeds LS4 2HD. Tel: 0113 279 5079. Fax: 0113 231 0835.

## DYNAMIC BALANCING

**Burton Performance Centre Ltd.** Specialists in dynamic balancing since 1963. All engine types undertaken. Plus full machine shop facilities (Certificated to ISO 9001/BS5750). 627a Eastern Avenue, Ilford, Essex IG2 6PN. Tel: 0181-554 2281. Fax: 0181-554 4828.

## DYNAMOMETERS AND ENGINE PREPARATION

**Deltic Performance Engineering Ltd.** Sole importers of Dynopack™ portable hub-driven hydraulic dynamometers. Demonstrations \* Sales \* Service. Dynamic Balancing, Engine Building & Testing, Car Preparation, all Formulas, Road - Race. Tel: 01953 884999. Fax: 01953 883525. Mobile: 0585 912156. e-mail: deltic@globalnet.co.uk www.deltic.co.uk

**Warrior Automotive Research Ltd.** Competition engine building and dyno services in all current formulae from Formula Ford to DFR – race – rally – historic. Phone for cost effective dyno and build prices. Uckfield, Sussex. Tel: 01825 764833.

## ELECTRICAL HARNESSING/ INTERCONNECT PRODUCTS

**Tony James Component Wiring Ltd.** Specialising in the design and manufacture of wiring harnesses for motorsport. Also stockists of military connectors, heatshrink sleeving, wire and moulded parts. Certificated to ISO 9002:1994 part 2. E10 Speedwell Way, Harleston Ind. Est., Harleston, Norfolk IP20 9EH. Tel: 01379 854485. Fax: 01379 852718.

## ENGINES/GEARBOXES/PISTONS

**Accralite Pistons (A Division of J.L.S. Ltd),** Spon Lane, Smethwick, West Midlands B66 1QJ. Tel: 0121-525 6450/7733. Fax: 0121-553 5951. We manufacture in the UK quality forged pistons for high performance engines.

**Arias Pistons Ltd.** Fully forged pistons for every competition application, in bore diameters from 60 to 140mm. Manufactured as custom-designed single engine sets or production quantities. Brookers Road Industrial Estate, Billingshurst, Sussex. Tel: +44 (0)1403 784022. Fax: +44 (0)1403 782022.

## EXHAUSTS

**BTB Exhausts Ltd,** manufacturers of motorsport manifolds and systems. Contact Joe Ellis, Unit 3, Great Central Way, Woodford Halse, Nr. Daventry, Northants NN11 3PZ. Tel: 01327 261797. 24hr Fax: 01295 750233.

## F1 HIRE

**Show cars** – simulators, display items, tyres/flags, body parts – everything for special events. 07000 553949.

## FIRE/SAFETY SYSTEMS

**Lifeline Sales and Service Enquiries** for BCF and Zero 2000 systems to Lifeline Fire and Safety Systems Ltd, 1 Portway Close (off Torrington Avenue), Coventry CV4 9UY. Tel: 01203 471207 or Fax: 01203 474777.

**Race & Rally Car Fire Protection.** Spa Lite environmentally friendly system available plus Halon 1211. All systems meet FIA and RACMSA requirements. Spa Design Ltd, The Boathouse, Litchfield Street, Fazeley, Tamworth, B78 3QN, UK. Tel: 01827 288328. Fax: 01827 260528.

## FREIGHT FORWARDING

**Rapid International.** Import/export by air, sea or road. Contact Ken Moore, 4 Crown Way, Horton Road, West Drayton, Middlesex UB7 8HZ. Tel: 01895 446442. Fax: 01895 444492.

## FUEL CELLS

**AERO TEC LABORATORIES.** FIA approved FT5/FT3 lightweight, flexible fuel cells. Standard and custom manufactured. 40 Clarke Road, Mount Farm, Bletchley, Milton Keynes, MK1 1LG. Contact Kevin Molloy. Tel: 01908 270590. Fax: 01908 270591.

**FUEL SAFE UK & USA** – Fuel cells and refuelling equipment. FIA, IMSA, USAC approved. Standard and custom manufactured. Tel: 07000 383572. Fax: 07000 383532.

## GRAPHICS

**Helmet Paintwork** by Mike Fairholme Designs. Sole approved painter of Arai helmets. Silver Birches, Corby Birkholme, Nr Grantham, Lincs NG33 4LE. Tel: 01476 550630. Fax: 01476 550029.

**SIGN deSIGN.** Race team graphics and design. Suppliers to the motorsport industry, including TOCA, BTCC and F3000. Tel: 01271 323 771. Fax: 01271 327 007. E-mail: sign.design@BTinternet.com

## HOSE & FITTINGS

**Think Automotive Ltd.** See 'Oil Coolers'.

## HOSPITALITY

**AWH Motorsport Hospitality.** For the very best located, luxury hospitality suites at Brands Hatch, Silverstone and Donington Park. Other events also available. The AWH Group, Alyxandra House, 26 Market Street, Nottingham NG1 6HW. Tel: 0115 950 9998. Fax: 0115 950 7048.

**Speedsport Promotions Ltd.** Market leaders in corporate hospitality. Full package available at all venues. Speedsport Promotions Ltd, Unit 6E & 6F, Silverstone Circuit, Silverstone, Near Towcester, Northants NN12 8TN. Tel: 01327 858167. Fax: 01327 858518.

## INSTRUMENTATION

**Think Automotive Ltd.** See 'Oil Coolers'.

## KARTING

**Silverstone Circuits Limited gets you closer to the action** with indoor and outdoor RAC Motorsports Association licenced kart tracks. Professionally, fully trained Marshals and Event Co-ordinators with high tech timing equipment • The ultimate in corporate karting entertainment • Individual bookings for groups of 1 to 100 drivers • Kart race tuition • ARKS courses • Cadet karts • Children's birthday parties • 1350m Stowe Circuit – twin engine kart events • Gift vouchers available. Open 7 days a week. Tel: 01327 320425/6/7. Fax: 01327 858268.

**SRS Racing Kart School.** Kart race tuition – individual group. The new A.R.K.S. courses. Race hire/sales/preparation/corporate days/off road/all terrain courses. Podium House, Great Staughton, Huntingdon, Cambs, PE19 4DA. Tel: 01480 860823. Fax: 01480 861297.

## LEGAL SERVICES

**Johnson & Gaunt Solicitors** with first hand knowledge and experience of motorsports, motorsports law and tribunal representation. Contact Tim Elkins for help with contracts and commercial matters or Roger Rose for tribunal or court representation.

**Johnson & Gaunt,** 47 North Bar, Banbury, Oxon OX16 0TL. Tel: 01295 256271. Fax: 01295 266451.

**Freeth Cartwright Hunt Dickinson Solicitors.** Experienced legal advice on all aspects of motorsport including: RACMSA tribunals, commercial agreements for teams, sponsors and drivers; contractual disputes; racing accidents and per-

sonal injury. Contact Simon J. Taylor at Express Building, 29 Upper Parliament Street, Nottingham NG1 2AQ. Tel: 01159 369369. Fax: 01159 350353.

**Pickworths Solicitors.** 6 Victoria Street, St. Albans, Herts AL1 3JB. A leading team of experienced motorsport lawyers, offering a complete range of legal services. Contact Peter Goodman on: 01727 844511. Fax: 01727 844277.

## MEDICAL & FIRST AID

**Advanced Healthcare Technology Ltd.** Hyde House, The Hyde, London NW9 6LH. The leading supplier of all standard and specialist medical and first aid equipment to the motorsport industry. Tel: 0181 201 3829. Fax: 0181 205 2716.

## MEMORABILIA

**Grand Prix Topgear.** No 1 for F1 Memorabilia – clothing body parts, signed items, bought and sold. See our ad under Marketplace 'Memorabilia'. Tel: 01279 843999.

**The Tifosi Shop.** Ferrari merchandise, models, memorabilia. Mail order: (0)1895 819300. Fax: (0)1895 819333. E-mail: hallifax@cct-mundo.net Willow Bank House, Oxford Road, Uxbridge, Middlesex, UB8 1LU. Shop: Talacrest Limited, 74 Station Road, Egham, Surrey, TW20 9LF, UK.

**Collector's Studio Toronto.** Signed original F1 and Indy memorabilia. Helmets, uniforms, prints, models: Senna, Schumacher, Villeneuve, more... Buy/sell worldwide. Tel/Fax: 001-416-975-5442. http://www.cstudiojoe.net Email: cstudio@can.net

**Formula 1 Trading.** For our latest list of F1 memorabilia contact F1TRADING@ADL

## MOTORHOMES

**American Motorhomes** for hire with or without 5m hospitality awning. Delivered anywhere. Many dates available. Phone/fax H.G.C.H. 0161-456 4122, 0385 111031.

## MOTORSPORT PRINTS

**Peter Ratcliffe Legends in Time.** The largest collection of signed motorsport prints in the world specialising in Formula One. Please visit our Galleries at 3 Windsor High Street, Windsor. Tel/Fax: 01753 851998. Also, Thames Avenue, Windsor (behind Theatre Royal). Tel: 01753 622555. Office: 01344 874874. Fax: 01344 622221.

## OIL COOLERS

**Cooling Technology by Serck Marston.** Full range of oil coolers, oil cooler kits and components available. Contact the specialists at Serck Marston Racing Components Division, Units 9 & 10 Bullsbrook Road, Brook Industrial Estate, Hayes Middlesex UB4 0JZ. Tel: 0181 813 7470. Fax: 0181 813 7499. **The world's leading oil cooler specialist,** manufacturers of Mocal equipment. Distributors of Aeroquip hose and fittings for oil, fuel, coolant and brakes. Aston Monza and Aero filler caps. Oil and fuel pumps. Classic instruments plus much more. Think Automotive Ltd, 292 Worton Road, Isleworth, Middx TW7 6EL. Tel: 0181-568 1172. Fax: 0181 847 5338.

## PHOTOGRAPHY

**Chris Dixon Photography – The Professionals Choice.** A polite and specialist service to the motorsport industry. Contact: Chris Dixon, Flat 1, 13 Fairmile Avenue, Streatham, London SW16 6AG. Tel: 0181 677 6575. Mobile: 0831 674055.

## PIT DISPLAYS

**Showtrax.** The leading pit display system designed to be smart, tough and long lasting. Used by professional teams throughout the world. Overhead gantries. Colourworks. Tel: 01525 840460. Fax: 01525 840760. Email: showtrax@colourworks.demon.co.uk

## PROPSHAFTS/DRIVESHAFTS

**Reco-Prop (UK) Ltd,** Unit 4, Newtown Trading Estate, Chase Street, Luton, Bedfordshire LU1 3GZ, England. Contact Peter MacPhail. Tel: 01582 412110/480959. Fax: 01582 480432. Manufacturers and suppliers of propshafts, driveshafts, and CV joints. All makes and models, specials for all motorsport applications, modification, balancing, repairs, plus related spares.

## RACE CAR PREPARATION/ ROLLING ROAD

**Pitstop Racing.** Professional race and test day support. Services include full race preparation, transport, arrive and drive, engine building, in-house rolling road, any formula. Tel: 01993 850654.

## RACING SCHOOLS

**Silverstone Driving Centre.** Single seater and saloon race tuition, from novice to public races. Also circuit coaching for experienced drivers. Corporate day packages also available. ARDS Member, approved by RACMSA. Tel: (01327) 857177. Fax: (01327) 858268.

## RADIATORS/INTERCOOLERS

**Aluminium Radiators by Docking Engineering.** Aluminium water radiators and cooling systems manufactured to your requirements by motorsports leading supplier. We supply quality prototypes and production components direct to teams and manufacturers worldwide. Contact Docking Engineering, Unit 15 Silverstone Circuit, Silverstone, Northants, NN12 8TL. Tel: +44 (0)1327 857164. Fax: +44 (0)1327 858011.

**Cooling Technology by Serck Marston.** We manufacture aluminium, copper/brass racing and performance radiators, oil coolers and intercoolers. Contact the specialists at Serck Marston Racing Components Division, Units 9 & 10 Bullsbrook Road, Brook Industrial Estate, Hayes, Middlesex UB4 0JZ. Tel: 0181 813 7470. Fax: 0181 813 7499.

## RADIO SYSTEMS

**Specialists in pit to car radio systems.** Available for single seater, GT, saloon, rally and karts. Full installation and back-up service available. Autotel Race Radio. Tel: 01508 528837.

## RALLY SCHOOLS

**Silverstone Driving Centre.** Tarmac and loose stage tuition from novice to expert. Corporate day packages also available. BARS member, approved by RACMSA. Tel: (01327) 857177. Fax: (01327) 858268.

## ROD END & SPHERICAL BEARINGS

**Goldline Bearings Ltd.** Exclusive distributors of Ampep Goldline and Silverline bearings. ISO9002 quality assured. Stafford Park 17, Telford, TF3 3DG. Contact Mike Jones/Ryan Currier. Tel: 01952 292401. Fax: 01952 292403.

## SHOCK ABSORBER DYNAMOMETERS

**Dynamic Suspensions Limited.** Suspension systems and damper test equipment from F1 to Rallying. Contact 20 Fison Way, Thetford, Norfolk IP24 1HJ. Tel: 01842 755744. Fax: 01842 752626.

**SPA Engineering** offer a wide range of test machines to suit all formulas worldwide. Extensive data displays in easy to understand formats with all types of shock absorbers. SPA, The Boat House, Lichfield Street, Fazeley, Tamworth, Staffs B78 3QN. Phone 01827 260026. Fax 01827 260528.

## SPARES & ACCESSORIES

**Burton Power Products.** Ford/Lotus/Cosworth high performance engine components and accessories. Fast Mail Order Service. Catalogue/Parts list available on request. 627a Eastern Avenue, Ilford, Essex IG2 6PN. Tel: 0181-554 2281. Fax: 0181-554 4828.

**Demon Tweeks,** 75, Ash Road South, Wrexham Industrial Estate, Wrexham, Clwyd LL13 9UG. Tel: 01978 664466. Fax: 01978 664467.

**Phoenix – Crankshafts.** Cranks with rods made to order. 37 The Business Village, Wexham Road, Slough, Berks SL2 5EJ. Tel: Slough 01753 821303. Fax: 01753 692485.

**Titan Motorsport Manufacturing Co. Ltd.** Harley Industrial Park, Paxton Hill, St. Neots, Cambs. PE19 4RA. Designers and manufacturers of competition dry sump oil pumps, race engine and race car components. Tel: 01480 474402. Fax: 01480 405668.

## SUPERCHARGERS

**Eaton Superchargers.** O.E. quality blowers available through the only official Eaton European aftermarket distributor. For engine sizes 1.5-5.5 litres. Supercharger UK. Tel: 01264 334277.

## SUSPENSION

**Demon Tweeks,** 75, Ash Road South, Wrexham Industrial Estate, Wrexham, Clwyd LL13 9UG. Tel: 01978 664466. Fax: 01978 664467.

**Dynamic Suspensions Limited.** Suspension systems and damper test equipment from F1 to Rallying. Contact 20 Fison Way, Thetford, Norfolk IP24 1HJ. Tel: 01842 755744. Fax: 01842 752626.

**Eibach.** Complete UK motorsport service. Contact: Eibach Suspension Technology Ltd, Unit 5, Swannington Road, Broughton, Leics. LE9 6TU. Tel: 01455 286524. Fax: 01455 285853.

**Leda Suspension Ltd.** For all types of race and rally suspension, parts and services. Unit 1, Park Drive Industrial Estate, Braintree, Essex CM7 1AP. Tel: 01376 326531. Fax: 01376 326530.

**Pilot.** Revolving service for Bilstein shocks. UK and export markets. Experienced capability. Pilot Brands International Ltd., Unit 5 Swannington Road, Broughton, Leics LE9 6TU. Tel: 01455 285850. Fax: 01455 285853.

## TAPE

**TESA – Europe's Number One Adhesive Tape Manufacturer.** Highest quality race tapes and other tapes available exclusively from: Speed-Sport Promotions Ltd., Units 6E/6F, Silverstone Circuit, Silverstone, Nr. Towcester, Northants NN12 8TN. Tel: 01327 858167/858527. Fax: 01327 858518.

## WHEELS & TYRES

**Hoosier Racing Tyres.** M&N Performance. Tel: 01327 312702. Fax: 01327 312701. Mobile: 0976 238747.

**Tecnomagisno.** Extra light magnesium race wheels, all Formula, GT 1 and 2, Saloon, Race or Rally. Also classic Campagnolo for Italian sports cars and Tecnomagisno motor-cycle wheels. Autorano Ltd, of Salisbury. Tel: 01722 410203. Fax: 01722 320831.

## WEBSITES

www.referracing.co.uk



# CLUB **AUTOSPORT**

ALL THE NATIONAL RACE, RALLY & HISTORIC NEWS PLUS FULL RESULTS ROUND-UP

EDITOR DAMIEN SMITH ASSISTANT EDITORS TIM SCOTT, KEITH OSWIN, ANTHONY PEACOCK EDITOR-AT-LARGE MARCUS PYE

## Hill to race at Goodwood

Former World Champion Damon Hill will top the bill of stars racing at the Goodwood motor circuit Revival meeting.

The Jordan Grand Prix star will race in the '60s GT and classic motorcycle events at the meeting on September 19/20.

The meeting will see motor racing return to Goodwood circuit for the first time since 1966, as it celebrates its 50th anniversary.

Hill will race the Ferrari 250 GTO which his late father, double World Champion Graham, drove to victory in the 1963 Tourist Trophy at the Sussex circuit.

The 37-year old, who is an official patron of Goodwood, had been rumoured to be attending the Revival meeting to perform some demonstration runs, but confirmed on Monday he would race.

Goodwood spokesman Rob Widdows said: 'We're absolutely

delighted that Damon will be racing. We've been negotiating it for some time and I'm thrilled it's come together.

'It's an exceptional gesture, bearing mind that he's still in the middle of a World Championship season. We couldn't ask any more of him, and it's great to see a superstar with his feet on the ground.'

Widdows also thanked Jordan Grand Prix boss Eddie Jordan for allowing Hill to compete.

'Obviously Eddie has been fantastic to give Damon permission. I think it will be quite an emotional moment when he goes out in the car his father raced.'

Although Hill's co-driver for the GT race has not been decided yet, the Sir Anthony Bamford-owned Ferrari should give him a

good chance of winning.

Former Grand Prix driver and ITV Formula 1 commentator Martin Brundle will be among the famous names Hill will be pitched against in the GT event. Brundle will be driving a lightweight Jaguar E-Type.

Racing legend Stirling Moss won seven of the nine Goodwood Tourist Trophy races and will also return to race at the circuit where he crashed heavily in 1962, ending his career. He will be in the Ferrari 250 GT SWB he took to victory in 1961.

Former IndyCar champion Danny Sullivan is also racing a Ferrari GTO, as is five-time Le Mans winner Derek Bell.

A brace of Shelby Daytona Cobra Coupes will be piloted by 1961 World Champion Phil Hill and fellow American Bob Bondurant.

Other races on the schedule are

for '50s sportscars, Formula Juniors, '60s saloons.

In the 1.5-litre GP car event, triple World Champion Jack Brabham will be reunited with the Cooper-Climax T53 in which he took his 1960 crown.

Rounding off the top attractions in the car section will be three BRM V16s, which have been reunited specially for the meeting. The MkI and MkII models from the early '50s will be piloted by former GP driver Peter Gethin, Nick Mason and Rick Hall.

The motorcycle event gives Hill the chance to return to his two-wheeled roots.

The GP driver was a full-time bike racer before he switched to cars. He will ride a Manx Norton TT in the race, which also features 1976 500cc World Champion Barry Sheene, racing for the first time since his retirement in 1984.

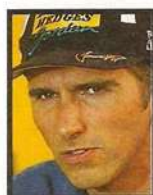

Hill: Ferrari GTO



FORMULA FORD racer Earl Goddard walked away unharmed from this accident in Saturday's race at Knockhill. His First Division Mygale SJ97 clipped the rear wheel of Oliver Smith's Van Diemen (58), and was launched into the Duffus Dip catch-fencing. He will return for the next round at Brands Hatch on August 31

Main picture: Lawrence/LAT. Insets: Jakob Efrey

Pizzonia signs for Manor P98 Hill hits 180mph P101 Knockhill TOCA P104 FPA track test P116



**Humble Pye**

*A spot of deja-vu in Hove brought back memories of the old Delta Race Cars*

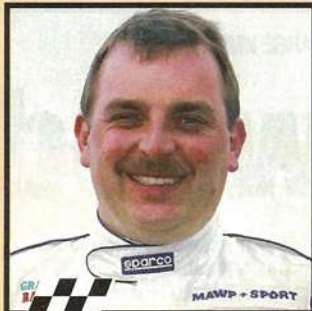

**MARCUS PYE**

Funny how a couple of chance turns down roads in a strange town suddenly place you on familiar territory, isn't it?

So it was last week when I was meandering through the backstreets of Hove on a beautiful summer's afternoon and vaguely recognised a junction. I turned the car, and looked right, into the bright cobbled mews of Wilbury Grove.

I spent many a pleasant hour at number 10A in my youth, for it was home to Delta Race Cars, whose stylish Formula Ford 2000s were then the class of the field. One of my first AUTOSPORT assignments in 1977 was to write a piece on the company, and my old pal Robert Syngé (now BAR's F1 test team manager) and I rode to Goodwood in 'Jemima', Delta's grand old transporter. There, boss Nick Crossley – twice national F4 champ in Chevrons – put one of the immaculate cars through its paces.

Designed by Patrick Head (now technical director of Williams Grand Prix Engineering), the Delta chassis was a beautiful piece of kit, sturdy and sleek. The little workshop which opened on to the mews boasted just enough room for the preparation of a couple of cars. In a small room at the back, another was usually in build, with Ken Taylor (these days fettling priceless Historic racers at Crosthwaite & Gardiner's shop) toiling away. More than 100 were hand-made there, and are still regarded as classics.

Delta is long gone, but Crossley's Pipecraft company flourished, and he's now back racing a Historic F2 Chevron. Wilbury Grove is much the same though. Amid the bustle of small businesses, 10A is operated by Dave West, automobile engineer and enthusiastic speed evener.

A small aluminium electrical box neatly inscribed with the legend 'Manufactured by Delta Race Cars' is now the only remaining clue to the place's heritage. But its connection with the sport goes back much further, for long-time landlord Basil Bowman was a keen competitor in the 1950s and early '60s, in a fine series of machines, including an Austin-Healey, an HWM-Jaguar, a Veritas, a Darracq and the rare Beart Rodger.

# Manor signs winter deal with Pizzonia

Antonio Pizzonia is to compete in the Formula Renault Sport winter series with the all-conquering Manor Motorsport team.

It is hoped that this will lead to him signing a deal with Manor for the 1999 season.

The Brazilian will race a Tatuus RC98 in November's Brands Hatch-based four-race series, but will make his FRS debut in the final two Formula Renault Eurocup races in October.

Should Pizzonia then sign for '99, he will become one of the hot favourites to lift the crown.

He is the champion-elect in the Formula Vauxhall Junior championship, while Manor has won all 12 FRS rounds this year.

Pizzonia's manager, former All-Japan Formula 3 champion Paolo Carcasci, felt that entering the winter series was likely to lead to a full season.

'I think Manor is the best team. If everything goes well it'll be the obvious choice,' he said.

Manor boss John Booth was equally optimistic, saying: 'There's intent there from both parties to join forces in 1999, but nothing's signed and sealed yet.'



**Pizzonia: Manor**

Pizzonia is set for a baptism of fire in the Eurocup races, at the German Hockenheim circuit and at Paul Ricard in France.

'It'll be interesting,' said the 17-year-old from Sao Paolo. 'The opposition will have a whole year's running behind them, but it'll be good experience for next year.'

Leighton Walker will race in the winter series, having signed a deal to drive a Paston Racing Van Diemen. The 20-year old has also committed to a full FRS programme in '99 with the team, and will be a major rival to Pizzonia.

Walker was a frontrunner in FRS in 1997, but has sat out most of 1998 because of a dispute with his former team Tollbar Racing. He returned to racing with Paston in Formula Vauxhall Junior at Snetterton on July 28.

'Doing the winter series will get me back in the groove,' he said. 'I stepped down to FVJ because I needed time in a car after a 10-month lay-off, but I prefer FRS.'

FRS co-ordinator Simon North was delighted with the signings. 'It's absolutely fantastic. It vindicates the decision to run the winter series completely.'

## Menu quits Spiders over exclusion

Menu Motorsport has quit the Renault Spider Cup amid allegations of unfair treatment.

The team, owned by 1997 British Touring Car champion Alain Menu, withdrew driver David Henderson from the rest of the season at Knockhill last weekend. His team mate, Simon Wiseman, will stop after Brands Hatch on August 31.

Henderson had qualified without the mandatory front-splitter on his car last weekend. The scrutineers gave him a bye after the first session, but excluded him from the second. Menu's appeal was turned down by the independent stewards.

Renault UK's Tim Jackson said:

'We didn't make the judicial decision. It was the RACMSA officials.'

Menu team manager Mike Baker was angry because the official parts suppliers, Radbourne Racing, had sold out of splitters, although three teams in the paddock had spares.

'Renault has a beautiful car and championship, but there's just no common sense,' said Baker.

Henderson, who was also excluded from the first race after a clash with Andy Priaulx, said: 'I've been driving a Renault for four years, but to be treated like this is ridiculous. They tell me I'm one of the family, but this weekend has proved otherwise.'



**Henderson leads Andy Priaulx in the first race of the year shortly before their clash**



## Vectra problems to cost MSD dear

Motor Sport Developments will be replaced as builder of the Vauxhall Vectra Challenge cars next year.

Paddock rumours suggest the switch is because of the Vectra's reliability problems this season.

Vauxhall Motorsport boss Mike Nicholson said: 'We're looking at ways of sorting things, but nothing is confirmed.'

MSD boss David Whitehead hinted that the company was unlikely to be involved in 1999. He said: 'Our job this year has been primarily preparing spare parts. We haven't done much at all with the programme.'

## Hunter plans major facelift for Spartan

Renault Spider frontrunner Jamie Hunter will revamp his Spartan Racing Team next year and will take up a managerial role.

The team will have a major new sponsor and plans to run two or three Spiders. Hunter will coach the drivers while concentrating on his touring car ambitions.

His wife and Formula Renault Sport racer Judit Forro will run the team on a day-to-day basis. She is also looking to continue in single-seaters.

'We're talking to several drivers,' said Hunter. 'It's too early to have anything definitive, but we've had lots of positive feedback.'



News in Brief

**Euroseries Formula Opel** team Meritus will test top karter Tom Ferrier at Mallory Park and Snetterton this week. The 16-year old hopes to race in FOpel in 1999.

**Justin Keen was banned** from racing in the opening Formula Palmer Audi race at Pembrey after an altercation with a marshal following a qualifying shunt. He had been clipped into a roll at Hatchets by Topi Serjala before remonstrating with the marshals.

**Suzuki World Superbike hero** Jamie Whitham starred on his four-wheeled racing debut in the Ford Fiesta guest car at Knockhill. He retired in the first race, but finished an excellent eighth in the second. He is keen to race cars again.

**TVR Tuscan Challenge** frontrunner Ian McKellar tested Jake Ulrich's Lister Storm GTL at Silverstone last week, and impressed the team.

**Paston Racing** will run BARC Formula Renault frontrunner Stuart Wood alongside Leighton Walker in its Formula Renault Sport Winter Series squad.

**The works Swift** Formula Ford team did not appear at Knockhill last weekend. The team is short of drivers with a budget, but is thinking of running a car in the World Finals at Brands Hatch on October 25.

**Swift's spirits were lifted** when Geva Racing's Jeroen Bleekemolen clinched the Dutch Formula Ford championship with a third place at Assen in Germany last weekend. The Dutchman will race his SC98Z in the British series at Brands on August 31.

**Former Swift Formula Ford** racer Robert Collard made his debut for the works Van Diemen team at Knockhill. The 29-year-old impressed the team, taking fifth place in the first race.

**Works Van Diemen** Formula Ford driver Marcos Ambrose scored his first win of the year at Knockhill last weekend. The Australian's car was



sporting a new Duckhams livery, the colours of which Van Diemen has run for 14 years.

**BARC Formula Renault** joint champion Matt Bettley made his tin-top debut in the Tomcat/Vento series at Donington. He qualified his family-run VW Vento VR6 well and finished second in class, despite being spun twice.

Pit board mix-up hits Lyons' title chances

Richard Lyons lost an almost certain Formula Vauxhall Junior race win at Knockhill due to a pit board mix-up with his Team JLR crew.

He slowed down a lap too early in the first race and gifted the win to title rival Antonio Pizzonia. This was a severe blow to his championship chances, even though he took his fifth victory of the season in the second race.

Going into the last lap Lyons thought he had won, and cruised round before peeling into the pits. The Ulsterman was eventually classified sixth.

'We have to shoulder the blame between us,' said team boss Richard Dean. 'The monitor in the pits was wrong. With two laps to go we gave Richard a board saying one lap to go. We realised our mistake, but Richard thought it was all over. It's tragic but there's nothing we can do.'

If Lyons wins all three remaining races he can still close the 14-point deficit. However, Pizzonia only has to manage podium finishes to be crowned champion.



Lyons: mix-up



Jeff Braham/AT

Pizzonia ahead of Lyons at Knockhill. Unfortunately for the Team JLR driver, they finished that way

Watts looks to take on the young guns

Former British Touring Car driver Patrick Watts is preparing to take on the Vauxhall Vectra SRi V6 Challenge youngsters.

The 42-year old, who was dropped by Peugeot last year, will race at Brands Hatch on August 31.

The car will be run by Mike Law, who engineered the three Mezzco-Law cars earlier in the season.

Watts wants to compare himself to the frontrunners in the series.

'All these kids have been asked to test a Super Tourer and I want to see how good they are,' he said. 'I'm proving I'm here to race and not to pose in touring cars.'

Scheckter to lose Hockenheim win

Euroseries Formula Opel frontrunner Toby Scheckter may lose his victory and third place from the Hockenheim races.

The engine management system in the South African's Vergani Racing car was found to be illegal by post-race scrutineering at the German track on June 27/28.

The stewards have disqualified Scheckter, but Vergani team boss Francesco Marzi is appealing against the decision.

'For me the exclusion is the first step. It's not finished,' he said. 'Two weeks before, our cars had been legal in Spa. It's very strange.'

FPA winter series offers £40k

The winner of Formula Palmer Audi's inaugural five-race winter series will pick up a £20,000 purse.

The haul is part of a £40,000 prize fund that series organiser Jonathan Palmer has put up to attract new drivers to try his series.

There will be substantial prize money for the second and third-placed drivers, and £5000 will be awarded to the best driver with no slicks-and-wings experience.

Palmer plans to evaluate drivers which he would like to run in FPA next year. 'It's a good way of evaluating talent,' Palmer said. 'I want to pick the highest quality field I can for 1999.'

Anyone who has driven an FPA previously will not be eligible for the series, which costs £16,000. This will ensure that no driver has an unfair advantage.

'The minimum licence will be a National B. The idea is that drivers from Formula Ford and Formula Vauxhall Junior will join,' said Palmer.

An extra race has been added to the double-headers at Brands Hatch on November 1 and 8. It will be at Snetterton on November 15. All the races will be shown on Sky Sports.

Before each meeting there will be a one-day test in the cars, which will run the same specification as those being raced this season.

Ebrahim on top at Euroseries test

Team Meritus' Wagner Ebrahim topped the recent Euroseries Formula Opel test at the Nurburgring in Germany.

The Brazilian's best time of 1m43.05s, set in a completely new car built up by the team, was 0.17s clear of South African Etienne van der Linde. It follows a run of inconsistent results in the ill-handling old car.

'Wagner was on the pace and back to where he'd been before our bad run,' said team boss Roberto Costa.

Championship leader Andrew Kirkaldy was sixth in his Paul Stewart

Racing car, just behind Fortec Motorsport's Darren Malkin.

Kirkaldy, the current McLAREN AUTOSPORT BRDC Young Driver, was pleased to be only 0.3s off his title-rival van der Linde.

'We had a test engine in, so I'm fairly happy to be that close to Etienne,' he said. 'There's only one man for us to think about now.'

Briton Charles Hall was 10th in his first run as van der Linde's team mate at AR Motorsport, while American Paul Edwards set a 1m45.00s on old tyres as he played himself in at Motaworld.

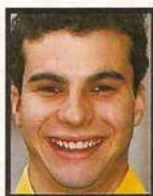

Ebrahim: quickest



# **The Autotecnic BMW Challenge 1998**

*Congratulations to Nigel Groomsall and Stephen Tomkins on their superb class victories and lap records last weekend at Pembrey*



*Thanks to our sponsors  
Cotters Insurance Services, C&D Charter,  
and David Morgan Futures.  
Special thanks to Bob, Brian and Harry.*



# Hill hits 180mph at Snetterton

Chris Hill blitzed a quality field in a triumphant return to sprinting by winning last Sunday's round of the BARC Supersprint series at Snetterton.

The four-time RAC British champion's first run time of 1m00.87s (at an average speed of 115.44mph) saw off any possible threat from reigning champion Roger Kilty, who languished some 2.13s adrift.

Conditions were cooler in practice, when Hill failed to break the magic minute barrier by a mere 0.06s. Telemetry on board his 3.5-

litre Reynard-Cosworth HB 94D recorded 171mph on the approach to Riches, and a staggering 180mph on the Revett Straight. Despite going slower as things warmed up, Hill managed to prune 1.27s from his own record for the event.

Kilty declared his result 'satisfactory', considering that his ageing Pilbeam-DFR MP47 - the same chassis in which Charles Wardle won the 1988 British Hillclimb title with 5-litre Repco V8-power - is best suited to standing starts and was running on sprint rubber.

Fellow Yorkshireman John Garnett was third in his Reynard 92D while fourth place fell to Matthew Mortlock, whose newly-acquired ex-Michele Alboreto Footwork-DFR FA12 made its debut at the Norfolk circuit.

Mortlock, who wanted to put some miles on the car prior to driving in some BOSS Formula races, survived a huge spin at the Bomb Hole on his opening run.

The field was completed by Carl Amos' Lola T90/50 whose spirited late effort failed to peg back Mortlock by a mere 0.29s.



Chris Hill, master of the sprinting art past and present, stunned rivals with a 60-second charge in his Reynard-Cosworth HB 94D

## Team Brask triples Eurocar V8 squad

Leading Eurocar outfit Team Brask is to expand its V8 team to three cars in 1999.

The team has signed V6 frontrunner Paul Sheard to join its V8 squad alongside Alf Boarer. Danish boss and Legends racer Lars-Christian Brask is talking to a 'well known name' for the third seat.

For Sheard, 43, who lies fourth in the V6 points standings, this season is his priority. 'I'm extremely excited about moving up to V8s, but I still have a job to do in V6s,' he said.

Fellow V6 racer Mike Schmidt is also looking to join the swelling V8 ranks next year with a two-car team.

## Bob Davies

Bob Davies, one of the staunchest allies of club motorsport, died on August 10 following a stroke. He was 58 years old.

Davies, whose enduring love of the sport began as a competitor in rallies, was a driving force behind Castle Combe's success.

'Bob was a very significant figure in the area,' said Combe boss Howard Strawford about his friend of 40 years. 'He played a major role in developing the circuit. We worked together through thick and thin.'

Davies, a key member of the Welsh Counties Car Club and the BTRDA, was often an RAC Steward.

He leaves a wife, Jill, and son Dan.

## Cumming heads Huron revival

The Huron marque, which enjoyed major Camel sponsorship for its 2-litre Group 6 sportscar team in the early 1970s, is making a comeback this season, with Cheshire driver Andy Cumming at its leading edge.

The Multiple BARC Sports Saloon Challenge champion acquired the first of the three Huron chassis from the now-defunct ADA Engineering concern last year.

Now, the aerospace engineer - who builds his own BDG engines - is racing 001 in the International Supersports Cup. He is also, along with some friends, formulating plans to reunite all of the stylish cars in the 1999 series.

Steve Watkins has already imported Huron 003 from the USA, and agreement has apparently been reached to bring 002 back for another team member. Hopefully, they will all run in Camel livery.

The cars were designed by the late Jo Marquart between him leaving McLaren (where he worked on the Can-Am M8) and founding the GRD, Modus and Argo concerns. The Hurons were raced by the likes of Roger Enever and Shaun Jackson.

'They are super little cars, very underrated,' said Cumming at the Nurburgring's Oldtimer GP. 'Once I get the hang of it after years in Lotus Elans, I'm sure it'll be competitive.'



Andy Cumming's Huron-BDG leading from Bruce van der Merwe's Chevron B19 at Monza

## News In Brief

### Ian Griswold's National Saloon

nightmare continued at Pembrey when his Honda Integra's diff failed in qualifying. In the first race he was an innocent victim as Dave Allan rolled across his bonnet, but the car survived to take fourth place and a new lap record in the second.

### Both Synchro Motorsport Hondas

were eliminated in the first National Saloon race at Pembrey. After Dave Allan's flipped on the entry to Hatchets hairpin, Kevin Hicks clashed with Stuart Clarke. Neither car made the second race.

**A top six finish** at Silverstone this weekend will secure Neil Riddiford the Supersports 200 title with two of its 12 rounds to run. Only Mike Swinnerton has a mathematical chance of catching the Nemesis racer in the Chapman Mantis.

**BMW racer** Dave Kempton is keen to contest the International Serie Group N races at Mondello Park and Donington, with a view to running a new M3 next year. Kempton loaned his Autotechnic BMW Challenge M3s to Nigel Greensall and Stephen Tompkins at Castle Combe last weekend. Both won their classes.

**Mike Roberts is joining** the Sportscar LM3000 series having bought the ex-William Hewland ProSport 3000 title winner. Mat Howard is also bringing his 2-litre Protosport out for the Snetterton race on August 31. Contingent on it being won by an LM3000 driver, the owners' club has put up a £1000 prize.

### Motorsport Industry Association

chairman Rob Baldock and Jonathan Spencer-Jones have signed up to race in the Sportscar LM3000 series, having qualified for RACMSA National A licences.

**Practice starts** on the warm-up lap cost Irish visitor Stephen Mawhinney dear in Sunday's Classic Formula Ford 1600 round at Snetterton. The 10-second penalty dropped him to fifth, handing victory to compatriot and series leader James Hagan.

**A superhuman effort** by Formula Saloon racer Richard Wood got his Vauxhall Calibra V8 into the Pembrey double-header. After a major transmission failure in qualifying, he dashed home to Manchester overnight to engineer replacement parts and, after two hours sleep, got back to Pembrey to take two top-three finishes. Sadly, the field comprised only eight-cars.

**Having set BTD** at a Ty Croes Sprint, ex-rally driver Mark Budgett took the DJ Monoposto to second in class on its race debut at Snetterton on Sunday. Del Quigley's design is powered by a 1100 Suzuki GSXR engine, but will also accept a conventional car engine and Hewland gearbox.



# LAST CHANCE...!

September 6 – 12  
September 28 – October 4  
November 1 – 8

...to train and RACE at  
Donington before the  
**JIM RUSSELL RACING  
DRIVERS SCHOOL**  
moves on to Silverstone

## DOUBLE BONUS!!

- Automatic entry to World Scholarship
- Formula Atlantic drive in US up for grabs!



For details phone:  
**01332 811430**



Designed and produced by Production Design Ltd. 01480 99060



-  **Pi Research Ltd**  
+44 1223 441256
-  **Pi Research Inc**  
+1 317 259 8900
-  **Amir Nasr Racing**  
+55 61 274 3010
-  **Forsman Racing**  
+46 8 608 1800
-  **Rechsteiner Racing**  
+41 21 866 16 66
-  **Krontec**  
+49 9401 703 045
-  **SEC S.R.L.**  
+39 59 45 21 23
-  **L&S**  
+33 386 21 29 80
-  **Pi Research Australia**  
+61 296 303584
-  **Doo Jin**  
+82 2 597 7494
-  **Le Mans Co**  
+81 3 3400 5086

**Pi Research**  
www.pi-group.com

## Pi Research data logging and control systems

**System 3+** - Cost effective and totally flexible  
 ■ up to 20 analogue channels ■ 4 wheelspeed inputs  
 ■ RTD and strain gauge options ■ compact dash or pro' dash instrumentation  
 ■ serial or CAN interface to ECU

**System 4+** - Outstanding performance and expandability  
 ■ up to 30 analogue channels  
 ■ 6 digital inputs ■ 4MB memory option  
 ■ 3 stage expansion options ■ real time telemetry  
 ■ serial or CAN interface to ECU

**System 5STAR** - Top-of-the-range  
 Pi data logging system ■ up to 48 analogue channels  
 ■ 12 bit resolution ■ up to 12MB logging memory  
 ■ burst logging ■ V6 analysis software and C programming kit for control applications



**Pi Research Limited, Milton Hall, Church Lane, Milton, Cambridge, CB4 6AB, UK**  
Tel: +44 (0) 1223 441256 Fax: +44 (0) 1223 441249

From Formula One to Touring Cars

# Del West Lightweight Valvetrain and Pneumatic Valve Control Systems

Del West precision-manufactured titanium valvetrain components are the standard in major racing series around the globe, specified by the makers of everything from the exotic, 17,000-rpm engines in Formula One to the turbocharged engines of CART and the pushrod V8s of NASCAR. Even in rev-limited series like touring cars, Del West lightweight titanium valves provide engine designers with greater flexibility.

In addition to titanium valves and valvetrain components, we design and manufacture an engine-specific pneumatic valve control system, now racing in Formula 1. That system is just one reason why engine builders and engine designers depend on Del West for engineering support, as well as the ultimate quality in manufacturing.

Del West products don't just live in the harsh environment of today's high-speed racing engines; they thrive on it.

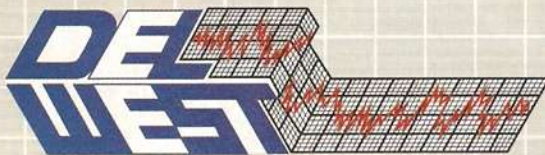

For additional information, contact

**Del West Engineering**  
28128 West Livingston  
Valencia, California 91355 U.S.A.  
**Telephone:** 805-295-5700  
**Fax:** 805-295-8300

**Del West S.A.**  
Chemin de Marjolin 75-77  
C.P. 358, 1860 Aigle CH  
**Telephone:** 02-44-66-96-36  
**Fax:** 02-44-66-96-38





Jerry Sturman



Rebuilt overnight with parts from Tim Painter's version, RAC champion David Grace's Gould-Ralt was good enough for second place

# All-nighter is a saving Grace

Newly-crowned British Hillclimb champion David Grace bounced back from a big accident late on Saturday's practice day at Shelsley Walsh to trail season-long adversary Roger Moran by a scant 0.06s in Sunday's Top 12 Run-off.

Grace's 3.5-litre Ford DFR-engined Gould Ralt GR37 was pitched into the barriers before the Esses when a gearbox-mounted suspension crossmember detached as the car bottomed out through the kink at more than 120mph.

The damaged machine was rushed to Gould Engineering

Services's Newbury factory. There, builders David and Sean Gould, Grace himself and long-time crew chief Ian Dayson worked through the night to effect repairs.

Having replaced the nearside suspension, and borrowed front and rear wings and a nosebox from Tim Painter and Andy Fraser's Somerset-based Sureboard GR37, the exhausted team returned to Worcestershire where Dayson's efforts were rewarded with the Clarks Motor Group Midland Championship's Man of the Meeting award.

During Sunday's championship qualifier, Roy Lane also suffered a suspension rocker failure at exactly the same point on the course.

The four-time RAC champion, who had set best time of the day, escaped unscathed when his 4-litre Pilbeam-Judd MP58-9 spun harmlessly to a standstill at the Bottom Ess.

The championship continues at Gurston Down, near Salisbury, on August 30, where Grace and Moran will both be gunning for Andy Priaulx's outright record, which was set in 1995.

## HSA behind Sprint School at Combe

The Hillclimb and Sprint Association runs its first Sprint School at Castle Combe on Thursday, October 15.

Quadruple British champion Chris Hill will be chief instructor.

Paul Parker and Phil Price, both vastly experienced competitors, will help Hill guide beginners and novices through the discipline in their own road cars.

The 1.8-mile Chippenham circuit was selected for its appropriate characteristics and facilities.

The aim is for beginners to acquire AHASS membership, which will enable licence upgrade signatures to be offered.

## No holds barred for the full Monte

Twenty more crews will get a run on the 10th Monte Carlo Challenge, thanks to a reorganisation of the marshalling schedule and a fruitful search for extra accommodation.

The 200 crews who set off could find themselves used as guinea pigs for a new set of regulations. Rally director Philip Young intends to switch his regulations from the 'old-car governing body' FIVA to a new set devised by the FIA.

Young believes the new rules offer a way ahead. 'The least we can do is give them a try,' he said. Organisers from other rallies will attend to witness the experiment.



Marcus Dodd last visited Silverstone's ralliesprint in 1997. Now he's back with a new car

## Mintex series invades Silverstone

The Mintex championship will visit Silverstone's Ralliesprint circuit for only the second time in the series' history this weekend.

The contest on Sunday will include categories for Group A, Formula 2 and Group N, as well as a one-make knockout competition featuring Ford Kas, Skoda Felicias and Nissan Micras.

One of the event's highlights will be the appearance of Subaru and Ford World Rally Cars. They will be driven by reigning champion Brian Lyall, and last year's Mintex ralliesprint winner, Marcus Dodd.

The Open class will be contested by Steve Smith. He has come out of

retirement to drive a Lancia Delta Integrale, similar to those which dominated the world championship for makes from 1987 to 1992.

Mark II Escorts will form the field for the Roger Clark Memorial trophy, while ITV F1 pit lane reporter Louise Goodman will square up to former Ladies' champion Rosemary Smith in a far more modern Ford Ka.

'Rosemary has taken on and won against the very best, so I'm expecting a bit of a thrashing' said Goodman. 'I'm getting used to being beaten though, and I'm sure it'll be very good fun!'

Qualifying runs are on Saturday, with racing starting on Sunday at 1400.

## News In Brief

**Five-times RAC** British Hillclimb champion Martyn Griffiths drove Dean Butler's ex-Whitney Straight 2.5-litre supercharged Maserati T26M Grand Prix car at Shelsley Walsh last weekend. Griffiths will again pilot the car, in which Straight held the outright record at Shelsley in 1933, at Prescott's Gold Cup meeting on September 6.

**Second place** on Ulster's 1.7-mile Cairncastle course means that Pilbeam MP82 driver Robert Morgan leads the CarSport ANICC Hillclimb Championship into its finale at Garron Tower on Saturday. Defending champion Robert Woodside must win the event and break the course record, without Morgan beating the existing mark, to retain his crown.

**John Page flew the British flag** in last week's Parenty hillclimb, near Boulogne in northern France. He finished runner-up to local man Bernard Nattier's 1600cc Ralt-BMW RT31. Alain Sigalat (Ralt-VW RT32) and Roger Barbera (Reynard-Alfa Romeo 913), chased Page's remarkable VW-engined Reynard FF2000 home.

**Former RACMSA steward** Berry Brooke attended the BARC Super Sprint at Snetterton on Sunday, 39 years to the weekend after he made his competition debut there in a sprint. Brooke has returned from living in Spain, and is keen to get back officiating at weekends.

**Keighley's Bobby Fryers** has stormed to the top of the Yorkshire Auto Trader BARC Harewood Hillclimb championship in his Renault Clio Williams. A non-championship event on the original short course takes place on the eve of September 12's decider.

**Next month's Woodpecker Stages Rally** is bursting at the seams. Organisers will once again face the problem of whittling down entry applications by half before the September 5-6 event. This is a familiar problem for the rally, which is included in no less than eight separate championships.

**Last week we erroneously** credited Nick Skelton with Daihatsu class victory on the McRae Forest Stages. While Skelton holds a two-point championship lead over Eynon Price after five of the seven events, victory on the day went (for the second time) to Charles Jukes.

**Martin Schanche has sold** his Escort-based rallycross supercar and does not have a drive lined up for the 1999 season. 'I have no idea what I'll do next year' said the six-time European champion. 'I would like to build a Focus, but I have heard nothing from Ford Norway. If I don't get a deal with them I'll go elsewhere. You can make any car competitive - it's just a question of time and money.'



# Coelho edges closer to FRS title

**A** win apiece for Manor Motorsport's Aluizio Coelho and Doug Bell brought the title a step closer for the Brazilian.

By way of consolation, Bell's win in the second race came after the year's best lead battle.

The Tatuus cars of Coelho and Bell had annexed the front row for the first race, with the Van Diemens of Martin Donnelly Racing's Vitor Meira and Redgrave Racing's Tim Mullen filling the second row.

Coelho got a great start and charged into the lead. He was given some breathing space when Bell got sideways out of the chicane and came under pressure from Meira. Meira then himself got a bad exit from the hairpin and Mullen grabbed third place down the straight.

Mullen stayed with Coelho and Bell as the leading trio broke away, while Meira, struggling with a weak engine, ran a lonely fourth.

At mid-distance Bell made a sterling effort and closed on to Coelho's tail, but around the tight, twisty confines of Knockhill there was little chance of overtaking. A glimmer of hope emerged from the arrival of the safety car on lap 14, after Jean de Pourtales had clashed with Gavin Jones and was left stranded at McIntyre.

Coelho timed his restart to perfection, however, and from there held off Bell to the flag for his seventh win of the season. 'My tyres overheated a bit as Doug's came good,' said Coelho. 'But we were very even all race, right on the edge.'

Mullen had his mirrors full of Meira after the safety car peeled off, but held third to the end, while Martello Racing's Chris Clark was a safe fifth as the third Manor car of Tor Sriachavanon tried in vain all race to pass Juan Jose Font.

Jones took the Star Cup win after Robbie Kerr had broken a driveshaft on the start line. It should have gone to Judit Forro-Hunter, though, who was leading until the pace car period, after which her engine played up and she ran home a disappointed second.

Bell had pole for the wet second race, while an excellent lap from Sriachavanon put the Thai on the outside of the front row. While Bell

leapt into the lead, Coelho dived to the outside from his third grid spot and rounded Sriachavanon into Duffus Dip. He then tried unsuccessfully to get past Bell into McIntyre, as they pulled away with Sriachavanon holding up Mullen, Clark and Meira.

The next 20 laps produced a battle royal from the leading pair. Coelho ran tucked into Bell's tail, but Doug refused to crack under the incessant pressure. On lap 15 Coelho finally made his decisive move, outbraking Bell down the inside into Duffus Dip. Bell stayed with him though, and when they came to the same corner on the next lap, Coelho, who had just changed his brake bias, locked up and shot over the gravel, allowing Bell back in front. From there, Bell had a small gap he held to the flag to keep his title hopes alive.

'I wanted to play safe,' said Bell. 'It's kept my chances going. We've got to keep trying.'

Third went to Vitor Meira, as he passed Sriachavanon on the last lap after the Thai thought the chequer had flown a lap earlier. Meira had taken fourth on lap eight after Clark and Mullen clashed at the hairpin, the resultant damage bending the latter's steering arm and sending him into the gravel and retirement at the next corner. This left Clark to hold off Font for fifth.

The improving Rob Austin took seventh, and once past Star Cup winner Kerr, set fastest lap.

● Tim Scott

**FORMULA RENAULT SPORT RACE ONE (23 LAPS)**

1 Aluizio Coelho (Tatuus RC98) 23m23.286s (76.70mph); 2 Doug Bell (Tatuus RC98) 23m23.922s; 3 Tim Mullen (Van Diemen RF97); 4 Vitor Meira (Van Diemen RF98); 5 Chris Clark (Tatuus RC98); 6 Juan Jose Font (Tatuus RC98); 7 Tor Sriachavanon (Tatuus RC98); 8 Rob Austin (Tatuus RC98); 9 Gavin Jones (Tatuus RC97); 10 Giandomenico Brusatin (Tatuus RC98). **Star Cup** 1 Jones 23m37.854s (85.91mph).

**Fastest laps** Coelho 52.069s (89.881mph); Jones 53.405s (87.632mph). **RACE TWO (20 LAPS)** 1 Bell 19m23.915s (80.41mph); 2 Coelho 19m24.190s; 3 Meira; 4 Sriachavanon; 5 Clark; 6 Font; 7 Austin; 8 Robbie Kerr (Tatuus RC97); 9 Jones; 10 Jean de Pourtales (Van Diemen RF97). **Star Cup** 1 Kerr 19m44.238s (79.03mph). **Fastest laps** Austin 56.865s (82.300mph); Jones 57.205s (81.81mph).

**Championship positions after 12 rounds** 1 Coelho 332pts; 2 Bell 274; 3 Mullen 220; 4 Font 178; 5 Meira 166; 6 Sriachavanon 124. **Star Cup** 1 Kerr 116pts; 2 Jones 96; 3 Chris Buncombe 57. **Next round** Brands Hatch August 31



FRVJ August 15/16 In association with AUTOSPORT

# Weekend of mixed emotions for Lyons

*Richard Lyons was robbed of one win by a pit mix-up, and nearly lost another after a penalty. By Tim Scott*

**A** weekend of wildly varying fortunes befell Richard Lyons in the double header north of the border. He triumphed in the second race despite a 10-second penalty, but a bizarre incident cost him certain victory in race one, handing the vital win to his title-rival Antonio Pizzonia.

The pressure was on for the dry first race as pole-sitter Pizzonia and Lyons lined up on the front row. The Brazilian got his Lewis Motorsport car away well to take the lead from Lyons as they made a break from the pack within the first lap. Tomas Scheckter was pushing Leighton Walker hard for third from the outset, with the South African's John Village Automotive team mate Johan Fourie and Team JLR's Robert Bell joining the battle by lap three.

Leader Pizzonia was able to hold off Lyons' advances over the early laps, but the Ulsterman stayed glued to his gearbox. It wasn't to remain a two-horse race, however, as Scheckter began to make inroads on their advantage. He had passed Walker's Paston Racing car at the hairpin on lap four and from there he was flying, soon making it a three-way battle at the front.

The balance of the race then swung completely in just two corners. Scheckter made a great move on the outside of Lyons as they rounded the hairpin for the

ninth time. On the charge down to Duffus Dip he slipstreamed up behind Pizzonia and dived down the inside to take the lead. They touched though and Pizzonia was forced wide, letting Lyons through as well. Lyons then led briefly, but Scheckter soon re-established his advantage and opened up a small gap, while Pizzonia held third.

Fourie was now closing in on the action. He'd been demoted from fifth by Bell at Duffus Dip on lap six, the culmination of a protracted scrap. They had then both moved up a spot when fourth-placed Walker had an off into the Duffus gravel. He eventually finished eighth. Fourie carved past Bell again on lap 11, and the pair benefited from the battle in front to close on the leaders.

Lyons began to put Scheckter under pressure. With four laps remaining, he came from a long way back up the inside of the leader at the hairpin. They clashed, and Scheckter bent his right front suspension and would coast into



Pizzonia has a healthy championship lead



Doug Bell won the second race after an assured drive in tricky weather conditions



# Cool Button eyes up Ford crown

Tomas Scheckter, Richard Lyons and Antonio Pizzonia were leading contenders throughout the weekend



retirement on the next lap.

Lyons now held a 0.6s lead over Pizzonia, who was clear of Fourie and Bell. The Ulsterman looked set for victory, but it all went wrong a lap from home. A mix up with his Team JLR pit-board crew meant the Ulsterman thought he'd finished when there was still a lap to go - he slowed, allowed Pizzonia through to win and finished sixth. For Pizzonia it was perfect.

Lyons said: 'I can't believe it. I'd seen my pit board saying one lap to go, and although they corrected it, I thought it was over.'

Fourth was Yugoslavian Milos Pavlovic, who withstood race-long pressure from Team DFR's John Dalziel. Both had trailed Diamond Racing's impressive new recruit Takuma Sato, before he retired with a water leak, while sole Class B runner Gary Paffett finished a 10th.

Lewis Motorsport's James Hanson, a victim of a broken wishbone in race one, had taken his maiden pole position for Sunday's wet race. He converted it to head Fourie around the opening lap. Lyons moved ahead of Scheckter to take third, while Pizzonia dropped to eighth as he struggled with a breathless engine.

Lyons was the man on the move, and took Fourie and then Hanson at the hairpin on successive laps. His break was stymied by the appearance of the pace car on lap five, however. Walker had been hit by Sato at Duffus Dip, and the cars were blocking the track.

At this point Scheckter had nipped past Fourie for third, but it was later deemed to be during the pace car period and the South African was excluded from his second place finish.

Approaching the restart, Lyons dropped away from the pace car to give himself a run at the green flag. He also receive a penalty after the race, but the 10-second penalty was not enough to rob him of the win. After the pace car, Lyons' break

was immediate and permanent, and while Scheckter demoted Hanson at Clark on lap eight and they moved clear of the field, he was not able to challenge the Ulsterman. Hanson led the pack in third, while Bell's chances disappeared as he dived inside Fourie at Duffus Dip, they clipped wheels and he speared into the tyre wall.

Fourie swarmed over Hanson's gearbox, Paffett looked threatening in fifth and Pizzonia clawed his way towards them. Paffett's glory run ended when he went off at the chicane on lap 14. He rejoined the track to battle with James Welsman and clipped the Mach 1 cars' wheel. A lap later his suspension collapsed. Welsman continued, but was troubled by a faulty exhaust, and lost his fifth place to Pavlovic.

Fourie got past Hanson on lap 19, only to spin it away at the chicane. He recovered to finish fifth. Hanson tried to fend off Pizzonia in the closing laps, but the Brazilian got past at Clarke on lap 21 to take third on the road, soon to be second.

Lyons' good display will always be marred by his missed chance, while Pizzonia drove sensibly. 'It's been a great weekend for the championship,' said Pizzonia. He's still catchable, but the task is now even harder.

**FORMULA VAUXHALL JUNIOR RACE ONE (20 LAPS)** 1 Antonio Pizzonia 18m16.006s (85.40mph); 2 Johan Fourie 18m19.298s; 3 Robert Bell; 4 Milos Pavlovic; 5 John Dalziel; 6 Richard Lyons; 7 Gavin Pyper; 8 Mark Taylor; 9 Leighton Walker; 10 Gary Paffett. **Class B** 1 Paffett 18m39.630s (83.59mph); no other starters. **Fastest laps** Pizzonia 53.558s (87.382mph); Paffett 54.786s (85.423mph). **RACE TWO (23 LAPS)** 1 Lyons 26m49.664s (67.28mph); 2 Pizzonia 26m50.329s; 3 James Hanson; 4 Fourie; 5 Pavlovic; 6 James Welsman; 7 Taylor; 8 Johnny Eastwood; 9 Pyper; 10 John Dalziel. **Fastest laps** Pizzonia 59.197s (79.058mph); Gary Paffett 59.780s (78.287mph). **Championship positions after 13 rounds** 1 Pizzonia 170pts; 2 Lyons 142; 3 Tomas Scheckter 83; 4 Fourie 69; 5 Bell 64; 6 Paffett 47. **Class B** 1 Paffett 238pts; 2 Yuya Sakamoto 132. **Next round** Brands Hatch August 31

For Marcos Ambrose it was a weekend to celebrate as he scored an excellent maiden win in his works Van Diemen, but Jenson Button's victory in the second race strengthened the Mygale driver's grip on this year's Formula Ford crown.

ADR Motorsport's Tom Sisley had claimed pole position for the first race, but local man Craig Murray carved around the outside to take the lead at the start. The works Van Diemens of Ambrose and Dan Wheldon were right behind, as the Haywood duo of Derek Hayes and Button sandwiched sixth-placed Nicolas Kiesa.

Ambrose dived past Sisley into the hairpin on the second lap, and then passed Murray's Mick Gardner Racing Van Diemen on the next tour. Wheldon also slipped past Sisley, and this quartet went clear of the pack.

They ran nose-to-tail throughout, with Murray applying lots of pressure on Ambrose. He set fastest lap and pushed the leader all the way. Ambrose also had the added hazard of having to deal with a restart, when the safety car appeared after Earl Goddard had a big accident at Duffus Dip on lap three. His Mygale had been launched by the back of Oliver Smith's Van Diemen and flipped several times before slamming into the catchfencing. He was fortunate to escape unharmed.

Despite Murray's best efforts the Australian held out, and christened the team's new Duckhams colour scheme with a win.

The luckless Wheldon, who had in turn shadowed Murray throughout, lost his third place on the last lap, when his throttle cable frayed and he helplessly trickled round to finish eighth. This allowed Sisley up to a good third place after a competitive run, while Button would claim fourth after Kiesa was later excluded. The Dane had been distracted by his battle with Button as the pace car came out and ran into the back of Hayes, which the stewards deemed dangerous.

Button had worked his way through, after dealing with the third works Van Diemen of Robert

Collard, and passed Hayes when the Irishman had an off a Duffus. Once again, when things weren't in his favour, Button still managed to pull off a good result and outscore his major championship rivals.

For the wet second race, Button had pole position and immediately took command off the line. Fellow front-row starter Wheldon squeezed over on Ambrose, forcing the Australian on to the grass, but he lost his second place when Murray and Ambrose passed at the hairpin.

Button was extending his lead gradually to four seconds as Murray and Ambrose circulated together. At mid-distance Murray began to close the gap to the leader, but by the end of the race lapping tailenders blunted the Scot's challenge and he had to accept runner-up spot again.

Ambrose never let up but a quick foray into the hairpin gravel on lap 18 allowed the chasing Kiesa through to third. Wheldon got the better of a good battle for fifth with Hayes, while Sisley came home seventh after a fighting off Barry Horne and Collard. Jeremy Smith took a first and a second in the First Division to lead the championship.

Murray scored the most points, but of the championship challengers Button came out best, and with four races left only his Haywood team mate Hayes can really stop him.

● Tim Scott

**FORMULA FORD RACE ONE (22 LAPS)** 1 Marcos Ambrose (Van Diemen RF98) 21m52.750s (78.43mph); 2 Craig Murray (Van Diemen RF98) 21m52.868s; 3 Tom Sisley (Van Diemen RF98); 4 Jenson Button (Mygale SJ98); 5 Robert Collard (Van Diemen RF98); 6 Derek Hayes (Mygale SJ98); 7 Richard Antinucci (Mygale SJ98); 8 Daniel Wheldon (Van Diemen RF98); 9 Jeremy Smith (Van Diemen RF97); 10 Julian Barratt (Mygale SJ97). **First Division** 1 Smith 22m19.407s (76.87mph); 2 Barratt 22m20.606; 3 Tom Herridge (Van Diemen RF97). **Fastest laps** Murray 54.259s (86.253mph); Smith 55.537s (84.268mph). **RACE TWO (20 LAPS)** 1 Button 20m15.818s (76.98mph); 2 Murray 20m18.844s; 3 Nicolas Kiesa (Van Diemen RF98); 4 Ambrose; 5 Wheldon; 6 Hayes; 7 Sisley; 8 Barry Horne (Van Diemen RF98); 9 Collard; 10 Mark McKenna (Mygale SJ98). **First Division** 1 Oliver Smith (Van Diemen RF97) 20m57.844s (74.41mph); 2 J Smith 21m00.796s; 3 Herridge. **Fastest laps** Murray 59.769s (78.301mph); Herridge 1m01.253s (76.404mph). **Championship positions after 11 rounds** 1 Button 116pts; 2 Hayes 101; 3 Ambrose 75; 4 Wheldon 70; 5 Kiesa/Murray 63. **First Division** 1 J Smith 92; 2 O Smith 86; 3 Earl Goddard 74. **Next round** Brands Hatch August 31



Jenson Button won the wet second Formula Ford race to increase his championship lead



# Spectacular passing wins Fiestas

Simon Clarke led Saturday's Fiesta race from start-to-finish, whereas Alan Morrison had to pull off a couple of spectacular moves through the hairpin to win Sunday's contest.

Knockhill instructor Neil Hose qualified on pole for the first race, but Clarke stormed into the lead, followed by Hose and Colin Stancombe. Morrison then moved up into third after pulling off an excellent manoeuvre on Stancombe, but the pressure was beginning to tell on Clarke as he slid wide exiting the hairpin. The leading seven were nose-to-tail, but Clarke was eventually able to pull out a four car-length lead.

It was then Hose's turn to run wide at the hairpin, allowing Peter Cate a run up the inside. The two ran side-by-side along the start/finish straight, with Hose just managing to defend his position.

Michael Cullen's solid drive allowed him into the top 10, but World Superbike star James Whitham driving the guest car found himself under pressure from Gareth Howell for 11th. Morrison was again mounting a strong challenge in the leading pack, but had a major moment on lap six which dropped him to last.

Clarke continued to lead from Cate and Hose, until Cate dropped back into third. Rae Claydon decided to call it a day and slid off on lap 11. Whitham was now ninth, but had the black and white 'your driving is being observed' flag shown to him. On lap 12, he approached the hairpin with several other cars, ran wide and retired.

Cate challenged Hose for second at Duffus on lap 16. The two made contact, and Hose was sent sideways towards the gravel. As the car skipped along the trap, the side dug in and pitched the Fiesta into a low-speed roll. Hose was shaken but unhurt, and Clarke crossed the line some distance ahead of Cate and Gordon.

After the race the stewards ruled Cate was to blame for Hose's accident and excluded him from the results. However, on appeal he was reinstated. Colin Stancombe was

also excluded for driving offences, and is appealing to the RACMSA.

BIM Motorsport worked overnight to repair Hose's Fiesta, and the end result was admirable. Neal Gordon converted his pole position to an immediate lead on Sunday, but he was constantly harried by Morrison and Hose. Clarke had slipped from second to fourth, and during the second lap this quartet started to break away.

On lap three Morrison and Hose were side-by-side on the start/finish straight, with Hose taking second through Duffus. Clark was still fourth, with Claydon gaining slightly in fifth and Stancombe a bit further back in sixth.

Whitham seemed to enjoy the tricky conditions and was up to 11th from 14th on the grid. Back in eighth Henry Taylor and Cate were having an exciting battle, with Cate emerging the victor.

The lead was being disputed by Hose and Gordon, with Hose going through at the hairpin on lap four. Morrison was still third, followed by Clarke and Claydon.

Morrison was crawling all over the back of Gordon's car and passed it with an ambitious move which started on the outside of the slippery hairpin. Morrison then set about the leader, passing Hose with a near-identical manoeuvre on the penultimate lap to win. Gordon and Hose then clashed, demoting Gordon to fifth. Hose was subsequently excluded by the stewards. Whitham took a deserved eighth place, commenting: 'Wow! It was wild out there.'

'I think car racing's great!' said the works Suzuki rider. 'I'd love to give it another try soon.'

● Anthony Peacock

**FORD FIESTAS RACE 1 (17 LAPS)** 1 Simon Clarke 19m09.244s (69.22mph); 2 Peter Cate 19m17.804s; 3 Neal Gordon; 4 Michael Neuhoff; 5 Daniel Buxton; 6 Alan Morrison; 7 Michael Cullen; 8 David Gibson; 9 Mark Burton; 10 Henry Taylor. **Fastest lap** Rae Claydon 1m06.502s (70.374mph). **RACE 2** 1 Morrison 20m35.970; 2 Clarke 20m37.717s; 3 Neuhoff; 4 Gordon; 5 Cate; 6 Colin Stancombe; 7 James Whitham; 8 Cullen; 9 Michael Burton; 10 Taylor. **Fastest lap** Morrison 1m11.418s (65.530mph). **Championship positions after round 11** 1 Clarke 159; 2 Gordon 143; 3 Morrison 133; 4 Cate 109; 5 Claydon 105; 6 Gibson 94



Simon Clarke leads local hero Neil Hose in the first Fiesta race, chased by the pack

# Figueiredo's wheel of fortune

Luck was on the Brazilian's side. By Anthony Peacock

Mark Blair should have triumphed in both Vectra races, but ended up winning one. He was in control on Saturday, taking pole position and the race lead with consummate style. However, a braking problem that started on lap six made an impact with the tyre wall inevitable, and Blair careered off at McIntyres on lap 14 while leading. 'The pedal was getting longer and longer and on that occasion off I went,' he explained.

This handed the lead to Simon

Graves, but he too was hit by a mechanical gremlin with just two laps to go. A gear selector component broke, jamming the car in fourth gear. Graves continued at reduced pace, which allowed Flavio Figueiredo to pass him for an unexpected win. The Brazilian had qualified second, in front of Graves, but dropped to third after an off-road excursion at McIntyres on lap 11.

Jason Yeomans took his second third place of the season, equalling his best result of the year.

Paula Sears drove a fantastic race on what she described as 'my favourite circuit' to take fourth

Flavio Figueiredo won Saturday's race but was excluded from Sunday's after a searing drive from the back of the grid

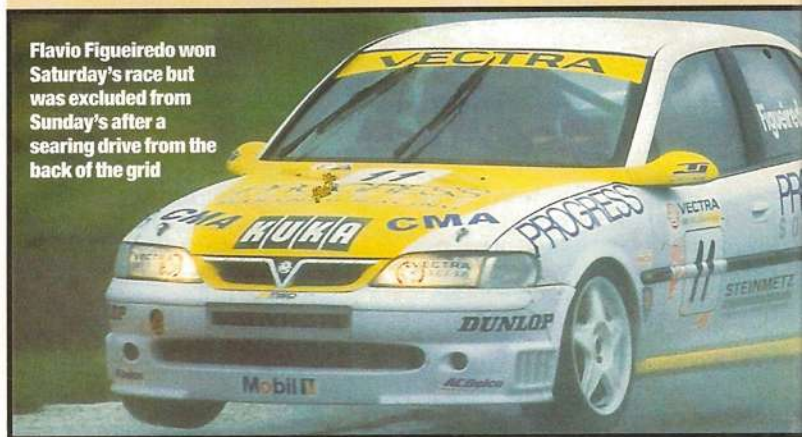

# One each for Hunter and Vercoe

Jamie Hunter and Duncan Vercoe took a win apiece at Knockhill's double-header, after two races as stormy and unpredictable as the weather.

Andy Priaulx took his first Spider pole for Saturday's race and immediately took the lead, hotly pursued by Hunter.

Tobia Masini's race was short, an ECU problem causing his Mardi Gras car to cut out before the end of lap one. Hunter got past Priaulx on lap two, while Duncan Vercoe, who had qualified fourth, slid wide at the chicane, ending his race in the gravel.

A hard-charging David Henderson had meanwhile forced his way into the lead on lap four, from fifth on the grid. The field was bunched even closer when the safety car came out due to Andy Demetriou's car being stranded in the middle of the circuit. When racing resumed Priaulx and Henderson made contact on lap nine at McIntyres, which put Priaulx into retirement. Each blamed the other for the incident, which was the culminating factor in Menu Motorsport's decision to quit the series (see National News).

Simon Hill's charge was halted by engine failure on lap 11, ending a day of misery for Mardi Gras. Stephen Baber was another one of the many

spinners, but the biggest change to the pattern of the race came on lap 16, when Henderson pulled off and retired. The data logger on the side of his Spider's dashboard had come adrift and was dangling in the footwell. Eventually, one of the unit's wires sheared and caused the ECU to malfunction, which switched off the engine and caused Henderson to coast in to the pits.

A surprised and delighted Hunter took the lead for the last three laps to the chequered flag. 'I was due a



Knockhill's savage kerbs took no prisoners

bit of good luck,' he said. Nick Hart had a lonely race to second, ahead of championship leader Daniel Eaves. Controversy followed after the race, when the stewards said Henderson was to blame for the accident with Priaulx. 'That's totally not the case,' stated Henderson, but the Menu driver was excluded, and

Calvin Lawrence/LAT

Bloxham/LAT



**SNETTERTON** August 16

## Dunn finds form with lights to flag Formula Renault win

Anthony Dunn bounced back to form to win the ninth round of the BARC Formula Renault series at Snetterton on Sunday from the lights. Dunn's victory stemmed the flow of champion elect Nick Dudfield who pressured him but settled for second after losing ground when he slid wide at Sear.

Both were under Dudfield's lap record during qualifying, but come race time it was Dunn who gained the upper hand on the sprint to Riches. Michael Nippers, Elliott Lewis and Paulo Rizzi Isper headed the chasers, but Rizzi Isper lasted only as far as Bomb Hole before crashing out on lap two.

Lewis coasted to a halt with suspected dead electrics at the end of lap two, leaving Nippers to come under attack from Stuart Wood who got past after a tough squabble.

'I was too inconsistent and I made it hard for myself,' admitted Dunn. Dudfield was equally adamant that his 'cardinal sin' had cost him his chance. Meanwhile, the 1700 class fell to a thrilled Martin Watkins who saw off title rival Jeremy Timms.

With Steve Nichols fastest in qualifying for the URS Classic FF2000 round, the outcome was foreseeable. Sure enough, McLaren's employee went on to rack up his fourth successive win, a result that all but wraps up the title. Amnon Needham was second clear of Simon Loynes who took third after place rivals Andy Billing and Anthony Galvin both indulged in separate spins. Colin Wright got to the head of Class B and edged away to win cosily.

Amanda Whitaker was the day's easiest winner, the Durham lass romping away with the Monoposto race. Jim Blockley took second after battling past Francis Phillips and David Cox. Series leader Paul Shipp again wrapped up Class B while Kent-engined honours went to

Jonathan Newman who kept Lee Bennett at bay by 0.12s!

A brace of Formula Ford races completed the action. Mark Jackson running away with the Super Classics. Simon Davey dropped from second to fifth with a sick engine, Enzo Mucci finally wresting the place after a spirited dice with Lee Cunningham.

Irish visitor Stephen Mawhinney 'won' the Classics only to drop to fifth in the results following a surprise penalty. It handed the victory to fellow Irishman James Hagan, who was clear of the tussling Mark Harrison, Nigel Lingwood and Dave Lowe.

● Dud Candler

**BARC FORMULA RENAULT (14 LAPS)** 1 Anthony Dunn (Martini MK72) 16m47.41s (97.65mph); 2 Nick Dudfield (Tatuus RC96) 16m53.15s; 3 Stuart Wood (Tatuus RC96); 4 Michael Nippers (Stryx RT96). **Class winners** Dunn, Martin Watkins (Swift SC94R) 17m40.23s (92.79mph). **Fastest laps** Dunn 1m10.90s (99.11mph) **record**; Lee Fitzpatrick (Swift SC94R) 1m14.01s (94.94mph) **record**.

**CLASSIC FF2000 (12 LAPS)** 1 Steve Nichols (Van Diemen RF82) 14m57.52s (93.95mph); 2 Amnon Needham (Van Diemen RF82) 15m00.57s; 3 Simon Loynes (Van Diemen RF82); 4 Andy Billing (Van Diemen RF82). **Class winners** Nichols, Colin Wright (Reynard SF79) 15m21.60s (91.50mph). **Fastest laps** Nichol 1m13.83s (95.18mph); Eric Hoult (Lola T580) 1m14.93s (93.78mph).

**CLASSIC FF1600 (12 LAPS)** 1 James Hagan (Croselle 32F) 16m02.27s (87.63mph); 2 Mark Harrison (Lola T580) 16m05.86s; 3 Nigel Lingwood (Van Diemen RF80); 4 Dave Lowe (Lotus 61). **Class winners** Hagan, Lowe 16m06.41s (87.25mph). **Fastest laps** Stephen Mawhinney (Croselle 32F) 1m18.87s 89.09mph **record**; Lowe 1m19.18s (89.09mph) **record**.

**SUPER CLASSIC FF1600 (12 LAPS)** 1 Mark Jackson (Swift FB88) 15m45.74s (89.16mph); 2 Enzo Mucci (Reynard FF84) 15m55.10s; 3 Lee Cunningham (Reynard FF84); 4 Tim Scott (Reynard FF89). **Class winners** Jackson, Mucci (88.29mph). **Fastest laps** Jackson 1m16.76s (91.54mph); Cunningham 1m17.30s (90.90mph).

**MONOPOSTOS (12 LAPS)** 1 Amanda Whitaker (Formula Vauxhall Lotus) 14m22.20s (97.80mph); 2 Jim Blockley (Ralt RT3) 14m36.91s; 3 Francis Phillips (Ralt RT3); 4 David Cox (Ralt RT3). **Class winners** Whitaker, Paul Shipp (OMS) 15m03.04s (93.38mph), Jonathan Newman (Lola T644E) 11 laps (88.87mph). **Fastest laps** Whitaker 1m10.46s (99.73mph); Shipp 1m13.79s (95.23mph) **record**; Lee Bennett (Lola T642E) 1m16.71s (91.60mph).

place, despite suffering similar brake problems to her team mate Blair. She added: 'I hope it rains tomorrow.' Her wish came true in spectacular fashion.

Floods of rain swept the circuit as the Vectras lined up on the grid, and unusually, Figueiredo was at the back of it, having missed the requisite qualifying session. But he made a storming start, and gained three places by the first corner, to the detriment of Sears, Suzane and Andrew Golby.

By the end of the first lap pole-sitter Blair had pulled a reasonable margin over Graves with Graham Coomes third. The leading pair were pulling away when Jason Yeomans and Steve Nichol passed Coomes in unison. Once past, Yeomans consolidated his third position and Coomes dropped back into the clutches of Sears, who was driving with increasing gusto. She had been excellent when she

moved past David Pinkney and then set off in pursuit of Chris Boon. Having followed him for several laps, She'd got a better drive out of the hairpin and passed Boon on the straight for fifth.

David Pinkney had also been passed by Figueiredo, and the Stealth Racing driver was eventually to retire on lap 13 with gearbox problems. Out front, Blair and Graves were maintaining their ever-constant gap of about 2s, while Yeomans was charging hard but seemed unable to catch the leading pair. Figueiredo seemed happy enough with fourth. 'It was a good result, especially as it was difficult to see with all the spray,' he said.

Figueiredo's compatriot Suzane was not faring so well in last position. Her situation was not helped by two off-track excursions, from which she recovered. Not so lucky was Golby who pitched his Vectra heavily into the tyre wall at the hairpin on lap 17.

Blair took an untroubled victory, eventually finishing 4s ahead of Graves. After the race Figueiredo was given a 10s penalty for an incident with Mark Nichol, dropping the disgruntled Brazilian to seventh.

**Vauxhall Vectras Race 1 (20 LAPS)** 1 Flavio Figueiredo 20m20.225s (76.70mph) 2 Simon Graves 20m23.980s; 3 Jason Yeomans; 4 Paula Sears; 5 Mark Nichol; 6 Graham Coomes; 7 Chris Boon; 8 Andrew Golby; 9 Suzane. **Fastest lap** Mark Blair 59.878s (78.159mph) **RACE 2** 1 Blair 21m40.992s (71.94mph); 2 Graves 21m44.530s; 3 Yeomans; 4 Sears; 5 Coomes; 6 Nichol; 7 Figueiredo; 8 Boon; 9 Suzane. **Fastest lap** Blair 1m04.213s (72.882mph) **Championship positions after 11 rounds** 1 Blair 116; 2 Graves 109; 3 Figueiredo 101; 4 Pinkney/Yeomans 52; 6 Coomes 49. Next round Brands Hatch Aug 31.



Lawrence/LAT



Jamie Hunter leads David Henderson on Saturday's race, en route to a deserved win

deprived of his fastest lap, which subsequently went to Eaves.

Vercoe won from pole on Sunday, as the wet conditions subdued some of the previous day's wilder antics. Hart got a good start from second on the grid, but was affected by an electrical problem from lap six, which allowed Hunter to slip by him and on to Vercoe's tail. Priaulx was fourth, but an excursion on to the grass during lap two dropped him to ninth. Two laps later he was out, having been forced into the gravel trap at the hairpin following a multi-car skirmish.

The real battle was with the leading quartet, with Eaves passing Hart for third on lap seven while Vercoe and Hunter pulled further away. Masini was also looking strong

in fifth, and by lap 10 was only three car lengths away from Hart. Simon Wiseman was the sole Menu Motorsport representative in sixth, his Spider damaged by contact with Eaves on the first lap. Hunter tried everything he could to get past Vercoe, but had to settle for second.

● Anthony Peacock

**RENAULT SPIDERS RACE 1 (20 LAPS)** 1 Jamie Hunter 22m22.889s (69.70mph); 2 Nick Hart 22m26.216s; 3 Daniel Eaves 22m37.547s; 4 Lee Adams; 5 Simon Wiseman; 6 Ray Macdowall; 7 James Aspinall; 8 Tony Slade. **Fastest lap** Eaves 58.787s (68.94mph) **RACE 2 (17 LAPS)** 1 Duncan Vercoe 18m05.167s (73.31mph); 2 Hunter 18m06.042s; 3 Eaves 18m07.169s; 4 Hart; 5 Tobia Masini; 6 Wiseman; 7 Tony Slade; 8 Aspinall; 9 Stephen Baber. **Fastest lap** Eaves 1m02.860s (74.451mph) **Championship positions after 12 rounds** 1 Eaves 280; 2 Hunter 278; 3 Hart 270; 4 Vercoe 206; 5 Henderson 160; 6 Wiseman 124



McLaren employee Steve Nichols won the Classic FFord 2000 race in his Van Diemen

Richard Styles

Bloxham/LAT





Former McLaren-AUTOSPORT Young Driver Darren Turner won the second Formula Palmer Audi race

# Wilson and Turner's mixed bag

PEMBREY August 15/16

*Justin Wilson and Darren Turner tasted victory and disappointment in Wales, as Paul Lawrence reports*

**J**ustin Wilson and Darren Turner experienced the extremes of emotion as Formula Palmer Audi hit Wales. Each won a race and was knocked out at the first corner of the other, which benefited double podium men Peter Clarke and Richard Tarling in the championship race.

Turner's best time in the first qualifying session became fourth on the grid when the top four were

reversed, and it cost him badly. While Wilson swept into the lead, Turner was involved in a chain reaction shunt and was knocked into a spin by Ian James. Turner's car was beached, his race over.

'It took a while for my car to come in and Peter was pushing me hard,' said Wilson, who was able to gradually extend his lead. 'I just used the boost button to hold the gap,' said Justin after a classy win, his second of the championship.

Clarke was a secure second. 'This is the first weekend we've been right on top of it,' he admitted. Tarling, too, had driven solidly for third after using a maximum boost period on the drag to the first corner. 'I got a good start compared to everyone else and boosted it to get past Turner and Moro,' he said.

Juliano Moro was the first to find a way round Damien Faulkner, who held fourth place early on. Mashed front fins left Faulkner struggling at every corner, however, and his dogged efforts to hold on ensured that a long queue formed in his wake. Felipe Maluhy and Topi Serjala eventually worked ahead of Faulkner, but it was too late to do anything about those up ahead.

Having qualified ninth for race two, Wilson's aim was simply to survive and he knew Hatchets was make or break after the rolling start. Moments later, his worst fears were realised as Maluhy hit him. 'I can't believe it. Felipe came in the side and pushed me into Faulkner,' said Wilson, his title hopes dented.

With carnage at Hatchets and the Esses, the safety car was scrambled for the fourth lap as Turner headed Clarke and Tarling, the only cars to get a clean run through the first corner. Then, two laps into the re-start, Martyn Smith clattered the pit wall and out came the reds.

The re-start was over another 11 laps to give an aggregate result after 17. Clarke grabbed the lead at Woodlands when Turner was slow out of the Esses. 'I had P1 on my board and I knew I just had to stay close to Peter,' said Turner. Clarke tried to get far enough clear for aggregate victory but a vicious slide at Paddock late in the race lost him precious fractions and Turner was three-tenths to the good at the end.

Neil Riddiford took another stride towards the Supersports 200 title with victory, but this was no easy run to the flag. The Nemesis driver suffered a high-speed off in qualifying when a rear pushrod adjuster failed and sent him flying into the boonies at Paddock.

New front bodywork fitted for the race fouled a wheel early on as Mike Swinnerton (Mantis) and Paul Gibson (Nemesis) set the pace. Gibson was on a mission and swept ahead of Swinnerton to lead, but it all went wrong for Gibson when he suffered a repeat of Riddiford's practice problem and his car plunged off the road at Diben. 'I had it won,' he said dejectedly.

Swinnerton retook the lead, but Riddiford was now threatening and dived through into Honda Curve on lap 12. 'Mike's always a tough competitor,' said Riddiford, but once ahead the champion-elect was



BOSS racer Nigel Greensall swapped his Tyrrell F1 car for a BMW M3 and won his race



able to concentrate on securing the extra point for fastest lap.

Swinnerton twice knocked his ignition off when resetting the alarm on the dash. That allowed Stephen Shanly to nip through for second, while Andy Jones and Bill Nickless had a great tussle for fourth.

Though small on numbers, the Dunlop National Saloon turned in a couple of incident-packed races. It all got too much on Saturday when Dave Allan rolled his Honda Civic into Hatchets and squashed the front of Ian Griswold's Integra in the process. From the re-start, Andy Middlehurst romped away with Toni Ruokonen giving chase until a grassy moment at Brooklands left him fighting to regain second from Lester Stacey on the final lap.

On Sunday, Stacey headed the pack until a touch with Middlehurst sent him wide at Brooklands. It was then Middlehurst versus Ruokonen. The Finn got ahead with a bold move at the Esses, and relentless pressure from Middlehurst failed to

his first win.

Nigel Greensall was guesting for Dave Kempton in the BMW Challenge and decimated the field. Jonathan Rowlands gave chase as Peter Challis manhandled his M5 into third. A delighted Mike Gardiner took the Ginetta spoils as John Griffiths slipped to third behind Nigel Woolcott. On Saturday, Graham Cole took an easy victory in the Welsh Sports/Saloons counter.

**FORMULA PALMER AUDI, RACE ONE (15 LAPS)** 1 Justin Wilson 13m48.28s (94.92mph); 2 Peter Clarke 13m50.51s; 3 Richard Tarling; 4 Juliano Moro; 5 Felipe Maluhy; 6 Topi Serjala. **Fastest lap** Moro 54.44s (96.28mph) **record. RACE TWO (17 LAPS)** 1 Darren Turner 20m01.29s (74.17mph); 2 Clarke 20m01.61s; 3 Tarling; 4 Ian James; 5 Justin Keen; 6 Shinya Nakazawa. **Fastest lap** Clarke 54.67s (95.87mph).

**SUPERSPORTS 200 (16 LAPS)** 1 Neil Riddiford (Nemesis RME98) 15m08.42s (92.31mph); 2 Stephen Shanly (Nemesis RME98) 15m12.59s; 3 Mike Swinnerton (Chapman Mantis); 4 Andy Jones (Nemesis RME97); 5 Bill Nickless (Mallock Mk33); 6 Duncan Bain (Nemesis RME98). **Fastest lap** Riddiford 55.645s (94.19mph) **record.**

**RDS AUTOMOTIVE K SPORTS 1600 (6 LAPS)** 1 Tony Richardson (Phantom P94) 6m08.32s (85.38mph); 2 Clive Woodward (Mallock Mk16) 6m08.73s; 3 Alan Palmer (Mallock Mk21/23); 4 Justin Foley (Mallock Mk18); 5 David Smith (Mallock Mk29); 6 Howard Payne (Mallock Mk28). **Fastest lap** Palmer 58.94s (88.92mph).

**DUNLOP NATIONAL SALOON CUP, RACE ONE (15 LAPS)** 1 Andy Middlehurst (Nissan Primera GT) 16m21.19s (80.13mph); 2 Toni Ruokonen (Honda Integra R) 16m29.31s; 3 Lester Stacey (Honda Integra R); 4 Rick Kraemer (Honda Integra R); 5 Barry Barnes (Ford Escort RS2000); no other finishers. **Fastest lap** Middlehurst 1m04.390s (81.40mph). **RACE TWO (20 LAPS)** 1 Ruokonen 21m38.71s (80.71mph); 2 Middlehurst 21m39.04s; 3 Gareth Burnett (Nissan Primera GT); 4 Ian Griswold (Honda Integra R); 5 Kraemer; 6 Stacey. **Fastest lap** Griswold 1m03.729s (82.24mph) **record.**

**AUTOTECNIC BMW CHALLENGE (12 LAPS)** 1 Nigel Greensall (M3) 13m12.08s (79.40mph); 2 Jonathan Rowland (M3) 13m27.28s; 3 Peter Challis (M5); 4 Stephen Tomkins (M3). **Class winners** Greensall; Tomkins 13m47.61s (76.00mph); Peter Seldon (325) 14m19.21s (73.20mph); Simon Hudson (323) 11 laps (71.72mph). **Fastest lap** Greensall 1m04.46s (81.30mph) **record.**

**BRIDGESTONE GINETTA G27s (12 LAPS)** 1 Mike Gardiner 13m42.09s (76.51mph); 2 Nigel Woolcott 13m43.03s; 3 John Griffiths; 4 Angus Brown; 5 Darren Duesbury; 6 Marcus Sharp. **Fastest lap** Gardiner 1m07.315s (77.86mph) **establishes record.**

**BELL SECURITY GUARDING FORMULA SALOONS, RACE ONE (12 LAPS)** 1 Andrew Chester (Pontiac TransAm) 12m10.88s (86.05mph); 2 Richard Wood (Vauxhall Calibra) 12m13.35s; 3 Garry Woodcock (Ford Sierra RS500); 4 Gareth Lloyd (Ford Escort Cosworth). **Class winners** Chester; Simon Dickinson (Vauxhall Cavalier) 12m37.64s (83.01mph). **Fastest lap** Wood 58.81s (89.12mph). **RACE TWO (12 LAPS)** 1 Woodcock 12m17.99s (85.22mph); 2 Chester 12m18.31s; 3 Wood; 4 Alvin Powell (Ford Mondeo). **Class winners** Woodcock; Dickinson 12m48.71s (81.82mph). **Fastest lap** Wood 59.54s (88.03mph).

**WELSH SPORTS/SALOONS (12 LAPS)** 1 Graham Cole (Darrin T90) 12m18.90s (85.12mph); 2 Keith Butcher (Ford Sierra RS500) 13m08.01s; 3 Martin Davies (Ford Sapphire Cosworth); 4 Nigel Jones (Ford Sierra Cosworth). **Class winners** Butcher; Glynne Jones (BMW M3) 11 laps (74.07mph); Mark Chandler (Rover Mini) 11 laps (76.60mph); Cole. **Fastest lap** Cole 1m00.350s (86.85mph).



Toni Ruokonen's Honda was impressive

unseat him. 'Toni didn't make any mistakes,' admitted Middlehurst after a tough encounter.

With Richard Wood scything his Calibra V8 up from the back after transmission traumas in qualifying, Andy Chester claimed the opening Formula Saloon race. Despite a spin, Wood got through to second at the expense of Garry Woodcock. However, Woodcock drove an absolute blinder in the second race to see off all that Chester could throw at him.

'I've never been on the podium before,' said Tony Richardson after a hard-earned RDS K Sports 1600 victory. He kept his head as Clive Woodward and Alan Palmer hounded him, and Justin Foley, Peter Clark and Dave Smith were also in on the action. However, cars went off at Hatchets, and the race was halted, giving Richardson with



Mike Gardiner won the Ginetta race after a strong performance proved his calibre



The Caterham racing was, as usual, a fast and frenzied affair where the best man won

## Clark sneaks thriller

The Caterham Roadsports protagonists were at their scintillating best as David Clark emerged atop a six-car lead battle which was the highlight of an action-packed programme run in aid of local charity.

Poleman Clark took the lead at the lights, but lost out to Thomas Jakobitsch into the Esses. The Austrian led over the line first time round, with Clark close behind, shadowed by Howard Redhouse.

These three ran abreast down Starkeys Straight and were soon joined by Rob Garofall, Alan Finn and Ross Bygrave - every one a possible victor. After much cut-and-thrust, Clark clinched the thriller, from Redhouse and Garofall.

The Superlight race was equally fraught, between polesitter Ben McLoughlin, Edward Horner and Mark Humphrey. Their fun was curtailed when a sideways backmarker was collected by McLoughlin on the main straight. Humphrey took the win from Shaun Balfie and Bart Hayden.

Andy Thompson comfortably won the Tomcat Vento Challenge, in which David Pierce carved his way impressively from a fifth row start to second. Adrian Churchill completed a Rover clean sweep.

The Sports 2000 revival event featured an exciting three-car lead contest between Les Johnson (who led for much of the race), his son Nick and Mike Turner. Top qualifier Nicholas Pearce's Tiga was beaten away by the Shrike trio, with victory going to Johnson junior in only his third car race!

The Anglo-American Challenge and Modified Production Car races were combined, Harvey Cooke claiming overall honours after a scrap with fellow Jaguar E-type pilot Nick Randall.

Richard Connell claimed MG Midget honours following a battle with Richard Wildman, after pole qualifier Graeme Adams failed to start. Paul Rose won a Blue Coral Road Saloon procession from Geoff Bland and Phil Wight, as VW Golf GTis filled the top six.

Mighty Minis ended the day on a spectacular note. Patrick Ford was running away from the swarming pack when a minor, but costly, excursion left him panting in a three-car run to the flag. Marc Norden managed to throw his car into Goddard that bit quicker to snatch it, with Paul Clarke third.

● Matt Carroll

**SPORTS 2000 (15 LAPS)** 1 Nick Johnson (Shrike P15) 19m54.70s (88.45mph); 2 Les Johnson (Shrike P15) 19m56.56s; 3 Mike Turner (Shrike P15); 4 Colin Fayerabend (Lola T90/96). **Class winners** N Johnson; L Johnson; Nicholas Pearce (Tiga SC79); Colin Turner (Royale RP37). **Fastest laps** Glenn Dudley (Lola T87/90), 1m17.78s (90.57mph).

**LOMBARD CATERHAM SUPERLIGHT R CHALLENGE (30 MINS)** 1 Mark Humphrey, 32m 03.82s (91.55mph); 2 Shaun Balfie, 32m08.89s; 3 Bart Hayden; 4 Jason Dance. **Fastest laps** Ben McLoughlin, 1m15.39s (93.45mph); Rupert Douglas-Pennant, 1m19.65s, (88.45mph).

**CATERHAM 1600 ROADSPORT CHALLENGE (10 LAPS)** 1 David Clarke, 13m53.59s (84.51mph); 2 Howard Redhouse, 13m54.44s; 3 Rob Garofall; 4 Thomas Jakobitsch. **Class winners** Clark; Tom Ferrier. **Fastest laps** Ross Bygrave, 1m21.88s, (86.04mph); Ferrier, 1m26.16s, 81.76mph.

**BRSC TOMCAT VENTO CHALLENGE (10 LAPS) - Overall and Rover Tomcats:** 1 Andy Thompson, 14m08.13s (83.06mph); 2 David Pierce, 14m10.75s; 3 Adrian Churchill; 4 John Quartermaine. **Class winners** Thompson; Clinton Ogbourne. **Fastest laps** Thompson, 1m23.86s (84.01mph); Matt Bettley, 1m24.39s (83.48mph).

**AMC ANGLo-AMERICAN CHALLENGE (10 LAPS)** Harvey Cooke (Jaguar E) 14m11.05s (82.78mph); 2 Ralph Avis (Shelby GT350) 14m 18.33s; 3 John Young (Sunbeam Tiger); 4 Tim Boles (Chevrolet Camaro). **Class winners** Anson Howe (MGB); Tommy Entwistle (TVR GT); Cooke. **Fastest lap** Nick Randall (Jaguar E), 1m23.48s (84.39mph).

**MIGHTY MINIS (10 LAPS)** 1 Marc Norden, 17m 07.16s (68.58mph); 2 Patrick Ford, 17m07.53s; 3 Paul Clark; 4 Tony Le May; 5 Bob Bennetts; 6 Stephen King. **Fastest lap** King, 1m40.25s (70.27mph).

**BLUE CORAL ROAD SALOONS (10 LAPS):** 1 Paul Rose (VW Golf GTI), 15m12.06s (77.24mph); 2 Geoff Bland (VW Golf GTI) 15m21.86s; 3 Phil Wight (VW Golf GTI); 4 Paul Connell (VW Golf GTI). **Class winners** Bland; Rose. **Fastest laps** Bland, 1m30.24s, 78.07mph; Rose, 1m30.72s (77.65mph).

**HALFORDS MG MIDGET CHALLENGE (10 LAPS)** 1 Richard Connell, 14m01.94s (83.67mph); 2 Richard Wildman, 14m02.10s (83.66mph); 3 Peter May; 4 David Brooker-Carey. **Class winners** Connell; Peter Tipper; Bill Lancashire. **Fastest lap** May, 1m22.36s (85.54mph).

**BARC/RSCC MODPROD SALOONS (10 LAPS)** 1 John Warren (Ford Capri) 14m26.68s (81.28mph); 2 Phil Seaman (Talbot Sunbeam Lotus) 14m29.60s; 3 Scott Austin (Ford Escort RS2000); 4 Nick Williamson (Rover 220C); 5 Tony Dolley (Vauxhall Corsa); 6 Colin Stott (Ford Capri). **Class winners** Warren; Seaman; Austin; Dolley; Cheryl Quantrell (Ford Fiesta). **Fastest lap** Warren, 1m24.86s (83.02mph).







CROFT August 15/16

# Tuscan wins brighten Campbell-Walter's day

The TVR Tuscan started on a wet track that was drying, but Jamie Campbell-Walter made the most of the conditions to take easy victories. By Peter Scherer

**J**amie Campbell-Walter overcame the best the British summer could throw at him, by winning the TVR Tuscan race, but the early qualifier too.

A first-corner collision put Colin Blower, Grant Tromans, Ashley Ward and Steve Cole out of the qualifier, while Campbell-Walter led the way from Ian Flux. A couple of exchanges followed, before JCW took control from Tower on lap seven, leaving Flux to defend second from Steve Sutcliffe.

As the field assembled for the championship race, the track was drying. Poleman Martin Short dived pitwards for slicks, along with Ian McKellar and David Hutchinson.

In Short's absence it was championship leader Bobby Verdon-Roe leading Phil Hindley, Gavin Cooper and Michael Caine into Clervaux, with Campbell-Walter and Flux next up.

Hindley and Verdon-Roe put daylight between themselves and third-placed Cooper, then changed places into Sunny on the third lap, while Caine set his sights on third.

Further down the order, Sutcliffe's pressure on Troy Dunlop for eighth, led to a spin across the Complex kerbing. He dropped to 11th, and took Mark Preston with him. As Hindley again showed signs of opening up his lead, Campbell-Walter squeezed inside Caine for fourth on lap five.

A lap later Campbell-Walter found himself promoted to second as Cooper and BVR clashed.

Verdon-Roe was now fourth, with Caine, Flux, Dunlop and Hood all forming up behind.

As the wet tyres began to go off, Campbell-Walter reeled in Hindley and had the lead out of Clervaux on lap eight. Verdon-Roe, having dropped behind Caine and Flux a lap earlier, regained fourth when Caine ran off and scattered gravel,



Jamie Campbell-Walter's Tuscan won both the qualification race and the main event

which put Flux into retirement.

Campbell-Walter then eased away to take his second win of the day.

Hindley and Cooper retained their podium places, with Verdon-Roe satisfied in fourth. Caine held on to fifth and Hood ousted Dunlop for sixth with a lap to go. Steve Hyde and Rod Gretton were eighth and ninth, while slick-shod McKellar and Short took 10th and 12th.

The PDS Colourprint Saloon and Sports were split into two races, with Jeff Wilson's Osella taking the first for Class A,B,C & E. Tony Sugden's Skoda was second and Michael Blomfield's Sierra was third. Eike Wellhausen's Lister Knobbly had no serious challengers in the Class D,F & G race.

The first of the double-headers saw Paul Buckley's 75 take the Chris Knott Insurance Alfa Romeo Class A-D victory on a sunny Saturday. On the wet Sunday Bryan Shrubbs' 33Ti was in a class of his own. Enzo Buscaglia held second.

Stephen Stokoe collected a comfortable Proton Coupe win, while Robert Ross pipped Paul Forster for second at the flag.

The first of the Porsche 924 races saw Keith Penman's hopes dashed when he was forced out with a blown headgasket. Jonathan Mann took the win, with Tony Brown

beating Brian El-Buka to second.

Mann was straight into the lead of race two, but a spin at the chicane dropped him to seventh and gave Brown and Penman a break. Mark McAleer joined the battle and found himself in second behind Penman a lap later after Brown retired.

Penman went on to win after McAleer had a couple of spins. Mann's recovery brought him back to second, with Dave Manners just heading El-Buka for third.

Adie Hawkins' Sud won a pair of bruising Class E&F Alfa Romeo encounters, while Ray Mears' 33 was second on both occasions too.

Reigning Formula 600 Champion James Pickford has a challenger at last, even if he did keep his 100% record with a double victory. In race one Stefan Hodgetts won the battle for the initial lead, but Pickford forced him wide on to the kerbs out of Sunny on the second lap to go ahead into the Complex. The battle was beginning to grow when the leaders encountered backmarkers. Pickford became boxed in and Hodgetts took the lead on the penultimate lap, only to spin at Sunny. Anthony Nicklin and Jan Prowse took second and third respectively.

A new winner looked to be on the cards in race two after Pickford spun out of the lead at the chicane on the opening lap, leaving Nicklin to head Chris Ellis, Hodgetts and the recovering Pickford. However, Hodgetts lost his gears on lap three, and within a lap Pickford had grabbed the lead back again. Nicklin fought off Ellis to take second again.

An early four-car break in the Unipart DCM Mini Miglia provided masses of action. Steve Bell, James Hayman, Matt Hayman and Tim Sims circulated in close formation, until James H. got around Bell through Tower on the fifth lap. Once Dave Percival joined in the fun, the pace was even hotter. He

took Sims at Clervaux and Matt H. at the Hairpin to hold third on lap seven. The leader nearly threw it away exiting the Complex, but held on. The last-lap scramble saw Bell and Percival collide to make it a Hayman one-two, with Sims sneaking back into third.

Ian Curley sealed the Mini Miglia championship with yet another victory. He headed home Julian Sole and the early leader of the race, Chris Lewis.

**TVR TUSCAN CHALLENGE (12 LAPS)** 1 Jamie Campbell-Walter 19m08.190s (67.72mph); 2 Phil Hindley 19m10.200s; 3 Gavin Cooper; 4 Bobby Verdon-Roe; 5 Michael Caine; 6 Tim Hood. **Fastest lap** Short 1m31.22s (71.04mph). **QUALIFICATION RACE (12 LAPS)** 1 Campbell-Walter 17m42.560s (73.18mph); 2 Ian Flux 17m45.020s; 3 Steve Sutcliffe; 4 Troy Dunlop; 5 Mark Preston 6 Hood. **Fastest lap** Campbell-Walter 1m23.79s (77.34mph). **Championship positions** 1 Verdon-Roe 546 points; 2 Hindley 488; 3 McKellar 459; 4 Cooper 440; 5 Short 427; 6 Campbell-Walter 411 etc.

**SALOON AND SPORTSCARS, CLASSES A,B,C&E (10 LAPS)** 1 Jeff Wilson (Osella PA7) 14m53.000s (72.56mph); 2 Tony Sugden (Skoda 130RS) 14m54.460s; 3 Michael Blomfield (Ford Sierra RS500); 4 Chris Maries (Westfield) Class winners Wilson; Ron Harper (Triumph Spitfire); Colin Blair (Ford Escort Cosworth); Maries. **Fastest laps** Wilson 1m22.87s (78.19mph) record; Harper 1m33.12s (69.59mph); Blair 1m35.54s (67.82mph); Maries 1m31.30s (70.97mph) record. **CLASSES D,F&G (10 LAPS)** 1 Eike Wellhausen (Jaguar Knobbly) 16m21.000s (66.06mph); 2 Simon Baker (Ford Fiesta) 17m33.330s; 3 John Pringle (Lotus Seven); 4 Paul Lavelle (Ford Fiesta XR2). **Class winners** Baker; Pringle; Wellhausen. **Fastest laps** Baker 1m43.47s (62.63mph); Richard Butterfield (Sylvia Striker) 1m40.38s (64.55mph); Wellhausen 1m36.24s (67.33mph) record.

**CHRIS KNOTT ALFA ROMEOs, CLASSES A-D, RACE ONE (8 LAPS)** 1 Paul Buckley (75) 13m04.880s (66.05mph); 2 David Thomas (Sud) 13m09.650s; 3 Graham Presley (75); 4 Alan Marshall (75). **Class winners** Buckley; Thomas; Andrew Kingerlee (33); Enzo Buscaglia (75). **Fastest laps** Buckley 1m36.70s (67.01mph) record; Thomas 1m37.08s (66.75mph) record; Dave Walker (Sud Ti) 1m42.25s (63.37mph); Buscaglia 1m42.68s (63.11mph) record. **RACE TWO (8 LAPS)** 1 Bryan Shrubbs (33Ti) 12m03.260s (53.82 mph); 2 Buscaglia 16m07.830s; 3 Thomas; 4 Dave Streater (Arna Ti). **Class winners** Marshall; Shrubbs; Streater; Buscaglia. **Fastest laps** Buckley 2m03.41s (52.51 mph); Shrubbs 1m55.37s (56.17 mph); Streater 1m58.34s (54.76 mph); Buscaglia 1m55.83s (55.94 mph). **CLASSES E&F, RACE ONE (8 LAPS)** 1 Adie Hawkins (Sud) 14m00.280s (61.69mph); 2 Ray Mears (33) 14m14.870s; 3 Simon Frost (33); 4 Paul Edwards (Sud). **Class winners** Steve Foley (75); Hawkins. **Fastest laps** Foley 1m46.95s (60.59 mph); Mears 1m43.56s (62.57 mph). **RACE TWO (8 LAPS)** 1 Hawkins 13m56.210s (61.99 mph); 2 Mears 13m59.060s; 3 Edwards; 4 Graham Heels (33). **Class winners** Foley; Hawkins. **Fastest laps** Foley 1m48.36s (59.80 mph); Hawkins 1m42.98s (62.92 mph) record.

**PROTON COUPES (10 LAPS)** 1 Stephen Stokoe 16m50.320s (64.14 mph); 2 Robert Ross 16m55.280s; 3 Paul Forster; 4 Ray Byford; 5 Gary Fletcher; 6 Richard Cuene-Grandidier. **Fastest lap** Stokoe 1m40.04s (64.77 mph) record.

**PORSCHE 924, RACE ONE (8 LAPS)** 1 Jonathan Mann 14m13.890s (60.71 mph); 2 Tony Brown 14m16.040s; 3 Brian El-Buka; 4 Mark McAleer; 5 Scott Weston; 6 Alan Everitt. **Fastest lap** Mann 1m45.26s (61.56 mph). **RACE TWO (8 LAPS)** 1 Keith Penman 16m45.410s (51.56 mph); 2 Mann 16m53.140s; 3 Dave Manners; 4 El-Buka; 5 Weston; 6 William Black. **Fastest lap** El-Buka 2m01.72s (53.24 mph).

**FORMULA 600, RACE ONE (8 LAPS)** 1 James Pickford 11m37.440s (74.33 mph); 2 Anthony Nicklin 11m45.010s; 3 Jan Prowse; 4 Chris Ellis; 5 Danny Reeves; 6 Harry Handkammer. **Fastest lap** Stefan Hodgetts 1m25.45s (75.83 mph) record. **RACE TWO (8 LAPS)** 1 Pickford 13m43.500s (62.95 mph); 2 Nicklin 14m00.440s; 3 Ellis; 4 Handkammer; 5 Dillon Battistini; 6 Andy Sayle. **Fastest lap** Pickford 1m39.90s (64.86 mph).

**MINI SE7EN CHALLENGE (10 LAPS)** 1 James Hayman 17m58.920s (60.06 mph); 2 Matt Hayman 17m59.600s; 3 Tim Sims; 4 Steve Bell; 5 Dick Hunter; 6 Dave Banwell. **Fastest lap** Dave Percival 1m45.52s (61.41 mph).

**MINI MIGLIA CHALLENGE (10 LAPS)** 1 Ian Curley 16m44.060s (64.54 mph); 2 Julian Sole 16m45.220s; 3 Chris Lewis; 4 Peter Baldwin; 5 Phil Manser; 6 Jonathan Lloyd. **Fastest lap** Lewis 1m37.14s (66.71 mph).



Tony Sugden's modified Skoda 130RS is seen here in front of Jeff Wilson's Osella PA7



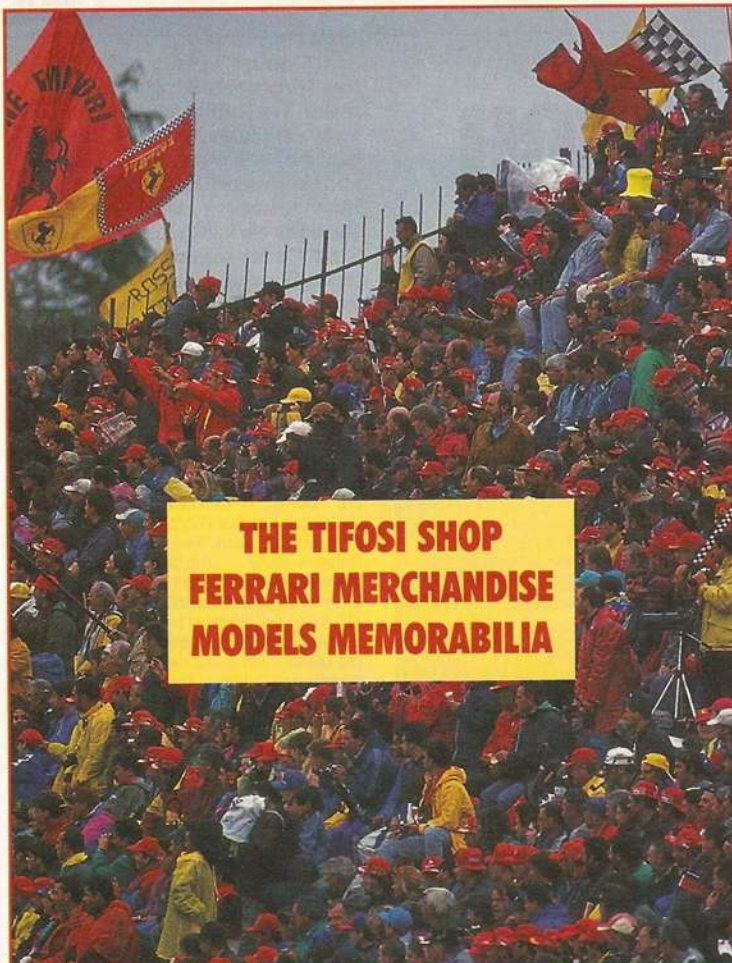

**THE TIFOSI SHOP  
FERRARI MERCHANDISE  
MODELS MEMORABILIA**

MAIL ORDER: (0)1895 819300 FAX: (0)1895 819333 E-MAIL: hallifax@ctc-mundo.net  
WILLOWBANK HOUSE, OXFORD ROAD, UXBRIDGE, MIDDLESEX, UB8 1LU.  
SHOP: TALACREST LIMITED, 74 STATION ROAD, EGHAM, SURREY, TW20 9LF, U.K.

## Del West Is on the Move

Del West Engineering has relocated it's U.S. headquarters operation. We haven't moved far, just a couple of exits up the freeway north of Los Angeles, which means only our address has changed. We even have the same postal code, and our phone and fax numbers also remain the same. Our European offices, in Aigle, Switzerland, are right where they've always been.



### Del West Engineering, Inc.

**Lightweight Valvetrain Component Design and Manufacture**

**U.S. Headquarters**

**Del West Engineering**

**(New Address)**

28128 West Livingston  
Valencia, CA 91355 U.S.A.

**(No Changes)**

**Telephone: 805-295-5700**

**Fax: 805-295-8300**

**European Offices**

**Del West S.A.**

**(No Changes)**

Chemin de Marjolin 75-77  
C.P. 358, 1860 Aigle CH

**(No Changes)**

**Telephone: 02-44-66-96-36**

**Fax: 02-44-66-96-38**

**CONGRATULATIONS TO DAVID GRACE  
1998 BRITISH HILLCLIMB CHAMPION**  
(not forgetting Ian Daysons sterling efforts!)

**GOULD**

**GOULD ENGINEERING SERVICES**

01635 44466 (T)

01635 30056 (F)



**ENGINES SUPPLIED BY**

**AVON  
TYRES**

**BMTR**

**BLMT**

Composite Design and Manufacture  
Suppliers of carbon composite wings  
to Gould Engineering  
Tel/Fax: 0044 (0)1703 894909  
Email: 100517.115@compuserv.com



**LANGFORD PERFORMANCE  
ENGINEERING**  
01933 441661 (T)  
01933 441549 (F)

**HEWLAND**  
MOTORSPORT TRANSMISSIONS



CADWELL August 16

# Cadwell cliffhanger

Martin Stewart grabbed a last-lap win in a thrilling Caterham race. By Tim Baggs

**M**artin Stewart and Jon Milicevic staged another Caterham cliffhanger on Sunday. Stewart snatched a late victory by just 0.24s to consolidate his championship lead.

A move by Matthew Marsh at Mansfield, on lap three, briefly delayed Stewart's pursuit of Milicevic, who then foiled two successive slipstreaming attempts by his rival along Park Straight. With three laps to go, Stewart half spun at the hairpin, allowing Marsh back to second, but they swapped positions again at Park corner. Less than one lap from home, Stewart's tighter line round the hairpin finally breached Milicevic's defences.

Driving a different Caterham, Marsh won an earlier duel with Peter Haynes. The former led from the lights, but was passed by Haynes at Park on lap four, only to be dislodged by Marsh in a clinical overtaking move at the hairpin.

Mick Hyde looked set for victory in the Clubsports 2000 race until his Radical's engine expired three laps from the finish, leaving Andrew Darby to coast home ahead of the Radical of Phil Abbott and Richard Gilmour's Mallock.

Rod Delves won the first two 750 Trophy races in his Kieft after



Phil Abbot's beautifully turned-out Radical finished second in the Clubsports race

trading the lead with Roger Windley and seeing Roy Hunt's challenge end in retirement at Coppice on the penultimate lap. Richard Reeve's Lotus beat Delves into second in race two.

Stock Hatch victories went to the Peugeot 205 GTis of Peter Featherstone and Paul Sheehan. Fellow Peugeot pilot Andrew Varey won the Hot Hatch race, with a bold move on Steve Taylor's XR2 at Park corner, with two laps to go.

Jonathan White won the Kit Car race from Steve Owen after early leader Mike Topp went off. Darvi driver Tim Cousins took the 750 Formula event from Peter Bove.

Mark Walklett's Ginetta won the Roadsports event. Philip Gladman's Lotus Elise Sport was second.

**750 TROPHY RACE ONE (10 LAPS)** 1 Rod Delves (Kieft) 14m02.45s (63.07mph); 2 Roger Windley (Genie) 14m17.64s; 3 Roger Rowe (RWR). **Class winners** Delves; Windley; Ringrose; Dave Locock (D&S Special); Graham Chambers (A7 Ulster). **Fastest laps** Roy Hunt (Martin) 1m22.67s (64.27mph); Windley 1m23.46s (63.67mph); Ringrose 1m29.56s (59.33mph); Locock 1m30.72s (58.57mph); Chambers 1m33.17s (57.03mph).

**RACE TWO (10 LAPS)** 1 Richard Reeve (Lotus Mk6) 14m09.73s (62.53mph); 2 Delves 14m20.35s; 3 Rowe. **Class winners** Reeve; Delves; Locock; David Whetton (A7 Special). **Fastest laps** Reeve 1m22.40s (64.49mph); Delves 1m23.96s (63.29mph); Locock 1m29.71s (59.23mph); Whetton 1m38.50s (53.95mph).

**HOT HATCHES (8 LAPS)** 1 Andrew Varey (Peugeot 205 GT) 10m13.64s (69.27mph); 2 Carl Lawrence (Vauxhall Nova GTE) 10m15.33s; 3 Steve Taylor (Fiesta XR2). **Class**

**winners** Varey; Mark Bush (Rover Metro GT). **Fastest laps** Taylor 1m16.37s (69.58mph); Stephen Polley (Toyota Starlet) 1m18.99s (67.27mph) **record**.

**CLUBSPORTS 2000 (12 LAPS)** 1 Andrew Darby (AJD Clubsport) 13m02.22s (81.52mph); 2 Phil Abbott (Radical Clubsports) 13m10.22s; 3 Richard Gilmour (Mallock U2 18/25); 4 Doug Newman (Radical Clubsports). **Class winners** Darby; Abbott. **Fastest laps** Mick Hyde (Radical Clubsports) 1m04.55s (82.32mph); Darby 1m04.93s (81.84mph).

**LOTUS 7 CLUB 7 CLASSES C&D (12 LAPS)** 1 Matthew Marsh (Caterham 7 Supersport) 14m32.67s (73.07mph); 2 Peter Haynes (Caterham 7 Supersport) 14m34.08s; 3 Neil Turner (Caterham 7 Supersport). **Class winners** Marsh; James Harvey (Caterham 7 Classic). **Fastest laps** Haynes 1m11.98s (73.82mph) **record**; Harvey 1m14.20s (71.61mph) **record**.

**CLASSES A&B (12 LAPS)** 1 Martin Stewart (Caterham Super 7) 13m39.36s (77.82mph); 2 Jon Milicevic (Caterham Super 7) 13m39.60s; 3 Marsh (Caterham Vauxhall). **Class winners** Stewart; Barry Ely (Lotus 7 S2). **Fastest laps** Stewart 1m07.65s (78.55mph) **record**; Ely 1m10.35s (75.53mph) **record**.

**KIT CARS (12 LAPS)** 1 Jonathan White (Sylva Striker) 14m25.61s (73.66mph); 2 Steve Owen (Sylva Clubman) 14m27.76s; 3 Andrew Owen (Sylva Phoenix). **Class winners** White; Andrew Owen. **Fastest laps** White 1m10.16mph (75.74mph) **record**; Hudson 1m11.21s (74.62mph) **record**.

**STOCK HATCHES RACE ONE (12 LAPS)** 1 Peter Featherstone (Peugeot 205 GT) 15m54.90s (66.77mph); 2 Rob Carvell (Peugeot 205 GT) 15m57.92s; 3 Steve Powlesland (Peugeot 205 GT). **Fastest lap** Featherstone 1m19.09s (67.18mph) **record**. **RACE TWO (12 LAPS)** 1 Paul Sheehan (Peugeot 205 GT) 16m25.88s (64.68mph); 2 Chris Lester (Fiesta XR2) 16m35.25s; 3 Leslie Ott (Fiesta XR2). **Fastest lap** Sheehan 1m21.93s (64.86mph).

**750 FORMULA (12 LAPS)** 1 Tim Cousins (Darvi Mk5) 14m21.83s (73.99mph); 2 Peter Bove (Darvi 88/P) 14m23.47s; 3 Bob Simpson (SS Reliant). **Class winners** Cousins; Manuel Hughes (Gallard J2). **Fastest laps** Pete Kriple (DNC) 1m10.56s (75.31mph); Hughes 1m12.51s (73.28mph).

**ROADSPORTS (12 LAPS)** 1 Mark Walklett (Ginetta G4) 14m13.72s (74.69mph); 2 Philip Gladman (Lotus Elise Sport) 14m19.23s; 3 Geoff Evison (Lotus Elise Sport). **Class winners** Walklett; Gladman; Coles; Kevin Ginger (Triumph Spitfire); Richard Daw (Sylva Phoenix); Christopher Varey (Porsche 924). **Fastest laps** Walklett 1m10.22s (75.67mph) **record**; Gladman 1m10.27s (75.62mph) **record**; John Dunham (Westfield 7) 1m13.73s (72.07mph); Ginger 1m14.23s (71.58mph); Daw 1m16.78s (69.21mph); Varey 1m24.87s (62.61mph) **record**.

PHOENIX PARK August 15/16

# Hat trick for O'Connor

**E**d O'Connor took three victories in his Renault Clio Williams at the annual two-day Phoenix Park Motor Races.

There were 20 races, with O'Connor notching up his first win in the combined Dunlop Touring Car event to beat Gordon Kellett, having taken his Fiat Punto to third behind Mark Turley and Kellett in the race before. He then won the Saloon Car Challenge from Turley and Rod McGovern.

The Dunlop Italian Saloon Cars were running with the Strykers. Turley won the first and Joey Freeburn the second. John Whelan claimed the first Stryker part of the race, and Bruce Allison the second.

Edmund Cassidy held off Bertie Carruthers in the Sign Factory Historics, but the Cesco Handicap event gave Jim O'Reilly the win from Carruthers.

Martin Stretton headed the grid of visiting Frazer Nashs to finish both races ahead of Jon Giles and Peter Cobb.

Barry Foster took the honours in the Pre-War Racing & Sports Cars from Patrick McMillen, while Cobb won the second from Bill Roberts.

Two attempts to run the first Formula Vee race were finally aborted, although Brian Hearty had dominated both times. Paul Heavey

and Pauraic Owens showed the rest the way home in the next two races, and once Heavey had fallen by the wayside, Hearty had an easy run home in the final, over 14 seconds clear of Brian Melia.

Philip Kehoe took a double Formula Ford victory, the first ahead of Derek Daly. However, with the Cross Sportscars also running, Arnie Black was third in the first race and second next time out.

Leo Nulty won his first Park race in the first Fiat Ritmo encounter from Enda Cassidy, the latter going one better on Sunday to win.

Clive Pratt held off Mervyn Miller in both Fiat Uno races, Turley taking third in Saturday's race and Gill Austen finishing third on Sunday.

● Linda Keen

**STRYKER SPORTSCARS (5 LAPS)** 1 John Whelan 7m 1.00s (73.96mph); 2 Des Brnton 7m 3.90; 3 Michael Coyne. **Fastest lap** Whelan 1m 19.99s (77.86mph). **RACE 2 (8 LAPS)** 1 Bruce Allison (10m58.52s (75.66mph)); 2 Andrew Dalton 11m 7.50s; 3 Pat Murphy. **Fastest lap** Whelan 1m 18.96s (78.88mph) **record**.

**ITALIAN SALOON CAR RACE (5 LAPS)** 1 Mark Turley (Fiat Punto) 9m14.07s (56.20mph); 2 Gordon Kellett (Fiat Punto) 9s 14.77s; 3 Ed O'Connor (Fiat Punto). **Fastest lap** O'Brien 1m 25.69s (72.68mph).

**DUNLOP TOURING CAR CHAMPIONSHIP (8 LAPS)** 1 Ed O'Connor (Renault Clio Williams) 10m 37.83s (78.11mph); 2 Gordon Kellett (Opel Astra) 10m 39.15s; 3 Mark Turley (Honda Civic Vtec). **Fastest lap** O'Connor 1m 17.72s (80.13mph).

**RACE 2 (8 LAPS)** 1 Ed O'Connor (Renault Clio Williams) 10m34.85s (78.48mph); 2 Mark Turley (Honda Civic Vtec) 10m 36.42s; 3 Gordon Kellett (Opel Astra). **Fastest lap** O'Connor 1m



The Phoenix Park races provided a wide variety of racing, both historic and modern

17.92s (79.93mph). **HISTORIC CARS (8 LAPS)** 1 Edmund Cassidy (Sunbeam Tiger) 10m 40.73s (77.60mph); 2 Bertie Carruthers (Porsche 911); 3 Lloyd Hutchinson (Mini Cooper 'S'). **Fastest lap** Cassidy 1m 18.23s (79.61mph).

**FRAZER NASH RACE (8 LAPS)** 1 Martin Stretton (BMW Type 328) 12m 58.65s (63.99mph); 2 Jon Giles (Beetle) 13m .57s; 3 Peter Cobb (Boulogne Vitesse). **Fastest lap** Stretton 1m 33.03s (66.96mph). **RACE 2 (6 LAPS)** 1 Martin Stretton (BMW Type 328) 9m 47.40s (63.62mph); 2 Jon Giles (Beetle) 9m 47.74s; 3 Peter Cobb (Boulogne Vitesse). **Fastest lap** Stretton 1m 32.04s (67.67mph).

**FIAT UNO CUP RACE (8 LAPS)** 1 Clive Pratt 11m 51.14s (70.06mph); 2 Mervyn Miller 11m 53.56s; 3 Greg Turley. **Fastest lap** Miller 1m 26.92s (71.65mph). **RACE 2 (8 LAPS)** 1 Clive Pratt 11m 50.79s (70.10mph); 2 Mervyn Miller 11m 53.63s; 3 Gillian Austen. **Fastest lap** Miller 1m 26.98s (71.60mph).

**PRE WAR RACING & SPORTS CAR RACE (8 LAPS)** 1 Barry Foster (MG Montlhery) 13m 52.60s (59.84mph); 2 Patrick McMillen (Aston Martin Le Mans) 14m32.76s; 3 Michael Hudson (Bugatti T13 Brescia). **Fastest lap** Foster 1m 41.56s (61.32mph). **RACE 2 (8 LAPS)** 1 Peter Cobb (Boulogne Vitesse) 13m 25.12s (61.88mph); 2 Bill Roberts (TT Replica) 13m 35.64s; 3 Tim Pryke (Shelsley/Mark Walker (Thunderbug). **Fastest lap** Cobb 1m 36.78s (64.35mph).

**FORMULA VEE (8 LAPS)** 1 Paul Heavey (Leastone) 10m 58.66s (75.64mph); 2 Ray Moore (Leastone) 11m 5.09s; 3 Dominic Dillon (Sheane PV93). **Fastest lap** Moore 1m 20.01s (77.84mph).

**RACE 2 (8 LAPS)** 1 Pauraic Owens (Leastone) 11m 8.20s

(74.56mph); 2 Gerry O'Reilly (Sheane) 11m 16.48s; 3 Brinsley Matthews (Sheane). **Fastest lap** Owens 1m 20.63s (77.24mph). **FINAL (8 LAPS)** 1 Brian Hearty (Sheane) 10m45.01s (77.25mph); 2 Brian Melia (Sheane 91) 10m 59.71s; 3 Frank Byrnes (Sheane 95). **Fastest lap** Melia 1m 19.55s (78.29mph).

**FIAT RITMO (5 LAPS)** 1 Leo Nulty 7m 55.39s (65.50mph); 2 Enda Cassidy 7m 57.49s; 3 Glen Cully. **Fastest lap** Nulty 1m 32.13s (67.60mph). **RACE 2 (8 LAPS)** 1 Enda Cassidy 12m 19.55s (67.37mph); 2 Alan Byrne 12m 24.63s; 3 Glen Cully. **Fastest lap** Cully 1m 31.12s (68.35mph).

**FORMULA FORD/CROSSE SPORTSCARS (8 LAPS)** 1 Philip Kehoe (Van Diemen RF98) 9m 21.98s (88.66mph); 2 Derek Daly (Mygale SJ97) 9m 25.85mph; 3 Arnie Black (Crosle 9S). **Fastest lap** Kehoe 1m 8.42s (91.03mph) **record**; Black 1m 6.73s (93.33mph). **RACE 2 (8 LAPS)** 1 Philip Kehoe (Van Diemen RF98) 9m 18.85s (89.15mph); 2 Arnie Black (Crosle 9S) 9m 26.24s; 3 Ronnie Maybin (Crosle 9S). **Fastest laps** Kehoe 1m 8.41s (91.04mph) **record**; Black 1m 7.30s (92.54mph).

**DUNLOP ITALIAN SALOON CAR RACE (8 LAPS)** 1 Joey Freeburn (Fiat Punto) 11m 50.73s (70.10mph); 2 David Kidd (Fiat Punto) 11m 51.29s; 3 Gordon Kellett (Fiat Punto). **Fastest lap** Freeburn & Kellett 1m 24.84s (73.41mph).

**CESCO HISTORIC CAR HANDICAP (8 LAPS)** 1 Jim O'Reilly (Crosle 91) 10m32.00s; 2 Bertie Carruthers (Porsche 911) 10m33.80s; 3 Alan Kessie (MG Midget).

**SALOON CAR CHALLENGE (8 LAPS)** 1 Ed O'Connor (Renault Clio Williams) 10m 51.15s (76.52mph); 2 Mark Turley (Honda Civic Vtec) 10m 54.73s; 3 Rod McGovern (Peugeot 205). **Fastest lap** O'Connor 1m 16.84s (81.05mph).



# ON SALE AUGUST 21

THE WORLD'S BEST-SELLING FORMULA 1 MAGAZINE

F1 RACING  
SEPTEMBER 1998

# F1

## RACING

SEPTEMBER 1998 £3.00

www.itv-f1.com

# Mika v Michael

How Schuey can take it to the wire

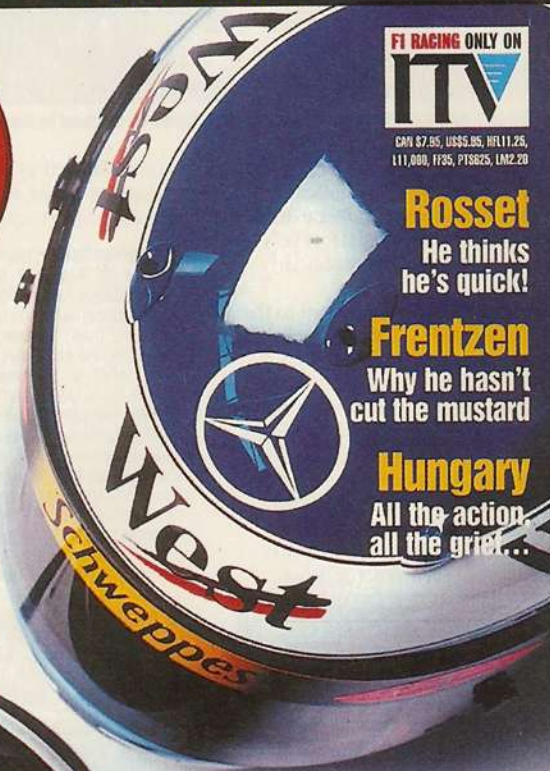

F1 RACING ONLY ON  
**ITV**

DAY £7.95, US\$5.95, HK\$11.25,  
L11,000, ¥135, P15825, LNZ 20

**Rosset**  
He thinks he's quick!

**Frentzen**  
Why he hasn't cut the mustard

**Hungary**  
All the action, all the grief...

**PLUS**

**JACQUES VILLENEUVE**  
Meet his new all-star team

**JIM CLARK**  
New clues to his mystery accident



**WORLD EXCLUSIVE!**

Ferrari's latest trick See page 24



MIKA V MICHAEL

## BAR

Craig Pollock talks about the prospects of his new kids on the grid.

## Jim Clark

For the very first time, a witness to the accident that killed Jim Clark speaks exclusively to F1 Racing.

## Ricardo Rosset

Ricardo took time out to have a cuppa with us and give us his own account of his season so far with Tyrrell.

## The F1 Swedes

We go back to 1978 and take in the year that F1 lost two of Swedens best - Ronnie Peterson and Gunnar Nilsson

[www.itv-f1.com](http://www.itv-f1.com)

# F1

RACING

Available from your newsagent,  
price £3.00



SHELSLEY WALSH August 16

# Moran shades Grace

Roger Moran bagged victory for Pilbeam as newly-crowned champion David Grace bounced back from a 120mph practice crash. Jerry Sturman was there

**W**ith his RAC crown lost to David Grace, Roger Moran hurtled back in his revised Pilbeam MP72 to score his fourth Auto Windscreens victory. 'I had to lift at Kennel with a touch of understeer,' he said, 'but I'm much happier with its handling.'

Undaunted by a 120mph shunt in practice (see *National News*), Grace kept the pressure up to trail Moran by 0.06s in the Gould-Ralt.

Top qualifier Roy Lane bottomed out there too, on his first run-off shot. The silver Pilbeam skated into Bottom Ess on three wheels, with a suspension rocker broken, and spun. Lane lost his Avon BMTR series lead to Moran, but at least kept LTD.

Sparks cascading from his Gould's skidblocks, Rob Turnbull bounced to third place, having led Grace by 0.02s at the break. Tim Mason brought his rebuilt Pilbeam-Judd in fourth, but Simon Durling had to push hard to beat Bill Bristow.

Right foot nailed as the four-pot Ralt slewed through Crossing, Bristow's fine sixth was his best Shelsley result. Richard Fry survived a last run charge by Tony Marsh as

they completed a quartet of scorers for the Gould marque. Sixth at the break, Malcolm Orme slumped to 10th after Deryk Young retired their Pilbeam with transmission failure.

Carving almost a second off Simon Rutland's 2-litre ModProd record, Trevor Willis strengthened his Midland title bid with the road-tyred Westfield. The slickshod Clive Kenrick overcame gearbox dramas to oust Tom New, who slipped to third in the Leaders race.

Morgan man Mike Hall mopped up an unlimited class which saw Lloyd Evans's bulky Spectre come off worse in an argument with the Crossing Bend tyre barrier. In the racing division, Richard Jones's Porsche turbo had the legs of Roy Standley's record-holding SEight.

Forced to bolt on new tyres with Alan Thompson back in the fray, Martin Groves held off his Clubmans adversary to stay atop the Leaders and Midland tables. Russ Pickering ran sub-30 in the sports libre Vision to beat the resurgent Roger Thomas.

Although Andy Smith slipped his blown Vision past Tom Hammonds's spectacular Quattro in the big division, Christian Mineeff's wailing SPA-Judd remained in charge.

Amid frantic single-seater action, Graeme Wight Jr upended his 1600cc Pilbeam in the Esses with the class - and top spot in the Leaders table shared with Groves - in the bag. And Willem Toet, with the two-litre class sewn up, bounced the works MP82 off the bank.

**AUTO WINDSCREENS RAC BRITISH HILLCLIMB CHAMPIONSHIP, ROUND 13.** **BTD** Roy Lane (4.0 Pilbeam-Judd/J&F EV MP58-9), 26.22s. **Run-Off 1** Roger Moran (4.0 Pilbeam-Judd/J&F EV MP72-3), 26.45s; 2 David Grace (3.5 Gould-Ralt-DFR/LPE GR 37), 26.51s; 3 Rob Turnbull (3.5 Gould-DFR/LPE GR37), 26.93s; 4 Tim Mason (3.5 Pilbeam-Judd/Connaught

CV MP50M), 27.50s; 5 Simon Durling (4.0 Pilbeam-DFL/J&F MP58-8), 27.81s; 6 Bill Bristow (2.5 Ralt-Hart/Beattie RT36), 28.21s; 7 Richard Fry (3.5 Gould Ralt-Judd/LPE CV GR37), 28.48s; 8 Tony Marsh (3.5 Gould Ralt-DFR/LPE GR37S), 28.60s; 9 Tim Coventry (3.5 Pilbeam-Judd/Connaught CV MP50M), 28.72s; 10 Malcolm Orme (3.5 Pilbeam-Judd/Merlin EV MP58-1), 28.74s; 11 Deryk Young (3.5 Pilbeam-Judd/Merlin EV MP58-1), 30.38s; Lane, DNF. **Class winners** Peter Herbert (1.4 Westfield-BDH), 33.13s; Trevor Willis (2.0 Westfield-Vauxhall SEI), 33.19s. **record:** Clive Kenrick (2.0 Caterham-BDG), 30.59s; Mike Hall (4.4 Morgan), 34.97s; Richard Jones (3.21 Porsche 911), 30.69s; Martin Groves (1.7 Mallock-Ford Mk20B), 29.01s; Russ Pickering (2.0 Vision-Hart V89), 29.79s; Christian Mineeff (3.5 SPA-Judd CV SC001), 28.55s; Steve Lawrence (0.5 Cooper Mk8), 39.09s; John Corby (0.5 Jedi-Krauser 4/85), 31.64s; Mark Lawrence (1.1 OMS-Kawasaki), 29.33s; Graeme Wight Jr (1.6 Pilbeam-BDA MP62), 29.04s; Willem Toet (2.0 Pilbeam-Vauxhall MP62), 28.80s; Lane 26.22s; Thomas Taylor (1.3 Mini), 38.90s (h/cap); Simon Bridge (1.8 Ford Anglia), 36.41s. **record:** David Lambourne (1.0 A-H Sprite), 49.93s (h/cap); Peter Bottrill (2.0 Lotus 26R), 33.23s. **record:** Jeremy Bouckley (1.5 Smith F2), 38.12s (h/cap); Martin Walford (2.3 Bugatti T51), 39.60s. **Championship positions** 1 Grace, 98pts; 2 Moran, 91; 3 Lane, 72; 4 Mason 65; 5 Turnbull, 58; etc. **RACMSA Leaders Championship** 1 Groves and Wight Jr, 81pts; 3 Tom New, 78; 4 = Moran and Herbert, 69; etc. **Next round** Gurston Down, August 30.



Russ Pickering shrugged off Roger Thomas to win his class driving the Vision Hart

Jerry Sturman

ROWRAH August 15/16

In association with **AUTOSPORT**

# Fell's second chance

**F**orget umbrellas, we were talking arks at Round 5 of Champions of the Future. With rain sheeting across Cumbria, the McLaren-Mercedes meeting halted for more than an hour, with the spectre of abandonment hanging overhead. At the 11th hour, however, it abated and the day became a race against failing light to run the finals.

Mobil 1 Formula JICA Heats went to Mark Fell, Lewis Hamilton and Russell Parkes. With Hamilton (Zip-Vortex) on pole and Ed Tilley's new Kosmic-Vortex combo on grid two,

the class came out for a final full of surprises. First, Fell was out when his carburettor failed. By rights the Tonykart driver's race was over as Alex Lloyd grabbed the lead from Hamilton, but two laps in it was red-flagged and a swift carb change gave Fell a second chance.

He dived past Hamilton at the restart then built his lead to more than 4s by the flag. Tilley, then Russell Parkes passed Lloyd, and Parkes gained a double dividend when first Tilley threw his chain, then Hamilton overcooked a corner and dropped from second to sixth.

Lloyd followed Parkes home in

third while, despite a day of frustrations, Fraser Shearer (Tecno-Rotax) finished fourth ahead of Roy Mendelssohn and Hamilton to retain the championship lead.

Psygnosis Formula Cadet looks set to go all the way. Adam King headed the table coming to Rowrah but, despite a disappointing run in the Final, the tables turned back in Thomas Wedgwood's favour.

King struggled to get on the pace in the heats, where Wedgwood netted two wins. Myles Gatherer equalled his feat and added a second place to secure pole for the final. Daniel Rowbottom and Oliver Oakes won a heat each, Oakes's consistency giving him grid 2 ahead of Wesley Graves and Wedgwood.

The final lead was largely shared between Oakes and Graves with Gatherer chasing. Wedgwood spun out of the picture early on, but Jordan Wise was quick to move up, side-stepping Oliver Turvey and Nicky Mitchell to fourth.

In the closing laps, the lead passed from Oakes to Graves to Gatherer, then back to Oakes, while a battle for second erupted. Gatherer drooped and Graves fought with Wise and Jonathan Robertson for the podium places before opening the door and letting them through, Robertson just ahead across the line. James Bean followed Graves with King in tow. Although Paul di Resta brought

his Sprint home first, the McLaren-Mercedes Junior Yamaha Final result remains provisional until film evidence is viewed, for it is alleged that he made contact with Chaz Small's Venom on the opening lap.

Highest placed after the heats - where Small, Adrian Estasy and Joey Foster took the wins - Small was on pole for the final. Small clung firm to his line through the first turn with di Resta on his tail, but when he exited the first hairpin he appeared to get out of shape and hit the tyres, handing di Resta the lead.

With Small out, di Resta stormed to an easy win helped by a battle for second between Daniel Devereaux and Evan Hopkins, whose order was reversed at the flag. Estasy looked well placed in fourth until engine failure ended his run. Thus Rodolfo Gonzalez and Joey Foster fought for the place, Foster snatching it on the last corner.

The outcome of the Small/di Resta situation is significant. Either way it effectively ends the championship challenge for one or the other. But there is still points leader Estasy to unseat and he has a comfortable lead.

● Allison Lock

**MOBIL 1 FORMULA JUNIOR INTERCONTINENTAL A** 1 Mark Fell (Tony-Vortex), 2 Russell Parkes (Tecno-Vortex), 3 Alex Lloyd (Tony-Vortex).

**MCLAREN-MERCEDES FORMULA JUNIOR YAMAHA INTERCONTINENTAL 1** Paul di Resta (Sprint-Yamaha), 2 Evan Hopkins (Zip-Yamaha), 3 Daniel Devereaux (Zip-Yamaha).

**PSYGNOSIS RAC BRITISH FORMULA CADET 1** Oliver Oakes (Zip-Corner), 2 Jonathan Robertson (Wright-Corner), 3 Jordan Wise (Tony-Vortex).



Mark Fell drove with commendable maturity to win the JICA category at Rowrah





FPA founder Jonathan Palmer (centre), Jonny Kane (standing) and driver Edward Redfern, whose car the AUTOSPORT tester was to be entrusted with

# Equal Opportunities

*After a shaky start, Formula Palmer Audi's concept of providing drivers with evenly-matched machinery seems to be paying off. We sent 1995 McLaren Autosport BRDC Young Driver Jonny Kane to try it out for himself*

**F**ormula Palmer Audi may be a nascent concept, but from the evidence I've seen it's got every chance of being a healthy formula well into the next millennium.

'There's been a lot of discussion about its early-season problems, but these have been ironed out. The organisers have done a good job.

Whether the idea of running a whole series under the awning of a single team catches on elsewhere or not, FPA has the strength to stand alone. After testing the car at Silverstone, I came away with a far more positive impression than on arrival.

'It proved to me that it's basically no different from any other - my theory is that all racing cars are

roughly the same animal. I did about 30 laps, and that was enough to find out that, with its turbocharged, 1.8-litre Audi engine and Van Diemen-built aluminium honeycomb chassis, this really is good.

'The fact that I was quickest in the session has maybe favourably influenced me, but my overall impression was a very positive one. It's quite a



Each car is assigned its own mechanic



Kane soon found there was little to be gained by throwing the FPA around

tricky car to drive and demands respect. It slides around quite a lot, and I would equate it to driving a Formula 3 car in damp conditions.

'The turbo and the brakes are the only things that take a bit of getting used to. With my F3 and Formula 3000 experience, the straightline speed of 250bhp was not a great culture shock, but it's definitely quick. With smaller wings and harder tyres than in F3, the braking areas are a lot longer. This promotes overtaking.





turbo's lag is negligible, so you have to be quite gentle with the throttle. On a corner such as Copse, I found that if you used the throttle more gradually than you normally would, the turbo came in a lot smoother, meaning I didn't get as much over-steer on the exit.

'This is not a bad thing. Every step drivers take up the motor racing ladder, they need to be learning something new and become adaptable. This will teach them about throttle control. A driver coming into FPA from Formula Ford, or any junior formula, should be able to cope with this, because their reactions will see them through.

'Like any winged car, I don't think there's much to be gained from chucking it around. It's easy to lock the wheels, so being smooth and consistent is the key. It teaches you not to make mistakes - you have to drive within yourself a little bit.

'There are other things to learn on the car, but drivers are restricted to changing the bare minimum - you can only play with wing and damper settings and the roll bars. While other formulas are more technical, this is good because you concentrate your efforts on a few things and improve in those areas.

**“ The key with FPA is that equality in the cars means driver talent shows ”**

**JONNY KANE**

All photos: Mike Walker

'Much has also been made of the overtaking possibilities produced by the turbo boost button. You certainly notice the extra 30bhp when you press it, especially in the lower gears. I used it mainly exiting Luffield to get a run onto the start-finish straight. I think using this technique is how it should be done. You get that little bit of extra speed and it helps you slipstream past someone on the straight. You're never going to hit the button and just fly past another car, but if you've got halfway there, this will make it complete.

'The gearbox felt good - it's heavier and not as technical as in F3, but it's a positive shift and there was no trouble to find a clean selection.

'The major aspect to driving these cars quickly is the application of power on the exit of a corner. The



Palmer gives Kane a lesson in steering

'In FPA, you don't learn to work in a traditional team environment, but I like the system of having one mechanic to a car, with a senior engineer circulating between four of them. It means a driver has to get involved, their input becomes very important, and that's how they learn to really make a car work.

## No hiding place

*There can be no phoney car problem excuses for a poor time - all lap data is shared among the drivers*

Many things within the Formula Palmer Audi framework make it a unique category. The boost button, which provides five-second bursts of an extra 30bhp to help overtaking, is among the highest profile, but FPA also has a policy of sharing lap data readouts among all the drivers, a concept alien to most.

At the end of every test, qualifying session and race, all 24 participants receive a readout which lays their best time against the quickest lap. They can see where they're losing time on the circuit, and how they have to improve. In a world where such information is usually a closely-guarded secret, this comes as something of a revelation.



The series is pitched to rival Formula 3

'The series founder, Jonathan Palmer, pitched his formula as a rival to F3, but in its first season many would argue it's been more of a threat to Formula Renault Sport and Formula Vauxhall.

'I guess I'm quite well placed to judge its position because, as well as my F3000 experience, I've won championships in FFord, FVauxhall and F3. I would say it lands at the moment between F3 and FVauxhall. However, FPA has improved a lot since the season's start, with its bigger turbo and improved reliability, and things could change again. Next year, it might be closer to F3.

'The prize of a free season in F3000 is amazing. The person who wins it has to take full advantage. The key with Palmer Audi is that equality in the cars means that driver talent shows. We all know that talent isn't everything in this sport, but team



The whole operation is under one roof

managers further up the ladder will watch with interest.

'To keep on attracting good drivers is vital for the formula. If that continues, people will want to compete in it. Add the very reasonable budget required for a season, with a car good enough to be durable, and it's got a healthy future.' ■

## CLUB SPORT

### Sat/Sun Aug 22/23; Silverstone (GB)

BRDC. Formula Palmer Audi, British GTs, Supersports 200, K Sports 1600, Maranello Ferrari Challenge, Ginetta, Marcos Mantis Challenge, Porsche Cup, Classic Porsches, Mintex Rallysprint. Qualifying (Sat): 0900. Racing (Sun): 1130. Admission: £10. Children U16: Free. Tel: 01327 857271

### Sat Aug 22; Oulton Park (GB)

BARC. Classic Formula Ford 2000, MGs, Westfields, Sports Cars, Saloon Cars, Austin Healeys, Super Sprint, 2CVs. Qualifying: 0830. Racing: 1300. Admission: £10. Children: £1. Tel: 01829 760301

### Sun Aug 23; Brands Hatch (GB)

BRSCC. Formula Vee, Lotus 7s, Classic Touring Cars, Aston Martins, Classic Saloons, Historic Touring Cars, Post-Historic Touring Cars, Group 1 Touring Cars. Qualifying: 0900. Racing: 1300. Admission: £15. Children: £2. Tel: 01474 872331

### Sun Aug 23; Cadwell Park (GB)

VSCC. Fraser Nash and GN Cars, Williams Trophy, Shuttleworth and Nuffield Trophy, Vintage Racing Cars, Scratch Race, Handicap Race, 1100cc Racing Cars. Qualifying: 0915. Racing: 1300. Admission: £10. Children: Free. Tel: 01608 644777

### Sun Aug 23; Lydden Hill (GB)

BARC. Saloon Cars, 797 Graduates, Kent Formula Ford 1600, Minis, Lydden Sports Cars, Silhouette Saloons, Single Seaters. Qualifying: 1230. Racing: 1400. Admission: £6. Children: Free. Tel: 01279 730274



Sharing lap data was an alien concept

I were racing in the series, but the key is that it's the same for everyone - you just have to put up with it. If I'm quickest, it's up to them to beat me, but if someone else were quicker, I'd definitely be looking at their readout.'

The effect of this open information is two-fold. It helps drivers to learn where they're losing time and it enforces a regime of brutal honesty. Palmer's idea was to allow no more space for hiding behind fabricated car problems to justify ending up in the midfield.

Novel, certainly. Refreshing, definitely. The system also seems to lead to more harmony in the paddock - there's no feeling of huddles behind closed doors. In a series based on equality, this is a vital component.



# Take me to your leader



**ADAM FAITH**  
ACTOR/PRODUCER

I've kept an eye on motor racing ever since I was a kid. When I first came into the entertainment business, a journalist asked me, if I hadn't been who I was, who would I have liked to have been? My immediate response, with no qualification, was Stirling Moss. In a way, he and Juan-Manuel Fangio made modern motor racing for me.

Having said that, I didn't go to a race meeting until the week before I met Bernie Ecclestone. I remember being down at the Monaco Grand Prix in 1965. It was the year that Paul Hawkins went in the water, and we fished him out. He spent the rest of the race sitting on the yacht with us, because we were right in the harbour.

I was in Monaco for about four days after the race with some friends. We had a system for playing the roulette wheel in the Casino. It was at a time when you were only allowed to take £25 out of the country, but I eventually came away with £5500, which was a lot of money in the early 1960s.

Coming home on the plane, I had notes stuffed all over me because one of my friends on the yacht had changed my francs for pounds. Then I had to decide whether I should use the money to gamble some more or buy something with it.

Back in London, I was in a casino, waiting for a table to open, when a man came and sat next to me. I knew his face because I had seen him around the place. We got talking and I told him my dilemma. He obviously saw I wasn't a serious punter because he told me to buy something and never play the tables again.

I asked him what I should buy and mentioned that I had always wanted a Rolls-Royce since I was a boy. He told me to come down to his garage the next morning because he had one. 'Come and have a look at it,' he said. 'And, if you like it, you can drive it away.'

He was Bernie Ecclestone. I bought the Rolls and kept it for about 15 years. My friendship with Bernie has lasted until this day. Occasionally he phones me up and asks me whether I want to go to a GP.

I've seen races all over the place as his guest, so I've always had the opportunity of seeing them from a privileged position. Despite having been to so many different events, there are two things that still really impress me about Formula 1 - the starts and Bernie Ecclestone.

It is difficult to describe the moment the lights go out at a GP - all that violence, noise and danger. It must feel the same to stand next to a space rocket when it is taking off. It reminds me of the time when I was in Kenya on the Masai

Mara and the wildebeest were migrating. When they reached the Mara river, there were suddenly tens of thousands of them backed up, with all these lions and crocodiles waiting for them. Eventually, by sheer animal force, the first one was pushed into the water and that started it all off. The panic, the mayhem is just incredible. It's an amazing feeling.

Bernie Ecclestone is a man who is unique in the world. He is remarkable and there is nobody in business who can match him. If you put him in charge of *anything*, from a government to a cafeteria in the park, it would not take too long before he would do remarkable things which would supersede anything that a normal human being could achieve.

A lot of people in F1, who see him all the time, probably overlook the job he does. It seems inadequate to say he is a genius. This isn't bullshit. I've got no business with Bernie, we are just friends. I've got nothing to win or lose out of this relationship.

However, if I was running the world and aliens were going to land, and we needed to negotiate with them, I wouldn't mess about with Bill Clinton, or Tony Blair, or any other world leader for that matter. I'd tell them to get in touch with Bernie. If I needed to have anybody on my side to negotiate or to work with me on anything, he would be the person I would ask.

I don't think the impact he has made on the sport will be realised until he leaves. Every team owner, every person to do with GPs - even the fans - owes him a debt of gratitude. ■

**“ I don't think the impact Bernie has made on the sport will be realised until he leaves ”**

ADAM FAITH



Formula 1's powerbroker, Bernie Ecclestone (left), deep in conversation with team owners Eddie Jordan (centre) and Craig Pollock

**How to contact us**

**Editorial**, tel: 0181-943 5998, fax: 0181-943 5922. **Advertising**, tel: 0181-943 5858, fax: 0181-943 5850. **Ad production**, tel: 0181-943 5909, fax: 0181-943 5850. **Autosport Photographic**, tel: 0181-943 5918. **Autosport incorporating Autoclassic** is published weekly by Haymarket Specialist Motoring Publications Ltd, 38-42 Hampton Road, Teddington, Middlesex, TW11 0JE. Reproduction in whole or in part of any text, photograph or illustration without written permission from the publisher is strictly prohibited. While due care is taken to ensure the contents of Autosport are accurate, the publishers and printers cannot accept liability for errors and omissions. Advertisements are accepted for publication in Autosport only upon Haymarket Publishing Services Limited's Standard Terms of Acceptance of Advertising, copies of which are available from the Advertising Sales Department of Autosport. **Editorial, Advertisement and Circulation**: 38-42 Hampton Road, Teddington, Middlesex, TW11 0JE. **Circulation trade enquiries**: Frontline Ltd, Park House, 117 Park Road, Peterborough, Cambs, PE1 2TS. Tel: 01733 555161. **Subscriptions**: (not US/Canada/Mexico) Autosport, PO Box 280, Sittingbourne, Kent, ME9 8BF.

Tel: 01795 414817, fax: 01795 414800, e-mail: haymarket@galleon.co.uk. Rates: UK £122.40, Euro and Europe/overseas surface mail £140, Middle East/Africa/India £172, Rest of the world £211. Autosport (USPS 454230) is published 51 times a year by Haymarket Specialist Magazines Ltd in the United Kingdom. US/Canada/Mexico rates: USA \$169, (Canada/Mexico \$208) from EWA, 205 US Hwy 22, Green Brook, NJ 08812. Call: (732) 424 7811 fax: (732) 424 7814. Second-class postage paid at Dunellen NJ 08812. Postmaster: send address corrections to: EWA, 205 US Hwy 22, Green Brook NJ 08812. E-mail address is ewa@ewasubs.com. Postage is free for all subscriptions. **Back numbers**: Haymarket Reprints, PO Box 200, Abingdon, Oxfordshire, OX14 3FG. Tel: 01235 534323. USA newsstand: Eastern News, 1130 Cleveland Road, Standusky, Ohio 44870. **Printed in England by**: St Ives plc. **Cover and centre sections printed by**: SR Hubbard Ltd, Callywhite Lane, Dronfield, Sheffield. **Colour origination**: Advertising: Primary Colours Ltd, 23 Grove Park Terrace, Chiswick, London, W4 3QE. Editorial: Colour Systems, 90-92 Pentonville Road, London, N1 9HS. Registered at the post office as a newspaper. © Autosport 1998.



# Join

## www.autosportmag.com

# in Hungary for:

- Up-to-the minute F1 news
- Full transcripts of press conferences
- Exclusive driver interviews
- And the inside line on the F1 paddock

### PLUS

- Knockhill BTCC
- Mid Ohio ChampCars
- Hungaroring F3000
- Pembrey F3
- Rally Finland preview with Carlos Sainz
- And all the breaking news from the world of motorsport

### LIVE BTCC TIMING

From 1000, Friday August 14  
until 1730, Sunday August 16  
See [www.autosportmag.com](http://www.autosportmag.com) for  
full race weekend timetable

We will also run daily chat sessions on our America OnLine site throughout race weekend. Just keyword 'Autosport' from the AOL homepage.\*

\*Call 0800 279 1234 for your free AOL starter pack. And don't forget to mention Autosport when ordering



# Your one stop Motorsport shop...



**SAMCO Sports**

From £6.98

Silicone hose available in 45°, 90°, 135° elbows, straight lengths and reducers.



From £6.95

Race springs for all applications.



AP RACING



AP RACING



AP RACING

Vast range of AP Racing discs, calipers, clutches, differentials, fluids and master cylinders.



Sparco, OMP & Safety Devices provide clubman, multi point and weld in roll cages, available in steel or light weight alternatives. FIA/ONSIRAC Approved.

FIA Approved Seats from Sparco, MomoCorse, OMP, Cobra, Recaro & Corbeau. Harnesses from Sabelt, TRS, Willans, Luke, MomoCorse & OMP



FIA



From £92.00

FIA Approved electrical, mechanical, single and dual chamber available.

FIA Approved racing fuel cells and tailored bag tanks, also pumps, vents & filler necks, hose & refuelling systems



Longacre



Longacre

Full range of set up equipment from Longacre, Intercomp, Pace, Dunlop and Champion.



STACK STACK

Full range of Dash logger systems, pressure sensors, accessories and parts. Gauges available from Elliot, Racetech, Arntech, SPA Design & Smiths.



FIA

Sparco, OMP & Safety Devices provide clubman, multi point and weld in roll cages, available in steel or light weight alternatives. FIA/ONSIRAC Approved.



Sparco

Sparco, OMP & Momo Steering wheels available in suede or leather for saloon & single seater.



Arai HELMET

GP3K £390.00



Not FIA

Arai HELMET

GPX £249.00

VAT Free



BELL HELMETS

Sport 2 £288.00



Bridges

F1 £450.00



OMP

Helmet Bag £17.51



Braces from £20.51



Visors from £25.00

**VISORS**

Sparco from	£25.00
Bieffe from	£38.30
Shoei from	£48.00
Arai from	£48.00
Bell from	£51.00
Bell tear offs	£11.33

**HELMET PAINTING SERVICE**  
Complete paint & design service for your individual or corporate identity. Single colour from £125.00



Sparco

Circuit £179.00

VAT Free



Sparco

Pro Rally £350.00

VAT Free



SHOEI

Quattro £495.00

Many more helmets available please call!

**WORRY FREE PURCHASE**  
If you have not chosen the most suitable size of helmet, we will arrange free collection & re-delivery of a replacement. (UK only)



Top Driver £75.00



Clubman £50.79



Pista £70.16



Sparco

Sprint, 2 layer £195.00



OMP

Trend, 3 layer £171.42



Momo

Racing, 3 layer £190.00



Sparco

Clubman £50.79



Pista £70.16



Balas from £7.66



from £22.17

**SUITS**

FIA Approved Sparco Sprint	2L	£195.00
Sparco 2	2L	£340.00
Sparco Prima	3L	£410.00
OMP Trend	3L	£171.42
OMP Super First	3L	£274.28
Momo Racing	3L	£190.00

L = 2 or 3 layer Nomex

**NOMEX BOOTS**

FIA Approved Sparco Top Driver	HT	£75.00
Sparco Racing	LT	£61.00
OMP Clubman	LT	£50.79
OMP Formula	HT	£96.27
Momo Pista	LT	£70.16
Momo Corsa	HT	£79.10

HT = High top LT = Low top

**NOMEX GLOVES**

FIA Approved Sparco Budget	£24.00
Sparco Profi	£40.00
OMP Rally	£22.17
OMP Challenger	£28.79
OMP Professional	£42.27
Momo Rally Top	£38.29

**BALACLAVAS**  
FIA Approved from £7.66

**UNDERWEAR SETS**  
FIA Approved from £4.04

**KIT BAGS**  
Sparco Trip Bag. Holds full kit including helmet. from £28.00

**TO ORDER**  
call our direct sales hotline on **:01978 664466**  
or fax: 01978 664467

American Express, Visa/Barclaycard, Diners Club Mastercard, JCB or Switch orders taken by telephone. Cheques, postal orders or bankdrafts made payable to Demon Tweeks. Goods despatched by next day £5.95 or 2 day £4.95. All prices shown are subject to alteration without notice. **IMPORTANT VAT must be added to all advertised prices**

**1998**  
284 page full colour MOTORSPORT PARTS AND ACCESSORIES CATALOGUE  
**FREE**  
Tel: **0930 106060**  
Calls to 0930 numbers cost 50p per minute at all times. (Calls should last no longer than 1 1/2 minutes)



Mastercard VISA Diners Club International AMERICAN EXPRESS DELTA JCB SWITCH TRANSAX

**demon tweeks Direct**

Dept 115, 75 Ash Road South, Wrexham Industrial Estate, Wrexham, North Wales. LL13 9UG