

MALAYSIAN GRAND PRIX REPORT

AUTOSPORT

APRIL 3 2014

FIRST MERCEDES 1-2 SINCE 1955

HAMILTON STRIKES BACK

“Lewis could have gone even faster” admits Vettel

PLUS



BRANDS BTCC THRILLS
Jordan starts with a bang as returning stars struggle





Porsche recommends **Mobil 1** and **MICHELIN**

Today's snapshot of tomorrow's motorsports.

The Porsche 919 Hybrid.

With our new LMP1 race car, the Porsche 919 Hybrid, we return to top-level racing and to the 24h of Le Mans. After 16 overall victories, we're back again with our new prototype to gain what is most important to us: knowledge - for the Porsche cars of the future.

Mission 2014. Our Return.

Discover more: www.porsche.co.uk/mission2014

DMG MORI **CHOPARD** **SCHAEFFLER** **WEC**
WAGNER FAG



PORSCHE

RENAULT CLIO



Our Formula One inspired ENERGY engines deliver you more miles for your money.

We've designed a range of Formula One inspired ENERGY engines for the Renault Clio. Why? Because they deliver up to 21% better fuel consumption with reduced CO₂ emissions and a combined mpg of **88.3**. Oh, and because it's nice to say, 'I've got a Formula One inspired ENERGY engine under the bonnet.'

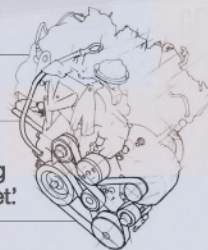

Visit renault.co.uk or call 08000 28 28 14 to book a test drive



Model shown Clio Dynamique S MediaNav with optional Flame Red metallic paint. The official consumption figures in mpg (l/100km) for the Renault Clio core range are: Urban 40.4 (7.0) – 78.5 (3.6); Extra Urban 60.1 (4.7) – 94.2 (3.0); Combined 51.4 (5.5) – 88.3 (3.2). The official CO₂ emissions for the range are 127-83g/km. EU Directive and Regulation 692/2008 test environment figures. Fuel consumption and CO₂ may vary according to driving styles, road conditions and other factors.



POLE POSITION

Celebrating a fantastic weekend for British sport

BRAVO LEWIS HAMILTON. SUNDAY'S VICTORY in the Malaysian Grand Prix was just what he needed after the disappointment of Melbourne, where he'd also qualified on pole but failed to register points due to a tiny insulation tube failing and short-circuiting a cylinder in his Mercedes engine.

Of course, it was churlish to suggest that Sepang was a "must-win" result, but it's a victory that kickstarts his title fight with team-mate Nico Rosberg, and with Sebastian Vettel also now registering it keeps the intrigue level high.

When Hamilton cut his apron strings to McLaren to join Mercedes it was always with one eye on being with a manufacturer in this new era of technical regulations. Now he's led home the first factory Merc one-two since Juan Manuel Fangio and Piero Taruffi at Monza in September 1955 – I'll wager it won't be the last.

British Touring Cars also burst into life with a fantastic start to its season at Brands Hatch, where the crowd was wowed by a capacity grid and three action-packed races. And the final piece in Goodwood's jigsaw – the 'revival' of its Members' Meeting – made this a memorable weekend for British motorsport in so many ways.



Bradley

CHARLES BRADLEY EDITOR
charles.bradley@haymarket.com
@Autosport_Ed

PRIVATE EAR

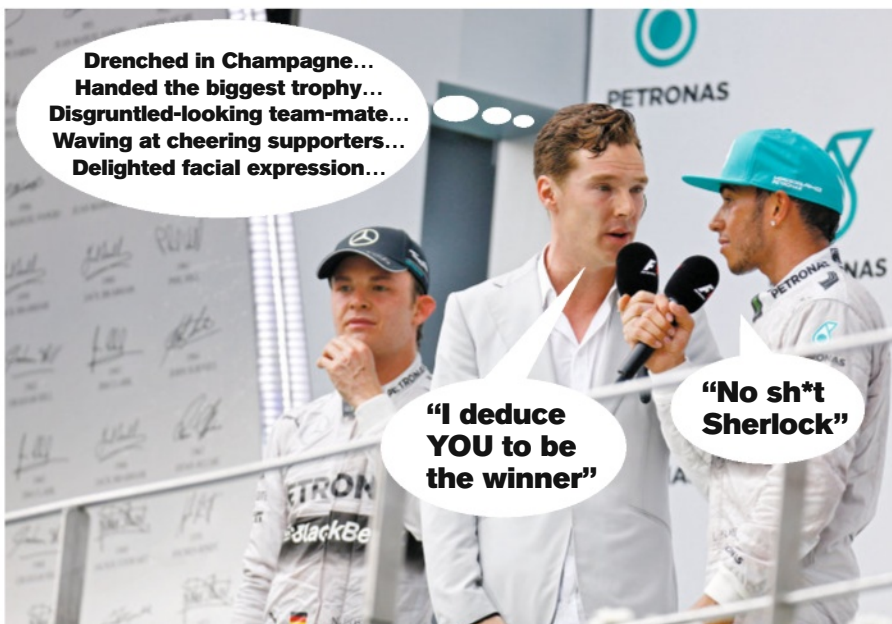

**Drenched in Champagne...
Handed the biggest trophy...
Disgruntled-looking team-mate...
Waving at cheering supporters...
Delighted facial expression...**

"I deduce YOU to be the winner"

"No sh*t Sherlock"

FIND US ON



Cover Images:
Dunbar/LAT, Ebrey/LAT

PIT & PADDOCK

- 8 THIS WEEK IN F1**
- 11 JONATHAN NOBLE: F1 NEWSHOUND**
- 12 THIS WEEK IN MOTORSPORT**
- 15 DIETER RENCKEN: THE INSIDE LINE**

GRAND PRIX REPORT

16 MALAYSIAN GRAND PRIX REPORT
All the action from the second race of the year, including driver-by-driver and team guide, technical analysis, comprehensive results and the key on- and off-track moments from the weekend

DEBRIEF

- 32 ARE WE FEELING THE F1 NOISE?**
Analysing the divided opinion among drivers and fans over the sound of the new 1.6-litre turbo engines
- 34 PORSCHE MAKES A POINT IN WEC TEST**
The truth behind the all-new 919 LMP1's headline-grabbing World Endurance test at Paul Ricard

FEATURES

- 36 SAUDI GRAND PRIX PREVIEW**
- 38 TOYOTA PINS HOPES ON NEW TS040**
We talk to the men behind Toyota's 1000bhp LMP1
- 42 GP2 PREVIEW**
It'll be veterans versus rookies in F1's feeder formula

RACE CENTRE

- 46 BTCC BRANDS HATCH**
Wins for champ Jordan and former champ Turkington
- 50 TOCA SUPPORTS BRANDS HATCH**
Ginettas, Porsche Carrera Cup, FFord, Renault Clio
- 52 INDYCAR ST PETERSBURG**
Power makes perfect start to season with Penske
- 56 NASCAR; INDY LIGHTS; VLN; ACROPOLIS RALLY; V8 SUPERCARS**

58 GOODWOOD MEMBERS' MEETING
72nd 'clubbie' wows drivers and spectators alike

SUBSCRIPTION OFFER & COMPETITION

- 60 FREE GILLES VILLENEUVE T-SHIRT**
Subscribe for a great gift and digital package
- 78 WIN A WEEKEND AT THE BRITISH GP**

CLUB AUTOSPORT

75 NISSAN RETURNS TO BRITISH GT
Onslow-Cole lands factory-backed GTR ride

76 HILL STARS ON PORSCHE DEBUT
Jake Hill considers full-time Carrera Cup move

79 BLUEBIRD ELECTRIC RACE IS GO
Thirty-car father/son race set for Rockingham TOCA

80 NATIONAL REPORTS
Donington Park 750MC; BRX Lydden; Silverstone MGCC; Kirkistown 500MRCI; Oulton Park BARC

THE BACK STRAIGHT

- 86 THIS WEEK**
Readers' letters; best pictures; product reviews
- 88 WHAT'S ON**
The best track and TV action in the coming week
- 90 RACE OF MY LIFE: KARL JONES**
Silverstone RAC Tourist Trophy 1988



THE BIG PICTURE

Chris Snowden's Alfa Romeo GTV wheelies over shards of Goodwood's chicane while fending off Jason Stanley's Mini 1275 GT during the Gerry Marshall Trophy race





BLOXHAM/LAT

This week in F1

RED BULL REVEALS PLAN FOR RICCIARDO FUEL-FLOW APPEAL

Red Bull will argue that a technical directive issued by the sport's governing body the FIA regarding fuel-flow sensor readings cannot be used as grounds to disqualify Daniel Ricciardo from last month's Australian Grand Prix.

At an FIA Appeal Court hearing in Paris on April 14 Red Bull says it is ready to prove it did not break the regulations regarding fuel-flow rate, and will argue technical directives do not hold regulatory value. It will contend this was

established by last year's controversy over Mercedes' secret Pirelli tyre test.

The FIA insists the rules are clear and that Red Bull, which experienced fresh fuel-flow sensor issues in Malaysia last weekend, was in breach.



88

"We have got to find a better way. Depending on the calibration of your sensor, it will determine your competitiveness, which is completely wrong"

Red Bull boss Christian Horner



"During the race we were fuel saving and the team was giving information on how much to save during a lap, but nothing more than that. I knew nothing about it"

Daniel Ricciardo



"If you have no fuel-flow limit there will be huge and very dangerous differences of speed [between cars] on the same lap, with a driving style that is not really F1"

FIA head of powertrain Fabrice Lom



Sauber 'is overweight'

Sauber drivers Adrian Sutil and Esteban Gutierrez have revealed the team's car is too heavy during last weekend's Malaysian GP. The C33's customer Ferrari engine is understood to be over the minimum power unit weight of 145kg, and the team has been unable to get down to the overall minimum weight limit of 692kg (raised by approximately 50kg for 2014).

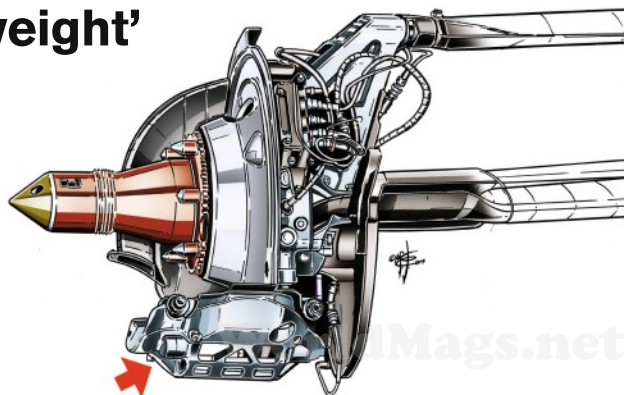

BRAKE WEIGHT SAVING

GARY ANDERSON: "The usual brake system pre-2014 featured a six-piston caliper front and rear. Because of the brake-by-wire system, most teams have gone much smaller on the rear discs and calipers. Sauber, like Red Bull and others, have gone to a four-piston caliper because 15 per cent of the braking is done by the electric motor. The caliper is, at most, a 200g weight saving at each rear corner."















For all the breaking news, visit AUTOSPORT.COM

Pole ace Lewis equals Clark

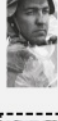
Lewis Hamilton equalled Jim Clark's record for the most F1 pole positions by a British driver at last weekend's Malaysian GP. The Mercedes driver outqualified Sebastian Vettel by 0.055s to take his 33rd F1 pole.

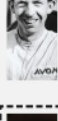
BRITS' F1 POLES-TO-STARTS RATIO

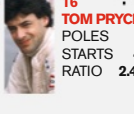
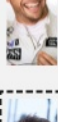
We've calculated a supergrid of British drivers, based on the percentage of races they started from pole position during their careers

 2 LEWIS HAMILTON POLES 33 STARTS 131 RATIO 25.2%	 1 JIM CLARK POLES 33 STARTS 72 RATIO 45.8%
 4 DAMON HILL POLES 20 STARTS 115 RATIO 17.4%	 3 STIRLING MOSS POLES 16 STARTS 66 RATIO 24.2%
 6 NIGEL MANSELL POLES 32 STARTS 187 RATIO 17.1%	 5 JACKIE STEWART POLES 17 STARTS 99 RATIO 17.2%
 8 JAMES HUNT POLES 14 STARTS 92 RATIO 15.2%	 7 MIKE PARKES POLES 1 STARTS 6 RATIO 16.7%
 10 MIKE HAWTHORN POLES 4 STARTS 45 RATIO 8.9%	 9 STUART LEWIS-EVANS POLES 2 STARTS 14 RATIO 14.3%
 12 GRAHAM HILL POLES 13 STARTS 176 RATIO 7.4%	 11 TONY BROOKS POLES 3 STARTS 38 RATIO 7.9%
 14 DAVID COULTHARD POLES 12 STARTS 246 RATIO 4.9%	 13 JOHN SURTEES POLES 8 STARTS 111 RATIO 7.2%
 16 TOM PRYCE POLES 1 STARTS 42 RATIO 2.4%	 15 JENSON BUTTON POLES 8 STARTS 249 RATIO 3.2%
 17 JOHN WATSON POLES 2 STARTS 152 RATIO 1.3%	

McLAREN'S NOSE JOB

McLaren introduced a modified anteatr nose at the Malaysian GP, in addition to the new front wing assembly that was used at the Australian GP. GARY ANDERSON analyses the changes:

Front wing changes (Australia)

- 1 This is a smoother transition to the endplate, whereas the original was very abrupt. An abrupt change can cause airflow-separation problems.
- 2 The upper forward wing has been simplified to a bigger, one-piece component.
- 3 This is a ski ramp, similar to the one Mercedes ran last year. The aim is to turn airflow over the tyre.
- 4 It has moved to a smaller turning vane solution.

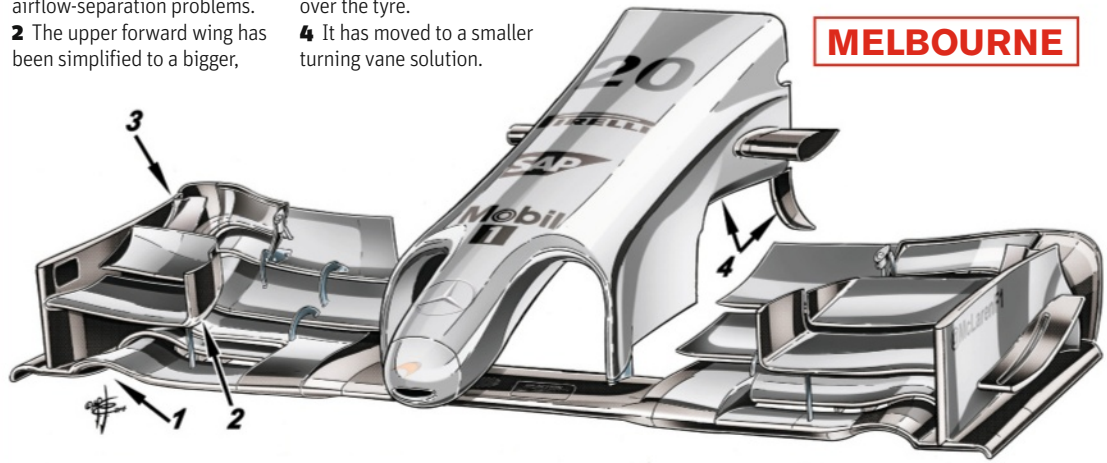

MELBOURNE



SEPANG

New nose (Malaysia)

- 5 The nose is raised near the Mobil logo to the maximum allowed height in the 2014 regulations.
- 6 The new nose section is higher and further rearward, with a revised 'anteater'. This is designed to get more airflow under the nose to the floor.
- 7 Like Ferrari, McLaren has introduced a bigger radius on the top corner of the nose, which then blends into a smaller radius where it joins the chassis. This allows airflow to spill off the top surface of the nose.
- 8 The front-wing mounting pillars are more curved, turning the airflow outward more aggressively.



REMEMBER WHEN

Mercedes last finished one-two in a world championship Formula 1 race in September 1955. Juan-Manuel Fangio (pictured) beat Piero Taruffi by just 0.7s at Monza that season.



Kobayashi in F1 safety fear

Kamui Kobayashi has called for a rethink on nose designs in Formula 1, following his Australian Grand Prix crash with Felipe Massa. "I think I was lucky that I did not hurt myself, because if it happened in Monza, it could be dangerous," he said.





**FORMULA 1
GRAN PREMIO
DE ESPAÑA**

**CATALUNYA
9-10-11 MAY 2014**



Formula 1® & Barcelona

**The engines change. The designs change.
The regulations change.
Everything changes, but Barcelona.**

Come and hear the new V-6 FORMULA 1 engines roaring on 9, 10 and 11 May, at Circuit de Barcelona-Catalunya. Because everything has changed. Everything but the sun, the beach, the gastronomy, the shopping, etc. in Barcelona.



The F1 FORMULA 1 logo, F1, FORMULA 1, FIA FORMULA ONE WORLD CHAMPIONSHIP, GRAND PRIX, GRAN PREMIO DE ESPAÑA and related marks are trade marks of Formula One Licensing BV a, Formula One group company. All rights reserved.





Jonathan Noble

F1's newshound

The depth and thoroughness of a grand prix team's preparation matter not a jot when the fates conspire and misfortune strikes

However deep Lewis Hamilton and Nico Rosberg have to dig to outdo each other on track, there's one factor that neither can have any influence over in their title battle: Lady Luck's shining light.

You can argue all you want about there being no luck in motor racing – that diligence is the mother of good fortune – but in sport sometimes you simply get dealt a bad card.

Last weekend, in a fascinating moment of transparency, Mercedes-Benz engine chief Andy Cowell came clean about the misfortune that had wrecked Hamilton's victory chances a fortnight ago in Australia. He pulled from his pocket a small plastic bag that had inside it a spark plug and a small blue rubber tube, no bigger than your little finger.

He explained how this tube, which insulates the spark plug in the engine, had developed a miniscule fault on the inside where the two parts of the tube had been moulded together.

Over the course of the Melbourne weekend, this weakness had been attacked by the spark – so much so that on the formation lap a hole had burned completely through the rubber. This allowed the spark to short on the cylinder head, leaving Hamilton with a V5 on the formation lap and no chance of finishing the race.

While a more robust design would have prevented the failure in the first place, it doesn't escape the fact that Hamilton had been tremendously unlucky



Rewind a bit further and we must remember that Mercedes had elected to replace the engine on Hamilton's car before the track action got underway, because it was worried about a fault in the unit he was originally going to use. So Lewis should never have had this one faulty tube in his car in the first place.

"All things, even bad things, happen for a reason," said Hamilton afterwards. "Even if we don't like it and even if it's not good, there's always a reason for it happening. That is how I look at it. So I'm looking

"Argue all you want that there's no luck in racing, sometimes you simply get dealt a bad card"

to be hit with a case of Finagle's Law of Dynamic Negatives – anything that can go wrong will, and at the worst possible moment.

Just think about it. Of the 48 rubber drop tubes fitted to the Mercedes-powered cars in Australia, Hamilton's was the only one that suffered this issue. The problem had never been encountered on the dyno during all the years of the new turbo engines' development; and neither had there been an issue during the thousands of kilometres of track testing in Jerez and Bahrain.

Worse than that, though, was that it happened to fail just moments past the point of no return. Had it gone earlier in the weekend, even in qualifying, then it could have been replaced.

We must also consider that if Hamilton had not been forced to miss FP1 in Australia, due to a faulty sensor shutting his car down, then the problem may have come to light early enough in the weekend for it not to strike him on race day.

at the glass half full rather than half empty."

Maybe he's right to react like this. For while that rubber tube cost him a decent chunk of points in Australia, it also means he now has an engine that's done one race distance fewer than Rosberg.

With the strict limit of five engines this season, that mileage advantage could benefit him later in the campaign, meaning he can either use more power at a specific race to take a win, or he can be more flexible in saving up fresher engines for when they are needed most.

Let's also not forget that the unpopular double-points rule also favours those whose luck comes late in the campaign. For Hamilton, Australia may have felt like an unlucky break, but in the ebb and flow of a season it could yet prove to be the best thing that happened to him.

And neither he nor Rosberg will be able to do a thing about it. ❧

This week in motorsport



P34 WEC TESTING

12

AUDI BACKS WORLD ENDURANCE 'WINTER SERIES' PLAN

Audi has come out in favour of the idea of the World Endurance Championship running over the winter, with the Le Mans 24 Hours in June as its finale. The plan would be that the series

would start in the autumn with the flyaway races that presently make up the second half of the calendar. These would likely be spread out through the winter before the WEC continued with its European races prior to Le Mans.

Audi Sport boss Wolfgang Ullrich revealed that the German manufacturer had been involved in discussions with the WEC and series promoter the Automobile Club de l'Ouest about the idea

for more than one year.

"The idea is one that we have discussed a lot because we think it has potential," he said. "The big question is when and how to start: the transition would be the hardest part."

PORSCHE STEPS DOWN

Porsche has downgraded the amount of hybrid energy its new 919 will run in this year's World Endurance Championship. The German manufacturer had announced its intention to race in the highest of the four sub-classes of recovered energy in 2014, which allows for eight megajoules to be used per lap of Le Mans. Now it has revealed that its 919 Hybrid has been homologated for the season in the 6MJ division. Porsche LMP1 technical director Alex Hitzinger said: "We designed a system to see what was possible and with that system it's not really possible to achieve 8MJ."



He will get what he gets when I decide to give it back



When he needs a break, he'll find his ass turned around in the wall



Kurt Busch (top) and Brad Keselowski vow to continue their on-track spat from last weekend's NASCAR Cup race at Martinsville

Trulli tests Formula E

Ex-grand prix driver Jarno Trulli became the first to experience the Formula E Spark-Renault SRT-01E running in race-spec full-battery capacity last month. The Italian, a veteran of 252 Formula 1 starts, recently drove the car at La Ferte Gaucher in France, where it ran with its full 270 horsepower for the first time. The 39-year-old, who has joined the series' drivers' club initiative, was coy on the subject of a return to racing for the first time since the 2011 Brazilian Grand Prix. "I hope in the future I can do it again," he said of driving the electric car.



For all the breaking news, visit **AUTOSPORT.COM**

AUTOSPORT BACKING LYDDEN RX

AUTOSPORT will be the title sponsor of the second round of the newly formed World Rallycross Championship at Lydden Hill in May. The AUTOSPORT World RX of Great Britain takes place on May 24-25, and pre-event ticket sales are already double those sold pre-event for 2013.

● For more information, and to buy tickets, call 0844 858 8518 or visit www.lyddenhill.co.uk



Ogier leaps to Fafe Rally Sprint win

World Rally champion Sebastien Ogier won Saturday's Fafe Rally Sprint in Portugal in front of a 100,000 crowd in his VW. Ott Tanak's Ford finished half a second adrift in second place, while Hyundai's Dani Sordo was third.



In brief



GREEN GOES ORANGE

Audi revealed Jamie Green's new colour scheme for the 2014 DTM season at this week's official pre-season test at the Hungaroring. Green topped the times on Monday morning, before team-mate Miguel Molina led an Audi top-four lockout when the running came to a close.

ROWLAND ON TOP

Briton Oliver Rowland and Sauber F1 reserve driver Sergey Sirotkin gave Fortec Motorsports a one-two at last week's final pre-season Formula Renault 3.5 test at Jerez. Red Bull junior Pierre Gasly was best of the rest for Arden. The season starts at Monza on April 12/13.

LYNN LEADS IN GP3

British Red Bull racer Alex Lynn topped the times during the first GP3 pre-season test of 2014 at Estoril. The Carlin driver led team-mate Emil Bernstorff, with day-one pacesetter Dino Zamparelli third overall for ART.

RENAULT'S F3 RUN

Renault's new Formula 3 engine was tested at Nogaro last week – just in time for the European championship's first official test at the Hungaroring. The Signature team's two drivers, Oscar Tunjo and Tatiana Calderon, both put mileage on the ORECA-built powerplant.

DESPRES TO PEUGEOT

Five-time Dakar Rally winner Cyril Despres will follow Stephane Peterhansel's move from two wheels to four on next year's South American marathon event. Despres will drive a second factory Peugeot 2008 alongside Carlos Sainz.

D'AMBROSIO IN BES

Ex-Formula 1 driver Jerome d'Ambrosio will race for Bentley in this year's Blancpain Endurance Series. The Belgian will drive the factory M-Sport team's second Continental GT3 alongside Briton Duncan Tappy and Frenchman Antoine Leclerc.

Debut win for 208 T16

Craig Breen gave Peugeot's 208 T16 a debut win on last weekend's Acropolis Rally. The Irishman's maiden ERC victory moves him to the top of the table ahead of his home round of the series, the Circuit of Ireland later this month.



BIRD, CALADO TO AF CORSE

Sportscar convert Sam Bird will contest a minimum of two races in the World Endurance Championship with the AF Corse Ferrari team this year.

Last year's GP2 runner-up has so far been confirmed for this month's Silverstone opener and the Le Mans 24 Hours in one of AF's GTE Am class

458 Italias. He will share the car with WEC regular Michele Rugolo and Australian Steve Wyatt.

Bird's GP2 sparring partner James Calado has finally been confirmed as part of AF's GTE Pro Ferrari factory squad and will drive alongside Davide Rigon.

Kubica needs to play safe

Robert Kubica is expecting an easier ride when he starts this week's Rally of Portugal – the Algarve event is the first WRC event he's competed on before. After a tough start to the season, Kubica says his goal is to stay on the road over the deceptive Portuguese gravel. So far, the

reigning WRC 2 champion has crashed on every event he has started at rallying's highest level.



KUBICA'S SHUNTS IN WORLD RALLY CARS

Rally GB 2013

World Rally Car debut interrupted by two crashes in Wales.

Monte Carlo 2014

Led on his Fiesta debut before sliding off the road and into retirement.

Sweden 2014

Crashed off the road three times on his first snow rally in the WRC.

Mexico 2014

Put his recce car through a fence before the start, then rolled on Friday and Saturday.



LetsRaceHorley

LETS RACE REALITY



LetsRace

WIN F3 TEST DAY WITH CARLIN

MAKE YOUR RACING DREAMS REALITY

Just £25 to enter in a Lets Race 2 Reality entry round during April with a chance to win an F3 test day

<p>CAR: GP2 TRACK: AUSTRALIA, MELBOURNE GP CIRCUIT</p>	<p>ROUND 01</p>	<p>QUALIFYING AT THE LETS RACE SIMULATOR CENTRE DURING MARCH AND APRIL 2014 - £25</p>
<p>TOP 10 % COMPETE IN A KARTING GRAND PRIX AT BUCKMORE PARK ON 23rd MAY 2014 - £65</p>	<p>ROUND 02</p>	<p>TOP 5 DRIVERS FROM ROUND 2 WILL BE INVITED TO CARLIN FOR A DAY OF ACTIVITIES - FREE</p>
<p>FINAL ROUND TO INCLUDE SIMULATOR TRAINING WITH A CARLIN RACE ENGINEER, FACTORY TOUR, AND AN INTERVIEW PROCESS WITH PANEL TO INCLUDE JOHN SURTEES OBE</p>	<p>ROUND 03</p>	<p>A REAL LIFE F3 TEST WITH CHAMPIONS CARLIN FOR THE WINNER. COMPLETE WITH YOUR OWN MECHANICS AND ENGINEERS FOR THE DAY!</p>

TO ENTER CALL: +44 (0)1293 826800 OR VISIT: WWW.LETSRACE.CO.UK

2014

BTCC SATURDAY 19TH AND SUNDAY 20TH APRIL
EASTER WEEKEND

BOOK YOUR ADVANCE TICKETS NOW*

SATURDAY £10 • SUNDAY £25 • WEEKEND £30
Children 13 & under go FREE if accompanied by a paying adult
*Advance ticket prices close at 5pm on Wednesday 16th April 2014. Booking fee applies.

RACE DAY HOSPITALITY
from just £85 per person (includes admission ticket)

TRADE & RETAIL SPACE AVAILABLE
For more details please call 01332 810048

Advance Tickets Book Early Available Now

2014
DUNLOP
Donington
The Heart of British Motorsport

YUASA
eBay
PIRTEK
CBT
DUNLOP
eBay

Official Donington Park Racing @DoningtonParkUK

QR Code



Dieter Rencken

F1's political animal

There could be very sound business reasons for Bernie Ecclestone criticising F1's new engines. Is he trying to buy the sport back?

Formula 1 thrives on conspiracy. Catch two (or more) team bosses in a huddle, and whispers have them trading drivers/ganging up against rivals/scheming further advantageous regulation changes.

In the world of F1 conspiracy, anything goes, with nothing being too bizarre to consider. Indeed, the only variables are the length of time devoted to deliberation/rejection/filing under "future".

But there was a theory shared with this column in the wake of the season opener that was simply too outlandish to have legs. And yet...

A source (who seldom peddles rumours) close to Bernie Ecclestone was adamant that he knew the reason for the F1 tsar's hefty criticism of the new technology, in particular the (lack of) noise emitted by the sport's 1.6-litre V6 engines, whose exhausts are muffled by high-pressure turbochargers driving compressors and electrical generators. This despite the 83-year-old not having heard the engines run in anger prior to last weekend's Malaysian Grand Prix.

"Look at it this way," said the source. "If you want to buy something, you do everything to hammer the price, find fault with the product. I think you'll find Bernie is aiming to buy control of the sport, and you know what hard bargains he drives. He aims to buy out CVC."

After stifling guffaws, the next reaction was to argue that, having single-handedly driven up the value from the £1.1 billion paid by venture fund CVC Capital Partners in that contentious deal – the aftermath of which included

That source had a good point or three, particularly Ecclestone's ability to persuade a syndicate to back him (despite his age) and CVC's headaches – and therefore the open questions are who, how Ecclestone would reacquire control of an entity he has now sold four times (and, according to Ken Tyrrell, did not legally own in the first place), and why he would do so at an age when most men are shuffling about in PJs and slippers.

The why is easier to answer than the how: not only is Ecclestone the consummate entrepreneur, but something of a controlling taskmaster. Yet, since massaging the deal that enabled CVC to acquire 63 per cent of F1's commercial rights – and thus majority control – he has been dictated to, with the latest blow to his well-known modus operandi being "resignations" from companies such as Formula One Management.

Mackenzie told the High Court that Ecclestone would be "fired" if it is proven he had done "anything that is criminally wrong", and once the charges were confirmed, a media release was issued stating that F1's CEO would be subject to increased monitoring. Acquiring majority control (again) would certainly set Ecclestone free professionally, even if the court case still bears heavily – but that is another fight.

So how? Ecclestone (5.3 per cent), his family's Bambino Trust (8.5 per cent) and FOM associates (3.7 per cent) currently hold 17.5 per cent of Delta Topco, the holding vehicle for F1's commercial rights. (Liquidated) Lehman Bros has 12.3 per cent – said to be available, possibly

"Acquiring majority control (again) would certainly set Ecclestone free professionally"

German banker Gerhard Gribkowsky being jailed and Ecclestone charged with bribery – back in 2005 by a factor of (at least) four, even Bernie is unlikely to have sufficient fiscal depth to cut a deal with his paymasters.

"Possibly, but don't forget he's got very rich and extremely powerful friends," the source argued. "I believe he's assembled a syndicate to buy out CVC, who made a fortune out of F1, but endured headache after headache. It's got to a stage where damage to their reputation by being associated with Bernie and his legal issues is not worth their dwindling return on investment, particularly as listing in Singapore is off the table.

"Don't forget companies like CVC are measured on two Rs: reputation and ROI [return on investment]. Already [Donald, CVC co-founder/chairman] Mackenzie was forced to testify in the High Court, and next month Bernie's Munich trial kicks off. Who knows what else awaits? They made their money, and now it's time to get out before their [annualised] return on investment gets dented too much."

immediately after 3 per cent was sold to the Texas Teachers Provident Fund. Such acquisition would take Ecclestone's syndicate to well-nigh 30 per cent.

Since the planned Singapore IPO bombed heavily for various reasons – not least various litigation suits faced by Ecclestone and associates – CVC (and other shareholders) gradually divested from Delta Topco such that CVC now holds just 35.5 per cent, but, in terms of its covenants, retains overall control.

Persuading the venture fund, which has already held its shareholding twice as long as is traditional in the business, to sell out would provide Ecclestone and Co with outright control. The final question is: who would Ecclestone's partners be? Red Bull's Dietrich Mateschitz and Ferrari president Luca di Montezemolo are obvious candidates.

Certainly, Mackenzie and Ecclestone worked the Malaysia paddock hard all weekend, and were not just soliciting comment on exhaust noise... ❧

MALAYSIAN GP

THE RACE REPORT

QUALIFYING • TRACKSIDE VIEW • LAP CHART • DRIVER BY DRIVER • RESULTS

Lewis leaves rivals gasping

Pole position, fastest lap and a lights-to-flag victory – Lewis Hamilton's Malaysian Grand Prix was in stark contrast to his Melbourne disaster. **EDD STRAW** reports on a dominant victory



AT A GLANCE



“The car was spectacular this weekend, a really great performance by the whole team” **HAMILTON**

MALAYSIAN GP
Sepang

ROUND 2/19

LAPS 56

WINNER
Lewis Hamilton
1h40m25.974s

POLE POSITION
Lewis Hamilton
1m59.431s

FASTEST LAP
Lewis Hamilton
1m43.066s

RACE RATING
★★★★★ Not a classic by any stretch, dominated by Hamilton as Rosberg kept Vettel at bay

DRIVERS' STANDINGS

Rosberg	43pts
Hamilton	25pts
Alonso	24pts



Hamilton's opening gambit was enough for second pole of '14



DUNBAR/LAT

QUALIFYING 16:50, 29.03.2014

18

➤ The vast majority of Lewis Hamilton's British-record-equalling 33 pole positions in Formula 1 have been sealed with a last-gasp special. So when he got stuck behind Nico Hulkenberg's Force India on his decisive final lap in the wet Q3 session, matching Jim Clark's number of poles was a long way from his mind.

But the 2008 champion's first flier on wets, which he described as "not my best lap", remained just out of reach of the rest. His advantage over Sebastian Vettel was just five thousandths of a second — a narrow escape for Hamilton, who ran off the track at Turn 4 on his final lap while struggling behind Hulkenberg.

"I missed out behind Hulkenberg, who slowed down on his [penultimate] lap and looked like he was coming in because he went wide at the last turn," said Hamilton. "As I

went to start my lap he cut across me, so I was stuck behind him. I couldn't see a thing when he was in front, it was like driving in thick fog, so I had to bail out of that lap.

"That was the lap that I needed... well, that I *felt* I should have had to get pole. But I'm so glad that the lap I did before was good enough."

Hamilton might not have improved even without finding a Force India in his way, as first laps proved decisive for the majority of the top 10.

Mercedes team-mate Nico Rosberg was the only driver able to improve his time at the end of Q3, but that was the consequence of underachieving on his first. On intermediate rubber, Rosberg looked to have the beating of Hamilton earlier in qualifying, but on wets he was unable to attack as he would have liked on the brakes. This allowed Vettel, who suspected he did have the car to outpace Hamilton on

that first lap, to get ahead.

Fernando Alonso was bumped down to fourth by Rosberg's late effort. He had his Ferrari crew to thank for a rapid front-left-trackrod change after damage sustained in a collision with Daniil Kvyat's Toro Rosso during Q2, allowing him to capitalise on the conditions to outpace team-mate Kimi Raikkonen, who potentially had the edge over him in the dry.

The other Toro Rosso of Jean-Eric Vergne qualified an impressive ninth, ahead of Jenson Button who had gambled on, and stuck with, the slower intermediate in Q3. Kevin Magnussen, in the other McLaren, had initially gone out on inters before deciding to pit for wets, the rookie ending up eighth.

Williams looked a top-six contender in the dry, but struggled badly in the wet, and both Valtteri Bottas and Felipe Massa fell in Q2.



Magnussen fought back from this for fourth row of grid

TEE/LAT

THE GRID

	1 HAMILTON MERCEDES 1m59.431s Medium
	2 VETTEL RED BULL 1m59.486s Medium
	3 ROSBERG MERCEDES 2m00.050s Medium
	4 ALONSO FERRARI 2m00.175s Medium
	5 RICCIARDO RED BULL 2m00.541s Medium
	6 RAIKKONEN FERRARI 2m01.218s Medium
	7 HULKENBERG FORCE INDIA 2m01.712s Medium
	8 MAGNUSSEN McLAREN 2m02.213s Medium
	9 VERGNE TORO ROSSO 2m03.078s Medium
	10 BUTTON McLAREN 2m04.053s Medium
	11 KVYAT TORO ROSSO 2m02.351s Medium
	12 GUTIERREZ SAUBER 2m02.369s Medium
	13 MASSA WILLIAMS 2m02.460s Medium
	14 PEREZ FORCE INDIA 2m02.511s Hard
	15 GROSJEAN LOTUS 2m02.885s Medium
	16 MALDONADO LOTUS 2m02.074s Medium
	17 SUTIL SAUBER 2m02.131s Medium
	18 BOTTAS WILLIAMS 2m02.756s Medium
	19 BIANCHI MARUSSIA 2m02.702s Medium
	20 KOBAYASHI CATERHAM 2m03.595s Medium
	21 CHILTON MARUSSIA 2m04.388s Medium
	22 ERICSSON CATERHAM 2m04.407s Medium

KEY
+3 3-place grid penalty
NB Perez did not start

➔ P30 FULL RESULTS & POINTS



Hamilton checks out as Rosberg defends from Vettel at the first turn

RACE 16:00, 30.03.2014



Lewis Hamilton's drive to victory in the Malaysian Grand Prix looked effortless, easy even. It was the kind of performance we've grown used to from Sebastian Vettel in recent times. As with Vettel's comfortable wins, it's all too easy to dismiss it as a walk in the park. After all, with the gift of the best car, anyone could turn up and cruise to victory, right?

Not a bit of it. Unlike in Melbourne, where Mercedes team-mate Nico Rosberg had a clean run to victory without having to worry about Hamilton, this was a straight fight between the two at the front. And it was a fight that Hamilton utterly dominated. From pole position he assumed the lead, stretching his advantage to over two seconds on the opening lap. He never looked back.

Rosberg endured two alarming moments in the first half-minute of

the race. At the start Vettel squeezed him towards the pitwall, legitimately given the space remaining between them when Rosberg started to cede ground. Then Rosberg had a lairy moment at Turn 3 when the rear stepped out, meaning he had to do some canny defensive driving to keep the Red Bulls at bay.

"I had a great start," said Rosberg. "With Vettel it was massively close. I closed my eyes and thought I might hit the wall, but it just worked out. Then I had a big tankslapper, so both the Red Bulls were all over the back of me and I managed to defend well. From there on, I just couldn't quite catch Lewis."

Rosberg had no way of fighting back. The gap at the chequered flag, just over 17 seconds, perhaps even flattered him, for this was a weekend on which Hamilton was supreme. He was faster over a lap, in the second and third sectors in particular. More

importantly, in hot conditions that meant Mercedes went into the race with very serious tyre-degradation concerns, Hamilton was able to look after his rears better, which speed-trap figures suggested was a consequence of running slightly more downforce. He also used less fuel, by around 3kg if the figures displayed on screen during the race were accurate. So he was faster, better on tyres, had the stronger set-up and was more efficient. Game, set and match. Hamilton made it look easy.

"I don't think any race is ever easy," said Hamilton. "Obviously there are opportunities that are presented in front of you and obviously you have to take them with both hands and today that's what I did. Looking after the car, looking after fuel, not making any mistakes, it was a massive challenge in that sense.

"I would hear that Nico had stepped up the speed, reacting to those things without damaging my tyres, so without doubt it was still a great challenge but one that I was able to do well because the car was spectacular this weekend. I'm really, really happy with a great performance from the team."

What makes this win so significant for Hamilton is that coming into the season, when it was clear that Mercedes would at least start the campaign with a big advantage, the dynamic between him and his team-mate was one of the big questions. Hamilton is the faster driver, probably

Hamilton: 'No race is ever easy. Looking after the car, the fuel, was a massive challenge'

even Rosberg would (privately) admit that. But Rosberg is plenty fast enough and has his own strengths to bring to the table, including a determination to assimilate every piece of information available to give himself the edge. Even though tyre degradation was not as serious a concern for Mercedes in the race as Friday practice had threatened, Hamilton still had to juggle those balls at the front of the race. And he did so without missing a beat. In Malaysia, he was simply the better driver on all fronts.

"It's difficult to say what the difference was," said Mercedes motorsport boss Toto Wolff. "You could see straight from the beginning that Nico had a bit of a snap [oversteer moment], and it was harder to recover from them because mid-race he came back. Lewis had a faultless race. Well, I wouldn't say faultless, because Nico was faultless as well technically, but they kept pushing each other all through the weekend. At the beginning of the weekend it was Nico, then Lewis came back, then during the race it was Lewis."

Even when Rosberg had sometimes looked faster in practice, on the ▶



Fifty-six laps later, LH enjoys his win

Red Bull switch as Vettel passes Ricciardo



HONE/LAT

► headline laps Hamilton had failed to string together three quick sectors, suggesting that the fundamental pace was there. What happened on Sunday served only to underline that.

From a world championship point of view, Hamilton's accomplished win means he lies 18 points behind Rosberg, which is why the German wasn't too disappointed with second place on a day when he had no answer for his team-mate. A real strength for Rosberg is that he knows and accepts there will be days when he is beaten and will roll with the punches. The question mark over Hamilton is whether he will react in the same way. That's something that the races to come will reveal as the pair disputes the championship lead.

Vettel might have something to say about that. The Malaysian GP encapsulated the potential shape

Vettel: 'We could have gone faster at the end of the race, but our priority was the podium'

of the world championship, for it's Red Bull that looks most threatening. Vettel crossed the line just seven seconds behind Rosberg in third place, and Daniel Ricciardo likely would have backed up his team-mate in fourth had he not been released from his final stop with the left-front wheel not attached, the first of a series of bodyblows that ruined the luckless Australian's afternoon.

Vettel held third throughout, following exactly the same three-stop strategy (three stints on the medium,

then a brief run on the slower hard tyres to the chequered flag) as the top two. After the second round of stops, he did get close enough to Rosberg to complain about fluid being flung at his car from the back of the Mercedes. But this was more than anything the consequence of excessive caution on Rosberg's part as he took it easy to ensure tyre life. He was easily able to consolidate and keep the troublesome Vettel behind. When told he needed to build a gap, he was able to do so by as much as a second per lap. That simply

underlined that there was no real battle for second, even though Vettel was only half a second adrift at one stage.

The RB10 looks strong aerodynamically, and seemed a little closer to the pace of the Mercedes in Malaysia than it had been in Australia, perhaps the consequence of a small step made with the Renault engine. With further software improvements due to come on stream rapidly, the Mercedes drivers would do well to worry more about the four-times world champion than each other, even though Vettel's proximity to the front perhaps flattered Red Bull.

"Probably Lewis could have gone faster," said Vettel. "I think we could have gone faster at the end of the race, but our priority was to make sure we secured the podium."

"We know that there's a lot we can do better, because it doesn't feel great when we are out there racing. If you go out on track and listen and look at how the cars behave on power, there's a big difference. I think it's a question of time, how soon we manage to catch up. And then we try to give them a harder time."

The paddock consensus is that this moment could come as early as the



COATES/LAT



TEE/LAT

Race unravels for Ricciardo

fifth race of the season, in Spain. The rate of progress since Vettel failed to complete a stuttering race simulation on the final day of pre-season testing in Bahrain has been astonishing. The feeling is that the Red Bull is the strongest car aerodynamically, and privately the team has no doubts that it's ahead of Mercedes in this area.

Lotus trackside operations director Alan Permane certainly sees it that way. "The Red Bull looks absolutely unbelievable and I'm convinced that when we see a few more power-unit improvements, which I know are coming and I know they will benefit from, they will give Mercedes a run for their money," he explained.

Rosberg fended off mid-race Vettel attack



COATES/LAT



Ferrari's race was low key, with Alonso a distant fourth and Raikkonen getting hit



Stevenage's finest took home the spoils

THOMPSON/GETTY

Ferrari star was more worried about Nico Hulkenberg's Force India than the Mercedes or Red Bulls ahead. After running fifth early on, he did hang onto the back of the Red Bulls, initially Vettel and then Ricciardo, but never looked like a threat.

The gap gradually inched up, equating to about two tenths of a second per lap over the race. Not a big difference, but there's cause for concern at Ferrari given there seems more obvious potential for improvement with the Renault engine. As Alonso put it, "I felt slow all the race", although practice suggested that Kimi Raikkonen might have had the pace to do better had his race not been ruined by being clipped by Kevin Magnussen on lap two, damaging the floor of the Ferrari and condemning the Finn to a long crawl back to the pits.

Hulkenberg was able to challenge Alonso for fourth thanks to a two-stop strategy, although fundamentally the car was a little slower. But the rest were nowhere. McLaren's promised half-a-second-per-lap improvement didn't put in an appearance and it was only circumstances – and a very accomplished drive – that allowed Jenson Button to finish as high as sixth.

He shouldn't have been ahead of the Williams pair of Felipe Massa and Valtteri Bottas, who were out of position thanks to again struggling in wet qualifying and spent the whole race not being able to challenge the 2009 world champion. That gave rise to Massa being given the "Valtteri is faster than you" instruction from the pitwall, which he disregarded. This grabbed the headlines but there was little sign of the kind of pace Williams had demonstrated in testing or Australia.

The race was best described as tense, rather than action-packed, but the conditions, temperatures and the relative lack of experience with the new cars played a big part in that. Sunday's Bahrain GP, a month on from testing there, will give a clearer indication of the shape of things to come. ❧



Williams pair battle Magnussen early on

COATES/LAT

Red Bull claimed the time deficit on the straights in Melbourne was a second per lap, so at Sepang it was probably more. There could be a double advantage in this, as Red Bull has had to be very conscious of drag levels when finalising aerodynamic set-up. If the Renault engine can realise the potential everyone at Viry insists is there, then the gain could be exponential. And that's a big worry for everyone at Brackley.

But those dreading the prospect of Red Bull winning a fifth consecutive world championship double should hold their horses. There is still a long way to go before it can threaten Mercedes for wins and, historically,



Massa couldn't pass Button even after race had finished!

COATES/LAT

the team that starts strongest is usually able to hang on even if its relative performance slips.

The Mercedes team itself experienced that in 2009, then in its Brawn guise, when it won six of the first seven races before sliding behind Red Bull and others in the competitive order, but still won both titles. But if Red Bull can maintain its upward trajectory, it should guarantee some great racing later in the season by

preventing the monotony of Mercedes winning week after week. In Malaysia, Rosberg had no trouble keeping Vettel at arm's length and really shouldn't have let him get so close in the first place. Give it a few months and it won't be so straightforward.

The Malaysian GP also showed how far behind the rest are. In fourth place, Fernando Alonso's deficit to the front was 35.9s (it had been 35.2s in Australia). Just as in Melbourne, the

HOW THE RACE WAS WON

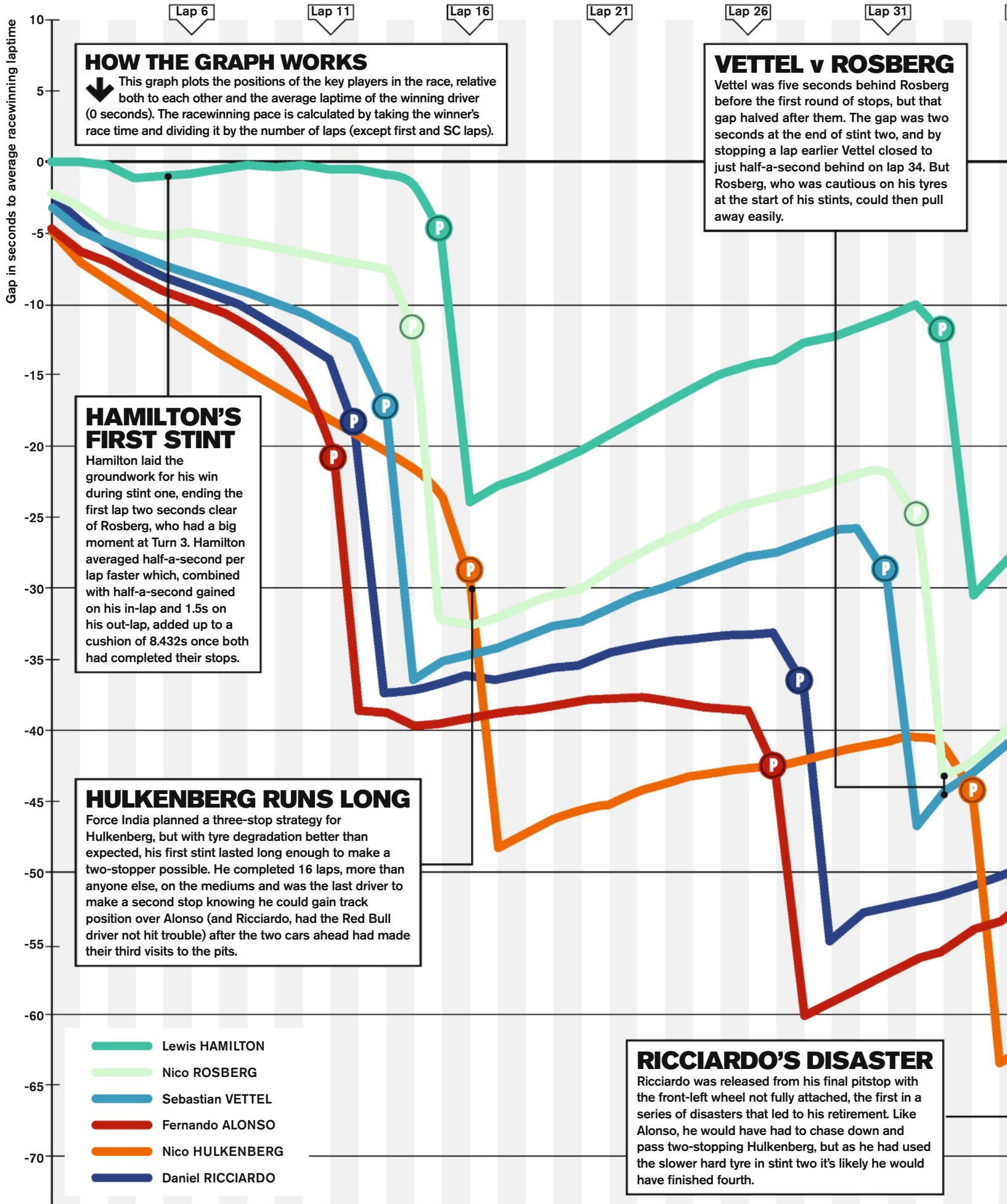

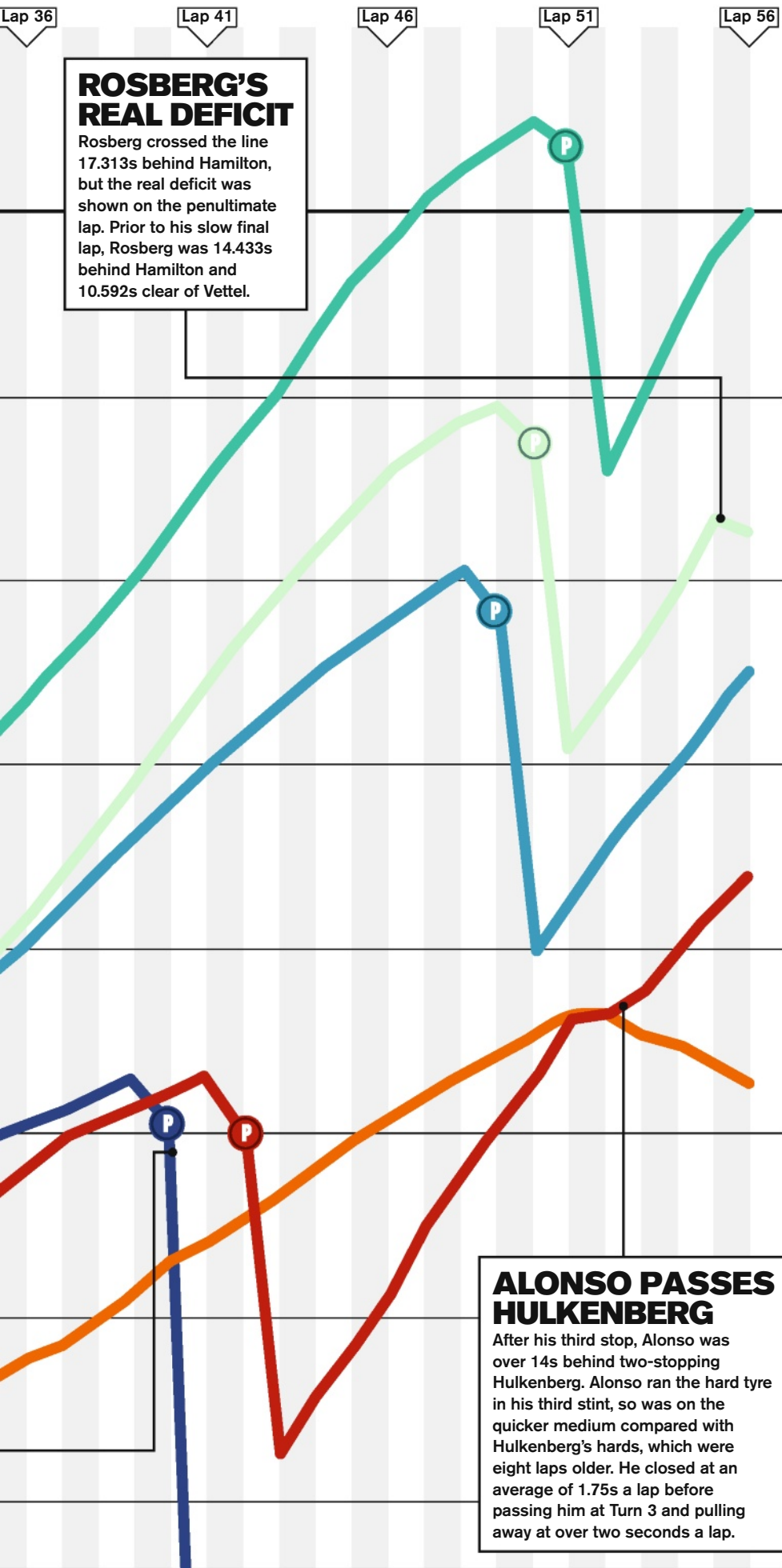

TRACKSIDE VIEW



EDD STRAW F1 EDITOR
edd.straw@haymarket.com
@eddstrawF1

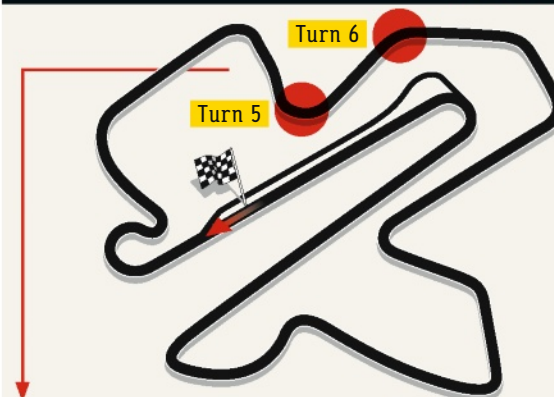

Sepang's Turn 5/6 combination allows the best cars to demonstrate their high-speed poise and brutally exposes those that are unbalanced.

The high-speed left-hand entry (Turn 5) transitions rapidly into the fast right-hander (Turn 6). Watching the Mercedes, the Red Bull or the Ferrari through here on their medium-tyre qualifying simulations and it's clear that, dynamically, these cars are strong. Sebastian Vettel is able to keep the car relatively tight to the kerb at the exit of the left-hander, but as he rolls off the lock the weight shifts effortlessly from one side of the car to the other and the rear stays planted. Once again, the RB10 proves its aerodynamic credentials.

As you work your way down the field, the transition gets less and less clear, with drivers having to make an increasing number of corrections and sacrifice a little mid-sequence speed to keep the rear in line and avoid compromising Turn 6. The Williams is well-behaved, the Toro Rosso a little uncertain but consistent, the Sauber iffy. But with the Lotus, it's clear that the car is controlling the driver and not the other way round.

'With Lotus, it's clear the car is controlling the driver and not the other way round'

The oversteer is obvious, with constant inputs to the steering and throttle to keep a car determined to throw itself backwards over the grass while simultaneously trying to carry enough speed to be fast enough. Laid bare in a few seconds is just how little work the Enstone team has been able to do on the car dynamically while troubleshooting its many problems.

"It was so hard," said Maldonado. "But it was the first real time in the car with the track and we are trying to adapt. It's quite loose, especially the rear."

The Lotus will improve. But the contrast between the best cars shows just how far the team has to go to get anywhere near challenging for podium finishes.



Maldonado wrestles the "loose" Lotus E22

STORIES OF THE RACE

Rounding up the action from the Malaysian GP

EDD STRAW
F1 EDITOR



Massa ignores Williams team-order call

FELIPE MASSA DISREGARDED A TEAM ORDER to let team-mate Valtteri Bottas past during the closing stages of the race.

The Brazilian had spent much of the last stint stuck behind seventh-placed Jenson Button. As the McLaren was strong on the exit of the slow Turns 14 and 15, which lead onto the main straights, he was unable to attack and Williams wanted to give Bottas the chance to have a go. Massa insisted he was right to ignore the order on the basis that he does not believe the Finn would have been able to challenge Button.

"What I did was correct," said Massa. "I'm sure the result would not have changed even if I had let him by, so it's the same. What's happened today was not what I expected, but what I did was correct."

"I expect these things to happen [only] at the right time. I have clarified my situation. I have no problem and I feel really relaxed inside the team."

Bottas was clearly unhappy with Massa's refusal to let him have a go at Button, although he was wary of admitting this in public. Bottas had been told to hold station behind Massa during the first stint even though he was quicker. On the final two laps, Bottas was told he could no longer pass Massa.

"We are going to talk through it with the team and analyse what happened and what we need to do next time in similar situations."

Williams chief test and support engineer Rod Nelson stressed that the orders were issued based on race situation, not to favour one driver.

"He [Massa] did not do what we would have preferred him to do," said Nelson. "We thought that it would be good to give Valtteri a go at getting past Jenson. Then, if he hadn't achieved that within two or three laps, we would have swapped our drivers over again and everyone would have been happy. It's not team orders, it's a strategic decision based on the relative performance of both cars."

The team held an in-depth discussion with both drivers after the race. "It's now been addressed," said Nelson.

BOTTAS'S CLOSING PACE

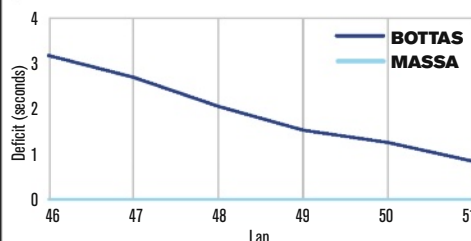

In the five laps before reaching DRS range during the final stint, Bottas was 0.467s per lap faster than Massa.



24



Vettel pushes Rosberg over towards pitwall

Rosberg criticises Vettel start squeeze

NICO ROSBERG CRITICISED SEBASTIAN VETTEL for pushing him towards the pitwall at the start of the race.

The Mercedes driver made a good start from third on the grid. Vettel moved across from the left side of the grid to defend and Rosberg feared that he was going to end up in the pitwall. The pair had a public disagreement during the post-race press conference.

"I had a really good start, so I was happy about that because it's not so easy this year," said Rosberg. "It felt great and I got away well and then Sebastian, I thought he was going to

put me right into the wall. But he stopped just before, so thank you for that."

Vettel said: "I had a similar experience last year," referring to when he was squeezed towards the wall while taking the lead from Red Bull team-mate Mark Webber.

"That doesn't make it right to do it again," Rosberg responded. "My heart skipped a beat a little bit but I kept right on it. It was OK anyway, it wasn't that bad."

The stewards did not take any interest in the incident as Rosberg had enough room to get past.

Alonso and Kvyat in qualifying collision

FERNANDO ALONSO AND DANIIL KVYAT ESCAPED censure by the stewards after colliding at Turn 4 early in Q2.

Alonso started the session on intermediate rubber and was struggling for grip when Kvyat, on wets, caught him. The Russian went up the inside of Alonso, who hadn't seen him and turned in. Kvyat locked up when he touched the kerb and slid into Alonso.

"I didn't see him coming," said Alonso. "Obviously, it was a little bit of an aggressive move on the out-lap with that sort of visibility."

Alonso broke his front-left trackrod in the incident, but Ferrari replaced it quickly to allow him to return to the track later in the 15-minute session.

"It's very simple," said Kvyat of the clash. "I thought he was letting me past, but in the end it's OK."

The stewards concluded that neither driver was "wholly or predominantly to blame for the incident".



Kvyat collided with Alonso in wet Q2 session



DUNBAR/LAT



Grosjean came close to scoring

TEE/LAT

Grosjean close to points for Lotus

ROMAIN GROSJEAN MISSED OUT ON SCORING the Lotus team's first point of the season by just two seconds after finishing 11th.

This was a significant step forward for Lotus, as this was the first time the troublesome twin-tusk E22 has completed a full race distance. Grosjean was chasing Daniil Kvyat's Toro Rosso in the closing stages running the hard tyre, but as Kvyat was running mediums that were six laps old the team suspects it would have been possible to pass the Russian for the final point but for a late-race diffuser problem.

"Unfortunately, on lap 48 something happened to the diffuser and Romain lost 17-20 points of downforce," said Lotus trackside operations director Alan Permane. "He was catching the Toro Rosso and we were probably a bit kinder on our tyres than them."

The diffuser problem would have cost as much as a second a lap according to the team.

Massa was told "Valtteri is faster than you" on radio

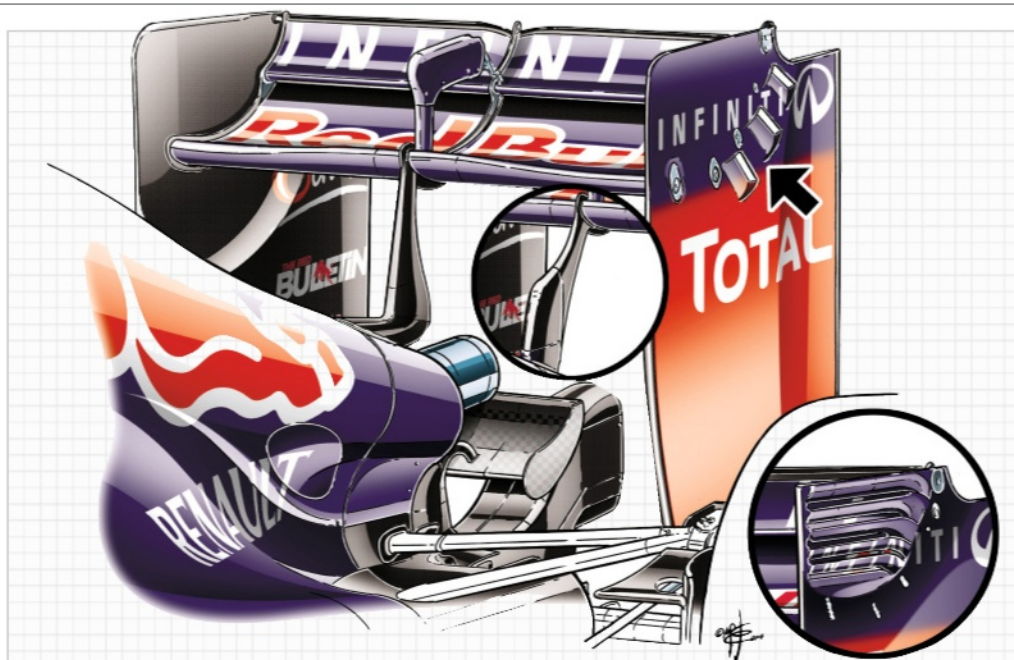

Red Bull sports new rear-wing upgrades

RED BULL INTRODUCED A REAR WING WITH new endplates and a modified support pillar in Malaysia. **GARY ANDERSON:** "This is an interesting change. The usual louvres you see in the endplates are on the top surface of the wing (inset right). They allow the high pressure there to spill through to the outside of the wing. This reduces the high pressure that triggers the vortex off the top rear corner of the wing endplate, which creates drag. You lose downforce but gain efficiency.

"But Red Bull has put three louvres in the endplate connected to the undersurface of the wing (black arrow). The low-pressure area under the wing will drag more air through these louvres to improve efficiency. "Red Bull has also tidied its rear-wing support pillar. Before it was a longer cord and leaned forward, but this has been refined with a longer cord base reducing as it rises up to join the underside of the wing. This will disturb the airflow to the undersurface of the wing less."

Q&A

ALAN PERMANE

LOTUS TRACKSIDE OPERATIONS DIRECTOR

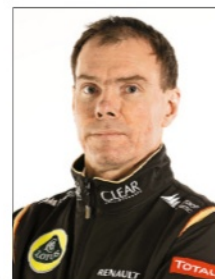

Considering where you were before, that must go down as a good weekend?

We're on a massively steep learning curve in the right direction, but it's by no means good. A couple of weeks ago in the Bahrain tests, we couldn't get the thing to run at all. In Melbourne we were all over the place and here on the first day we still were. By the standards we've had, we had a decent Saturday and we got to the end of the race. There are glimmers of hope and the car looks pretty competitive in the middle sector, which is the downforce sector.

Do you feel you have reached a 'zero' point where you can work on the car without constantly being tripped up by problems?

Yes, I hope so. But Pastor [Maldonado] had an awful weekend because we didn't give him a car to run with on Friday or in the race because of turbo problems, so there are things tripping us up.

Was there a step with the engine here?

Yes, but that was in running it, mapping, driveability. There are things Red Bull have got this weekend that we tried on Friday but couldn't make work. Once we have those, we'll have that little step that they had here.

STORIES OF THE RACE



Ricciardo's race was ruined in pits

Pitstop blunder foils Ricciardo points bid

DANIEL RICCIARDO WAS ON COURSE TO FINISH fourth in the race before he was released from his final pitstop with the left-front wheel not properly attached.

He noticed the wheel was loose and stopped, but by the time he was dragged back to the pit box and sent out again, 85 seconds had been lost.

"It went on OK, it was done up, but the gunman felt that something wasn't quite right," said team principal Christian Horner. "He was going to check and put an extra couple of turns into it, but the latch on the gun had switched back across so he effectively undid it."

A front-wing pillar then broke soon after, either from damage in the pitstop or rattling over a kerb, forcing him to return to the pits, followed by a 10-second penalty for an unsafe release. With no chance of points, he retired.

Ricciardo was also hit with a 10-place grid penalty for the Bahrain Grand Prix. This is a mandatory punishment for an unsafe release in the race.

It's fun being up there and fighting for the top few spots, but then we had a problem at the last stop and then we had a puncture. It went from looking good to looking pretty bad in a short period of time



Daniel Ricciardo on how his day quickly turned around



Red Bull's pitcrew tend to the stricken Ricciardo RB10

THOMPSON/GETTY

New penalties make first F1 appearance

VALTTERI BOTTAS, KEVIN MAGNUSSEN AND Jules Bianchi were all hit with superlicence penalty points for offences during the Malaysian GP weekend.

Bottas was given two points for impeding Daniel Ricciardo during Q2, which also earned him a three-place grid penalty. Bianchi received two for tipping Pastor Maldonado's Lotus into a spin at Turn 4 on the opening lap, which he blamed on a puncture picked up when he clashed with Jean-Eric Vergne, while Magnussen landed two for hitting Kimi Raikkonen on lap two. Drivers are given a one-race ban if they accumulate 12 points over a 12-month period.



Raikkonen was hit by chasing Magnussen

The new five-second penalty, served during pitstops or, if issued after a driver has made their final stop, added to total race time, also made its debut. Bianchi and Magnussen

were both given the penalties for their early-race incidents. Only Magnussen served his, as Marussia driver Bianchi retired before he was able to do so.

Magnussen takes rap for Kimi clash

KIMI RAIKKONEN HELD KEVIN MAGNUSSEN responsible for his disappointing 12th-place finish.

Raikkonen had gone well during free practice thanks to tweaks to the set-up of his Ferrari designed to give him the strong front-end feel he demands of a car, but in wet qualifying he struggled for grip and ended up over a second off Ferrari team-mate Fernando Alonso and sixth on the grid.

Raikkonen was running seventh when his right-rear was clipped by Magnussen at Turn 1 on lap two, giving him a puncture.

"I just heard that his front wing hit me and damaged my rear wheel," said Raikkonen. "I didn't feel anything, but obviously it destroyed our race. I had some damage after that, so we lost some downforce because the tyre damaged the floor."

Magnussen, who finished ninth, suffered front-wing damage in the incident, which cost him time during the first stint before his nose was changed at the first pitstop. He was held responsible for the clash with Raikkonen by the stewards and was hit with a five-second penalty, served at his second stop.

"I'm really disappointed with the race," said Magnussen. "Formula 1 races are long and you shouldn't make a mistake like that in the first corner."



RAIKKONEN v ALONSO

The Finn outpaced his team-mate during dry free practice, but couldn't match him during wet qualifying

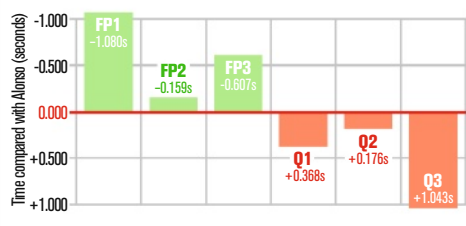

Software woe stops Perez starting race

FORCE INDIA DRIVER SERGIO PEREZ WAS unable to start the race after a software problem developed during his reconnaissance laps.

Perez endured a difficult weekend, losing FP1 to a fuel-system problem. He complained of a brake-balance problem that led to him repeatedly locking the rears during wet qualifying. He was set to start 14th, but a gearbox problem manifested itself and put the car into the safety 'limp home' mode. The team attempted to reset the system but proved unable to do so.

"We got a gearbox issue and we just couldn't get it unlocked in time," said deputy team principal Bob Fernley. "There are still glitches, everybody suffers them at some point. It's just unfortunate for Checo that it was then."



DRAWING BOARD



Gary Anderson, technical consultant

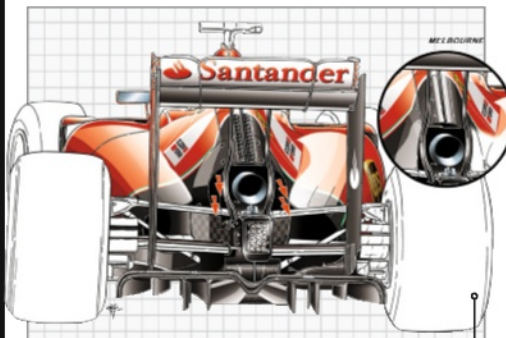

Ferrari strikes a spinal chord

→ Ferrari has the flared bodywork opening around the exhaust, but it has also taken an interesting approach with the back of the engine cover.

It has added a series of small louvres that run down the spine of the engine cover, instead of having a large hole as it did last year. These work quite well because you can keep the surface airflow attached. The risk if you don't do this is that you can end up sucking the airflow that is meant to stay outside into it. Years ago, Williams had this problem on one of its ground-effect cars with a radiator duct in the sidepod that was allowing airflow in to get sucked under the floor.

The louvres create a surface for the airflow to attach to and ensure that the exit facing rearwards is connected to the low-pressure area at the rear of the car to pull air through. It's an elegant solution.



Lotus tries new cooling concept

→ The lower red arrow indicates a hole extracting air out of the sidepods of the Lotus. The regulations allow openings up to 100mm above the reference plane. This is about 50mm from the step plane, which is itself 50mm above the reference plane. This will aid the cooling of whatever is in the sidepod.

I'm not 100 per cent convinced it's to help the radiator cooling. Perhaps it's for the electronic control units of the ERS, which is logical considering the problems Lotus has had. But it will hurt car performance because most cars have a turned up section on the outer edge of the floor to act as a trip to make sure you get more downforce from the front part of the underfloor; this doesn't allow that to happen.

The upper red arrow indicates four louvred holes to help the cooling of the front of the radiator.

Mercedes shows off its cooling flare

→ Mercedes ran a cooling package that it was able to optimise based on data gathered during testing.

The flared bodywork (1) allows greater cooling airflow (red arrows) to exit at the back of the car, which is a relatively neutral place to have this aerodynamically. Inside, you can see what is probably the gearbox or gearbox/hydraulic cooler (3). There are restrictions on where you can have cooling exits on the car, so Mercedes has opened up the exit beside the driver's head (2), which helps efficiency of the front corner of the radiator by creating a low-pressure area to help drag air through it.

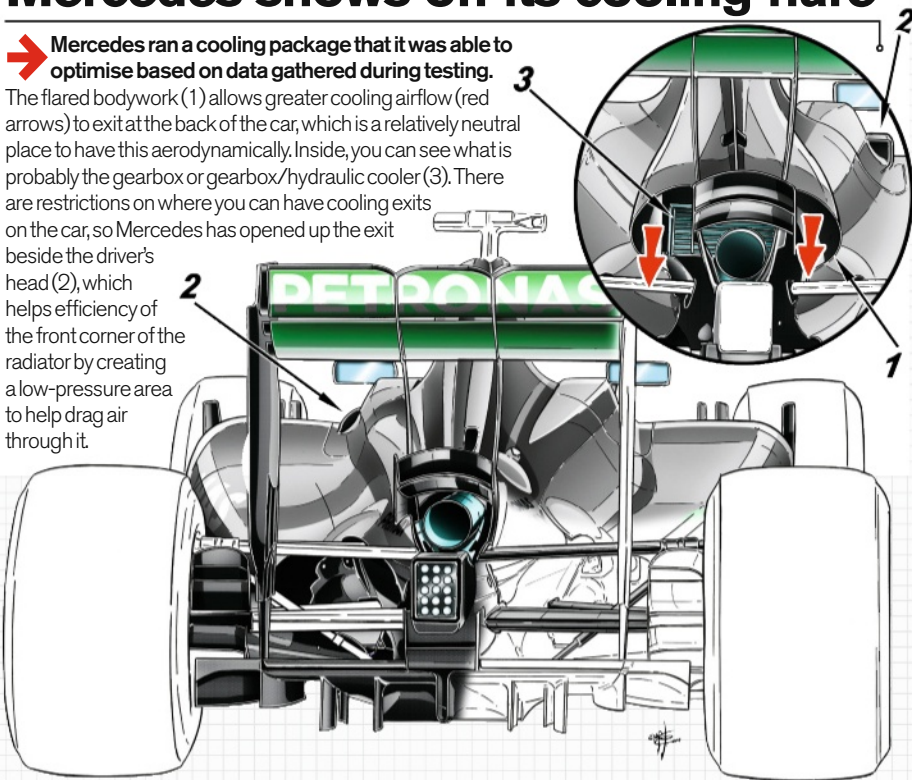

TEAM BY TEAM

RED BULL



RED BULL-RENAULT RB10

1
9/10

SEBASTIAN VETTEL

Start: 2nd **Finish:** 3rd
Strategy: 3 stops (medium/medium/medium/hard)

3
8/10

DANIEL RICCIARDO

Start: 5th **Finish:** DNF
Strategy: retired (medium/medium/hard/medium/hard)

The RB10 again looked impressive in the downforce-dependent part of the track, but Vettel would certainly not have been so close to Hamilton in qualifying had it been dry. But with further software tweaks to the Renault engine, plus a few aerodynamic upgrades, the car was more competitive. On race pace in particular, the car seemed much quicker and Vettel and Ricciardo would have finished third and fourth but for the Australian being sent out from his pitstop with a loose front-left, the start of a series of disasters for him. Vettel drove well, but didn't have the speed to challenge Rosberg. If the engine can match the aero, the RB10 might prove a Merc-beater after all.

MERCEDES



MERCEDES F1 W05

6
8/10

NICO ROSBERG

Start: 3rd **Finish:** 2nd
Strategy: 3 stops (medium/medium/medium/hard)

44
10/10

LEWIS HAMILTON

Start: 1st **Finish:** 1st
Strategy: 3 stops (medium/medium/medium/hard)

A first one-two since Juan Manuel Fangio led home Piero Taruffi at Monza in 1955, Mercedes locked out the top two steps of the podium. The F1 W05 was the class of the field at Sepang and winner Hamilton certainly appeared to have pace in reserve had he needed it. Concerns about tyre degradation arose on Friday, but in the race things were not as troublesome as anticipated and Mercedes was able to control things. Hamilton was the class of the field having made impressive strides since Friday practice, particularly on fuel consumption. Rosberg drove well, but wasn't able to challenge him and had to focus his attention more on keeping Vettel's Red Bull at arm's length.

FERRARI



FERRARI F14 T

7
7/10

KIMI RAIKKONEN

Start: 11th **Finish:** 12th
Strategy: 3 stops (medium/medium/hard/medium)

14
7/10

FERNANDO ALONSO

Start: 4th **Finish:** 4th
Strategy: 3 stops (medium/medium/hard/medium)

Just as in Australia, Ferrari proved to be 'thereabouts' rather than 'there' in Malaysia. Things had looked more promising on Friday, when Raikkonen finally appeared to have a front end that gave him the feel and grip he needed. Rain in qualifying undid him, but Alonso came through to fourth after a rapid replacement of his front-left trackrod following the clash with Kvyat during Q2. In the race, Alonso spent the afternoon ensuring he beat Hulkenberg, but he couldn't quite keep the Red Bulls within range and had a so-so weekend. Engine improvements will be needed to get closer to Mercedes and even to be able to challenge Red Bull in the coming races.

SAUBER



SAUBER-FERRARI C33

21
6/10

ESTEBAN GUTIERREZ

Start: 12th **Finish:** DNF
Strategy: retired (medium/medium/hard)

99
6/10

ADRIAN SUTIL

Start: 17th **Finish:** DNF
Strategy: retired (medium/hard/hard)

Sauber focused its efforts on trying to get the engine working better with its car and improving set-up and tyre use. The C33 is believed to be around 20kg overweight, and is some way off showing the pace needed to be a serious points contender. In dry conditions, the drivers struggled badly for grip, with the problem even worse in the wet in qualifying. Sutil didn't bank a strong enough laptime early in Q1 to get through and the late red flag stopped him having a chance of redemption. Gutierrez acquitted himself well in qualifying, but didn't have Sutil's pace in the race. The Mexican retired with a gearbox problem, while Sutil stopped with a loss of electrical power.

TORO ROSSO



TORO ROSSO-RENAULT STR9

25
8/10

JEAN-ERIC VERGNE

Start: 9th **Finish:** DNF
Strategy: retired (medium/hard/medium/retired)

26
8/10

DANIIL KVYAT

Start: 11th **Finish:** 10th
Strategy: 3 stops (medium/medium/hard/medium)

Toro Rosso had a decent weekend and always looked to have the pace to slip into Q3 should circumstances offer the chance. Jean-Eric Vergne did so, qualifying ninth, with Kvyat a quarter of a second behind in 10th. Vergne's 2013 bad luck returned in the race, with a loss of engine power dropping him down the order on the run to the first corner, whereupon he tried to squeeze between Bianchi and Kobayashi, clipping the Marussia and damaging his wing. He soon retired with engine problems. Kvyat drove with immense maturity to bank a second successive points finish, although Grosjean's late-race problems saved him having to mount a serious defence in the closing stages.

WILLIAMS



WILLIAMS-MERCEDES FW36

19
7/10

FELIPE MASSA

Start: 13th **Finish:** 7th
Strategy: 3 stops (medium/medium/medium/hard)

77
7/10

VALTTERI BOTTAS

Start: 18th **Finish:** 8th
Strategy: 3 stops (medium/medium/medium/hard)

The Williams was not as competitive in Malaysia as it had been in Australia, with the drivers complaining that the track configuration played to its weaknesses, in particular a lack of traction and downforce. But it was still plenty quick enough to make Q3 in dry conditions. But in the wet, the car is poor so Massa and Bottas were nowhere near. In the race, Massa led home Bottas in seventh, but the car was plenty quick enough to beat Button's McLaren and at least give Hulkenberg something to think about, so all in all it was a disappointing weekend. It was made all the more disappointing by Massa refusing to heed a team order to let Bottas past.

For the reasons behind the driver weekend ratings, visit AUTOSPORT.COM

LOTUS



LOTUS-RENAULT E22

8
8/10

ROMAIN GROSJEAN

Start: 15th Finish: 11th
Strategy: 3 stops (medium/medium/medium/hard)

13
6/10

PASTOR MALDONADO

Start: 16th Finish: DNF
Strategy: 0 stops (medium)

It was the same old story for Lotus on Friday, completing just 20 laps thanks to engine and gearbox problems for Grosjean and a blown turbo for Maldonado. But on Saturday things seemed to run broadly to plan and allowed the team to undertake work that stretched beyond simply trying to get the car to run. Grosjean might have slipped into Q3 had he changed tyres at the right time in qualifying and might have beaten Kyvyat to 10th had he not picked up some diffuser damage that cost him as much as a second a lap late on. Maldonado retired early with a turbo-intake problem, which was unrelated to being clobbered by Bianchi on lap one.

McLAREN



McLAREN-MERCEDES MP4-29

20
6/10

KEVIN MAGNUSSEN

Start: 8th Finish: 9th
Strategy: 3 stops (medium/medium/medium/hard)

22
9/10

JENSON BUTTON

Start: 10th Finish: 6th
Strategy: 3 stops (medium/medium/medium/hard)

While strong in the slow corners, the MP4-29 is not so good in the quick stuff. That, combined with high temperatures that required hefty, downforce-sapping cooling modifications and contributed to tyre troubles, added up to a difficult weekend. There was little sign of the promised half-second performance gain. Button excelled in the race after a gamble on intermediate rubber backfired in Q3, and kept the quicker Williams cars behind him in the race to finish a car-flattering sixth. Magnussen's inexperience told in his lap-two clash with Raikkonen that earned him a five-second penalty and damaged his front wing, which was changed at his first stop. The Dane recovered respectably to ninth.

FORCE INDIA



FORCE INDIA-MERCEDES VJM07

11
6/10

SERGIO PEREZ

Start: 14th (DNS) Finish: DNS
Strategy: DNS

27
9/10

NICO HULKENBERG

Start: 7th Finish: 5th
Strategy: 2 stops (medium/medium/hard)

The Silverstone-based team headed to Sepang with only very minor car tweaks, with one of the priorities being to improve the rear traction on corner exit by softening off the rear suspension. Hulkenberg reaped the rewards, qualifying a strong seventh in wet qualifying and then becoming the only frontrunner to pull off a two-stop strategy. This did get him ahead of Alonso, but he could do nothing about the charging Ferrari in the closing stages. Perez had a disastrous weekend, with fuel-system problems on Friday and then rear-brake-locking issues in qualifying. On his reconnaissance lap, a gearbox software problem manifested itself so he was unable to start.

MARUSSIA



MARUSSIA-FERRARI MR03

4
5/10

MAX CHILTON

Start: 21st Finish: 15th
Strategy: 3 stops (medium/medium/medium/hard)

17
6/10

JULES BIANCHI

Start: 19th Finish: DNF
Strategy: retired (medium/medium)

Unlike in Australia, Marussia managed to get some consistent running through the weekend and made good steps both with engine-related software and set-up fine-tuning during Friday and Saturday. In qualifying, while Bianchi did a decent job, Chilton ended up having to convert a planned 'off' lap (for avoiding ERS power build-up) into nailing a time, which contributed to his deficit. In the race, Bianchi clouted Maldonado, blaming a puncture sustained when Vergne hit him, and soon retired, while Chilton didn't show the expected pace and finished behind Ericsson. The team could at least be satisfied with the progress made with the car, which still looks to have the legs of Caterham.

CATERHAM



CATERHAM-RENAULT CT05

9
7/10

MARCUS ERICSSON

Start: 22nd Finish: 14th
Strategy: 3 stops (medium/medium/medium/hard)

10
8/10

KAMUI KOBAYASHI

Start: 20th Finish: 13th
Strategy: 2 stops (medium/medium/hard)

Another tough weekend for Caterham, which again had more than its fair share of problems in practice, with Kobayashi in particular suffering with an energy-store problem then an oil leak from the clutch on Friday. But on Saturday, things ran more smoothly, save for Ericsson making a rookie mistake and spinning into the barrier at high speed after dropping a wheel onto a damp kerb. In the race, Ericsson made amends and did a solid job, while Kobayashi drove with tremendous discipline and good racecraft to finish a very respectable 13th. Considering the lack of set-up work completed to date, the car has plenty more to give, although Q2 pace in dry conditions remains some way off.



STANDOUT PERFORMANCE

Lewis Hamilton

Winning in the best car might not seem anything to write home about, but Hamilton did everything right during the weekend, learned from the weaknesses on Friday and comfortably outperformed Rosberg. His banker lap was good enough to take pole position, while in the race he pulled a two-second margin on the opening lap and never looked back, combining his pace with good tyre and fuel management. A textbook performance that could have led to an even more dominant victory.

"It's quite special when you get a one-two. I've not had that many in my career and so that makes it even more special. A great day"

RESULTS

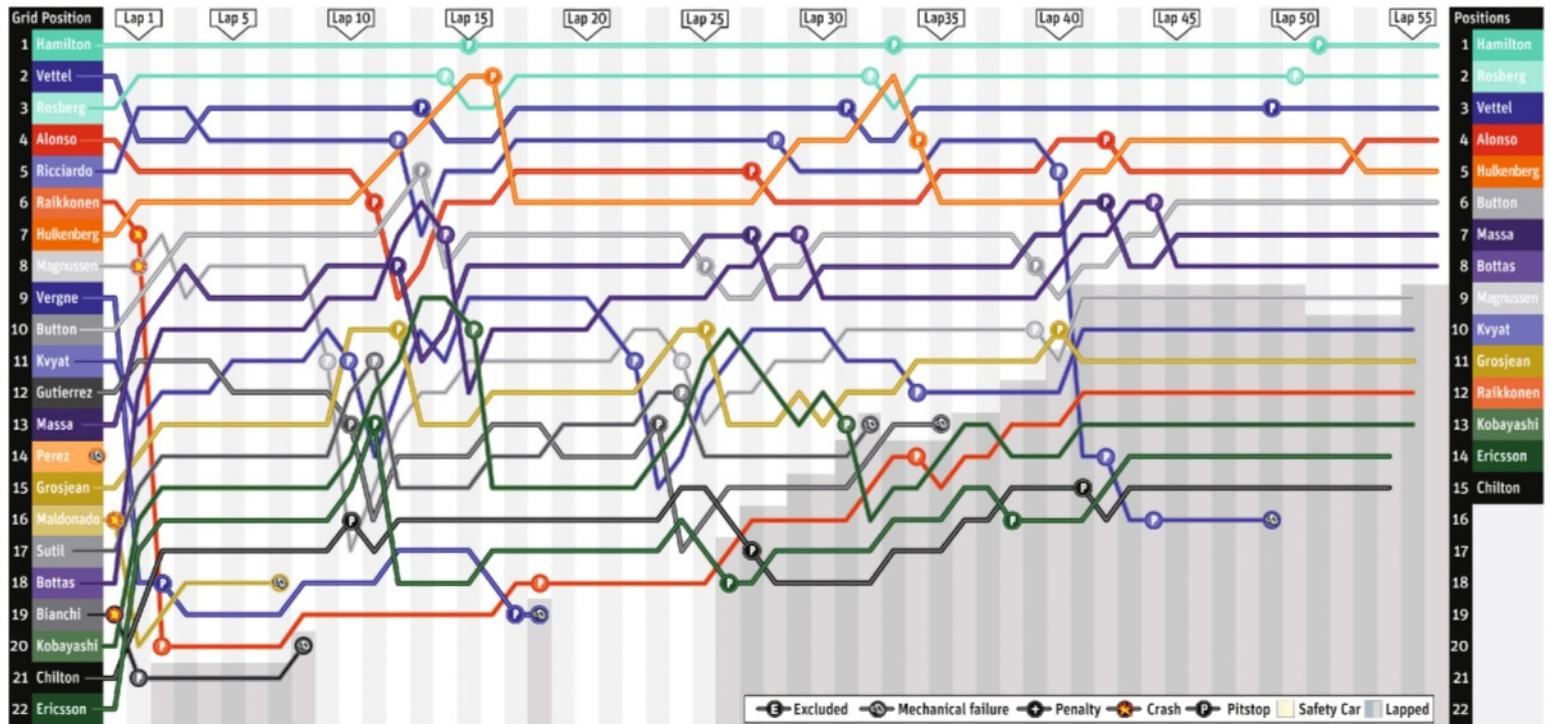

PRACTICE 1: Friday

POS	DRIVER	TIME
1	HAMILTON	1m40.691s
2	RAIKKONEN	1m40.843s
3	ROSBERG	1m41.028s
4	BUTTON	1m41.111s
5	MAGNUSSEN	1m41.274s
6	VERGNE	1m41.402s
7	VETTEL	1m41.523s
8	HULKENBERG	1m41.642s
9	MASSA	1m41.686s
10	BOTTAS	1m41.830s
11	ALONSO	1m41.923s
12	RICCIARDO	1m42.117s
13	SUTIL	1m42.365s
14	KVYAT	1m42.869s
15	GUTIERREZ	1m42.904s
16	BIANCHI	1m43.825s
17	ERICSSON	1m45.775s
18	CHILTON	1m46.911s
19	KOBAYASHI	1m51.180s
20	PEREZ	no time
21	MALDONADO	no time
22	GROSJEAN	no time

PRACTICE 2: Friday

POS	DRIVER	TIME
1	ROSBERG	1m39.909s
2	RAIKKONEN	1m39.944s
3	VETTEL	1m39.970s
4	HAMILTON	1m40.051s
5	ALONSO	1m40.103s
6	MASSA	1m40.112s
7	RICCIARDO	1m40.276s
8	BUTTON	1m40.628s
9	BOTTAS	1m40.638s
10	HULKENBERG	1m40.691s
11	VERGNE	1m40.777s
12	MAGNUSSEN	1m41.014s
13	SUTIL	1m41.257s
14	KVYAT	1m41.325s
15	GUTIERREZ	1m41.407s
16	PEREZ	1m41.671s
17	GROSJEAN	1m42.531s
18	CHILTON	1m43.638s
19	BIANCHI	1m43.752s
20	ERICSSON	1m45.703s
21	KOBAYASHI	no time
22	MALDONADO	no time

PRACTICE 3: Saturday

POS	DRIVER	TIME
1	ROSBERG	1m39.008s
2	HAMILTON	1m39.240s
3	RAIKKONEN	1m40.156s
4	VETTEL	1m40.387s
5	HULKENBERG	1m40.523s
6	RICCIARDO	1m40.686s
7	ALONSO	1m40.736s
8	MASSA	1m40.781s
9	BOTTAS	1m40.891s
10	PEREZ	1m41.029s
11	KVYAT	1m41.182s
12	VERGNE	1m41.441s
13	SUTIL	1m41.552s
14	GUTIERREZ	1m42.041s
15	GROSJEAN	1m42.749s
16	MALDONADO	1m43.539s
17	CHILTON	1m43.977s
18	BIANCHI	1m44.170s
19	ERICSSON	1m44.457s
20	KOBAYASHI	1m46.015s
21	BUTTON	2m05.555s
22	MAGNUSSEN	no time

Weather: 32C, humid

Weather: 34C, very humid

Weather: 30C, cLOUDy



COATES/LAT

QUALIFYING TIMES

POS	DRIVER	QUALIFYING 1	QUALIFYING 2	QUALIFYING 3
1	HAMILTON	1m57.203s (2)	1m59.041s (1)	1m59.431s
2	VETTEL	1m57.654s (3)	1m59.399s (2)	1m59.486s
3	ROSBERG	1m57.183s (1)	1m59.445s (3)	2m00.050s
4	ALONSO	1m58.889s (5)	2m01.356s (6)	2m00.175s
5	RICCIARDO	1m58.913s (6)	2m00.147s (4)	2m00.541s
6	RAIKKONEN	1m59.257s (7)	2m01.532s (7)	2m01.218s
7	HULKENBERG	1m58.883s (4)	2m00.839s (5)	2m01.712s
8	MAGNUSSEN	2m00.358s (12)	2m02.094s (9)	2m02.213s
9	VERGNE	2m01.689s (16)	2m02.096s (10)	2m03.078s
10	BUTTON	2m00.889s (13)	2m01.810s (8)	2m04.053s
11	KVYAT	2m01.175s (15)	2m02.351s	-
12	GUTIERREZ	2m01.134s (14)	2m02.369s	-
13	MASSA	2m00.047s (9)	2m02.460s	-
14	PEREZ	2m00.076s (10)	2m02.511s	-
15	BOTTAS	1m59.709s (8)	2m02.756s	-
16	GROSJEAN	2m00.202s (11)	2m02.885s	-
17	MALDONADO	2m02.074s	-	-
18	SUTIL	2m02.131s	-	-
19	BIANCHI	2m02.702s	-	-
20	KOBAYASHI	2m03.595s	-	-
21	CHILTON	2m04.388s	-	-
22	ERICSSON	2m04.407s	-	-

Weather: 31C, rain

QUALIFYING STATISTICS

	HEAD TO HEAD		
VETTEL	1	1	RICCIARDO
ROSBERG	0	2	HAMILTON
RAIKKONEN	0	2	ALONSO
GROSJEAN	2	0	MALDONADO
MAGNUSSEN	2	0	BUTTON
PEREZ	0	2	HULKENBERG
GUTIERREZ	1	1	SUTIL
VERGNE	2	0	KVYAT
MASSA	2	0	BOTTAS
CHILTON	1	1	BIANCHI
ERICSSON	0	2	KOBAYASHI



TEE/LAT

POLE POSITION TROPHY

HAMILTON	AUS MAL 2
----------	---------------



HONE/LAT

SUPERLICENCE PENALTY POINTS

Drivers	1	2	3	4	5	6	7	8	9	10	11	12
Bianchi	X	X										
Bottas	X	X										
Magnussen	X	X										

Anyone who gets to 12 points will be suspended for one race

RACE: 56 LAPS - 192.888 MILES

POS	DRIVER	TEAM	LAPS	TOTAL TIME	FASTEST LAP	PITSTOPS	TIME IN PITS	GRID
1	LEWIS HAMILTON	MERCEDES	56	1h40m25.974s	1m43.066s	3	1m14.384s	1
2	NICO ROSBERG	MERCEDES	56	+17.313s	1m43.960s	3	1m14.664s	3
3	SEBASTIAN VETTEL	RED BULL-RENAULT	56	+24.534s	1m44.289s	3	1m14.346s	2
4	FERNANDO ALONSO	FERRARI	56	+35.992s	1m44.165s	3	1m13.329s	4
5	NICO HULKENBERG	FORCE INDIA-MERCEDES	56	+47.199s	1m45.982s	2	50.223s	7
6	JENSON BUTTON	McLAREN-MERCEDES	56	+1m23.691s	1m46.039s	3	1m14.393s	10
7	FELIPE MASSA	WILLIAMS-MERCEDES	56	+1m25.076s	1m44.897s	3	1m13.740s	13
8	VALTTERI BOTTAS	WILLIAMS-MERCEDES	56	+1m25.537s	1m45.475s	3	1m14.482s	18
9	KEVIN MAGNUSSEN	McLAREN-MERCEDES	55	-1 lap	1m45.373s	3	1m32.192s	8
10	DANIIL KVYAT	TORO ROSSO-RENAULT	55	-1 lap	1m46.695s	3	1m17.871s	11
11	ROMAIN GROSJEAN	LOTUS-RENAULT	55	-1 lap	1m46.224s	3	1m16.377s	15
12	KIMI RAIKKONEN	FERRARI	55	-1 lap	1m45.129s	3	1m15.062s	6
13	KAMUI KOBAYASHI	CATERHAM-RENAULT	55	-1 lap	1m47.753s	2	53.629s	20
14	MARCUS ERICSSON	CATERHAM-RENAULT	54	-2 laps	1m47.500s	3	1m22.585s	22
15	MAX CHILTON	MARUSSIA-FERRARI	54	-2 laps	1m48.249s	3	1m22.677s	21
R	DANIEL RICCIARDO	RED BULL-RENAULT	49	front wing	1m44.675s	5	3m47.990s	5
R	ESTEBAN GUTIERREZ	SAUBER-FERRARI	35	gearbox	1m47.782s	2	55.745s	12
R	ADRIAN SUTIL	SAUBER-FERRARI	32	power unit	1m48.040s	2	51.491s	17
R	JEAN-ERIC VERGNE	TORO ROSSO-RENAULT	18	turbo	1m48.527s	2	1m12.227s	9
R	JULES BIANCHI	MARUSSIA-FERRARI	8	accident damage	1m51.473s	1	52.836s	19
R	PASTOR MALDONADO	LOTUS-RENAULT	7	power unit	1m50.929s	-	-	16
DNS	SERGIO PEREZ	FORCE INDIA-MERCEDES	0	gearbox	-	-	-	14

Weather: 33C, sunny. Winner's average speed: 115.233mph. Fastest lap: Hamilton 1m43.066s (120.310mph) on lap 53. Lap leader: 1-56 Hamilton. Bottas dropped three grid places for impeding during qualifying.

TYRE CHOICE

STINT 1	STINT 2	STINT 3	STINT 4	STINT 5	STINT 6
Medium	Medium	Medium	Hard		
Medium	Medium	Medium	Hard		
Medium	Medium	Medium	Hard		
Medium	Medium	Hard	Medium		
Medium	Medium	Hard			
Medium	Medium	Medium	Hard		
Medium	Medium	Medium	Hard		
Medium	Medium	Medium	Hard		
Medium	Medium	Medium	Hard		
Medium	Medium	Hard	Medium		
Medium	Medium	Hard	Medium	Hard	Hard
Medium	Medium	Hard			
Medium	Hard	Hard			
Medium	Hard	Medium			
Medium	Medium				
Medium					
Hard/dns					

Option tyre in bold; new set in red; used set in black

DRIVERS' STANDINGS

POS	DRIVER	PTS	AUS	MAL	BRN	PRC	E	MC	CDN	A	GB	D	H	B	I	SGP	J	RUS	USA	BR	UAE	
1	ROSBERG	43	1 st	2 nd																		
2	HAMILTON	25	ret	1 st																		
3	ALONSO	24	4 th	4 th																		
4	BUTTON	23	3 rd	6 th																		
5	MAGNUSSEN	20	2 nd	9 th																		
6	HULKENBERG	18	6 th	5 th																		
7	VETTEL	15	ret	3 rd																		
8	BOTTAS	14	5 th	8 th																		
9	RAIKKONEN	6	7 th	12 th																		
10	MASSA	6	ret	7 th																		
11	VERGNE	4	8 th	ret																		
12	KVYAT	3	9 th	10 th																		
13	PEREZ	1	10 th	dns																		
14	GROSJEAN	0	ret	11 th																		
15	SUTIL	0	11 th	ret																		
16	GUTIERREZ	0	12 th	ret																		
17	CHILTON	0	13 th	15 th																		
18	KOBAYASHI	0	ret	13 th																		
19	ERICSSON	0	ret	14 th																		
20	BIANCHI	0	nc	ret																		
21	MALDONADO	0	ret	ret																		
22	RICCIARDO	0	ex	ret																		



CONSTRUCTORS' STANDINGS

POS	DRIVER	PTS	AUS	MAL	BRN	PRC	E	MC	CDN	A	GB	D	H	B	I	SGP	J	RUS	USA	BR	UAE	
1	MERCEDES	68	25	43																		
2	McLAREN	43	33	10																		
3	FERRARI	30	18	12																		
4	WILLIAMS	20	10	10																		
5	FORCE INDIA	19	9	10																		
6	RED BULL	15	0	15																		
7	TORO ROSSO	7	6	1																		
8	SAUBER	0	0	0																		
9	LOTUS	0	0	0																		
10	CATERHAM	0	0	0																		
11	MARUSSIA	0	0	0																		

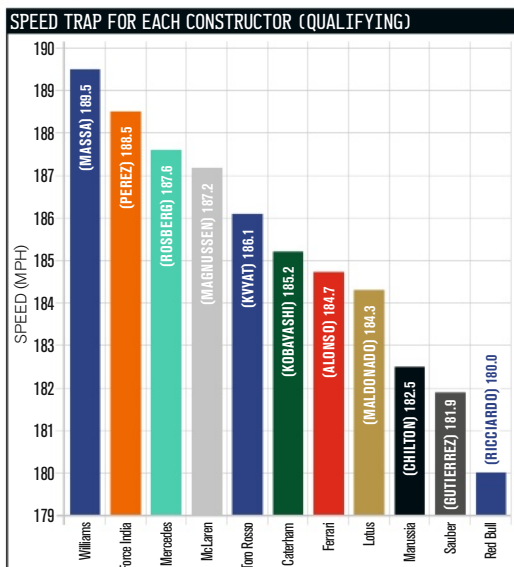

FOR IN-DEPTH RESULTS
forix.autosport.com

Why F1 2014 is louder than you think

The sound of the new V6 turbos has divided opinion among drivers and fans. **BEN ANDERSON** investigates whether the 2014 soundtrack is hitting the right notes, and what can be done to improve it



32

Noise has long been a big issue for motorsport in general, but it has also become a serious talking point in Formula 1 over the first two races of the new season.

There was a degree of backlash from fans following the first race of 2014 in Australia, as those used to the piercing scream of high-revving V8 engines suddenly found the soundtrack to their Sunday viewing altered substantially

by muted V6 turbo propulsion.

But it is not only a proportion of enthusiasts who have found this quieter form of F1 a turn-off. First the sport's commercial supremo Bernie Ecclestone told the Australian press that he was "horrified" by the lack of noise in Melbourne (despite not actually being there himself), then reigning world champion Sebastian Vettel waded into the debate in the build-up to the Malaysian Grand Prix by claiming

the latest F1 engines sound "shit".

Other drivers have been less outspoken, although McLaren's Jenson Button pointed out that most are only concerned with how competitive their machinery is, not what it sounds like. "When you cross the finish line first you don't care what it sounds like," he said. "You have beaten the best in the world and that's all you care about. Go and race something else if you're not happy"

Interestingly, Ecclestone subsequently softened his opinion after seeing – and hearing – the cars up close for the first time in Malaysia. And that is a crucial point, for it seems there has been a serious disconnect between what the cars actually sound like and how they come across on TV and radio.

As Professor Trevor Cox – an expert in audio engineering from the University of Salford – points out, this new generation of F1

NOISE COMPARISON

How Formula 1's new era stacks up against other major motorsport categories, and its previous engine formula used from 2006-13

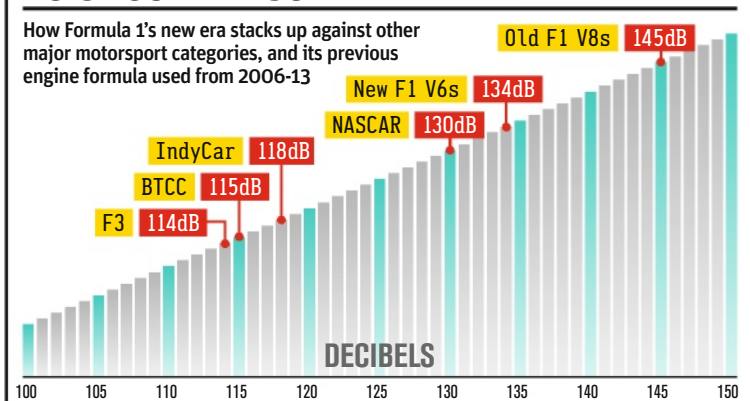

Screaming V8s were only 11dB louder than V6s

Many fans have
hit out at the
sound of 2014

WHY THE SOUND OF F1 2014 CAN'T BE CHANGED

REMI TAFFIN

RENAULT HEAD OF
TRACK OPERATIONS



"There are two big items that drive this. Firstly revs. We went from 18,000rpm to something like 12,000rpm this year. It's important to say it's based on the regulations, because they set 15,000rpm as a maximum, but the fuel-flow limitation means the maximum we're running – whether it's a Ferrari, a Mercedes or a Renault – is 12,000rpm, and at the end of the straight it could be 10 or 11,000.

"The other item is the turbo. You put one thing through the path of the exhaust gases, which is like if you would put a pillow on someone's face. It acts as a muffler. If you combine these two, we've got the result we've got.

"If you want to have a different noise you have to go up on revs, but there would be no point going up on revs if you look at the fuel flow, because you would have to get the fuel flow up, and that would bring your efficiency down.

"There's nothing you can do with exhaust profiling because again you've got both exhaust pipes running into the same tailpipe after it has run through the turbo, so it is what it is."



HONE/LAT

cars is actually substantially louder than it appears.

"A lot of people have commented about these new 'quiet' engines, but they're producing a sound at 134 decibels, according to the FIA, which is around 11dB lower than the old V8s but still above the threshold at which the listener would experience discomfort in the ear," he told AUTOSPORT. "As a rule of thumb, a 10dB decrease equates roughly to a halving of our perception of loudness.

"The irony is that if you look at videos from 2013, lots of people are wearing ear defenders, which will knock off 20-30dB depending on their quality, and that's quieter than what is going into their ears now.

"There's an important psychological aspect too, related to the frequency of the sound. The old V8s produced a sound in the 500-2500Hz range, whereas the new engines fall an octave lower, to 300-600Hz. The old V8s were described as 'screaming' and the ear is very sensitive at that frequency. A screaming sound is also a distress cry, so it produces an emotional

"Ears are sensitive at V8 frequency. That 'screaming' sound is also a distress cry"

response in the listener.

"I've listened to some recordings of the new engines and they sound like older turbocharged racing cars. Part of this is about what we're used to. It might sound glib to say people will get used to it, but that's probably true for most."

Beyond getting used to a different audio experience, perhaps the key to reaching fans who (understandably) are unwilling or unable to spend money on actually attending races is to better translate the sound to TV and radio audiences.

One TV insider, who did not wish

TV is not doing
new sound of
F1 justice



STALEY/LAT

to be named, told AUTOSPORT that better microphone placement and processing of the sound would improve the experience for armchair fans.

"The biggest thing lost from 2013 to 2014 has been volume," he said. "I would suspect a drop of around 25dB to 30dB. This may not sound a lot but it's pretty big.

"There's also a tonal shift in the sound produced by the new cars. The mid to upper frequencies have been lost and, while the turbo whistle is there, it's not enough to compensate for the loss of

the scream of the V8.

"Given better mic placement, audio mixing and processing, the fans at home should get a much more precise reproduction of the sound at the track, although this can be tricky given the acoustics of each venue are different, and that sound is also affected by climatic conditions, so the cars could sound very different from day to day."

Ultimately, it seems that fans will have to like it or lump it. For better or for worse, the sound of F1 has fundamentally changed, and there is no going back now.

Porsche proves that it belongs

It's too early to read into the 919's pace-setting times in testing, but the mileage it completed in France last week proved a significant point. By **GARY WATKINS**



34

Porsche proved on the public testing debut of its new 919 Hybrid that it has solved the car's reliability gremlins ahead of the World Endurance Championship opener at Silverstone later this month.

The German manufacturer had a successful two days at the official – and mandatory – WEC test at Paul Ricard last week, topping the times and running almost fault-free

through the five sessions. The significance of Porsche's pace relative to LMP1 rivals Audi and Toyota was hard to judge, but reliability of a car that was plagued by problems through its first five months of testing last year was clear-cut.

The two 919 Hybrids ran through four of the sessions without problems until the #14 car, shared by Romain Dumas, Neel Jani and Marc Lieb, was hit by an

undisclosed engine problem and then lost a wheel in the final three-hour period. Porsche was able to rack up nearly as many laps over the course of the test as Toyota's new TS040 HYBRID and far more than Audi, which admittedly was keeping mileage down on its two R18 e-tron quattros ahead of the Silverstone 6 Hours on April 20.

The performance came on the back of a first endurance simulation by Porsche in private at Ricard at the start of the week of the test. The 919 earmarked for long-distance testing failed to complete a 24-hour run, but it did do six hours – the duration of all the WEC races bar Le Mans – on two occasions.

Team principal Andreas Seidl said he would “not go into detail” on the problems that prevented the 919 from completing a Le Mans distance. But he expressed satisfaction with the test.

“It was our first endurance test and we tried to go as far as possible,” said Seidl. “The main focus was on the first two races [the Silverstone and Spa six-

hour events] and we managed to go through this, which was good for us.”

Porsche, which embarked on a major engine redesign straight after the first shakedown of the 919 last June, is now confident that the major components of the car are capable of doing six hours. That includes its twin kinetic and exhaust-gas energy-recovery systems.

Porsche LMP1 technical director Alex Hitzinger said: “From a general concept point of view the car is working well and is reliable, that's the big thing. Now it's the little things that could catch us out, the 10 cent bits, finger trouble and all the operational stuff.”

Seidl added: “We have addressed some [of the problems] already and we are working hard back home on the others.”

Hitzinger warned that too much could be read into the times from the test. Brendon Hartley ended up fastest by eight tenths in the #20 car he shares with Mark Webber and Timo Bernhard, who both set times better than the second-placed



Porsche is focused on race sharpness

LMP1 rivals
got up close
and personal



LAPS COMPLETED AT TEST BY LMP1 MANUFACTURERS

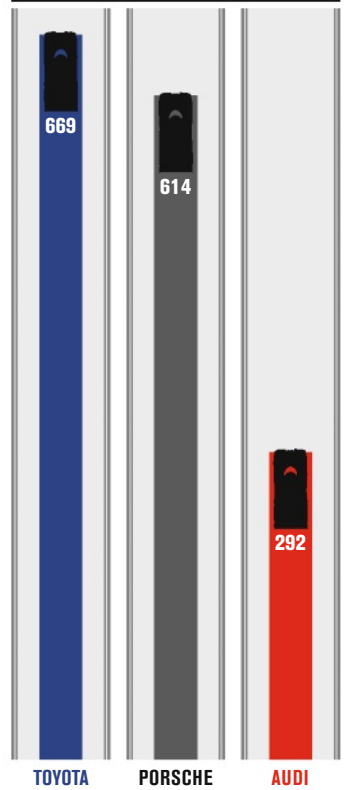

WEC TESTING TIMES

PAUL RICARD MARCH 28-29

DRIVERS	TEAM	TIME
1 Brendon Hartley	Porsche	1m41.289s
2 Andre Lotterer	Audi	1m42.073s
3 Romain Dumas	Porsche	1m42.126s
4 Stephane Sarrazin	Toyota	1m42.356s
5 Loic Duval	Audi	1m42.407s
6 Sebastien Buemi	Toyota	1m43.615s

In brief



LOLAS CALLED UPON

Rebellion Racing dusted off its out-going Lola-Toyota B12/60s for the Ricard test prior to its new Rebellion R-One coming on stream. Nick Heidfeld set a best time of 1m44.806s for the team, which looks increasingly likely to fall back on the old cars at the Silverstone WEC opener.

CLOSE TIMES IN LMP2

Shinji Nakano ended up fastest in LMP2 for the best of the Millennium/Delta squad's ORECA-Nissan O3s with a time a tenth better than Olivier Pla in the G-Drive/OAK Morgan-Nissan LMP2. Millennium and OAK kept their running to a minimum at the mandatory test because they were obliged to use one of the three race engines they are allowed over the course of the season. The AF Corse-run SMP team did more running with its pair of ORECA as part of a data-gathering exercise for Michelin.

PORSCHE LEADS GTE

The Porsche factory headed the times in the GTE Pro class with its solo Manthey-run 911 RSR in the hands of Frederic Makowiecki. James Calado was second fastest on his public debut as a Ferrari factory driver with AF Corse. Sam Bird, who will race a privateer AF 458 Italia at Silverstone and Le Mans in GTE Am, was also second fastest in class to Paolo Ruberti's AF/8Star Ferrari.

NEW 'YELLOW' SYSTEM

The ACO and the FIA were experimenting with a new GPS-based monitoring system that will police yellow-flag procedures that should reduce the need for the deployment of the safety car. The in-car system will alert drivers when they have to maintain the 60km/h (37mph) limit.

Audi of Andre Lotterer.

The true pace of the three factory P1 contenders for this year's WEC was confused by the different aero configurations their machines were running. Audi's two R18s were in high-downforce sprint specification, while Toyota had one high-downforce and one low-downforce TSo40, neither of which offered the optimum set-up for Ricard, according to team technical director Pascal Vasselon.

The Porsches were clearly more optimised for the 3.60-mile Circuit Paul Ricard. That was something that the new in-house

factory team admitted.

"The main focus for us here is to fine-tune the car and find some performance," said Seidl. "The other thing that is important is to get ready for the first race at Silverstone and operate as a proper race team."

Confusion over what fuel allocation – the basis of the new energy-based P1 formula – each of the cars were running further clouded the picture. The FIA and the Automobile Club de l'Ouest, authors of the P1 rulebook, presented the factories with new figures on Friday morning after meeting with them the previous

day. These numbers have yet to be published and nor were the manufacturers under any obligation to run to them at the test.

Porsche is remaining cautious in its aspirations for its first year back in front-line sportscar racing since 1998. Its comments at Ricard on its targets for Silverstone and beyond came straight from the well-thumbed company crib sheet in use since last summer.

"This doesn't change anything at all," said Hitzinger. "We have been realistic and we remain realistic. Our aim is to finish races and after that be as competitive as possible."

Comprehensive motorsport insurance products to keep you on track;

- 🔵 Worldwide On Track
- 🔵 Personal Accident
- 🔵 Storage and transit
- 🔵 Track day
- 🔵 Liability
- 🔵 Commercial

Please complete an online quote request form at – www.ryanmi.com

Email – info@ryanmi.com Tel – +44 (0) 1799 524202

Ryan Motorsport Insurance Limited is an appointed representative (557405) of Independent Broking Solutions Limited who are authorised and regulated by the Financial Conduct Authority. Its Financial Services Register number is 312026

RYAN
MOTORSPORT INSURANCE

BAHRAIN GP PREVIEW

Fuel technology takes a more direct route

One of the lesser-heralded developments to F1 2014 has been the advent of direct fuel injection, but it became big news given Red Bull's recent problems. **CRAIG SCARBOROUGH** explains all

Direct fuel injection is common on road cars, but is new to Formula 1 as it was previously outlawed.

Fuel is now injected directly into the combustion chamber at very high pressures. Previously, the fuel was indirectly injected above the inlet trumpets at far lower pressures. This change is to boost fuel efficiency as this year's instantaneous fuel-flow and race-fuel limits would have been hard to achieve with indirect injection.

Fuel is stored in the flexible bladder tank. It flows inside the tank through a series of false floors and walls. The fuel's flow is controlled by one-way

trap doors that direct it into a final compartment at the bottom of the tank. Surprisingly, given F1's nature, there is a sole supplier of fuel tanks to the teams: ATL manufactures all of the Kevlar bag tanks to the teams' individual specifications.

From here, fuel is moved to a collector by a number of lifter pumps. These are simple electric pumps and can tolerate being run dry. The collector is a one-to-two-litre carbonfibre cylinder, about the size of a family-sized bottle of fizzy drink. It's tall and narrow, so fuel should always be in the bottom of the baffled cylinder regardless of cornering forces.

Fuel is taken from the bottom of the collector by a high-pressure pump driven from the engine. This being a pump of far higher precision than the lifter pumps, it must not run dry. Sensors will warn the team if the pump fails to find fuel in the collector and the engine will be shut down.

Last year, this high-pressure feed would have exited the tank and have been connected to the fuel rail that houses the eight indirect fuel injectors. This year, the fuel line passes through the FIA fuel-flow sensor and then meets another pump.

This is the direct-injection pump, which can pressurise the fuel up to

500 bar. As this pump is so powerful, there is usually one pump per cylinder bank, each mechanically driven off the inlet cam. Inside each cylinder head is a single, high-pressure injector and fuel is sprayed into the combustion chamber on the inlet stroke.

Such is the pressure, the fuel is instantly atomised and mixes with the air to provide a far more efficient fuel/air mix. The timing of the injection and spark are both controlled by the FIA SECU (standard ECU), with a separate power box providing the higher voltage required to drive the injectors and individual coil packs on each spark plug.

FUEL SYSTEM

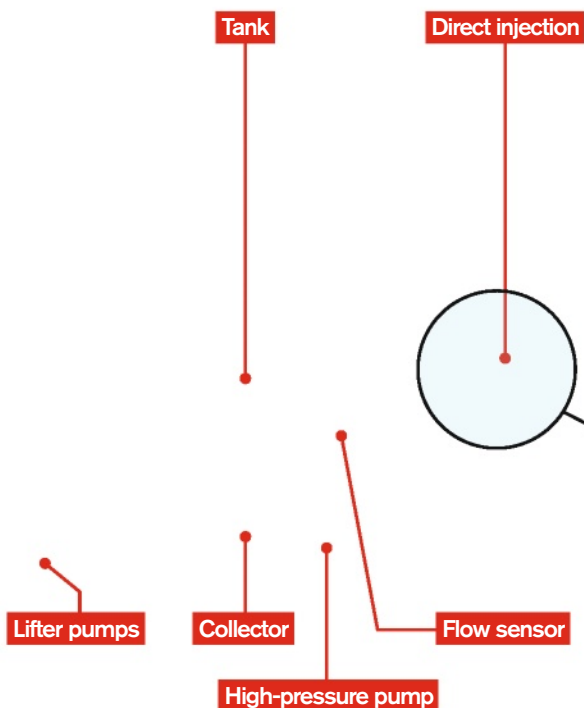

DIRECT INJECTION

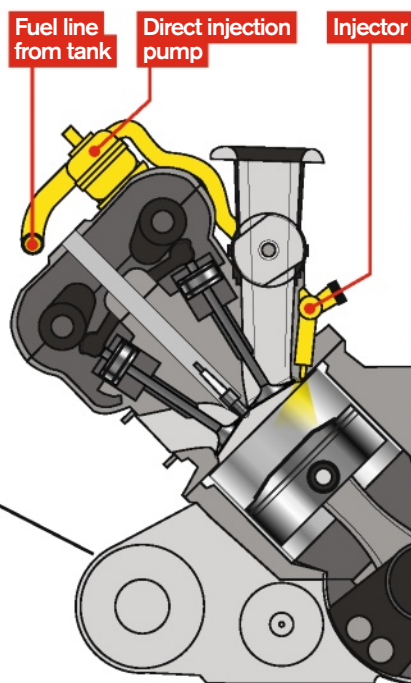

INDIRECT INJECTION

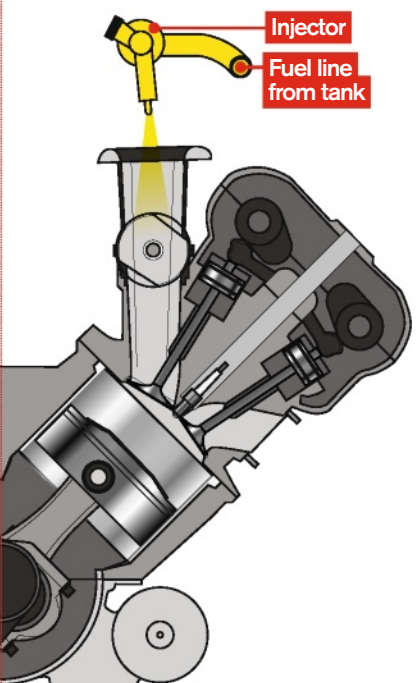

WHAT TO WATCH OUT FOR

RACING IN DARKNESS

This season's race will be the first run under floodlights at the Sakhir circuit. Of course, Formula 1 is no stranger to night races, thanks to Singapore's street event and Abu Dhabi's dusk race, but this fundamental change in conditions for a race that usually runs in blistering Middle Eastern desert heat is a step into the unknown.



DEVELOPMENT WAR

This race will mark the first time this new generation of F1 cars has returned to a circuit on which it has already run. Teams spent eight days testing here in late February/early March, so this event should give us a fresh insight into which outfits are making the most progress with their new machines.



STRATEGIC PATTERNS

This new lean, green, energy-efficient formula has created plenty of headaches on the pitwall, as teams battle to get to grips with its new strategic demands. That means we don't yet know what a 'typical' 2014 GP looks like. But this will likely be the most representative race yet, thanks to extra knowledge of tyre behaviour gleaned from testing.

BAHRAIN

Sakhir

KEY INFO

2013 winner
Sebastian Vettel
(Red Bull)

2013 pole
Nico Rosberg
(Mercedes) 1m32.330s

UK start times
FP1: 1200
FP2: 1600
FP3: 1300
Qualifying: 1600
Race: 1600

Live TV
Sky Sports F1

Tyre allocation

Soft Medium

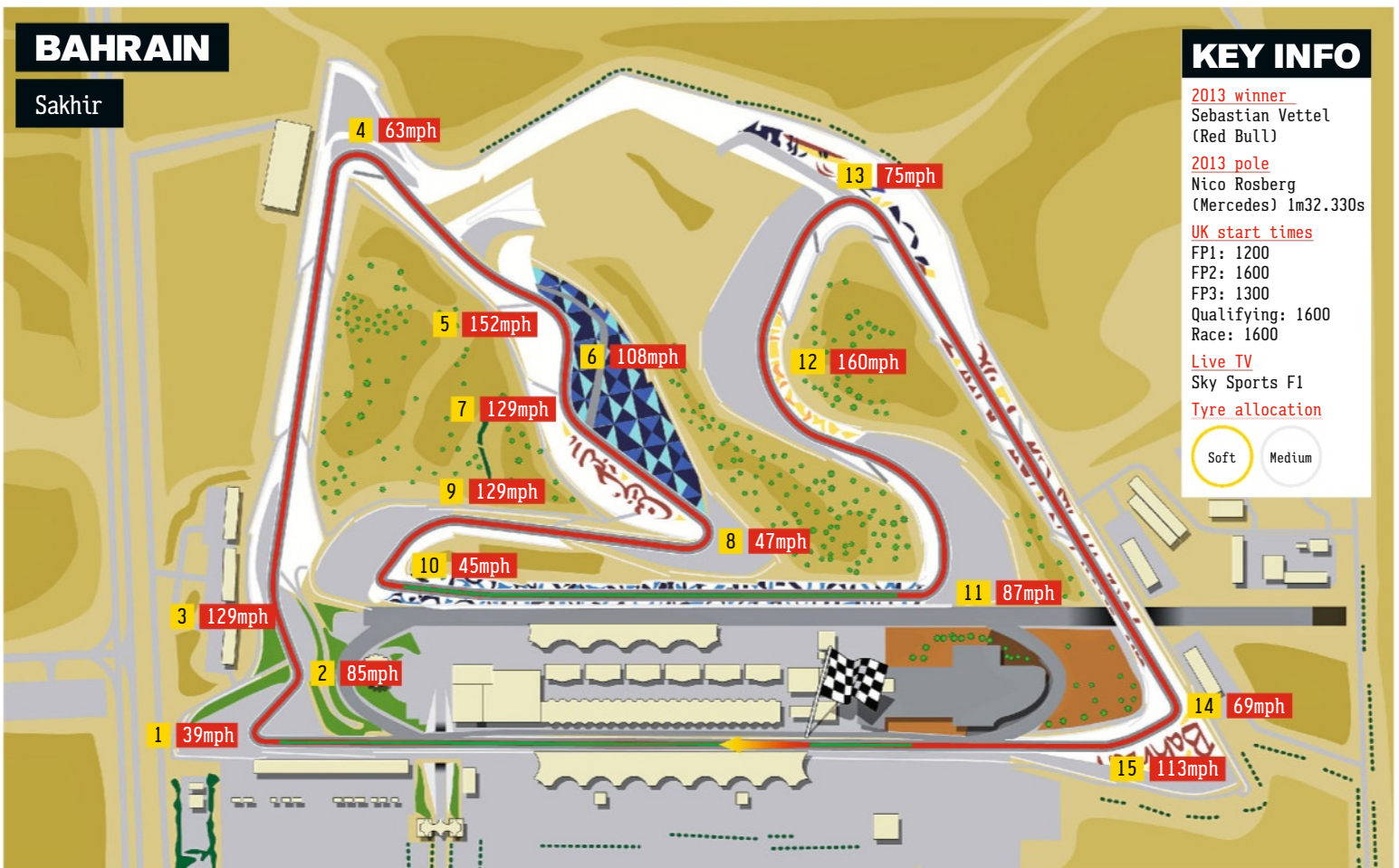

DRS zone

CLASSIC RACE

Sebastian Vettel held off a stern challenge from the Lotuses of Kimi Raikkonen and Romain Grosjean to win the 2012 Bahrain Grand Prix by just over three seconds. Team Enstone's E20 design possessed a remarkable ability to protect Pirelli's delicate tyres, allowing its drivers to reach the front from unremarkable grid positions. Raikkonen leapt from 11th on the grid to seventh at the start, and was up to third after the first round

of pitstops thanks to an elongated opening stint. He passed team-mate Grosjean before their second stops and hunted down Vettel, but blamed race-rustiness in his comeback season for failing to make a move stick into Turn 1. Vettel's Red Bull eked out a small but decisive lead after the final round of stops to record his first win of the campaign, ahead of Raikkonen and Grosjean, the Frenchman collecting his maiden F1 podium finish.



TOYOTA'S BEST CHA

The Japanese firm's latest Le Mans contender has almost 1000bhp and the squad is better prepared



ANCE YET

than ever before. **GARY WATKINS** talks to the main architects behind the project



Toyota grabbed the headlines with the power figures of its new TSO40 HYBRID. Yet the revelation that its new car is knocking on the door of 1000bhp when you combine the power of its engine and its hybrid systems isn't the most significant fact to emerge from last week's launch of the Japanese manufacturer's bid for the 2014 World Endurance Championship. More important is that it will be

ready when the series kicks off at Silverstone later this month – and ready, perhaps, to win the title and the Le Mans 24 Hours for the first time.

A two-car assault is set in stone – something that wasn't the case last year – and the Toyota Motorsport GmbH squad will begin the eight-race season on April 20 with both configurations of the TSO40 ready to go. Again, that wasn't true in 2013, its first full year back at the very pinnacle of sportscar racing.

BETTER PREPARED

“Our mission statement, and it couldn't be more simple,” says TMG operations manager Rob Leupen, “is to win the Le Mans 24 Hours and the WEC.”

That, combined with a firm two-car entry, suggests that 2014 was always the year set down in the Toyota masterplan to go for twin honours at Le Mans and in the world championship. Leupen insists it's more complicated than that. “We also had some expectations last year,” he says. “We would like to have won Le Mans and we were disappointed to only get two wins in the WEC.”

Leupen does admit, however, that TMG has greater resources available to it for this, the first year of the new energy-based LMP1 regulations.

“We found some extra money and resources to enable us to run two cars for the whole season, which was always planned and is what you need to win,” he explains. “Last year, it was one plus two at Le Mans and two for preparation [for the 24 Hours].”

That is confirmation, if any were needed, that ▶

HIGH DOWNFORCE



MOY/APB

► Toyota initially only planned to make one full-season entry and run two cars at Silverstone, Spa and Le Mans last year. Two TS030s were actually entered for the full season at the behest of the WEC, with part of the deal being that TMG could run one car without sanction after Le Mans. It subsequently found some extra resources to revert to two cars for the final three races after the early disappointment of the retirement of its solo entry at Interlagos, a race it believed it was on course to win.

That Brazilian race marked the debut of the high-downforce – or sprint – specification second-generation TS030. The team had to rely on the 2012 car at the Silverstone opener and only had one of its new chassis ready for Spa in May, and then only in Le Mans trim. A year on, it has already been racking up the test mileage with what it calls “a rollout aero package” on the TS040, and had its definitive Le Mans-spec car and high-downforce sprint aerodynamics ready for last week’s official WEC test at Paul Ricard.

Pascal Vasselon, technical director at TMG, reckons that Toyota is better prepared than it was for either of its first two seasons in the WEC. The programme was inevitably late in year one – it didn’t get signed off until October 2011 – and last year was better rather than perfect.

“The worst, of course, was 2012,” says Vasselon of the year in which Toyota was always going to miss the season opener at Sebring and then had to delay its first race until Le Mans after a shunt in testing. “In ’12 we were not ready at all. Last year was better and this year is one step better again.”

Toyota’s TS040 was beaten to the test track by its rivals from both Porsche and Audi, but then TMG is still working on a much smaller budget. Vasselon explains that the big push on the new car didn’t start until Le Mans last year was done and dusted. The Porsche was already testing by that point,



while Audi has revealed that it began designing its new R18 e-tron quattro at the end of 2012.

“A few people started as soon as the regulations were more or less known, and we have been working on the regulations with the FIA and the Automobile Club de l’Ouest [which are jointly responsible for the rulebook] since 2011,” explains Vasselon. “We started on our simulation at that time. We had a flow of activity to get the project under way and to make the major decisions, but actually designing the car only started in terms of major man hours after Le Mans.”

That resulted in the first car running at the end of January and more than 22,000km (13,600 miles) have already been racked up by the TS040. The next big test comes with the latest of “several” Le Mans simulations scheduled for next week at Ricard.

THE HYBRID SYSTEMS

Toyota has stuck to the rear-axle kinetic-energy recovery of the TS030 and added a front-axle KERS as the second hybrid system allowed under the

rules. It looks like the obvious solution for a manufacturer that clearly had an advantage over Audi in terms of energy retrieval in 2012-13. But Vasselon insists that all options were considered.

Running one KERS and also harvesting energy from the exhaust gases, the route chosen by Porsche and (initially) Audi, was also a possibility.

“For the end result of one kilo of hybrid system, our calculations say that KERS is more efficient than exhaust-gas energy recovery,” he says. “We are happy to see that finally Audi came to the same conclusion.

“It doesn’t mean it is more energy efficient, because to get one megajoule of energy from an exhaust system is lighter than getting one MJ from KERS, but using braking energy is more lap-time-efficient, because with an exhaust system you lose efficiency with the combustion energy.

“You create back pressure in the exhaust, which impacts the way the combustion energy works and its efficiency. You have more losses. With KERS, you are recovering energy that would otherwise be dissipated as heat and lost.”

Toyota is sticking with a supercapacitor for energy storage. Vasselon said that Toyota and TMG were “constantly monitoring both technologies. A supercapacitor, at the moment for us, is the best compromise. At Le Mans you need reliability and consistency of performance over a long period.”

Asked if he has doubts about the ability of a lithium ion battery pack, as used by Porsche, to function properly through the 24 Hours, Vasselon says: “Exactly.”

Toyota has opted to run in the 6MJ sub-class for factory LMP1 entries, the second highest of the four categories. Vasselon explains that going to the higher 8MJ division would “involve too many weight and packaging constraints that would generate problems elsewhere”

“When you raise the energy you raise the weight

“A small-capacity turbo is efficient in your wife’s car, but not in a racing car”
PASCAL VASSELON

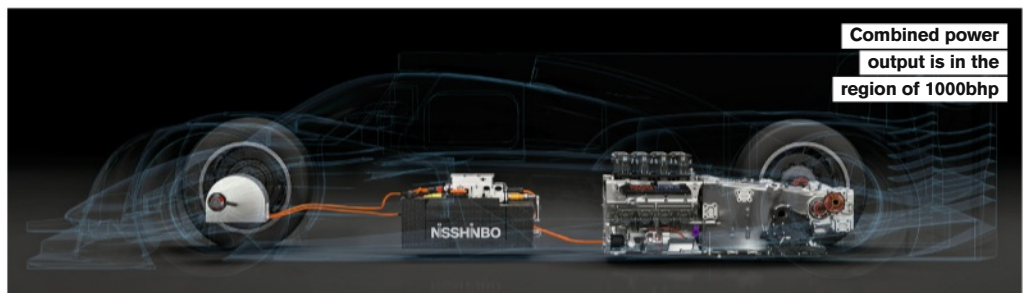

LOW DOWNFORCE

MOYXPB



of all the components," he continues. "Everything would become heavier, the motors and driveshafts as well as the supercapacitor."

How the 473bhp available – the official figure is 480PS – from the twin hybrid systems will be returned to the track hasn't been fully explained by Toyota. Vasselon would only say: "Let's put it this way, we will put less energy in the rear tyres than last year. There is a lot of energy going to the front."

THE ENGINE

Toyota is returning with an increased-capacity version of the existing normally aspirated petrol V8, which was all-new for 2012 even though its architecture has its roots in the Super GT/Formula Nippon-based powerplant used by the privateer Rebellion Racing LMP1 squad since 2011. Vasselon now reveals that this engine was conceived with the new regulations in mind.

Toyota's calculations suggest that a lower-revving normally aspirated powerplant is more fuel efficient than the small-capacity turbo chosen by Porsche. "There is no mystery," says Vasselon. "If you want to be competitive, you have to reach a certain level of power and a small-capacity engine will have to rev higher and that is where, for us, you have an efficiency loss."

"A small-capacity turbo is efficient in your wife's car, but not in a racing car."

Toyota has increased the V8's capacity from 3.4 litres, the maximum allowed by the old regulations, to 3.7 litres under the new rules, in which there is no limit. "If you want to increase the efficiency, you need to drop the revs," explains Vasselon of the engine with a quoted power output of 520PS or 512bhp (and hence the 1000PS claim). "That is why we have gone to a larger capacity. There is no big secret to it."

"There is a benefit of going even bigger with the

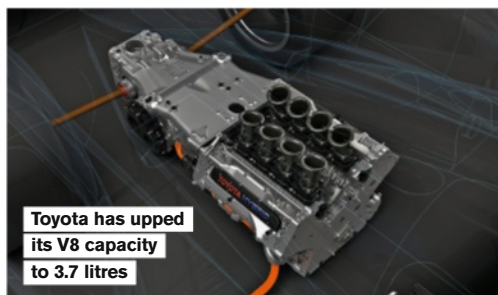

Toyota has upped its V8 capacity to 3.7 litres

engine, but then the weight goes higher as well. All these parameters are tuned to be a local optimum where you take the benefit up to the point where you don't create another loss."

THE CHASSIS

John Litjens, project chassis leader on the TS040 and its predecessor, explains that getting an LMP1 to the new 870kg weight limit, down from last year's 915kg, was a significant challenge. Not only did his team of designers have to account for extra kilos of a second hybrid system, but a raft of new safety measures – including wheel tethers and Xylon anti-intrusion side panels – made mandatory for the coming season also come with a weight penalty.

"It was one of the biggest challenges, along with the new aerodynamics," he says. "We have taken some big steps in this respect, but I think there's the possibility to damage the car more easily than before."

The safety items come in at around 20kg, but Litjens won't reveal the total weight of the TS040's hybrid systems, except to say they have increased by 30 per cent in comparison with last year's car. Asked if Toyota has managed to come up with an underweight car that can be ballasted in the interests of optimum weight distribution, he says: "We are happy we have achieved the minimum weight."

The TS040 retains the family look of its forebears, just like Audi's R18 e-tron quattro appears similar to the first car to be given that name, but underneath the Toyota is very different to what has gone before, reveals Vasselon. That is a consequence of new aerodynamics that allow for an adjustable front wing inside the nose of the car.

"It has to be very different because the aero regulations are very different," he says. "The car might look similar [to last year's] but what faces the ground is very different – but you will never see it!"

Toyota, like its two manufacturer rivals in the WEC, offers what sound like compelling arguments to justify the solutions and technology it has chosen to meet the massive challenge of the new P1 regulations. Vasselon admits, however, that all simulations start with "a list of hypotheses, approximations and guesses".

"If our hypotheses are right, then we have made the right decisions," he says. "If we have made a few mistakes in the questions we were asking, the results of our simulations might be wrong. I guess we will know at Le Mans." ❧

THE MEN IN THE COCKPIT

The drive for weight reduction was the major motivating factor in Toyota's decision to move its line-up of drivers around for 2014. Stephane Sarrazin moves into the #7 car to join Alex Wurz and Kazuki Nakajima, while Nicolas Lapierre goes the other way to team up with Anthony Davidson and Sebastien Buemi in #8.

The change-around has matched the height of the drivers, putting the three tallest pedallers together in the #7 and leaving #8 to the shorties. This offers a weight saving because it allows each driver to have a smaller seat insert.

"We have some tall guys and some short guys like me, which makes it a nightmare for the seats," explains technical chief Pascal Vasselon. "An insert is actually very heavy."

"Last year, for example, when we put Anthony into Alex's seat [in testing], the insert was huge. It weighed something like eight kilograms. Our new line-up means we've saved something like 3-4kg, which can be worth a few tenths."

The logic is simple, as Vasselon explains: "You start from a reference seat for the tallest of the three and the others put inserts into it. If the drivers are closer together in terms of size you have smaller inserts."

The Toyota line-up, which has been unchanged since 2012, came together in piecemeal fashion. Wurz, Lapierre and Nakajima were already confirmed in #7 when Davidson and Buemi were signed up for Le Mans only that year. The slightly taller Sarrazin came in just days before the Le Mans Test Day after Toyota decided to not to continue with its plan to run Hiroaki Ishiura after disappointing results for the Japanese in testing.





ROOKIE
STOFFEL VANDOORNE



VETERAN
STEFANO COLETTI



VETERAN
FELIPE NASR

Rookies take on

GP2 remains a proven route into F1, even though its past two champions haven't quite made the grade.

Not since 2009 has a rookie won the GP2 Series title, when Nico Hulkenberg emulated Lewis Hamilton (and inaugural champion Nico Rosberg) but this year that sequence could be broken. Two Formula 1 junior drivers join the ranks with huge reputations, but their vastly experienced opposition is quite formidable. Can Ferrari protege Raffaele Marciello or McLaren's Stoffel Vandoorne stake their claims for 2015 F1 race seats by scooping this title at their first attempt? Or will the competitive field of seasoned veterans they're up against prevail once more?

INTRODUCING THE ROOKIES

Ferrari's Marciello is the reigning European Formula 3 champion and graduates to GP2 with Racing Engineering, which took Fabio Leimer to last year's title. The equipment and personnel at his disposal are undoubtedly top notch, and he's teamed with five-time GP2 race winner Stefano Coletti (more about him later).

Pre-season testing form has been impressive, the Italian regularly displaying top-10 pace with a team that's never been prone to chasing headline-stealing test times.

"Testing has gone really well," says Marciello.

"We've tried a lot of programmes and we've been really fast, but we know we have to improve on our qualify laps. From my side, it's quite difficult on these Pirellis because you only get one lap to get the time out of them – I used to get four chances on the Hankooks in F3 last year. It means you have to find 2s in one lap over the used tyres, which is a bit more difficult."

Marciello is happy he's had enough pre-season seat time to be prepared for this weekend's Bahrain opener, and says his race simulations have been "really fast – for the races, I think I'm ready". He's targeted a top-five finish in the points, and race wins are certainly on his radar.

"I'm pleased to see the rookies coming in – it's great to see the best talent in GP2, backed by F1 teams" JOLYON PALMER

In the McLaren corner, Vandoorne arrives as runner-up to Kevin Magnussen in last year's Formula Renault 3.5 championship. Already a champion at F4 and FRenault 2.0 Eurocup level, he lands at an ART team that is no stranger to success with Rosberg, Hamilton and Hulkenberg. However, its recent fortunes have waned slightly and James Calado struggled to maintain a title campaign last season.

The 22-year-old Belgian is also McLaren's reserve F1 driver this year, so his first season on the grand prix support card should prove mutually beneficial to both parties.

THE VETERANS

The top three in last year's championship might have moved on to pastures new (none of them in F1, it should be noted) so the hot favourite for honours this year is Brazil's Felipe Nasr. He remains at Carlin this year for a full-on title assault (his third in the category) but the Williams F1 test and reserve driver has the stigma of not yet having won a GP2 race (albeit missing out by 0.08s in Bahrain last year). It's a statistic he's keen to address.

"I'm always fighting to win, maybe four or five times last year I was leading races," he says. "But there was always something, whether it was a strategy decision like those who took fresh prime



VETERAN
ALEXANDER ROSSI

BLOXHAM/LAT



VETERAN
JOLYON PALMER

BLOXHAM/LAT



ROOKIE
RAFFAELE MARCIELLO

BLOXHAM/LAT

GP2's veterans

43

CHARLES BRADLEY analyses the class of 2014 and asks if there are any GP superstars in waiting

tyres in the feature race [compromising their sprint-race hopes]. I was always going for the championship, so I wasn't willing to do that.

"We made some wrong decisions too, but I was always competitive and in positions to win. This year, I'm really keen to win races and take the title. It's why I came back to Carlin – it's easier when you know the team and we've analysed what we could have done differently, but we'll get it right. I'm out there to win."

Another driver with a lot to prove this year is Stefano Coletti, a fourth-year GP2 racer who moves to Racing Engineering after a Jekyll-and-Hyde season with Rapax. Three wins and seven podiums in the first half of the season dissolved into a pointless second part as he plunged from a dominant lead to fifth in the standings.

He claims he has learned from that bruising experience, and pressed the reset button with his new team, blaming last year's fall from grace on tyre pressure and camber limitations that everyone else appeared to cope with much better.

"I've been working really well with the team and my engineer – it's a completely different car to drive [from the Rapax machine] and it took quite a while to get used to the driving style required," says Coletti. "The car is very quick when you drive it correctly, but if you don't drive it how it wants you to it gets complicated!"

Britain's big hope for title glory is Jolyon Palmer, who moves to former champion DAMS on the back of two feature-race wins with Carlin in 2013. Also going into his fourth year in the series, he knows that the title is a must-win if he's to emulate father Jonathan by making it to F1.

"I've got all the experience I need, and coupled with DAMS' expertise, it's a case of us putting it all together," says Palmer. "I'm pleased to see the new rookies coming in – Vandoorne and Marciello – I think it's great to see the best talent from the other categories coming into GP2, backed by F1 teams. It gives me a chance to beat them and show everyone what I can do."

Palmer's team-mate at DAMS is the mercurial Stephane Richelmi, who stays for a second year with the French squad. Other likely contenders are Alexander Rossi (a winner in Abu Dhabi last year) who likewise sticks with Caterham for a second season, and Mitch Evans, who should be a far stronger proposition with an iSport-run Russian Time team than with Arden last year.

THE OTHER BRITS

Perennially-underfunded Jon Lancaster continues to cling to his F1 dream, thanks to spectacular results like successive sprint-race victories with Hilmer at Silverstone and the Nurburgring last

year. He topped both the Abu Dhabi and Bahrain pre-season tests for MP Motorsport, and even if his times were set in full-blown qualifying spec, it proves his underlying speed.

Adrian Quaife-Hobbs and Rapax is an intriguing combination, as both have race-winning form but question marks remain over consistency of performance.

WHAT ELSE IS NEW?

The big rule change for this year is the stipulation that all drivers must use both compounds of tyre during the Saturday feature race, as in F1. Last year, certain drivers forsook their chances in the Sunday sprint race by using both sets of the most durable tyre in the first race – most notably Palmer's successes in Hungary and Singapore. "This is a much fairer solution, which will balance the race strategies," says Nasr.

Pirelli has also altered the specification and compounds of its tyres for this season, to a similar type used at high-speed Spa and Monza last year. "They will be easier for the rookies to drive," claims Coletti.

Friday's free-practice sessions have been extended from half an hour to 45 minutes at all tracks – which should also help the rookies as they take on the older hands. It's going to be a fascinating battle between youth and experience. ❧

GIVE YOUR CAR THE BEST

SUPERIOR AIRFLOW, SUPERIOR POWER

Designed to **Improve** Engine Power

Cotton – brought to you by Mother Nature and used for filtration by K&N, the leader in washable performance air filters. Cotton breathes easier than paper and that can help improve engine performance by reducing airflow restriction. Another natural feature of cotton is its durability. It can be washed again and again. That means a K&N stock replacement air filter can last for the life of your car reducing waste and saving money.



Washable & Reusable

Up To 50 000 miles Between Cleanings
Under Normal Highway Driving Conditions

Lifetime Product



5 minute install

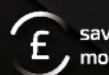

save money



reusable



more power

OVER 45 YEARS OF EXPERIENCE
MILLION MILE LIMITED WARRANTY

WWW.KNFILTERS.CO.UK® | TEL.: 01925 636 950



AUTOSPORT SHOP

AYRTON SENNA CANVASSES

TO COMMEMORATE ONE OF FORMULA 1'S GREATEST DRIVERS

Celebrate the life and successful times of the late, great Brazilian Ayrton Senna with one of six fabulous canvasses from the LAT archive. Capturing the skill, focus and intensity of the three-time world champion, the canvasses offer a superb piece of Senna memorabilia.



FREE SENNA T-SHIRT
FOR EVERY SENNA CANVAS PURCHASED
BETWEEN APRIL 1 AND MAY 1

TO BUY YOUR SENNA PRINT OR VIEW OTHER PRODUCTS VISIT WWW.SHOTDEADINTHEHEAD.COM/AUTOSPORT

ENTRY LIST

* to be confirmed

RT RUSSIAN TIME



1 MITCH EVANS (NZ) 2 ARTEM MARKELOV (RUS)



Reigning teams' champion has undergone massive upheaval following the death of team boss Igor Mazepa. Replacing Motopark in running the cars is 2007 champion squad iSport. Evans will be a force.

CARLIN

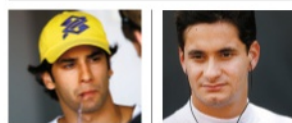

3 FELIPE NASR (BR) 4 JULIAN LEAL (CO)



Great stability with lead driver Nasr, who is the pre-season favourite for honours. In Leal it has a well-heelled racer who can be pretty handy when the mood takes him. A serious title contender on both fronts.

RACING ENGINEERING

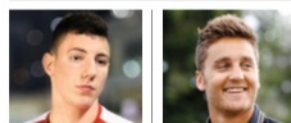

5 RAFFAELE MARCIELLO (I) 6 STEFANO COLETTI (MC)



After guiding Fabio Leimer to last year's drivers' championship, the southern Spanish squad has the strongest pairing in the series as it seeks its first teams' title. Expect fireworks from this quick duo.

DAMS



7 JOLYON PALMER (GB) 8 STEPHANE RICHELMI (MC)



Tons of nous, and two drivers' titles in the past three seasons – there's no doubting DAMS as a major player in the title equation this year. In Palmer and Richelmi it has two solid performers with race wins in them.

ART GRAND PRIX



9 TAKUYA IZAWA (J) 10 STOFFEL VANDOORNE (B)



After a lean 2013 by their standards, Fred Vasseur's boys have extra motivation with a McLaren protege in their ranks (remember that Hamilton chap in 2006?). Izawa is an odd choice – a McLaren/Honda portent?

HILMER MOTORSPORT

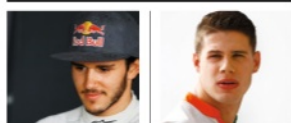

11 DANIEL ABT (D) 12 FACU REGALIA (RA)



One of the feelgood stories of last year was Franz Hilmer's decision to subsidise Robin Frijns and Jon Lancaster in his cars. That paid off with four wins, and attracted two quality (and full-budgeted) racers.

RAPAX



14 ADRIAN QUAIFF-HOBBS (GB) 15 SIMON TRUMMER (CH)



Rapax was champion with Pastor Maldonado not so long ago, but last year the crown slipped from lead driver Coletti's grasp in nightmarish fashion. Quaife-Hobbs has shown flashes of pace; Trummer has yet to.

ARDEN INTERNATIONAL



16 RENE BINDER (A) 17 ANDRE NEGRAD (BR)



A really odd season last year with quality rookie Mitch Evans and *enfant terrible* Johnny Cecotto Jr that didn't deliver anything like the solid results it should have done. Is this pairing likely to? Nah, not really.

CATERHAM RACING



18 RIO HARYANTO (RI) 19 ALEXANDER ROSSI (USA)



Here's a real dark horse to make an impact on the title races. Both Rossi and Haryanto have race-winning ability, and together they could push Caterham on in the teams' championship too. Keep an eye out.

MP MOTORSPORT



20 DANIEL DE JONG (NL) 21 JON LANCASTER (GB)*



A late spurt of points elevated this new team into the top 10 in last year's table, and although de Jong isn't expected to rip up any trees, feisty Yorkshireman Lancaster has been flying in pre-season testing.

TRIDENT



22 AXCIL JEFFERIES (ZW)* 23 JOHNNY CECOTTO JR (VV)



Here's a combination that's either going to sink or swim. Cecotto has copped some serious flak for his wild driving (often quite rightly, but not always). However, he is very, very swift (as well as nuts).

VENEZUELA GP LAZARUS

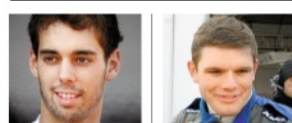

24 NATHANAEL BERTHON (F) 25 CONOR DALY (USA)*



A bit like Osella, you always want this little Italian squad to shine occasionally. It's been a tough winter, but in Berthon it has a tidy driver – and Daly would be an excellent addition too.

CAMPOS RACING



26 ARTHUR PIC (F) 27 KIMIYA SATO (J)



It's been a while since former Minardi racer Adrian Campos has been a team boss in this series, having sold out to Alejandro Agag. But now he's got his old crew back, so expect a steady year.

2014 CALENDAR

April 5-6	Sakhir	August 23-24	Spa-Francorchamps
May 10-11	Barcelona	September 6-7	Monza
May 23-24	Monte Carlo	October 11-12	Sochi
June 21-22	Spielberg	November 22-23	Yas Marina
July 5-6	Silverstone	ON TV	
July 19-20	Hockenheim	Watch all 11 GP2 race weekends live in the UK on Sky Sports F1	
July 26-27	Hungaroring		



BTCC Brands Hatch (GB)

March 30

Round 1/10

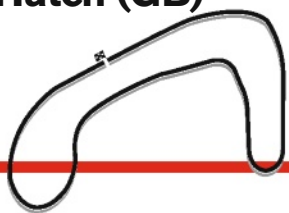

RESULTS

RACE 1: 24 LAPS, 28.990 MILES

1	ANDREW JORDAN (GB)	Eurotech Honda Civic	19m46.613s
2	JASON PLATO (GB)	MG (Triple Eight) MG6	+0.536s
3	MATT NEAL (GB)	Honda (Dynamics) Honda Civic Tourer	+9.396s
4	GORDON SHEDDEN (GB)	Honda (Dynamics) Honda Civic Tourer	+9.806s
5	ROB AUSTIN (GB)	Rob Austin Racing Audi A4	+10.156s
6	ROB COLLARD (GB)	WSR BMW 125i M Sport	+13.133s
7	ARON SMITH (IRL)	Team BMR Volkswagen Passat CC	+14.522s
8	COLIN TURKINGTON (GB)	WSR BMW 125i M Sport	+15.341s
9	TOM INGRAM (GB)	Speedworks Toyota Avensis	+15.736s
10	SAM TORDOFF (GB)	MG (Triple Eight) MG6	+16.188s
11	NICK FOSTER (GB)	WSR BMW 125i M Sport	+16.521s
12	JACK GOFF (GB)	Team BMR Vauxhall Insignia	+16.761s
13	ADAM MORGAN (GB)	Ciceley Mercedes A-class	+19.412s
14	FABRIZIO GIOVANARDI (I)	Motorbase Ford Focus ST	+20.231s
15	MAT JACKSON (GB)	Motorbase Ford Focus ST	+21.881s

Winner's average speed: 87.95mph. Fastest lap: Jordan, 48.718s, 89.26mph.
Pole: Jordan, 48.228s, 90.16mph.

RACE 2: 27 LAPS, 32.613 MILES

1	JORDAN	Honda	25m15.787s
2	SHEDDEN	Honda	+0.505s
3	TURKINGTON	BMW	+0.709s
4	NEAL	Honda	+1.742s
5	FOSTER	BMW	+2.094s
6	COLLARD	BMW	+2.519s
7	MORGAN	Mercedes	+3.524s
8	INGRAM	Toyota	+3.822s
9	GIOVANARDI	Ford	+4.146s
10	TORDOFF	MG	+5.814s
11	PLATO	MG	+6.623s
12	M JACKSON	Ford (S)	+7.027s
13	SMITH	Volkswagen (S)	+7.175s*
14	GOFF	Vauxhall (S)	+7.238s*
15	WARREN SCOTT	(GB) Team BMR Vauxhall Insignia	+7.377s*

Winner's average speed: 77.45mph. Fastest lap: Tordoff, 48.975s, 88.79mph.
Pole: Jordan. * time penalties: 4.2s for Smith; 1.7s for Goff; 1.0s for Scott.

RACE 3: 27 LAPS, 32.613 MILES

1	TURKINGTON	BMW (S)	24m21.546s
2	NEAL	Honda (S)	+1.114s
3	PLATO	MG (S)	+1.446s
4	COLLARD	BMW (S)	+2.432s
5	ALAIN MENU	(CH) Team BMR Volkswagen Passat CC	+2.660s
6	SHEDDEN	Honda (S)	+3.378s
7	M JACKSON	Ford	+3.550s
8	GOFF	Vauxhall	+3.803s
9	DAVE NEWSHAM	(GB) AmD Tuning Ford Focus ST	+6.395s
10	MORGAN	Mercedes (S)	+8.728s
11	AUSTIN	Audi (S)	+9.632s
12	TORDOFF	MG (S)	+10.173s
13	JORDAN	Honda (S)	+10.761s
14	JAMES COLE	(GB) United Autosports Toyota Avensis (S)	+11.184s
15	HUNTER ABBOTT	(GB) Rob Austin Racing Audi A4	+13.357s

Winner's average speed: 80.33mph. FL: Plato, 48.881s, 88.94mph. Pole: Collard. (S) = used soft tyres in this race.

CHAMPIONSHIP

1	JORDAN	47	6	COLLARD	34
2	NEAL	45	7	MORGAN	18
3	TURKINGTON	44	8	TORDOFF	17
4	SHEDDEN	40	9	FOSTER	16
5	PLATO	38	10	AUSTIN	16



Scott ended his day in the pitwall

POINTS SYSTEM EXPLAINED
In each race:
20-17-15-13-11-10-9-8-7-6-5-4-3-2-1 to top 15 finishers.
Additional point for being fastest in qualifying, and for leading a lap.

FOR IN-DEPTH RESULTS **FORIX**
forix.autosport.com

Jordan sees off the BTCC 'oldcomers'

Seven champions and 30 cars made the Brands opener a tightly contested affair, and Andrew Jordan led the way. By **KEVIN TURNER**



MUCH OF THE TALK BEFORE THE BRITISH TOURING Car opener at Brands Hatch last weekend was of returning champions Alain Menu and Fabrizio Giovanardi, but it was a more-recent star who came away with the championship lead.

Andrew Jordan snatched pole from Jason Plato in the final minutes of qualifying and then controlled the first two races, while several other potential rivals hit trouble.

The Eurotech Honda might have slipped to a quiet 13th on the soft Dunlop tyre in the finale, but Jordan looks very capable of repeating his crown.

Works Honda ace Matt Neal certainly thinks so. "Someone's going to have to go bloody well to beat Andy this year," he said. "He's looking really strong."

JORDAN'S JOY

Jordan and Plato ran away from the field in race one after a little bit of luck at the first corner.

"I didn't get a great start and then got a crack from behind that sent me sideways," reckoned Jordan. "Jason was on the outside and helped straighten me up. If he hadn't been there it would probably have let Colin [Turkington] up the inside.

"At one point Jason came back at me and I was just keeping something back for the tyres."

The Honda was then able to hold off Gordon Shedden's new Civic Tourer in the second encounter, despite a big slide at Paddock. That performance was particularly impressive, given Jordan's 45kg of success ballast and the competitiveness of the grid – half a second had



Reigning champion celebrates after taking the early points lead

covered the top 16 in qualifying. "Winning with ballast is always sweet," he added. "The weight is going to hurt this year because the grid's so close, but I'd rather have the 45kg for a win than not."

Part of Jordan's strength is continuity. For the third year in a row he has fundamentally the same kit in the successful Civic hatchback, while many others acquaint themselves with new machinery. "We had a good car so we didn't want to change it too much, but you don't want to stand still," he said.

PLATO'S PAIN

Plato should have been Jordan's closest challenger, but he came away fifth in the championship, nine



Jordan recovered from this moment to win race one



Plato should have got more from his weekend

points off the lead. That was largely due to a strange electrical issue that struck just before race two.

Prior to that, the MG6 had topped both free practice sessions and held pole for most of qualifying. Considering the problems Plato had experienced in the tests leading up to Brands, the Saturday performance was welcome.

"We had a persistent steering issue and we couldn't get to the bottom of it, but we've cured it now," he said. "It's my car again, which is a relief."

Plato looked confident behind Jordan in race one and, with less success ballast than his rival, thought he had a decent shot at victory in the second event. But then trouble arrived.

"As soon as the five-second board was shown the car went into limp-home mode and the only way to fix that is a complete shutdown," said an angry Plato. "I didn't want to do that on the grid as it would stop me radioing the team, so I managed to clutch-slip it and limp off before bump-starting it."

"We knew we were going to have pace; that's what makes it so frustrating. You do everything right and the weekend gets f****d, because it hurts race two and race three. It's simply not good enough. This year, if you have one DNF or problem like that you'll only just get back into the points [by the end of the day]."

A fired-up Plato nevertheless underlined the



Turkington and Neal both scored heavily

Triple Eight-run MG6's pace with a storming drive in the finale, coming through from 11th to finish on Neal's tail in third using the soft tyre.

HONDA AND BMW IMPRESS

If Jordan's weekend was textbook and Plato's dramatic, then Neal's was one of stealth. The Dynamics squad still hasn't quite got a handle on the new Honda estate, but Neal took a third, a fourth and a second to leave Brands just two points behind Jordan.

"With the level of competition in qualifying I couldn't have dreamt of those results," admitted the triple champion. "We're still learning a lot – we've not just got a new chassis, we've got a new engine and new tyres. And the twisty Brands Indy circuit shouldn't suit us."

Shedden also came away with a good haul, although he didn't look quite as strong as Neal across the balance of the weekend. Dynamics boss Steve Neal admitted the two drivers had run different set-ups to aid the learning process.

"The results are probably slightly flattering," he said. "We tried different set-ups on the two cars and I think Matt's was a bit better than Flash's."

The other race winner from Brands also looks a serious bet for the title. The whole WSR team liked the revised BMW 125i M Sport – at one point they ran 1-2-3 in the finale – and Turkington was quick whenever the car was working.

He was one of five drivers under the 2013 pole time in qualifying and only some clever defending from Plato prevented Turkington's rear-wheel-drive machine challenging for the lead into Paddock in race one. He fell backwards with a front-rollbar issue, ending up eighth, but charged up the field – and onto the tail of the Jordan-Shedden lead battle – in race two.

After dispatching team-mates Nick Foster and Rob Collard with moves at Paddock in the reversed-grid finale, Turkington looked after the soft rubber to make it home ahead of a battling Neal and Plato.

"It's a massive improvement from last year," said the 2009 champion. "It's more stable in high-speed corners and better over kerbs. We've made the big steps, now we're doing the small tweaks to find the odd tenth or two. It's a great day for me. We weren't sure what to expect, but now it's a good racecar."

"We've come out of the blocks very quickly and I think we're in good shape."

It was a fitting lift for the team after Collard's engineer, Craig Parley, had suffered a fall from the pitwall on Saturday. At first his injuries were thought to be minor, but it later transpired that he had fractured a tibia and shattered a knee.

THE 'NEW' OLD GUARD

So what of the two other champions, Menu and Giovanardi? Menu and his new BMR squad probably had more to cheer, even if the man himself maintains a title challenge is unrealistic in 2014.

A number of issues, including power- ▶



This race-one moment cost Menu dear...

► steering problems, prevented Menu from much running in free practice, so he was happy to qualify the Passat CC eighth, just behind Aron Smith in the sister VW. A tap at Paddock that sent Menu off the road spoiled race one and the second outing was a struggle on the soft tyre.

Nevertheless, his pace in between – and Smith’s run to seventh in the first stanza – provided some optimism. That was backed up when Menu stormed from row eight to fifth in the final race.

“I enjoyed that one,” said the 50-year-old. “It’s unfortunate the weekend didn’t start better for me, but there are loads of positives because the car is competitive. We have a car capable of being in the top six and we’ll continue to work and improve it.”

“It’s good to be back, but I enjoy it when I’m winning. I don’t think we are ready as a team to win the title – we have things to learn – but the boys did a great job to get where we are. The car is more competitive than I expected it to be.”

The opposite could be said for Giovanardi, at least for the first part of the weekend. He was initially mystified after qualifying 18th, until a throttle issue was discovered. Progress in race one was limited to 14th, but things improved for race two, a good start helping him to ninth.

“In the first race I didn’t have the pace to pass anyone, but between races one and two we found some more speed and the car was much faster,” said the Italian, who lost the chance for a better race-three result when he spun at the first corner. “Now I feel I understand the car so we can develop it properly.”

“At the end of the weekend I’m frustrated because I don’t think the results we got are a reflection of the car.”

MORE TO COME FROM CHALLENGERS

There were a number of other strong performances that didn’t get the results they deserved.

Motorbase’s Mat Jackson qualified a fine ninth, a quarter of a second off pole, and shot to sixth at the start of race one, only to be forced off the road at Clearways by former team-mate Smith.

Rob Austin brilliantly rose from row five to challenge the works Hondas in race one with his Audi, but propshaft failure before the green-flag laps next time out hurt his weekend.

Reigning Ginetta GT Supercup champion Tom Ingram stunned everyone with sixth in qualifying on his first BTCC outing, driving a revised Speedworks Toyota Avensis. Poor starts didn’t help the 20-year-old in the races, but a ninth and an eighth indicated he could be a thorn in the side of the established stars during the season. It was unfortunate that his debut ended in the barriers after a clash with Menu exiting Graham Hill Bend.

Despite all the fine flashes of performance, though, the name at the top of the pile had a familiar ring to it. Jordan has set himself up nicely to be the first man to claim a second successive BTCC crown since Giovanardi in 2008.

“It doesn’t bother me if other drivers have won a title or not,” said Jordan. “It’s just more people to beat. I knew we’d be in a strong position, but I didn’t feel the need to shout about it.”



Ingram starred on his BTCC debut with Speedworks



...and this off didn't help Giovanardi in the finale

DRIVER BY DRIVER



1 ANDREW JORDAN

Qualifying: 1 Race: 1/1/13

With no ballast he only had Plato to worry about. Then held off Shedden with 45kg in R2. Quiet R3.



30 MARTIN DEPPER

Qualifying: 17 Race: DQ/R/R

A tough return to the BTCC. Races were all spoiled by contact, twice with Marc Hynes.

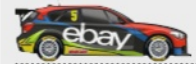

5 COLIN TURKINGTON

Qualifying: 3 Races: 8/3/1

Happy with quality effort, less so with the front-rollerbar issue that slowed him in R1. Impressive thereafter.

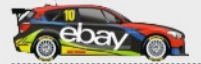

10 ROB COLLARD

Qualifying: 10 Races: 6/6/4

Was clearly happier with the revised, more-stable 125i M Sport. Couldn't match Turkington, but a good haul.



9 ALAIN MENU

Qualifying: 8 Race: 27/17/5

Reckoned free-practice issues hid car's true performance. Great R3 charge, apart from Ingram clash.



40 ARON SMITH

Qualifying: 7 Race: 7/13/R

Initially had the better of the VW Passat luck and had good pace, but got into too much trouble.



80 TOM INGRAM

Qualifying: 6 Race: 9/8/R

Best non-BTCC champ in quality and looked good running in top 10. Perhaps a tad naive with Menu in R3.



11 SIMON BELCHER

Qualifying: 25 Race: 21/23/21

Largely anonymous weekend for the ex-Clio racer, but he stayed out of trouble better than some.

IN THE PADDOCK

KEVIN TURNER
FEATURES EDITOR

@KRT917



TIME FOR SOME HONESTY. BEFORE last weekend I was worried that the MSAs new track-limits rules – no wheels over the white lines or kerbs – would cause chaos. Being quick, especially in a touring car, often involves using lots of kerb or grass-cutting on a corner apex, so there was a chance the edict could overshadow the meeting.

Fortunately, I was wrong. The new cameras installed at Druids and Graham Hill Bend, along with the extended kerb at Paddock Hill Bend, made the rule easier to police consistently. Some warnings during practice and four disallowed qualifying times showed the drivers that the rule would be enforced, and they responded by driving to slightly different limits and being neater.

"With a modest investment it's policeable," reckoned circuit owner Jonathan Palmer, who has already decided to install similar systems at his other BTCC tracks, Snetterton and Oulton Park. "It's transformed overnight and it's so much more impressive to see the drivers being precise."

It remains to be seen how other circuits enforce the change, and it will be interesting to find out what happens when international championships visit the UK, but the rule passed its first real test comfortably.



Hynes excluded as penalties fly

FORMER BRITISH FORMULA 3 champion Marc Hynes was excluded from the second BTCC race at Brands, and several other drivers were penalised.

The series debutant required an engine change before qualifying 16th and then failed to start race one thanks to a power-steering issue.

The Triple Eight MG driver's first series finish thus appeared to be 20th in race two, but Hynes was then excluded and handed four points on his licence for a clash with Martin Depper's Eurotech Honda Civic.

"We came out of Graham Hill Bend side by side," said Hynes. "I got the cutback and, from my perspective, he jinked back in."

"I thought it was a racing incident, but

the stewards thought differently."

Team BMR drivers Aron Smith (demoted from seventh to 13th), Jack Goff (11th to 14th) and Warren Scott (13th to 15th) also received time penalties for overtaking Mat Jackson behind the safety car.

Smith had received a five-place grid penalty ahead of the encounter for contact with Jackson in race one. An appeal allowed him to start from seventh instead of 12th, but the appeal was lost so he began race three from 18th instead of 13th.

Depper had previously been excluded from race one for a clash with James Cole, while Jack Clarke was handed three penalty points and will drop five grid slots at Donington Park for a race-three incident.

Morgan's Merc shows promise

ADAM MORGAN BELIEVES HIS NEW Mercedes A-class can run at the front despite a mixed debut at Brands Hatch.

The Ciceley Motorsport driver impressed in free practice, but only qualified 14th, albeit less than 0.4s from pole, and finished 13th in race one with a slow puncture.

Front-suspension tweaks helped ahead of race two and Morgan made a good start on his way to seventh. He then ran as high as sixth in the finale before his soft tyres went off and he finished 10th.

"We made loads of changes for race two and it transformed the car," said the 25-year-old. "I was quicker through the corners than the BMWs, but they'd pull away on the straights. We're obviously not as slippery through the air as we thought."

"We've had a relatively good day for a new car. We've definitely got serious potential to be at the front."



49



4 MATT NEAL
Qualifying: 4 Race: 3/4/2
Classic Neal weekend. Was up near the front throughout to score good points in underdeveloped estate.



52 GORDON SHEDDEN
Qualifying: 5 Race: 4/2/6
Not a great meeting as team chased a set-up balance, but avoided the usual Shedden Brands Indy disaster.



99 JASON PLATO
Qualifying: 2 Race: 2/11/3
Only man to really challenge Jordan on pace. Furious after R2 failure, but storming drive in R3 to take third.



88 SAM TORDOFF
Qualifying: 12 Race: 10/10/12
Pretty anonymous all weekend. Not comfortable with car in qualifying and never really recovered.



888 MARC HYNES
Qualifying: 16 Race: NS/DQ/18
A trying debut. Engine change before qualify, power-steering issues before R1 started, disqualified for contact in R2.



33 ADAM MORGAN
Qualifying: 14 Race: 13/7/10
Tad disappointed with qualify, but made progress during races. Merc should become a threat.



18 NICK FOSTER
Qualifying: 13 Race: 11/5/19
Arguably his best weekend in the BTCC. Shame about R3 drive-through penalty for starting out of position.



6 MAT JACKSON
Qualifying: 9 Race: 15/12/7
Perhaps one of his best qualify efforts, ruined by punt from Aron Smith in R1. Good racing in R3. Has his mojo back.



7 FABRIZIO GIOVANARDI
Qualifying: 18 Race: 14/9/16
Throttle issue in qualify, slow puncture in R1 and an off in R3, but kept smiling. Still learning NGTC.



44 JACK CLARKE
Qualifying: 26 Race: 19/19/17
Torrid start to tin-top career for the ex-single-seater racer. Car trouble in qualify and failed to score a point.



17 DAVE NEWSHAM
Qualifying: 20 Race: 17/16/9
AmD squad is still learning its new Ford Focus, with the help of Motorbase. Good charge in R3.



43 LEA WOOD
Qualifying: 24 Race: 22/R/R
Barely any running with new Toyota before Brands weekend and clutch problems struck on raceday.



31 JACK GOFF
Qualifying: 15 Race: 12/14/8
Bizarre set-up issue hampered him in qualify, but again showed promise. Was one of the quickest at end of R3.



39 WARREN SCOTT
Qualifying: 22 Race: 16/15/23
"I'm learning so much from the other three drivers," said Scott. It showed, with his best BTCC event thus far.



101 ROB AUSTIN
Qualifying: 11 Race: 5/R/11
Decent pre-season testing allowed Austin to start well. Strong race pace either side of R2 propshaft failure.



54 HUNTER ABBOTT
Qualifying: 21 Race: 18/18/15
Solid start for the former GT racer. Would not be a surprise to see more points finishes in 2014.



20 JAMES COLE
Qualifying: 19 Race: R/21/14
United Autosports team is still learning intricacies of NGTC. Encouraging points finish in final encounter.



21 GLYNN GEDDIE
Qualifying: 23 Race: 20/20/25
Various small niggles held him back. Reckoned 10th or 11th could have been possible in qualify.



67 ROBB HOLLAND
Qualifying: 28 Race: 23/22/20
American was happy to make a reliable start in new Audi S3, on which he hopes to build more pace.



28 CHRIS STOCKTON
Qualifying: 30 Race 26/R/NC
Diff issue stopped the new Cruze coming out for qualify and it was an uphill struggle from there.



16 AIDEN MOFFAT
Qualifying: 27 Race: 24/24/24
Radiator leak onto tyres slowed him in qualify. Reckons there is a lot more to come from ex-Andy Neate car.



48 OLLIE JACKSON
Qualifying: 29 Race: 25/25/22
Car, with new Proton engine, was only just completed in time so three finishes was a good effort.

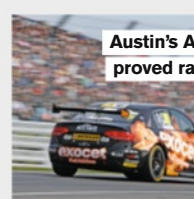

Austin's Audi proved rapid

P50
ALL THE ACTION FROM THE BTCC SUPPORTS



Robertson (55) and Watson won a race apiece

GINETTA GT4 SUPERCUP BRANDS HATCH (GB), MARCH 29-30

Watson in charge, Robertson stars

THREE DRIVERS SHARED THE SPOILS AS GINETTA'S rebranded GT4 Supercup fired into life at Brands Hatch with an entertaining trio of races.

Andrew Watson converted pole into victory in the opening race, but it was Pepe Massot who led early on before being adjudged to have jumped the start. When Massot was black-flagged for not serving a drivethrough penalty, Watson duly led home Jamie Orton and single-seater refugee Charlie Robertson, excelling on his debut in a G55. Carl Breeze fought off Junior champion Harry Woodhead and Tom Oliphant for fourth.

Watson again led from pole in the second race, managing with ease an immediate safety car triggered by a three-car incident. That was caused by Breeze hitting Orton into Paddock for the first time, with Woodhead running wide and collecting them as they careered into the gravel.

At the restart, Watson headed Robertson, whose poor getaway first time around had kept him well clear of the first-corner melee, and the pair gradually edged away from a four-car fight for third. The youngsters ran in tandem until

mid-distance, when a mistake from the leader at Surtees resulted in a trip across the grass and a damaged splitter. Robertson needed no second invitation, diving by at Clearways a lap later.

As he streaked clear, Watson held on for second ahead of David Pittard, whose weekend started with a blown engine in practice but performed admirably as he and his SV Racing team acclimatised to a G55 they had barely run before Friday's practice session. Oliphant and Luke Davenport completed the top five with Huyton claiming reverse-grid pole in sixth.

While Huyton headed the pack at the start of the finale, Robertson charged through the field in the early stages. After a quick getaway moved him past Oliphant, he made short work of Pittard, Davenport and Watson to move into second.

Watson dropped to fifth following some argy-bargy with Davenport, and ahead Robertson attacked Huyton for the lead. They were inseparable through Clearways, and Robertson began to nose inside as they moved onto the start-finish straight. But Huyton moved across

and the pair made contact, inflicting a broken rim and a puncture on their respective cars and putting Huyton out of the race altogether.

That allowed Davenport to record a maiden victory, the GT5 Challenge champion seeing off the attentions of Oliphant and Watson to hand United Autosports a win on its debut weekend in the series. Pittard finished fourth ahead of Massot and Will Burns. Eleventh and fastest lap was scant consolation for Robertson, though he is second in the points, 21 behind Watson.

● Scott Mitchell

RESULTS

Race 1 (15 laps) 1 Andrew Watson; 2 Jamie Orton +1.079s; 3 Charlie Robertson; 4 Carl Breeze; 5 Harry Woodhead; 6 Tom Oliphant. **FL** Watson 48.039s (90.52mph). **Race 2 (27 laps) 1 Robertson;** 2 Watson +5.865s; 3 David Pittard; 4 Tom Oliphant; 5 Luke Davenport; 6 Sean Huyton. **FL** Carl Boardley 48.588s (89.49mph). **Race 3 (24 laps) 1 Davenport;** 2 Oliphant +1.014s; 3 Watson; 4 Pittard; 5 Pepe Massot; 6 Will Burn. **FL** Robertson 48.753s (89.19mph). **Points 1 Watson, 93;** 2 Robertson, 72; 3 Oliphant, 70; 4 Davenport, 66; 4 Pittard, 64; 6 Reece Somerfield, 40.

BRITISH FORMULA FORD BRANDS HATCH (GB), MARCH 29-30

Experienced Kruger nets steely double

JAYDE KRUGER TWICE OVERCAME POLEMAN Harrison Scott to secure a pair of wins and a narrow British Formula Ford points lead.

The South African was more alert when the lights went out in race one, outdragging Scott into Paddock to decide the opener at the first corner. Sam Brabham headed the early battle for third but series debutant Jack Barlow demoted him with a superb move at Druids in the closing stages.

Juan Rosso attempted to follow the Jamun driver through but lost control and spun, sending Brabham airborne and into retirement. Ricky Collard benefited to take fourth on his car racing debut, ahead of Max Marshall and James Abbott.

Abbott claimed the reversed-grid pole and raced into an early lead, with Marshall in pursuit until Collard nailed him at Druids on lap two. Scott

demoted him further with a superb move into Paddock and passed Falcon team-mate Collard at Clearways, but was forced to settle for second behind Abbott — with Collard an impressive third ahead of Marshall, Barlow and Kruger.

Scott headed Kruger in the finale until Collard attempted to pass Marshall for third at Druids, but was left stranded when they collided, causing a safety car. Kruger nerfed Scott at Surtees as they prepared for the restart, and Scott claimed further contact made him run wide at Paddock.

That let Kruger through to win and a similar mistake from Scott a lap later handed Rosso second and Brabham third. Scott held on to fourth ahead of a charging Barlow, who had dropped to 14th at the start before an entertaining recovery.

● Scott Mitchell



Kruger gave JTR a pair of wins

RESULTS

Race 1 (26 laps) 1 Jayde Kruger (Mygale M12-SJ); 2 Harrison Scott (Mygale M13-SJ) +1.129s; 3 Jack Barlow (M12); 4 Ricky Collard (M12); 5 Max Marshall (M12); 6 James Abbott (M13). **FL** Kruger 46.072s (94.38mph). **Race 2 (26 laps) 1 Abbott;** 2 Scott +0.437s; 3 Collard; 4 Marshall; 5 Barlow; 6 Kruger. **FL** Marshall 46.045s (94.44 mph). **Race 3 (25 laps) 1 Kruger;** 2 Juan Rosso (M13) +1.147s; 3 Sam Brabham (M12); 4 Scott; 5 Barlow; 6 Abbott. **FL** Scott 46.022s (94.48mph). **Points 1 Kruger, 79;** 2 Scott, 77; 3 Abbott, 66; 4 Barlow, 64; 5 Marshall, 59; 6 Rosso, 57.

PORSCHÉ CARRERA CUP GB BRANDS HATCH (GB), MARCH 29-30

Guest Barker steals the spotlight

PORSCHÉ SUPERCUP STAR BEN BARKER GATECRASHED the opening round of the Carrera Cup GB with two well-crafted victories over two-time champion Michael Meadows, but Barker's guest-driver status – and ineligibility for points – meant that an unprecedented third title already beckons for the Redline-run driver.

Sunday morning's race, the first British round with the more powerful 991 GT3 Cup machine that was used in the Supercup last year, was effectively decided at the standing start, with Barker stating later it was crucial to lead at Turn 1.

Although poleman Meadows' reaction to the lights was decent enough, Barker's superior second phase of the launch meant he arrived at Paddock clear of Meadows and GP3 refugee Josh Webster. Karl Leonard grabbed fourth as fourth-placed qualifier Jake Hill "lit up" his rear wheels off the startline and fell to fifth.

Barker pulled out a two-second lead by lap 10 as Meadows slipped back, but the champion vowed to learn from the winner's driving and tyre management of the new machine, that he'd raced for a season last year, for the second race.

Webster was a distant but unchallenged third, while Leonard lost fourth when stewards penalised him for exceeding track limits. "I think that was a bit harsh," he reckoned, and beneficiary Hill backed the judgement: "He was unlucky the second time, he only just caught the sensor, and I feel for him... but not that much!"

Victor Jimenez inherited fourth following a stunning comeback drive after he bogged down at



the start and fell to the rear of the pack. Leonard was 0.159s behind once his 5s penalty was applied, with Paul Rees 0.676s shy of deposing him further.

Meadows did everything right to lead the pack on the series' first ever rolling start, but Barker was the last of the late brakkers into Paddock and grabbed the lead once again. "I worked really hard to warm up the tyres on the left-hand side of the car so I could go really late on the brakes round the outside at Paddock," he revealed later.

Meadows kept Barker in sight throughout, and got within 0.7s with five laps to go when backmarkers loomed ahead, but settled for second and rued his points-wary caution at the start.

Hill drove superbly to finish third, having only driven his car for the first time last Friday, just holding off Webster, who had been elbowed down to fifth on the opening lap at Graham Hill Bend and had to battle past Jimenez.

● Charles Bradley

RESULTS

Race 1 (34 laps) 1 Ben Barker; 2 Michael Meadows +1.739s; 3 Josh Webster; 4 Jake Hill; 5 Victor Jimenez; 6 Karl Leonard.

FL Barker 46.546s (93.42mph). **Race 2 (33 laps) 1 Barker;** 2 Meadows +1.954s; 3 Hill; 4 Webster; 5 Jimenez; 6 Paul Rees.

FL Meadows 47.047s (92.43mph). **Points 1 Meadows, 44;** =2 Hill & Webster, 34; 4 Jimenez, 28; 5 Rees, 22; 6 Justin Sherwood, 19.



RENAULT CLIO CUP UK BRANDS HATCH (GB), MARCH 29-30

Morgan on top as new Clio era begins

WELSHMAN ALEX MORGAN USHERED IN THE TURBO age of Renault Clio racing in the UK with two starkly different wins across the weekend.

On Saturday, Morgan leapt into an immediate lead from pole as fellow front-row man Mike Bushell bogged down and then slewed sideways at Paddock, quickly regaining control but dropping to fourth and inadvertently sending the close-following Paul Rivett into a grassy spin.

Morgan controlled the gap over Rob Smith, stretching his legs to win by almost five seconds as Smith eased off with a slow puncture. Josh Cook, who started sixth, drove a superbly defensive race (with bent suspension from a startline clash) to hold third despite an onslaught from behind by Bushell and Lee Pattison, the latter grabbing that spot from James Colburn at Druids.

Sunday's contest was far more entertaining at

the front, as Morgan had to fend off the stern challenges of first Bushell and then Rivett, once the former champion had pulled off a superb, round-the-outside move on Bushell at Druids.

Morgan admitted he was "looking backwards more than forwards" as he repelled the persistent Rivett to the finish. Bushell just held off the feisty Ant Whorton-Eales, who surged past Cook early on and passed Smith at Clearways near the end.

● Charles Bradley

RESULTS

Race 1 (both 20 laps) 1 Alex Morgan; 2 Rob Smith +4.644s; 3 Josh Cook; 4 Mike Bushell; 5 Lee Pattison; 6 James Colburn.

FL Paul Rivett 53.118s (81.86mph). **Race 2 1 Morgan;** 2 Rivett +0.154s; 3 Bushell; 4 Ant Whorton-Eales; 5 Smith; 6 Colburn. **FL** Bushell 52.895s (82.21mph). **Points 1 Morgan, 64;** 2 Bushell, 49; 3 Smith, 48; 4 Rivett, 40; 5 Cook, 39; 6 Colburn, 36.

GINETTA JUNIOR BRANDS HATCH (GB), MARCH 29-30

Motorbase man Mitchell takes two

MOTORBASE ACADEMY DRIVER JACK MITCHELL opened his season with a brace of wins at his local track but each time he had to overcome the faster-starting Ryan Hadfield to do so.

On Saturday he wheelspun his pole advantage away, only to retake the lead from Hadfield at Clearways at the end of the opening lap. Hadfield slipped back to fourth as James Kellett and Jamie Chadwick demoted him at Druids, and spent the remainder fending off younger brother Jonathan.

It was a near-mirror image on Sunday, as Ryan Hadfield led from the outside of the front row. He fended off Mitchell for a couple of laps before running wide at Clearways and allowing Mitchell to outrag him along the start-finish straight.

Ben Pearson came through to third, benefiting from a startline pile-up that removed Chadwick and delayed Kellett. The latter then battled back to seventh, before spinning again on the penultimate lap at Druids.

● Charles Bradley

RESULTS

Race 1 (both 14 laps) 1 Jack Mitchell; 2 James Kellett +2.415s; 3 Jamie Chadwick; 4 Ryan Hadfield; 5 Jonathan Hadfield; 6 Lando Norris. **FL** Mitchell 57.177s (76.05mph) **Race 2 1 Mitchell;**

2 R Hadfield +3.007s; 3 Ben Pearson; 4 Jack Rawles; 5 Dan Zelos; 6 J Hadfield. **FL** Mitchell 57.465s (75.67mph). **Points 1 Mitchell, 74;** 2 R Hadfield, 52; 3 Pearson, 42; 4 J Hadfield, 38; 5 Kellett, 36; 6 Rawles 34.

INDYCAR

St Petersburg (USA)

March 30

Round 1/15

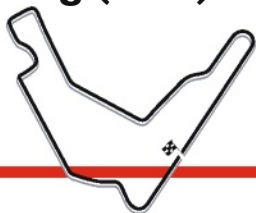

RESULTS

110 LAPS, 198 MILES

1	WILL POWER (AUS)	2h06m57.6288s	
	Team Penske Dallara-Chevrolet; Grid: 4th-1m02.3955s		
2	RYAN HUNTER-REAY (USA)	+1.9475s	
	Andretti Autosport Dallara-Honda; Grid: 3rd-1m02.2167s		
3	HELIO CASTRONEVES (BR)	+7.8716s	
	Team Penske Dallara-Chevrolet; Grid: 10th-1m03.6635s		
4	SCOTT DIXON (NZ)	+15.9685s	
	Chip Ganassi Racing Dallara-Chevrolet; Grid: 5th-1m02.4454s		
5	SIMON PAGENAUD (F)	+17.3937s	
	Schmidt Peterson Hamilton Motorsports Dallara-Honda; Grid: 14th-1m12.3741s		
6	TONY KANAAN (BR)	+20.3882s	
	Chip Ganassi Racing Dallara-Chevrolet; Grid: 2nd-1m02.1637s		
7	TAKUMA SATO (J)	+20.8561s	
	AJ Foyt Racing Dallara-Honda; Grid: 1st-1m01.8686s		
8	JUSTIN WILSON (GB)	+21.0622s	
	Dale Coyne Racing Dallara-Honda; Grid: 16th-1m12.5890s		
9	JOSEF NEWGARDEN (USA)	+21.5544s	
	Sarah Fisher Hartman Racing Dallara-Honda; Grid: 22nd-1m13.1170s		
10	RYAN BRISCOE (AUS)	+23.9897s	
	Chip Ganassi Racing Dallara-Chevrolet; Grid: 9th-1m03.6206s		
11	SEBASTIAN SAAVEDRA (CO)	+34.4041s	
	KVAFS Racing Dallara-Chevrolet; Grid: 11th-1m03.8374s		
12	MIKHAIL ALESHIN (RUS)	+34.9969s	
	Schmidt Peterson Motorsports Dallara-Honda; Grid: 15th-1m15.9111s		
13	SEBASTIEN BOURDAIS (F)	+35.3526s	
	KVSH Racing Dallara-Chevrolet; Grid: 13th-1m15.8337s		
14	GRAHAM RAHAL (USA)	+38.9881s	
	Rahal Letterman Lanigan Racing Dallara-Honda; Grid: 21st-no time		
15	JUAN PABLO MONTOYA (CO)	+40.3350s	
	Team Penske Dallara-Chevrolet; Grid: 18th-1m12.6994s		
16	MIKE CONWAY (GB)	+40.9140s	
	Ed Carpenter Racing Dallara-Chevrolet; Grid: 12th-1m03.9618s		
17	CARLOS MUNOZ (CO)	+44.6244s	
	Andretti - HVM Dallara-Honda; Grid: 7th-1m03.3955s		
18	CARLOS HUERTAS (CO)	+47.5637s	
	Dale Coyne Racing Dallara-Honda; Grid: 17th-1m16.8105s		
19	JAMES HINCHCLIFFE (CDN)	-1 lap	
	Andretti Autosport Dallara-Honda; Grid: 19th-2m24.4862s		
20	CHARLIE KIMBALL (USA)	-2 laps	
	Chip Ganassi Racing Dallara-Chevrolet; Grid: 20th-1m13.0048s		
21	JACK HAWKSWORTH (GB)	83 laps-accident damage	
	Bryan Herta Autosport Dallara-Honda; Grid: 8th-1m03.5738s		
22	MARCO ANDRETTI (USA)	82 laps-accident	
	Andretti Autosport Dallara-Honda; Grid: 6th-1m02.9595s		

Winner's average speed: 93.572mph. Fastest lap: Power, 1m02.3404s, 103.945mph.
All drivers in Dallara DW12

CHAMPIONSHIP

1	POWER	53	6	KANAAN	28
2	HUNTER-REAY	40	7	SATO	28
3	CASTRONEVES	36	8	WILSON	24
4	DIXON	32	9	NEWGARDEN	20
5	PAGENAUD	30	10	BRISCOE	20

POINTS SYSTEM EXPLAINED:

50-40-35-32-30-28-26-24-22-20-19-18-17-16-15-14-13-12-11-10-9-8-7-6 for the top 24, with 5 for all other starters. 2 points for leading the most laps, 1 point for leading at least one lap, 1 point for pole position.

Kanaan took 'Dario'

#10 to front row



ABBOTT/GETTY

FOR IN-DEPTH RESULTS
forix.autosport.com



Power makes his play for maiden Indy title

Once the Australian had got an early pitstop out of the way, he was invincible in St Petersburg. By **MARK GLENDENNING**

YOU CAN CHANGE SOME PERIPHERALS – GET THE two most recent championship-winning teams to swap engine manufacturers, bring Juan Pablo Montoya back into single-seaters, plant four rookies in the field – but the fundamentals generally don't change. Example: when Will Power gets the bit between his teeth, the results can be scary.

After a few years as a perennial contender – 'contender' being the key word, given that the championship remains elusive – Power had a frustrating IndyCar season in 2013. He finished on the best possible note with a commanding win at Fontana, the track where his title hopes had unravelled 12 months earlier, but nothing threatens to dampen momentum like a five-month off-season. Power enjoyed a strong finish to last year, but how much of that form could he carry through a long winter hibernation?

If St Petersburg was any guide, the answer is: quite a lot. And at least some of that owes a bit to some soul-searching by the Team Penske-run Australian during his 2013 struggles.

"You definitely start to look pretty hard when you have a long period of not winning," he said on Sunday. "You can't get complacent. You've got to keep working hard, especially in this series. It's a good kick in the ass to have bad runs. You reset; you realise that you can't leave anything on the table.

"It's funny. I was speaking to Mark Webber last year and asked him, 'Did you lose a little bit of motivation in your thirties?' He said, 'Yeah. You can't kid yourself. You've got to work hard. If you're not, someone else is.'"

For an active driver to even hint at past complacency is all but unheard of, but Power



Sato claimed pole and led early stages

LEVITTI/LAT

marches to a different tune to most. And besides, if you're ever going to reveal a spot of vulnerability, there's no better time than when you've just given everyone else a pounding.

Polesitter Takuma Sato led during the opening phase of the race, but Power, running third, wasted little time in taking matters into his own hands. The Penske team called him in early to ditch the scrubbed option tyres he'd started the race on and, although he was out of synch with the leaders when he rejoined to commence a long stint on the harder rubber, the strategy dictated much of what was to follow.

That stop gave Power seven laps in clearish air and, when Sato rejoined from his own visit to the pits at the end of that spell, he exited pitlane right in front of Power, and on cold tyres. The inevitable came just a couple of laps later, when the Penske car waltzed around the outside of Sato at Turn 1. For Power, who started the weekend with a pole-to-win



Power was out on his own for last two thirds of the race

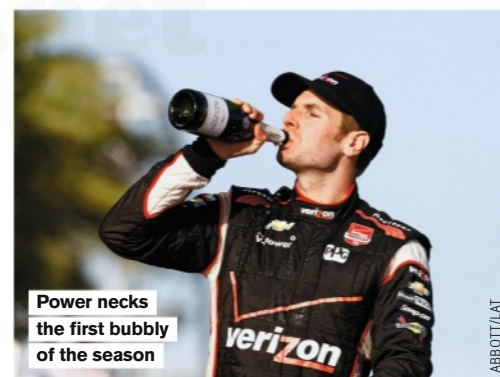

Power necks the first bubbly of the season

ABBOTT/LAT



Conway (left) battled to temporary third, here passing Andretti

ratio at St Pete of 4:1, the move was sweetened by a touch of redemption. "I felt our car was definitely stronger on blacks [harder tyres] and was able to hunt him down and pull the move on him that I've had pulled on me two years in a row," he said. "I learned my lesson and finally pulled it off myself."

Unfortunately for Sato, Power's car was not the only one superior to his on the harder tyres, and over the next two black-shod stints the AJ Foyt Racing driver slipped steadily out of podium contention.

Sato's fade heralded the arrival of Helio Castroneves, Ryan Hunter-Reay and Mike Conway into the podium battle, and the fortunes of all three were determined by the same incident.

It began incongruously enough when Charlie Kimball shuffled into the barrier and brought out the first safety car of the race after an uncharacteristically long 78-lap spell under greens. Under new series rules, the pits were closed at the

beginning of the full-course caution, meaning that virtually the entire field would pit under yellows when the option became available next time around.

Accordingly, nearly everyone did. But Conway, running third in the first race of his ride-share deal with Ed Carpenter Racing, didn't hear the command to pit and went around again. In the process, he misinterpreted a signal from the pace car waving James Hinchcliffe past as an invitation to himself, and earned a penalty as a result. It was a sad end to a strong performance.

"I thought the safety car waved me by but they were waving Hinchcliffe by instead," he said. "And that was it. It screwed up our whole day."

Then came the restart. The specifics of what happened when the race went green take some explaining (see p55), but the crux was: Power was slow to hit the gas; Castroneves, in second, was caught out; and Hunter-Reay was able to skip past.

The restart had more serious ramifications further back, where the rear half of the field concertinaed dramatically and resulted in Marco Andretti and Jack Hawksworth hitting the wall. This, inevitably, led to another caution period and a second restart, which went ahead without incident.

The race returned to green with 22 laps to go, and any ideas Hunter-Reay might have had about challenging Power were put to rest when the leader began to gap him at a rate of 0.3s per lap. With four laps remaining Power was 2.6s ahead, Hunter-Reay had a similar advantage over Castroneves, and the podium was set.

Reigning champion Scott Dixon took fourth, a result with which the Kiwi declared himself reasonably pleased given that his car wasn't working all that well. Rather happier was fifth-placed Simon Pagenaud, who appeared destined for a finish on the outer reaches of the top 10 before capitalising on all the caution-induced chaos to make up an extra three places.

Just behind him, Tony Kanaan began his Chip Ganassi Racing career with a sixth place – a good return for a driver whose street-course credentials have occasionally been called into question. TK himself felt that he could have finished even higher had he not had to take evasive action to avoid a clash with Hunter-Reay at one point.

"That cost us 0.5s, which equates to two positions out there," said the Indy 500 winner. "We had a top-five car, and finished sixth. Not the start we wanted, but we'll take it."

Another performance worthy of note was that of Josef Newgarden, who started from last and climbed through the field – in a race run mostly under green flags – to finish ninth. "We kept fighting," he said.

All the rookies had reason to be satisfied, but Hawksworth's debut with Bryan Herta Autosport was especially impressive. The Brit's immediate thoughts after the race were of the accident that prematurely ended his involvement, but up to that point he'd looked entirely at home. Anyone who dives down the inside of Montoya in their first race has just cause to feel pleased with themselves.

"It wasn't the end to the race that we wanted," he said. "But we had some really good pace on the red tyres, and I think that's really promising."

The writing was on the wall for 2013 St Petersburg winner James Hinchcliffe when he attempted to fire a T-shirt cannon prior to the race, only for the garment to flop out of the barrel and land at his feet. Starting from near the back, an array of mechanical problems prevented any early progress, and by the time they were sorted out he was too far back for it to matter.

And Montoya? A six-year street-course drought was broken with a 16th place. He was clearly a little rusty, but encouragingly quick during certain points of the race. "We were just burning up the rear tyres with the set-up," he said. "It was a little too aggressive. There are a few things we have to do better, but I didn't feel my pace was too bad there at the end." ▶



WE'LL KEEP YOU ON TRACK

MOTORSPORT INSURANCE

Grove & Dean Motorsport Insurance is one of Europe's premier on-track insurers for professional GT, Sports Car, Historic and Single Seater racing cars.

With a choice of bespoke European and international policies, a dedicated team and an in-house Claims Manager to take the hassle out of any incidents, you can rely on Grove & Dean Motorsport Insurance.

Our cover keeps you on track.

Policy Options Include:*

- Race / On-Track Cover
- Track / Test Day Cover
- Storage & Transit Cover
- Personal Accident Cover
- Discounts for multi-event and annual policies*
- Knowledgeable UK staff
- Open 7 days a week

*Subject to underwriting criteria

+44 (0)1708 606768

www.grove-dean-motorsport.com



Grove & Dean Motorsport Insurance is a trading name of Grove & Dean Motorsport Ltd. Grove & Dean Motorsport Ltd are an appointed representative of Grove & Dean Ltd. Grove & Dean Ltd are an independent intermediary who are authorised and regulated by the Financial Conduct Authority (FCA). For your security calls may be recorded.

THE CLASSIC BRITISH WELCOME SAINT SATURNIN, NEAR LE MANS, FRANCE

A FESTIVAL OF
1000 CLASSIC & SPORTS CARS

Theme 2014



PORSCHE



Friday 13th June 2014
9 am to 5 pm



FREE ENTRY

www.classicbw.org



Creation: agence-erwinmedia.com / Photos: C. Brevignot, DR

IronmongeryDirect

MASTERS OF OUR TRADE

ORDER BY 8PM
GET IT NEXT DAY

- ✓ UK's Biggest Range
- ✓ FREE Delivery over £45
- ✓ Minimum 5 Year Guarantee
- ✓ FREE Returns

FULL RANGE AVAILABLE ONLINE

Download our FREE App!



CALL 8am-8pm 7 days a week

0808 168 28 28



ONLINE Shop 24/7!

IronmongeryDirect.com



CALL TODAY
FOR YOUR FREE CATALOGUE
OR TEXT RBA16 to 62244 FREE with name, address and email.

IN THE PADDOCK

MARK GLENDENNING
INDYCAR CONTRIBUTOR

@m_glendenning



AS A LONG-TIME STUDENT OF THE sport, Dario Franchitti probably spent an awful lot of time aspiring to be Rick Mears. Now, in his new, loosely defined role within Chip Ganassi Racing, the Scot is seeking to do so again.

Since retiring from racing, Mears has remained part of the Penske organisation as a 'well-informed observer'; a role that loosely describes what Franchitti is now doing within Ganassi.

Franchitti admits that the contribution Mears has made to Penske is something that he now seeks to emulate.

"Rick and I haven't really talked about that, because obviously there's a big rivalry there [between the teams]," he said.

'Rick' Franchitti
talks things over
with Kanaan

TROTMAN/GETTY

"I tell you this, though. Every time I talk to Rick, I learn something. And I wish that I'd him in my corner for my recent career, because there's a few races that I maybe threw away that I wouldn't have had Rick been there. So if I can help the Ganassi guys half as much as Rick's helped the guys at Penske, I'll be pretty happy."

Roger Penske explained that Mears's

contribution to his team is wide-ranging.

"He's a voice for the drivers," he said. "He's talking a lot with Juan Pablo [Montoya] about what he sees, and he has really tried to work with Will [Power]. Dario does have that feel, and it's a good move. It keeps him connected, and I'm anxious to see how he likes sitting on the sidelines rather than being in the middle of the fire."



LEVIT/LAT

KARAM'S INDY CHANCE

Chip Ganassi Racing is weighing up running a fifth car at the Indianapolis 500 for reigning Indy Lights champion Sage Karam (above), who is currently part of the team's United SportsCar line-up. Team owner Chip Ganassi said that Karam is the only candidate should the team's fifth Dallara-Chevrolet be confirmed.

HUERTAS AT COYNE

Colombian Carlos Huertas completed the St Petersburg field when he was named as the driver of the second Dale Coyne Racing entry. The British Formula 3 and Formula Renault 3.5 race winner, who tested with Panther Racing during the pre-season, has signed on for the full year.

PANTHER LYING LOW

Panther Racing's recent problems appear to have reached a crescendo, with the team failing to make the trip to St Petersburg. The team, which does not have a driver under contract, lost primary sponsor National Guard to RLL during the off-season.

ALESHIN TOP ROOKIE

Russian IndyCar debutant Mikhail Aleshin capitalised on the restart accident that accounted for Jack Hawksworth and Carlos Munoz (who was hit by the spinning Hawksworth, but continued) to finish as the highest-placed rookie. "I was close to being lost in the first corner, but we had a good strategy and quick car that helped me climb through the field," he said.

PENALTIES DISHED OUT

Mike Conway's penalty for passing the pace car helped to form a hat-trick of punishments issued simultaneously by race control. Sebastien Bourdais was penalised for not catching up quickly enough during the caution, while rookie Carlos Huertas was sanctioned for a full pit service when pitlane was closed.

ANDRETTI WRIST PAIN

Marco Andretti was nursing his wrist after the restart accident, although the Andretti Autosport driver escaped injury. "[The incident] was an accordion effect," he said. "That's what happens when you're in the back, so I've got no-one to blame but myself."

Power warned by IndyCar for 'clean' restart

First restart
caused chaos
behind Power

CHRIS JONES

WILL POWER WAS ISSUED A

warning for the restart at St Petersburg – but it was the second, 'clean' restart that drew the ire of race control, rather than the one that caused a pile-up.

Power's conduct during the first restart was called into question after his slow reaction to the green flag caused a concertina effect that resulted in Marco Andretti and Jack Hawksworth crashing out.

Andretti Autosport team owner Michael Andretti, among others, protested that Power was at fault for not reacting to the green, but IndyCar representatives told AUTOSPORT that race control had investigated the

incident and had no issue with it.

Power explained that his reaction had been the result of confusion caused by the green flag waving too early, and that he reacted on the second restart by accelerating before the designated zone. The Penske driver was warned for this and AUTOSPORT understands that any repeat will likely attract a penalty.

Helio Castroneves's claim that Power was "playing games" was rejected by his team-mate. "[Helio] was going to do what he did last year; jump the start completely and get the lead," Power said. "I was not going to let that happen."

Top two teams in off-track spat

THE LONG-STANDING RIVALRY

between Team Penske and Chip Ganassi Racing moved off the track in St Petersburg when Penske team president Tim Cindric downplayed the significance of the history between the two teams, and suggested that rival team boss Ganassi was actively seeking to be compared to Roger Penske.

Cindric's comments were swiftly dismissed by both Ganassi himself

and team stalwart Dario Franchitti, the Scot suggesting that Cindric's agitation may stem from Penske's lack of recent championship success.

Despite the brief war of words, relations between Penske and Ganassi themselves remained civil.

"When we spoke this morning, Mr Penske recalled that we've won five of the past six championships," Ganassi said. "I thought that was pretty good [of him]."

Barfield (right)
will share power

EBREZ/LAT

Double-file
restart dropped

DOUBLE-FILE RESTARTS HAVE

been dropped for all IndyCar road and street courses, although they will be retained for all ovals other than the Indianapolis 500.

According to the series, the intention was to limit the potential for accidents on the restart, a circumstance that nevertheless arose last Sunday in St Petersburg.

The series also announced that race director Beaux Barfield will no longer be autonomous in race control, with decisions now being handled by what will eventually become a rotating panel of three stewards, with Barfield serving as senior steward.

Handbags at dawn
between Penske
and Ganassi

ABBOTT/LAT

NASCAR SPRINT CUP MARTINSVILLE (USA), MARCH 30 RD 6/36

Busch gets mad – and then gets even

ONE HUNDRED LAPS INTO THE 500-LAP Martinsville NASCAR Sprint Cup race, it looked like Kurt Busch was destined to end his afternoon in a brawl, rather than Victory Lane.

Mired in the mid-twenties with a battered Stewart-Haas Chevrolet he was convinced was “ruined for the day”; his main focus was on plans to “**** that dude’s ****ing face up” post-race. The dude in question was Brad Keselowski, with whom Busch had tangled in the pits and enraged sufficiently for the 2012 champion to then hunt him down for a retaliatory bargaining match on the racetrack.

The feud began when Keselowski ran into Kasey Kahne amid pitstops, with Busch then swiping the Penske Ford as he tried to get around the incident. Opinions differed – in the extreme – over whether Busch could have avoided contact. When Keselowski rejoined 30 laps down and with little front bodywork left, his priority was finding Busch so he could variously gesticulate at, brake-test and drive into him.

Fortunately, Martinsville is a long enough race that Busch had time to get his rage out of his system, realise his car was still quick, and hack his way to the front of an absorbing race that featured a record 33 lead changes among 12 drivers, as extremely cold



temperatures and the after-effects of Saturday’s rain left everyone struggling with guesswork set-ups.

Jimmie Johnson looked like he had managed to get a grip on the race until Busch came on even stronger in the final 35-lap shootout after the last yellow. Although never dominant, Johnson was by the most consistent in the lead pack, battling back to the front no fewer than 11 times as he led 296 laps. He and Busch swapped the

lead twice in a thrillingly tense run to the flag, but the Hendrick man lost out by 0.2 seconds, with Busch ending a victory drought stretching back to Dover in October 2011.

Dale Earnhardt Jr and Joey Logano lurked just behind the lead battle in third and fourth, while fifth-placed Marcos Ambrose buoyed a Richard Petty Motorsports team mourning the loss of team matriarch Lynda Petty.

● Connell Sanders Jr

RESULTS

1 Kurt Busch (Chevrolet SS), 500 laps in 3h38m38s; 2 Jimmie Johnson (Chevy), +0.263s; 3 Dale Earnhardt Jr (Chevy); 4 Joey Logano (Ford Fusion); 5 Marcos Ambrose (Ford); 6 Matt Kenseth (Toyota Camry); 7 Kevin Harvick (Chevy); 8 Aric Almirola (Ford); 9 Clint Bowyer (Toyota); 10 Paul Menard (Chevy). **Points** **1 Earnhardt, 227;** 2 Kenseth, 218; 3 Carl Edwards, 217; 4 Jeff Gordon, 216; 5 Johnson, 209; 6 Kyle Busch, 189; 7 Brad Keselowski, 188; 8 Logano, 187; 9 Austin Dillon, 179; 10 Ryan Newman, 174.

56



INDY LIGHTS ST PETERSBURG (USA), MARCH 30 RD 1/10

Veach out of reach by the beach in Florida opener

AMERICAN ZACH VEACH EARNED THE first Indy Lights win of his career with a dominant performance on the streets of St Petersburg.

The Andretti Autosport driver passed polesitter Gabby Chaves at the first corner and that was essentially the last any of his rivals saw of him. When he crossed the line 39 laps later, Chaves was almost 5.5s in the red.

“Last year didn’t go exactly how we wanted it to,” Veach said. “This winter I spent a lot of time trying to get more physically strong because I felt that was my weakness, and spent a lot of time doing mental things and came into the season

with a whole new attitude.”

Matthew Brabham posed an early threat to Chaves, but that unravelled when he tagged the wall and was forced to pit for a new tyre. A later battle for third between Vittorio Ghirelli and Jack Harvey was decided in the Brit’s favour after a great move around the outside in the closing laps.

● Mark Glendenning

RESULTS

1 Zach Veach, 39 laps in 50m16.8989s; 2 Gabby Chaves, +5.4610s; 3 Jack Harvey; 4 Vittorio Ghirelli; 5 Luiz Razia; 6 Juan Piedrahita. **Points** **1 Veach, 51;** 2 Chaves, 41; 3 Harvey, 35; 4 Ghirelli, 32; 5 Razia, 30; 6 Piedrahita, 28.

VLN NURBURGRING (D), MARCH 29 RD 1/10

Nordschleife season gets under way with Audi win

AUDI TEAM PHOENIX RACING TOOK first blood for the 2014 season on the Nurburgring Nordschleife, with pole and a win for the R8 LMS ultra driven by Marc Basseng, Frank Stippler and Laurens Vanthoor.

A collision with a backmarker meant a checkover for the Audi in the pits, and allowed the BMW of Uwe Alzen and Philipp Wlazik into the lead before a puncture ended its race.

The Black Falcon Mercedes of Jeroen Bleekemolen, Andreas Simonsen and Lance David Arnold qualified and finished second.

Some late splash-and-dash stops ended with the Schubert BMW – with ex-DTM champ Martin Tomczyk on the driving strength –

beating the Marc VDS cars for third.

Among the 170-car field, Brits Alexander Sims (BMW) and Peter Dumbreck (Porsche) were non-finishers, but Stuart Leonard and Paul Wilson took a fine seventh in their locally run Aston Martin.

● Rene de Boer

RESULTS

1 Marc Basseng/Frank Stippler/Laurens Vanthoor (Audi R8 LMS ultra), 28 laps in 4h02m35.714s; 2 Andreas Simonsen/Jeroen Bleekemolen/Lance David Arnold (Mercedes SLS AMG GT3), +1m55.640s; 3 Jens Klingmann/Dominik Baumann/Martin Tomczyk (BMW Z4 GT3); 4 Bas Leinders/Nicky Catsburg (BMW); 5 Jorg Muller/Marco Wittmann (BMW); 6 Jurgen Alzen/Dominik Schwager (Ford GT GT3).





Peugeot's new rally baby took debut win with Breen

EUROPEAN RALLY CHAMPIONSHIP ACROPOLIS RALLY (GR), MARCH 28-30 RD 3/12

Breen breaks European duck

IN A RALLY FULL OF FIRSTS, CRAIG Breen scored the result that mattered most: his maiden ERC win and the first for Peugeot's R5-spec 208T16.

For the first time, the Acropolis featured one full day on asphalt and one full day on gravel.

Once Bryan Bouffier had dropped out of the lead when he punctured his Citroën's front-right Michelin cutting a corner on stage two, it was Breen's new team-mate Kevin Abbring who made the early running with a brace of stage wins. But the Dutchman's second-stage best, on his first major rally for two years, would be his last when a water leak cooked his engine on stage five and forced him out.

It would be folly to suggest that

Breen only won because Abbring stopped. The Irishman was fastest on the third stage and was in striking distance of the sister 208 when things went awry for Abbring. While Breen reached the end of the Tarmac leg leading by 14.7s, his victory – the first in the ERC for an Irishman since his hero Frank Meagher won the Manx International 19 years ago – was by no means a done deal with six gravel stages left on day two.

As Bouffier beat Kajetan Kajetanowicz in a thrilling battle for second, swapping positions virtually on every stage, Breen kept going, claiming the 208's debut gravel stage win on Sunday morning and landing a further fastest time in the afternoon

to take victory. That was despite a scare on the final stage when he dislodged the air inlet on a water splash, causing the windscreen to steam up and forcing him to short-shift to the finish.

● Graham Lister

RESULTS

1 Craig Breen/Scott Martin (Peugeot 208T16), 2h21m20.2s; 2 Bryan Bouffier/Xavier Panseri (Citroën DS3 RRC), +8.1s; 3 Kajetan Kajetanowicz/Jaroslav Baran (Ford Fiesta R5); 4 Esapekka Lappi/Janne Ferm (Skoda Fabia S2000); 5 Bruno Magalhaes/Carlos Magalhaes (Peugeot 207 S2000); 6 Vasily Gryazin/Dmitry Ereemeev (Ford Fiesta S2000). **Points 1 Breen, 63;** 2 Lappi, 59; 3 Gryazin, 48; 4 Kajetanowicz, 44; 5 Robert Kubica, 39; 6 Bouffier, 31.

V8 SUPERCARS SYMMONS PLAINS (AUS), MARCH 29-30 RD 2/14

Tasman treble for Triple Eight

SUCH WAS THE SPEED OF THE TRIPLE Eight Holden Commodores at the Symmons Plains V8 Supercar races that the only threat to their domination was themselves.

Jamie Whincup took three pole positions and he and Craig Lowndes split the wins in Tasmania, but an on-track incident and an unusual technical mistake nearly cost them.

In the first race, Lowndes led early until Whincup forced his way into a gap and speared his team-mate off and onto the grass. There was no penalty for the 'racing incident' and Lowndes recovered to eighth, only to then be informed that a technical infraction in qualifying (his team taped over a safety-access hole in

his driver's-side window) would send him from second to the back of the grid for the second race.

Whincup won that one too, from Ford's Mark Winterbottom and Fabian Coulthard. The Volvo of Scott McLaughlin was fourth ahead of, incredibly, Lowndes, who had stormed through the traffic at the same pace as the leaders had been going in clean air.

His 'driving-angry' mantra carried Lowndes to a dominant win in Sunday's race, over Whincup and factory Holden driver James Courtney, who was in fine form with podium finishes in two of the races.

Winterbottom and McLaughlin again looked to be the best challengers on Saturday, and

the Volvo was in the mix on Sunday. The longer race also featured the best showing yet for the Erebus Motorsport team, Will Davison taking his Mercedes E-class to an impressive fourth place. It was an ironically timed result: team-mate Lee Holdsworth's E63 was in plain black, to emphasise the team's lack of a naming-rights sponsor.

The Nissans struggled, none of the four Altima drivers making the top 10 in any of the races.

● Phil Branagan

RESULTS

Race 1 1 Jamie Whincup (Holden Commodore), 42 laps in 39m48.2632s; 2 James Courtney (Holden), +0.8999s; 3 Mark Winterbottom (Ford Falcon); 4 Russell Ingall (Holden); 5 Scott McLaughlin (Volvo S60); 6 Garth Tander (Holden). **Race 2 1 Whincup, 42 laps in 42m46.3425s;** 2 Winterbottom, +0.4875s; 3 Fabian Coulthard (Holden); 4 McLaughlin; 5 Craig Lowndes (Holden); 6 Tander. **Race 3 1 Lowndes, 84 laps in 1h15m08.3240s;** 2 Whincup, +5.3910s; 3 Courtney; 4 Will Davison (Mercedes E63 AMG); 5 Coulthard; 6 McLaughlin. **Points 1 Lowndes, 532;** 2 Whincup, 462; 3 Coulthard, 447; 4 Courtney, 429; 5 Winterbottom, 406; 6 Shane van Gisbergen, 389.



Whincup leads Winterbottom

CIANFLONE/GETTY



DOLE/LAT

WORLD CHALLENGE

Tomas Eng (above) recovered from a slow start to win on his Pirelli World Challenge debut in St Petersburg. The Czech's Lamborghini Gallardo passed the Cadillac CTS-VR of Andy Pilgrim with a few minutes remaining to take the lead.

PRO MAZDA

Spencer Pigot started his campaign with a pair of wins in St Petersburg, leaving Kyle Kaiser in second for both races. Scott Hargrove competed the podium in race one, but was denied a repeat on Sunday by ex-F3 racer Pipo Derani.

US F2000

Brazilian Victor Franzoni put in a superb wet-weather performance to beat RC Enerson in the opening race at St Petersburg, with Nico Jamin third. Enerson reversed the top two on Sunday, although Franzoni was later disqualified from second for a technical infraction. Jake Eidson and Florian Latorre therefore moved up to second and third.

HA'IL CROSS-COUNTRY

Toyota Land Cruiser driver Owaid Mansi snatched victory from Khalaf Joan Al-Shammeri on the final selective section of the Ha'il International Rally, Saudi Arabia's premier off-road motorsport event. Race favourite Yazeed Al-Rajhi retired his Hummer with a broken engine on day two and technical problems and time penalties cost Emirati Khalid Al-Jafra and Saudi Mutair Al-Shammeri their leads.

ASIAN CARRERA CUP

The Malaysian GP support round at Sepang went to 2013 champion Earl Bamber, the Kiwi beating Martin Ragginger and Alexandre Imperatori.

AUSTRALIAN F3

Ben Gersewski took all three races at Sandown in his Dallara-Mercedes, followed by John Magro (in two races) and Simon Hodge (in the other).

NASCAR TRUCKS

Reigning champion Matt Crafton beat Darrell Wallace Jr in a caution-infested race at Martinsville that finished under yellow. Crafton (below) struggled early on before his Toyota was improved at pitstops in the rain-delayed race. Rookie Ben Kennedy was third.



LEPAGE/LAT

Members' meeting i

Great weather and enthusiasm to match heralded the 72nd Members' Meeting at Goodwood – the first for nearly half a century. **MARCUS PYE** witnessed all the action



n full bloom

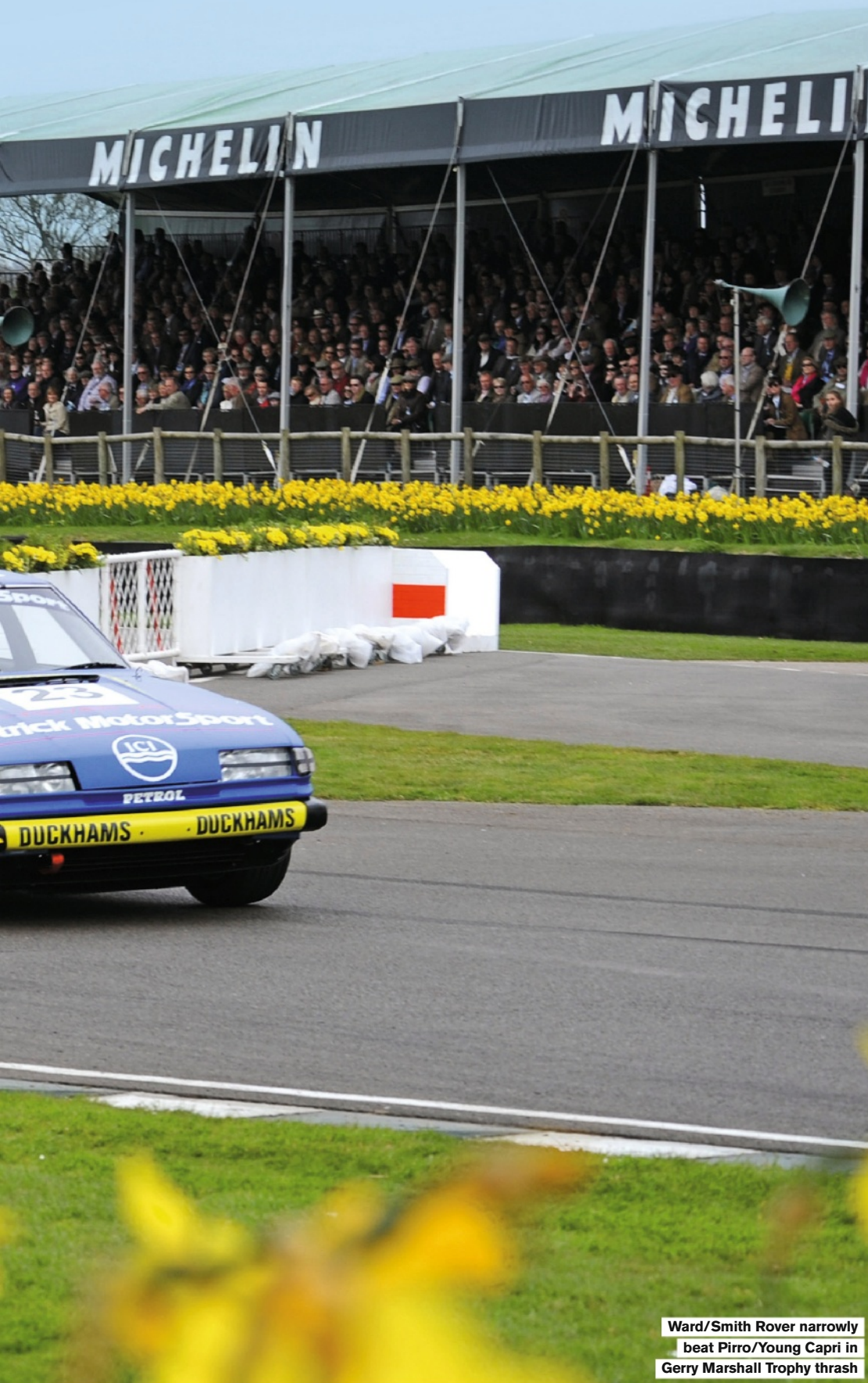

Ward/Smith Rover narrowly
beat Pirro/Young Capri in
Gerry Marshall Trophy thrash

ALMOST 48 YEARS AFTER THE 71ST BARC MEMBERS' Meeting at the Sussex airfield circuit on July 2, 1966, the 72nd – and first badged by the Goodwood Road Racing Club – was a very different celebration of the past. Against the odds, summer-like conditions blessed the hallowed former RAF Westhampnett perimeter track which, since Lord March's extraordinary inaugural Revival Meeting of 1998, has more than regained its former reputation as a temple of speed.

As darkness descended on Saturday evening's Moss Trophy GT race at Goodwood, an utterly mesmeric David-versus-Goliath battle between Simon Hadfield (Aston Martin DB4 GT) and Oliver Bryant (Lotus 11 GT) enthralled onlookers at the height of a triumphant event that until last month was a headache-causing slow-burner in terms of ticket sales. Sensational racing in a relaxed atmosphere and smiling punters say the event is here to stay!

The Inter-House Challenge format, involving spectators who could add to the racers' tallies with derring-do in a wide range of scoring opportunities, may have been innovative, but the quality of track action and accessibility to pits balcony and paddock exceeded all expectations. Indeed, serial Goodwood winner Gary Pearson described it as "a new favourite".

The Pre-'63 showpiece – named for the venue's most successful driver Sir Stirling Moss, who was there almost 66 years after he won a 500cc race at the opening event of September 1948 – was a marvellous spectacle, packed with surprises.

Top qualifier Rob Hall's scorching early pace in the Count Volpi-commissioned Ferrari 250 GT 'Breadvan' did not translate to victory for ever-diminishing visibility after sundown and a slippery track were not conducive to an easy baptism for new owner Martin Halusa. The other fast Ferrari, Jackie Oliver's SWB didn't get that far, a blown rear tyre stranding it before Pearson could clamber aboard.

James Cottingham's Jaguar E-type thus took

"It was very exciting racing, but better to have spun trying than not had a go" Oliver Bryant

up the cudgels before Hadfield (in for Wolfgang Friedrichs) and Bryant (relieving Joe Twyman) ascended the lap charts and got stuck in to battle that had them locked together for 10 laps. Several times GT racer Bryant nosed the little Lotus past the Aston at Lavant, only to be outdragged down Lavant Straight. With one final superhuman effort, Ollie finished in the Aston's slipstream.

"That was remarkable, but we trusted each other," said Hadfield. Bryant agreed. "It was very exciting, but better to have spun trying than not had a go," he grinned. Also thrilled was Graham Capel, originator of the Lotus 11 'Breadvan' theme 50 years ago, and there to watch the car, newly restored by Twyman Racing in its David Plumstead Racing livery.

Jeremy Cottingham replaced his brother in the maroon E-type, but fell back as night closed in. The DK Engineering boys were still third, albeit ▶

SUBSCRIBE TO AUTOSPORT AND GET A FREE OFFICIAL GILLES VILLENEUVE T-SHIRT

+PLUS+

FREE DIGITAL EDITION SUBSCRIPTION & UNLIMITED ACCESS TO **AUTOSPORT.COM**



FREE GIFTS

- ✓ Free Official Gilles Villeneuve design T-shirt
Available in medium, large & X-large
- ✓ Free subscription to the AUTOSPORT Digital Edition and unlimited access to **AUTOSPORT.com**

SUBSCRIBE NOW!



- ✓ Save 25% on the cover price
- ✓ Pay just £34.99 every 13 issues by direct debit

Visit: www.themagazineshop.com/aspo/m0414p

08448 488 817

Or call and quote **M0414P**
Please have your bank details ready.
Offer ends May 3 2014.

themagazineshop.com

THE BENEFITS OF SUBSCRIBING!

- ✓ Never miss an issue
- ✓ Free delivery direct to your door
- ✓ Unlimited access to news and views from the paddock
- ✓ Access to subscriber-only analysis and comment

This offer is open to UK residents only. Overseas rates are available on +44 (0) 1795592 972. Please allow 35 days for delivery of your gift and first issue. The gift will be sent under separate cover from the magazine. Should we run out of gifts, you may be offered an alternative gift – there is no cash alternative. To activate your Autosport online account visit <https://secure.autosport.com/subs/activate.php> and enter your activation code (your personal magazine subscriber number which will be included in your welcome email/letter) along with your email address to access your extra Autosport content. Direct Debit rates are valid for one year after which they are subject to change – should prices change we will inform you in writing. We ask that you enter into a Direct Debit agreement with the intention that your subscription will continue for a minimum period of 12 months, even if the frequency of payment is for a shorter period, however, you will still have the right to cancel your Direct Debit in accordance with Direct Debit Guarantee. Should you wish to cancel your subscription it will be cancelled on expiry of the current term which will not be refundable, other than in exceptional circumstances. If a gift is included as part of the subscription offer we reserve the right to request the return of the gift. Details of the Direct Debit Guarantee are available on request. Savings are based on the standard UK cover price of £3.60. Offer ends May 3 2014. Haymarket Media Group Ltd uses a best-practice layered Privacy Policy to provide you with details about how we would like to use your personal information. To read the full privacy policy please visit our website www.haymarket.com/privacy or call us on 08448 482 800. Please ask if you have any questions as submitting your personal information indicates your consent, for the time being, that we and our partners may contact you about products and services that will be of interest to you via post, phone, e-mail and SMS. You can opt out at ANY time by emailing the datacontroller@haymarket.com or by calling 08448 482 800.

Bryant's Lotus had great scrap with Aston of Hadfield



BLOXHAM/LAT

► being caught by ex-F3 racer Adrian Willmott who at times lapped Tom Alexander's DB4 GT quicker than the leaders. Halusa was happy to bring his snarling Ferrari home fifth, a lap down, after the Martin Hunt/Patrick Blakeney-Edwards AC Cobra slithered off four laps from the end, while lying fourth.

Goodwood's first MSA-sanctioned post-period race – for Group One saloons of the 1970s and early '80s – captured competitors' imagination, and rekindled memories of British and European Saloon Car Championships of a golden era. Saturday's 'owners' qualifying heat set the scene as a 24-car, 10-marque field came under orders.

Torbolton house captain Emanuele Pirro

somehow supplanted John Young in the Autocar/Motorcraft Ford Capri he'd put on pole, but the Italian was pushed off the grid with "a starter motor issue" and went from the pitlane. Carrying TV cameras, the five-time Le Mans winner's relentless charge through the field was sensational.

Emanuele failed to catch Chris Ward (Patrick Motor Group Rover SDI) by eight seconds, and only annexed second when polesitter Nick Swift's giant-slaying Richard Longman replica Mini 1275GT was "shoved" onto the grass while lapping a Rover at the Lavant Kink and lost momentum.

Sunday's double-driver final was equally exciting, for 71-year-old Stuart Graham turned the clocks back 40 years as he blasted Nigel

Garrett's evocation of his Faberge Brut Chevrolet Camaro from fifth on the grid past Pierre-Alain Thibaut's Belga Capri, Swift, Pirro and Ward to lead within three laps.

Graham led superbly but, with Garrett waiting nervously, missed the pit window – a costly "strategical error. As I came in I saw a board on the wall which said 'pits closed' so I went round again," said Graham. Two laps later he did stop, still leading, but Garrett received a stop-and-go penalty from which he emerged just ahead of fourth-placed Jason Stanley in Swift's Mini.

Andrew Smith in the PMG Rover and Young's Capri had gone ahead in the confusion, and their full-blooded fight to the chequered flag had onlookers waving programmes. V8 grunt won the day by a second, although Smith had to wrestle the bigger car into Lavant on what, by then, were shot Dunlops. "Once I was on the straight I was OK," beamed the Scot.

Garrett powered the Camaro away from Stanley to secure third, while Alex Buncombe hauled Paul Pochciol's Esso Capri back to fifth and former works Mazda BTCC star Patrick Watts wound up Ian Cowley's Pentax RX-7 as he hurtled to sixth.

Eighty-five years after Briton William Grover-Williams's Monaco GP victory in a patriotic green Bugatti T35B, a magnificent array of 25 of Ettore's finest machines contested the Grover-Williams Trophy race, including Stephen Gentry's imposing aerodynamic T57G 'Tank' and Chris Jaques' ►

Pochciol leads as Pirro joins first tin-top race from the pitlane



BLOXHAM/LAT

SALVADORI CUP: 1955-1960 sports-racers

Spectators who witnessed Oliver Bryant's mastery in the closed Lotus 11 in Saturday's twilight enjoyed a second chance to see him at work in a two-litre Lotus 15 in a thrilling event-closer for '50s sports-racers.

Fresh from his unexpected BRM F1 win, Gary Pearson ran from the post-race interviews and leapt into his burbling Lister-Jaguar. He then engaged in a swashbuckling high-speed fight with big-saloon victor Andrew Smith – back in Chevy-powered 'knobbly' after 18 months – and Bryant's Climax FPF-engined Lotus.

For 10 laps they jostled, ducking and diving in traffic. Pearson had a close shave when he was squeezed by Harry Wyndham (Jaguar D-type). Bryant, who edged

ahead of Smith at Lavant, then pirouetted at Woodcote.

Having tracked Smith's smoky monster, searching his repertoire for a move on Smith that might stick, Pearson spotted a chance to pounce – round the outside of the kink after Fordwater! A locked front brake sent him herbaceous on both sides of the track, but he rejoined, still second, leaving Smith unchallenged. "That was brilliant fun," said the Scot. "That was some pressure."

After Sebring 12 Hours winner Marino Franchitti retired father-in-law Nick Mason's misfiring Maserati Birdcage, Sam Hancock (Lister-Jaguar) and Andy Wolfe (Lotus 15) narrowly got the better of 'super sub' Darren Turner (Ferrari Dino 246S) in a protracted struggle for fourth.



Smith topped epic Lister battle

BLOXHAM/LAT

DEMO STARS

Many historic machines were demonstrated at Goodwood. Here are five of the best.



PORSCHE 917 LANGHECK

The Automobile Club de l'Ouest Museum at Le Mans sent its 1971 streamliner – one of the Gulf entries repainted in Martini colours – for Gary Pearson to drive.



LOTUS-RENAULT 97T

Ayrton Senna's first GP winner – 97-2, from Estoril in '85 – was entrusted to Joaquin Folch by Clive Chapman when the Spaniard's 94T developed a fault.



RONDEAU M379

Gordon Spice was at Goodwood to see the Cosworth DFV-powered machine in which he finished third at Le Mans in 1980. Emanuele Pirro drove it.



BEATRICE-HART TH1 & BEATRICE-FORD TH2

Chevrolet Corvette GT ace Oliver Gavin and historic racer Richard Meins sizzled the latter's pretty Lola-built F1 turbocars of 1985-'86 round in unison on Sunday.



TOYOTA 87C

Goodwood favourite Kenny Brack enjoyed his first taste of Group C in the ex-Geoff Lees Toyota 87C from fellow Swede Kent Abrahamsson's collection.

Mitcham (11) was a dominant victor in Formula Junior



▶ delightful narrow-tyred T35 – raced by Raymond Mays in '28, and later at Brooklands by Alex Spottiswoode – in Rob Newall's hands.

Amid the whine of superchargers and rasp of exhausts nobody could touch Charles Knill-Jones in Nick Mason's T35B once Tom Dark had pitted Gunther Krump's gruff five-litre T59/50 III with low fuel pressure. Thereafter, wasp-helmeted Duncan Pittaway performed miracles in his unblown T35 to finish second, ahead of American Charles McCabe who coolly brought his T59 up from seventh on lap one.

Will Mitcham shook off Ray Mallock for a U2 one-two in Formula Junior. Robbed at the 2012 Revival, Mitcham completed "unfinished business" in faultless style. A first-lap shemozzle at St Mary's – triggered when Richard Ellingworth's Gemini rotated – put Lurani Trophy champion Andrew Tart (Bond), veteran Derek Walker (Terrier) and Michael Gans (Stanguellini) out, but left a terrific scrap for third.

This embroiled the Lola Mk2s of Simon Goodliff and Chris Goodwin, and 75-year-old class debutant Barrie Williams (front-wheel-drive Bond). Goodliff prevailed over the McLaren test driver, but 'Whizzo' split them before his steering tightened after he clonked the chicane. British champion Mark Woodhouse (Elva 100) chased them in.

A red flag to remove Anthony Hansford's rolled Rochdale from Lavant changed the Tony Gaze '50s GT landscape, bringing Max Girardo's Ferrari 250 GT TdF back level with leader Andy Shepherd's AC Ace Bristol at the restart. Girardo scarpred as the Union flag fell, then threw it all away on the last lap with a grassy excursion at St Mary's.

Shepherd thus completed a fairy tale victory in the car with which race debutant Paul Fletcher won at the 39th Members' Meeting in 1960. Continuing the straight-six joy, poleman Andy Keith-Lucas (Jaguar XK150) and Chris Jolly (Aston Martin DB2/4 PUM 6) fought to the line, with

Girardo fourth. "I could have crawled into the footwell and stayed there all day," he said.

Nick Swift and his pristine sage green Swiftune Mini Cooper S outran the Lotus Cortinas of Neil Brown and Shaun Lynn for Sears Trophy Pre-'64 saloon honours, his best lap being almost 93mph! Jason Stanley's Cooper S was glued to Lynn at the chequer, but Peter Alexander's feisty Ford Anglia 105E slipped back into the pack having frightened the Cortinas initially.

Fifty years to the day after John Taylor debuted the Bob Gerard Racing Cooper-Ford twin-cam at the circuit, Revival 500cc F3 and FJunior victor Sam Wilson stretched his unbeaten Goodwood CV to three races in his first F1 start aboard Alan Baillie's machine.

Wilson went clear of the shrieking Lotus 24 V8s of Paul Drayson – piloting his BRM-powered car with unprecedented gusto either side of a grassy moment at Lavant – and Andrew Beaumont before suspected gearbox input-shaft failure stopped the latter's ex-Innes Ireland Climax version.

The overjoyed Alex Morton (ex-Neville Lederle four-cylinder Lotus 21) thus claimed bronze behind Drayson, while Ian Bankhurst (Alexis Mk8) gratefully grabbed third after a lengthy early F3 screamer duel with Max Blee (Brabham BT15) ended when the German spun negotiating traffic.

Driving the fabled black Aston Martin DB3 in which 1948-'52 sports racing honouree Peter Collins won the 1952 Goodwood Nine Hours with Pat Griffith, Rob Hall tried his best to land the prize, but Geraint Owen's Kurtis 500S had too much grunt. Nick Finburgh (Jaguar C-type) was flying early on and bagged third, but pursuers Rob Newall (Cooper-Jaguar T33) and Malcolm Paul (Lotus-Bristol 10) retired, leaving late challenger Ben Cussons (C-type, a Lavant spinner) and Darnley house captain Jochen Mass (Mercedes-Benz 300SL) fourth and fifth.

Alas Ron Gammons' Lotus-MG IX was



Shepherd's AC (1)
benefited from late
Ferrari off by Girardo

HAWKINS/LAT



Wilson added to his
Goodwood CV with
win in Cooper

GARY HAWKINS

GARY HAWKINS



Goodwin celebrates
Surtees Trophy
success in M1B

BLOXHAM/LAT

damaged at the first corner after Pat Blakeney-Edwards' Frazer Nash Le Mans Replica gyrated on oil from the Cadillac V8 in Patrick Watts' short-lived Allard J2 'Blunderbuss'.

A safety car interlude for the retrieval of Marshall Bailey's Lola T70 from the Lavant gravel gave Chris Goodwin a breather in the mighty Surtees Trophy '60s Can-Am/USRRC/prototypes battle. With pursuer Jon Minshaw – the British GT racer quick to recover from a trip to the greensward at St Mary's – stuck behind three tailenders in the queue, Goodwin blasted his ex-Chris Amon factory McLaren M1B clear again at the green flag.

Intrepid Italian Pierenrico Tonetti bounced back from a hairy spin at Madgwick to net third on his first proper go in the ex-Don Skogmo Huffaker-Chevrolet Mk8/10 he'd owned for years, a brave move (also into the tricky first corner) denying James Cottingham's Ford GT40 on the final lap.

The transition from front to rear-engined F1 technology was beautifully illustrated in the Brabham Trophy race, which had a sting in its tail when leader Roger Wills' ex-works Cooper T51 had a transmission problem two laps from home. "Better here than at Monaco in a few weeks time," grinned the Kiwi having congratulated Gary Pearson, who powered the ex-Jo Bonnier BRM P25 through to a surprise win.

An overnight gearbox change enabled Martin Stretton to finish runner-up in Mark Clubb's pretty two-litre Cooper T45. Will Nuthall kept 'Dangermouse' more than honest in a borrowed Scuderia Centro-Sud Cooper-Maserati T51, while John Clark scored a superb fourth in Marshall Bailey's oft-recalcitrant JBW-Maserati.

A minute later, Bailey himself was a good fifth, second of the 'pullers', in his Lotus 16 – one of three in the race – ahead of a brilliant tussle in which Malcolm Cook (Cooper T43) withstood immense pressure to keep Joaquin Folch (Maserati 250F) and Tony Smith (Ferrari Dino 246) behind. ❧

STIRLING MOSS TROPHY: CLOSED TWO-SEATERS 1959-'62 (37 LAPS)

1 Wolfgang Friedrichs/Simon Hadfield (Aston Martin DB4 GT); 2 Joe Twyman/Oliver Bryant (Lotus 11 GT 'Breadvan') +0.535s; 3 James & Jeremy Cottingham (Jaguar E-type); 4 Tom Alexander/Adrian Willmott (Aston Martin DB4 GT); 5 Rob Hall/Martin Halusa (Ferrari 250 GT 'Breadvan'); 6 Armin Zumtobel/David Franklin (Ferrari 250 GT SWB); 7 Richard Meins/Ludovic Lindsay (Aston Martin DB4 Zagato); 8 David Clark/Roger Wills (Lotus Elite); 9 Simon Tate/Stuart Lawson (Jaguar E-type). **Fastest lap** Jackie Oliver (Ferrari 250 GT SWB) 1m30.209s (95.77mph).

GERRY MARSHALL TROPHY: GROUP 1 SALOON CARS 1970-'82 (29 LAPS)

1 Chris Ward/Andrew Smith (Rover 3500 SDI); 2 Emanuele Pirro/John Young (Ford Capri 3.0S) +1.056s; 3 Stuart Graham/Nigel Garrett (Chevrolet Camaro Z28); 4 Nick Swift/Jason Stanley (Mini 1275GT); 5 Paul Pochciol/Alex Buncombe (Ford Capri 3.0S); 6 Tim Scott-Andrews/Oliver Gavin (Rover 3500 SDI); 7 Ian Cowley/Patrick Watts (Mazda RX-7); 8 Rupert Keegan/Chris Snowdon (Alfa Romeo GTV6); 9 Tiff Needell/Peter Mallett (Rover 3500 SDI); 10 Tim Morley/Anthony Reid (Triumph Dolomite Sprint). **FL** Graham 1m29.355s (96.69mph) **record**.

QUALIFYING RACE (10 LAPS) 1 Ward; 2 Pirro +8.722s; 3 Swift; 4 Pierre-Alain Thibaut (Ford Capri 3.0S); 5 Garrett; 6 Pochciol. **FL** Pirro 1m30.897s (95.05mph).

GROVER-WILLIAMS TROPHY: PRE-WAR

BUGATTIS (14 LAPS) 1 Charles Knill-Jones (T35B); 2 Duncan Pittaway (T35) +46.970s; 3 Charles McCabe (T59); 4 Chris Hudson (T35B); 5 Bo Williams (T35B); 6 Martin Halusa (T35C). **FL** Tom Dark (T59/50B) 1m39.368s (86.94mph).

THRELFALL CUP: FRONT-ENGINED FORMULA JUNIOR 1958-'60 (16 LAPS)

1 Will Mitcham (U2-Ford Mk2); 2 Ray Mallock (U2-Ford Mk2) +11.196s; 3 Simon Goodliff (Lola-Ford Mk2); 4 Chris Goodwin (Lola-Ford Mk2); 5 Barrie Williams (Bond-Ford); 6 Mark Woodhouse (Elva-BMC 100). **FL** Mitcham 1m29.040s (97.03mph).

TONY GAZE TROPHY: '50s PRODUCTION SPORTS & GT CARS (6 LAPS) 1 Andy Shepherd (AC Ace Bristol);

2 Andrew Keith-Lucas (Jaguar XK150S) +3.489s; 3 Chris Jolly (Aston Martin DB2/4); 4 Max Girardo (Ferrari 250 GT Tour de France); 5 David Cooke (Ferrari 250 GT Tour de France); 6 Guy Broad (Triumph TR2). **FL** Girardo 1m36.670s (89.37mph).

SEARS TROPHY: PRODUCTION SALOONS 1959-'63 (16 LAPS) 1 Nick Swift

(Morris Cooper S); 2 Neil Brown (Ford Cortina Lotus) +10.008s; 3 Shaun Lynn (Ford Lotus Cortina); 4 Jason Stanley (Austin Cooper S); 5 Andy Ruhan (Studebaker Lark Daytona 500); 6 Rory Henderson (Morris Cooper S). **FL** Swift 1m32.926s (92.97mph).

CLARK-STEWART CUP: 1.5-LITRE F1, 1-LITRE F2 & F3 CARS 1960-'65 (18 LAPS) 1 Sam Wilson (Cooper-Ford T71/73); 2 Paul Drayson (Lotus-BRM 24) +19.149s; 3 Alex Hurston (Lotus-Climax 21); 4 Ian Bankhurst (Alexis-Ford Mk8);

5 Max Blee (Brabham-Cosworth BT15); 6 John Elliott (Lotus-Climax 18).

FL Wilson 1m25.729s (100.78mph).

PETER COLLINS TROPHY: SPORTS RACING CARS 1948-'55 (16 LAPS)

1 Geraint Owen (Kurtis 500S); 2 Rob Hall (Aston Martin DB2) +6.631s; 3 Nick Finburgh (Jaguar C-type); 4 Ben Cussons (Jaguar C-type); 5 Jochen Mass (Mercedes-Benz 300SL); 6 Bob Francis (Allard J2). **FL** Owen 1m32.979s (92.82mph).

SURTEES TROPHY: SPORTS PROTOTYPES 1963-'66 (19 LAPS)

1 Chris Goodwin (McLaren-Chevrolet M1B); 2 Jon Minshaw (Lola-Chevrolet T70 Spyder) +8.812s; 3 Pierenrico Tonetti (Huffaker Genie-Chevrolet Mk8); 4 James Cottingham (Ford GT40); 5 Chris Drake (McLaren-Chevrolet M1B); 6 Marcus Mussa (McLaren-Chevrolet M1B). **FL** Goodwin 1m20.030s (107.95mph).

BRABHAM TROPHY: F1 CARS 1954-'60 (18 LAPS) 1 Gary Pearson (BRM P25);

2 Martin Stretton (Cooper-Climax T45) +3.549s; 3 William Nuthall (Cooper-Maserati T51); 4 John Clark (JBW-Maserati); 5 Marshall Bailey (Lotus-Climax 16); 6 Malcolm Cook (Cooper-Climax T45). **FL** Roger Wills (Cooper-Climax T45) 1m25.259s (100.32mph).

SALVADORI CUP: SPORTS RACING CARS 1955-'60 (18 LAPS) 1 Andrew Smith

(Lister-Chevrolet Knobbly); 2 Gary Pearson (Lister-Jaguar Knobbly) +7.424s; 3 Oliver Bryant (Lotus-Climax 15); 4 Sam Hancock (Lister-Jaguar Knobbly); 5 Andy Wolfe (Lotus-Climax 15); 6 Darren Turner (Ferrari Dino 246S). **FL** Pearson 1m25.128s (101.49mph).

PRODUCT SHOWCASE

NEW!

ATLL
AERO TEC LABORATORIES LTD

CLOSED LOOP REFUELLING BOWSER
SAFE, FAST, CLEAN REFUELLING



ZERO VAPOUR
WITH INTEGRATED SAFETY FEATURES

FOR MORE INFO, PLEASE CONTACT:
ATLL LTD.COM
sales@ATLLTD.com +44(0)1908 351700

CARTEK **NEW**
MOTORSPORT ELECTRONICS

Wireless Steering Wheel Pushbutton Controls



CARTEK now offer a quick and easy solution to installing 8 pushbutton controls to detachable racing steering wheels.

This wireless system is fully configurable incorporating momentary, latching and flashing functions for uses such as: radio, pit limiter, dash, lights, wipers, etc...

£499
Pit!

www.CARTEKMOTORSPORT.com
Battery Isolators, FIA Rain Lights, PDMs, Shift Lights...
Available from: Demon Tweaks, Competition Supplies, Powervamp, Rallynuts, Pandamonium, Interex

RED LINE SYNTHETIC OIL

Racotech

macs

FLOWMASTER
THE EXHAUST TECHNOLOGY COMPANY

OLDHALL PERFORMANCE

Old Hall Performance Ltd, Burnsall Road, Coventry, United Kingdom, CV5 6BU
T: +44 (0) 2476 717 100, E: sales@oldhallperformance.com
www.oldhallperformance.com

MOCAL
OIL COOLERS

- Winning races since 1967
- Wide Range of oil coolers and components
- British design and manufacture

For the best in Oil Cooling systems... make it MOCAL!!



WORLDWIDE ENQUIRIES visit: www.mocal.co.uk
phone: +44 0208 568 1172

USA ENQUIRIES visit: www.batinc.net

AUTOSPORT

PRODUCT SHOWCASE

TO ADVERTISE YOUR NEW 2014 PRODUCTS AND SERVICES HERE

CALL:

0208 267 5992

Evolution of the species

NEW zero 360



FIRE SAFETY BROUGHT UP TO DATE



NOT ONLY FIRE EXTINGUISHERS BUT ALSO
QUICK RELEASE STEERING BOSSES • RAIN LIGHTS
RACING MIRRORS • ROLL-CAGE PADDING

Coventry UK
Tel +44 (0)24 7671 2999
www.lifeline-fire.co.uk

lifeline

- FIA FT3 Certified Fuel Cells & Accessories
- Short Lead Times for Stock or Custom Parts
- Fitting Service Available
- Superior Seamless Construction Technology
- Special Large Capacity Fuel Cells for Endurance Events

FUEL SAFE
Racing Cells



Classic World Racing
www.classicworldracing.co.uk
Tel: +44(0)1527 521050

Anglian Fasteners



- Unbrako, Holokrome, Dormer and Loctite
- All the fasteners you'll ever need
- Next day delivery

Call: 01234 345641 or 01604 645341
Email: info@anglianfasteners.co.uk
TRADE COUNTERS IN BEDFORD AND NORTHAMPTON
www.anglianfasteners.co.uk
If it's threaded, call Anglian Fasteners!

LIVE ONBOARD VIDEO

WITH THE SPAA05-RCT-VID THE RACE BECOMES LIKE A VIDEO GAME FOR EVERYONE TO ENJOY.

SPAA05-RCT VID FEATURES:

- Live video
- DVB quality video
- Telemetry data overlay
- Live internet broadcasting
- Full track coverage on most circuits



Prices: from £4,800

SPAA05.com
Live Telemetry & Video Systems

www.spaa05.com
info@spaa05.com
+31 416 565 005

WEB DIRECTORY

CAR BROKERAGE

RACING CARS FOR SALE
ALAN CORNOCK FCS
BUYING - SELLING - BROKERAGE
www.racingcarsforsale.co.uk
TEL: 01480 891212

ENGINES

JULIAN GODFREY
ENGINEERING
visit our new online shop www.racetuners.com

EXHAUSTS

Inconel & Stainless Steel Specialists
SIMPSON
Race Exhausts
Tel: 01753 532222
www.simpsonraceexhausts.com

GEARBOXES

Gearboxman.com
COMPETITION TRANSMISSION SERVICES
Gearboxes & Axles for Road, Race, Rally and more
Telephone: 01582 840008 Fax: 01582 840007

HELMET GRAPHICS

Mike Fairholme Designs
Sole approved painter of Arai helmets.
Silver Birches, Corby Birkholme, Nr Grantham, Lincs NG33 4LE.
Tel: 01476 550630. Fax: 01476 550029.
email: fairholmedesigns@btconnect.com
www.fairholmedesigns.co.uk

MEMORABILIA

FINAL LAP
For Everything Formula One
www.finallap.net **WE BUY AND SELL**
+44 (0) 1245 287588 / 07771 920345

MERCHANDISE

GRANDPRIXGRAPHICS
SPECIALISTS IN MOTORSPORT GRAPHICS
RACE CARS, SUPPORT VEHICLES,
F1 TYPE BOTTLES, SIGNS.
07902061423 or 01992 666913
www.grandprixgraphics.co.uk

MODELS

www.Diecast
race models.com
Specialists in 1:2 Scale Replica F1 Helmets

RACE PRODUCTS

ARE DRY SUMP SYSTEMS
ARMSTRONG RACE ENGINEERING INC.
WWW.DRYSUMP.COM (916) 652-5282

RACE PARTS

PORSCHESHOP
10% off with website
voucher code AUTOTEN
Or Call: 0121 585 6088

RACE PRODUCTS

MRR
Matt Roach Racing
Race Car Preparation Specialist
01268 207000 matt@mattroachracing.com
www.MattRoachRacing.com

MARDI GRAS MOTORSPORT
www.mardigras.co.uk

RACE PRODUCTS

Pit to Car **Autotel**
Radio solutions **Digital** Race Radio
0044(0)1508 528837
www.raceradio.co.uk

PIPER
www.pipercams.co.uk

JJC race and rally
PASSIONATE ABOUT MOTORSPORT
www.jjcraceandrally.com

RACEWEAR

CROYDON RACE & RALLY CENTRE
www.croydonraceandrally.co.uk
220-222 Portland Road
South Norwood
London SE25 4QB
FORECOURT PARKING
For Racewear & Motorsport equipment
Tel: 020 8656 7031

demon tweeks
MOTORSPORT Direct
www.demon-tweeks.co.uk

THE RACEWEAR EMPORIUM
Grand Prix Racewear
WWW.GPRDIRECT.COM
08435 070 858
sparco uvex omp iral BELL SCHOTTI hons

RACEWEAR

AUTHORISED DISTRIBUTOR
OMP **YBRACING**
MOTORSPORT & PERFORMANCE
WWW.YBRACING.COM

RACING OIL

OLD HALL PERFORMANCE LTD T: 02476 717 100
RED LINE
SYNTHETIC OIL
sales@redlineoil-europe.com www.redlineoil-europe.com

THROTTLE & DRY SUMP SYSTEMS

at power
www.atpower.co.uk
+44 (0)1953 857800

TRAILERS & TRANSPORTERS

BRIAN JAMES TRAILERS
» Connected to you
www.brianjames.co.uk

PRG TRAILERS
www.prgtrailers.co.uk
Phone no: +44 (0) 1270 812402

WHEELS

Image Manufacturers of bespoke split rim alloy wheels
www.imagewheels.co.uk
IMAGE WHEELS INTERNATIONAL LTD.

RACE & RALLY CARS

NURBURGRING VLN Championship and 24 Hours.

Drive available -

In Saxon Motorsports BMW 135D GTR. This car competed in 6 VLN rounds and the 24 hour race last year, winning the class in all of them without a single mechanical problem.

If you want to join the team for 2014
Email: nick@saxon-motorsport.co.uk
or Tel: **01432 350157**



2002 3.21 Porsche Boxster S

Fully race ready / recently built, ready to enter porsche championship

- Full engine rebuild / race ready at cost of over £9,000, no expense spared
- New clutch, brake pads / disks etc.
- 2 brand new sets of wheels and tyres.
- McLaren engine oil.
- 'Li fellne' fire extinguisher system and autoelec system.
- 'Recaro' racing seat with 'Schroth' 3 point safety harness.
- 'Custom Cages' roll cage.
- Carbon fiber internal door panels, floor and dashboard
- 'Vidbox' camera /recording system (optional).

can be used for Trackdays, BRSCC Porsche championship, Britcar, GT cup, Modern Classics, 750 motor club

Less than 30mins test from new build, beat the lap record at Donnington.

£25,000 ono Contact Kevin - tel - **07973 675 734** email - kevin@ruffordhall.com

TRAILERS & TRANSPORTERS

WOODFORD TRAILERS



www.WOODFORDTRAILERS.com

HIGH QUALITY TRAILERS FOR CLUB, PRIVATE AND PRO MOTORSPORTS



Email: sales@woodfordtrailers.com

CALL US NOW **01327 263 384**

BRIAN JAMES TRAILER

Race Transporter in bespoke black. Tri- axle (6 wheel) 5 door in excellent condition. Hydraulic tilt bed with remote electric winch and ramps, 2 spare wheels. Deck width 2.23m x 5.4m by 2.5m high.



£11000 ovno

Tel. John on 07770 925153 or 01202 477474

PRG TRAILERS

Finest Built British Trailers.



PRG Trailers | Cheshire | UK | Tel: +44 (0) 1270812402
Web: www.prgtrailers.co.uk | Email: info@prgtrailers.co.uk

BRIAN JAMES TRAILERS

»» Connected to you



www.brianjames.co.uk

Established in the present

Carefully crafted, finely honed enclosed designs offer discreet, safe and efficient vehicle transportation. Style is always important, never more so than when in such illustrious company.

The latest Race Transporter models are testimony to the technology, craft and designs our dedicated engineers have developed.

Main photograph, Race Transporter 5 with high level tyre rack and work bench combination, Interior LED lighting pack and 'style 1' Alloy wheels.

Race Transporter range from £ 7,099 (excl. VAT).



T +44 (0)1327 308 833

For more information and details of your local BJT dealer please call or visit our website.

RACE TRANSPORTER



HOPKINS
MOTORSPORT

☎ 0117 950 9294

ORDERS NOW

BEING TAKEN FOR **2015** DELIVERY
POP UP ROOF & HYDRAULIC SLIDE OUT
VEHICLES TO ANY SPECIFICATION

Europe's Largest Motorhome-Office-Hospitality Vehicle

TRAILERS & TRANSPORTERS



ULTIMATE IN LUXURY

BUILT TO IMPRESS

Everybody in motorsport has different requirements, be it mobile garages, living, offices or hospitality or a combination; Hopkins Motorsport will build your vision - however radical!

A revolutionary design with 1,100 sqft of living space incorporating 4 slide out pods, a hydraulic pop up roof to achieve three levels with 2.1metre of headroom in each level and still be able to travel legally throughout Europe. Once at a venue this vehicle can be easily set up by one person in under an hour!

This extraordinary vehicle will accommodate eight people in homelike comfort and luxury.

www.hopkinsmotorsport.com

THE RACE TRANSPORTER SPECIALISTS

NEW & USED SALES :: RENTAL :: REFURBISHMENT

PREMIUM CLASS IN THE WORLD OF MOTORSPORTS!

GERMAN ENGINEERING ON BOARD



living quarters

workshop facilities

technical office



BISCHOFF SCHECK AG

WWW.BISCHOFF-SCHECK.COM

WorldMags.net

MARKETPLACE

ART

PAUL DOVE ART



HUNT v LAUDA
www.pauldoveart.co.uk
paul@pauldoveart.co.uk

CAR TYRES

FOR ALL YOUR
AVON
 TYRES
MOTORSPORT
 RACING TYRES
 Inc. ACB 10 Formula Ford
 Contact

BMTR LTD

Tel: 0121 331 1122
 Fax: 0121 331 1144
 email: sales@bmtr.co.uk
 see our new website at www.bmtr.co.uk

EVENTS

I.R.T.S

International
 Race Tyre Service

REUNION

Please contact Alan on
01992 701149

MEMORABILIA

F1 COLLECTORS .COM



#1 FOR F1 MEMORABILIA & AUTOGRAPHS

We buy and sell F1 items
AYRTON SENNA specialists

Call CHRIS GRINT

01763 274448

email:- sales@f1collectors.com

RACE PRODUCTS

demon tweeks NEW 2014 CATALOGUE

508 pages of the best motorsport parts, accessories and innovative new products.

TEL **0906 250 1516** www.demon-tweeks.co.uk
Calls to 0906 numbers cost 50p per minute at all times. (Calls should last no longer than 1 1/2 minutes).

OR TEXT CODE MSAS TO 84010 WITH YOUR NAME, ADDRESS, POSTCODE If you do not wish us to contact you by mail or text with any information, promotion or special offers we may have in the future, insert X at the end of your message. Brochure requests via SMS are charged at £1.50 per message sent. Calls to 0906 numbers cost 50p per minute at all times. (Calls should last no longer than 1 1/2 minutes).



AUTOSPORT

IF YOU'D LIKE TO
 ADVERTISE YOUR
 PRODUCTS AND
 SERVICES IN THE
 MARKETPLACE CALL:

0208 267 5865

MARKETPLACE

STORAGE



SYSTEM
 STORE
 SOLUTIONS LTD

DRIVING INNOVATION FORWARD IN WORKSHOP DESIGN & STORAGE



- New race bays
- Machine shops
- Stand-alone workstations
- Mobile storage units
- Workbenches, trolleys & racking for workshops



System Store Solutions are pioneering the latest design and installation of motorsport workshops and transporters to teams in classic/historic racing right through to Formula One.



Providing a total design, layout and installation of storage products from the FAMI range including project management, consultation, technical advice and no obligation site surveys.



01622 859522

sales@systemstoresolutions.com

www.system-store.com

EVENTS

Organised by
The Historic Racing Drivers Club



'BTCC CELEBRATION' SALOON CAR RACE 1958 - 1966



SAT.
MAY 3 2014
DONINGTON
HISTORIC
FESTIVAL

Entry Form:
www.hrdc.eu
direct@juliusthurgood.co.uk
07850 361159

Sponsored by



DONINGTON
HISTORIC
FESTIVAL

RACE PRODUCTS

CARTEK

MOTORSPORT ELECTRONICS



Innovative products:

- Solid State Battery Isolators
- Power Distribution Modules
- Wireless Steering Wheel Controls
- Coolant Sensors
- FIA Rain Lights
- Shift Lights



www.CARTEKMOTORSPORT.com
CARTEK AUTOMOTIVE ELECTRONICS Ltd
44 (0)2380 637600
info@cartekmotorsport.com



MARDI GRAS MOTORSPORT

Saloon Car Preparation

Unit 45, Silverstone Circuit
Towcester
Northampton NN12 8GZ

tel: 01327 858006 fax: 01327 858800
email: info@mardigras.co.uk
web: www.performanceclutch.co.uk

Distributors and agents for:



FIRE SERVICES
Extinguisher Refills on Site



MARKETPLACE

INSURANCE

One discount, two discount, three discount, more...

Insure your cars with Admiral MultiCar, and each car receives a great discount. More cars equals more discounts!



Admiral.com

0800 600 880



80% OFF
car insurance



If you have 8 years or more No Claim Discount

Chat to churchill™
0800 917 7626

churchill.com

Applies to new customers for the first year. Minimum premium applies. Excludes N.I. Underwritten by U K Insurance Limited.

MOTORSPORT JOBS

AUTOSPORT

Want to advertise a motorsport job?

If you are recruiting in motorsport and wish to advertise with Autosport in print and online please contact Jonathan.whitehead@Haymarket.com by email or call 020 8267 5908.

For all current vacancies advertised please visit our website www.autosport.com



tiab **Where are you?** **Software Engineers needed**

for GUI & real-time controller programming.

see tiab.co.uk

www.tiab.co.uk

AUTOSPORT

And here are the views of some of our satisfied clients:

"We received an unexpectedly large amount of responses in only a few days. We would definitely consider Autosport for any future recruitment needs."

Jose Santos, Race Engineer Matech Concepts

"At Flybrid Systems we have used Autosport as a single source to advertise a range of jobs from design and development engineering roles to assembly technicians and administrators. We have always had a strong response and on the last occasion we received over 200 applications for 6 posts."

Jon Hilton FIMechE CEng, Managing Partner, Flybrid Systems LLP

"The decision to advertise for staff in Autosport was easy as the magazine is one of the most widely read motorsport publications in the world. The resulting response also met our expectations providing us with a large number of high quality candidates. What exceeded our expectations was the friendly and helpful nature of the Autosport staff who helped us with the timing and preparation of our advertisement. I would recommend the use of Autosport to any organization looking to recruit staff in our business."

Steve Hallam, Director of Competition, Michael Waltrip Racing



WE ARE LOOKING FOR INSPIRED AND INNOVATIVE ENGINEERS TO HELP GUIDE THE STRUCTURAL DESIGN OF OUR F1 RACING CARS

Based at the centre of our design office you will be a member of our Structures Group, working on the huge variety of structural components that make up our cars. This will involve close, regular interaction with the various design groups, aerodynamics, vehicle dynamics, testing and of course the race team itself.

Your target will be to help us achieve the crucial, delicate balance between out and out performance and reliability.

To do this you will need a strong practical, analytical approach, backed up by a good engineering qualification and high quality experience in structural analysis, using both classical 'hand' calculations and the latest Finite Element Analysis techniques.

As you would expect, we are always pushing to utilise the very latest materials and a broad understanding of metals, composites and plastics would come in very useful.

In return we offer the opportunity to work as part of a highly successful team, in an exciting environment where you can see the results of your work on the racetrack in only a matter of days.

To apply for the Structures Analyst role (HR31031401), or any other positions at Red Bull Racing and Red Bull Technology, please visit the jobs link on our website www.infiniti-redbullracing.com.

CLOSING DATE FOR APPLICATIONS – 13TH APRIL 2014

PLEASE NOTE: No Agencies please.



TAKING **SERIOUS FUN** TO ANOTHER LEVEL

Be part of the fastest growing and most exciting single make series in the UK, as **Atom Cup** enters its second season. 16 races over 8 weekends at the UK's top tracks, in the sensational Ariel Atom.

**FULL SEASONS
RACING FROM
£25,600+VAT**



- HONDA RELIABILITY
- F1 HOSPITALITY
- TELEVISED COVERAGE
- AFFORDABLE PACKAGES
- TRACKSIDE ASSISTANCE

**For further details visit:
www.atomcup.co.uk**

16 RACES, 8 RACE WEEKENDS



Silverstone GP



Rockingham



Donington GP



Cadwell Park



Oulton Park



Brands Hatch GP



Silverstone National



Snetterton 300



SIGN UP TODAY!

Call 01926 258028 or e-mail: info@atomcup.co.uk to secure your place on the grid

CLUB AUTOSPORT

NATIONAL RACING • HISTORICS • RALLYCROSS • HILLCLIMB • TRACK TESTS



Onslow-Cole will race Nissan's GT3 monster

SCOTT MITCHELL
EDITORIAL ASSISTANT

scott.mitchell@haymarket.com
@ScottMitchell89



THE CONFIRMATION THAT

Nissan's mean-looking GT-R Nismo GT3 will join the British GT grid full-time again is another feather in the championship's cap.

Tom Onslow-Cole teased everyone last week with the news that he and Paul White would join the series for 2014 – despite not revealing in which car, or with which team. That the multiple British Touring Car race winner will be part of a factory-supported effort, with JRM providing JMH Automotive with personnel on race weekends and fettling the car away from the track, makes that entry a tantalising prospect. The Strata21 squad, as it will be known, has a slim chance of making the Oulton Park grid though, as organisers have confirmed that the Cheshire circuit's 34-car limit has already been reached.

From one healthy British series to another, and heading to the BTCC's curtain raiser at Brands Hatch last weekend it was difficult not to wonder whether the new UK track-limits rule was about to kick up a big controversy. And I couldn't help but observe, with great scrutiny, each car as it ran onto the kerbs exiting Paddock and Graham Hill Bend. There were a few warnings for different drivers, and a five-second penalty for Karl Leonard in the first Porsche Carrera Cup GB race, but that was as bad as it got.

Whether it's with CCTV surveillance or old-fashioned human observation, so far the new regulation has been obeyed with diligence and punished sensibly when breached. It's very early in its employment, but hopefully what was feared as being a major 2014 controversy will prove the opposite.

Nissan returns to British GT

BTCC convert Tom Onslow-Cole to race factory-supported GT-R

NISSAN WILL RETURN TO THE British GT grid this season with British Touring Car convert Tom Onslow-Cole driving a factory-supported GT-R Nismo.

Seven-time BTCC race winner Onslow-Cole will partner Paul White with assistance from the JRM squad that has led the development for the Japanese manufacturer's GT3 model.

The GT-R appeared in British GT once last year, with Jody Fannin and Mark Cole driving two cars solo at the first round at Oulton Park, but was a race winner with Alex Buncombe and Jann Mardenborough in its debut season in 2012.

JRM will prepare the car between races and provide raceday assistance to JMH Automotive, which will take up the weekend running of the car, entered under the Strata21 banner.

Onslow-Cole and White, who paired up for selected GT races in 2013 and also contested this year's Dubai 24 Hours, tested the car for the first time on Tuesday at Snetterton, but are unlikely to take part in the curtain-raiser at Oulton Park later this month due to a confirmed full grid of 34 cars.

"We've done our research, and its results and build can't be faulted," Onslow-Cole told AUTOSPORT. "The link with JRM is great, that's an integral part for me. To be in a minority car is a good thing. Once we've caught up with learning we want to be at the front."

Despite the late deal and an expected delayed start to the season, Onslow-Cole believes the JRM affiliation will allow the pairing to run at the front.

"It's a big challenge, you can't underestimate that," he admitted.

"But although it's late, it's been done properly. I haven't done a huge amount in GTs but I've got more than 200 races under my belt and I'm sure somewhere I've learned something."

AUTOSPORT understands that a second Nissan prepared by JRM will also contest the season, driven by an experienced GT driver and a rookie.

While the Japanese marque is returning to the grid, Mercedes will not be represented on a full-time basis. Single-seater powerhouse Fortec Motorsport ran one AMG SLS GT3 last season but will focus primarily on European racing.

Team boss Richard Dutton said: "We're concentrating on the Blancpain Sprint Series with two Mercedes. It's more what we're about, with pro drivers. We didn't feel the British championship is where we want to be but may do some of the big circuits, like Silverstone and Brands Hatch, which suit the SLS."

David and Godfrey Jones, who drove a Team Pyro-run Merc in 2013, will run the McLaren MP4-12C they raced at selected rounds last year on a permanent basis this season.

AUTOSPORT also understands that Gulf Racing has decided to focus on its European Le Mans Series campaign and will not enter British GT this season as planned.



Fortec Merc will not return full-time



Track limits not an issue at Brands

Hill took third
in second race



EBREY/LAT

Carrera Cup

Hill stars on Porsche debut at Brands

FORMER GINETTA STAR AND sometime British Touring Car racer Jake Hill made his Porsche Carrera Cup GB debut at Brands Hatch last weekend, netting a podium finish.

The 20-year-old, who won on his S2000-class debut in the BTCC last year and also drove a Rob Austin Racing Audi A4 NGTC in the finale, was a late addition to the Carrera Cup grid for the season opener.

He drove the In2 Racing-prepared 991 GT3 Cup car for the first time

on Friday morning but finished fourth and third in the two races.

Hill is uncertain of continuing in the championship for the rest of the year, but hinted it – or a BTCC drive – was a possibility.

“The Porsche [grid] number was quite low and there was a last-minute deal to be done,” he explained. “I hadn’t really thought about it but then I thought, ‘let’s have a go’. I’m very grateful.

“If I’m not going to be in a Porsche

again this season I’ll be in a touring car. But I’ll just wait and see.”

A number of other drivers made their Carrera Cup bows at Brands Hatch, including scholar Josh Webster, Kieran Gallagher, Peter Kyle-Henney and Stephen Liquorish.

Emmerdale actor Kelvin Fletcher, a regular in the defunct GT3 Cup Challenge last year, was another Carrera Cup rookie present but admitted further outings would be restricted by filming commitments.

In addition to the influx of new drivers on the 13-strong grid, Supercup driver Ben Barker returned to the series as the first of a number of planned guest drivers.

The invitational car last ran in 2009 but has been revived for this season and Porsche confirmed it will be appearing at selected rounds of the 2014 Porsche Carrera Cup GB for “an exciting mix of young, talented and, in many cases, new-to-Porsche race drivers”.

Ginetta Junior

Motorbase backing for Ginetta Junior title contender Mitchell

GINETTA JUNIOR RACE WINNER

Jack Mitchell is the latest driver to be assisted by British Touring Car race-winning squad Motorbase.

The Motorbase Academy aims to help youngsters and a number of junior drivers have had test days in the team’s Ford Focus BTCC racers in recent years.

Now Motorbase boss David Bartrum has decided to support Mitchell, who lives close to the outfit’s workshops and has conducted work experience there, this season.

“Each year I try to do something to help young drivers,” said Bartrum. “We’ve been helping Jack.

“If he does well we might do a touring car test. He’s definitely quick.”



EBREY/LAT

Mitchell sports Motorbase livery

Motorbase will leave the running of Mitchell’s G40 to established Ginetta squad JHR. “It is one of the best teams in the support paddock,” added Bartrum. “It’s a good choice for Jack.”

Mitchell qualified fastest and won both races at Brands Hatch to take a 22-point lead in the table.

Carrera Cup

Welch misses opener but still hopes for Porsche races

BRITISH TOURING CAR SQUAD

Welch Motorsport is still hoping to contest the Porsche Carrera Cup this season despite missing the opening round at Brands Hatch last weekend.

Welch, which will run two Protons in the 2014 BTCC, bought a new-spec 991 during the off-season (see AUTOSPORT, January 23).

The outfit was planning to run the car in the Carrera Cup in conjunction with established Porsche outfit Team Parker,



EBREY/LAT

Welch only ran Ollie Jackson at Brands

but did not have a driver for Brands.

Team boss John Welch said: “The right person didn’t come along with a budget. The car is there to be used, but it’s got to be the right deal.

“It’s a beautiful car, so we look forward to running it.”

Thirteen Porsches qualified for the first meeting of the 991 era in Britain.

Welch also ran only one BTCC Proton at Brands due to a lack of parts for Dan Welch’s machine.

Quick and competitive Track Day Insurance

The first online “quote and buy” system solely for the track day user, supplied by established track day and motorsport insurance provider - Ryan Motorsport Insurance

INSUREMYTRACKDAY.COM

- ✓ Damage to your car on a track day, regardless of fault.
- ✓ Any circuit in Europe, including Spa and Nürburgring Nordschleife.
- ✓ Inclusive cover for barrier damage at the Nordschleife.
- ✓ Vehicle recovery available for circuits in Great Britain.
- ✓ Organisers and Clubs - promotional rates and discounts
- ✓ Storage and transit for vehicles and trailers

Log on to www.InsureMyTrackday.com to obtain your online quote today

Ryan Motorsport Insurance Limited is an appointed representative (557405) of Independent Broking Solutions Limited who are authorised and regulated by the Financial Conduct Authority. Its Financial Services Register number is 312026

FR ALPS

Russell switches FR ALPS teams, tops Eurocup test and races 2CV

SINGLE-SEATER ROOKIE GEORGE

Russell has switched from Prema Powerteam to Koiranen GP for his 2014 Formula Renault ALPS campaign.

The highly rated 16-year-old, who is also set to contest the BRDC Formula 4 Championship with Lanan Racing, had his first running with Koiranen at the official Formula Renault Eurocup test at Jerez last week.

Karting graduate Russell was fourth on the first day in Spain and then went quickest in mixed conditions on Friday.

He travelled back to the UK to twice race a Citroen 2CV at Oulton Park on Saturday, finishing second and seventh, before heading to Donington Park to contest the Toyota MR2 race on Sunday as he seeks signatures to gain the required International C-grade licence to compete in FR ALPS. He finished 14th each time.

McLaren Formula 1 junior and Racing Steps Foundation protege Ben Barnicoat, who needs an International B licence, also took part in the 2CV races at Oulton, finishing eighth and 22nd.

Prospective F3 Cup racer Toby Sowery, who joined Barnicoat and Russell at Donington Park's BARC season opener two weeks ago, also raced at two circuits in two days.

He finished on the podium driving an MG ZR170 at Silverstone on Saturday before travelling to Donington to join Russell in the MR2 race. He finished 22nd and 24th.



Russell leads Barnicoat in 2CVs!



Mygale's FIA F4 car gets first test

The car French manufacturer Mygale hopes will be used in the British version of FIA Formula 4 has tested at Magny-Cours. It had been publicly unveiled at the Australian Grand Prix two weeks ago.

Scottish FF1600

Graham Brunton Racing becomes official Ray Scottish FFord squad

GRAHAM BRUNTON RACING HAS become Ray's official Scottish Formula Ford 1600 team for the 2014 season.

The frontrunning squad ran Craig Brunton to the Scottish title in 2010 and has been a Ray Race Car customer for four years. It also fielded Ciaran Haggerty for his debut season last year, during which he became the youngest winner in Scottish FF1600 history.

"Graham has been a driving force in Scottish motorsport for many years and has been instrumental in the promotion of the category," said Gavin Ray.

"We feel now is a good time to



Brunton has had Ray success

recognise Graham Brunton Racing for their efforts on behalf of Ray Cars and Scottish FF1600 by naming them as official Ray representatives in Scotland.

"We look forward to working with him and wish the team continued success."

HUMBLE PYE

The voice of club racing



Appearance of the Alpine A441C was a highlight for Pye

Another fine meeting to add to Goodwood's roster

As ever in Goodwood's modern era, which now spans 38 extraordinary motorsport showcases, detail was everything with the 72nd Members' Meeting. Nobody though – especially those who drove through last week's sleet and hail storms – could have predicted the Pantone 291-blue skies that prevailed throughout the landmark weekend, precisely matching the event branding and the stunning Ford Mustang fastback course car.

From the moment Lord March 'ran with the hounds' on Saturday morning, opening the track in Peter Rutt's Lola Mk1 (in '48 Goodwood Fiat racer Dickie le Strange Metcalfe's hands the winner of the final race at the 71st BARC Members' Meeting in July 1966) glorious sunshine, mirroring the carpets of daffodils planted around the campus, made the West Sussex estate a picture-postcard venue for the new experience.

Different it was, most noticeably for the airy paddock and spectator banks, relaxed ambience and lack of massive grandstands opposite the pits. The all-inclusive school sports-day team element [won by Anthony Reid's Methuen squad, incidentally] found favour with GRRC members, guests, those on the GRRC waiting list – and Facebook 'likers' invited when ticket sales were slow. Given that this weekend last season I was at Thruxton's sub-zero Easter Revival, 20 degrees Celsius was another result!

The racing was great, because airfield circuits make it so when treaded-tyred historic cars have more power than grip, but the Group One saloons were superb. I had been sceptical about post-period racing at Goodwood, but it worked

superbly. For many privateers it was their passport to paradise. Long may it remain so. Nobody wants to see the same people in every race.

The Long-Tailed Le Mans and Turbo F1 Car demonstrations added to the occasion, and it was good to see the drivers of the McLaren P1 and Ferrari F40 pace cars being permitted to up the tempo on Sunday. It was among the former set, corralled in the feature garages

"I was sceptical, but post-period racing at Goodwood worked superbly"

behind the pits, that I discovered my favourite bolide of the weekend.

Fresh from a five-year restoration, Flavier Marcais' unique Alpine A441C was Marie-Claude Beaumont's and Lella Lombardi's chassis in 1975. Sold to Giancarlo Naddo in '76, and once shared by Vittorio Brambilla, it raced on until '79. Frustratingly, having not turned a wheel in 35 years, a starter-motor problem silenced the car and denied fans the two-litre Renault V6 engine's wait. That would have completed the fever for me.

Marcus Pye

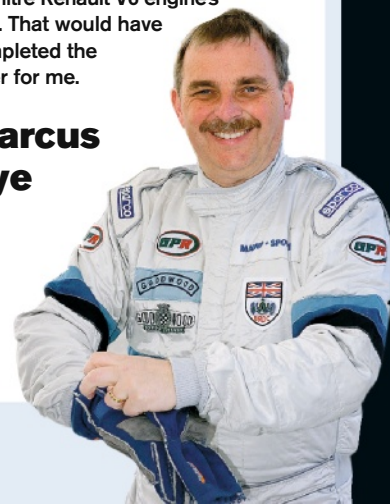

WIN A WEEKEND AT THE 2014 BRITISH GRAND PRIX



The 2014 British Grand Prix will be the 50th to be held at Silverstone, and we have teamed up with Silverstone to offer one lucky winner and guest the chance to enjoy the celebrations with a pair of general-admission tickets for the three days (July 4-6), plus camping in the AUTOSPORT campsite at Whittlebury Park.

As well as on-track action, enjoy the entertainment provided, including a Heritage Village of classic F1 cars from Silverstone's first 49 grands prix, the Kaiser Chiefs concert, air displays, entertainment zones and the post-race Grand Prix Party.

And when you go back to your tent, you can enjoy the F1 Fan Village with more music and entertainment.



www.silverstone.co.uk

or call 0844 3728 300 Tickets available from £65

TO WIN, ANSWER THIS QUESTION:

Who won the 2013 FORMULA 1 BRITISH GRAND PRIX at Silverstone?



Nico Rosberg



Lewis Hamilton



Sebastian Vettel

THE CLOSING DATE IS MIDNIGHT ON APRIL 20 2014

Terms and conditions: 1. To enter: visit autosport.com/competition; 2. Entries close: 11.59pm on April 20 2014; 3. Prize(s) are as stated in the competition; 4. Open to UK residents aged 18 or over; 5. No cash alternative, prizes are non-transferable; 6. Only one entry per person; 7. For full terms and conditions see autosport.com.

The Promoter: Haymarket Media Group, Teddington, Middlesex, TW11 9BE



Whittlebury Park

www.whittlebury.com



www.whittlebury.com

or www.f1racingfanvillage.com or call 01327 850000

TO ENTER VISIT AUTOSPORT.COM/COMPETITION



Thirty-car race is planned for new electric car

Bluebird

Electric Bluebird's BTCC support gig

A NEW ELECTRIC RACECAR BUILT by British manufacturer Bluebird will debut in a special father-son race in support of the British Touring Car Championship round at Rockingham. Organisers are planning a 30-car grid for the inaugural Bluebird Trophy and revealed six "celebrity" pairings will be part of the charity race, to be held as part of the BTCC meeting on September 6-7. Don Wales, the grandson of Bluebird's

legendary land speed record holder from the 1920s Sir Malcolm Campbell, is working with the Northamptonshire circuit to co-ordinate the event. "Electric car technology is central to everything we are doing at Bluebird and this is another opportunity to demonstrate our engineering and motorsports development," he said. "Creating the Bluebird Trophy for fathers and sons is a great way of

showcasing our advancements while raising funds for good causes." Details of the meeting, cars and driver line-ups will be revealed at a launch event at Rockingham in the spring. Circuit chief executive Peter Hardman added: "We are delighted to see our idea become a reality. To mark the race with the return of Bluebird to the track, in what will be the first electric car race in the UK, just makes it even more special for us."



EBREVIAT

In brief

Karting ace's debut
Karting prodigy Lando Norris made his car racing debut in the Ginetta Junior season opener at Brands Hatch last weekend. The 14-year-old (above), a late addition to the entry list with HHC Motorsport, qualified third but was pushed back in the pair of races and finished sixth and 10th.

Late deal for duo
Louise Richardson and motorsport broadcaster Ben Constanduros made their British Formula Ford debuts last weekend with Richardson Racing. Richardson achieved a best finish of 10th in the opening race and could contest the remainder of the season alongside a second permanent driver. Constanduros thrice finished 12th.

Walkinshaw's big effort
Ginetta GT4 Supercup racer Fergus Walkinshaw returned to the series at the last minute for the first round at Brands Hatch. Walkinshaw, who built the car with the help of a friend in two weeks, missed qualifying and the first race but finished 12th in the second and was running in the top 10 before retiring from the finale.

MG racer hurt in crash
MMM & T-Types racer Hamish McNinch was hospitalised after a heavy crash at Silverstone last Saturday. His MG C-Type Montlhery suffered a puncture and flipped over. McNinch was thrown clear, but suffered two fractured vertebrae and was awaiting further news in hospital as AUTOSPORT went to print.

Huge entry for HSCC
Historic Sports Car Club organisers are expecting a 250-car entry for its season opener at Donington Park this weekend. Eight series will take part in the curtain raiser, with the 24-car Classic Racing Car Championship the meeting's smallest entry. The Formula Junior and Guards Trophy entries are both oversubscribed.



New Civic series had a good debut

Civic Cup/5club Mazda

750MC hails new Civic/MX5 grid

THE 750 MOTOR CLUB HONDA Civic and Mazda MX5 categories attracted a combined entry of 40 cars for their debut last weekend. Eighteen Civic Cup drivers and 24 5Club-run MX5 competitors were entered for Donington Park. They

qualified together before running separately, though one Civic and two MX5s did not take part. "I'm really pleased, it certainly exceeded expectations," said competitions manager Giles Groombridge. "We're really proud."

Historic F1

Barber goes flat-bottomed

MASTERS HISTORIC FORMULA 1 race winner Richard Barber will step up to the FIA championship's flat-bottomed class at Barcelona this weekend in a newly-acquired Williams FW08C.

Barber tested the new car at Donington Park last Thursday following a short shakedown at Pembrey. "I loved the Fittipaldi [F5A], but the Williams already feels quicker," said the 1983 British 250 International Superkart Grand Prix winner. "I know I have a good car under me, and once we get a fuel pick-up issue sorted I hope to be challenging for class wins." Champion Greg Thornton, who has switched to a Classic Team Lotus-prepared 91, local hero Joaquin Folch (Brabham BT49C), Michael Lyons (Hesketh 308E) and Katsu Kubota (Lotus 72) are among the 31-car field.



Tohill raced DS3 at Lydden

Rallycross

Euro champ Tohill in Supercar debut

TWO-TIME EUROPEAN TOURINGCAR Rallycross champion Derek Tohill made his Supercar debut at Lydden Hill's British Rallycross Championship opener. Tohill, who will contest the World Rallycross Championship with Liam Doran's team, raced the Citroen DS3

Supercar for the first time last weekend. He won the second heat, but retired from the final with suspension damage. "Working under high pressure in a race environment you learn so much more than during testing," he said. "It forces you out of your comfort zone."



Historic tin-tops will star on HSCC bill

Drinkwater tops busy Bimmers



DAVID DRINKWATER OUTPACED his rivals to win both of his BMW Compact Cup races as the 750 Motor Club's season opener helped celebrate its 75th anniversary.

The first Compact Cup race had to be restarted and was dominated by Stuart Voyce. Stephen Roberts, the 2013 season dominator, had pressed hard at the start but lost out to Alex Dew and Mike Tovey on the opening lap. He soon reclaimed third exiting Redgate, but it took another four laps until he successfully challenged Dew on the Craner Curves and took second.

Voyce led a four-car break at the start of the second race. As Daniel Kirby started to lose touch with the group, Drinkwater charged ahead through Goddards on the second lap and immediately pulled away. Voyce was left to successfully defend second from Alan Kirkaldy, well clear of fourth-placed Michael Gray.

Roberts made the best start in race three, taking the outside line at Redgate to nose ahead on the exit. Drinkwater had demoted Dew and was quick to make his move for the lead. He was alongside into Goddards and opted for the outside, before pulling clear on the exit.

Both Dew and Kirkaldy then piled the pressure on Roberts and both got by at the Melbourne Hairpin. Roberts reclaimed third into McLeans, but Dew had made second secure, still well adrift of challenging

Drinkwater's lead. Kirkaldy pitted, so Declan McDonnell secured fourth.

Both Toyota MR2 races followed a similar pattern with Matthew Palmer taking lights-to-flag victories. In the first he was shadowed for the entire race by Jim Davies, with Stuart Nicholls sitting in a solitary third. Davies got alongside Palmer on a number of occasions, but never had the power to nose ahead. Ben Rowe held a race-long fourth and, after Robert Wells had slipped from an early fifth, Nigel Ralphson and John Wilson completed the top six.

Palmer escaped at the start of race two, while it was Nicholls defending second from Davies. As in the first race Davies was on the attack, but this time for second. With Palmer well clear, Davies was still fighting on the last lap. It was side-by-side out of Goddards, but Davies took the place by 0.01 seconds in the run to the flag, with Wilson, Kristian White and Matthew Wallis well back in the fight for fourth.

Billy Albone was another double winner with his Batten 3 in the 750 Formula. Ed Pither's PRS and Ron Gearing (Darvi) were well spread out in race one as they completed the podium, leaving Bill Cowley, Bob Simpson and Andrew Kemp to settle the top six.

With Albone in the clear from the start of race two, Cowley led the chase from Gearing as they exited Redgate

on the opening lap. Gearing retook second into the Esses and managed to consolidate it from Cowley. Chris Gough had run in fifth after losing out to Pither, but fell behind Dave Robson, who then spun at the Esses.

In his first-ever race John Schultz took a comfortable win in the 750 Trophy, taking the flag in his JoMo more than 26s ahead of Danny Ruta's DNC. It could easily have been another double win, but Michael Harvey and his JB Special did enough to keep Schultz back in the second race, both finishing over one and a half minutes clear of third-placed Michael Dorsett's HCS Renault.

The Spire of Matthew Higginson may have been the quickest car in the RGB field, but after both races were red-flagged he stalled at the restarts and was left playing catch-up. The similar car of John Cutmore led for virtually the whole of both races, but in the first he was caught at the last corner by the recovering Higginson and beaten to the flag by 0.04secs, with Dave Wale just keeping Jonathan Thackray and Alistair Boulton at bay for third in an all-Spire top five.

Cutmore managed to retain his race-two advantage, with Paul Rogers's Contour and Boulton rounding off the podium positions



**Double victor
Palmer headed
huge MR2 pack**



Drinkwater won both of his Compact Cup races at Donington



Schultz triumphed on race debut



Baker won new Civic Cup category

after demoting Jonathan Thackray at the Esses on lap two.

For most of the Roadsports enduro it was a duel between Gary Goodyear (Lotus Exige) and Rob Horsfield (Toyota MR2 Turbo) for supremacy. The Porsche 924S of Steve Hewson/Robert Gilham also had a spell in front but, after the mandatory stops had been made and the dust settled, Goodyear consolidated the lead over Horsfield, with Martin Short's Toyota GT86 securing third after the Porsche slowed late on.

There was another double winner in the Bikesports where Jon-Paul Ivey's Radical PR6 reigned supreme.

Mark Conroy (PR6) was second throughout but excluded over a weight issue. James Breakell moved up to second having defended sternly from Steve Burgess, as both were chased by Ben Dimmack. Tim Gray was the first non-Radical, with his fifth-placed Spire.

Ivey and Burgess had a great scrap for the lead in race two, and Burgess briefly led from Coppice on lap seven, but Ivey was back in front a lap later and just held onto his advantage. Breakell and Gray passed Dimmack for third and fourth respectively.

Ian Prior just held off Mark Fowler to take the win in the first MGBCV8

race, with Ollie Neaves third. Fowler just missed out again in race two, with Neaves the victor this time and Prior third ahead of Robert Spencer.

Both 5Club Mazda MX5 Cup races were easily won by Will Blackwell-Chambers, with Martin Tolley and Gary Hufford completing the podium on each occasion.

David Weston was never headed in either of the Midget & Sprite Challenge races, but it much closer behind as Ed Reeve and Martin Morris duelled for second. Reeve edged it in the first race, with Sam Healey a distant fourth. After swapping places almost every lap in race two, Morris

had to settle for third again after his gear lever snapped.

The Civic Cup was fairly well supported but nobody could match Robert Baker, who took a pair of comfortable wins. Luke Sedzikowski led both but had to settle for third behind Rich Hockley in race one, before colliding with him in race two and taking second.

Mark Fowler chased fellow MGB GTV8 driver Ian Prior for the whole of the first Thoroughbred Sports race, but roles were reversed in the second, with Fowler winning and Russ McCarthy splitting the duo early on.

● Peter Scherer

RESULTS

BMW COMPACT CUP (7 LAPS) 1 Stuart Joyce 13m53.86s (75.25mph); 2 Stephen Roberts +6.05s; 3 Alex Dew; 4 Mike Tovey; 5 Declan McDonnell; 6 Farard Darver. **Fastest lap** Joyce 1m58.29s (75.78mph). **RACE 2 (8 LAPS) 1 David Drinkwater 15m49.11s** (75.56mph); 2 Joyce +1.57s; 3 Alan Kirkaldy; 4 Michael Gray; 5 Ireneusz Zaleski; 6 Daniel Kirby. **FL** Kirkaldy & Joyce 1m57.63s (76.21mph). **RACE 3 (8 LAPS) 1 Drinkwater 15m53.38s (75.22mph)**; 2 Dew +2.36s; 3 Roberts; 4 McDonnell; 5 Darver; 6 Kevin Denwood. **FL** Drinkwater 1m57.93s (76.01mph). **TOYOTA MR2 (BOTH 8 LAPS) 1 Matthew Palmer 15m19.70s (77.97mph)**; 2 Jim Davies +1.45s; 3 Stuart Nicholls; 4 Ben Rowe; 5 Nigel Ralphson; 6 John Wilson. **Class winners** Davies; Toby Sowery. **FL** Davies 1m53.98s (78.65mph). **RACE 2 1 Palmer 15m21.17s (77.85mph)**; 2 Davies +3.84s; 3 Nicholls; 4 Wilson; 5 Kristian White; 6 Matthew Wallis. **CW** Davies; Sowery **FL** Palmer 1m53.93s (78.68mph). **750 FORMULA (BOTH 9 LAPS) 1 Billy Albone (Batten 3) 16m06.64s (83.46mph)**; 2 Ed Pither (PRS 1B) +7.71s; 3 Robin Gearing (Darvi P88); 4 Bill Cowley (Cowley MkIV); 5 Bob Simpson (SS/F); 6 Andrew Kemp (Racekits Falcon). **CW** Nigel Harvey (PC Special). **FL** Gearing

1m45.09s (85.30mph). **RACE 2 1 Albone 16m07.28s (83.41mph)**; 2 Gearing +3.80s; 3 Cowley; 4 Pither; 5 Chris Gough (CGR02 Evo); 6 Bill Rutter (Darvi Mk5). **CW** Harvey. **FL** Albone 1m45.18s (85.23mph). **750 TROPHY (BOTH 7 LAPS) 1 John Schultz (JoMo) 15m58.55s (65.46mph)**; 2 Danny Ruta (DNC) +26.14s; 3 John Gaskin (Centaur Mk16); 4 Michael Inglis (Austin 7); 5 David Whetton (Austin 7); 6 Alistair Frayling-Cork (Austin 7). **CW** Inglis. **FL** Schultz 2m12.42s (67.69mph). **RACE 2 1 Michael Harvey (JB Special) 15m40.95s (66.69mph)**; 2 Schultz +1.12s; 3 Michael Dorsett (HCS Reliant); 4 Gaskin; 5 Inglis; 6 Whetton. **CW** Inglis. **FL** Harvey 2m09.90s (69.01mph). **RGB (4 LAPS) 1 Matthew Higginson (Spire GT3) 6m41.52s (89.30mph)**; 2 John Cutmore (Spire) +0.04s; 3 David Wale (Spire); 4 Jonathan Thackray (Spire); 5 Alastair Boulton (Spire); 6 Colin Chapman (BDN S3). **CW** Paul Rickers (STM Phoenix). **FL** Higginson 1m38.56s (90.95mph). **RACE 2 (5 LAPS) 1 Cutmore 8m21.11s (89.44mph)**; 2 Paul Rogers (Contour RGB09) +3.50s; 3 Boulton; 4 Thackray; 5 Chapman; 6 Duncan Horlor (Spire). **CW** Rickers. **FL** Higginson 1m37.90s (91.56mph). **ROADSPORTS (24 LAPS) 1 Gary Goodyear (Lotus Exige) 46m33.90s (77.00mph)**; 2 Rob Horsfield (Toyota MR2 Turbo) +12.24s; 3 Martin Short (Toyota GT86); 4 Steve Hewson/Robert Gilham (Porsche 924S); 5 Jim Davies (MR2); 6 Leon Bidgway/Andy Chapman (MR2). **CW** Short; Davies.

FL Goodyear 1m49.98s (81.51mph). **BIKESPORTS (4 LAPS) 1 Jon-Paul Ivey (Radical PR6) 6m17.61s (94.96mph)**; 2 James Breakell (PR6) +2.79s; 3 Steve Burgess (Radical SR3); 4 Ben Dimmack (PR6); 5 Tim Gray (Spire GT3); 6 John Macleod (SR3). **CW** Burgess; Richard Wise (GT3). **FL** Dimmack 1m33.28s (96.10mph). **RACE 2 (13 LAPS) 1 Ivey 20m18.92s (95.60mph)**; 2 Burgess +0.45s; 3 Breakell; 4 Gray; 5 Dimmack; 6 Macleod. **CW** Burgess; Wise. **FL** Burgess 1m32.02s (97.41mph). **CIVIC CUP (BOTH 8 LAPS) 1 Robert Baker 15m15.60s (78.32mph)**; 2 Rich Hockley +4.91s; 3 Luke Sedzikowski; 4 Mark Anderson; 5 Nicholas Chatburn; 6 Tim Evans. **FL** Baker 1m52.78s (79.48mph). **RACE 2 1 Baker 15m14.68s (78.40mph)**; 2 Sedzikowski +15.29s; 3 Chatburn; 4 Andrew Gaugler; 5 Brook Pitchford; 6 Nathan Burrell. **FL** Baker 1m52.20s (79.89mph). **5 CLUB MX5 CUP (8 LAPS) 1 Will Blackwell-Chambers 15m51.29s (75.38mph)**; 2 Martin Tolley +17.94s; 3 Garry Hufford; 4 James Rogers; 5 Ben Short; 6 Andrew Coombs. **FL** Blackwell-Chambers 1m57.99s (75.97mph). **RACE 2 (7 LAPS) 1 Blackwell-Chambers 13m52.58s (75.37mph)**; 2 Tolley +14.32s; 3 Hufford; 4 Rogers; 5 Short; 6 Marco Aghem. **FL** Blackwell-Chambers 1m57.82s (76.08mph). **MIDGET & SPRITE CHALLENGE (6 LAPS) 1 David Weston (Midget) 11m08.03s (80.51mph)**; 2 Ed Reeve (Midget) +4.15s; 3 Martin Morris (Midget); 4 Sam Healey (Frogeye

Sprite); 5 Tom Neat (Midget); 6 Nigel Pratt (Midget). **CW** Neat; Carl Chadwick (Sprite); Paul Campfield (Frogeye Sprite). **FL** Weston 1m49.82s (81.62mph). **RACE 2 (8 LAPS) 1 Weston 14m44.88s (81.04mph)**; 2 Reeve +5.95s; 3 Morris; 4 Healey; 5 Campfield; 6 Pratt. **CW** Pratt; Chadwick; Campfield. **FL** Reeve 1m49.01s (82.23mph). **MGBCV8 (11 LAPS) 1 Ian Prior (BGT V8) 20m05.43s (81.80mph)**; 2 Neil Fowler (BGT V8) +0.89s; 3 Ollie Neaves (BGT V8); 4 Chris Forrest (BGT V8); 5 Benjamin Tovey (B Roadster); 6 Mark Scott (B Roadster). **Class winners** Bob Luff (B Roadster); Forrest. **Fastest lap** Fowler 1m47.85s (83.12mph). **RACE 2 (10 LAPS) 1 Neaves 18m13.84s (81.95mph)**; 2 Fowler +0.60s; 3 Prior; 4 Robert Spencer (BGT V8); 5 Forrest; 6 Tovey. **CW** Luff; Forrest; Spencer. **FL** Fowler 1m47.32s (83.53mph). **THOROUGHbred SPORTSCARS (BOTH 11 LAPS) 1 Ian Prior (MGB GT) 20m00.78s (82.12mph)**; 2 Neil Fowler (MGB GT) +0.11s; 3 Robert Spencer (MGB GT); 4 Simon Cripps (MGB Roadster); 5 Dave McDonald (Triumph TR6); 6 Mark Scott (Roadster). **CW** Martyn Clews (MG Midget); Cripps; R Spencer; McDonald. **FL** Prior 1m48.01s (82.99mph). **RACE 2 1 Fowler 19m50.65s (82.82mph)**; 2 Russ McCarthy (MGB GT) +13.97s; 3 Prior; 4 R Spencer; 5 Cripps; 6 Jon Ellison (Triumph TR6). **CW** Jordan Spencer (MGB Roadster); Cripps; R Spencer; McDonald. **FL** McCarthy 1m46.90s (83.85mph).



Belgian ace Pauwels headed the foreign invasion at Lydden

BRITISH RALLYCROSS CHAMPIONSHIP LYDDEN HILL, MARCH 29-30 LHMC

Visitors steal rallycross glory

BELGIAN DRIVER KOEN PAUWELS stormed his Ford Focus to victory in a frantic British Rallycross Championship opener at Lydden Hill.

Reigning champion Julian Godfrey started the main event – which was joined by the first round of the Belgian Rallycross series – with his Ford Fiesta on pole alongside Koen Pauwels and the Citroen DS3 of Supercar debutant Krzysztof Skorupski.

Pauwels made a good start to run side by side with Skorupski, who headed straight into the joker section followed by the Ford Focus of Steve Harris. On the main circuit, Pauwels led as Godfrey was passed Jochen Coox and Kevin Procter. As Procter moved into second place, Godfrey repassed Coox for third.

In his first Supercar start, Derek Tohill started on the back row, but suspension damage in the first corner left his Citroen DS3 stranded in the middle of the the circuit, while

Jos Jansen retired after hitting the stationary DS3 on lap three.

Godfrey and Coox took their joker lap together on lap two, leaving Procter to hunt down Pauwels. The Belgian was next to take the longer route on lap three, only just returning to the main circuit ahead of Godfrey. Procter played his joker on the fourth tour, rejoining the battle in fourth behind Coox and initially passing the VW Scirocco, only to run wide and hand the position back.

As Godfrey struggled with a differential problem in second, Coox passed the ailing Fiesta on the last lap, leaving the British driver to fend off Procter for the final podium position and claim top British championship points. Harris finished fifth ahead of Skorupski.

“I’m so happy for me and my team,” said Pauwels at the finish. “I never expected to be on the same pace as Godfrey and Tohill, it’s great.”

Godfrey was equally happy to collect top British honours. “The car was a handful in the final, but taking maximum British points here is the perfect start to start,” he said.

Stuart Emery fought back from problems in each of his three heat races to win first the SuperNational B final and then the A final from the back of the grid. The Peugeot 206 driver took his joker on the first lap, avoiding the first-corner melee to claim victory. Polesitter Michael Boak was out of contention in the first corner after contact with Mike Howlin, allowing Allan Tapscott to finish second, with Gary Dixon third.

The Suzuki Swift Sport category provided the closest and cleanest racing of the day. Last season’s series runner-up Tristan Ovenden beat 2013 champion Graham Rodemark in a final where there was nothing to choose between the pair. Third went to Rob Maynard, while X-Games Skateboard star Danny Way made his rallycross debut to win the B final and finish seventh in the A final.

The RX150 category was claimed by Marc Scott after a close duel with rally convert James Grint, while the Super1600 category was won by Belgian champion Dennis Remans.

Polesitter Charlie Bean was victorious in the Junior Swift class, just ahead of Drew Bellerby and Jake Taylor. Ray Morgan (Ford Escort) claimed the spoils in the Retro Rallycross division, even before main protagonist Rob Gibson retired his Metro 6R4 with engine gremlins.

● Hal Ridge



Emery won Supernational

- BRITISH RALLYCROSS CHAMPIONSHIP (5 LAPS)**
1 Koen Pauwels (Ford Focus) 3m54.456s; **2** Jochen Coox (VW Scirocco) +1.938s; **3** Julian Godfrey (Ford Fiesta); **4** Kevin Procter (Ford Focus); **5** Steve Harris (Ford Focus); **6** Krzysztof Skorupski (Citroen DS3). **Class winner** Godfrey. **Fastest lap** Godfrey 44.724s.
SUPERNATIONAL (5 LAPS) **1** Stuart Emery (Peugeot 206) 4m35.294s; **2** Allan Tapscott (Vauxhall Corsa) +4.447s; **3** Gary Dixon (Vauxhall Astra); **4** Vincent Bristow (BMW 328); **5** Guy Corner (Peugeot 206); **6** Michael Boak (Audi TT). **FL** Emery 48.904s.
SUZUKI SWIFT (5 LAPS) **1** Tristan Ovenden 4m26.429s; **2** Graham Rodemark +1.043s; **3** Rob Maynard; **4** Richard Dolan; **5** Dale Cousins; **6** Jack Brown. **CW** Rodemark. **FL** Ovenden 51.100s.
RX150 (5 LAPS) **1** Marc Scott 4m11.402s; **2** James Grint +0.739s; **3** Kevin Feeney; **4** Richard Moore; **5** Adam Sargent; **6** Don MacLeod. **FL** Scott 48.736s.
SUPER1600 (5 LAPS) **1** Dennis Remans (Ford Fiesta) 4m17.413s; **2** Thijs Heezen (Ford Fiesta) +1.345s; **3** Dave van Beers (Renault Clio); **4** Marcel Snoeijers (Renault Megane); **5** Jack Thorne (Citroen C2); **6** Willem Veltman (Citroen C2). **CW** Thorne. **FL** Heezen 49.324s.
JUNIOR SUZUKI SWIFT (5 LAPS) **1** Charlie Bean 4m54.404s; **2** Drew Bellerby +0.334s; **3** Jake Taylor; **4** Jennie Hawkes. **FL** Bellerby 55.428s.
HOT HATCH/BMW MINI **1** Craig Lomax (Citroen Saxo); **2** Tomasz Marciniak (Citroen Saxo); **3** Tomasz Wielgosz (Peugeot 106); **4** David Bell (BMW Mini); **5** John Lyne (Citroen Saxo); **6** David Ellis (Citroen Saxo). **CW** Bell.
RETRO RALLYCROSS (2 LAPS) **1** Ray Morgan (Ford Escort) 1m47.221s; **2** Lance Foster (Rover Mini) +0.690s; **3** Ian Biagi (Mini Clubman); **4** Paul Smith (VW Polo); **5** Rob Gibson (Metro 6R4); **6** Barry Stewart (Porsche 911). **CW** Smith. **FL** Morgan 51.023s.



Godfrey took max British points in third



Morgan won Retro

METRO CUP SILVERSTONE, MARCH 29 MGCC

Reliability woes stop Sanderson double

RELIABILITY PROBLEMS WERE widespread through the Metro Cup field as a host of drivers suffered early-season gremlins. Several racers missed out on potential podium places because of car issues during the opening two races of the season.

One such driver was first-race poleman Ben Rushworth. In only his third race he outqualified Tom Sanderson to take top spot, but after a slow start he retired from third on lap three with engine issues.

Sanderson grabbed the lead at the start and was untroubled throughout the race, winning comfortably from Mike Williams. With Rushworth's engine having expired, David Javes spinning out at Brooklands and Jack Ashton having a coolant issue, several drivers who qualified well down the order came to the fore. Most notable was Phil Gough, who from 16th on the grid stormed through to finish fourth, not far behind Tony Howe.

In race two it was Sanderson's turn to suffer. He seemed on course for a second dominant victory when, with just two laps left, a



Sanderson won the Metro Cup opener but retired in race two

suspected differential problem struck. This enabled Williams to win from Javes and Gough, after Howe also had reliability issues.

Class B honours twice went to the impressive Jonathan Woodcock.

● Stephen Lickorish

RESULTS (BOTH 17 LAPS) 1 Tom Sanderson (Rover Metro GTi) 20m34.062s (81.35mph); 2 Mike Williams (Rover Metro) +6.680s; 3 Tony Howe (MG Metro Turbo); 4 Philip Gough (Rover 114 GTi); 5 Jim Webb (Rover Metro 100); 6 Jonathan Woodcock (Rover Metro GTi). **Class winners** Woodcock; Les Tyler (MG ZR). **Fastest**

lap Sanderson 1m11.989s (82.03mph). **RACE 2 (17 laps)** 1 Williams 20m47.082s (80.50mph); 2 David Javes (MG Metro Turbo) +22.430s; 3 Gough; 4 Woodcock; 5 Oliver Hood (Rover Metro 100); 6 Daren Angood (Rover 100 GTi). **CW** Woodcock; Tyler. **FL** Sanderson 1m12.141s (81.86mph).



Halstead/McPherson Turner was on top

ECURIE GTS SILVERSTONE, MARCH 29 MGCC

Halstead and McPherson show a good Turner pace

THE TURNER OF MARK HALSTEAD AND Stuart McPherson was dominant in the season-opening Ecurie GTS enduro, but behind them was a magnificent battle for second.

For the opening half of the race, Brian Lambert's MGB narrowly held the position but he lost out during the mandatory pitstop to TVR Grantura driver Robi Bernberg.

As Halstead and McPherson raced to a 17-second win, the battle behind raged until the flag, with Bernberg eventually claiming second – and Class 4 honours – with a last-lap move at Copse.

The only other car to finish on

the lead lap was the John Pearson/Nick Crewsdon MGB. Behind it was John Andon, despite having received a drive-through penalty for speeding in the pitlane. Craig Taylor was also penalised for pitting too early.

● Stephen Lickorish

RESULTS (36 LAPS) 1 Mark Halstead/Stuart McPherson (Turner MkII) 45m07.973s (78.51mph); 2 Robi Bernberg (TVR Grantura MkIII) +17.009s; 3 Brian Lambert (MGB); 4 John Pearson/Nick Crewsdon (MGB FIA Roadster); 5 John Andon (MGB Roadster); 6 Graham Bates (MGB Roadster). **CW** Bernberg; John Hilbery (Lotus Elite S2). **FL** Halstead/McPherson 1m11.819s (82.22mph).

COCKSHOOT CUP SILVERSTONE, MARCH 29 MGCC

Simm belies inexperience to claim dominant victory

JASON SIMM STORMED TO THE Cockshoot Cup win despite it only being his second-ever race.

Simm beat several former champions – including the returning Mike Peters – to pole in his ZS but didn't make a good start, allowing David Coulthard to take the lead. Simm reclaimed the place going onto the Wellington Straight and never looked back, winning by almost 20 seconds.

Coulthard remained second, in his first race driving an F Cup MG, with Paul Clackett's ZS third. It was a disappointing comeback for Peters, whose car hit trouble with four laps left.

Reigning champion David Morrison was another title winner to retire – with a possible brake problem – enabling Michael Ashcroft to take fourth in the last ZR 190 built, ahead of Simon Lowery.

● Stephen Lickorish

RESULTS (18 LAPS) 1 Jason Simm (MG ZS) 20m50.201s (85.02mph); 2 David Coulthard (MG F Cup) +19.665s; 3 Paul Clackett (MG ZS); 4 Michael Ashcroft (MG ZR 190); 5 Simon Lowery (MG ZS 180); 6 Ashley Woodward (MG ZS 180). **CW** Ian Winstanley (MG ZR 160); Jeremy Toes (MG Midget); Adam Key (MG ZF VVC). **FL** Simm 1m08.553s (86.14mph).



Simm's ZS was unstoppable



DEMPSTER

Roadsports

Jim Larkham (above) scored a brace of victories with his new Radical at Kirkistown, fending off John Benson's S2000 Crossle in the opening race, but having a lonely run to the flag in the second when the Crossle's gear linkage came apart. Alan Davidson's GMS took a class-winning third overall in race one and benefiting from Benson's misfortune to take the runner-up spot in the second.

MG Cup

Andrew Young, Robert Campbell and Tom Diment filled the top three spots in both MG Cup races at Silverstone on Saturday, but that only tells half the story. Behind the dominant Young there were battles throughout. In the second thrash, Campbell was closing on Young when a spin at Brooklands dropped him off his tail.

NW Sports & Saloons

A huge grid necessitated split races at Oulton Park, with multiple former champion Paul Dobson back to winning ways in the class D-F race. He was chased all the way to the flag by Ilsa Cox's SEAT Leon Cupra. It was nip and tuck between Paul Rose's Saker and Rob Spencer's Locosaki in the opening laps of the class A-C race, but Rose eventually took charge as his rival dropped back with an oil problem.

British Superkarts

Liam Morley topped the 33-kart field in qualifying at Oulton Park but had to give best to Paul Platt in the opening race. Stephen Clark completed the podium. Morley claimed victory in the sequel though, with Carl Hulme second ahead of Platt.

Citroen 2CVs

Pete Sparrow was never headed in the first race, but a terrific duel took place for second place between budding single-seater racer and karting champion George Russell (below) and Neil Savage. Savage held on to take the place. It was a two-horse fight in race two, but Peter Rundle kept his nose ahead, despite the best efforts of Simon Clarke. Rundle also won the non-championship finale.



BOURNE



DEMPSTER

Murray (5) beat Dunne in race one

FORMULA FORD 1600 KIRKISTOWN, MARCH 29

Quality trumps quantity in FFord battle

PROOF THAT A MASSIVE FIELD IS NOT necessary for a fine motor race came courtesy of the Formula Ford 1600 brigade at Kirkistown's season opener.

Jake Byrne started from pole after an impressive drive in the wet qualifying session and the track conditions remained the same for the first race.

Within a lap he, along with Noel Dunne and second-row starters Adrian Pollock and Niall Murray, had opened out a gap over the rest and the quartet stayed together, the order changing every lap. Just after the

halfway point Dunne got caught out by the still slippery conditions and dropped back, while Murray and Byrne carried on the fight with Pollock in close attendance.

A lap from the finish Byrne nosed ahead and seemed set for a maiden victory but a slip on the final tour allowed Murray through to win.

That battle resumed for race two and this time Dunne made no mistakes to fend off a determined challenge from Murray.

Byrne was with them initially, but Pollock got ahead in the closing

stages to complete the podium.

● Richard Young

RESULTS (15 LAPS) 1 Niall Murray (Van Diemen LA10) 16m12.645s (83.942mph); 2 Jake Byrne (Ray GRO9) +0.223s; 3 Adrian Pollock (Van Diemen DPO8); 4 Mike Todd (Mondiale M84S); 5 David Nicholl (Reynard 89FF); 6 Chris Paul (Van Diemen RF97) **CW** Todd; Nicholl; Arnie Black (Crossle 32F). **FL** Byrne 1m03.078 (86.290mph). **RACE 2 (16 LAPS) 1 Noel Dunne (Van Diemen RFO1) 16m38.725s (87.199mph);** 2 Murray +1.887s; 3 Pollock; 4 Byrne; 5 Paul; 6 Todd. **CW** Todd; Nicholl; Black. **FL** Dunne 1m01.119s (89.056mph).

SALOON/GT KIRKISTOWN, MARCH 29

Finn slides to win in soggy Saloon opener



Finn won first race in G50

DEMPSTER

DESPITE A FAILING REAR-WHEEL bearing, Connaire Finn slithered to victory in a very wet first race.

His cause was helped by red flags after 10 laps when David Beatty fell foul of the conditions.

Race two was dry and, in the absence of Finn, it was Stephen Traub (Integra) who took the win with Savage — the Saloon winner in race one — and Burke behind.

● Richard Young

RESULTS (10 LAPS) 1 Connaire Finn (Ginetta G50) 11m36.014s (78.203mph); 2 Robert Savage (Honda Integra) +36.910s; 3 Billy Burke (Honda Integra); 4 Simon Quinn (Honda Civic); 5 Stephen Traub (Honda Integra); 6 Andrew Armstrong (Honda Civic). **CW** Savage; Armstrong. **FL** Finn 1m06.378s (82.00mph). **RACE 2 1 Traub, 16m47.631s (81.027mph);** 2 Savage +28.432s; 3 Burke; 4 Donal O'Neill (SEAT Cupra); 5 David Beatty (Ginetta G50); 6 Armstrong. **CW** Beatty; Armstrong. **FL** Traub 1m05.186s (83.500mph).

FORD FIESTAS KIRKISTOWN, MARCH 29

Blair picks up Turkington's Fiesta baton with double

IN THE ABSENCE OF LAST YEAR'S champion James Turkington, Andrew Blair proved the man to beat in the Fiesta Zetec Cup races.

Jamesy Hagan and Ryan Campbell were very close and in the opening wet race the trio slipped and slid its way clear of the rest with Blair making it to the flag less than a second ahead of Hagan.

Conditions were dry for their second outing but again the canny Blair managed to pull away while the other two spent several laps

battling with each other, Campbell eventually getting the better of his team-mate.

Peter Barrable took a brace of fourth positions, helped by a coming together at the chicane that removed Paul Magill and James Hanna from the leaderboard.

● Richard Young

RESULTS (12 LAPS) 1 Andrew Blair, 16m20.520s (66.614mph); 2 Jamesy Hagan +0.999s; 3 Ryan Campbell; 4 Peter Barrable; 5 Paul Magill; 6 James Hanna.



Blair took a Fiesta double

DEMPSTER

FL Hagan 1m20.003s (68.035mph) **RACE 2 (13 LAPS) 1 Blair 17m03.830s (69.112mph);** 2 Campbell +2.923s; 3 Hagan; 4 Barrable; 5 Richard Livingston; 6 Ian McCallister. **FL** Campbell 1m17.641s (70.105mph).

NATIONAL RESULTS ROUND-UP

SILVERSTONE
MARCH 29, MGCC



MG CUP (17 LAPS) 1 Andrew Young (MGC GT) 19m57.358s (83.84mph); 2 Robert Campbell (MGC GT) +12.549s; 3 Tom Diment (MG ZR 190); 4 Paul Eales (MGB GT); 5 James Walpole (MGB Roadster); 6 Alan Brooke (Rover Metro GTi). **Class winners** Eales; Niall Campbell (MGB). **Fastest lap** Young 1m09.362s (85.14mph).
RACE 2 (18 LAPS) 1 Young 21m01.236s (84.28mph); 2 R Campbell +17.867s; 3 Diment; 4 Brooke; 5 Eales; 6 Clive Jones (MGB Roadster). **CW** Eales; N Campbell. **FL** R Campbell 1m08.922s (85.68mph).
MG TROPHY (BOTH 17 LAPS) 1 Jake Fraser-Burns (ZR 190) 20m04.235s (83.36mph); 2 Richard Buckley (ZR 190) +0.006s; 3 Richard Marsh (ZR 170); 4 Toby Sowery (ZR 170); 5 Julia Penfold (ZR 170); 6 David Candy (ZR 170). **CW** Marsh; Ian Boulton (ZR 160). **FL** Fraser-Burns 1m09.536s (84.92mph).
RACE 2 1 Fraser-Burns 20m32.452s (81.46mph); 2 Marsh +3.948s; 3 Sowery; 4 Christopher Boulton (ZR 170); 5 Candy; 6 Penfold. **CW 1** Boulton. **FL** Buckley 1m09.100s (85.46mph).
MMM CARS WITH MG T-TYPES (10 LAPS) 1 John Bussey (TC) 13m08.220s (74.92mph); 2 Stuart Dean (Dick Jacobs Special) +4.451s; 3 Jonathan Harmer (TF Sports); 4 Nick Ashman (TC); 5 Tim Patchett (TA); 6 Charles Harmer (TF). **CW** Thijs de Groot (PA Special). **FL** Bussey 1m17.756s (75.95mph).

KIRKISTOWN
MARCH 29, 500MRCI



ROADSPORTS (BOTH 15 LAPS) 1 Jim Larkham (Radical PRO6) 17m08.591s (79.736mph); 2 John Benson (Crosle 37S) +0.829s; 3 Alan Davidson (GMS Honda); 4 David Mutch (GMS Honda); 5 John McCandless (Crosle 47S); 6 Graham Moore (Westfield Honda). **CW** Davidson. **FL** Benson 1m05.961s (82.519mph).
RACE 2 1 Larkham 16m34.588s (82.090mph); 2 Davidson +29.290s; 3 Mutch; 4 Moore; 5 Jimmy Dougan (Locost Honda); 6 Davis Buick (Reis Aero Honda). **CW** Davidson. **FL** Larkham 1m01.286s (88.813mph).

OULTON PARK
MARCH 29, BARC



NORTH-WEST SPORTS SALOONS CLASSES D-F (12 LAPS) 1 Paul Dobson (Mazda RX7) 22m29.424s (86.18mph); 2 Ilsa Cox (SEAT Leon Cupra) +0.385s; 3 Garry Wardle (Ginetta G50); 4 Steven Hibbert (Lotus Elise); 5 Oliver Thomas (Subaru Impreza WRX); 6 Tony Ellis (Mazda RX7). **CW** Hibbert; Mike Nash (Peugeot 106 Rallye). **FL** Cox 1m49.591s (88.43mph).
CLASSES A-C (13 LAPS) 1 Paul Rose (Saker) 23m08.947s (90.83mph); 2 Robert Spencer (Stuart Taylor Locosaki) +31.961s; 3 Alistair Chalmers (Caterham CSR); 4 Steve Harris (Saker); 5 Anthony Bennett (Caterham R300); 6 Cam Forbes (Westfield SeiW). **CW** Spencer; Chalmers. **FL** Spencer 1m45.103s (92.20mph).
2CV (ALL 8 LAPS) 1 Peter Sparrow 20m23.516s (63.36mph); 2 Neil Savage +1.615s; 3 George Russell; 4 Michael Fox; 5 Matthew Hollis; 6 Richard Lambert. **FL** Sparrow 2m30.349s (64.45mph). **RACE 2 1 Peter Rundle 20m10.244s (64.06mph);** 2 Simon Clarke +1.569s; 3 Matt Lambert; 4 Sammie Fritchley; 5 Hollis; 6 Tom Perry. **FL** Rundle 2m30.004s (64.60mph).
RACE 3 1 Rundle 20m31.581s (62.95mph); 2 M Lambert +2.418s; 3 Fox; 4 Kris Tovey; 5 Chris Yates; 6 Hollis. **FL** Rundle 2m31.277s (64.06mph).

Stefan di Resta raced at Oulton



BOURNE



Neaves edged the second BCV8 race at Donington

JONES



Alan Davidson won his class at Kirkistown

DEMPSTER

John Bussey won the MMM/MG T-Types race at Silverstone



WALKER

Teddington Studios, Broom Road, Teddington, Middlesex TW11 9BE, UK.
Tel: +44 (0) 20 8267 5804 Fax: +44 (0) 20 8267 5922
E-mail: mail@autosport.com Website: www.autosport.com

EDITOR
Charles Bradley ext.5889
charles.bradley@haymarket.com

GROUP F1 EDITOR
Jonathan Noble ext.5810
jonathan.noble@haymarket.com

F1 EDITOR
Edd Straw ext.5887
edd.straw@haymarket.com

FEATURES EDITOR
Kevin Turner ext.5432
kevin.turner@haymarket.com

NEWS EDITOR
Glenn Freeman ext.5309
glenn.freeman@haymarket.com

MANAGING EDITOR
Peter Hodges ext.5903
peter.hodges@haymarket.com

RALLIES EDITOR
David Evans
david.evans@haymarket.com

ART EDITOR
Lynsey Row ext.5914
lynsey.row@haymarket.com

PHOTOGRAPHS
LAT Photographic

CHIEF SUB-EDITOR
Marcus Simmons ext.5807
marcus.simmons@haymarket.com

PRESENTER/SUB-EDITOR
Henry Hope-Frost ext.5835
henry.hope-frost@haymarket.com

NATIONAL EDITOR
Ben Anderson ext.5425
ben.anderson@haymarket.com

EDITORIAL ASSISTANT
Scott Mitchell ext.5370
scott.mitchell@haymarket.com

SENIOR DESIGNER
Michael Cavalli

PICTURE EDITOR
Peter Mills ext.5918
peter.mills@haymarket.com

AUTOSPORT.COM TECHNICAL TEAM LEADER
Geoff Creighton
geoff.creighton@haymarket.com

AUTOSPORT.COM DEVELOPER
Tomasz Trznadel
tomasz.trznadel@haymarket.com

OFFICE MANAGER
Joanne Grove
joanne.grove@haymarket.com
ext.5804

SPECIAL CONTRIBUTORS

Gary Watkins	Dieter Rencken	Alan Eldridge
Marcus Pye	Gary Anderson	Pablo Elizalde
Mark Glendenning	Giorgio Piola	Matt Beer

CORRESPONDENTS

ARGENTINA Tony Watson	ITALY Roberto Chinchero	Martin, David Phillips, Diego Mejia, Robin Miller, Jeremy Shaw
AUSTRALIA Phil Branagan	JAPAN Jiro Takahashi, Len Clarke	UK & EIRE Jonathan Crawford, Dan Cross, Kerry Dunlop, Leanne Fahy, Paul Healy, Paul Jurd, Linda Keen, Mark Libbeter, Stephen Lickorish, Marc Orme, Graham Read, Hal Ridge,
AUSTRIA Gerhard Kuntzschik	NEW ZEALAND Bernard Carpinter	Peter Scheres, Ian Sowman, James Stacey, Oliver Timson, Ian Titchmarsh, Matt Upton, Eddie Walder, Richard Young
BELGIUM Gordon McKay	RUSSIA Gregory Golyshv	
BRAZIL Lito Cavalcanti	SOUTH AFRICA Richard Asher	
FINLAND Esa Iloninen	SPAIN Raimon Duran	
GERMANY Rene de Boer	SWEDEN Tegge Tornvall	
GREECE Dimitris Papadopoulos	USA Jonathan Ingram, Bruce	

ADVERTISING
Tel: +44 (0) 20 8267 5820
Fax: +44 (0) 20 8267 5850
E-mail: autosport.ads@haymarket.com

DISPLAY SALES MANAGER
Martin Lee,
ext: 5389
martin.lee@haymarket.com

DISPLAY ADVERTISING
Gary-Lee Hoebeek,
ext: 5276
garylee.hoebeek@haymarket.com

LUKE RICKETTS,
ext: 5961
luke.ricketts@haymarket.com

DON RUPAL,
ext: 5244
don.rupal@haymarket.com

CLASSIFIED SALES MANAGER
Jonathan Whitehead,
ext: 5908
jonathan.whitehead@haymarket.com

SUBSCRIPTIONS
UK 0844 848887
OVERSEAS +44 (0)1795 592 974
EMAIL
autosport@servicehelpline.co.uk
AUTOSPORT, ISSN number 0269946X,
is published weekly by Haymarket Media Group, Teddington Studios, Broom Road, Teddington TW11 9BE, United Kingdom. The US annual subscription price is \$235. Airfreight and mailing in the USA by agent named Air Business Ltd, c/o Worldnet Shipping Inc., 156-15, 146th Avenue, 2nd Floor, Jamaica, NY 11434, USA. Periodicals postage paid at Jamaica NY 11431. Subscription records are maintained at Haymarket Media Group, Teddington Studios, Broom Road, Teddington TW11 9BE. Air Business Ltd is acting as our mailing agent.

BACK ISSUES
Tel: 0844 848887

MARKETING MANAGER
Karen McCarthy, ext: 5658
karen.mccarthy@haymarket.com

LICENSING AND SYNDICATION LICENSING MANAGER
David Ryan, ext: 5024

DIGITAL SPECIAL PROJECT MANAGER
Simon Strang, ext: 5093
simon.strang@haymarket.com

DIGITAL PRODUCT MANAGER
Simon Grayson, ext: 5346
simon.grayson@haymarket.com

CIRCULATION/TRADE ENQUIRIES
Frontline Ltd, Park House, 117 Park Road, Peterborough, Cambs, PE21 2TS. Tel: +44 (0) 1733 555161. Printed in England by Wyndeham Heron Ltd. Cover and centre sections printed by CSM Impact, Basingstoke. Colour origination: FIMG, 90-92 Pentonville Road, London N1 9HS. ISSN 0269-946X. AUTOSPORT, incorporating Autoclassic, is published weekly by Haymarket Consumer Media, Teddington Studios, Broom Road, Teddington, TW11 9BE, UK.

EDITORIAL DIRECTOR
Mark Payton

CREATIVE DIRECTOR
Paul Harpin

STRATEGY AND PLANNING DIRECTOR
Bob McDowell

PUBLISHING DIRECTOR
Patrick Fuller

MANAGING DIRECTOR
David Prasher

CHIEF EXECUTIVE
Kevin Costello

Haymarket is certified by BSI to environmental standard ISO14001

THIS WEEK

LETTERS • BEST PICS • LATEST GEAR • ON TRACK & SCREEN • ONLINE

What you think of the motorsport news of the past week



It's not Ricciardo's fault his team messed up his pitstop in Malaysia

Punish the team, not the driver

Once again poor Daniel Ricciardo is receiving more punishment, as a result of other people's actions. If a driver is unsafely released, which is totally out of his control, then just punish the team.

There are two championships, and different penalties should apply in each. The FIA shouldn't give the driver a 10-place

grid penalty at the next race. Deduct, say, 10 points from the team's constructors' championship points tally instead.

Ricciardo was already punished in Malaysia by a loose-fitting wheelnut, and in Australia by the team choosing to ignore FIA instructions.

Clive Eaton, by email

I find it strange that such an experienced driver like Felipe Massa acts so stupidly right in the beginning of the season when after such a long time things look very promising for both the Williams team and its drivers.

Massa didn't declare war against Valtteri Bottas, but against his employer and boss by refusing to do his job the way the company wants. He also showed what kind of team player he is, no matter what he said before the season.

**Ari Jakobson
Espoo, Finland**

I really wish that F1 'fans' would stop moaning about the noise, or rather lack of noise, from the current F1 engines.

Have they forgotten the '80s turbo era? They weren't particularly loud. Sure, the old V8s of recent years were louder, but they sounded as rough as a bag of nails, especially on over-run.

When I'm watching diesel hybrid LMP cars pounding round Le Mans,

where you can hear the tyre roar over the engine, the last thing I'm wishing for is increased volume. They can't all be driving around in Corvettes.

If you want noise, get down to Santa Pod where the Earth shakes beneath your feet and your eyeballs get vibrated out of your skull.

Here's to an excellent 2014 F1 season!
**Rob King
By email**

As a humble FF1600 competitor it's the time of year when I'm about to fork out my hard-earned on a fix of my favourite drug.

I opened AUTOSPORT last Thursday and I could not believe what I was reading. 'CCTV to police track limits' at Brands (p83). I take it the bill will be paid for with this year's annual increase in entry fees... (Like petrol and gas, they never go down.)

I understand the argument on track limits, honestly I do, but is it really necessary to put such a

draconian system in place?

If you want to keep competitors on the black stuff, why not go the whole hog and put a speed camera at the bottom of Paddock Hill Bend? Mr Palmer can put the revenue generated in fines towards a new helicopter.

As for me, racing at Brands suddenly doesn't seem so appealing. I wonder how many others feel the same.
**James Gowens
By email**

What a weekend for motor

racing fans. The nearly day-long ITV4 coverage of the first round of the 2014 BTCC season from Brands Hatch was tremendous. Perhaps Bernie and the FIA need to watch real multi-car racing...

On the subject of F1, I don't know why people are moaning about noise. That's how a turbocharged car should sound – it's the future, not the past.
**Patrick Wickham
Buckingham**

In pictures

Images taken around the globe, from Goodwood to Greece, via Tasmania

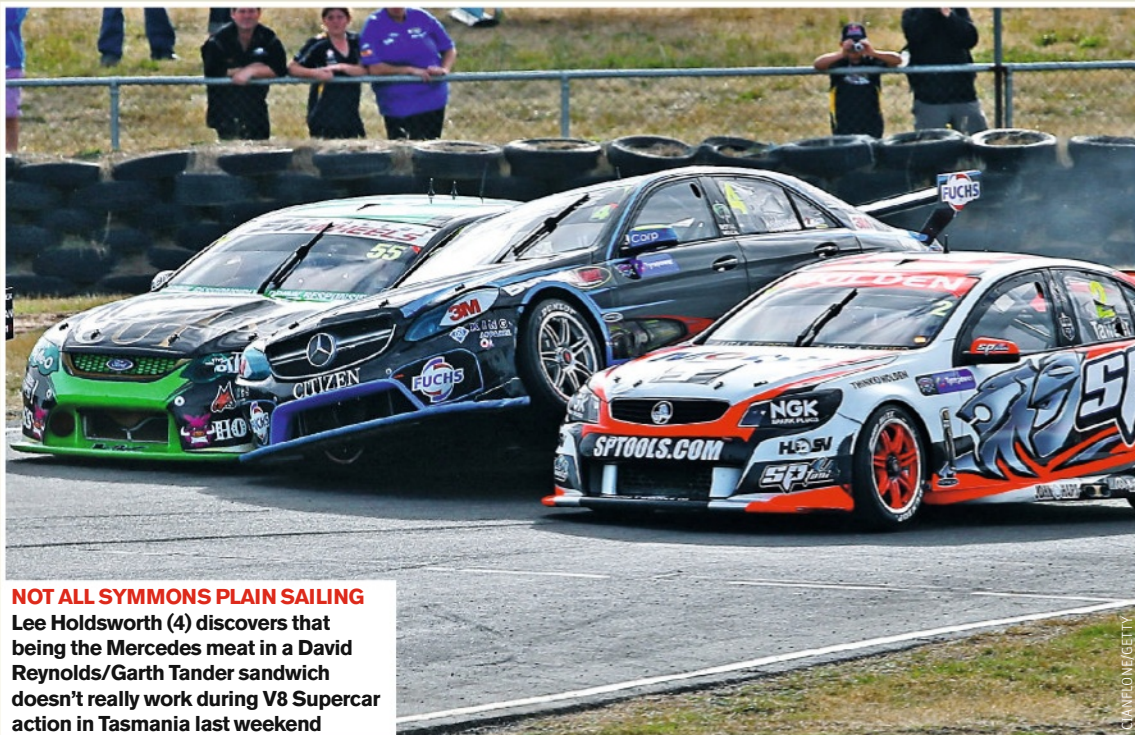

NOT ALL SYMMONS PLAIN SAILING

Lee Holdsworth (4) discovers that being the Mercedes meat in a David Reynolds/Garth Tander sandwich doesn't really work during V8 Supercar action in Tasmania last weekend



IT'S B FOR BONKERS

Mega mid-80s Group B rally monsters – Metro 6R4, Lancia Delta S4 and Audi Sport Quattro – line up for their sprint during last weekend's Goodwood's 72nd Members' Meeting, but Ian Gwynne's Ford RS200 was the winner

SPOTLIGHT ON KING CARLOS
New Peugeot signing Carlos Sainz poses during the announcement last week of the firm's return to Dakar – watched over by the 1987-winning 205 T16



PIG'S EAR OF IT
Skoda Fabia crew Henk Lategan and Klaus Wicha may well have stopped for some roast pork just out of shot – they were 13 minutes behind the winner on the Acropolis Rally...



In the shops

Desirable new releases

BBC F1 2014 SEASON GUIDE

£14.99 – autosport.com/shop
We may be a couple of races into the 2014 F1 season, but it doesn't guarantee you know exactly what's going on yet, especially when it comes to the new technical tweaks. Obviously you'll have consumed our own excellent pre-season guide, but other season preview publications are available, as they say, and this is the BBC's premium-priced effort.



MOTOGP 2013 REVIEW DVD

£16.99 – dukevideo.co.uk
Bike-racing lovers can settle down to almost four hours of action with the official MotoGP 2013 season review DVD. The season produced the sport's youngest champion, rookie Marc Marquez, and the superbly edited film retraces his battles with established stars Jorge Lorenzo, Dani Pedrosa and Valentino Rossi.

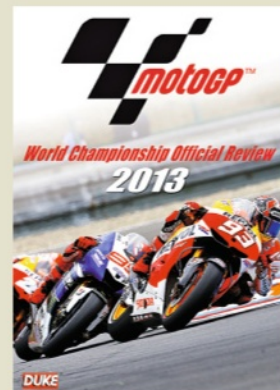

ROVER '84 BTCC WINNER 1:43

£67.99 – autosport.com/shop
The recent pro-am, two-driver retro tin-top race at last weekend's 72nd Members' Meeting at Goodwood drew our attention to Neo's new resin replica of the ICS-sponsored Rover Vitesse driven to British Saloon Car title glory in 1984 by multiple champion Andy Rouse.



WHAT'S ON

ON TRACK IN THE UK

SILVERSTONE

AMOC

April 5

www.silverstone.co.uk

The Aston Martin Owners Club and Historic Racing Drivers Club combine to provide a quintet of classic categories for you to enjoy on Silverstone's National circuit, including the HRDC Touring Greats and AMOC 50s Sports Cars series.

ROCKINGHAM

BARC

April 5-6

www.rockingham.co.uk

The Formula Renault BARC season opener tops the bill at Rockingham, with McLaren Formula 1 junior and Racing Steps Foundation ace Ben Barnicoat making a one-off appearance. Renault's club-level Clio Cup Series and Track Attack Race Club's litany of low-cost, high-intensity series are also part of the package.

SILVERSTONE

BRSCC

April 5-6

www.silverstone.co.uk

One of the country's most popular club championships will take centre-stage on the International circuit, as the

Barnicoat warms up for European season at Rockingham



EBREY

BRSCC lets loose what is always a bountiful grid of Mazda MX5s. Joining the entertaining mini-sportscars are races for Formula Jedi, Toyo Tyres Porsche, Ford Fiestas and Mighty Minis.

SILVERSTONE

BRSCC

April 6

www.silverstone.co.uk

Taking over from the AMOC and HRDC runners on the National circuit on Sunday are the Ford Fiesta Junior, Alfa Romeo and Arrowpak Saloon and Sports racers. These aren't spotlight-

grabbers, but regularly provide close and intense racing.

SNETTERTON

MSVR

April 5-6

www.snetterton.co.uk

The F3 Cup roars back into life this weekend at Snetterton and a quintet of MSVR's series will support it on the 300 circuit. Monoposto adds an eclectic single-seater flavour, while the Lotus Elise Trophy and Lotus Cup UK will kick off their respective seasons too. MSV Trackday and Team Trophy competitors will also be present.

DONINGTON PARK

HSCC

April 6

www.donington-park.co.uk

The Historic Sports Car Club's season opener looks set to be a belter, with 250 cars predicted across its eight categories. Historic Formula Junior, Formula Ford and FF2000 races head the single-seater bill, with more open-wheeled action courtesy of the Classic Racing Car Championship. Historic and 70s Road Sports, Historic Touring Car Championship and the oversubscribed Guards Trophy complete the entry list.

KNOCKHILL

SMRC

April 6

www.knockhill.com

Racing gets back under way in Scotland this weekend, with competitors in the country's finest six championships ready to do battle for another season. The hotly-contested Scottish Mini Cooper Cup and Formula Ford 1600 championships are the big draws, along with the feisty Legends races, while Fiestas, plus Classic and contemporary Sports and Saloons complete the programme.

ON TRACK AROUND THE WORLD

BAHRAIN GRAND PRIX

Formula 1 World

Championship

Rd 3/19

Sakhir, Bahrain

April 6

formula1.com

The glitz of F1 in Bahrain...



COATES/LAT

GP2 SERIES

Rd 1/11

Sakhir, Bahrain

April 5-6

gp2series.com

RALLY PORTUGAL

World Rally Championship

Rd 4/13

Lisbon/Algarve, Portugal

April 3-6

wrc.com

NASCAR SPRINT CUP

Rd 7/36

Texas Motor Speedway,

USA

April 6

nascar.com



CIANFLONE/GETTY

...and no-frills Winton for the V8 Supercars

SUPER GT

Rd 1/8

Okayama, Japan

April 6

supergt.net

V8 SUPERCARS

Rd 3/14

Winton, Victoria, Australia

April 5-6

v8supercar.com.au

EUROV8 SERIES

Rd 1/6

Monza, Italy

April 6

Your guide to the best events taking place in the UK and around the world – plus TV and online

ON TELEVISION

THURSDAY APRIL 3

1300-1345 Sky Sports F1 LIVE
Bahrain GP: Drivers' Press Conference
1800-1900 BT Sport 1 LIVE
Rally Portugal

FRIDAY APRIL 4

1000-1050 Sky Sports F1 LIVE
GP2 Bahrain: Free Practice
1145-1345 Sky Sports F1 LIVE
Bahrain GP: Free Practice 1
1545-1745 Sky Sports F1 LIVE
Bahrain GP: Free Practice 2
1755-1835 Sky Sports F1 LIVE
GP2 Bahrain: Qualifying
2300-2330 BT Sport 1
Rally Portugal: Day 1 highlights
0030-0115 Sky Sports F1
Bahrain GP: Drivers' Press Conference

SATURDAY APRIL 5

0500-0600 BT Sport 2 LIVE
V8 Supercars: Winton Race 1
0720-0830 BT Sport 2 LIVE
V8 Supercars: Winton Race 2
0810-0900 Motors TV
Tuthill Porsche Safari Rally
0900-0935, 1210-1240 Motors TV
Rally Portugal: Day 1 highlights
0930-1030; 2200-2300 Eurosport 2
British Rallycross: Lydden
1105-1220 Sky Sports F1 LIVE
GP2 Bahrain: Feature Race
1245-1415 Sky Sports F1 LIVE
Bahrain GP: Free Practice 3
1500-1745 Sky Sports F1 LIVE
Bahrain GP: Qualifying
2100-2215 BBC2
Bahrain GP: Qualifying highlights
2200-2230 BT Sport 1
Rally Portugal: Day 2 highlights

2300-0145 Sky Sports F1
Bahrain GP: Qualifying Replay
2345-0000 Eurosport
Abu Dhabi Desert Challenge

SUNDAY APRIL 6

0615-0820 ESPN LIVE
V8 Supercars: Winton Race 3
0810-0835, 1210-1240 Motors TV
Rally Portugal: Day 2 highlights
0955-1210 Motors TV
V8 Supercars: Winton, races 1&2
1100-1200 BT Sport 1 LIVE
Rally Portugal: Powerstage
1210-1310 Sky Sports F1 LIVE
GP2 Bahrain: Sprint Race
1500-1830 Sky Sports F1 LIVE
Bahrain Grand Prix
1930-0030 Premier Sports LIVE
NASCAR Sprint Cup: Texas
2000-2100; 2215-2315 Sky Sports F1
Bahrain Grand Prix: Highlights
2100-2215 Sky Sports F1
F1 Classics: Japanese GP 1994
2200-2330 BBC2
Bahrain GP: Race highlights
2230-2300 BT Sport 1
Rally Portugal: Day 3 highlights
2235-2305; Motors TV
Rally Portugal: Day 3 highlights

MONDAY APRIL 7

0930-1030, 2230-2330 ESPN
NASCAR Sprint Cup: Texas highlights
2100-2145 Sky Sports F1
F1 Classics: Las Vegas GP 1982

TUESDAY APRIL 8

2200-2230 Eurosport
World Touring Cars: Season preview

ONLINE

HOT ON THE WEB THIS WEEK

YouTube ONBOARD WITH SIMON PAGENAUD AT ST PETERSBURG



SEARCH FOR: RACER Simon Pagenaud IndyCar St Pete Visor Cam 2014 (5:25)
Frenchman Simon Pagenaud heads out onto the St Petersburg street track during practice in his Schmidt Peterson Hamilton Motorsports Dallara-Honda and we get a unique perspective from his visor cam. This is the future of onboard viewing, surely?

AUTOSPORT+
Exclusive content coming up in our premium website this week

The F1 circus heads straight from Malaysia to Bahrain and our team will be there to bring you the latest news and opinion. Gary Anderson will once again be on hand with his form guide based on the early running. Plus, we look at the young single-seater stars set to battle it out during 2014.

GET AUTOSPORT ON THE MOVE

- IN THE IPAD ISSUE THIS WEEK
 - HIGHLIGHTS FROM THE SUCCESSFUL 72ND GOODWOOD MEMBERS' EVENT
 - ON SALE ALL OVER THE WORLD FOR ONLY £2.99
- Download it now from autosport.com



Revved up over what's on the box

"Fuel if you think it's over" crooned husky Geordie Chris Rea in 1978 in a far-sighted requiem for Daniel Ricciardo's breach of FIA fuel-flow regulations at the recent Australian Grand Prix. A massive race fan, expect Rea to follow up this hit with "So much for my left-front wheel" and

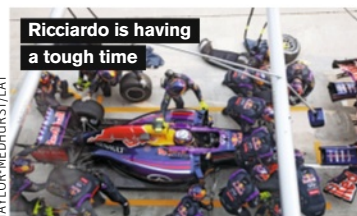

"Front wing's all gone" – a kind of Ricciardo *Road To Hell* trilogy.

One thing Chris, and the rest of us, can now follow is real-time fuel-usage data during grands prix. This was sadly lacking from the Melbourne coverage, but in Malaysia we were treated to over six minutes (yes, I counted them) of fuel percentage graphics, as David Coulthard rightly pointed out: "It's key information that shows who's being most efficient."

It's great to have some transparency in such a secretive sport, and seeing Vettel with only 4.44 per cent of his 100 kilos left with two laps remaining probably explains him admitting defeat in his pursuit of Nico

Rosberg. We also learned Felipe Massa had 1.3 per cent of fuel in hand over pesky Williams team-mate Valtteri Bottas in the closing stages, which perhaps played a part in him not acquiescing to team orders.

That's the fuel usage sorted, now what we really need to see is some on-screen graphics that explain the whole operation of these complex power units. When are they harvesting the energy? When are they releasing? In the heat of battle, who is being canny and saving the most energy to release it in a full-on attack? This would have added a new dimension to the whole Jenson Button-Massa-Bottas battle.

As usual it's our Australian cousins who

have this nailed. During Sunday's long-distance V8 Supercars race at Symmons Plains (a multiple pitstop race with refuelling) pit reporter Mark Larkham danced his way between the garages, telling viewers who had used the most fuel by literally pointing at the levels remaining in their rigs. The crews didn't bat an eyelid as 'Larko' told the world (and their rivals) their fuel strategies and thus accurately predicted the length of each frontrunner's final fuel stops.

FOM TV graphics minions, I refer you again to the wisdom of Chris Rea: "Come so far, yet still so far to go".

Revved Up

Karl Jones

“I was starting to feel nauseous – it must have been that BRDC lunch”

■ RAC Tourist Trophy, Silverstone ■ September 4, 1988 ■ Ford Sierra RS500 ■ Star turn in top event



Jones ran as high as sixth before the clutch gave out

I HAD LOTS OF GREAT RACES in the cut and thrust of Formula Ford and then in Production Saloons and the British Touring Car Championship, but the one that I'd have to go for is the RAC Tourist Trophy at Silverstone in 1988, the famous race that was a round of the European Touring Car Championship in those days.

I don't know why we decided to compete in this event, as Silverstone was the least competitive circuit for our car. Hey, we were young guns thinking we could take on the world!

I'd come close to sharing the Wolf Racing Sierra RS500 with Armin Hahne – a deal that my friend Steve Soper helped to broker – but in the end Harald Grohs drove with Armin and they finished fifth. Oh well!

I ended up with Fluxie [Ian Flux] in my regular Richard Asquith Autosport Sierra. We had continued Duckhams support, thanks to the legend Ron Carnell, and Richard got some help from Peter Ashcroft, as he'd worked at Ford on the past. But

it was still a limited-budget effort, although Richard was a technical genius, a really underrated bloke.

We had a turbo-boost problem in practice so had to start quite a long way back for the 105-lap race. Beforehand, Fluxie took me for lunch in the BRDC clubhouse. I didn't normally eat before a race and it came back to haunt me later on.

Richard solved the boost problem

on the grid so I was raring to go for my first-ever rolling start. I remember looking across at Winni Vogt in the Bigazzi M3. He gave me a thumbs-up which I thought was cool. I made my way through the pack, getting past all the M3s but was struggling with the heat – the turbo in the Sierra was right in front of the bulkhead and the exhaust ran under the seat, so I was sweating buckets!

After 30-odd laps I was feeling nauseous, had a splitting headache and was losing concentration. It must have been that BRDC lunch! I radioed in to tell the team to get Fluxie ready. I came in a few laps later, with the inevitable piss-taking from my team-mate.

I went to have a lie down and fell asleep, only to be woken up soon after – Fluxie was coming in. Now it was my turn to piss myself. I barely recognised the poor fellow, all red-faced and haggard.

I felt much better in my second stint, passing cars and really enjoying it, only for the clutch to explode at 140mph coming through Abbey when we were running sixth.

It was such a shame, but a massive achievement to be running as high as that, especially after starting near the back. We were racing among the world's best touring car drivers with our small operation and a race crew of just five people. A great day! ❧ Karl Jones was talking to Henry Hope-Frost

PROFILE



WELSHMAN KARL JONES

won the Champion of Brands FFord title in 1983. A move to Production saloons landed the Monroe title in '86 and Uniroyal crown in '87 before he settled in the BTCC in a Sierra RS500. He 'retired' in the mid-90s but has recently made a return in historics, something he's keen to continue ["hint, hint!"] alongside his professional job with McLaren's Pure driving experience programme.

NEXT WEEK BAHRAIN GP REPORT
Plus: Portugal WRC & exclusive ERA track test

World Endurance *in Style*

19th+20th April | 3rd+4th May 2014



UK



France



Sweden



Germany



Holland



Spain



Malaysia



Russia



Saudi Arabia



United Arab Emirates



Global Specialists in
Bespoke Vehicle Distribution



Winnebago Tour

For Sale at £249,000+VAT

WINNEBAGO

20% Discount on RV Hire.
Quote these references:

- WEC Silverstone 19th+20th April
WECSi14
- WEC Spa 3rd+4th May
WECSpa14



To book an American Motorhome for these events or for more information, please contact Chris Bee at Stingray RV on **+44 (0) 870 241 5614** or **chris@stingrayRV.com**

www.stingrayRV.com



WorldMags.net



BY APPOINTMENT TO
HER MAJESTY THE QUEEN
SUPPLIER OF CAR CARE PRODUCTS
AUTOGLYM, LETCHWORTH, ENGLAND



BY APPOINTMENT TO
H.R.H. THE PRINCE OF WALES
SUPPLIER OF CAR CARE PRODUCTS
AUTOGLYM, LETCHWORTH, ENGLAND



OFTEN IMITATED, NEVER RIVALLED.

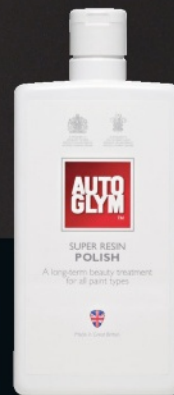

It's not until you've experienced an inferior product that you realise only the original will do. If you take car care seriously, like we do, you'll appreciate how important authenticity and quality is. After all, there will only ever be one king.

Find out more about why the finest marques insist on Autoglym Super Resin Polish, visit autoglym.com

Join the conversation: [#superresinpolish](https://twitter.com/superresinpolish)



Made in Great Britain

PASSION for PERFECTION



WorldMags.net