

# Workshop Manuel

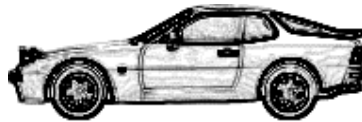

944

Volume IA - Engine, 16 valves

**DR. ING. h. c. F. PORSCHE Aktiengesellschaft**

As webpage by <http://www.9ss1.dk/porsche944>

	<b>Page</b>
<b>General</b>	
Technical data	0.9
<b>Maintenance, Self-diagnosis</b>	
Fault diagnosis, DEE control unit	03 - 1
Connecting into the vehicle - 944S	03 - 3
Starting fault diagnosis	03 - 5
Functional test - actuator and input signal	03 - 7
List of test codes	03 - 13
System adaptation	03 - 15
Knock detection	03 - 17
Troubleshooting	03 - 19
List of fault codes	03 - 29
Clearing fault memory	03 - 31
Operating conditions for start of diagnosis	03 - 32
Operating instructions for System Tester 9288	03 - 33
<b>Engine, Crankcase</b>	
Tightening torques for engine (16-valve)	10 - 0101
Tolerances and wear limits	10 - 0102
Engine, removing and installing	10 - 101
<b>Engine, Crankshaft drive, Pistons</b>	
Notes on assembly for pistons, from Model 87 onward	13 - 101
Checking pistons and cylinder bore	13 - 102
Pistons from Model 89 onward	13 - 103
Installing cover for oil-centrifuge partition	13 - 105
<b>Engine, Cylinder head, Valve drive</b>	
Camshaft salling, checking and adjusting	15 - 101
Camshaft salling, checking and adjusting for Model 89 onward	15 - 104 a
Applying the TOC mark on the camshaft sprocket	15 - 104 b
Camshafts and cylinder head, removing and installing	15 - 105
Cylinder head, installing and tightening	15 - 110
Camshafts, installing	15 - 111
Camshaft seal, installing	15 - 112 a
Camshaft specifications	15 - 112 b
Chain tensioner, removing and installing	15 - 113
Cylinder head, disassembling and assembling	15 - 115
Valve springs, removing and installing with Sauer tool	15 - 118

	<b>Page</b>
Machining mating face, cylinder head	15 - 120
Valve springs, removing and installing, removing valve stem seal	15 - 121
Valve stem seal, installing	15 - 122
Checking valve guides	15 - 123
Replacing valve guides	15 - 125
Checking valve seat wear limit	15 - 130
Valve seats, checking and machining	15 - 131
Checking and adjusting installation length of valve springs	15 - 133
 <b>Engine - Lubrication</b>	
Replacing engine oil and oil filter	17 - 101
Pressure-reducing valve, removing and installing	17 - 102
 <b>Engine - Coating</b>	
Checking cooling and heating system for leaks	19 - 101
 <b>Fuel supply</b>	
Replacing fuel filter, checking injection lines for leaks and tightness	20 - 101
Checking delivery rate of fuel pump	20 - 102
Line routing, fuelsystem, M 44.40	20 - 103
 <b>Fuel preparation - L-Jetronic/regulation</b>	
Replacing air filter cartridge, checking intake-air guide hoses	24 - 101
Testing and adjusting specifications	24 - 102
Checking fuel pressure	24 - 103
Checking idle speed and CO - with catalytic convertor	24 - 105
Checking idle speed and CO - without catalytic convertor	24 - 106
Replacing air filter cartridge for Model 89 onward	24 - 107
 <b>Exhaust system</b>	
Exhaust system - check tightness of flanges	26 - 101
 <b>Ignition system</b>	
Equipment table	28 - 101
DEE control unit coding - 944 S, Model 87 onward	28 - 103
Replacing spark plugs	28 - 104
Equipment table, Model 89 onward	28 - 105
DEE control unit coding - 944 S 2, Model 89 onward	28 - 107
DME-Diagnosing / Troubleshooting	D-24/28-1

## TYPE 944 S (16-VALVE ENGINES) - '87 MODELS ONWARD

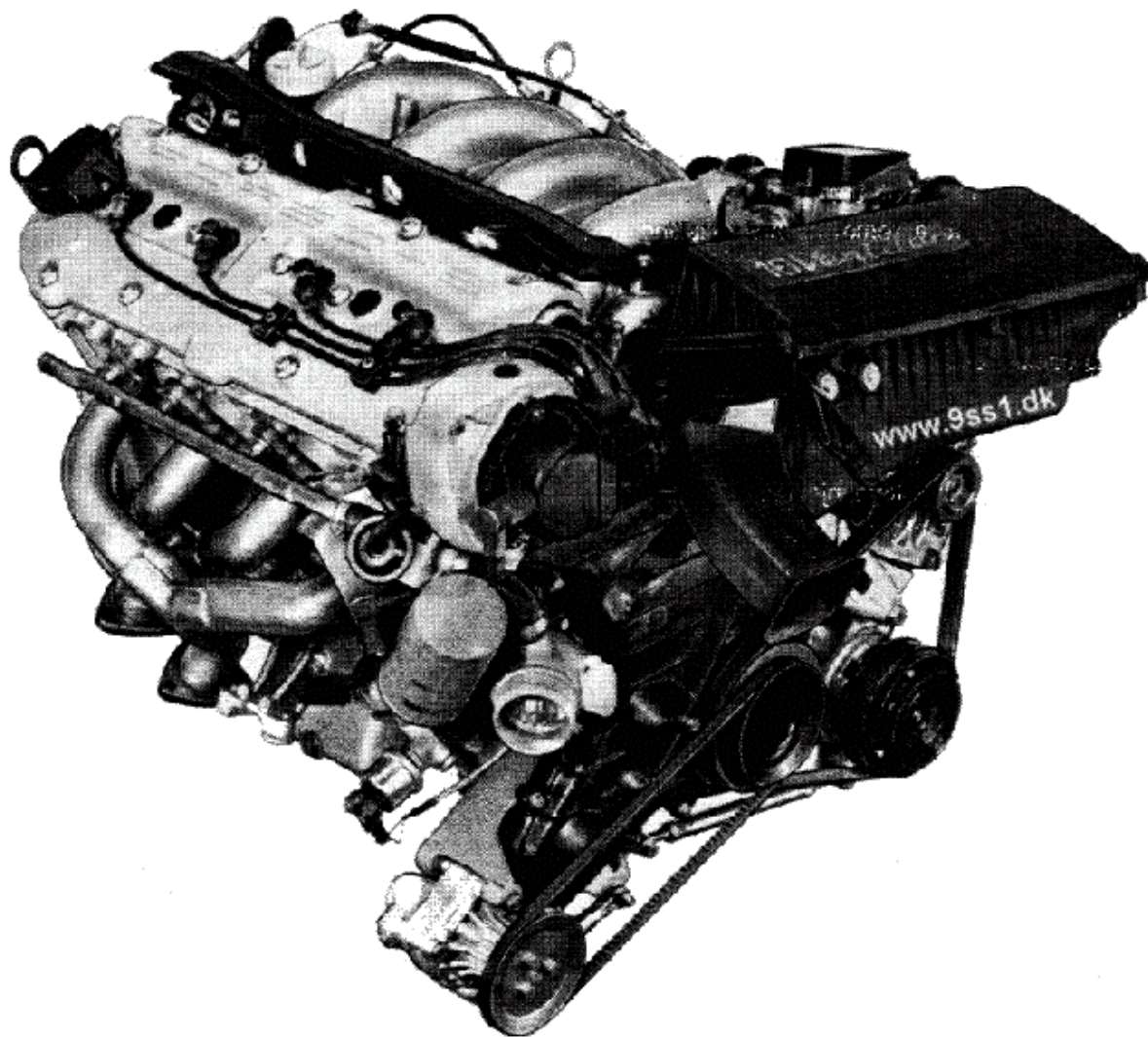

## TECHNICAL DATA

(Adjustment specifications and wear data are stated in the appropriate Repair Groups)

Note: US values are stated in parentheses

## DRIVE UNIT

Internal engine designation		M 44/40
Number of cylinders		4
Bore	mm/in.	100/3.94
Stroke	mm/in.	78.9/3.11
Displacement (actual)	cc/in. <sup>3</sup>	2479/151
Compression ratio		10.9 : 1
Max. engine output to 80/1269/EC	kW/PS	140/190 - 135/184 Australia
Net power, SAE J 1349	kW/HP	140/188
at engine speed	rpm	6000
Max. torque to 80/1269/EC	Nm/kpm	230/23.5 - 225/22.9 Australia
at engine speed	rpm	4300
Net torque, SAE J 1349	Nm/lbft	230/170
Max. spec. power output	kW I/HP I	56.5/76.6-54.5/74.2 Australia
Net power, SAE J 1349	kW I/HPI	56.5/75.8
Fuel octane rating	RON/MON	95/85 - 92/82 unleaded Australia (95/85 premium unleaded)
Max. perm. engine speed	rpm	6840
Engine weight (dry)	kg/lbs	175/386

## ENGINE DESIGN

Type 4-cylinder, 4-stroke in-line spark ignition engine with two balance shafts

---

Crankcase	Two-part light alloy crankcase	
Crankshaft	Forged, 5 bearings	
Crankshaft bearings	Plain	
Connecting rods	Cast, opt. sinter-forged	
Connecting rod-bearings	Plain	
Pistons	Light alloy, cast	
Balance shafts	Forged	
Balance-shaft bearings	Plain bearings with bearing shells	
Cylinders	Light alloy	
Cylinder head	Light alloy	
Valve guide	Press-fit, special brass	
Valve arrangement	2 intake, 2 exhaust overhead V	
Valve timing	Two overhead camshafts, hydraulic bucket tappets	
Camshaft	Without bearing shells, carried in cylinder head	
Camshaft drive	Toothed belt and internal chain	
Balance-shaft drive	Toothed belt	
Valve clearance	Self-adjusting (hydraulic)	
Timing	Intake opens	4° after TDC
	Intake closes	40° after BDC
	Exhaust opens	36° before BDC
	Exhaust closes	4° before TDC

ENGINE COOLING		Sealed cooling system, electric fan with thermostat, antifreeze effective to - 25 °C
ENGINE LUBRICATION		
Lubrication		Forced-feed lubrication with sickle-type pump, oil filter and oil-water heat exchanger in main oil flow and secondary water flow integrated in crankcase
Oil pressure	n = 5000 rpm	Approx. 4 bar, at operating temperature
Oil-pressure indicator		Pilot lamp and pressure gage
Max. oil temperature		140 °C
Oil consumption	l/1000 km	Up to 1.5
EXHAUST SYSTEM		Standard 2 double-wall manifolds, branch pipe to primary muffler, 1st and 2nd secondary mufflers Option: M298 or M299 and USA and Australia as standard, catalytic converter instead of primary muffler
EMISSION CONTROL		Standard: engine-internal Option: M298 or M299 and Australia heated oxygen sensor with 3-way catalytic converter
HEATING		Hot-water heating with heat exchanger and blower

## FUEL SYSTEM

Injection		DME Digital Motor Electronics
Fuel delivery		1 electric fuel pump
Fuel octane rating	RON/MON	Standard: 95/85 - European standard premium unleaded possible Opt./M298: 95/85 unleaded - European standard premium - Australia: 91/82 unleaded
Fuel consumption to 80/1268/EC or ECE R 15/04		Standard:
Constant 90 km/h	l/100 km	6.7
Constant 120 km/h	l/100 km	8.3
EC exhaust urban cycle	l/100 km	12.5

## ELECTRICAL SYSTEM

Suppression		ECE-R 10 and 72/245/EC
Battery voltage	V	12
Battery capacity	Ah	50 - optional 63, sports package 36
Alternator (output)	A/W	115/1610 - sports package: 90/1260
Ignition		By DME
Firing sequence		1-3-4-2
Ignition timing		By DME



## BODY DESIGNS

Integral all-steel body with front air dam and rear spoiler  
 - as coupe, opt.: removable hardtop panel, also available with fog lamps set in PU front air dam as optional extra.

## DIMENSIONS (at DIN curb weight)

Length	mm/in.	4230/165.354	(4290/168.90)
Length with opt. extra US bumpers	mm/in.	4290/168.90	
Width	mm/in.	1735/68.31	
Height	mm/in.	1275/50.20	
Wheel base (in design pos.)	mm/in.	2400/94.49	
Track:			Rim size
Front	mm/in.	1477/58.2	7 J x 15
		1477/58.2	7 J x 16
		1477/58.2	8 J x 16
Rear	mm/in.	1451/57.1	7 J x 15
		1451/57.1	7 J x 16
		1451/57.1	8 J x 16
		1442	9 J x 16
Ground clearance (at per. total weight)	mm/in.	120/4.72	
Bed clearance (at per. total weight)	mm/in.	53/2.09	
Overhang angles:			
Front		14°	
Rear		15°	

WEIGHTS		- to DIN 700 20 -		
Curb weight		Standard	Sports package	Australia, standard
Front	kg/lbs	640/1411 (650/1433)	630/1389	640/1411
Rear	kg/lbs	640/1411 (650/1433)	610/1345 (630/1389)	640/1411
Total	kg/lbs	1280/2822	1240/2734 (1260/2778)	1280/2822
Per. axle load				
Front	kg/lbs	730/1609	730/1609 (720/1587)	730/1609
Rear	kg/lbs	900/1984	900/1984	920/2028
Per. total weight	kg/lbs	1600/3527	1600/3527 (1550/3417)	1620/3571
Per. trailer load				
Braked trailer	kg/lbs kg/lbs	1200/2646 1200	up to 16% gradient for Italy	
Unbraked trailer	kg/lbs kg/lbs	500/1102 500	up to 16% gradient for Italy	
Max. car/ trailer weight	kg/lbs kg/lbs	2760/6085 2760	for Italy	
Max. drawbar load	kg/lbs kg/lbs	50/110 50	for Italy up to 100 km/h	
Per. roof load	kg/lbs	35/77		
With genuine Porsche roof transport system	kg/lbs	75/165		

## CAPACITIES

Engine (measurement with dipstick as per Driver's Manual is definitive)	Proprietary HD oils to API classification SE or SF, see Driver's Manual
Engine oil	Approx. 6.0 l
Engine coolant	Approx. 8.5 l
Transmission with differential	Approx. 2.0 l hypoid oil, SAE 80 to MIL-L 2105, API classification GL 4
Fuel tank	Approx. 80 l, including approx. 8 l reserve
Brake-fluid reservoir	Approx. 0.2 l
Windshield and headlight washing fluid reservoir	Approx. 0.6 l

## PERFORMANCE

Maximum speed	km/h/mph	228/142
Acceleration from 0-100 km/h* (0-60 mph)* (1/4 mile from standing start)*	s	7,9
	s	(7.7)
	s	(15.4)
Kilometer from standing start*	s	27.8

## CLIMBING PERFORMANCE

In % (slip limit)	1st gear	62%
	2nd gear	35.6%
	3rd gear	21.5%
	4th gear	13.3%
	5th gear	9.4%

\*DIN curb weight and half of payload



## Technical data - Type 944 52 - Model 89

(Values for adjustment and wear are to be found in the respective repair groups)

**Notes: USA values are given in brackets**

### Drive unit

Internal engine designation		Manual transmission M 44.41 (3.0 l)
Bore	mm (in.)	104 (4.09)
Stroke	mm (in.)	88 (3.46)
Displacement (actual)	cm <sup>3</sup> (in. <sup>3</sup> )	2990 (182.5)
Displacement (rounded down)	cm <sup>3</sup>	2969
Compression ratio		10.9: 1
Max. engine power 88/195/EEC	kW (HP)	155 (211)
Net power, SAE J 1349 at engine speed	kW (HP) rpm	155 (208) 5800
Max. torque 88/195 / EEC (Net torque, SAE J 1349) at engine speed	Nm (kpm) Nm / lbft rpm	280 (28.5) 280 (207) 4100
Max. output per litre DIN 70020 (SAE J 1349)	KW/l (HP/l) KW/l (HP/l)	51.8 (70.6) 51.8 (69.6)
Speed governed by fuel cut-off	rpm	6480 +- 20
Engine weight (dry)	kg	175

## DME control unit error diagnosis

### DME control unit error diagnosis 944 S as from 88 model

As from model year 88, the DME control unit 944 S is capable of a self-diagnosis. That is to say, the control unit is capable of detecting, storing and displaying system errors. The control unit capable of diagnosis is identified by an altered part number. A specially developed diagnostic tester (special tool No. 9268) is then used to read out the error memory and to test specific components and control signals of the fuel and ignition system.

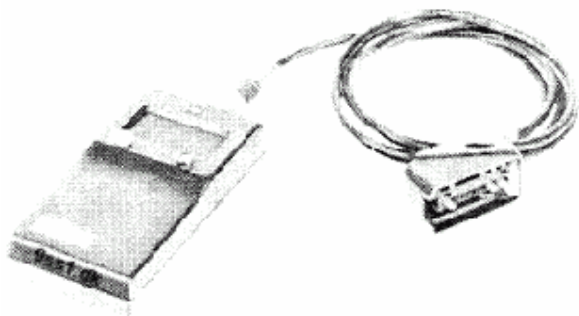

87/793

**Important: Before diagnosis, the battery or the connector of the DME control unit must not be disconnected as otherwise the error memory will be erased.**

Display

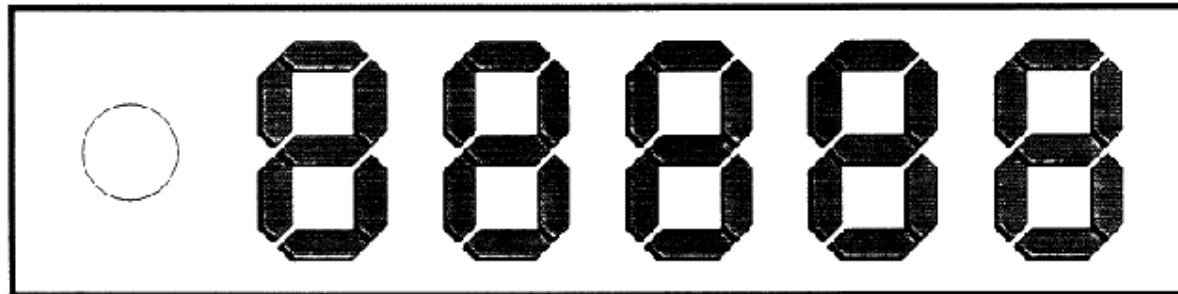

LED

Control unit  
identification

1 = LH / DME  
2 = EZK

Error code  
test code

Diagnosis mode

1 = Continous error  
2 = Occasionally occurring  
error  
3 = Actualor / unput signal  
testing  
4 = System adaption  
5 = No error

Function  
display



LED off

Test sequece terminated / igniti



Flashing LED

Error code / test code



LED on

Ignition on

## Connection in the 944 S

In the 944 S, the diagnosis socket is attached to a separate cable harness located above the DME control unit.

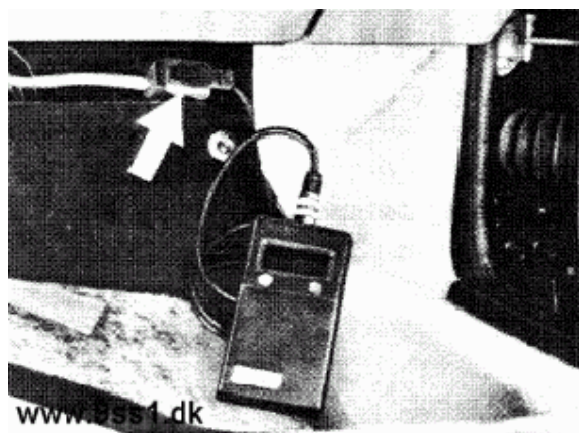

87/1012

## Diagnosis socket in the car

Pin 1 = terminal 15

Pin 2 = terminal 31

Pin 5 = terminal 30

Pin 9 = Hall generator

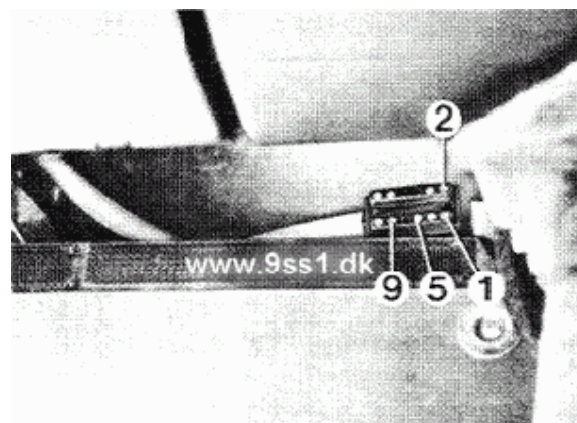

87/908

Ignition off

After connecting the tester, the following display must appear.

Display:

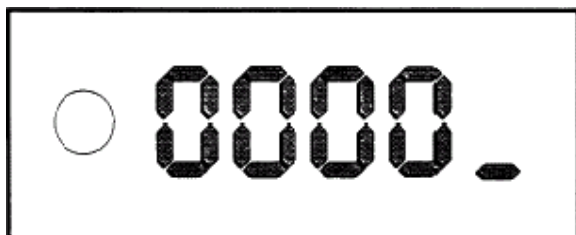

If this is not the case, check the tester terminals or check the power supply of the diagnosis socket in the car by referring to the circuit diagram.

**Tester cable**

Diagnosis plug		Round plug
Pin 1	→	Pin 4
Pin 2	→	Pin 1
Pin 3	→	Pin 7
Pin 4	→	Pin 6
Pin 5	→	Pin 2
Pin 6		unused
Pin 7		unused
Pin 8		unused
Pin 9		unused
Pin 10		unused
Pin 11	→	Pin 5
Pin 12	→	Pin 3

Switch on the ignition

Display:

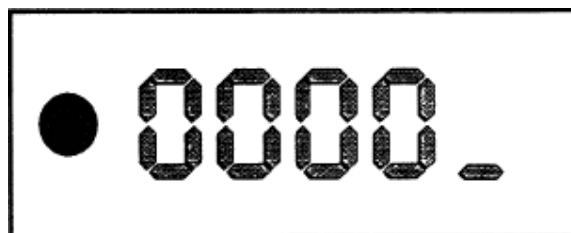

**The ignition must not be switched off during the entire error diagnosis procedure.**

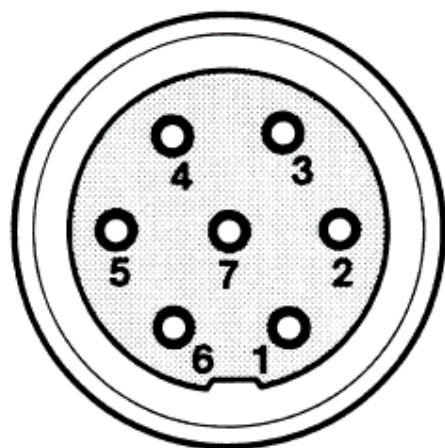



## Starting error diagnosis

### Condition:

Engine off  
Ignition on

Display:



Press the *green* key until the clear symbol appears on the function display.

Display:

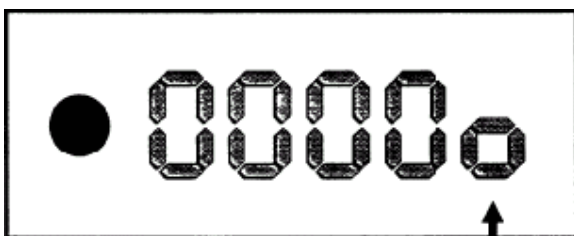

Clear symbol

The diagnosis sequence for the DME control unit then takes place.

If an error is displayed - take the note of the error (e.g. 1211).

Display:



The error is displayed until the *green* key is again pressed on the tester. The next error code is then displayed. if applicable.

This must be repeated until 1000 appears on the display.

If no error has occurred. the following display appears.

Display:



Press the *green* key until the clear symbol appears on the function display. The following display must then appear.

Display:

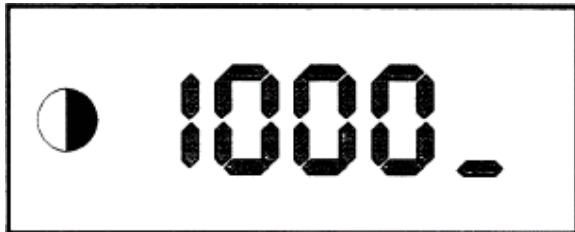

This now terminates diagnosis of the DME control unit.

If one or several errors (up to 5) has/have been displayed, the error memory must be reset; see chapter (Resetting the error memory).



### Actuator and input signal function checking

An actuator and input signal function check can be carried out independently of an error diagnosis. This function check tests individual components or electrical signals with respect to their functioning or signal paths. Functions are triggered from the diagnosis tester. During functional checking of components, these must *audibly* or *tangibly* operate and can thus be detected as being electrically in proper working order or defective.

An error display via the tester is not possible in this mode, but faulty input signals or their wiring connection are detected by the tester.

### Starting actuator and input signal function check

Ignition off

Press the *yellow* key until the function symbol (see display) appears on the function display.

Display:

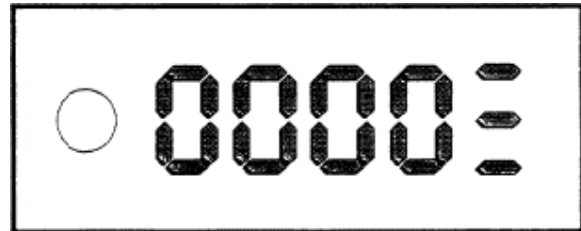

Press the *green* key until the clear symbol appears on the function display.

Display:

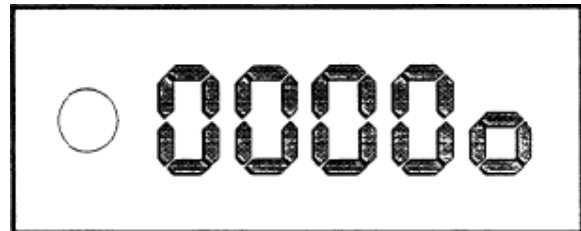

Switch on the ignition within 8 seconds.

Press the *green* key until the clear symbol appears on the function display. This activates the first testing step and the injection valves are activated.

Display:



The injection valves must all operate audibly or tangibly.

**Note:**

If later attempts are made to start the engine, starting difficulties may occur because a slight residual amount of fuel is injected during this testing step.

The testing steps remain in operation until the *green* key is again pressed on the tester and the clear symbol appears.

The next testing step is initiated by again pressing the *green* key.

Refer to the test code list for the sequence of testing steps.

As from the "idle contact" testing step, specific controls must additionally be operated on the car for the purpose of function checking.

Idle contact display:



Slightly press the accelerator. The LED must go off after approx. 20 mm and the display will appear. After approx. 3 s.

Display:

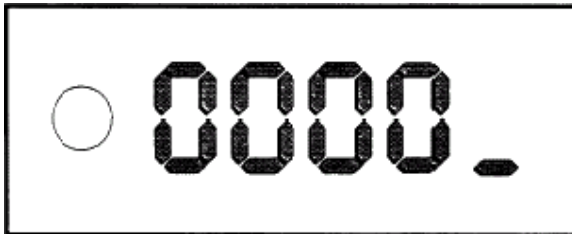

If this is not the case, an error has occurred in the area of the idle contact (see Idle contact troubleshooting).

If the display 0000 does not appear, it is possible to switch at all times to the next testing step. Press the *green* key until the clear symbol appears.

Initiate the full load contact testing step.

Display:



Slowly press the accelerator until the full throttle position is reached. The LED must go off and the display will appear after approx. 3 s.

Display:

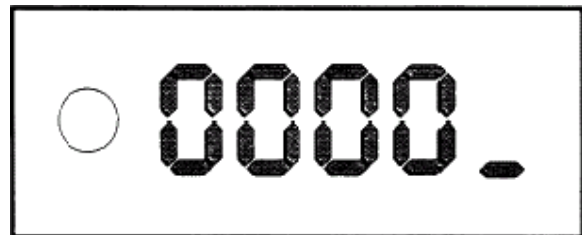

If this is not the case, an error has occurred in the area of the full load contact (see Full load contact troubleshooting).

Initiate the air-conditioning control terminal 41 testing step.

Display:



Switch on the air-conditioning system. The LED must go off and the display will appear after approx. 3 s.

Display:



If this is not the case, an error has occurred in the area of the air-conditioning system's wiring.

In the event of an error, check with reference to the circuit diagram. Do not switch off the air-conditioning system.

Initiate the air-conditioning control terminal 40 testing step.

Display:



Switch off the air conditioning system. The LED must go off and the display will appear after approx. 3 s.

Display:



If this is not the case, an error has occurred in the area of the air-conditioning system's wiring.

In the event of an error, check with reference to the circuit diagram.

Press the *green* key until the clear symbol appears.

Display:



End of the actuator and input signal function checks.







## Test code list

### Test code Components

1311	Injection valves
1321	Rotary idle controller
1322	Solenoid valve - tank bleeding
1332	Idle contact
1333	Full load contact
1334	Air-conditioning/AC switch
1335	Air-conditioning/compressor coupling





## System adaption

System adaption can be carried out with the tester. That is to say, the electronic idle control in the DME control unit is adapted to the actual air throughput and to the current condition of the engine.

### Note:

For system adaption, it is necessary for the engine to be at operating temperature.

Ignition off

Press the *yellow* key the number of times required for the function symbol to appear on the function display.

Display:



Press the *green* key until the clear symbol appears on the function display. Start the engine within 8 seconds. Allow the engine to idle until the system adaption code appears.

Display:

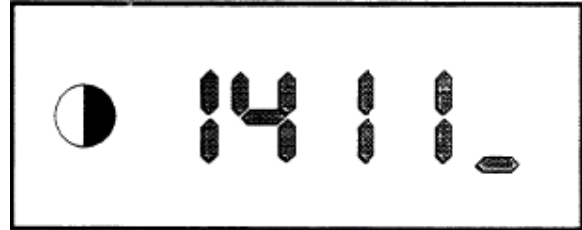

The engine must now idle for at least 30 seconds.

System adaption is then completed.

Ignition off





## Knock detection

Before knock detection is carried out, error diagnosis must first of all be performed to guarantee that no electrical error has occurred in the area of the knock control and the knock sensors.

Knock detection should not be carried out if the customer has complained about poor output or too high a consumption, for instance.

### Condition:

The engine must be at operating temperature during the test. Testing must be carried out during a test drive or on the roller test stand.

## Knock detection

Engine at operating temperature

While the engine is running, simultaneously press the *yellow* and the *green* key until the knock detection function symbol appears on the function display.

Display:



The tester is new in knock detection mode.

### Note:

**Normal driving is a prerequisite for the test drive (roller test stand).**

Start the test drive (roller test stand). Press the *green* key until the clear symbol appears on the function display.

Display:



The tester is now active. If knocking occurs, this will be indicated by the tester, e.g.:

Display:



After the expiry of 10000 ignitions. the function display will change to "r".

Display:



Counting is now complete.

The number of knocks is displayed in per mill.  
In this example. 25 knocks have occurred.

Knock detection must be carried out until the function display switches over from the clear symbol to the knock detection symbol. This is always the case once 10000 ignitions have occurred. All occurring knocks are added up and displayed as the end result.

To restart knock detection. the *green* key must be pressed until the clear symbol again appears.

A knock display of > 2.5 (25) draws attention to an error.

#### Error possibilities:

Defective cup tappets  
Conical rod damage  
Crank mechanism damage

To terminate knock detection mode. the *green* and *yellow* keys must be pressed simultaneously until the display appears.

Display:



## Troubleshooting

**Diagnosis using the tester can refer only to the error path, but not to a defective component.**

**Note:**

**Before troubleshooting, the entire error memory must be read out.**

## Error code 1111

The supply voltage is too low  
< 10 V or too high > 16 V.

Possible causes for too low a supply voltage:

Battery exhausted

Poor contact on the grounding strap  
Poor contact on the control unit

A defective regulator may be the cause of  
too high a supply voltage.



**Error code 1112**

This error code indicates an error in the area of the idle contact.

**Possible error:**

Ground fault  
Switch stuck

**Testing the idle contact**

Extract the plug from the DME control unit.

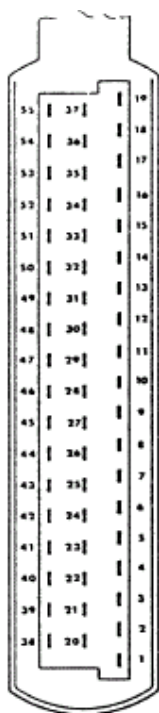

Connect a ohmmeter between terminal 52 and terminal 24 on the DME plug.

**Display:**

Throttle valve closed:  $R < 10 \Omega$

Throttle valve open:  $R = \infty \Omega$

Switchover must already occur if the throttle valve is only slightly open (approx.  $1^\circ$ ).

If the values are not reached during this testing step, measurement must be repeated directly on the throttle valve switch.





**Error code 1113**

This error code draws attention to an error in the area of the full load contact.

**Possible errors:**

Ground fault  
Switch stuck

**Testing the full load contact**

Connect an ohmmeter between terminal 53 and terminal 24 on the DME plug.

**Display:**

Throttle valve closed:  $R = \infty \Omega$   
Throttle valve in full load position:  $R < 10 \Omega$

The switching point must be briefly before full load.

If the values are not reached in this testing step, measurement must be repeated directly on the throttle valve switch.

**Error code 1114**

This error code draws attention to an error in the area of the engine temperature sensor (NTC 2).



87/912

**Possible errors**

Ground fault  
Short to positive  
Wire discontinuity  
NTC 2 defective

**Testing the engine temperature sensor.**

Connect an ohmmeter between terminal 45 and terminal 24 on the DME plug.

**Display**

0°C	=	4400 Ω	-	6800 Ω
15 - 30°C	=	1400 Ω	-	3600 Ω
80°C	=	250 Ω	-	390 Ω
100°C	=	160 Ω	-	21 Ω

If the values are not reached in this testing step, measurement must be carried out directly on the engine temperature sensor.

The engine temperature sensor (NTC 2) informs the control unit about the current engine temperature. It results in mixture enrichment during cold starts or hot running.

**Error code 1121**

This error code draws attention to an error in the area of the air-flow sensor.

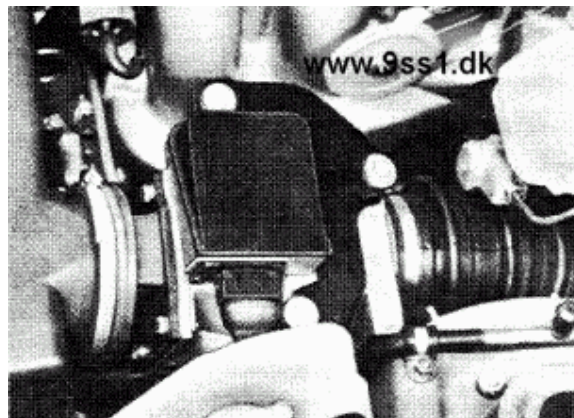

87/907

**Possible errors:**

- Ground fault
- Short to positive
- Wire discontinuity

**During this test, the plug of the DME control unit must be plugged in.**

### Testing the power supply of the air-flow sensor:

Ignition on

On the extracted plug of the air-flow sensor, a voltage of 5 V  $\pm$  0,5 V must be measurable between terminal 3 (positive) and terminal 4 (negative) (if necessary, check by reference to the circuit diagram).

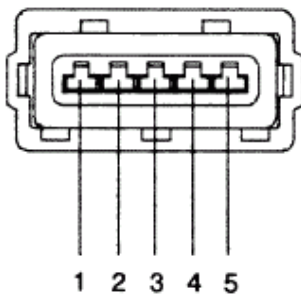

A voltage rise must be observed during this time.

### Display:

approx. 0.2 V - ca. 4.6 V

No abrupt voltage changes must be observed during opening or closing. (Abrupt voltage changes. i.e. the air-flow sensor is defective).



33

### Testing the air-flow sensor

From the extracted plug of the air-flow sensor,  
link plug terminal 3 to air-flow sensor plug terminal 3 and plug terminal 4 to air-flow sensor plug terminal 4 using an auxiliary cable. Measure the voltage between terminal 2 of the air-flow sensor and ground.

### Display:

approx. 250 - 260 mV

Detach the top of the air filter.

Using a non-metallic tool, slowly force the airflow sensor valve to full load position.

### Error code 1123

When this error code appears, the Lambda control has detected too rich or too lean a mixture.

#### Possible causes for too lean a mixture:

Lambda probe ground fault  
Infiltrated air on the intake side  
Infiltrated air on the exhaust side of the Lambda probe  
Injection valve does not open  
Ignition cut-out  
Fuel pressure too low

#### Possible causes for too rich a mixture:

No partial vacuum on the pressure regulator  
Injection valve does not close  
Return to the fuel tank clogged.



### Error code 1124

This error code draws attention to an error in the area of the Lambda probe.

#### Possible errors:

Ground fault  
Short to positive  
Wire discontinuity

#### Testing the Lambda probe signal.



Figure 87/906

Disconnect the Lambda probe plug.

#### Note:

The voltage of the Lambda probe must only be measured using a digital voltmeter, or only using a comparable measuring instrument with an internal resistance ( $R_i$ ) of no less than  $10\text{ M}\Omega$ .

Measure the voltage between pin 1 and engine ground.



35

The voltage is within the range of approx. 150 mV - 900 mV depending on the mixture composition.

Check the cable harness to the DME control unit with reference to the circuit diagram.



### Error code 1125

This error code indicates an error in the area of the intake air temperature sensor (NTC 1) in the air-flow sensor.

#### Possible errors:

Ground fault  
Short to positive  
Wire discontinuity  
NTC 1 defective

#### Testing the intake air temperature sensor.

Connect an ohmmeter between terminal 44 and terminal 26 on the DME plug.

#### Display:

0 °C = 4400 Ω - 6800 Ω  
15 - 30 °C = 1400 Ω - 3600 Ω  
40 °C = 1000 Ω - 1300 Ω

If the values are not reached during this testing step, measurement must be carried out directly on the intake air temperature sensor.

Connect an ohmmeter between pin 1 and pin 4 on the air-flow sensor.

Display: as above



**Error code 1131**

This error code draws attention to an error in the area of knock sensor 1.

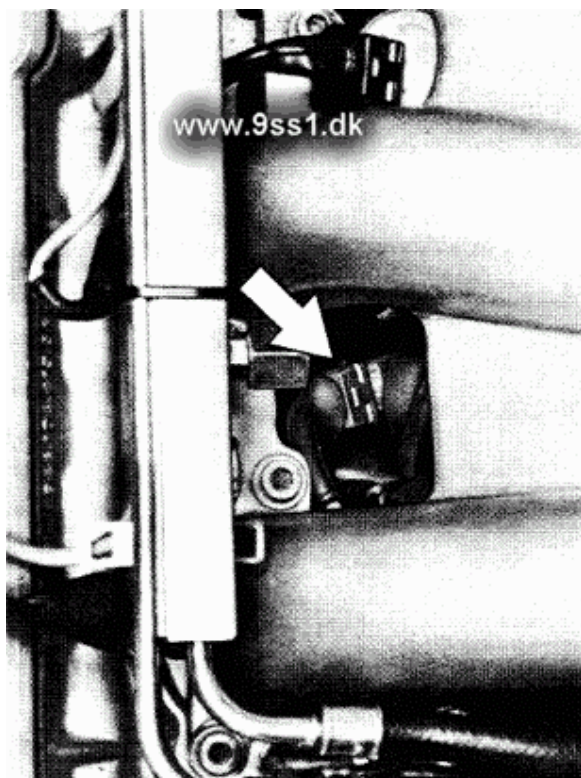

87/911

**Error code 1132**

This error code draws attention to an error in the area of knock sensor 2.

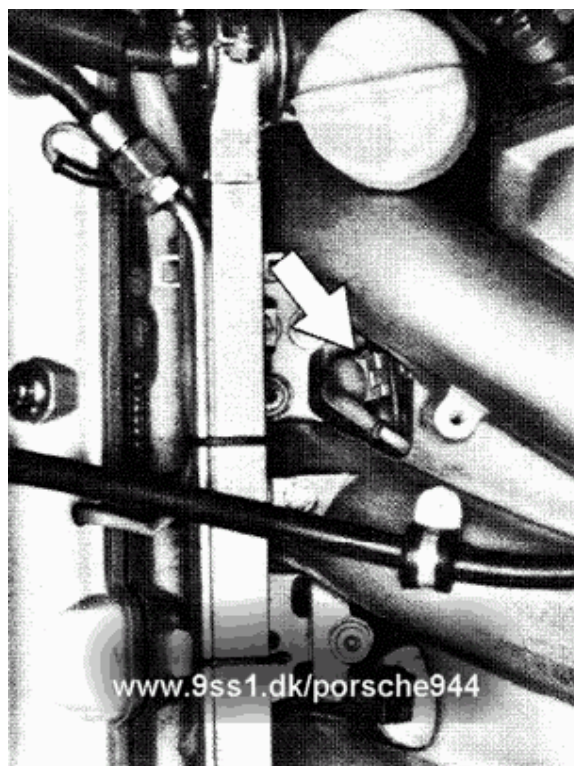

87/910

Error testing of the knock sensors is an *active* error test, i.e. error testing is carried out during driving.

If an error has occurred, first check the wiring for a ground fault, a short to positive and for continuity with reference to the circuit diagram before replacing the knock sensor.





### Error code 1133

Error code 1133 draws attention to an error in the area of the knock control in the DME control unit. If this error code appears, the DME control unit must be replaced.



### Error code 1134

This error code draws attention to an error in the area of the Hall generator.



87/904

#### Possible errors:

- Ground fault
- Short to positive
- Wire discontinuity

#### Testing the Hall generator signal

Using a suitable auxiliary æble, connect an oscilloscope to the diagnosis plug, pin 9 (square-wave signal) and pin 2 (ground). If the Hall generator signal is O.K., the following picture must appear on the oscilloscope's screen.

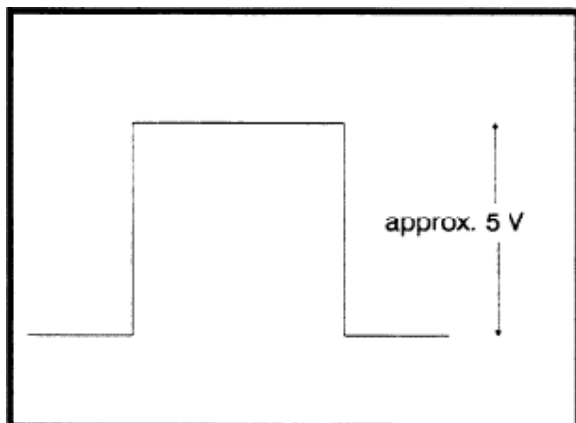

### Error code 1141

Error code 1141 draws attention to an error in the area of the DME control unit. If this error code appears, the DME control unit must be replaced.



### Testing the Hall generator's power supply

Disconnect the Hall generator's connector.

Ignition on

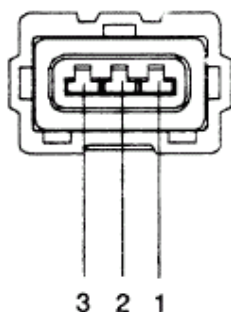

36

A voltage of 12 Volt  $\pm$  1 V must be measurable between pin 1 (positive) and pin 3 (negative). If this is not the case, check the wiring with reference to the circuit diagram.





**Error code - List**

<b>Error code</b>	<b>Error path</b>
1500	No error
1000	Output end
1111	Supply voltage too low/high
1112	Idle contact
1113	Full load contact
1114	NTC 2
1121	Air-flow sensor
1123	Lambda control detects a too rich / too lean mixture
1124	Lambda probe signal not correct
1125	NTC 1
1131	Knock sensor 1
1132	Knock sensor 2
1133	Knock control in the control unit
1134	Hall generator signal
1141	DME control unit

A digit 2 (e.g. 1211) may appear in the second error code digit position to indicate "sporadic errors", i.e. an occasionally occurring error.

This does not apply to error codes 1000 and 1500.





## Resetting the error memory

Once the DME control unit error diagnosis has been completed, this is completed by error code 1000. The error memory cannot be reset as follows until this error code appears:

The *yellow* key must be pressed until the function symbol (see display) appears on the function display.

Display:

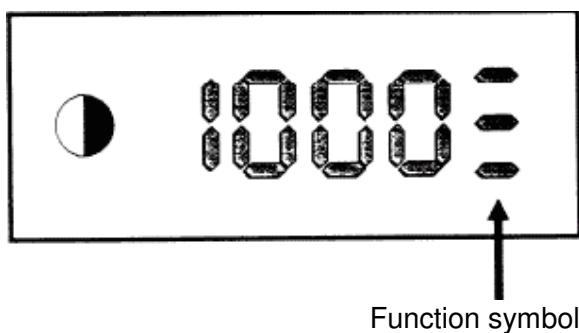

The *green* key must be pressed until the clear symbol appears on the function display.

Display:

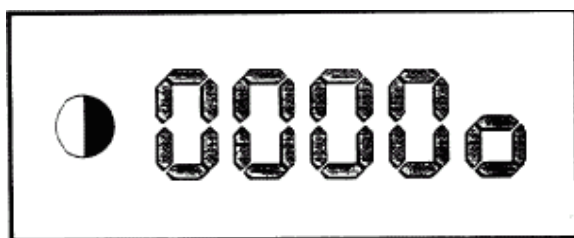

The error memory is reset if the LED goes off and the function display changes to 0000.

Display:

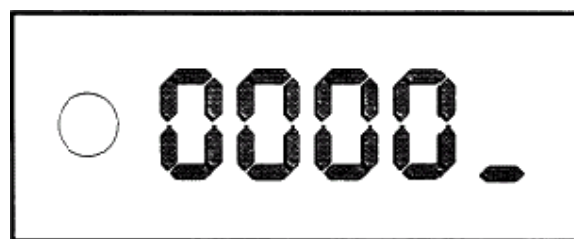

### Note:

A test drive must be carried out after resetting the error memory.

At the same time, pay attention to the following:

1. The engine must be at operating temperature. i.e. at least 80°C.
2. The duration of the test drive (minimum 6 minutes).
3. At the end of the test drive, run the engine for at least 60 seconds without opening the throttle valve.

After the test drive, read out the error memory once again.



**Operating conditions for start of diagnosis**

<b>Systems</b>	<b>Ignition on Engine standing still</b>	<b>Engine running</b>
<b>944 S / 944 S2</b>		
DME	yes	to n < 2000 rpm
Airbag	yes	yes
Alarm system	yes	yes

---

**Operating instructions for System Tester 9288**

## 1. General information

### 1.1 Application

The Systemtester 9288 (BOSCH KTS 301) is a microprocessor-controlled self-diagnosis tester.

All systems which have a diagnosis interface as per ISO Standard can be tested with this tester. The following tests are possible:

- \* Reading out the fault memory
- \* Testing of the actuators
- \* Testing the circuit inputs
- \* System adaptation
- \* Engine-knock detection
- \* Sensor and status checks, tire-pressure monitoring (RDK)

The Systemtester 9288 is a high-quality piece of electronic equipment. In order to prevent damage to the equipment as a result of improper use, please read the information in the operating instructions carefully and comply with it.

In addition, the instructions (specifications) of the vehicle manufacturer are also to be observed.

If the tester should fail, check the following points before sending it in for repair:

1. Has the tester been operated incorrectly?
2. Is the battery sufficiently charged?
3. Is the adapter cable OK?

(Please note when checking the adapter cable that a highly sensitive electronic matching circuit is installed in the vicinity of the 19-pore plug).

### 1.2 Construction (Fig. 1)

No.	Description	Function	Remarks
1	LCD indicator	Dot matrix 5 x 8 4 lines each with 20 characters Foreign languages possible Illumination	If the Systemtester 9288 is switched on without the program module, following the self-test the tester switches off automatically and informs the user that the program module is not fitted.
2	Keyboard	Keys 1, 2, 3 = Selection key  Keys < > = Previous page next page  Key H = Help menu, e.g.: Illumination Screens stored Control-unit overview Setting up printer Switching off unit  Key N = Return to the next higher program level following termination of a test sequence or, during a test sequence, return to the last display  Key = Storing indication  Key = Playing back stored reading	Switching on = Press any key  Switching off = 180 s after last depression of a key or if no data stream flows across the serial interface.  The last field in the top right-hand corner is filled completely, this means that this is a stored figure and not an actual, real-life figure.
3	Power supply  If the voltage is not sufficient, "Charge battery" appears on the display. If this is not done, the unit switches itself off.	Fitted accumulator with NiCd batteries. The Systemtester 9288 must be switched off during the initial battery charging process. Charging time > 8 hours	Discharged upon delivery. Following charge: Operating time: 4 - 8 hours without scale illumination 1 - 2 hours with scale illumination
		Connection to vehicle battery by means of vehicle-specific adapter lead (see 1.4)	Connection through ISO-interface Charging voltage supply
		Battery charger (accessory)	For test operation and for charging the NiCd batteries.
4	Connection for Input and output devices	Connection facility for Printer e. g. Epson, IBM, Hewlett Packard (HP)	The Systemtester 9288 transmits data with the following configurations: 8 data bits / 1 start bit / 1 stop bit / No parity (for printer matching)
5	Connection for vehicle specific adapter lead	Reading out the data	Input for flashing-code support
6	Plus-in programme module (see also Figure 2)  <b>C-MOS !</b> Do not touch plug !	Operating system LCD drive Keyboard Interface communication Computations and data conversions	Plug in module: remove rubber protector, insert module fully.

1.3 Battery charger run off mains voltage (Figure 3)  
 - Accessory -  
 Item 1 Charger with connecting cable, 1.5 m long  
 Item 2 8-pin AMP plug

1.4 Vehicle-specific adapter cable  
 Porsche No. 000 721 928.81

1.5 Connecting lead (Figure 4)  
 - Self-fabrication -  
 for printer, programme load station or similar unit.  
 For interface-trunk assignment, see manual of corresponding unit.  
 Printer cable for standard D 25  
 BOSCH No. 1 684 465 193  
 Printer cable for EPSON  
 BOSCH No. 1 684 465 194

## 2. Connection

The following points must be observed:  
 - No gear must be engaged on the vehicle (Automatic transmission in position N - P) - Danger of Accident!  
 - ALL work on the vehicle must only be carried out with the ignition switched off.  
 After having connected the vehicle-specific adapter cable, the instructions listed under "3" are displayed on the Systemtester 9288:

2.1 Charging with the battery charger (Fig. 3)  
 Connecting the Systemtester 9288 to the battery charger.  
 (Fig.1, pos.5).

2.2 Diagnosis  
 Connecting the Systemtester 9288 to the diagnosis plug in the vehicle by means of the vehicle-specific adapter cable.  
 Switch on the tester and proceed according to the instructions displayed.

## 3. Testing

Scope of module:  
 Guidance through the menu, communication with the ECU, reading out the error memory and selection of the "Help" menus, actuator diagnosis, circuit inputs and system adaptation, engine-knock detection, sensor and event check for the tire-pressure monitor (RDK).

3.1 Reading-out the error memory  
 Connect the Systemtester 9288 (see 2.)  
 Switch on the Systemtester,  
 (possible with every key!)  
 Display:

```

PORSCH
Eprom modul      eng
Mod. intro.
xx.xx.xx
    
```

If a specific instruction does not appear in a display, it is always possible to proceed by pressing the button >.

Due to the fact that the Systemtester 9288 can store error displays (see Chapter 3.7), the following display will appear if errors have been stored in the image memory:

```

Stored displays
erased ?
1 = yes
3 = no
    
```

Key 3  
 Display:

```

Print out
displays:      H
continue:      >
    
```

H = Help menu (see 3.6) or key 1  
 Display:

```

Vehicle types
1 = 944 S
2 = 911 Carrera 4
3 = 928 S 4
    
```

Selection of the vehicle type with key 1, 2 or 3.  
 After the vehicle type has been selected, the following instruction appears:

```

Connect adapter
cable to veh. plug.
Ignition "ON".
After completion:  >
    
```

The following then appears:

```

Wait for
Data
Break off test:    N
    
```

After a short pause, the Systemtester 9288 reports all the systems that are installed in the particular vehicle. If a system is preceded by "#", this means that at least 1 error is stored in that particular system.

Examples:

```

Installed systems
1 = # LH
2 = # EZK
3 = RDK
    
```

The particular system can be selected by means of key 1, 2 or 3.  
 After selection (for instance with key 1), the following display appears:

```

LH
System:    L01 LH-JET
Ser. No.:  92861812313
RB. No.:   0280002507
    
```

After pressing the key > , a selection menu is displayed:

```
Menu
1 = Fault memory
2 = Drive links
3 = Input signals >
```

```
< Menu
1 = System adaptation
```

In the example - press key 1. There then follows the display of the number of errors which are stored (if any).

```
Number of
faults
- 2 -
```

Proceed with key >

```
Additional info to
every display with
key 1
continue: >
```

Proceed with key >  
Error output:

```
1: Engine
temperature sensor 2
Short to ground
not present
```

If key 1 is pressed instead of the > key, the corresponding error code display appears (the last two digits of the flashing code).

```
Fault code: - 14 -
```

Proceed with key >  
Further errors are displayed (if they exist):

```
2 : Idle contact
Short to ground
present
```

If key 1 is pressed instead of key > the corresponding error-code display appears (the last two digits of the flashing code).

```
Fault code: - 12 -
```

After the last displayed error, the following instruction appears:

```
Repair fault accord-
ing to repair
instructions
Continue: >
```

Proceed with key >

```
Fault repaired ?
1 = yes
3 = no
```

Return to display "No. of errors" with key 3.  
Proceed with key 1:

```
Fault memory
1 = Erase
3 = Do not erase
```

If key 3 is pressed:  
= Return to menu "error memory".  
The error memory is not erased!

Proceed with key 1:

```
Fault memory
has been cleared
Return: N
```

The test scope "Read-out error memory" is terminated at this point.

### 3.2 Actuator diagnosis

If an actuator is selected, this is triggered by the ECU so that it can be checked for correct functioning. The various actuators components are gone through one after the other and are selected with the > key. Operate the Systemtester 9288 as described under 3.1 until the following menu display appears:

```
Menu
1 = Fault memory
2 = Drive links
3 = Input signals >
```

After pressing key 2, the display for the first actuator appears:

```
Injector
to activate
1 = Start
Continue: >
```

If key > is pressed, the next actuator is selected.  
Pressing key 1 results in the following instruction:

```
Can injectors be
heard / felt?
1 = yes
3 = no
```



Key 1 selects the next actuator (e. g. idle actuator). Following instruction:

```
Repair fault accord-
ing to repair
instructions
Continue: >
```

After pressing key > , the following display appears:

```
Injector
to activate
1 = Start
Continue: >
```

Proceed with key 1

```
Can injectors be
heard / felt?
1 = yes
3 = no
```

Proceed with key 1 to the next actuator.

```
Idle stabilizer
to activate
1 = Start
Continue: >
```

Proceed with key 1

```
Can idle stabilizer
be heard / felt?
1 = yes
3 = no
```

By pressing key 1, the next actuator is selected. After pressing key 3, the next instruction appears:

```
Repair fault accord-
ing to repair
instructions
Continue: >
```

Proceed with key >

```
Idle stabilizer
to activate
1 = Start
Continue: >
```

After pressing key 1. the following display appears:

```
Can idle stabilizer
be heard / felt?
1 = yes
3 = no
```

By pressing key 1. the next actuator is selected. The actuators are selected one after the other and triggered until the following display appears:

```
Drive link test
completed
Return: N
```

By pressing the key N. the operator is returned to the menu.

### 3.3 Circuit inputs

In addition to the actuators, the Systemtester 9288 can also check circuit inputs. To this end, operate the Systemtester 9288 in accordance with 3.1 until this menu display appears:

```
Menu
1 = Fault memory
2 = Drive links
3 = Input signals >
```

Press key 3

```
Idle contact
1 = Start
Continue: >
```

By pressing key > the next circuit input is selected. The next display appears when key 1 is pressed.

```
Activate accl. pedal
Idle contact
- closed -
Continue: >
```

Operate the accelerator pedal, the following display appears:

```
Activate accl. pedal
Idle contact
- open -
Continue: >
```

The next circuit input is selected by pressing key >. Repeat until this display appears:

```
Input signals
testing completed
Return: N
```

Press key N for return to menu

### 3.4 System adaptation

When the function "System adaptation" is triggered. the ECU registers the basic air requirement of the engine. To this end. operate the Systemtester 9288 as per 3.1 until the following menu display appears:

```
Menu
1 = Fault memory
2 = Drive links
3 = Input signals >
```

Proceed with key >

```
< Menu
1 = System adaptation
```

Proceed with key 1

Prerequisite:  
Eng. at oper. temp.  
with all consumers  
and ignition off.

Proceed with key >

System adaptation  
1 = Start  
  
Return: N

If key N is pressed  
= return to menu.  
If key 1 is pressed:

Start engine !

Following engine start there appears:

System is being  
adapted  
  
Please wait !

After approx. 30 secs there appears:

System adaptation  
completed  
  
Return: N

If it is impossible to carry out system adaptation (idle contact not closed, or defective), the following display appears:

No system adapta-  
tion possible  
Idle contact ?  
Return: N

After completion of the system adaptation, return to the menu with key N.

### 3.5 Engine-knock registration

The engine-knock registration function can only be triggered through the EZK or DME control unit. To this end, operate the Systemtester 9288 as described in 3.1 until the following display appears:

Installed systems  
1 = # LH  
2 = # EZK  
3 = # RDK

The particular system can be selected by means of key 1, 2 or 3. For instance with key 2 the following display appears:

EZK  
System: E01EZK  
Ser. No.: 92861812415  
RB. No.: 0227400154

Proceed with key >  
The following menu display appears:

< Menu  
1 = Fault memory  
2 = Knock registration

Proceed with key 2

Condition:  
Engine at operating  
temperature  
  
>

Proceed with key >

< Start knock  
registration before  
test drive  
  
>

Proceed with key >

< A normal test  
drive is a pre-  
requisite  
  
>

Proceed with key >

< Stop the test  
drive only if the  
display with the no.  
of knocks comes on.

Proceed with key >

Knock registration  
1 = Start  
  
Return: N

Pressing key 1 activates the engine-knock counter:

Knock registration  
in progress  
  
Please wait !

The knock counter registers 10,000 ignitions before the display with the actual number of combustion "knocks" appears.

```

Number
Knocks:      xxx
Combustion:  xxxxx
Continue:    >
    
```

Proceed with key >

```

Knock registration
completed

Return:      N
    
```

If knock registration is impossible (due to lack of engine-speed signal), the following display appears:

```

No knock regist-
ration possible.
RPM signal?
Return:      N
    
```

Following completion of the knock registration test, return to the menu with key N.

### 3.6 Help menu

The "Help" menu can be selected from every display by pressing key H. Return to the initial display with key N.

```

Help menu
1 = Illumination
2 = Display stored
3 = Ctrl. unit chart  >
    
```

Proceed, for instance with key 1:

Key 1:  
The scale illumination is switched on and the tester returns to the previous display.

Or with key 2:

```

Data display stored
1 = Print
2 = Clear
    
```

Proceed with key 1  
Stored displays are printed out (if printer connected).  
Proceed with key 2  
Stored displays are erased.

With the "Help" menu, for instance

```

Help menu
1 = Illumination
2 = Display stored
3 = Ctrl. unit chart  >
    
```

If the key > is pressed, a further section of the "Help" menu is displayed:

```

< Help menu
1 = Printer setting
2 = Switch of! equip.
3 = Baud Rate
    
```

Proceed for instance with key 1

```

Printer setting
1 = IBM
2 = HP Quiet Jet
3 = EPSON
    
```

The selection of the printer results in the tester being set up for the printer type in question.

### 3.7 Store measurement displays (Key ⤴)

Using key ⤴, all displays can be stored manually.  
The following displays are stored automatically:

- ECU-Identity
- Installed systems
- All existing errors

When the memory limit is reached, the following instruction is displayed:

```

Data display mem.
full !

Return:      N
    
```

### 3.8 Show stored measurement displays (Key ⤵)

Using the keys < or >, the stored displays for the selected system can be shown.  
The stored displays can be called up by means of the ⤴key.  
The system selection (LH - EZK - RDK) takes place with the keys 1, 2 or 3.

## 4. Service and wear parts (BOSCH)

Fig.	BOSCH Part No.	Designation	Comment
1/3	1 687 335 002	NC- battery	9 pole
4/1	1 684 483 152	Plug	
4/2	1 684 485 170	Socket	
4/3	1 680 552 005	Screwed cap	
	1 684 465 193	Printer cable (Standard D25)	
	1 684 465 194	Printer cable (EPSON)	

### 4.1 Service parts (Porsche)

Designation	Porsche Part No.	Special tool No.
Systemtester 9288	000.721.928.80	9288
Adapter cable	000.721.928.81	9288/1
Battery charger	000.721.928.82	9288/2
Module (D)	000.721.928.84	9288/4
Module (GB/USA)	000.721.928.85	9288/5
Module (F)	000.721.928.86	9288/6
Module (I)	000.721.928.87	9288/7
Module (E)	000.721.928.88	9288/8



**Tightening torques for engine (16-valve)**

Location	Thread	Tightening torque Nm (ftlb)	
<b>Crankshaft/ crankcase</b>			
Upper and lower crankcase sections (studs)	M 12 x 1.5	30(22)	1 st stage
		60 ° torque angle	2nd stage
	M 10	20(15)	1 st stage
		50(37)	2nd stage
	M 8	20(15)	
	M 6	10(7.5)	
Knock sensor	M 8	20(15) original screw without washer	
<b>Cylinder head</b>			
Cylinder head to upper crankcase section Engine type M 44.40	M 12	refer to Page 15 - 110	
		20(15)	1 st stage
		90 ° torque angle	2nd stage
		90 ° torque angle	3rd stage
Engine type M 44.41 (3.0 l)	M 12	20(15)	1 st stage
		60 ° torque angle	2nd stage
		90 ° torque angle	3rd stage
Camshaft bearing to cylinder head	M 8	20(15)	
Allen screws for chain tensioner	M 6	10(7.5)	
Banjo bolt / Chain tensioner	M 8 x 1	10(7.5)	
Cover for cylinder head	M 6	10(7.5)	
Fastening / Hall sensor	M 6	10(7.5)	

**Tolerances and wear limits****Engine M 44.40/41**

		<b>For installing (new)</b>	<b>Wear limit</b>
<b>Cooling system</b>			
Coolant thermostat	Opening temperature	81-85° C	
Cooling system cap Pressure valve	opens at excess pressure	1.3...1.5	
Vacuum valve	opens at vacuum	0.1 bar	
<b>Oil circuit</b>			
Oil consumption	l/600 miles		approx. 1.5
Oil pressure at 80° C oil temperature: at 5,000 rpm	excess pressure	approx. 4 bar	
Oil capacity	6 l, from MY '88	6.5 l	
Difference of quantity between dipstick marks			approx. 1.5 l
<b>Valve timing</b>			
Camshaft bore	Inner dia.	28 + 0.021 - 0	
Camshaft	Dia.	28 - 0.04 - 0.055	
Camshaft	Axial clearance	0.08...0.18	
Bucket tappet bore	Inner dia.	35 - 0.025 - 0.041	
Bucket tappets	dia.	35 - 0.025 - 0.041	
Camshaft	Runout	0.02	

## Tolerances and wear limits

### Engine M 44.40/41

		For installing (new)	Wear limit
<b>Cylinder head with valves</b>			
Mating surface	Distortion		max. 0.05
Valve seat width	Intake:	1.5	
Exhaust		1.8	
Seating angle		45°	
Outer correction angle		30°	
Inner correction angle		60°	
Valve guides:	Inner dia.	7 + 0.015	
Valve stem:			
Intake	Dia.	6.97 - 0.012	
Exhaust	Dia.	6.94 - 0.012	
Valve guide/valve stem	Rocking clearance		
Intake			0.8
Exhaust			0.8
Compression		8 bar and above	6.5 bar
<b>Pistons with connecting rods</b>			
Cylinders/pistons	Clearance	0.008-0.032	approx. 0.080
Piston rings M 44/40	Height clearance	Groove 1	0.040...0.075
		Groove 2	0.020...0.055
		Groove 3	0.020...0.055
Piston rings M 44/41	Height clearance	Groove 1	0.040...0.075
		Groove 2	0.030...0.065
		Groove 3	0.020...0.055
Piston rings M 44/40	Ring gap clearance	Groove 1	0.20...0.40
		Groove 2	0.20...0.45
		Groove 3	0.30...0.60
Piston rings M 44/41	Ring gap clearance	Groove 1	0.20...0.50
		Groove 2	0.20...0.55
		Groove 3	0.30...0.90

**Tolerances and wear limits****Engine M 44.40/41**

		<b>For installing (new)</b>	<b>Wear limit</b>
Con rod bush	Dia.	24 + 0.018 + 0.028	
Piston pin	Dia.	24-0.004	
Con rod bush/piston pin	Radial clearance	0.018-0.032	

**Crankshaft and cylinder block**

Crankshaft measure at bearing 2, 3 or 4 Bearing 1 and 5 on prisms	Runout	0.046	max. 0.06
Con rod journal	Dia.	51.971-51.990	
Con rod/crankshaft	Radial clearance	0.027-0.069	
	Axial clearance	0.080...0.240	
Crankshaft bearing journal	Dia.	69.971-69.990	
Crankshafts/ crankshaft	Radial clearance	0.028-0.070	0.16
Crankshaft bearing/ crankshaft	Axial clearance	0.060...0.192	0,40
Cylinder bore	Out-of-round	0.010	0,020
Bore for balance shaft bearing shells at crankcase or balance shaft cover	Dia.	34.000...34.019	
Bore for bushing in bearing housing	Dia.	34.000...34.019	
Balance shaft	Dia.	30.975...30.991	



## REMOVING AND INSTALLING ENGINE (16-VALVE ENGINES)

## TOOLS



No.	Description	Special Tool	Remarks
	Engine suspension beam	3033 (VW Special Tool)	In conjunction with workshop crane, e.g Bilstein K750 H.

## Note:

If necessary, use a commercially available carabiner (load-bearing capacity 650 kg) to connect engine suspension beam to workshop crane.

## REMOVING AND INSTALLING ENGINE (MANUAL TRANSMISSION)

Remove by lowering engine from car.  
The bell housing remains attached to the engine.

### Removing

1. Align lifting platform pads beneath jacking points and raise car.
2. Place protective covers on fenders.
3. Unbolt and remove front wheels.
4. Disconnect battery/bodywork ground lead. Disconnect battery positive lead. Disconnect wire harness and push both cables with rubber grommets through splash wall. Open cable clips.
5. Unbolt panel in passenger-side footwell and remove. Unbolt carrier plate for DME control unit and disconnect control-unit plug. Disconnect 8-pin connector.



6. Slacken hose clamp for fuel return line and disconnect hose. Disconnect fuel feed while countering. Detach cable from tempostat serve motor. Disconnect series resistor/injection nozzle connector.

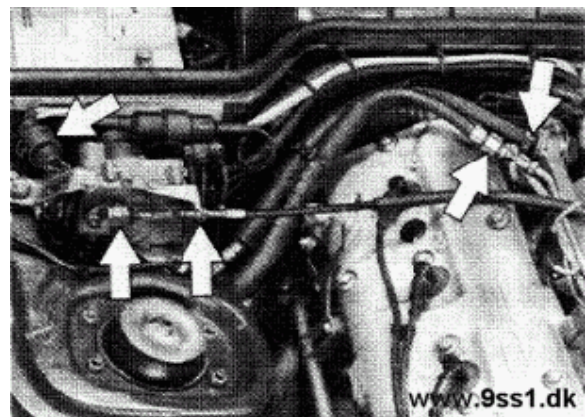

7. Disconnect breather hose for toothed belt cover at rear of lower section of air filter. Unbolt filter assembly as a unit and remove.



8. Remove air-flow sensor.

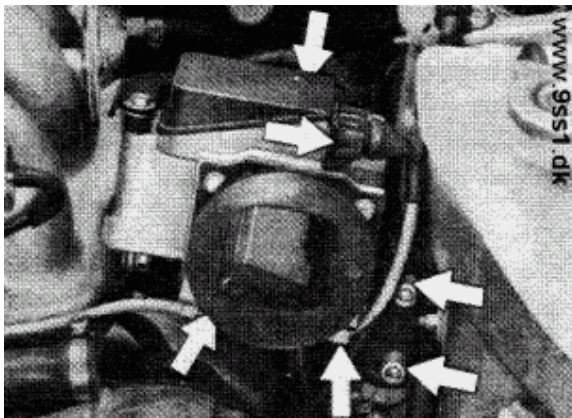

9. Slacken and remove ignition-distributor cap and rotor. (Mark installation position of rotor). Remove oil filter and ATF reservoir.

10. Remove throttle valve actuating cable complete with reversing roller and holder. Disconnect oxygen sensor plug connector. Slacken hose clamps at intake manifold and brake booster and disconnect hoses.

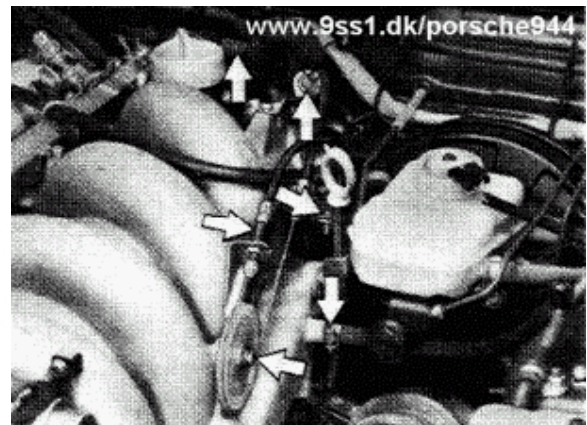

11. Remove cable clips from bulkhead. Disconnect two-pin and multi-pin connectors. Disconnect vacuum hose from tank breather valve.

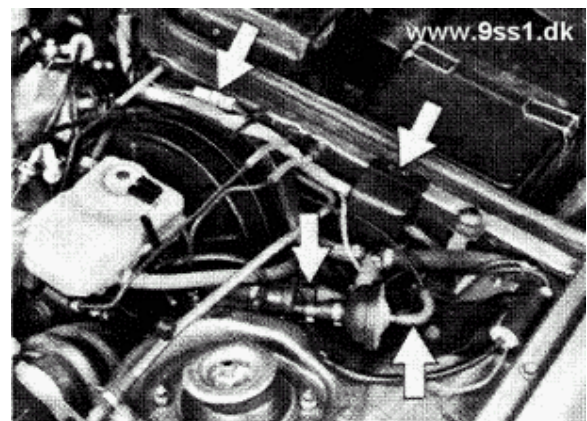



12. Remove engine underguard.

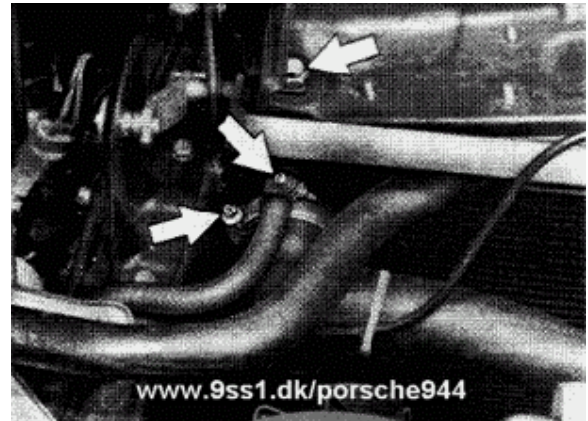
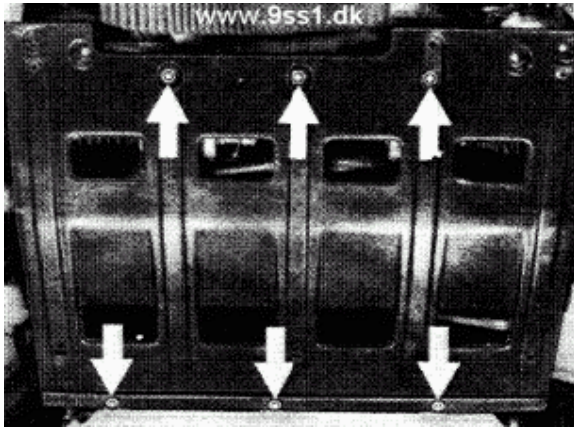

13. Open coolant drain plug and catch coolant in a suitable container. Disconnect alternator breather hose.

14. Disconnect coolant hose at bottom right of radiator from engine and remove. Catch any coolant which may be left.

15. Disconnect electric leads from fan motors, detach fan-motor bracket from radiator and remove by lowering from car.

16. Slacken coolant hose and breather hose from top left of radiator and remove. Disconnect electrical connection from temperature switch to radiator. Disconnect coolant hose from expansion tank and remove.

17. Disconnect radiator at brackets and remove radiator by lowering from car.

18. Attach support beam 10-222 A to front transport bracket of engine and hold engine in installation position. Check that beam is correctly attached.

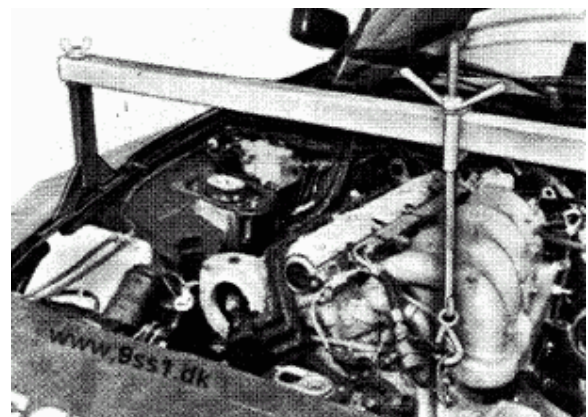

19. Detach Poly-rib belt tensioner from air-conditioning compressor and remove belt. Remove compressor from bracket and place to one side. (Do not disconnect refrigerant hoses).

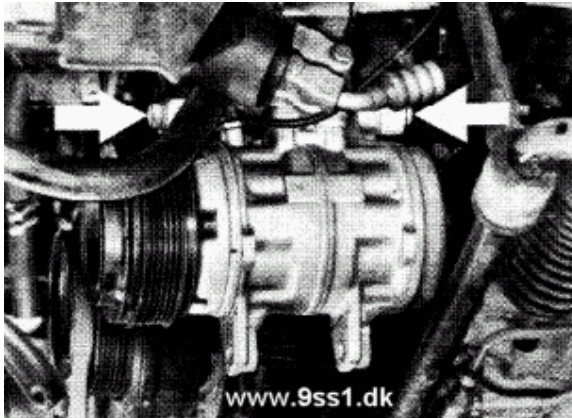

20. Unbolt stabilizer with bracket from body and from control arms and remove. Disengage left and right tie rods.

21. Slacken hose clamps between ATF cooler and steering and disconnect line.

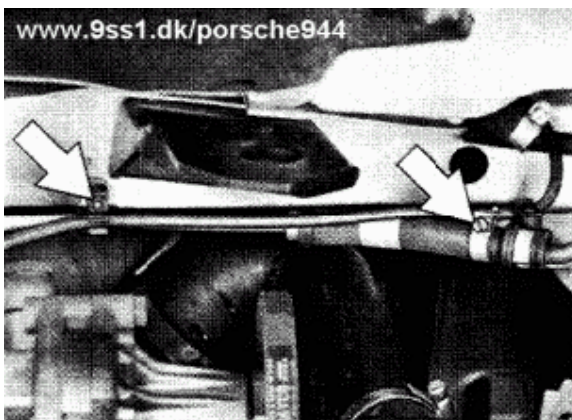

22. Disconnect servo pump from bracket, moving spacer sleeve forward to remove. Leave servo pump hanging from steering.

23. Disconnect left and right control arms from front-axle traverse and rear bearings and pull forward to remove. (Do not slacken bolts in bearing bracket).

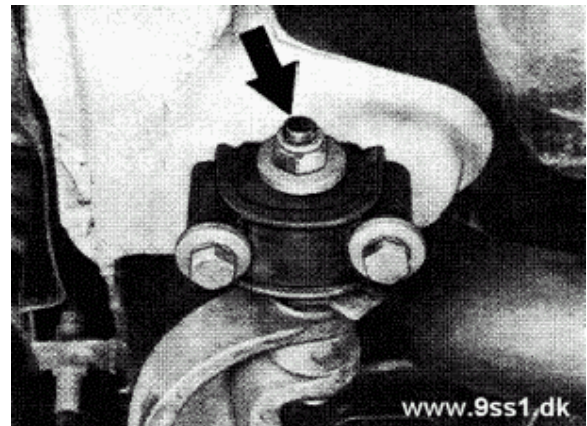

24. Unbolt universal joint from steering detach hydraulic motor mount from engine supports and lower front-axle cross member complete with steering and servo pump from car.

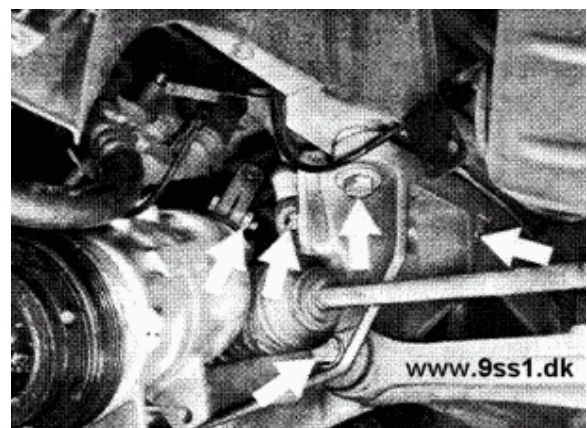



25. Disconnect leads from starting motor and remove starting motor.
26. Remove clutch actuating cylinder from bell housing. (Leave line connected). Unbolt and remove holder for line from upper crankcase half.
27. Disconnect exhaust from flange of exhaust manifold and disconnect exhaust extraction line. Remove oxygen-sensor cable from bodywork.

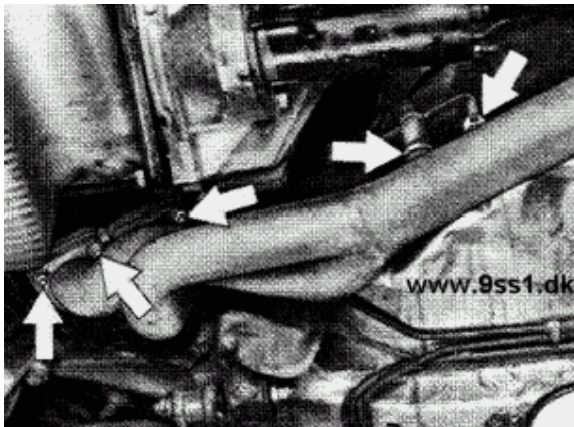

28. Disconnect flange downstream of catalytic converter and suspension and remove system.
29. Remove upper transaxle/bell housing mounting bolts.
30. Disconnect coolant hoses for heating above exhaust manifold and from cylinder head.

31. Attach VW Special Tool 3033 suspension beam to transport bracket of engine as follows:

Pulley end: Position 2  
Flywheel end: Position 12

In position 2, the threaded rod is beneath" the suspension beam. In position 12, the threaded rod is "above" the beam.



32. Tighten workshop crane e.g. Bilstein K750 H slightly to take part of engine weight and remove support beam 10 - 222A.

Note:

Threaded rod of support beam 10 - 222A remains in front suspension eye.

33. Remove lower transaxle/bell housing mounting bolts.

34. Pull engine forward, push rubber sleeve out of firewall toward engine compartment and carefully pull wire harness out of passenger-side footwell.
35. Separate engine from central tube/central shaft and lower from car.

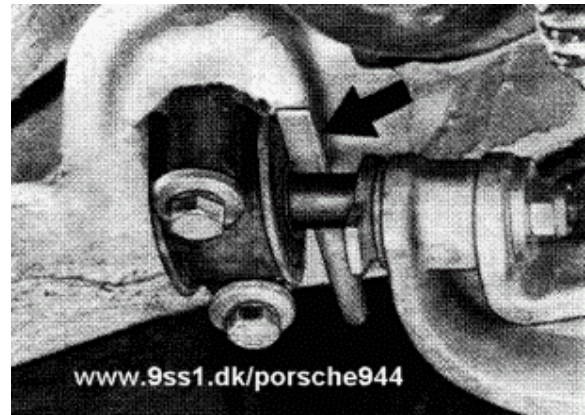

### Installing

Note the following:

1. Carefully feed wire harness for DME control unit, 8-pin connector and multi-pin connector into passenger-side footwell.
2. Begin by screwing transaxle/bell housing mounting bolts into place, but do not tighten.

### Note:

Do not tighten mounting bolts fully until hydraulic motor bearing has been attached to the front-axle cross member. Tightening torque of mounting bolts: 42 Nm (31 ftlb).

3. Install control arms, pressing sleeve in rubber-metal bearing down slightly to facilitate installation.

4. Place a 4mm thick steel washer in each of the threaded connections between the right-hand engine support (viewed in the forward direction of travel) and the hydraulic motor bearing.
5. Check that the radiator is correctly seated on the rubber mounts.
6. Tighten nuts and bolts to the specified torques.

Tightening torques:

Stablizer to aluminium control arm	25 Nm (18 ftlb)
Track rod to steering knuckle (locknut)	50 Nm (37 ftlb)
Steering - universal joint	30 + 5 Nm (22 + 3.6 ftlb)
Control arm to cross member	65 Nm (48 ftlb)
Cross member to body	85 Nm (53 ftlb)

7. Refill system with coolant and bleed system.

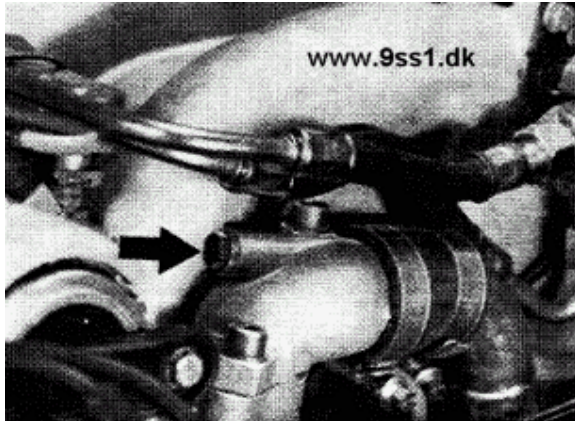

8. Fill reservoir with ATF and bleed steering system.
9. Run engine until it reaches operating temperature, check engine-oil level and coolant level, top up if necessary.





## PISTONS. '87 MODELS ONWARD

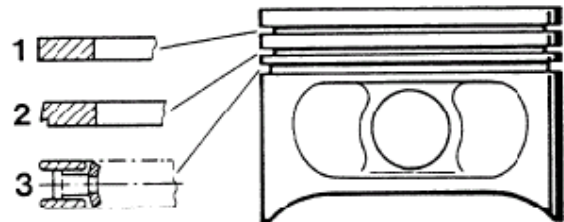
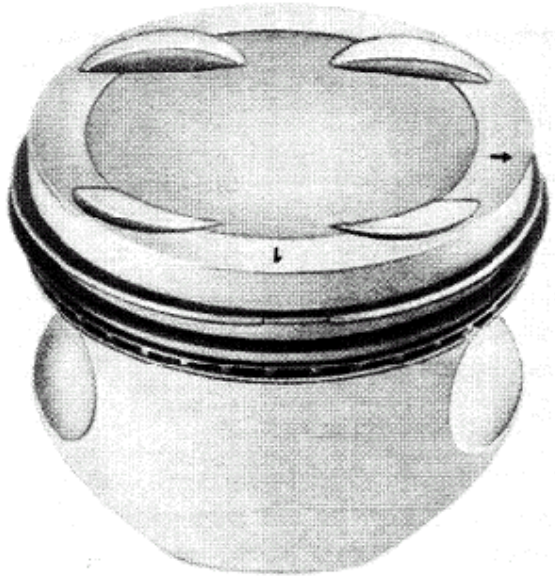

## (16-VALVE ENGINES)

Engine M 44.40 worldwide  
 Compression: 10.9 : 1  
 Nominal dia. 100.00 mm

An arrow pointing toward the belt pulley indicates the installation position.

- 1 - Plain compression ring.  
chrome-plated
- 2 - Oil scraper ring
- 3 - Three-part oil wiper ring



## Checking pistons and cylinder bores

### Motortype M 44.40

Repair Stage	Piston Ø (mm) Fa. Kolbenschmidt	Cylinder bore dia. (mm)	tolerance group code
Standard size	99.980	100.000	0
	99.990 +- 0.007	100.010 +- 0.005	1
	100.000	100.020	2
Oversize 1	100.480	100.500	I 0
	100.490 +-0,007	100.510 +- 0.005	I 1
	100.500	100.520	I 2

#### Checking pistons

Measure approx. 61 mm from piston crown, 90° offset from piston pin axis.

#### Checking cylinder bores

Measure approx. 61 mm from upper edge of cylinder bore, transverse to engine block. Mount lower crankcase section and tighten bolts to specified torque for measuring.

#### Note

It is recommended that the stocks of the relevant tolerance group are checked before machining the cylinders. If necessary, hone to the piston size available. In some cases, certain tolerance groups may be in short supply.

### Pistons from Model 89 onwards



Engine M 44. 41 (3.0 l) worldwide  
 Compression ratio: 10.9 : 1  
 Nominal Ø 104.00 mm

The installation position is indicated by the enlarged intake-valve pockets.

171/13

### Checking pistons and cylinder bore Engine type M 44.41 (3.0 l)

Repair size	Piston Ø (mm) MAHLE	Cylinder bore (mm)	Tolerance groups Code
Standard	103.980	104.000	0
	103.990 +- 0.007	104.010 +- 0.005	1
	104.000	104.020	2
Oversize 1	104.480	1 04.500	0
	104.490 +- 0.007	104.510 +- 0.005	1
	104.500	104.520	2

#### Checking pistons

Measure approx. 52 mm from crown of piston, 90° offset to axis of piston bolt.

#### Checking cylinder bore

Measure approx. 52 mm from top edge of cylinder bore, across cylinder block. For measurement, mount lower crankcase section and tighten with prescribed tightening torque.

#### Note

It is recommended that the stocks of the relevant tolerance group are checked before machining the cylinders. If necessary, hone to the piston size available. In some cases, certain tolerance groups may be in short supply.

**This page are missing or blank in the book !**

**Assemble cover of centrifugal oil compartment in upper crankcase section.**

**Notes on installation**  
**Model 89 onward,**  
**Engine type M 44.41 (3.0 l)**

**Note**

Under normal conditions, it is not necessary to remove the cover when overhauling an engine. If the cover is removed, however, the bolt area must be heated with a hot-air blower under all circumstances. Apply Loctite 270 to hexagon head screws.

Observe coding on the cover.

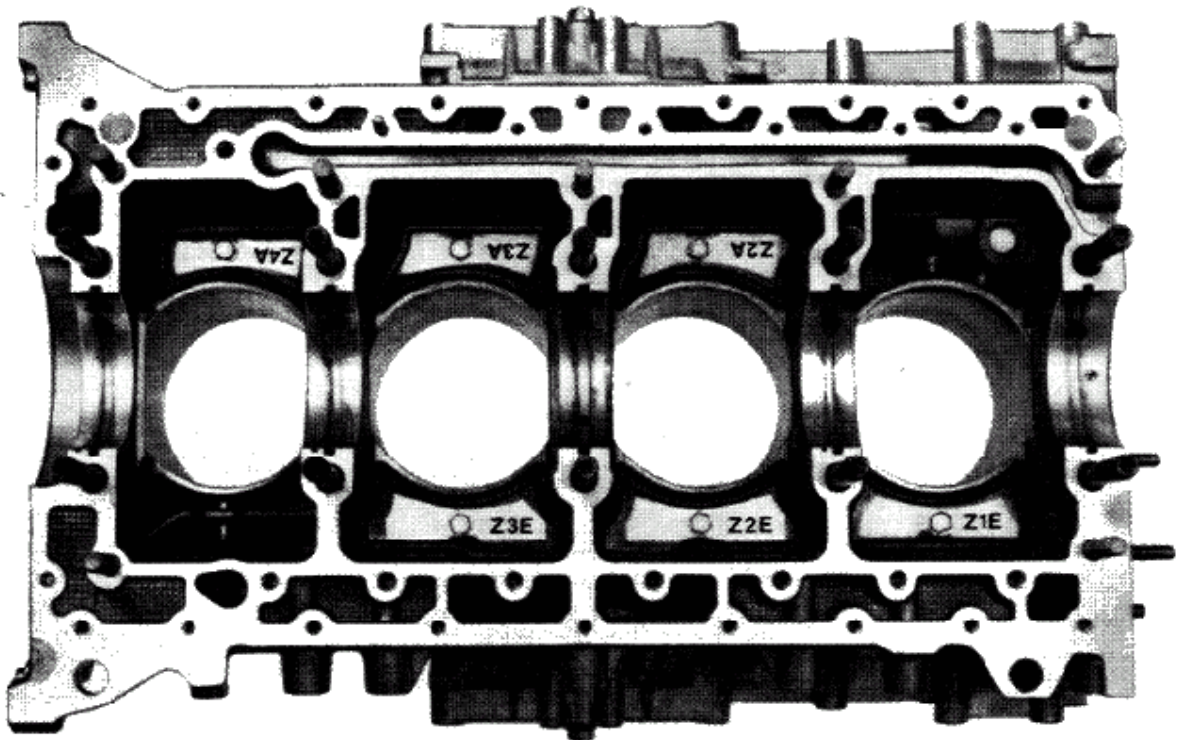

88/342



**This page are missing or blank in the book !**

**This page are missing or blank in the book !**



## Adjusting with dial gages

2. Align dial gage with improvised extension (205 mm long) on piston crown {cylinder 1}. 3 mm pretension.  
Align second gage with hydraulic tappet of cylinder 1 intake valve. The dial gage must be aligned perpendicular to the intake valve. 3 mm pretension.

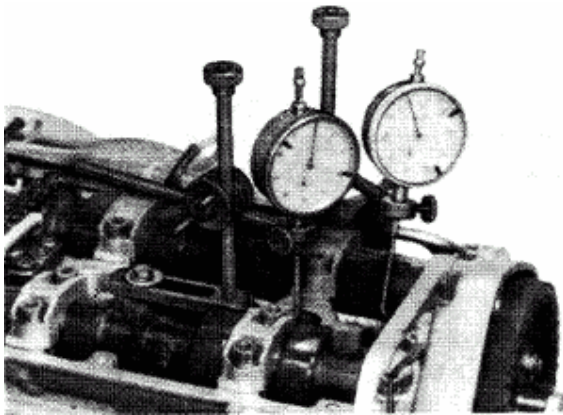

3. Remove distributor rotor and lock camshaft sprocket with 3 M 5 x 15, to prevent camshaft sprocket or camshaft turning when camshaft central bolt is slackened.

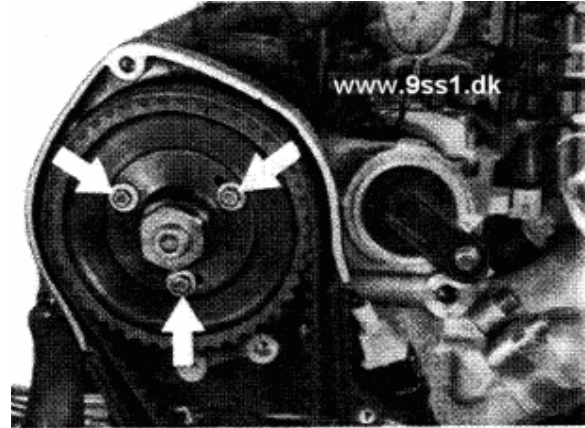

4. Slacken camshaft central bolt - note that it is essential to counter. Slacken temporary retaining bolts. Turn engine in direction opposite to direction of rotation until camshaft sprocket reaches stop inside feather-key groove

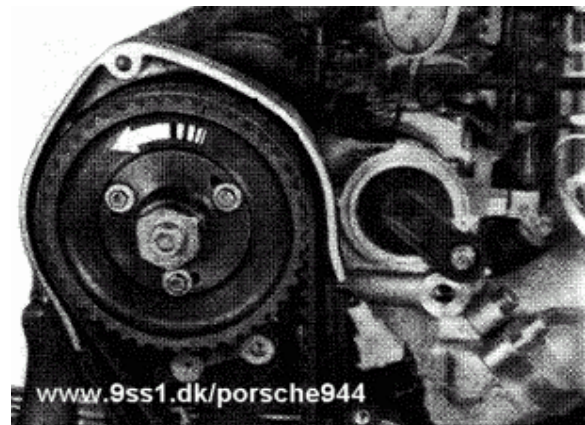

5. Tighten temporary retaining bolts (6 Nm, 4.4 ftlb) and central bolt (approx. 40 Nm, 30 ftlb).

6. Turn the engine in the direction of rotation until piston reaches its upper limit of travel.
7. Set dial gage of cylinder 1 intake-valve hydraulic tappet to 0.
8. Turn crankshaft past ignition TDC (cylinder 1) while observing cylinder 1 intake-valve dial gage. Turn engine until gage shows 1.4 +/- 0.1 mm lift.

**Note:**

Do not turn engine in direction opposite to direction of rotation.

9. Slacken central bolt and temporary retaining bolts; while doing so, ensure that the reading of 1.4 + 0.1 mm on the dial gage is not changed.
10. Now turn crankshaft slowly until dial gage shows that piston has reached the upper limit of travel. With the crankshaft in this position, the camshafts are at ignition TDC for cylinder 4.

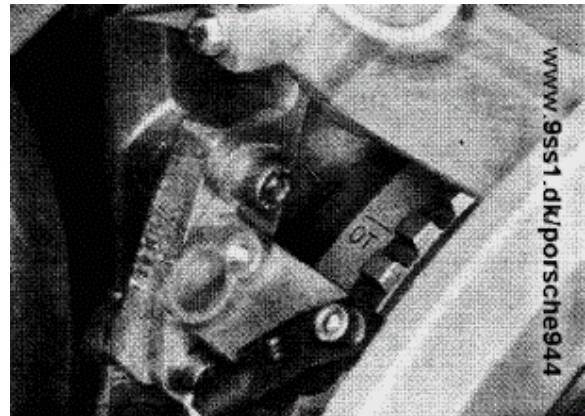

11. Tighten temporary retaining bolts and central bolt. Tightening torque of central bolt: 65 - 70 Nm (48 - 52 ftlb).
12. Recheck by turning crankshaft through another 2 turns and checking setting.
13. Remove temporary retaining bolts and install distributor rotor.

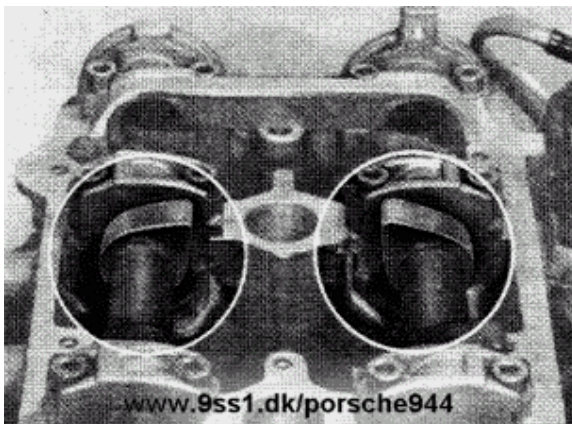

## Checking or adjusting camshaft setting for Model 89 onward

### Engine type M 44.41 (3.0 l)

#### Note

The timing has changed with installation of new camshafts for engine type M 44.41 (3.0 l) for Model 89 onward.

#### Setting

Inlet valve cylinder 1  
Testing and adjusting value **0.75 +- 0.1 mm**

The camshaft is adjusted according to the same procedure as described on Page 15 - 102.

## Applying the TDC mark on the camshaft sprocket

Engine type M 44.40 / 41 (3.0 l)

### Note

Camshaft sprockets available from the spare parts department do not have a TDC mark. This TDC mark is applied after the camshaft timing has been set on the new engine.

1. Position the new camshaft sprocket over the old sprocket and transfer the TDC mark to the new sprocket using a color pencil.
2. Fit new camshaft sprocket and adjust camshaft timing as described in the Repair Manual, page 15-102 to 104.
3. After operation 12, page 15-104, has been carried out, engrave the TDC mark in its final position on the new camshaft sprocket using a three-square-file as described on page 15-102, Fig. 1.

TOOLS - REMOVING AND INSTALLING CAMSHAFTS AND CYLINDER HEAD,  
DEGREES-OF-TURN METHOD OF TORQUING (16-VALVE ENGINES)

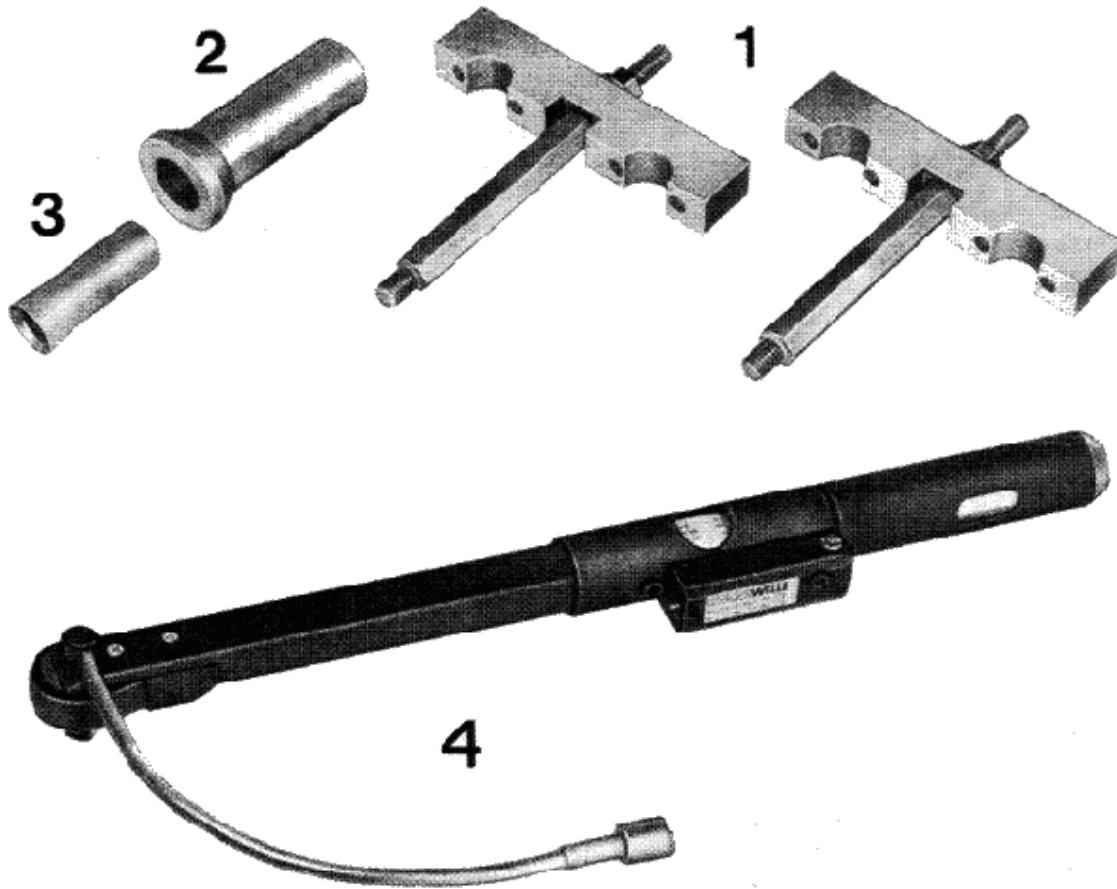

No.	Description	Special Tool	Remarks
1	Assembly bridges for installing camshafts	9248	In conjunction with clamping bolt from Special Tool 9226
2	Pressure piece for sealing ring	9234	
3	Assembly drift for sealing ring	9233	
4	Angle reader		Commercially available e.g. Stahlwille No. 715/20



## REMOVING AND INSTALLING CAMSHAFTS AND CYLINDER HEAD

### Removing:

1. Align lifting-platform pads beneath jacking points and raise car.
2. Place protective covers on fenders.
3. Disconnect ground lead from battery
4. Disconnect breather hose for toothed-belt cover from rear of lower section of air filter. Detach entire filter assembly and remove.
5. Remove air-flow sensor and disconnect support (M 8 bolt) from intake manifold.
6. Remove throttle-valve actuating cable complete with reversing roller and holder. Remove oil dipstick. Slacken hose clamps at intake manifold, brake booster and breather hose and remove.



5. Remove air-flow sensor and disconnect support (M 8 bolt) from intake manifold.

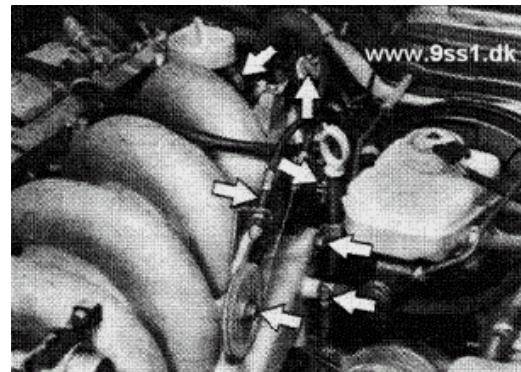
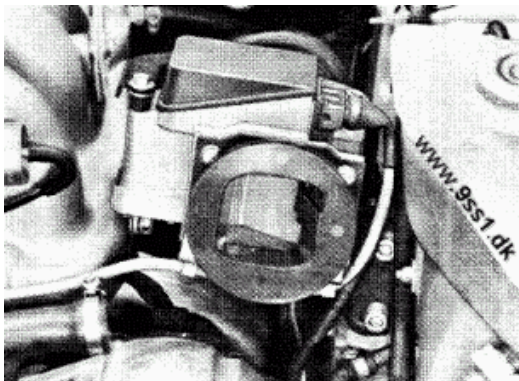

7. Remove cover of fuel-distribution pipe. Slacken hose clamp for fuel return line and disconnect hose. Disconnect fuel feed while countering.

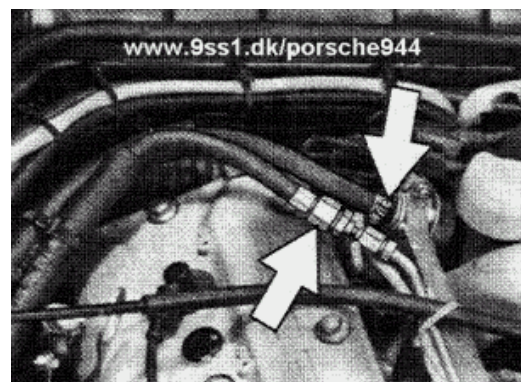

8. Disconnect vacuum hose, fuel-line-pressure damper and fuel-distribution pipe from intake manifold, disconnect plug from idle actuator, remove fuel rail with injection valves and place to one side.

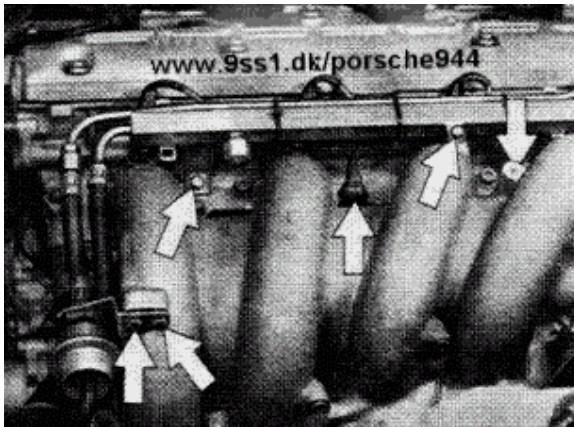

9. Disconnect throttle-valve switch connector. Unbolt intake manifold from cylinder head and remove.
10. Remove engine underguard. Open coolant drain plug and catch coolant in suitable container.
11. Detach exhaust at exhaust-manifold flange.

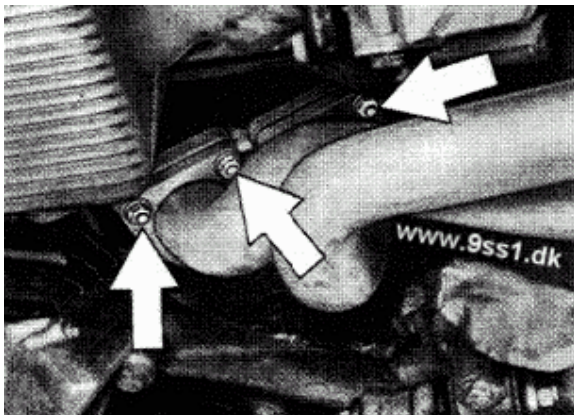

12. Pull off spark-plug caps and remove distributor cap. Slacken hose clamp at ATF reservoir.
13. Unbolt and remove upper and lower toothed-belt covers, front camshaft sprocket bracket and cylinder-head cover.
14. Turn engine in direction of rotation until cylinder 1 ignition TDC is reached.

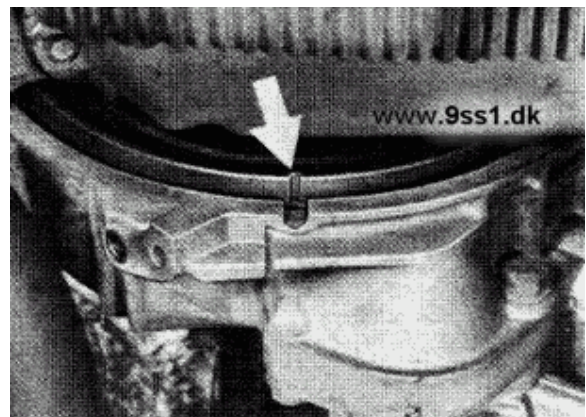
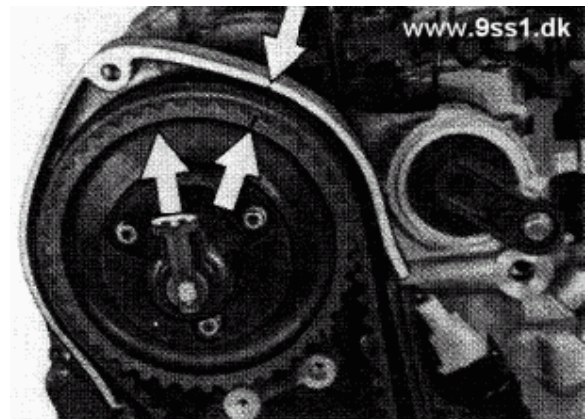



15. Relieve tension of camshaft toothed belt by slackening nut A and bolt B, pressing toothed-belt tensioner against the pressure of the spring with Special Tool 9200 and removing toothed belt from camshaft sprocket.

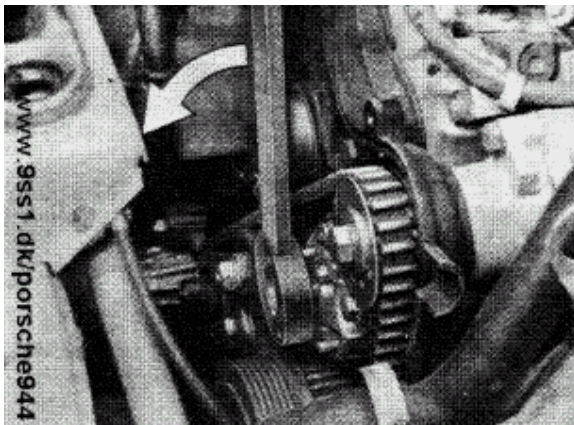
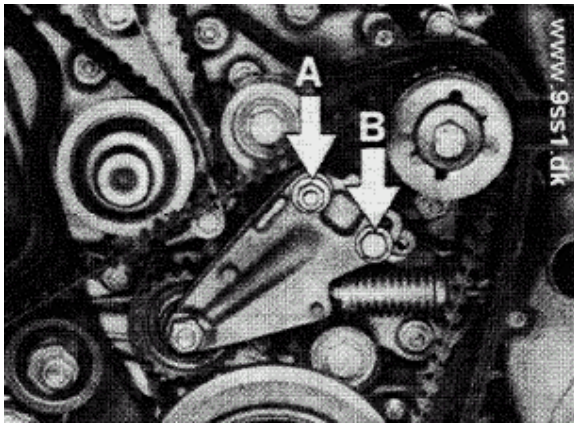

16. Remove distributor rotor. Insert 3 temporary retaining bolts M 5 x 20 to hold camshaft sprocket to avoid upsetting basic camshaft setting when camshaft central bolt is slackened.

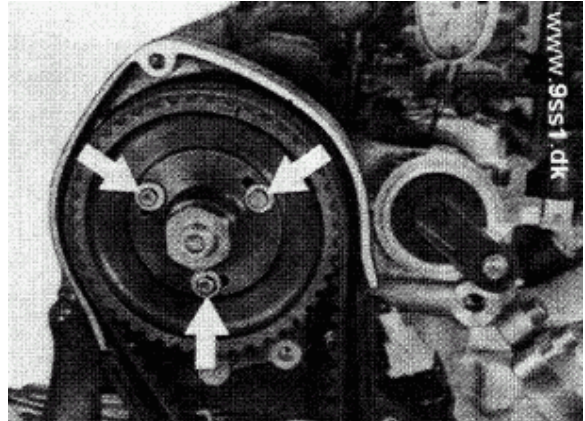

17. Slacken central bolt while countering. Remove camshaft sprocket.
18. Remove rear bracket.
19. Unbolt and remove chain tensioner.

**Note:**

Chain-tensioner plunger is spring loaded. When removing, compress plunger and after removal hold in this position with a piece of wire or a retaining clamp.



20. Remove bearing cover from cylinders 1 + 3.

Hold both camshafts in the bearings with Special Tool 9226. Undo and remove front double bearing bridge and bearing cover.

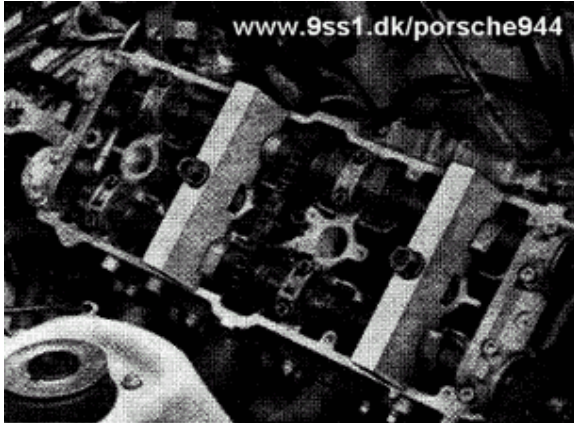

87 - 422

### Note

If oil has been mixed with water, the cylinder head must be subjected to a thorough visual inspection (hairline fractures). At the same time, check the coating system for leaks.

### Use

test unit VW 1274 above the expansion tank for the teak test (max. 1 bar). The camshaft cover must be removed for visual inspection.

### Note

The rear double bearing bridge may remain on the cylinder head.

21. Undo Special Tool evenly, remove both camshafts with chain and lay together on one side.
22. Undo cylinder head. Undo in sequence: from outside to inside.
23. Remove cylinder head.

## Installing and tightening the cylinder head

### Model 87 onward Engine type M 44.40

#### Note

The cylinder head may be mounted with the engine installed.

1. Place the cylinder head gasket in the correct position.
2. Mount cylinder head  
Tightening sequence:



87/420

Opposite to undoing sequence.

### Tightening specifications for cylinder head

#### Model 87 onward Engine type M 44.40

1st stage	20 Nm
2nd stage	90° torque angle
3rd stage	90° torque angle

### Model 89 onward Engine type M 44.41 (3.0 l)

#### Note

The cylinder head has been reinforced by 20 mm in the area of the bearing surfaces for the cylinder head nuts. This has altered the tightening sequence.

### Tightening specifications

#### Model 89 onward Engine type M 44.41 (3.0 l)

1st stage	20 Nm
2nd stage	60° torque angle
3rd stage	90° torque angle

#### Note

Never use lubricant when fitting cylinder head nuts and washers. Apply a light film of engine oil to the stud thread only.

### Installing camshafts

1. Turn engine in direction of rotation by approx. 45° before ignition TDC (cylinder 1).
2. Lay intake shaft and exhaust camshaft in the timing chain.
3. Place both camshafts in the timing chain so that the cast lugs are aligned with the marked links of the chain. Oil the bearing journals and place in the bearings carefully together with the timing chain.

### Note

The distance between the marking on the intake camshaft and the marking on the exhaust camshaft amounts to 7 outer chain links; the distance between the cast lugs measures approx. 113 mm.

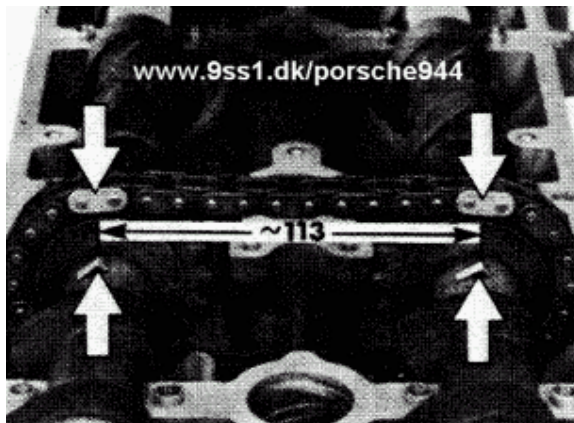

11838

4. Fasten the camshafts to the cylinder head with assembly bridges SpecialTool 9248 together with the clamping bolt of Special Tool 9226.

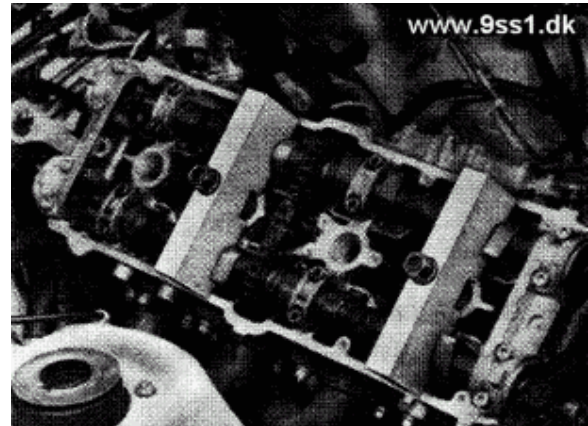

87/422

5. Install the bearing bridges and bearing cover of the camshaft. The bearing bridges and cover are production-matched to the cylinder head and must always be installed as a set. Note the identification code and pairing number. Tightening torque for bearing bridges and cover 20 Nm.

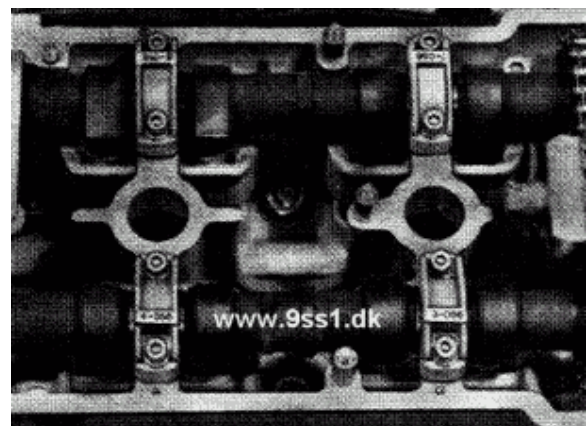

11804



11639

6. Apply Loctite 574 to the sealing surfaces of the front and rear double bearing bridges.
7. Use the assembly drift, Special Tool 9233 and pressure piece 9234 to drive the sealing ring into position at the drive end of the camshaft. Lubricate the sealing lip before assembly.



11794

### Note

The timing chain must always be replaced if the valves have been damaged by the piston as a result of a broken toothed belt. A thorough visual inspection must be made of the sprockets and chain tensioner.





### Installing Camshaft Seal

1. Place sealing washers in bearings and install bearing bridge with Loctite 574. Tightening torque 20 Nm (15 ftlb).

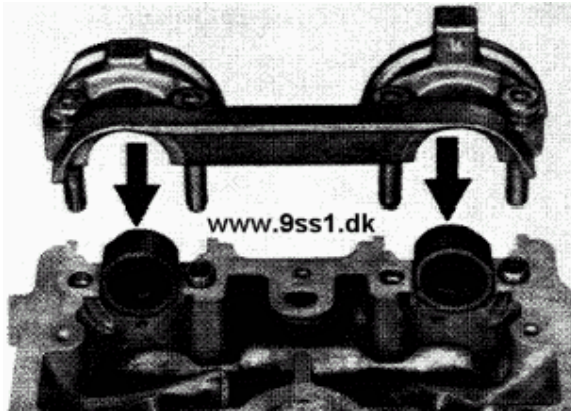

87/465

2. After torquing the bearing bridge, install sealing cover with the aid of Special Tool 9234

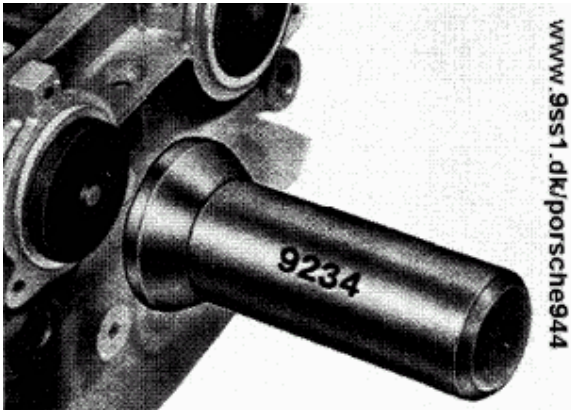

86/925

### Engine installed

#### Note:

If the sealing cover of an engine leaks with the engine installed, the procedure for installing the cover is as follows:

1. Place camshafts and sealing washers in bearing.
2. Apply Loctite 574 to bearing bridge and install. Place a 0.20 mm feeler gauge between bearing bridge and cylinder head and tighten bolts slightly by hand.

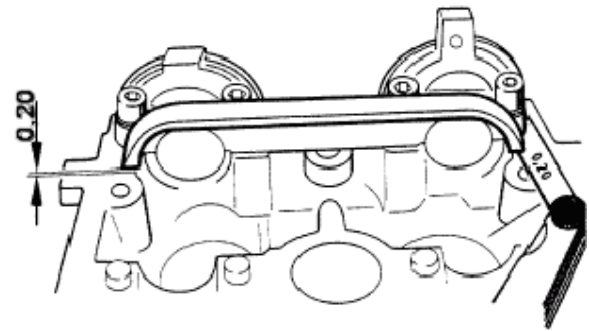

928/01

3. Apply a light film of oil to sealing cover and press on by hand. Tighten bearing bridge to 20 Nm (15 ftlb).

Camshaft specifications	Worldwide, Model 87 onward	Worldwide, Model 89 onward
Engine type	<b>944 S</b> M 44.40	<b>944 S 2</b> M 44.41 (3,0 l)
Camshafts		
Inlet shaft	944.105.277.04	944.105.277.07
Exhaust shaft	944.105.275.04	944.105.275.09
Identification code	277.04	277.07
On the rear face	275.04	275.09
Timing 1 mm stroke, zero play		
Inlet opens	4° CS    after TDC	3° CS    after TDC
Inlet closes	40° CS   after BDC	47° CS   after BDC
Exhaust opens	36° CS   before BDC	39° CS   before BDC
Exhaust closes	4° CS    before TDC	7° CS    before TDC

## REMOVING AND INSTALLING CHAIN TENSIONER

### Removing

Remove hollow screws from cylinder head and chain tensioner and remove complete with oil line and seals.

### Note:

Chain-tensioner plunger is spring-loaded. When removing, compress plunger and hold in this position with suitable retainer (improvised tool).

3. When installing the oil delivery line, install a sealing ring at both ends of the two hollow bolts. The check valve is in the chain tensioner housing. Tightening torque of hollow bolts: 10 Nm (7 ftlb)



### Installing

1. Chain tensioner can be installed without removal of retaining clamp.
2. The retaining clamp for the chain-tensioner plunger must be removed once the chain tensioner is installed.

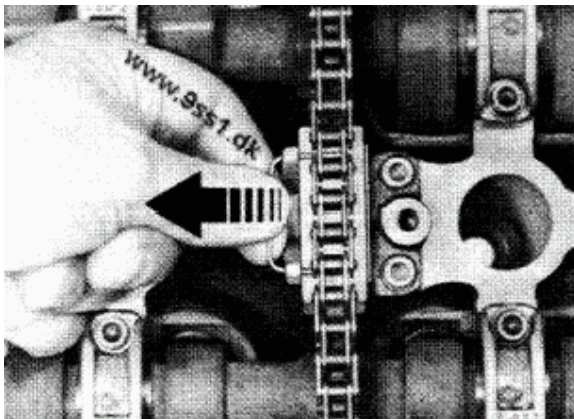

**This page are missing or blank in the book !**



## TOOLS - CYLINDER HEAD (16-VALVE ENGINES)

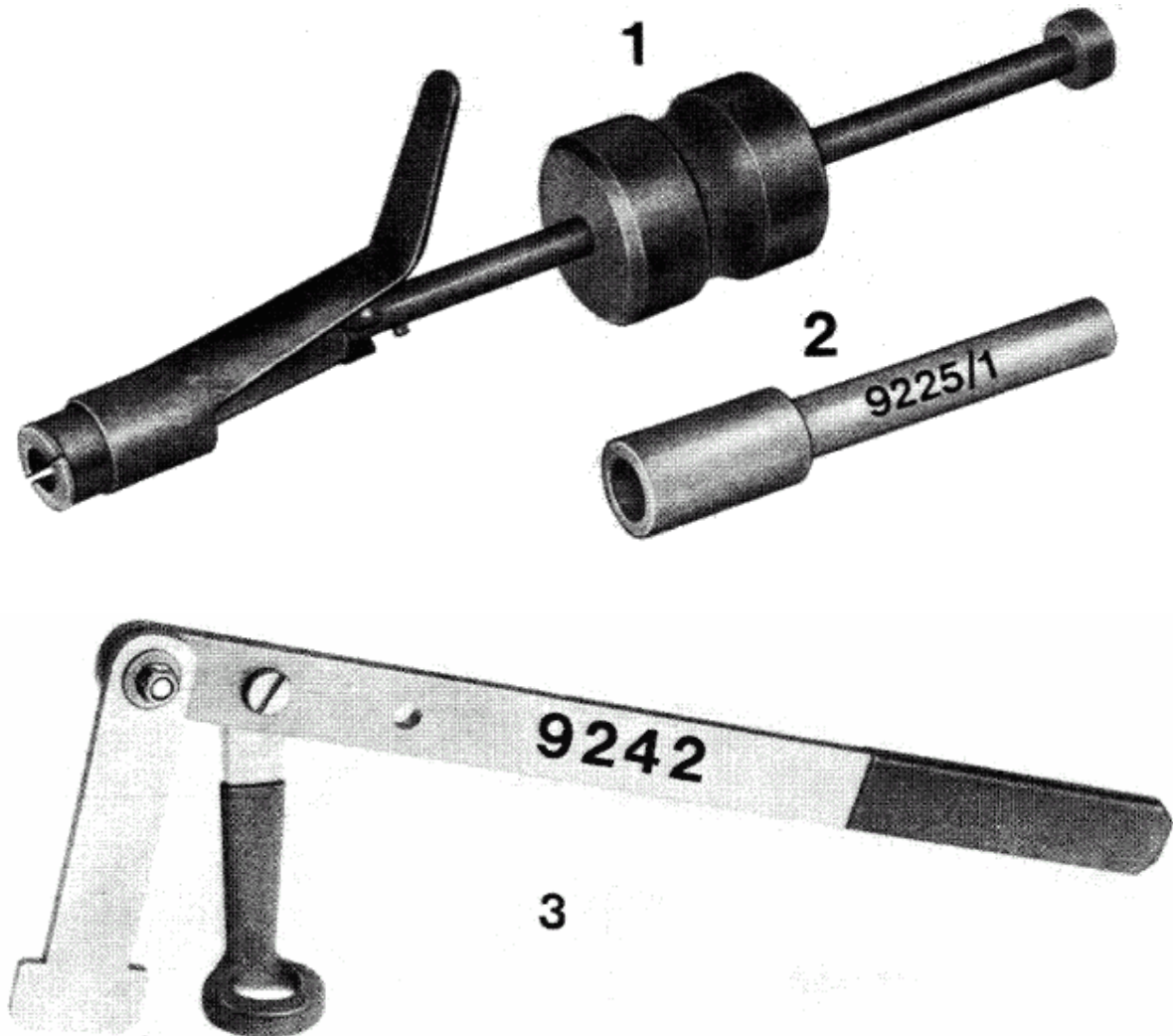

No.	Description	Special Tool	Remarks
1	Puller for valve stem seals	9237	
2	Press-in tool for valve stem seals	9225/1	
3	Valve spring assembly tool	9242	Or US 1020 + US 1020/1

DISASSEMBLING AND ASSEMBLING CYLINDER HEAD (16-VALVE ENGINES)

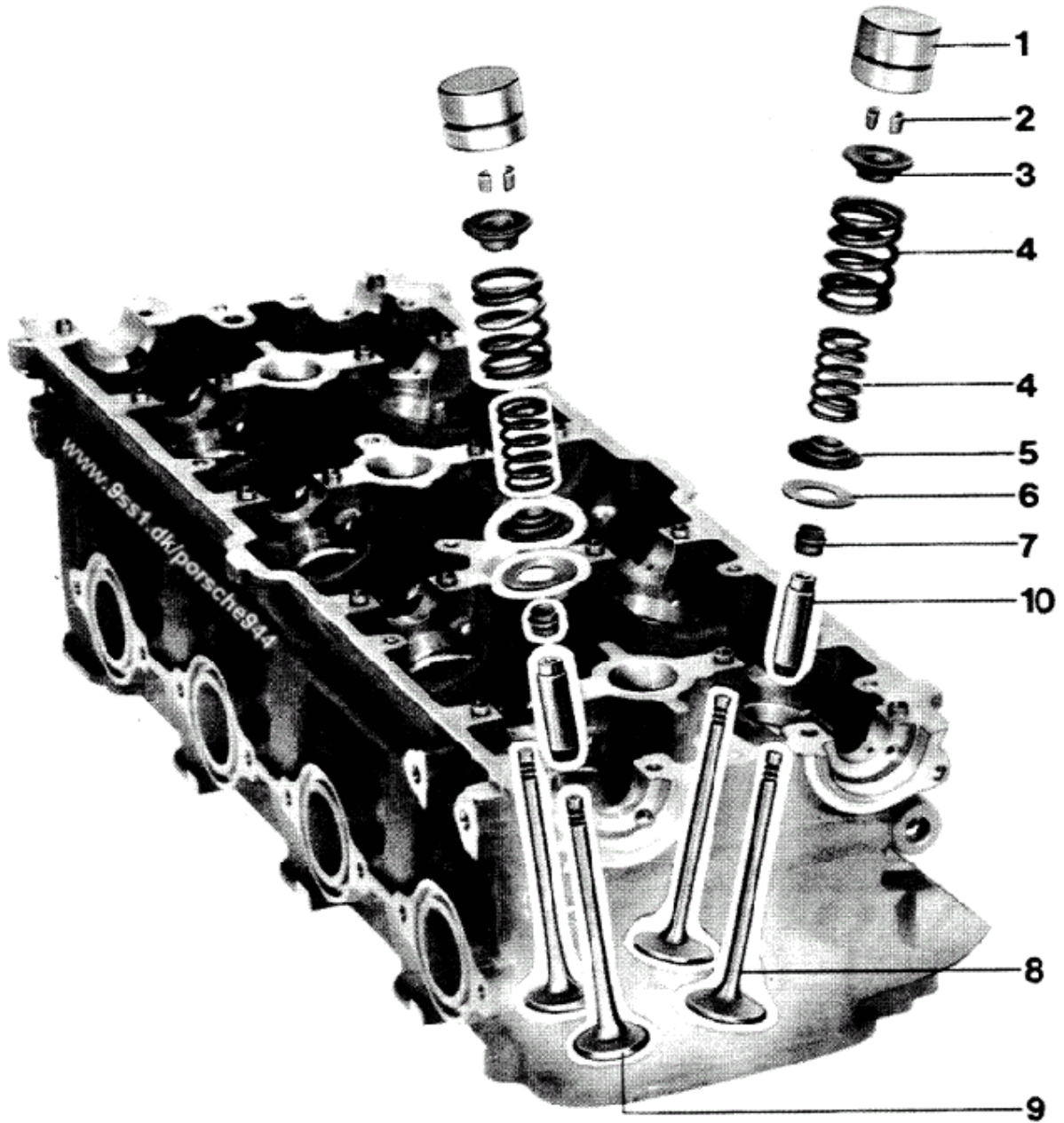

No.	Description	Qty.	Note When:	
			Removing	Installing
1	Hydraulic valve tappet	16	Withdraw with a magnet, do not mix up	Oil
2	Conical valve keeper	32		Check correct seating
3	Spring plate	16		
4	Valve spring set	16		
5	Valve spring support	16		
6	Washer	X	Note number	Redetermine if necessary
7	Valve stem seal	16		Always replace, drive in with press-in tool, Special Tool 9225/1, oil sealing lip, use drift
8	Intake valve	8		Oil valve stem
9	Exhaust valve	8		Oil valve stem
10	Valve guide	16		

## Cylinder Head (16 Valves)

## Removing and installing valve springs

## Tools

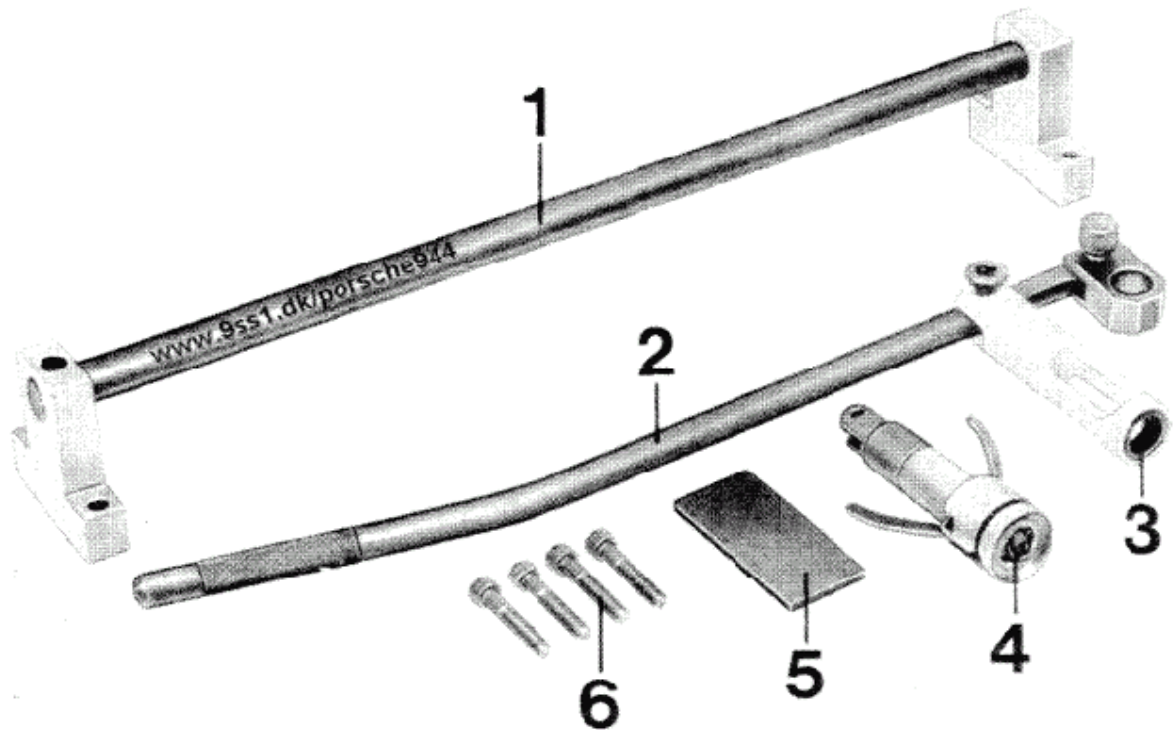

87/927

No.	Description	Special tool	Remarks
1	Assembly bridge		Supplier: Sauer Hamburg
2	Lever arm		Supplier: Sauer Hamburg
3	Magnetic removal head		Supplier: Sauer Hamburg
4	Assembly head		Supplier: Sauer Hamburg
5	Spacer		Supplier: Sauer Hamburg
6	Screws		Commercially available M 8 x 40

**Note**

If the cylinder head is installed, the lever arm must be angled more acutely.

### Notes on assembly

#### Remove and install the valve springs with the special tool supplied by Sauer

1. Mount the assembly bridge on the cylinder head. Secure the cylinderhead to the work bench with a screw clamp to prevent tilting.
2. Fasten the magnetic removal head to the lever arm. Press the valve spring together in the cylinder head and loosen the conical valve keeper from the valve shaft with a small screwdriver.

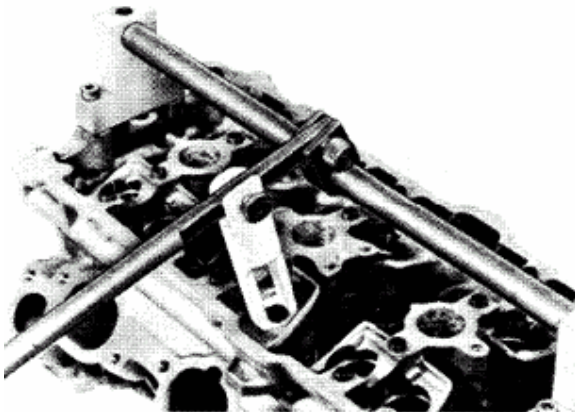

87/926

3. All valve spring components can be pulled out with the magnetic removal head.
4. Fasten the assembly head to the lever arm. Prags the tensioning arms together and place the conical valve keepers in the assembly head.

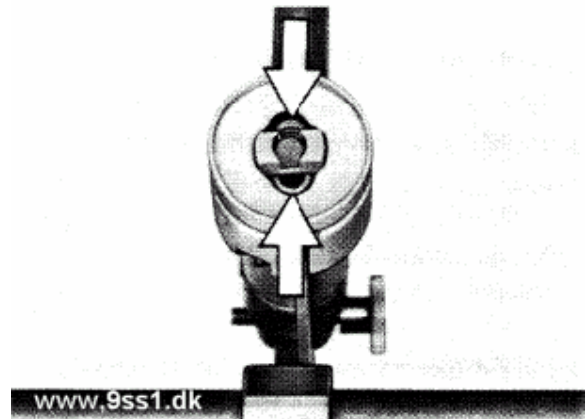

87/926

5. Place washer, valve spring support, valve springs and spring plate in the cylinder head and prags together with the assembly head. A small up and down movement of the lever arm allows the conical valve-keepers to lock into place. This movement also positions the conical valve keepers automatically in the correct location.

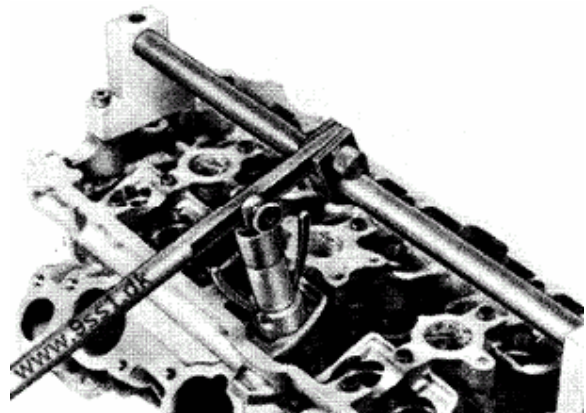

87/925

6. When the conical valve keepers are locked in, the tensioning arms of the assembly head point outwards.



## Remachining cylinder-head mating face

### Checking cylinder head for distortion

Use a feeler gage and a straight edge or a precision straight edge to check the mating face of the cylinder head for distortion.

Permissible mating-face unevenness: 0.05 mm

Cylinder heads with distorted mating faces can be remachined and reused. Permissible roughness after finishing: 0.03 mm.

### Remachining cylinder head

Do not remove more material from the cylinder head mating face than is necessary to achieve a smooth surface. Max. machining depth 146.6 mm.

Note on machining mating face:  
Peak-to-valley = 0.015 mm

If the new-dimension tolerance is exceeded during machining, a cylinder head gasket with a thickness of 1.4 mm must be fitted.

Size new = 147 ± 0.1 mm  
Size worn = 146.6 mm

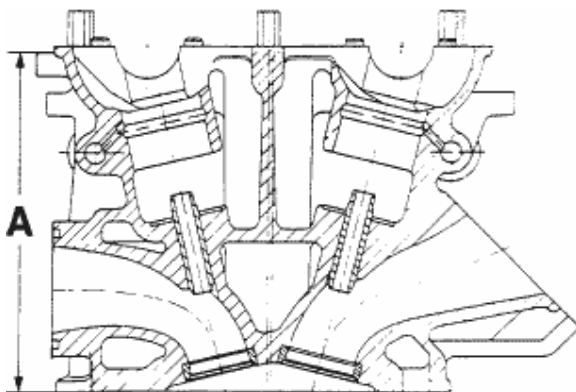

1126-15

### Cylinder head refacing dimension and identification

New dimension : 147 ± 0.1 mm  
Gasket : 1.1 mm  
Identification : none

Refacing dimension : 146.8 to 146.6 mm  
Gasket : 1.4 mm  
Identification : N

### Identification "N"

To be embossed on exhaust side, between cylinders no. 2 and 3, on the casting lug below the sealing face of the cylinder head cover.

**Punch character height "N" = 6 mm**



## NOTES ON ASSEMBLY

## REMOVING AND INSTALLING VALVE SPRINGS

Cylinder head removed

Remove and install valve springs with US 1020 + US 1020/1.

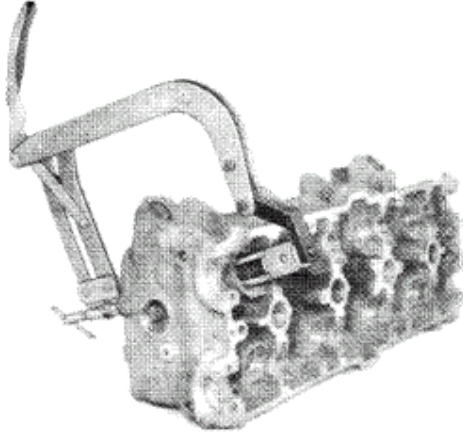

## REMOVING AND INSTALLING VALVE SPRINGS

Cylinder head installed

Remove and install valve springs with Special Tool 9242.

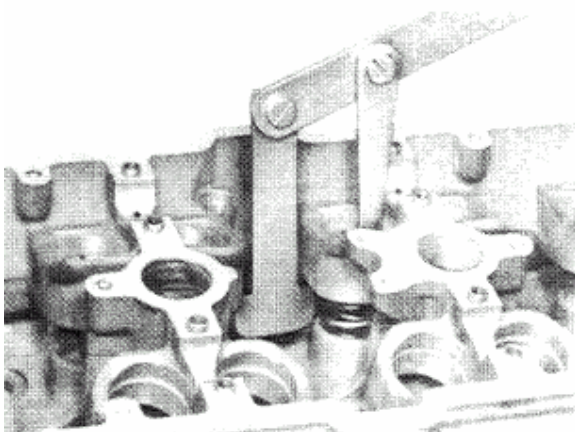

## REMOVING VALVE STEM SEAL

Remove valve stem seal with Special Tool 9237.

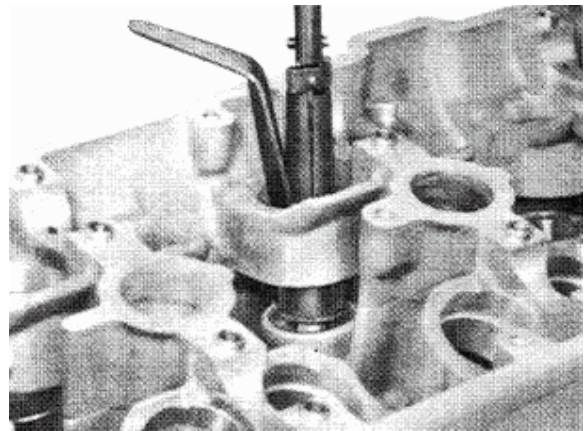

## INSTALLING VALVE STEM SEAL

**Note:**

Always remember to place an 1 mm thick washer on the cylinder-head face before installing the valve stem seal.

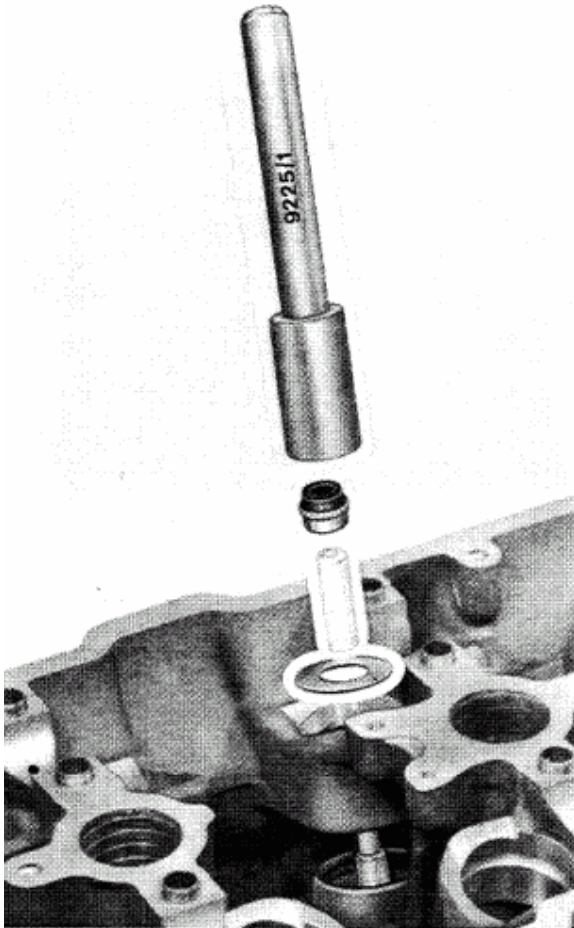

1. Lubricate valve stem and install shaft. Place an 1 mm thick washer on cylinder-head face. Push drift over valve stem. Lubricate sealing lip of valve stem seal and position on drift. Using Special Tool 9225/1, carefully and gently push seal as far as it will go onto valve guide.

2. The valve stem seal is correctly seated when Special Tool 9225/1 and washer make contact.

Note:

The assembly drifts are available as spare parts.





### Checking the valve guides

1. Clean the valve guides thoroughly.
2. Use a new valve to measure the tilt play.
3. Mount bar gate holder VW 387 on the cylinder head. The dial gaugemust be aligned parallel to the valve disk.

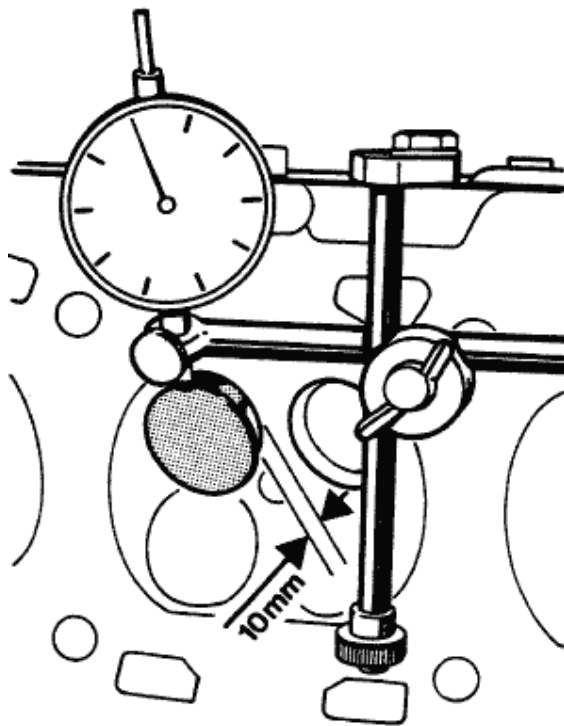

15/2

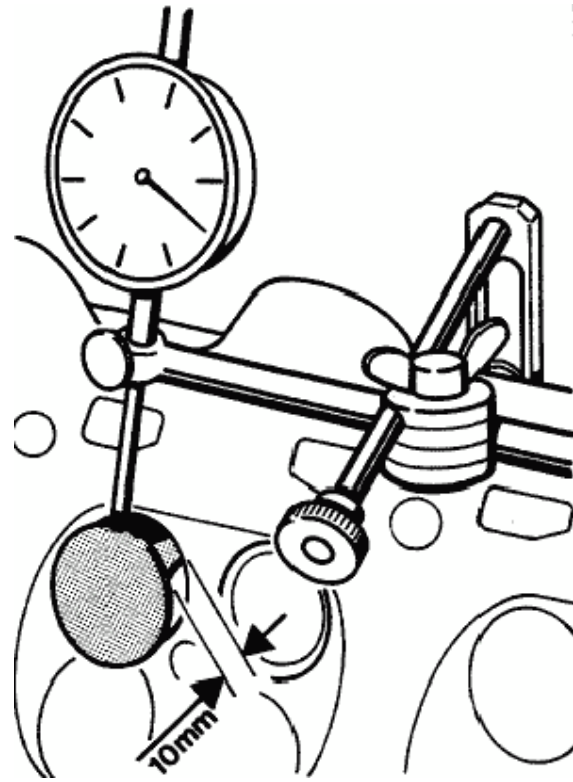

15/3

4. The tilt play is measured with 10 mm valve stroke (distance between the valve disk and valve seat). Wear limit for intake and exhaust guides = **0.80 mm**.





## Replacing valve guides

## Tools

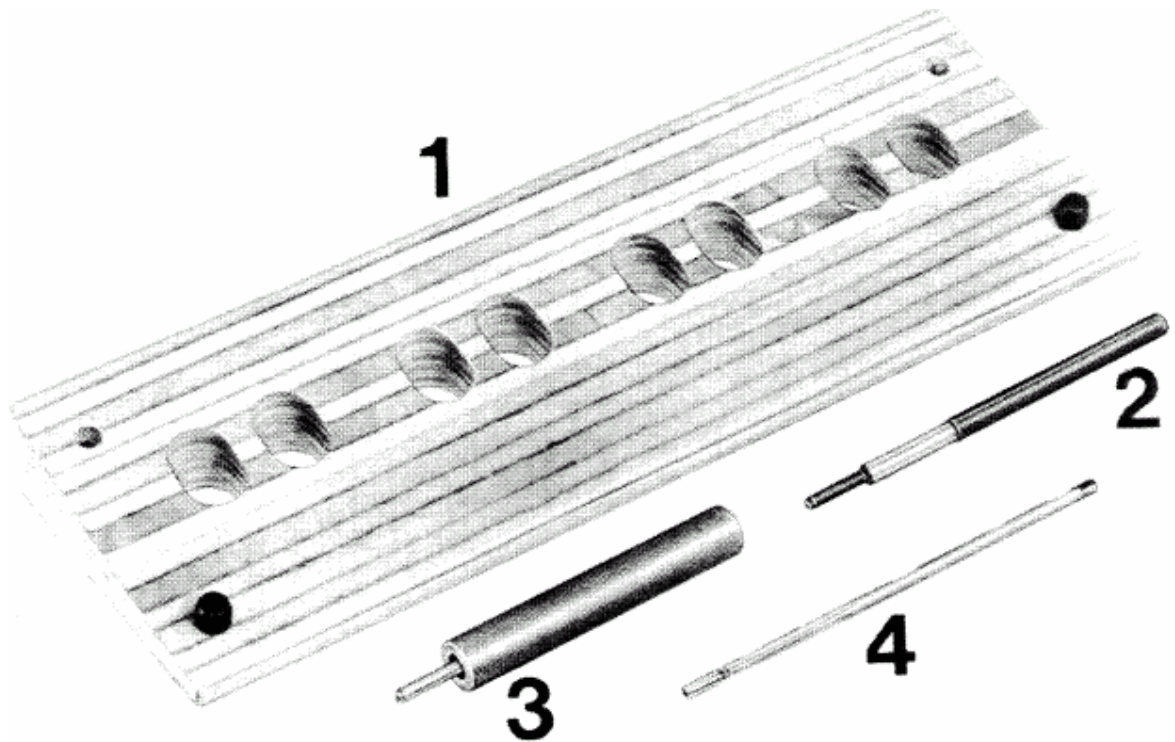

87/918

No.	Description	Special tool	Remarks
1	Ejection base		See drawing
2	Plunger		See drawing
3	Plunger		See drawing
4	Reamer	3120	VW special tool

**Drawing**

Plunger to press out the valve guide

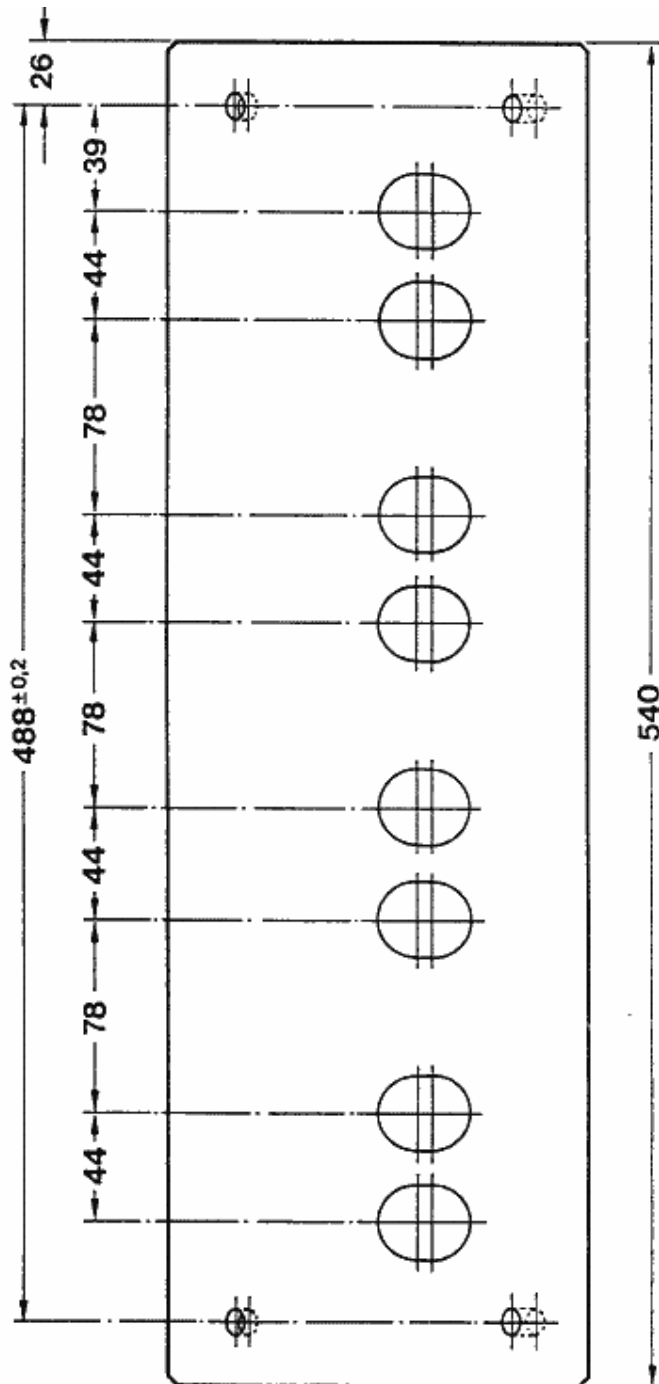

Material: Wood

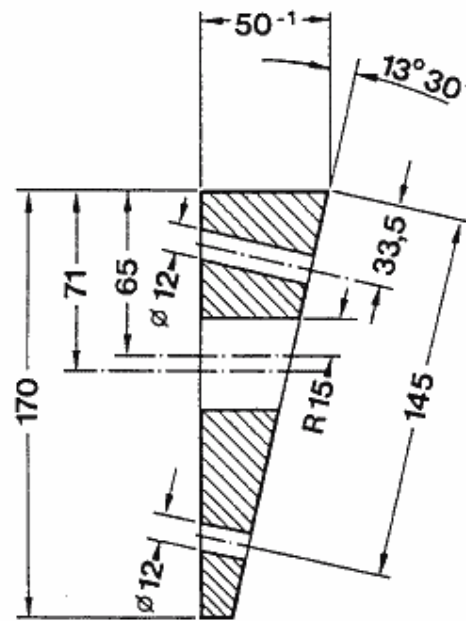

Material: St 37

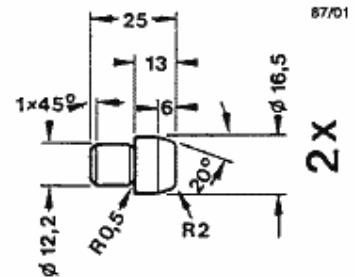

**Drawing**

Plunger to press out the valve guide

Plunger to press in the valve guide

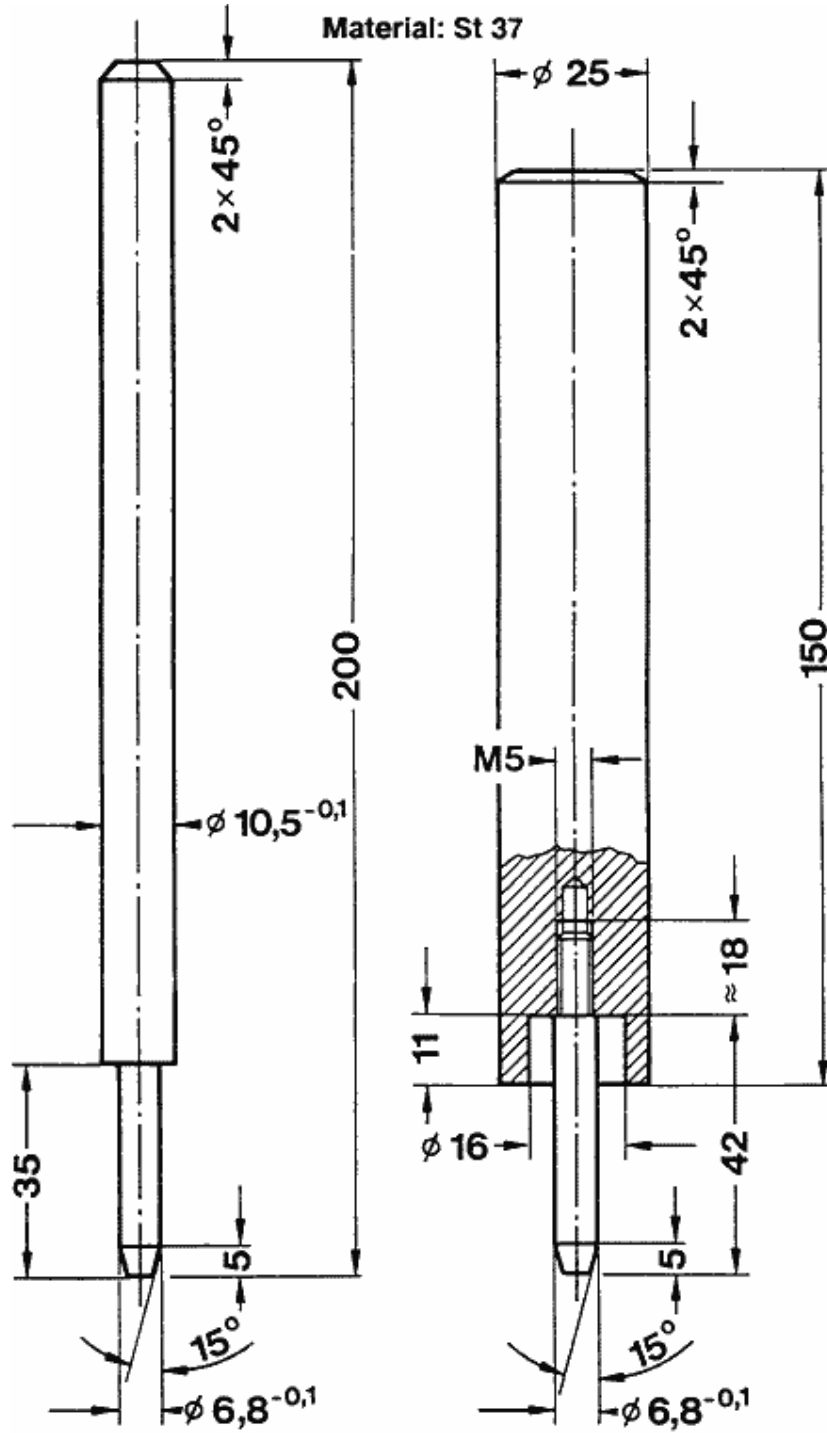

### Replacing the valve guides

1. Clean and inspect the cylinder head. It is inexpedient to replace the valve guides in cylinder heads where remachining is no longer possible on the valve seats or sealing areas.
2. Lay the cylinder head on the ejection base.
3. Press out the valve guides from the camshaft side to the combustion chamber side with a press.



87/921

4. Measure the bores in cylinder with an internal measuring caliper.



87/919

5. Machine the SP valve guide Part No. 944 104 327 51 (outer diameter 11.26 mm) accordingly. The pressing must amount to 0.06 - 0.8 mm for intake and exhaust valve guides

#### Example

Bore in the cylinder head measures 11.020 mm. Machine the outside diameter of the SP valve guide accordingly to 11.080 or 11.10 mm.

#### Note

A 1 mm thick washer must always be placed on cylinder-head face before installing the valve guide.

6. Heat the cylinder head up to 170 °C (338 °F). Apply a film of tallow to the valve guides. Position with a light knock, align and from the camshaft side, press into the cylinder head as far as the stop with a plunger.

#### Attention

*The temperature of 170 °C (338 °F). must only be maintained for a maximum of 90 minutes.*

7. Ream the valve guides with Special Tool 3120

Proceed as follows:

The valve guides must always be reamed with "petroleum" lubricant. Withdraw the reamer regularly to remove chips. Then finish-ream the bore again with a dry reamer.

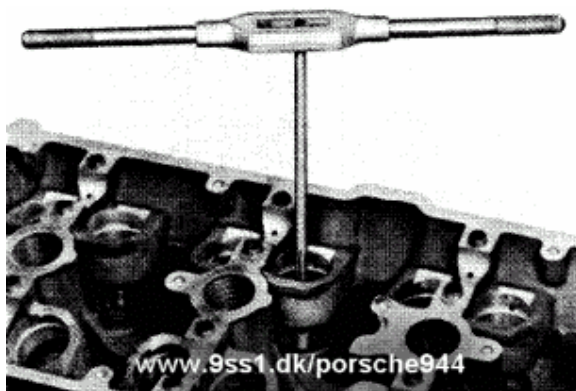

87/920

8. The valve seat rings must be remachined after replacing the valve guides. It is not enough to grind in the valves with grinding paste



### Checking the valve seat wear limit

1. The valve seats in the 4-valve cylinder heads can be remachined. At the same time, the wear limit dimension must not be exceeded as this would mean that the hydraulic valve tappets may no longer function correctly.

Wear dimension	Intake valve	Exhaust valve
As from Model 87	44.4 mm	43.4 mm

2. This is measured with the valve to be installed, from the end of the valve shaft to the contact area of the valve spring support in the cylinder head.



11841

3. The valve must be held firmly on the valve seat for measurement.





**Checking and remachining valve seats**

**Visual inspection**

1. Check that the valve seat sits securely in the cylinder head.
2. Check the contact pattern. If the valve does not make contact over the entire surface of the valve seat, remill the seat slightly.

3. Valve seat milling cutter. e.g.

- Neway 234 45°
- Neway 213 60°

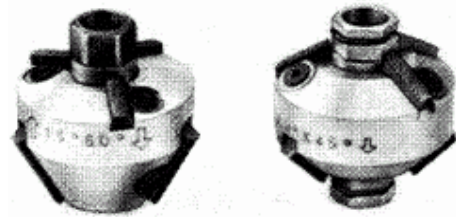

**Remachining**

1. Valve seats can be remachined, for example, with the Neway valve miller or the Hunger valve seat tuning tool.
2. Remachine the valve seats with a 45° seat milling cutter. Then machine the seat to the prescribed width with a 60° correction milling cutter. A 30° correction milling cutter is not required.

11862

Intake seat width 1.5 mm

Exhaust seat width 1.8 mm



11865

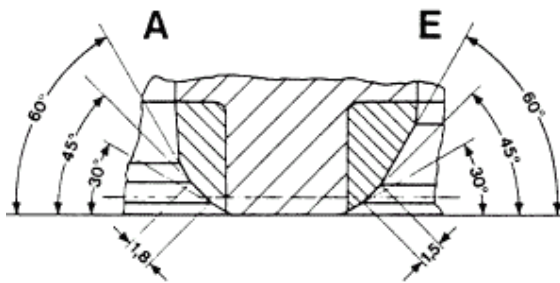

1/05



11864

4. Valve seat turning tool, e.g. Hunger VDSNL 1/45 I.K.

Valve dimensions

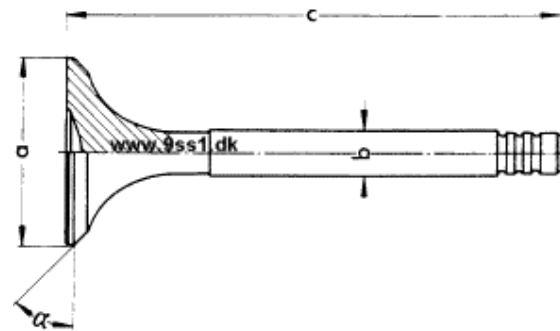

15/127

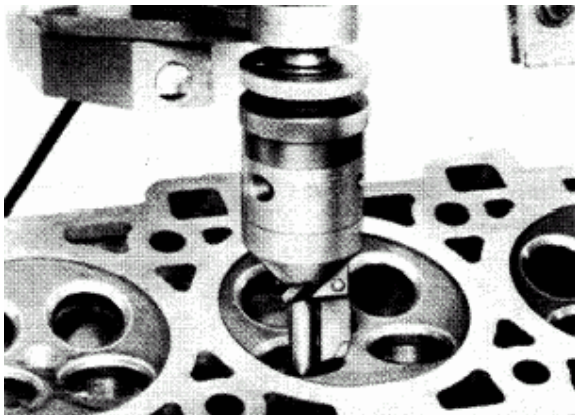

85/151

5. After milling, grind in the valve seats lightly with grinding paste. Check the contact pattern of the valve seat surface.

Valve dimensions 944 S

As from Model 87

Engine type M 44.40

Dimension	Intake	Exhaust
a	37 mm	33 mm
b	6.97 mm	6.94 mm
c	114.7 mm	113.7 mm
$\alpha$	45°	45°



### Checking and adjusting installation length of valve springs

#### Valve springs, Model 87 onward Engine type M 44.40

#### Note

When selecting the valve-spring seat (own construction) always ensure that the valve-spring seat is  $2.0 + 0.2$  mm thick.

2. Shorten the auxiliary spring to approx. 50 mm to ease assembly.

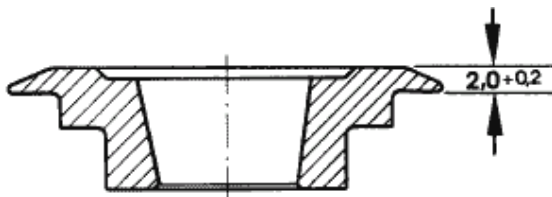

1/03

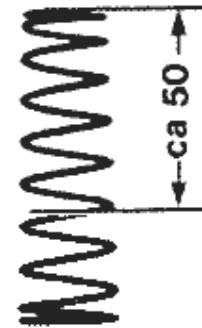

86/927

Tool (own construction)

Valve spring Sp No. 944.105.467.03

Auxiliary spring Sp No. 928.107.171.01

1. Machine a recess of approx. 10 mm width into valve-spring seat. Only install valve-spring seat for measurement.

3. Install valve and hold in valve seat. Insert washer, valve-spring seat, auxiliary spring and valve-spring seat with machined recess.

4: Use Special Tool 9242 to fit the conical valve keepers.

5. Using a depth gauge, measure from the top surface of the valve-spring seat, vertically downwards through the recess to the outer spring contact surface.



86/930

### Valve spring, Model 89 onward Engine type M 44.41 (3.0 l)

#### Note

A new type of valve spring has been installed in engine type M 44.41 (3.0 l) from Model 89 onward. The installation length remains unchanged.

#### Installation lengths

Inlet valve	<b>38.0 + 0.5 mm</b>
Exhaust valve	<b>37.0 + 0.5 mm</b>

Carry out working procedure *Checking and adjusting installation length of valve springs* as described on Page 15 - 133.

#### Installation length

Inlet valve	<b>38.0 + 0.5 mm</b>
Exhaust valve	<b>37.0 + 0.5 mm</b>

6. The installation length can be adjusted using shims.
7. The valves must not be mixed up again after measurement.

## CHANGING ENGINE OIL AND ENGINE OIL FILTER (16-VALVE ENGINES)

Preconditioned:

Engine at operating temperature.

1. Unscrew and remove oil filler cap.
2. Unscrew oil drain plug from oil pan and drain engine oil.



3. Remove oil filter with oil-filter wrench, Special Tool 9204. Catch remaining oil.



4. Clean drain plug and never forget to replace seal. Tightening torque: 50 Nm (37 ftlb).
5. Lightly oil gasket of oil filter, screw in by hand until gasket makes contact, and turn through one further turn to tighten. To ensure that filter is correctly seated, recheck with oil-filter wrench. Tightening torque (for guidance): 20 Nm (14 ftlb).
6. Pour in engine oil, run engine to operating temperature and check for leaks.
7. Check oil level with engine switched off.



## Removing and installing the pressure reducing valve

### Engine type M44.40

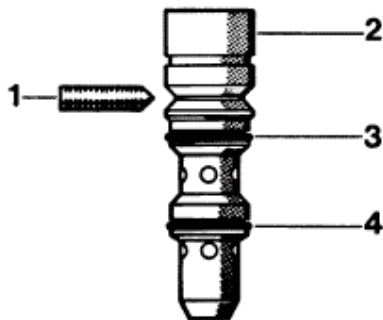

80/17

- 1 - Set screw  
Pressure reducing valve
- 2 - O-ring
- 3 - O-ring
- 4 -

1. Remove the cylinder head cover and undo the set screw by 2 turns.
2. Ease the pressure reducing valve out of the seat with a screwdriver and take it out upwards.
3. Replace the O-rings and apply a light film of oil before installation.
4. Tighten the set screw carefully until you can feel the stop, then turn back by 45°. The screw must not be loose. (Microencapsulated, renew if necessary).



## MIXING TABLE FOR COOLANT

(Average values)

Antifreeze effective to	Antifreeze Agent	Water	Antifreeze Agent	Water
- 25° C	40%	60%	3.1 l	4.7 l
- 30° C	45%	55%	3.5 l	4.3 l
- 35° C	50%	50%	3.9 l	3.9 l

CHECKING HEATING AND COOLING SYSTEM  
FOR LEAKS (16-VALVE ENGINES)

1. Visual inspection for leaks.
2. Check routing of cooling and heating hoses, look for signs of porosity, swelling, cracks and rubbing. Replace damaged hoses.
3. Retighten hose clamps.







### REPLACING FUEL FILTER (16-VALVE ENGINES)

1. Disconnect fuel lines, always counter when slackening threaded connectors. Catch fuel exiting from lines in a suitable container.
2. Slacken retaining clamp and remove fuel filter.

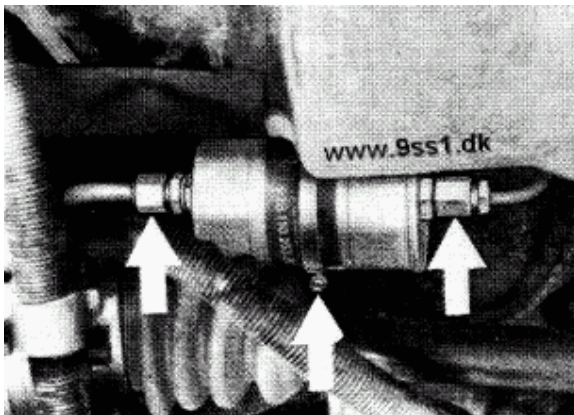

3. Install new filter. Direction of flow is as indicated by the arrow.



### CHECKING FUEL AND INJECTION LINES FOR LEAKS AND LOOSE CONNECTIONS

1. Visual inspection for leaks.
2. Retighten union nuts and hose clamp.

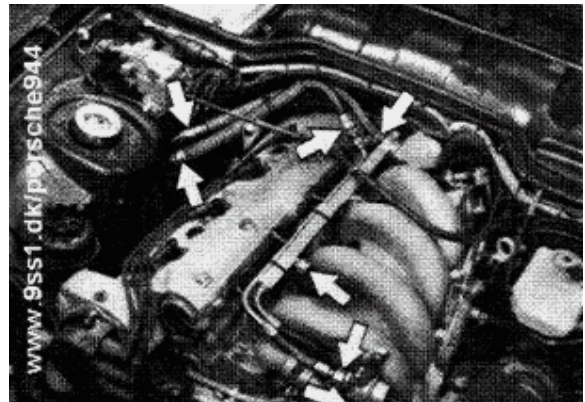

## CHECKING DELIVERY RATE OF FUEL PUMP

Precondition:

Fuel filter and power supply OK.

Allow fuel to flow into graduated cylinder for 30 seconds. Minimum delivery rate is 850 cc/30s, if necessary replace fuel pump.

1. Unbolt fuel return hose from pressure regulator. Connect a length of commercially available fuel hose and place one end in a graduated cylinder (capacity approx. 1500 cc).

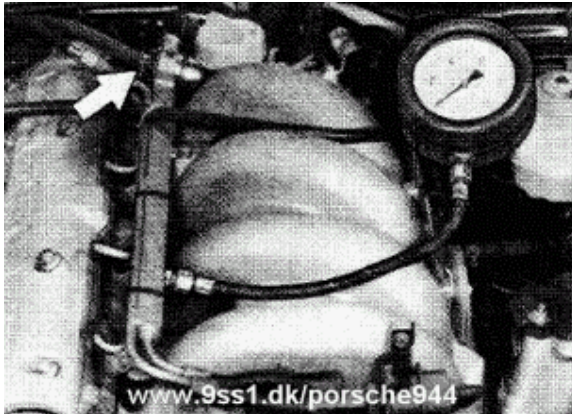

2. Disconnect DME relay from central electrics and, using a length of wire, jumper terminals 30 and 87 b.



FUEL SYSTEM LINE ROUTING (16-VALVE ENGINES)

'87 MODELS ONWARD

ENGINE TYPE M 44.40

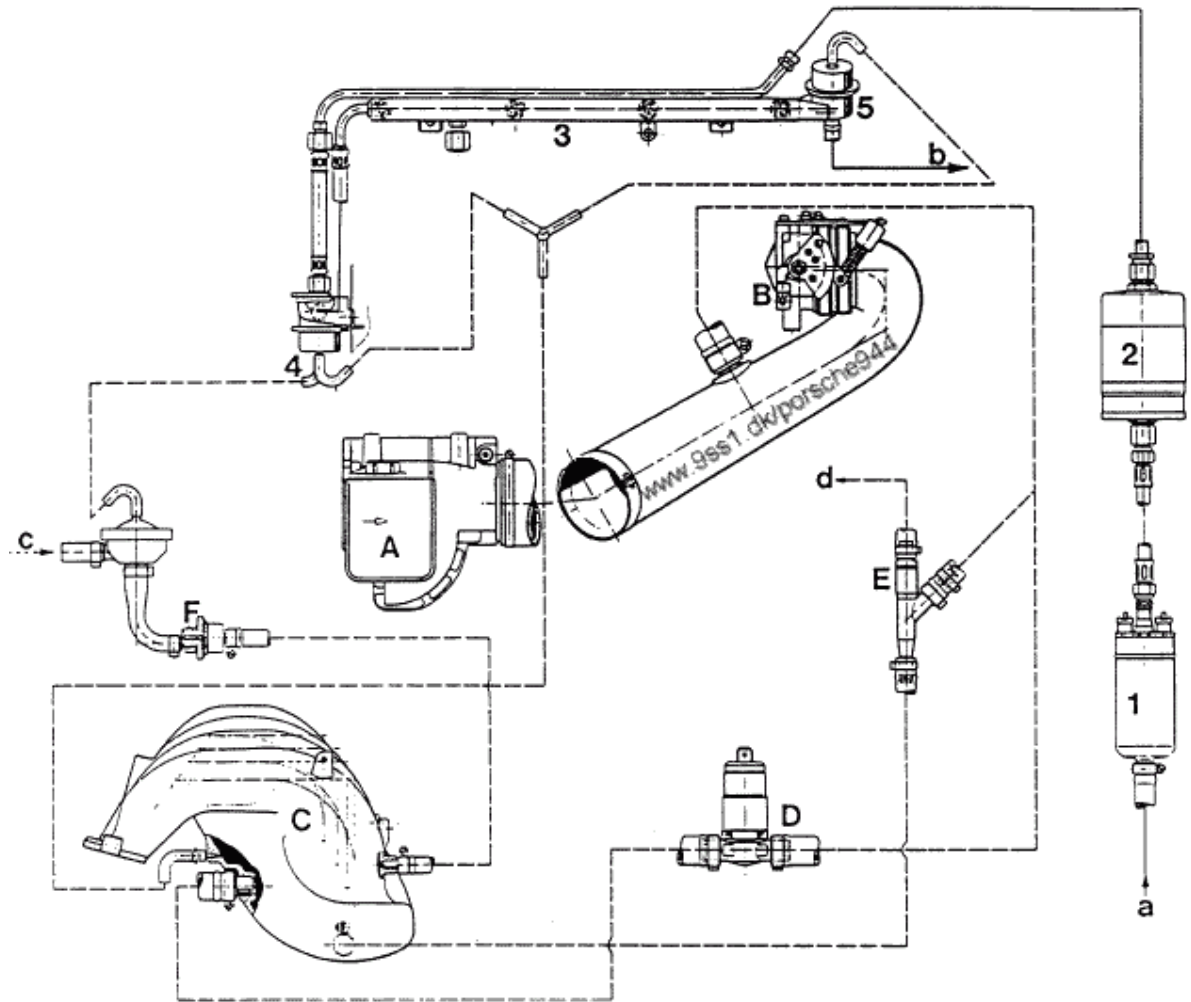

- |                       |                                |                                    |
|-----------------------|--------------------------------|------------------------------------|
| 1 Fuel pump           | A Air flow sensor              | a from fuel tank                   |
| 2 Fuel filter         | B Throttle valve housing       | b to fuel tank                     |
| 3 Fuel collector tube | C Intake tube                  | c from activated charcoal canister |
| 4 Pressure damper     | D Idle actuator                | d to brake unit                    |
| 5 Pressure regulator  | E Intake jet pump              |                                    |
|                       | F Electric tank breather valve |                                    |



### REPLACING AIR FILTER ELEMENT (16-VALVE ENGINES)

1. Use a screwdriver to remove mounting screws and remove upper part of air filter.

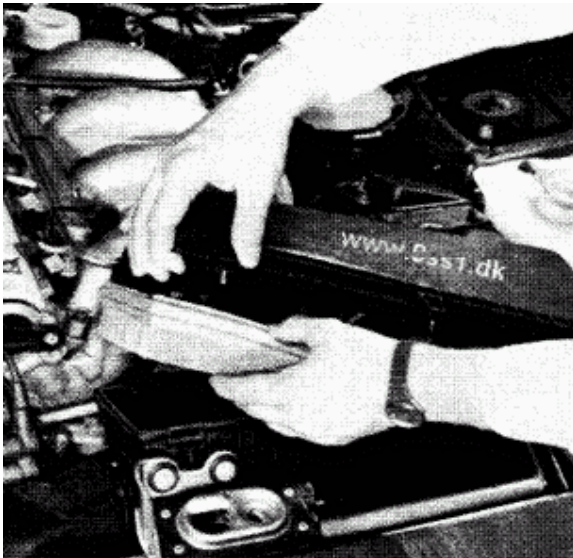

3. Remove filter element and clean inside of lower half of air-filter housing with a lint-free cloth
4. Insert filter element, place housing cover in position and tighten mounting screws. Check that upper part of air filter is correctly seated.



### CHECKING INTAKE AIR GUIDE AND CRANKCASE BREATHER HOSES FOR LEAKS AND LOOSE CONNECTIONS

1. Check all hoses of intake system for loose connections
2. Retighten hose clamps.

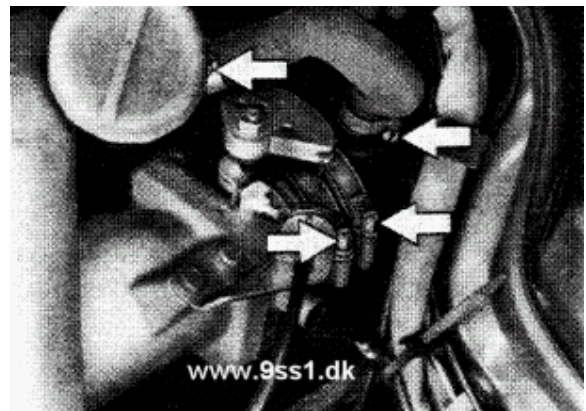

### Testing and adjusting specifications

#### Model 87 onward

#### Engine type M 44.40/41 (3.0 l)

Test	Specifikation	Remarks	
Electric fuel pump Min. delivery	rate 850 cm <sup>3</sup> /30 s		
Fuel pressure (engine stationary) DEE relay jumpered	3.8 +- 0.2 bar		
Checking value at idle	approx. 3.3 +- 0.2 bar		
Leak test min. pressure after 20 Min.	2.0 bar		
Idle speed rpm	without catalytic converter 840 +- 40 **	with catalytic converte 840 +- 40 **	** Idle speed can only now be checked. Idle adjust- ment no longer applies.
CO values %	0.5...1.5	0.4...1.2 *	* Measured upstream at catalytic converter and Lambda HC value probe connector not separated CO adjustment no longer applies.
ppm	<= 300	<= 300 *	

#### Note

Carry out working procedure **checking delivery rate of fuel pump** and **checking fuel pressure** as described an Pages 20 - 102 and 24 - 103 respectively.

Tightening torque for cap nut **12 Nm**.



## CHECKING FUEL PRESSURE

## TOOLS

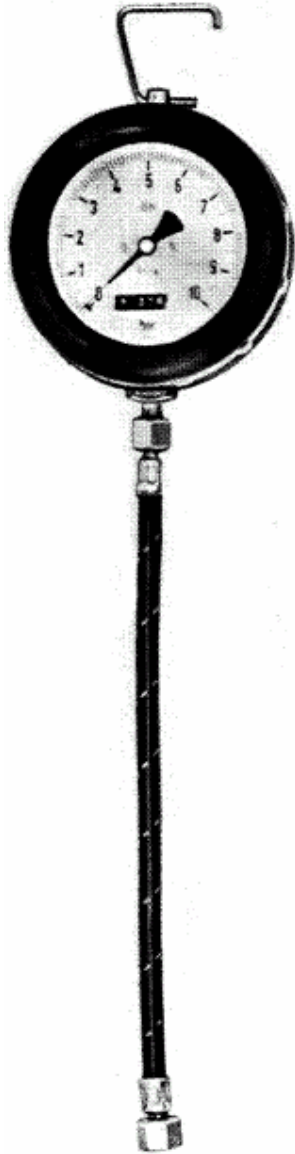

No.	Description	Special Tool	Remarks
	Pressure gage with hose from pressure tester	P 378	or VW 1318



## CHECKING FUEL PRESSURE

1. Slacken and remove capped nut on test connection of fuel distribution line.

Note:

Be careful that sealing ball does not fall out when capped nut is removed.

2. Connect pressure gage with hose from pressure tester P 378 or VW 1318 to test connection.



3. Disconnect DME relay from central electrics and jumper terminals 30 and 87 b with a length of electric wire. Fuel pump must now run.



4. Control value:

Engine stopped 3.8 +/- 0.2 bar  
(DME relay jumpered)

Engine idling, approx. 3.3 bar

5. Tightening torque of capped nut:  
22 Nm (16 ftlb)



### Checking idle speed and CO- with catalytic converter

**Model 87 onward**  
**Engine type M 44.40/41 (3.0 l)**

#### Note

It is no longer possible to adjust idle speed or CO on vehicles with catalytic converters. The Lambda probe remains connected while checking idle speed and CO.

#### Checking preconditions

Engine in perfect mechanical condition. Consumers must be switched off during checks. Carry out checks as quickly as possible to ensure that the intake paths do not heat up thus falsifying the CO value. Ambient temperature 15 - 35° C.

1. Fit standard exhaust adapter to the test connector of the catalytic converter.

#### Engine type M 44.40

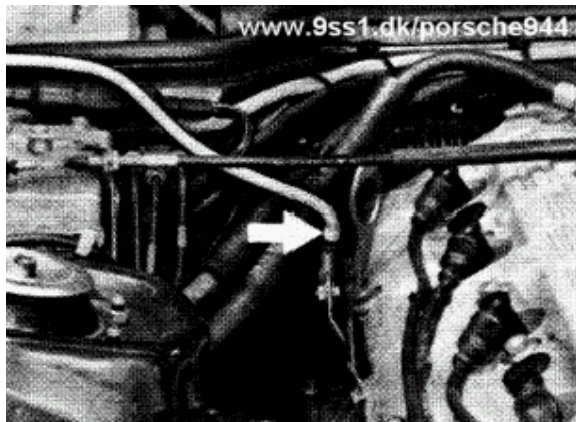

86/463

#### Engine type M 44.41 (3.0 l)

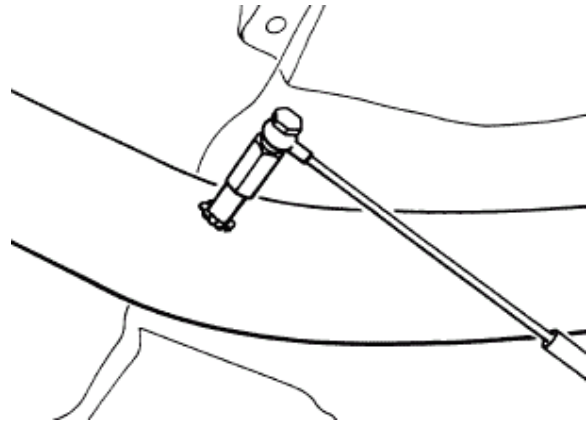

173-24

2. Warm engine up to operating temperature. (70 - 90° C oil temperature.) Use the oil-temperature tester, Special Tools 9122 and 9122/2.

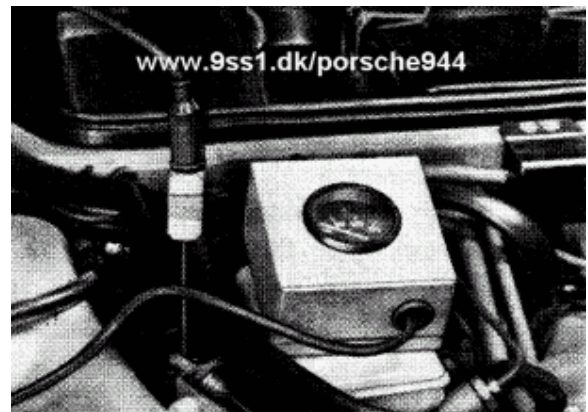

85/114

3. Do not separate the connection for the Lambda probe. Connect CO tester and separate speedometer according to the manufacturer's specifications.  
CO reference value 0.4...1.2%  
Idle speed 840 +/- 40 rpm

## Checking idle speed and CO without catalytic converter

**Model 87 onward**  
**Engine type M 44.40/41 (3.0 l)**

### Note

It is no longer possible to adjust the idle speed. The throttle valve connector adjustment therefore no longer applies.

### Idle/CO adjustment

#### Adjustment preconditions

Engine in perfect mechanical conditions. Consumers must be switched off during adjustment work. Carry out adjustment as quickly as possible to ensure that the intake paths do not heat up thus falsifying the CO value. Ambient temperature 15 - 35° C.

1. Warm engine up to operating temperature. (70 - 90°C oil temperature). Use oil temperature tester, Special Tools 9122 and 9122/2.
2. Check CO value. If the CO value is not within the prescribed tolerances. correct the setting at the air-flow sensor. Remove the sealing plug in the access bore to the CO adjusting screw.

### Engine type M 44.40

Standard screwdriver for 3 mm Allen screw.

### Engine type M 44.41 (3.0 l)

Standard angled screwdriver for 5 mm Allen screw.

Illustration shows engine type M 44.40

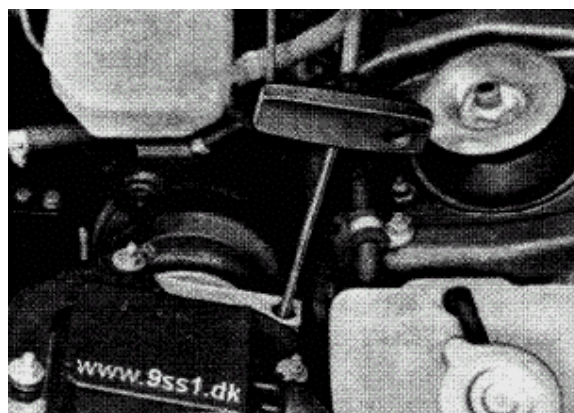

86/512

CO setting: 0.5...1.5 %  
Turn to the right - richer mixture  
Turn to the left - leaner mixture

#### Checking idle speed.

1. Connect separate speedometer according to manufacturer's specifications.

Idle speed 840 +- 40 rpm

### Replacing air filter insert Model 89 onward

#### Engine type M 44.41 (3.0 l)

1. Replace front end plate. Refer to 944 Workshop Manual Page 50 - 5.
2. Undo retaining clips and remove housing cover with filter insert.
3. Clean inside of filter housing with lint-free cloth.
4. Install new filter insert. Observe installation position. Arrow or TOP-OBEN marking points towards **the engine**.

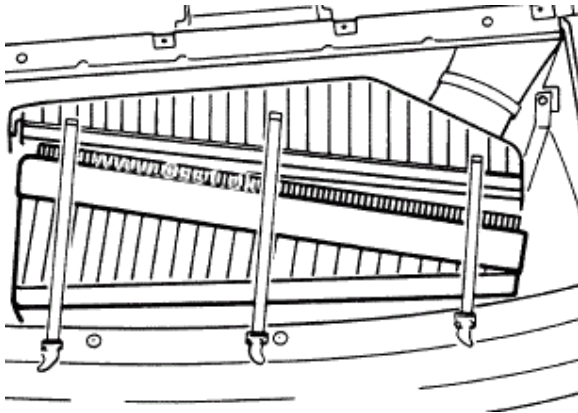

172 - 24



### CHECKING TIGHTNESS OF EXHAUST SYSTEM FLANGES (16-VALVE ENGINES)

1. Check tightness of exhaust flanges and check entire exhaust system for leaks.
2. Check tightness of hex nuts on exhaust manifold/cylinder head flange.
3. Check tightness of all flange connections in exhaust system, together with oxygen sensor and exhaust extraction tube.

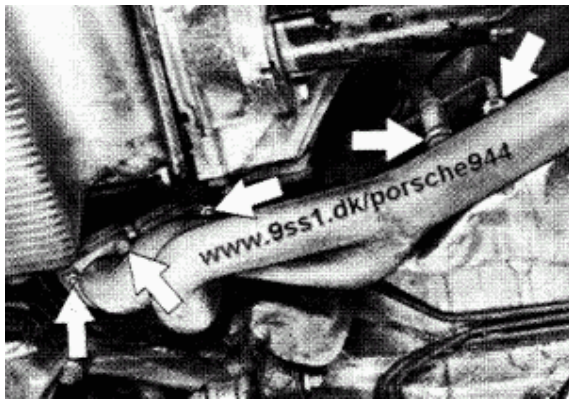

4. Check tightness of bolts in primary muffler (catalytic converter)/secondary muffler flange. Check exhaust-system hangers.

Tightening torques of nuts and bolts:

M 8	20 + 2 Nm (14 + 1.4 ftlb)
M10	40 + 5 Nm (30 + 3.6 ftlb)





## EQUIPMENT TABLE

Ignition Coil

Type/Model	Version	Remarks
944 S	944 602 115 00 Bosch No. 0 221 118 322	Without series resistors

Distributor (Cap)

Type/Model	Version	Remarks
944 S	928 602 211 01 Bosch No. 1 235 522 395	Only high-tension distribution

Spark plugs

Type/Model	Version	Remarks
944 S	Bosch WR 7 DC	Spark gap 0.7 + 0.1 mm

Ignition trigger box

Type/Model	Version	Remarks
944 S	928 602 706 01 Bosch No. 0 227 100 124	

**DME control unit**

Type/Model	Version	Remarks
944 S Mod. '87	944.618.124.00 944.618.124.01	M 44.40 Spare part
944 S Mod. '88	944.618.124.01	M 44.40

**Hall probe for knock sensors**

Type/Model	Version	Remarks
944 S	944.606.170.01	

**Knock sensor**

Type/Model	Version	Remarks
944 S	944.606.145.00	Tightening torque = 20 Nm (14 ftlb), use specified mounting bolt (without washer)

## DME CONTROL UNIT CODING, 944 S, '87 MODELS ONWARD

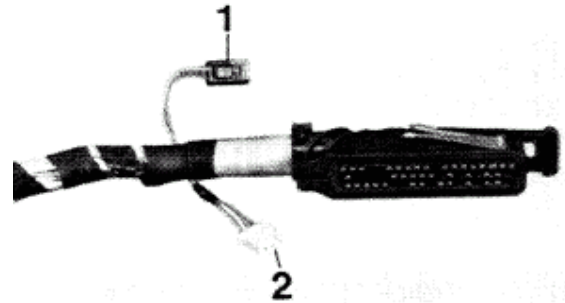
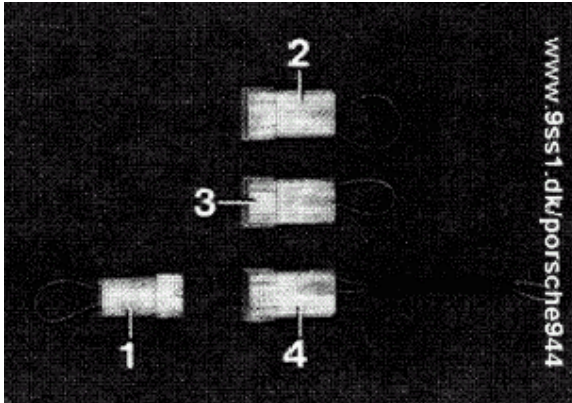

- 1 - 944.612.525.01
- 2 - 928.607.421.00
- 3 - 928.607.422.00
- 4 - 944.612.522.00

- 1 - Plug for characteristic-map switch
- 2 - Plug for variant switch

Country	Characteristic-map switch, ter. 54	Varient switch, ter. 39
USA, rest of world with catalytic converters		
California, Japan		928.607.421.00
EC, without catalytic converters		928.607.422.00
Sweden		944.612.522.00
Australia	944.612.525.01	



## REPLACING SPARK PLUGS, 944 S

1. Pull off spark plug caps.
2. Unscrew spark plugs with commercially available wrench. A spark-plug wrench is supplied as part of the car's toolkit.



Tightening torque: 25 - 30 Nm  
(18 - 22 ftlb).



**Equipment table 89 models onward****Engine type M 44.41 (3.0 l)****Ignition Coil**

Type/Model	Version	Remarks
944 S 2	944 602 115 00 Bosch No. 0 221 118 322	without series resistors

**Distributor (Cap)**

Type/Model	Version	Remarks
944 S 2	928 602 211 01 Bosch No. 1 235 522 395	Only high-tension distribution

**Spark plugs**

Type/Model	Version	Remarks
944 S 2	Bosch WR 5 DC	Spark gap 0,7 + 0,1 mm

**Ignition trigger box**

Type/Model	Version	Remarks
944 S 2	928 602 706 01 Bosch No. 0 227 100 124	

**DME Control unit**

Type/Model	Version	Remarks
944 S 2 Mod. '89/90	944.618.124.02	
944 S 2 Mod. '91	944.618.124.05	

**Hall probe for knock sensors**

Type/Model	Version	Remarks
944 S 2	944.606.170.01	

**Knock sensor**

Type/Model	Version	Remarks
944 S 2	944.606.145.00	Tightening torque = 20 Nm (14 ftlb), use specified mounting bolt (without washer)

**Coding - DEE control unit 944 S 2, Model 89 onwards**

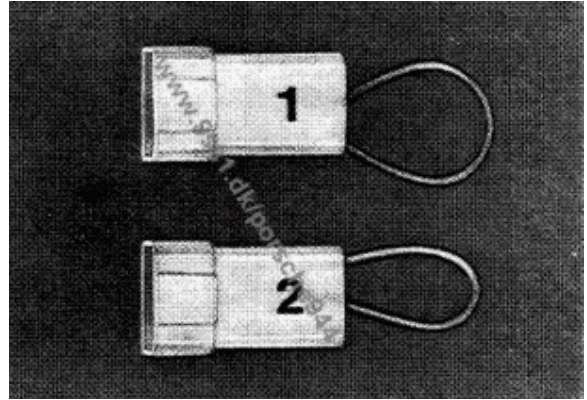
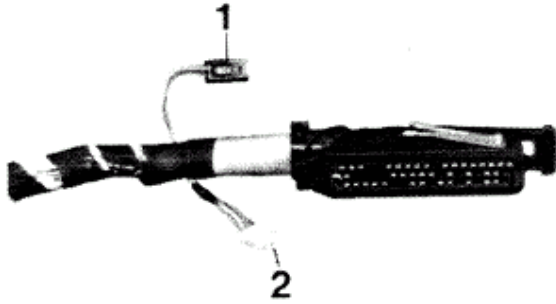

86/746 B

86/733

1 - 928.607.421.00  
2 - 928.607.422.00

1 - not used  
2 - connector for variant switch

Country	Variant switch
USA, rest of world with catalytic convertor	
California, Japan	928.607.421.00
Rest of world without catalytic converter	928.607.422.00



# DME-Diagnosis / Troubleshooting

---



---

Dr. Ing. h.c. F. Porsche Aktiengesellschaft

Test Point	Description	Page
	Precautions	2
	Important Vehicle Information	3
	Testing Requirements	4
	Effects of Faults (Cross Reference List)	7
	DME Control Unit Plug Connections	8
1	Power Supply	9
2	Idle Speed Contact	10
3	Full Load Contact	11
4	Engine Temperature Sensor	12
5	Air Flow Sensor	13
6	Idle Speed Control Activation	14
7	Oxygen Regulation Stop	15
8	Oxygen Sensor	16
9	Intake Air Temperature Sensor	16
10	Knock Sensor I	17
11	Knock Sensor II	17
12	Control Unit Faulty	18
13	Hall Signal	18
14	Control Unit Faulty	18
15	DME Relays	19
16	Tank Venting Valve	19
17	Check Engine Warning Lamp	20
18	Fuel Pressure	21
19	Intake System Leaks	22
20	Ground and Plug Connections	22
21	Speed/Reference Mark Sender	24
22	Ignition and Final Stage	25
23	Fuel Injectors - Injection Control Unit	28
24	Alternator / Regulator	29
25	Leads K and L	29
	CO and Idle Speed Test	30
	Coding of Control Unit	31
	Check-Engine-Lamp	32

**Precautions**

Greater demands of modern engines on the ignition systems and a desire for freedom from maintenance had led to the introduction of electronic ignition systems in standard production some time ago already. Normally the ignition power of electronic systems (almost all makes) will be greater than that of conventional systems and even greater power can be expected in the future. This places electronic ignition systems in a power range, where touching current carrying parts or terminats could be dangerous to lite (both primary and secondary circuits).

In conjunction with this matter we must point out that there must always be conformance with safety regulations and legislation of a pertinent country when working on or testing ignition systems. The ignition (ignition or source of power) must always be switched off when working on the ignition system.

Sample Jobs:

- Connecting engine testers, for example:  
timing light, dwell angle/speed tester, oscilloscope, etc..
- Replacing ignition components, for example:  
spark plugs, ignition coil, distributor, ignition leads, etc..

The above mentioned dangerous voltage will be present in the entire system should it be necessary to switch on the ignition for ignition tests or engine adjustments.

Consequently there is not onty danger on the various components of an ignition system (such as, for example, distributor, ignition coil, control units, ignition tackle), but also on wire harnesses, plug connections and testers.

**Important Vehicle Information**

- Always turn off the ignition or disconnect the battery for resistance tests (if not, the tester could be destroyed).
- Always disconnect the speed sender plug for compression tests (if not, there could be dangerous high tension and damaged insulation on the ignition coil, high tension distributor and ignition leads).
- Never replace a specified ignition coil (see order number) with a different ignition coil.
- Never connect a suppression capacitor on ignition coil terminals 1 and 15.
- Never connect ignition coil terminal 1 on ground for the burglar alarm (ignition coil and control unit could be destroyed).
- Never connect battery + or a test lamp on ignition coil terminal 1 (control unit could be destroyed).
- Never disconnect the ignition lead between ignition coil terminal 4 and high tension distributor terminal 4 during operation.
- Avoid voltage flashover from ignition coil terminal 4 to ignition coil terminals 1 and 15 (control unit could be destroyed).
- To avoid destruction of the control unit, the secondary circuit of the ignition system must be suppressed with at least 4 k-ohms, whereby the original distributor rotor with 1 k-ohm suppression resistance must be installed.
- Disconnect DME control unit and ignition final stage plugs only after turning off the ignition.
- Flashover or disruptive discharge in the area of the high tension distributor cap (poor insulation) could destroy the control unit.
- Never disconnect the battery while the engine is running.
- Mixing up battery pole connections could lead to destruction of the ignition final stage, ignition coil and DME control unit.
- Outside starting of the engine with more than 16 volts or a boost battery charger is forbidden.
- Always conform with accident prevention regulations when working on fuel systems.

**Equipment Required for DME Tests:**

- Diagnostics tester 9288 (9268) with connecting leads
- 1 oscilloscope approved by Porsche
- 1 digital display multimeter with an internal resistance of at least 10 M-ohms
- 1 Bosch L-Jetronic test lead, Bosch No. 1684 463 093 (check read for correct polarity in plugs)
- 2 control unit plug test leads (local manufacture) fitted with 2 flat male plugs, 'N 17.457.2, in order to avoid damage on plug pins in the control unit plug while testing
- 2 adapter test leads, consisting of 4 plug connectors, N 017.483.1, soldered with 2 approx. 150 mm lang leads
- 1 three-pin test lead (e.g. VW VAG 1501)
- 2 control unit plug test leads (local manufacture) fitted with 4 flat male plugs, N 17.457.2

Test leads must always be used for testing!

- All sender and ignition timing signals of Porsche models can be checked with the engine reglers recommended by Porsche. Instructions for connection of testers on a car will be different depending on the make, so that it will always be necessary to conform with the instructions supplied with a pertinent tester.

**Sender Signals Which Can Be Checked With An Oscilloscope:**

- Speed sender signal
- Injection ( $t_i$ ) signals
- Idle speed control activation signal
- Hall sender signal
- Ignition trigger signal to ignition final stage
- Tank venting activation signal

as well as:

- Reed switch signal (speedometer)
- ABS wheel sensor signals

### Diagnosable DME Control Unit

Self-diagnosis with a fault memory, with which it is possible to detect and store certain injection, ignition and knock regulating system faults, is integrated in the DME control unit of 944 S cars beginning with 1988 models.

The DME control unit has a permanent positive connection to prevent cancellation of detected and stored faults by turning off the ignition. Detected faults remain stored in the memory for at least 50 engine starts (exception: idle speed switch interruption faults).

#### Important!

If the DME control unit plug or battery is disconnected, the fault memory and system adaptation will be cancelled.

#### Tester Connections:

A 12-pin plug, which leads out of the DME wire harness in the passenger's footwell to the right above the DME control unit, is provided for diagnosing in cars since 1988 models. 9268 Flashing Code Testers can be connected on this plug.

A 19-pin plug replaces the 12-pin plug beginning with 1990 (L) models. Either a 9288 System Tester or the Flashing Code Tester (via adapter leads 9268/2) can be connected on this plug. Operation of the testers is explained in the instructions supplied with the testers.

#### Note:

A pertinent test point is supplemented by a corresponding fault flashing code of Tester 9268.

#### Example:

Test Point 2 = idle speed contact (1-12)

Second digit display:

"1" fault exists

"2" fault does not exist

The following actual engine data can be read direct in the "actual value" menu with a 9288 System Tester beginning with the version 2.0 tester module status.

Intake air temperature	Engine temperature
Ignition timing	Engine speed
Oxygen sensor voltage	Power supply
Version code	Air flow sensor signal
Idle drive pulse duty factor	Load signal

This DME 944 S Diagnosing/Troubleshooting Plan is based on the contents of the fault memory.

Paths not included in self-diagnosis can be diagnosed with conventional equipment (Test Points 17-25. see Fault List).

### **Troubleshooting requires that the person performing the tests**

- is familiar with the location of components, the function and technical interconnections of the systems being tested (model information).
- can read and evaluate Porsche wiring diagrams.
- knows the functions of circuits and relays, and
- is capable of using testers, such as the oscilloscope, voltmeter, ohmmeter and ammeter, as well as evaluating the test results.

### **Important!**

A fault text in the display (Fault List and Flashing Code) does **not** always indicate a fault in the pertinent component, but could also concern the corresponding control unit or connecting leads (paths) between the component and control unit.

Troubleshooting on a running engine in the form of disconnection of plugs, etc. must not be carried out prior to reading the fault memory, since such action could be stored as faults in the fault memory.

### **9288 System Tester Information**

Displayed in Tester

Fault does not exist, this could mean:

- Fault not existing at time of testing (loose contact).  
**Remedy: visual inspection of path (connection).**
- Conditions, with which the fault is tested. are not the same as the conditions, with which the fault had occurred.  
**Remedy: conform with conditions displayed in the tester.**

### Signal Not Plausible:

Signal of the monitored component does not fit in the tolerance range of the value calculated in the control unit.



**This page are missing or blank in the book !**

**This page are missing or blank in the book !**

---

**Fault, Fault Code**                      **Possible Causes, Elimination, Remarks**

---

**Test Point**

**1a**                      **a) Perm. pos. (B +)**                      **Fault memory is cancelled, if there is no B +.**  
 Power supply for DME control unit (V)                      Testing:  
 Connect a voltmeter on terminal 24 (-) and terminal 18 (+) of the control unit plug with help of test leads.

Display: battery voltage

No display: check current flow and ground paths according to the wiring diagram.

**Test Point**

**1b**                      **b) Power supply via DME relay**  
 Power supply for DME control unit (V)                      Connect a voltmeter on terminal 24 (-) and terminal 37 (+) of the control unit plug with help of test leads. Turn on ignition.  
 Display: battery voltage  
 too high / too low                      No display: check current flow path according to the wiring diagram.  
 Fault Code  
 1\_11

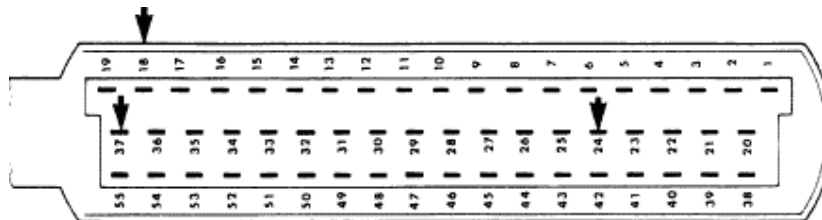
**Remarks:**

**Cars with burglar alarm:** check power supply from ignition lock via burglar alarm control unit to terminal 86 at the DME relay according to the wiring diagram.

**Cars without burglar alarm:** check pin bridges on plug (provided for installation of a burglar alarm control unit).

**Fault, Fault Code**                      **Possible Causes, Elimination, Remarks**

**Test Point 2:**

**Idle speed contact ( $\Omega$ )**      **Check** via circuit input test with 9288 System Tester or 9268 Tester.

**Ground short**

Select test step and operate accelerator pedal.

Fault Code 1\_12 9288 Display:    Idle speed contact made  
    Idle speed contact broken  
    9268 Display:    1332 (idle speed contact made)  
    0000 (idle speed contact broken)

No Display:

Pull off plug on DME control unit.

Connect ohmmeter between terminal 52 and terminal 24 with help of test leads.

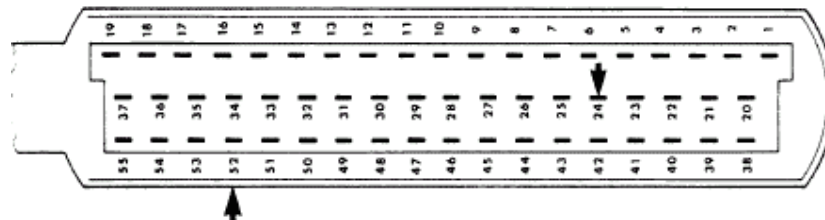

Display:  
 Throttle valve closed                      < 10  $\Omega$   
 Throttle valve opened to gap of > 1° =  $\infty \Omega$

If the value of the idle speed contact is not reached in this test, the test should be repeated direct on the throttle valve switch as described below.

Pull off plug on throttle valve switch. Connect ohmmeter between terminals 1 and 2 of the throttle valve switch with help of test leads.

Display:  
 Throttle valve closed                      < 10  $\Omega$   
 Throttle valve opened to gap of > 1° =  $\infty \Omega$



**Idle speed contact ( $\Omega$ )**      Testing same as described for ground short (fault stored in memory as of 1991 models).

**Break**

Fault Code 1\_15 Check for correct adjustment, correcting if necessary.  
 Cause, for example, could be an incorrectly adjusted throttle valve switch or accelerator cable.

**Fault, Fault Code**                      **Possible Causes, Elimination, Remarks**

**Test Point 3**  
**Full load contact ( $\Omega$ )**  
**Ground short**  
 Fault Code 1\_13

Check via circuit input test with a 9288 System Tester or 9268 Tester.

Select test step and operate accelerator pedal.  
 9288 Display:    Full load contact broken  
                          Full load contact made  
 9268 Display:    1333 (tull load contact broken)  
                          0000 (full load contact made)

No Display:

Connect ohmmeter on terminal 53 and terminal 24 of the disconnected DME control unit plug with help of test leads.

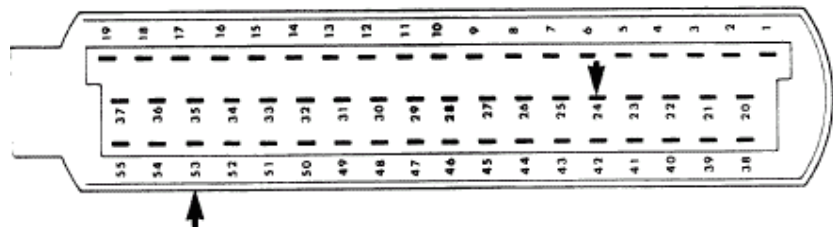

Display:  
 Throttle valve closed                       $\infty \Omega$   
 Throttle valve opened about  
 2/3rd of full gap                               $< 10 \Omega$

If the value of the full load contact is not reached in this test, the test should be repeated direct on the throttle valve switch as described below.

Pull off plug on throttle valve switch. Connect ohmmeter between terminal 3 and terminal 2 of the throttle valve switch with help of test leads.

Display:  
 Throttle valve closed                       $\infty \Omega$   
 Throttle valve opened about  
 2/3rd af full gap                               $< 10 \Omega$



**Remarks:**

If the full load contact fails, the control unit produces a load threshold via the air flow sensor. Value below this load threshold same as switch broken or above load threshold same as switch made.

**Fault, Fault Code****Possible Causes, Elimination, Remarks**

**Test Point 4**  
**Engine temp. sensor**  
 (NTC II/ $\Omega$ )  
 Fault Code 1\_14

Engine temperature can be read direct from the "actual value" menu with a 9288 System Tester.

No Plausible Display:

Connect ohmmeter on terminal 45 and terminal 24 of the disconnected DME control unit plug with help of test leads.

Display at:

0°C =	4.4 - 6.8 k $\Omega$
15 - 30°C =	1.4 - 3.6 k $\Omega$
40°C =	1.0 - 1.3 k $\Omega$
80°C =	250 - 390 $\Omega$
100°C =	160 - 210 $\Omega$

Test direct on the engine temperature sensor, if the values are not reached.

Note: Temperature sensor II sends information about the engine temperature to the control unit. It is used to provide a rich fuer/air mix-ture after a cold start or during warm-up.

Break ( $\infty \Omega$ ):

DME control unit of the 944 S selects a resistance value, which is stored in the control unit's memory and is approximately equal to that of an engine at operating temperature. There is no enrichment from a faulty NTC II when the engine is warm (emergency running program). This results in starting problems when the engine is cold (no cold start enrichment).

Short (0  $\Omega$ ):

No engine pickup, too lean and stopping of engine in cold state.  
 No effects in operating temperature state.

Replacement value is applicable to both types of fault!

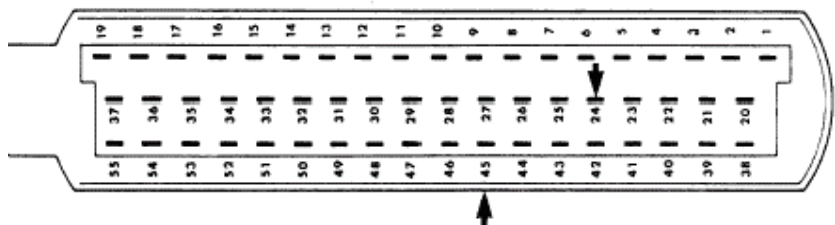

---

**Fault, Fault Code**                      **Possible Causes, Elimination, Remarks**

---

**Test Point 5a:** The ratio between  $U_p$  (potentiometer voltage) and  $U_v$  (power supply voltage) can be read in the "actual value" menu with a 9288 System Tester.

**Air flow**

**sensor** When opening the air flow sensor plate the ratio must be about 0.0 to 1. If not:  
(V/ $\Omega$ )

**Fault Code**                      **a) Power supply voltage**

1\_21

Connect a voltmeter on terminal 3 and terminal 4 of the disconnected air flow sensor plug with help of test leads. Turn on ignition.

Display: 5 +/- 0.3 volts

**Test Point 5b:**

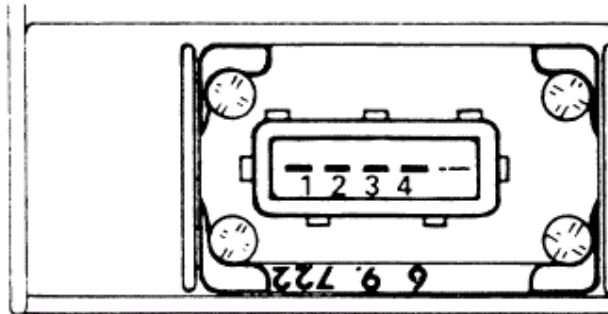
**b) Voltage drop on air flow sensor plate potentiometer (V)**

Take off air cleaner connecting hose. Connect pin 3 of the disconnected air flow sensor plug with air flow sensor plug terminal 3 and pin 4 with air flow sensor plug terminal 4 with help of test leads.

Connect a voltmeter on air flow sensor terminal 2 and terminal 4 (turn on ignition).

Display: approx. 250 - 260 mV

It must be possible to move the air flow sensor plate easily and without hesitation. Observe the voltmeter's display at the same time. Voltage jump or voltage drop should not be observed while the air flow sensor plate is opening or closing.

Display with air flow sensor plate in full load position:  
approx. 4.60 volts.

---

Fault, Fault Code	Possible Causes, Elimination, Remarks
-------------------	---------------------------------------

---

Turn off ignition and reconnect plug if the voltage values have been reached.

**Remarks:**

Control unit produces replacement values in case of air flow sensor failure (emergency running program).

Injection signal  $t_i$  from nominal air of the idle speed volumetric efficiency control for idle or a constant injection signal  $t_i$  for partial load and full load ranges.

**Test Point 6:****Idle speed control (V)**

Fault Code

1\_22 only S2

**Element Activation Menu**

If pulse cannot be heard, check:

**Power supply**

Connect a voltmeter on terminal 2 and ground of the disconnected idle speed control plug.

Turn on ignition.

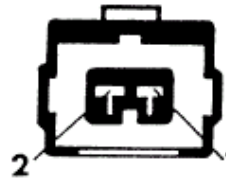

Display: battery voltage

No display:

Check power supply according to the wiring diagram.

**Control signal test**

The pulse duty factor in % can be read direct in the "actual value" menu with a 9288 System Tester.

Function test: Switch on electric power consumers with engine running at idle speed. The pulse duty factor must change and the idle speed must remain constant.

If not:



---

**Fault, Fault Code**                      **Possible Causes, Elimination, Remarks**



---

Connect two-pin DME test lead (Bosch No. 1 684 463 093) between the speed control and plug.

Connect and adjust engine tester to supplied operating instructions.

Make sure that electric lead connections do not have contact with vehicle ground (danger of short).

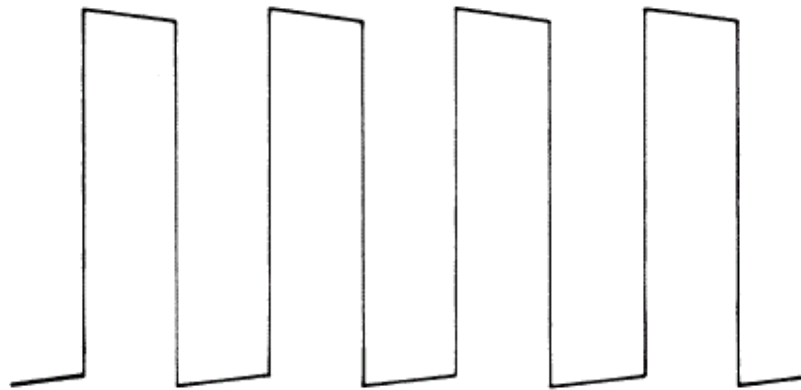
Displayed with the engine running:



Frequency: approx. 100 Hz.

Replace the idle speed control if the pulse cannot be heard in spite of correct power supply and received signal.

**Test Point****7****Oxygen regulation on stop**Fault Code  
1\_23

Oxygen regulation cannot work in its regulating range in case at disturbances in air/fuel mixture; for example: too lean because of excessive air or too rich because of a sticking fuel injector. It then moves against the stop.

Test 1:            Check CO level with the engine running and CO tester connected (between 0.4 and 1.2 %).

too lean:        Check intake system for leaks (Test Point 19).

too rich:        Check system pressure (Test Point 18).  
Check fuel injectors for leaks (Test Point 18).

**Fault, Fault Code**                      **Possible Causes, Elimination, Remarks**

**Test Point 8:**  
**Oxygen sensor**  
 (V)  
 (sensor signal)  
 Fault Code 1\_24

**Sensor signal test**

Sensor voltage can be read direct in the "actual value" menu with a 9288 System Tester.

If not:  
 Disconnect oxygen sensor plug. Connect a digital display voltmeter on the sensor end test connection (sensor voltage signal) and ground.

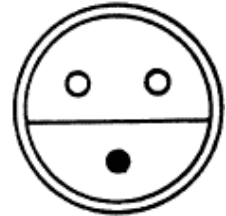

Start and run engine warm so that the oxygen sensor reaches its operating temperature. A change in the voltage signal must be displayed when the mixture is richer, e.g. by accelerating.

Display on voltmeter:  
 approx. 150 mV - 900 mV (depending on composition of mixture)

**Remarks:**

If the control unit recognizes an oxygen) sensor voltage signal of more than 1 V or less than 0.1 V, the control unit will switch over to operation without oxygen sensor (short or break).

If regulation does not work and the sensor voltage signal is okay, check the coding of the control unit before replacing the control unit.

**Test Point 9**  
**Air temperature sensor**  
 NTC I (Ω)  
 Fault Code 1\_25

Intake air temperature can be read direct in the "actual value" menu with a 9288 System Tester.

If not or when a non-plausible value is displayed:

Connect an ohmmeter on terminal 44 and terminal 26 of the disconnected DME control unit plug.

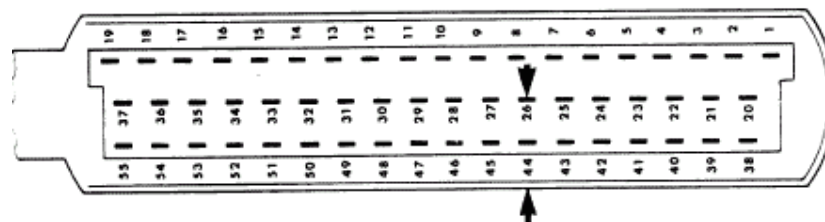

Display at:

0°C =	4.4-6.8 kΩ
15-30°C =	1.4-3.6 kΩ
40°C =	1-1.3 kΩ

---

Fault, Fault Code	Possible Causes, Elimination, Remarks
-------------------	---------------------------------------

---

If no display: Disconnect plug on air flow sensor. Connect an ohmmeter on air flow sensor terminals 1 and 4 with help of test leads. Display: same as above.

Note: In case of a break, there will be a replacement value equal to an intake air temperature of 20° C (emergency running program).

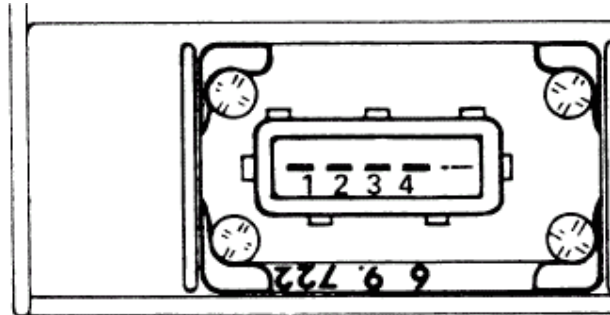
**Test Point 10**

**Knock sensor** Knock sensor I: Knock signal not plausible. Check:

- |            |  |
|------------|--|
| I          | - Installation of knock sensor (check tightening torque and type of screw).    |
| Fault Code | - Wire harness and plug connections according to wiring diagram.               |
| 1_31       | - Reconnecting sensors eliminates contact resistance.                          |
|            | - Whether coolant or other liquids are in area of the knock sensor.            |
|            | - Replace knock sensor.  |
|            | Ignition timing retarded by 6° on crankshaft in case of a faulty knock sensor. |

**Test Point 11**

**Knock sensor** Knock sensor II: Knock signal not plausible. Check:

- |            |  |
|------------|--|
| II         | - Installation of knock sensor (check tightening torque and type of screw).    |
| Fault Code | - Wire harness and plug connections according to wiring diagram.               |
| 1_32       | - Reconnecting sensors eliminates contact resistance.                          |
|            | - Whether coolant or other liquids are in area of the knock sensor.            |
|            | - Replace knock sensor.  |
|            | -  |
|            | Ignition timing retarded by 6" on crankshaft in case of a faulty knock sensor. |

---

Fault, Fault Code	Possible Causes, Elimination, Remarks
-------------------	---------------------------------------

---

**Test Point**

**12:** Ignition timing is retarded 6° in case of this fault.

**Control**

**unit** Replace control unit.

(knock  
computer)

Fault Code

1\_33

**Test Point**

**13:** Disconnect plug on cylinder head behind the camshaft drive gear and connect a three-pin adapter lead (VW 1501) inbetween to check the Hall signal. Connect oscilloscope positive and negative test leads on terminals 1 and 2 of the adapter lead. Start the engine.

Fault Code

1\_34

This signal should be displayed when the Hall system is okay:

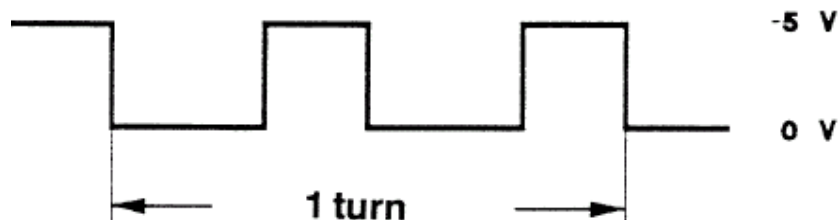

Ignition timing will be retarded approximately 6° in all speed ranges, if the DME control unit recognizes that the Hall signal is missing.

Protective circuit test:

Turn off ignition. Disconnect Hall plug. Start the engine. Idle speed ignition timing will adjust itself to approximately 4° before TDC (944 S). There must be a certain load signal from the air flow sensor in case of 944 S2 cars.

**Test Point**

**14:** Replace control unit.

**Control**

**unit faulty**

Fault Code

1\_41

---

**Fault, Fault Code**                      **Possible Causes, Elimination, Remarks**

---

**Test**

**Point 15:** Start the engine - fuel pump must run during engine starting.

**DME****relay**

(fuel

pump) (V)

It not:

Turn off ignition. Disconnect control unit plug. Connect terminal 3 and terminal 24 on the control unit plug with help of a test lead.

Turn on ignition - the pump must run!

It not:

Check current flow and ground paths of DME relay and fuel pump according to the wiring diagram.

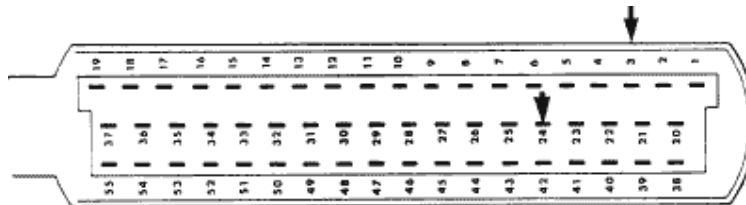
**Test**

**Point 16:** Electric valve (for brake booster) will be opened more or less long depending on the engine load when an engine having operating temperature is running. The opened time is determined by a ground pulse from the control unit.

**Tank venting valve (V)**

Fault

Code

1\_43

(not 944

S)

**a) Activation test**

Activate the tank venting valve in the "element activation" menu of the tester. If a pulse is not heard, check power supply to terminal 1 of the electromagnetic valve plug according to the wiring diagram.

**b) Control signal test**

Install DME test read (Bosch No. 1 684 463 093) between the electromagnetic valve and plug connection. Connect and adjust engine tester according to the supplied operating instructions.

---

Fault, Fault Code	Possible Causes, Elimination, Remarks
-------------------	---------------------------------------

---

Tank venting valve is not activated permanently.

Test must be performed within 7 minutes after starting an engine having operating temperature (interrupt tank venting valve activation approx. 75 seconds afterward and then continue).

Start engine and accelerate. This must be displayed in the tester for an engine at operating temperature:

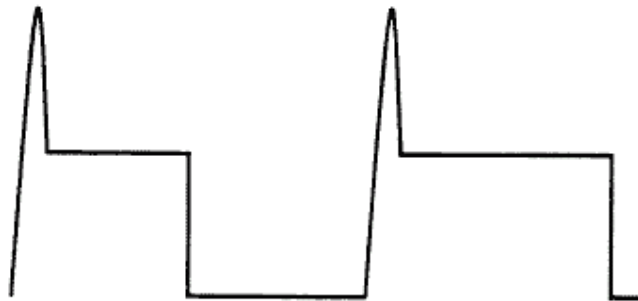

Signal will be wider as the air flow rate increases!

Check path according to the wiring diagram if there is no signal.

Replace control unit if necessary.

### Test Point

17:

#### Check Engine warning lamp

Fault Code

1\_45

(California as

of

1991 models)

A ground signal from control unit plug terminal 22 goes to and switches on the "Check Engine Lamp", if a component influencing emission control fails.

If the "Check Engine" warning lamp fails, this fault is stored in the fault memory.

Check by supplying ground to control unit plug terminal 22 and turning on the ignition.

Always replace a faulty display lamp with a specified lamp.

**Test Point 18: Fuel Pressure**

Fuel collection pipe has a test connection at left front. Unscrew cap nut of the test connection.

Important! Inserted ball seal could fall out!

Connect P 378 pressure tester on the test connection. Start the engine. Vacuum on pressure regulator at idle speed:

**Test pressure: 3.3 +/- 0.2. bar**

Build up pressure again by switching on the fuel pump briefly. Remove return pipe on the pressure regulator (fuel pump must not be switched on).

**Hot starting problems:**

Check with the engine stopped and fuel pump running, without vacuum on the pressure regulator (this requires removing the DME relay and bridging terminals 87b and 30):

**Test pressure: 3.8 +/- 0.2 bar**

- Stop fuel pump. Read pressure on the pressure tester (specification: 3.8 +/- 0.2 bar).
- Max. permissible pressure drop on warm engine: **0.5 bar in 30 minutes.**
- If the pressure drops below the specified value, proceed as described below.

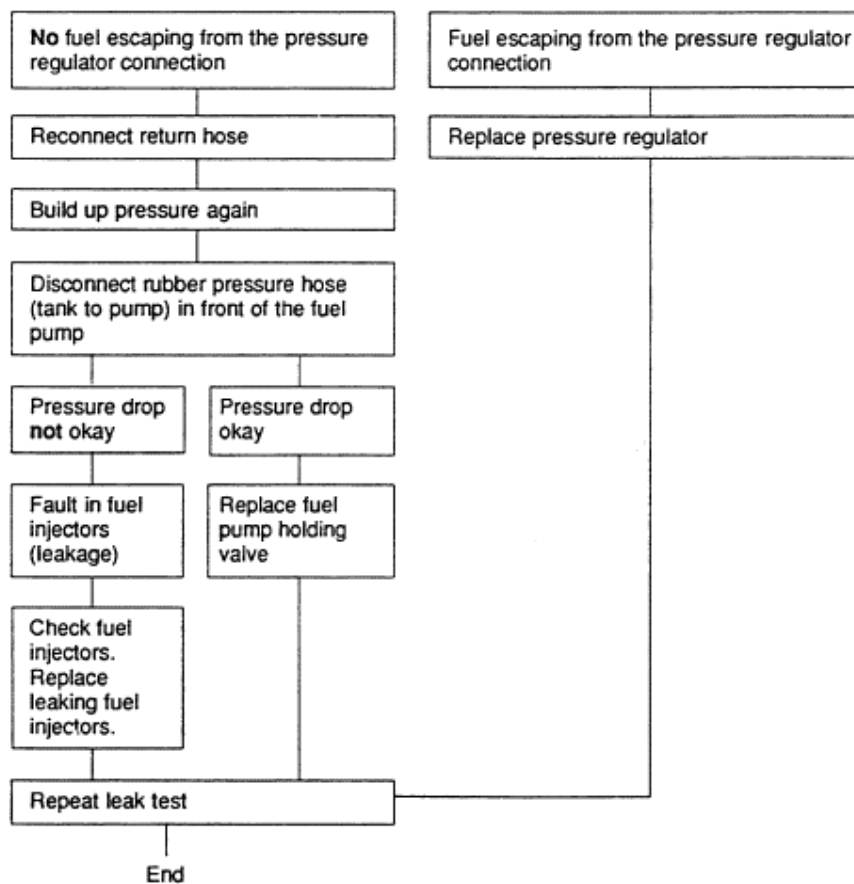

**Test Point 19: Intake System leaks**

Check all connections after the air flow sensor for leaks. Remove upper air cleaner section. Apply Special Tool 9264/4 on the air flow sensor and produce approx. 0.5 bar pressure in the intake system. Leaks will cause the pressure in the system to drop quickly.

(944 S: shut the safety pressure valve for crankcase breathing.)

**Remarks:**

Flashing Fault Code 1\_23 (oxygen regulation on stop) is displayed in cars with oxygen regulation and very large leakage in the intake system (for example: intake pipe gasket).

**Test Point 20: Ground Connections (V)**

- Ground read (2 x) from wire harness to engine block.
- battery ground lead on clutch bell housing (engine ground) and on body (body ground next to battery).
- Ignition final stage ground on side member at left front.
- Fuel pump ground on rear lock cross wall behind the spare wheel.
- Are ground connections tight and without corrosion? Loosen, clean and retighten ground connections as specified.

**Caution!**

**Never start the engine as long as the ground lead between the body and engine is disconnected!  
This would destroy the control unit immediately!.**



### Plug Connections

Are all plugs connected correctly, not loose and not corroded?

Disconnect plugs and check whether pins and terminals of plugs are bent or corroded.

- 55-pin plug an DME control unit (behind floor plate in the front passenger's footwell).
- 14-pin plug in engine compartment next to the brake booster.
- 3-pin plug for reference mark/speed sender and 3-pin plug for oxygen sensor behind the intake pipe for cylinder no. 4 (first remove cover an the fuel ring-pipe).
- 3-pin plug an throttle valve switch.
- 2-pin plug on electromagnetic valve for tank venting (an brake boaster).
- 4-pin plug an air flow sensor.
- 2-pin plug an NTC II (temperature sensor is screwed in the engine block above the left compensating shaft near cylinder no. 1).
- 7-pin plug on ignition final stage in the engine compartment at front left.
- 3-pin Hall sender plug (behind the camshaft drive gear).
- 2-pin plug for knock sensor I (between in take pipes for cylinder no. 1 and 2).
- 2-pin plug for knock sensor II (between in take pipes for cylinder no. 3 and 4).
- 2-pin plug on idle speed control (between intake pipes for cylinder no. 2 and 3).

944 S2: between cylinder no. 1 and 2.

- Plug for fuel injector ballast resistors (in engine compartment at rear right next to the plug for the brake pad wear indicator).

- 2-pin plugs on each of the four fuel injectors.

Because 944 S cars are supplied worldwide since 1987 models with only one standard control unit and said control unit is coded accordingly depending an country equipment, this coding must be checked in case of complaint.

A 2-pin or 3-pin plug leads out at the DME wire harness near the plug receptacle, in order to be able to call the different curve families.

Power is supplied to the DME control unit of a 944 S via terminal 30 (battery +) in addition to via ignition lock terminal 15.

### Test Point 21: Speed/Reference Mark Sender

This test can only be performed with an oscilloscope. Connect and adjust a workshop oscilloscope according to the supplied operating instructions for this purpose.

Connect the positive tester lead via a test lead on control unit plug terminal 47 and negative tester lead via a test lead on control unit plug terminal 48.

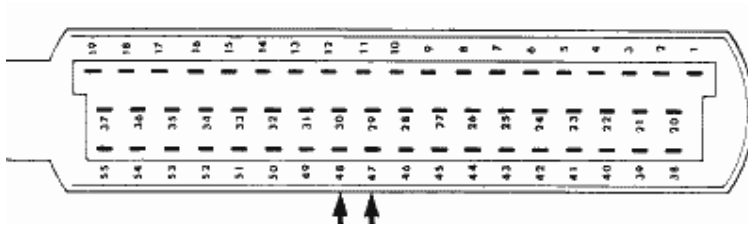

Crank engine with the starter motor. Sinusoidal oscillation of at least 3 volts (speed pulse) and an applied higher amplitude (reference mark) must be displayed on the screen.

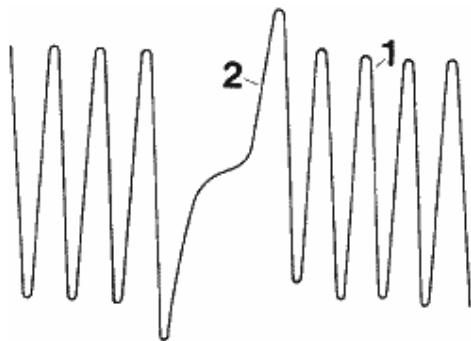

If the voltage signal is too small ( $< 3\text{ V}$ ), the distance between the sender and gear ring could be adjusted incorrectly.

**Sender distance:** Between gear ring and sender:  $0.8 \pm 0.3\text{ mm}$ .

- 1 - Speed signal
- 2 - Reference mark signal

**No display:**

Disconnect plug of speed sender on plug plate in the engine compartment. Connect tester leads on middle and outside pins of the plug on the sender end of the plug with help of test leads (terminals 1 and 2, pin end). Start the engine. Sinusoidal oscillation must be displayed on the screen.



Speed sender plug

**Remarks:**

The display must remain unchanged after supplying ground to connection 3.

If not, check power flow, spacing and condition of the sender.

**Test Point 22: Ignition****a) Secondary ignition display**

Adjust secondary ignition display on the oscilloscope. Connect tester leads according to the supplied operating instructions.

**Note:**

If a fault is displayed for all cylinders, it is in the primary or secondary circuit from the ignition coil to the distributor rotor. If a fault is displayed for one cylinder, this fault is located after the distributor rotor.

Primary resistor:	Term.1 + 15 = 0.4-0.6
Secondary resistor:	$\Omega$ Term.1 + 4 = 5-7.2 k $\Omega$

**b) Spark plug connectors ( $\Omega$ )**

Suppression resistor: 3 k $\Omega$   
Visual inspection for damage or traces of burning.

**c) Distributor**

Distributor rotor, distributor cap: suppression resistor = each 1 k $\Omega$ .  
Visual inspection for damage, dirt or wrong location.

**d) Ignition timing test**

Ignition timing is checked with the engine at operating temperature.

Ignition timing and engine speed can be read direct in the "actual value" menu with a 9288 System Tester.

**Test value: (944 S + 944 S2)**

At 840 +/- 40 rpm    10° +/- 3°

**e) Activation of high tension end  
(if ignition sparks are not triggered)**

Ignition triggering signal can be simulated for fast troubleshooting of the ignition end. This requires connecting the oscilloscope term. 4 tester lead on the ignition lead betw. ignition coil and high tension distributor (term. 4).

Disconnect DME control unit plug.

**Turn on ignition.**

If battery voltage is now supplied intermittently to terminal 1 of the control unit with help of a test lead (e.g. control unit plug term. 18), a high tension peak must be displayed on the oscilloscope each time (ignition triggering).

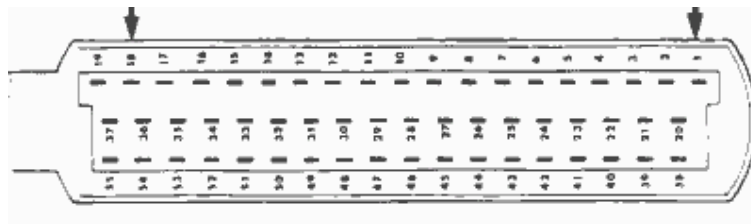
**If there is no signal, check:**

- Power supply to ignition final stage and ignition coil.
- Ground connection for ignition final stage (ground point on left front side member).
- Plug connections on ignition final stage, ignition coil and high tension distributor.
- Components responsible for high tension (for example: ignition coil, ignition leads, spark plug connectors, etc.).
- Power flow in lead between control unit plug and ignition final stage term. 5.

**f) Ignition final stage control signal test**

Connect DME control unit plug.

Connect oscilloscope's positive tester lead on terminal 5 and negative tester lead on terminal 2 of the disconnected final stage plug.

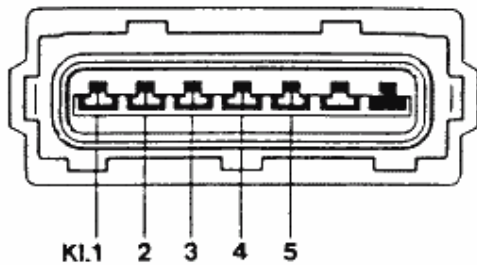

Operate starter motor.  
Oscilloscope should display the control signal of the DME control unit.

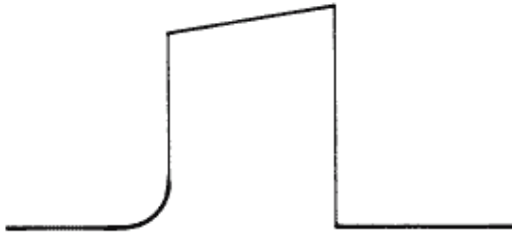
**Very important:**

Coat the baseplate with a heat conducting paste prior to installation of the ignition final stage. Keep heat conducting paste off of painted parts.

Heat conducting paste:  
Bosch No. 5 942 860 003.

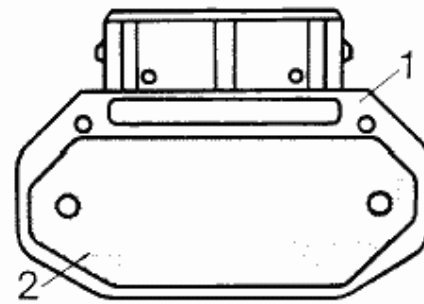

1 - Final stage  
2 - Baseplate

### Test Point 23: Fuel Injectors - Injection Timing ( $V/\Omega$ )

#### Element activation menu:

If a pulse is not heard, check:

#### a) Power supply

Pull off injector plug. Connect voltmeter on injector plug terminal 2 and ground with help of test leads. Turn on ignition.

#### Display: battery voltage



If there is no display:

Disconnect 5-pin plug of fuel injector ballast resistors. Connect voltmeter between terminal 3 (terminal sleeve end) and ground. Turn on ignition.

If battery voltage is displayed, Turn off ignition and pull off all plugs on fuel injectors. Check power flow and resistance between the S-pin plug of ballast resistors and terminal 2 of each fuel injector plug with an ohmmeter.

#### Resistance of each ballast resistor = $6 \Omega$



Check current path according to the wiring diagram if battery voltage is not displayed.

#### b) Coil resistance test of fuel injectors

Pull off injector plugs. Check coil resistance on the contacts of the fuel injectors with an ohmmeter.

**Test value: 2 - 3  $\Omega$**

#### c) Injection final stage

Adjust oscilloscope according to the supplied operating instructions. Connect Bosch test lead (1 684 463 093) between fuel injector and plug. Connect tester leads on Bosch lead according to the supplied operating instructions.

#### Caution:

**Tester leads must not have any contact with ground.**

Start the engine. These displays must appear in the oscilloscope if the injection final stage is working perfectly and test connections are correct.

#### Starter speed

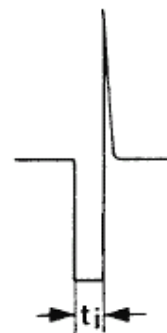

#### Remarks:

If the engine cannot be started or the idle speed drops, change tester connections on the Bosch lead and check tester adjustment.

**Test Point 24: Alternator, Regulator**

Misfiring of the engine could be caused by the peak voltage of the alternator.

Take drive belt off of the alternator. Start the engine.

Check alternator and regulator if the disturbances have been eliminated.

**Test Point 25: Leads K and L**

Connections for diagnosing between the DME control unit and fasters are made with both leads K and L. Check the following points when diagnosing is not possible.

**1. Power flow test (see wiring diagram)**

Lead L: Pin 7 (19-pin diagnostics socket) - Pin 13 (DME plug)

Lead K: Pin 8 (19-pin diagnostics socket) - Pin 55 (DME plug)

**2. Ground short test (see wiring diagram)**

Lead L: Voltage on Pin 7 (19-pin diagnostics socket) must be > 8 V with the ignition turned on.

Lead K: Voltage on pin 8 (19-pin diagnostics socket) must be > 8 V with the ignition turned on.

**Possible Causes of Fault:**

- Ground short or break in wiring or plug connections.
- Faulty control unit, which is connected on these leads (could be any diagnosable control unit; does not always have to be the DME control unit).

Checking: Pull off plugs on diagnosable control units one after the other until there is > 8 V. Replace fault-causing control unit.

- Tester faulty.
- Power supply lacking on diagnostics socket.
- Ground supply lacking on diagnostics socket.

**Information for idle speed and idle speed CO test:****a) Idle speed**

944 S engines have adaptive idle speed volumetric efficiency regulation since 1987 models. This means that the idle speed of all versions does not have to be adjusted. The system of cars with adaptive idle speed volumetric efficiency regulation should be adapted each time the DME control unit had been disconnected on permanent positive or after each inspection.

Idle speed control value for engine at operating temperature:

**840 +/- 40 rpm**

**b) Idle speed CO of cars without catalytic converter**

CO level is still adjusted on the CO adjusting screw in the air flow sensor.

Requirements:

- Engine at operating temperature.
- Engine and ignition in perfect running condition.
- All electric consumers switched off.
- CO tester at operating temperature, calibrated and adjusted correctly.

**Adjusting value: 0.5 - 1.5 % CO**

at 840 +/- 40 rpm and ignition timing of 10° +/- 3° before TDC.

Adapt the system after adjusting the CO level. An adapter plug (911.612.422.8) must be connected on the oxygen sensor connecting lead of cars without a catalytic converter, in order to avoid diffusion (see wiring diagram).

**c) Idle speed CO of cars with catalytic converter**

In addition to adaptation of the idle speed there is also adaptation of the idle speed CO level in these cars, so that it is only necessary to check the actual state in such cars.

Requirements:

- Engine at operating temperature.
- Engine and ignition in perfect running condition.
- All electric consumers switched off.
- CO tester at operating temperature, calibrated and adjusted correctly.
- **Oxygen sensor plug connected.**

**Test value: 0.4 - 1.2 % CO**

at 840 +/- 40 rpm and ignition timing of 10° +/- 3° before TOC.

**Afterwards the engine must be run at least 10 minutes after disconnection of the control unit plug or disconnection of the battery, before it will be possible to recheck these values. In addition, the system must be adapted.**



### Coding of Control Unit - 944 S

Pertinent curve families are integrated in the DME control unit, in order to be able to comply with the legislation of different countries. They can be read direct in the "actual value" menu with a 9288 System Tester.



One each 2-pin and 3-pin plug, which are bridged differently depending on the country version, lead out of the DME wire harness to call these curve families.

Country	Curve Family Switch 2 Pins	Version Switch 3 Pins
USA Federal States FAG M 298 Oxygen sensor	-	-
USA California Japan Oxygen sensor	-	Bridge against battery voltage 928.607.421.00
ECE	-	Bridge against grd. 928.607.422.00
Sweden	-	Resistance 6.8 k $\Omega$ against grd. 944.612.522.00
Australia Oxygen sensor	Bridge against ground 944.612.515.00	-

**Coding of Control Unit - 944 S 2**

Country	Curve Family Switch 2 Pins	Version Switch 3 Pins
All with cat. conv.	-	-
California, Japan	-	Bridge against battery + 928.607.421.00
All without cat. conv.	-	Bridge against grd. 928.607.422.000

As from model year '91, the code for California and Japan is being deleted (identical worldwide).

**Check-Engine Lamp**

**(Malfunction Indicator Light M.I.L)**

As from model year '91, Californian legislation prescribes a warning lamp which lights up if a part relevant to the exhaust gas fails.

As a function check of the warning lamp, it lights up when the ignition is switched on and goes out once the engine is running when this is started without depressing the accelerator.

The warning lamp has a flashing code to indicate a defective fault path.

To trigger off the flashing code, fully depress the accelerator pedal with the engine off and the ignition on for 3 seconds until the Malfunction Indicator Lamp flashes. Then remove foot from accelerator.

If no fault is recorded, i.e. no warning came from the indicator light, there appears the flashing code

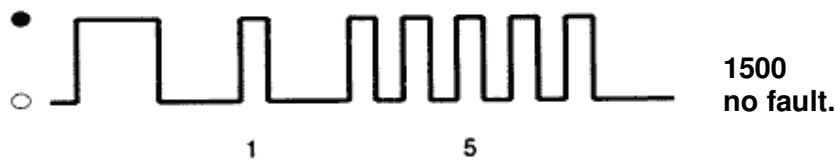

● = Lamp on    ○ = Lamp off

If the warning light did indicate a warning, i.e. there is a fault, there appears a flashing code, e.g.

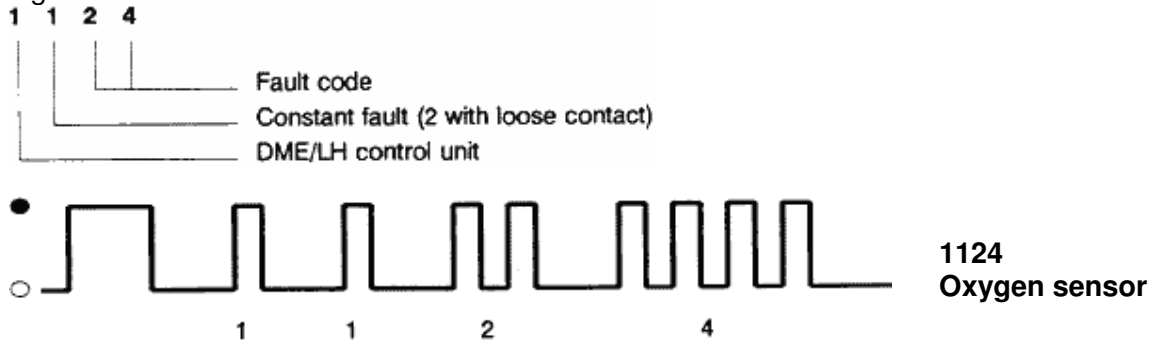

The flashing code is listed in the Diagnosing/Troubleshooting plan on page D 24/28-7. The fault can also be read direct using System Tester 9288. After a repair the fault memory must be erased using the **System Tester**.