



**MULTI-CARRIER
POWER AMPLIFIER
MCPA**

Product Number 1/KRB 101 1108

**INSTALLATION, OPERATION AND
MAINTENANCE INSTRUCTIONS**

Ericsson Amplifier Technologies Inc.
Technical Publication MCPA
Revision A

PREPARED
May 23, 2001

**NOTICE
PROPRIETARY AND PRIVATE**

The information contained in this document is the property of Ericsson Amplifier Technologies Inc., (Company) and shall be kept in strict confidence. Except with the written permission of the Company, such information shall not be published, or disclosed to others, or used for manufacture or sale or for any other purpose. This document shall not be duplicated in whole or in part. Any recipient so agrees by acceptance of this document.

ERICSSON AMPLIFIER TECHNOLOGIES INC.

49 Wireless Boulevard

Hauppauge, New York 11788

(631) 357-8200

The following symbols are used throughout this technical manual:

WARNING



THIS SYMBOL INDICATES IMPORTANT INFORMATION THAT IS EMPHASIZED TO ALERT THE READER TO THE POTENTIAL RISK OF PERSONAL INJURY TO THE OPERATOR OR OTHER PERSONNEL.

CAUTION



This symbol indicates important information that is emphasized to alert the reader to the potential risk of damage to the amplifier.

NOTE



This symbol indicates information that is highlighted signifying an operation or procedural step requiring additional emphasis.

WARNING



THE USE OF AN EARTH GROUND IS REQUIRED TO ENSURE SAFETY.

IF THE EQUIPMENT APPEARS TO BE DAMAGED IN ANY WAY, REMOVE ALL POWER TO THE UNIT, AND HAVE IT SERVICED AS SOON AS POSSIBLE.

Ericsson Amplifier Technologies Incorporated provides this technical manual “as is” without warranty of any kind, either expressed or implied. Ericsson Amplifier Technologies may make improvements or changes to the product and/or manual at any time without notice.

Every effort has been made to ensure the accuracy and completeness of this technical manual, however, it may contain technical inaccuracies or typographical errors. Changes are made periodically to the information contained herein. These changes will be incorporated into new editions of this technical manual.

Ericsson Amplifier Technologies is interested in receiving comments from the users of this manual in order to improve its usefulness. All comments should be directed via regular mail to the address listed on the title page of this document. Ericsson Amplifier Technologies may use or distribute any of the information supplied in any way it believes appropriate, without incurring any obligations.

All specifications are subject to change without notice.



RETURN FOR REPAIR

FIELD OPERATION SUMMARY SHEET

Please make a copy of this sheet, and complete the following questionnaire. If necessary, attach additional sheets. This information will assist in expediting repairs to the equipment, and is used for fault trend analyses and ongoing product improvement.

FIELD TECH NAME: _____ DATE: _____

EQUIPMENT LOCATION (CELL SITE NUMBER): _____

MODEL NUMBER: _____

SERIAL NUMBER: _____

FREQUENCY OF OPERATION: A: _____ B: _____

CARRIER POWER: _____

MAXIMUM NUMBER OF CARRIERS: _____

LED INDICATOR STATUS:

LED DESCRIPTION	LED ON	LED OFF
	Check <input checked="" type="checkbox"/>	Check <input checked="" type="checkbox"/>
DC ON:	<input type="checkbox"/>	<input type="checkbox"/>
ENABLE:	<input type="checkbox"/>	<input type="checkbox"/>
FAN ALARM:	<input type="checkbox"/>	<input type="checkbox"/>
LOOP ALARM:	<input type="checkbox"/>	<input type="checkbox"/>
VSWR ALARM:	<input type="checkbox"/>	<input type="checkbox"/>
POWER SUPPLY ALARM:	<input type="checkbox"/>	<input type="checkbox"/>
TEMPERATURE ALARM:	<input type="checkbox"/>	<input type="checkbox"/>
OVER POWER ALARM:	<input type="checkbox"/>	<input type="checkbox"/>

UNIT SURFACE TEMPERATURE: _____

POWER SUPPLY MODEL OR CAPABILITY: _____

OTHER DETAILS OF PROBLEM REPORTED: _____

Table of Contents

1. GENERAL DESCRIPTION	1
1.1 Introduction	1
1.2 Related Publications	1
1.3 General Description.....	1
1.4 Equipment Functional and Physical Specifications.....	2
1.5 Mechanical Description.....	3
2. INSTALLATION	4
2.1 Introduction	4
2.2 Electrical Service Recommendations.....	4
2.3 Receiving, Unpacking and Inspection.....	4
2.4 Repackaging for Shipment	4
2.5 Environmental Limitations.....	5
2.6 Installation	5
2.6.1 Recommended Tools.....	5
2.6.2 Blind Mate Configuration Mounting	5
2.7 Cable Interconnections	7
2.8 Verify Connections.....	8
2.9 Verify DC Supply Voltage.....	8
3. OPERATING INSTRUCTIONS	9
3.1 Safety Precautions	9
3.2 Controls and Indicators	10
3.2.1 Local Controls and Indicators.....	10
3.2.2 MCPA Power ON/OFF Sequence Summary	13
3.2.3 Remote Control/Status Interface.....	15
3.3 Initial Turn On Procedure.....	15
3.4 Normal Operation	16
3.5 Shut Down Procedure	16
4. PRINCIPLES OF OPERATION	17
4.1 Introduction	17
4.2 RF Input Signal	17
4.3 RF Output Load	17
4.4 System Functional Description	17
4.4.1 Main Amplifier	19
4.4.2 Error Amplifier	19
4.4.3 Amplitude and Phase Adjustment	19
4.4.4 Amplifier Module Cooling.....	20
4.5 Power Distribution.....	20
4.6 Intermodulation Distortion Performance	20
4.6.1 Intermodulation Distortion	20
4.7 Description of Operating Modes.....	20
4.7.1 Default mode	20

4.7.2	Standby Mode:	21
4.7.3	DC On Mode	21
4.7.4	Enable Mode.....	21
4.7.5	Shutdown Mode	21
4.7.6	ALC Mode	21
4.7.7	Locking Mode.....	22
4.8	Description of Alarm Conditions	22
4.8.1	LOOP Alarm	22
4.8.2	VSWR Alarm	22
4.8.3	TEMP/WARN Alarm	22
4.8.4	PWR SPLY Alarm	23
4.8.5	FAN Alarm.....	23
4.8.6	OVER PWR Alarm	23
5.	MAINTENANCE	25
5.1	Introduction	25
5.2	Periodic Maintenance.....	25
5.2.1	Cleaning Air Inlets/Outlets	26
5.2.2	Test Equipment Required	26
5.2.3	Performance Tests	26
5.3	Troubleshooting Procedures.....	27
5.4	Fan Assembly Replacement Procedure	27

List of Figures

Figure 1.	Ericsson Amplifier Technologies Inc. Multi-Carrier Power Amplifier.....	2
Figure 2.	Outline/Installation Drawing, Ericsson Amplifier Technologies MCPA	6
Figure 3.	MCPA Local Controls and Indicators.....	11
Figure 4.	MCPA Power ON/OFF Sequence.....	14
Figure 5.	Block Diagram, MCPA Power Amplifier	24
Figure 6.	MCPA Troubleshooting Flow Chart	28

List of Tables

Table 1.	Performance Characteristics, MCPA Power Amplifier	3
Table 2.	J1 – Blind Mate 24W7 D Sub-miniature Connector	7
Table 3.	MCPA Local Controls and Indicators	12
Table 4.	Periodic Maintenance Tasks.....	25
Table 5.	Test Equipment Required	26

1. GENERAL DESCRIPTION

1.1 Introduction

This manual provides information for the installation, operation and maintenance of Ericsson Amplifier Technologies MCPA multi-carrier power amplifier.

The manual is organized in 6 sections as follows:

- Section 1. General Description
- Section 2. Installation
- Section 3. Operating Instructions
- Section 4. Principles of Operation
- Section 5. Maintenance
- Section 6. Photographs

1.2 Related Publications

TMHPC8689-400 - ERICSSON AMPLIFIER TECHNOLOGIES
INSTALLATION, OPERATION AND
MAINTENANCE INSTRUCTIONS FOR
SUBRACK ASSEMBLY

1.3 General Description

The MCPA (Figure 1) is a microprocessor controlled, linear multi-carrier power amplifier (MCPA), which operates over the frequency range of 869 to 894 MHz with a rated output power of 120 watts total (average). At rated output, the amplifier provides intermodulation products of better than 63 dBc. The design of the MCPA is entirely solid state, providing trouble free operation and a minimum of maintenance. The MCPA includes a high-speed I/O port to receive commands from the host controller. The MCPA is equipped with microprocessor controlled status monitoring and control circuitry which monitors key MCPA operating conditions and provides remote status output via the rear panel I/O connector. Local operating status is provided via front panel LED indicators. The MCPA is powered by an external (customer supplied) 26-28 VDC power supply.

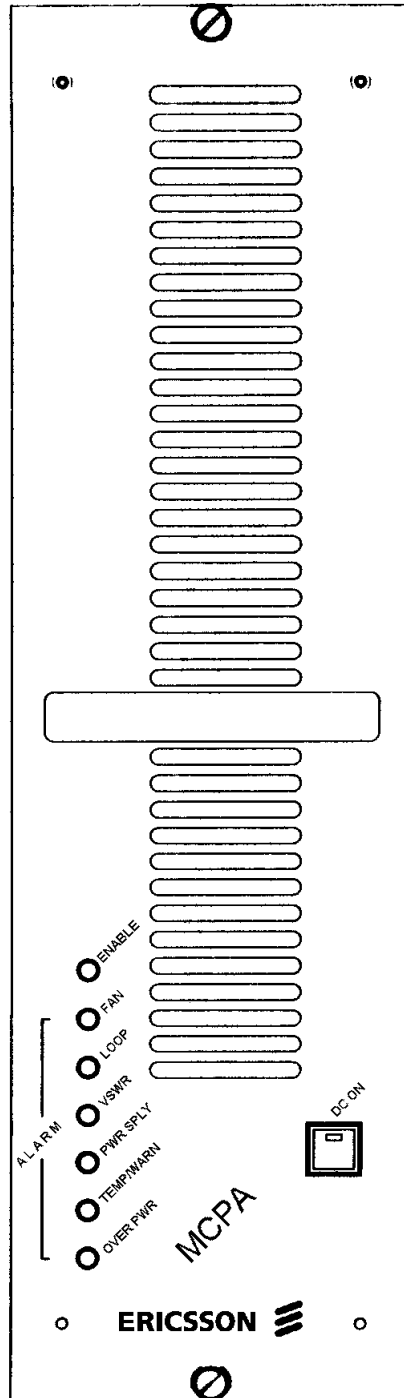

Figure 1. Ericsson Amplifier Technologies Inc.
MCPA Power Amplifier

1.4 Equipment Functional and Physical Specifications

Table 1 lists the functional and physical specifications of the MCPA power amplifier.

**Table 1. Performance Characteristics
MCPA Power Amplifier**

PERFORMANCE CHARACTERISTICS	
Parameter	Specification
Frequency	869 - 894 MHz
RF Output Power	120 Watts Average
Intermodulation Distortion	-3 dBc minimum when measured with 50 random phase sets.
Gain	69.5±0.25 dB
Modulation Format	Any
Input Return Loss	14 dBr Minimum
Load Stability	VSWR unconditional, all phases
Current Consumption	50 amperes nominal @ 27 VDC
DC Input	Fully operational from 26 to 28 VDC
Operating Temperature	5° to 40° C
Operating Humidity	20% to 80% RH, non-condensing
Storage Humidity	20% to 95% RH, non-condensing
Dimensions	17.88" H x 5.12" D x 16.5" D 45.4 cm H x 13 cm W x 41.9 cm D (Optional Configuration Available)
RF, DC, and I/O interface (Blind mate):	24W7 Sub-miniature connector, OSP
LED Status Monitoring	Loop Alarm, VSWR Alarm, Temperature Alarm, Power Supply Alarm, Fan Alarm, Over Power Alarm, and DC On

1.5 Mechanical Description

The MCPA is contained in a chassis that can be mounted in a subrack enclosure. A central heatsink is permanently mounted as part of the assembly (casting/housing). Cooling is provided by 2 integral rear mounted fans that are easily replaced without the need for chassis disassembly, or removal of power to the amplifier. Airflow through the MCPA is from front through the rear of the unit.

2. INSTALLATION

2.1 Introduction

This section contains receiving, unpacking and installation recommendations for the Ericsson Amplifier Technologies MCPA multi-carrier power amplifier. Carefully read and review all of the information contained in this section before attempting to install or operate the MCPA. In addition, read and review the operating instructions contained in Section 3 before operating the equipment.

2.2 Electrical Service Recommendations

Ericsson Amplifier Technologies strongly recommends the use of AC line conditioning and surge suppression devices at the primary AC input to the power source for the MCPA. All electrical connections should be in accordance with the National Electric Code, and any applicable state and local codes. In addition, lightning protection for all systems is strongly recommended. The electric service must be well grounded.

The amplifier power source should be equipped with a separate circuit breaker, installed in a load center with a separate mains switch or breaker. This arrangement permits future service and maintenance of the MCPA without the necessity for removing power to the entire site.

2.3 Receiving, Unpacking and Inspection

The MCPA has been tested and calibrated at the factory prior to shipment. No additional readjustment is required prior to installation.

The MCPA is shipped in a single container. Check the exterior of the shipping container for any visible signs of damage. If possible, open the container in the presence of the delivery agent. Carefully unpack the MCPA and save all packing material for possible reshipment. After removal from the container, check the MCPA for physical damage such as scratched panels, damaged connectors, etc. If damage is noted, immediately file claim with the delivery agent or freight carrier.

2.4 Repackaging for Shipment

Should it ever become necessary to re-ship the MCPA for service or repair, the following procedure should be followed.

- a. Use the original container, if possible.
- b. Wrap the item in heavy paper or plastic before placing it in the shipping container.
- c. Use packing material around all sides of the item.
- d. Use a heavy cardboard box or a wooden container to house the item. Seal the container with heavy-duty tape (Fiberglas) or strap the container with metal bands.
- e. Mark the container: "FRAGILE - DELICATE INSTRUMENT".

2.5 Environmental Limitations

The MCPA is designed to operate in an environment as noted in Table 1 of this manual. The MCPA must be installed in an area where an adequate and unrestricted supply of air is available for cooling. Adequate clearance must be provided to prevent obstruction of airflow. Confirm that proper dc power is available for the equipment.

2.6 Installation

The amplifier is produced in a Blind Mate configuration as shown in Figure 2. The Blind Mate configuration is designed for mounting in an Ericsson Amplifier Technologies subrack, and features a single connector on the rear panel for all RF, DC and I/O interface connections. The following paragraphs provide installation details.

2.6.1 Recommended Tools

The following tools are recommended to assist in the installation of the amplifier.

- #1 and #2 Phillips screwdrivers
- Slotted screwdrivers, 1/8" and 1/4"
- A 5/16" or 3.5mm open-end wrench
- A multi-meter with probes

2.6.2 Blind Mate Configuration Mounting

- a. Install an amplifier module into each of the mating slots of the subrack, beginning from the left. Use firm, but not excessive force when installing the amplifiers to ensure a good connection is made.
- b. Hand tighten the retaining screws on the front panels of the amplifier modules. Do not over tighten.
- c. Ensure that an unrestricted supply of air is available at the front and rear of the enclosure for cooling.

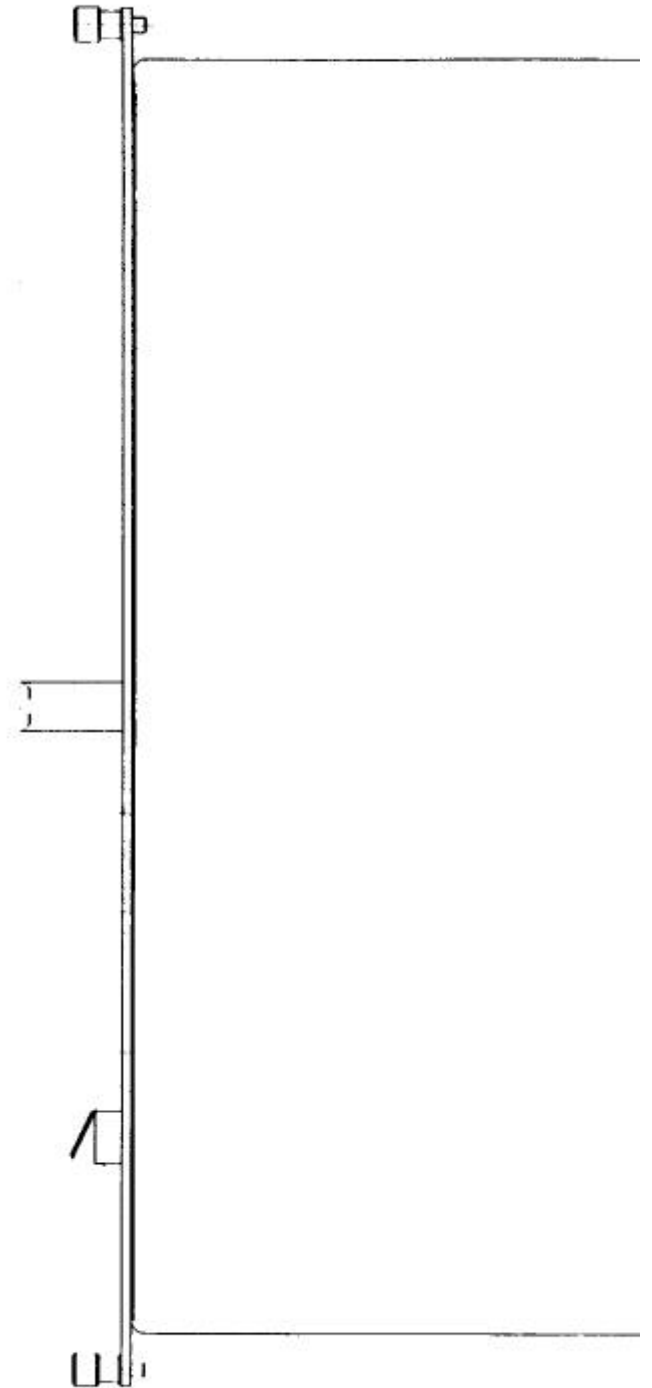
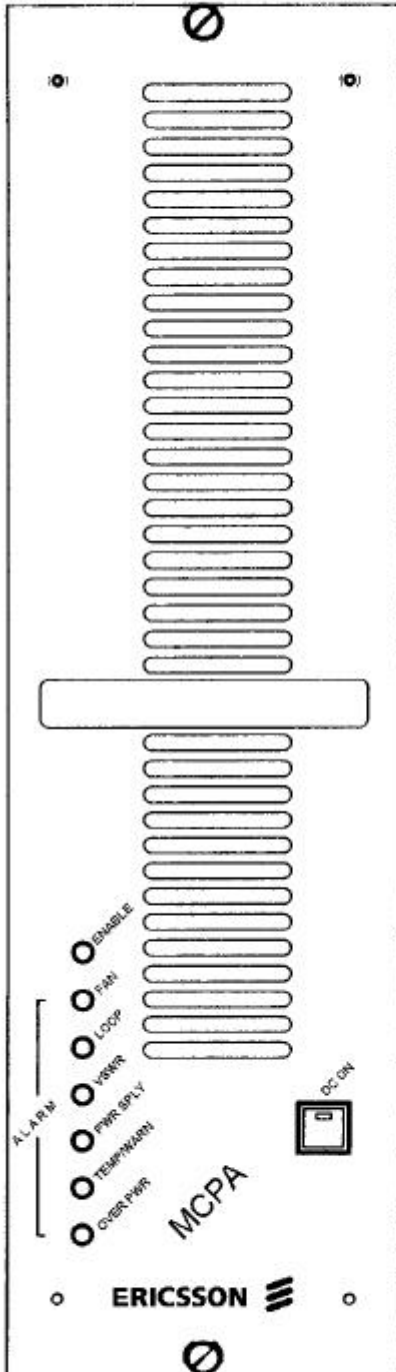

2.7 Cable Interconnections

The MCPA is produced in a Blind Mate configuration. The following paragraphs provide interconnection details.

CAUTION



VERIFY THAT PROPER DC VOLTAGE IS AVAILABLE TO MCPA BEFORE CONNECTIONS ARE MADE. DAMAGE TO THE MCPA CAN OCCUR IF IMPROPER VOLTAGES ARE APPLIED.

The RF input, DC, and I/O interface is incorporated into a 24W7 Blind Mate “D” sub-miniature connector, J1. Connections are as shown in Table 2. RF output is via an OSP Blind Mate connector, J2.

Table 2. J1 – Blind mate 24W7 D Sub-miniature Connector

J1-Connector Pin	Signal Name	Description
A1	RF In PKZ26	
A2, A7	No Connection	No Connection
A3, A4	+DC Power In	
A5, A6	DC Power Return	
1-6	No Connection	No Connection
7	RS-232 RXD_PS	Data Out 1
8	RS-232 TXD_PS	Data In 1
9	Signal Ground	Ground
10	RUN/PGM PS	
11	RS-232 TXD_IMD	Data Out 2
12	RS-232 RXD_IMD	Data In 2
13	RUN/PGM IMD	
14	PA ID, GND	
15-17	No Connection	No Connection

2.8 Verify Connections

Recheck all connections. Make certain that all connections are correct and secure.

2.9 Verify DC Supply Voltage

Measure the DC supply voltage that will power the MCPA at the subrack terminals. **The DC supply voltage must be 27 VDC \pm 0.5 VDC. In addition, the power supply circuit breaker rating must be 75 amperes minimum.** Refer to Section 3 for operating instructions.

CAUTION



DO NOT OPERATE MCPA WITH A DC SUPPLY VOLTAGE OUTSIDE OF THESE LIMITS. DAMAGE WILL OCCUR TO THE MCPA FROM IMPROPER SUPPLY APPLICATION.

NOTE



When +27VDC is initially connected and applied to the MCPA, all of the LED's on the front panel except for the DC On will illuminate momentarily.

3. OPERATING INSTRUCTIONS

3.1 Safety Precautions

During normal MCPA operation, personnel must be cognizant of the intrinsic hazards related to electronic equipment in general, and RF power amplifiers in particular. This amplifier subsystem generates high RF power (120 watts) which is dangerous and can cause serious RF burns if contacted. Caution must be exercised when working with this amplifier. While every practicable safety precaution has been incorporated into this amplifier, the following rules must be strictly observed:

WARNING

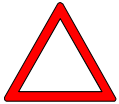

KEEP AWAY FROM LIVE CIRCUITS

Operating personnel must observe all safety regulations at all times. Do not make adjustments inside equipment with hazardous voltages present. Do not operate the amplifier without proper RF termination.

DO NOT SERVICE OR ADJUST ALONE

Under no circumstances should any person reach within or enter any enclosure for purposes of servicing or adjustment without the immediate presence and assistance of another person capable of rendering aid. Knowledge of first aid for electrical shock and burns is necessary.

PERSONNEL

Only trained personnel are to service and adjust the amplifier. Personnel must be trained in the maintenance of equipment with hazardous RF power, and must be familiar with this amplifier. In addition, the following precautions must be observed during operation.

WARNING

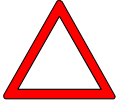

MAINTAIN PROPER TERMINATION AT THE OUTPUT PORT OF THE MCPA. DO NOT REMOVE OR EXCHANGE RF CABLES OF THE OUTPUT LOAD CIRCUIT WHILE THE MCPA IS IN OPERATION. DANGEROUS RF VOLTAGE MAY EXIST AT THE FOREMOST TERMINAL OF THE INTERRUPTED LOAD CIRCUIT DURING OPERATION.

CAUTION



All interconnecting cables must be connected prior to application of RF power. Although the MCPA is designed to withstand all output load conditions including open and short circuit conditions, it is recommended to connect an appropriate RF load to the output port of the MCPA prior to application of RF power.

CAUTION



Maintain proper RF input to the MCPA. Damage to the MCPA may occur if excessive RF input is applied.

3.2 Controls and Indicators

The MCPA is equipped with local controls and indicators on the front panel, and a rear panel I/O interface for remote status monitoring and control. The following paragraphs detail these features.

3.2.1 Local Controls and Indicators

Figure 3 is the front view of the MCPA. Table 3 describes the local controls and indicators.

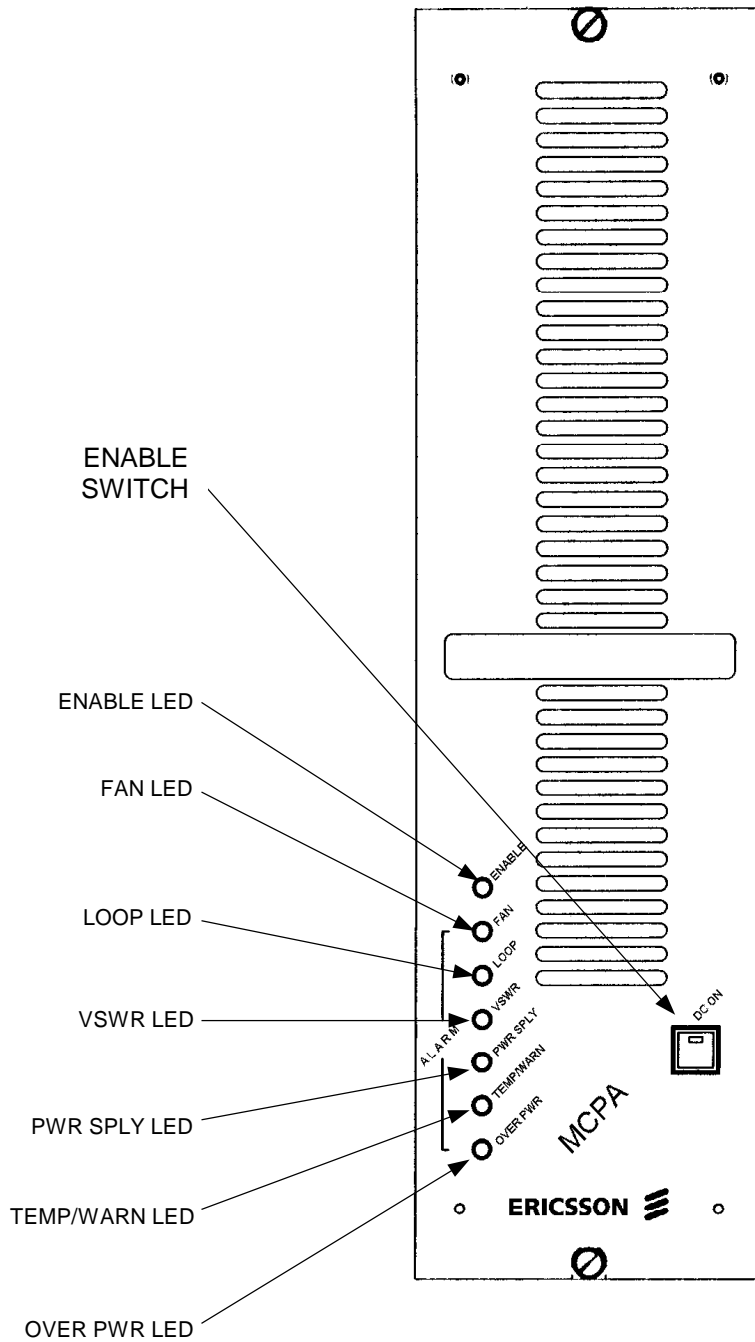

Figure 3. MCPA Local Controls and Indicators

**Table 3.
MCPA Local Controls and Indicators**

CONTROL/INDICATOR	FUNCTION
DC ON -	Power Supply switch and integral DC ON green LED indicator, enables the external high power +27V power supply circuitry.
ENABLE ON -	Green LED indicates unit is ENABLED, biased on and the amplifier is ready to amplify signals.
FAN ALARM -	Yellow LED indicating a blocked or non-functioning fan.
LOOP ALARM (Steady On)-	Steady (not blinking) Red LED indicating internal control loops can no longer minimize IMD performance. The sequence of disable and enable commands may be used to reset the loops to their normal conditions.
LOOP ALARM – (Blinking On/Off, indicates Locking Mode)	Blinking red LED indicating Locking Mode has been entered. The locking mode is used to indicate when the module is unable to minimize IMD performance and is attempting to adjust loop coefficients. During this mode, IMD performance may not meet specified values. The module will attempt to improve performance for 1 minute. If unable to improve performance during this period, the module will indicate a loop alarm and enter the shutdown mode, and will require power to be reset in order to clear the fault.
VSWR ALARM -	Red LED indicating load VSWR is greater than 3.0:1. Amplifier will enter shutdown mode, and will require power to be reset in order to clear the fault.
POWER SUPPLY ALARM -	Red LED indicating a power supply generated voltage is out of range. Amplifier will enter shutdown mode, and will require power to be reset in order to clear the fault.
TEMP WARNING/ALARM - Dual color (Yellow/Red) LED.	<p>TEMP WARNING: Yellow color indicates approach of excessive operating temperature of approximately +80°C as monitored on the heatsink. Operation of the MCPA can continue uninterrupted during this warning condition.</p> <p>TEMP ALARM: Red color indicates excessive operating temperature of approximately +90°C as monitored on the heatsink. Operation of the MCPA is disabled until the heatsink has cooled to a safe operating temperature, at which point, operation will automatically resume.</p>
OVERPOWER ALARM -	Red LED indicating that the RF output power from the MCPA is greater than 2 dB above nominal output power. Amplifier will enter shutdown mode, and will require power to be reset in order to clear the fault.

NOTE



Activation of the **LOOP ALARM, VSWR ALARM, POWER SUPPLY ALARM, TEMP ALARM** or **OVERPOWER ALARM** will cause the Amplifier to enter shutdown mode. The amplifier will attempt to auto recover up to three times within 24 hours. If the alarm is still present, the amplifier will continue to shutdown. The amplifier may also be manually reset using the front panel button. Refer to Figure 4, which details the ON/OFF sequence of the MCPA.

3.2.2 MCPA Power ON/OFF Sequence Summary

Figure 4 is a functional diagram of the MCPA Power ON/OFF sequence.

Initially, the MCPA +27 VDC and +15 VDC bias are both off.

After depressing the On/Off switch, both the external +27 VDC and +15 VDC bias are on. Typical current without any RF applied to the MCPA is 18 amps.

Depressing the On/Off switch again will turn off the MCPA module completely, as it was initially.

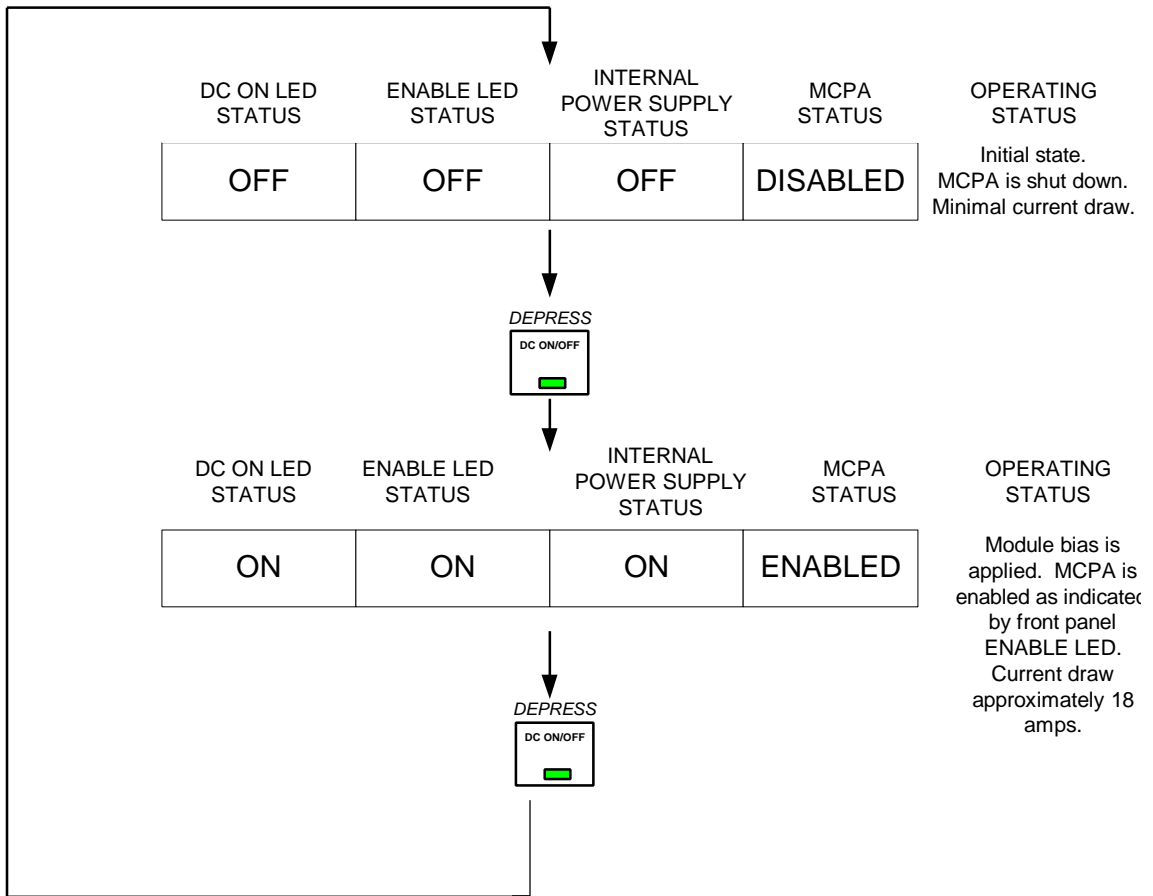

NOTE:
 If resetting power to the MCPA does not clear the fault condition, contact Ericsson Amplifier Technologies, or return MCPA for service.

Figure 4. MCPA Power ON/OFF Sequence

3.2.3 Remote Control/Status Interface

The MCPA is equipped with control inputs and status outputs at the I/O interface. Section 2.7 details the interfaces for the Blind mate configurations and describes the signals.

3.3 Initial Turn On Procedure

The following procedure is intended to verify operation of the MCPA following installation, repair or replacement.

WARNING

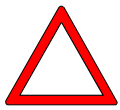

EQUIPMENT OPERATORS MUST BE FAMILIAR WITH ALL SAFETY PRECAUTIONS OUTLINED AT THE BEGINNING OF THIS SECTION PRIOR TO OPERATING THE MCPA. OPERATOR INJURY AND/OR EQUIPMENT DAMAGE WILL RESULT FROM IMPROPER OPERATION.

a. Verify that all connections to the MCPA have been properly made in accordance with Section 2 of this manual, and the outline and installation drawing, Figure 2.

NOTE



When +27VDC is initially connected and applied to the amplifier, all of the LED's on the front panel, except for the DC ON, will illuminate momentarily. This is a normal condition.

b. With no RF applied to the MCPA, press the POWER ON/OFF switch once. The DC ON LED (part of the ON/OFF switch) will be illuminated, and the fans will be activated.

c. Observe that **only** the following indicators are illuminated on the MCPA front panel:

DC ON
ENABLE

d. Apply reduced RF input (-40 dBm) to the MCPA RF IN connector within the 869-894 MHz frequency range, and observe that **only** the DC ON and ENABLE LED indicators remain illuminated.

CAUTION



Maintain proper RF input level within the 869-894 MHz operating band. Improper RF input may cause severe MCPA damage.

g. Increase input level to between -19 and -15 dBm, and observe that **only** the following indicators are illuminated on the MCPA front panel.

DC ON
ENABLE

3.4 Normal Operation

The MCPA requires minimum attention during normal operation. Monitoring of the status output provides an overall indication of MCPA health.

3.5 Shut Down Procedure

- a. Reduce RF input signal level to minimum (-60 dBm).
- b. Press the PWR ON/OFF switch **once** to disable the bias voltage and to disable +27 VDC to the internal amplifier module. The DC ON indicator will be extinguished.

WARNING



THE DC ON/OFF SWITCH DOES NOT CONTROL THE MAIN +27 VDC FEED TO THE MCPA. IF MAINTENANCE OR SERVICE IS TO BE PERFORMED ON THE MCPA, DEACTIVATE PRIME DC POWER AT ITS SOURCE.

4. PRINCIPLES OF OPERATION

4.1 Introduction

This section contains a functional description of the multi-carrier power amplifier. Refer to the block diagram of the MCPA, Figure 5, located at the end of this section.

4.2 RF Input Signal

The maximum input signal for all carrier frequencies must not exceed the limits specified in the electrical specifications. The input VSWR should be 2:1 maximum (or better).

4.3 RF Output Load

The load impedance should be as close as possible to 50 ohms (VSWR of 1.5:1 or less) over the 869-894 MHz operating frequency band to ensure maximum RF power transfer to the load.

4.4 System Functional Description

The MCPA amplifier is a multi-carrier, feed forward power amplifier, which operates from 869 to 894 MHz with a rated output power of 120W total (average). The amplifier employs feed forward carrier cancellation circuitry, providing extremely low intermodulation products, equal to or less than -63 dBc. The front panel of the amplifier contains the DC ON/OFF switch, and the status LEDs. The amplifier operates from a 26-28 VDC input power source, and provides a rear panel input/output (I/O) control and status interface to report all faults and alarms. Relay dry contacts are provided for the following fault conditions:

OVERPWR – Relay dry contact closure provided for remote notification in the event that the MCPA output is greater than 2 dB above the nominal operating power level. The MCPA power will need to be reset in order to clear this fault condition.

MINORFLT – Relay dry contact closure provided for remote notification in the event that the MCPA has encountered a minor fault condition, which has not caused shut down of the amplifier, but which will require attention as soon as possible in order to ensure uninterrupted operation. A TEMP WARNING or FAN ALARM will result in a MINORFLT condition and remote notification. The MCPA power will need to be reset in order to clear this fault condition.

MAJORFLT – Relay dry contact closure provided for remote notification in the event of a potentially damaging fault condition, which has resulted in shut down of the MCPA. Activation of the LOOP ALARM, VSWR ALARM, POWER SUPPLY ALARM, TEMP

ALARM and OVERPOWER ALARMS will result in a MAJORFLT condition and remote notification. The MCPA power will need to be reset in order to clear this fault condition.

TTL control inputs are provided at the I/O interface. The Control and Status interface is an 8-bit asynchronous serial bus, which complies with the EIA/TIA 232-E type Standard for Electrical Characteristics for use in Balanced Digital Systems. The communications protocol is as follows:

- Half Duplex
- 1 Start bit
- 1 Stop bit
- 8 Data bits
- No Parity
- 9600 bits per second (baud)

The MCPA will respond to commands, and will send a response only when commanded first.

Although the MCPA contains no user-serviceable components (with the exception of the fan assemblies), the following paragraphs provide operating principles, and a general overview of its operation. Figure 5 is a functional block diagram of the MCPA. The amplifier is comprised of the following internal functional elements:

- Carrier Cancellation
- Main/Error Driver Amplifier
- Main Amplifier
- Error Amplifier
- DC/DC Function
- Microprocessor Control
- Loop Processor
- Pre-distorter

The main amplifier employs class AB amplification for maximum efficiency and low intermodulation distortion. The error amplifier and main/error driver amplifiers operate class A mode. The input RF signal is amplified by the carrier cancellation circuit, and then split into a signal and a reference path. The signal path is sent through the main driver amplifier, where the amplitude and phase are modified, based on the reference signal, and then amplified by the main amplifier. The signal is coupled to the carrier cancellation circuit where the 180° phase shifted and amplified signal meets the reference signal. At this point the combined signal, which has a canceled carrier (called the IMD signal), is sent to the IMD leg of the feed forward amplifier.

The IMD signal is sent to the error driver amplifier and error amplifier. Signal amplitude and phase are adjusted from the input by the loop processor. The signal is re-injected into the main amplifier output signal, and the combined signal yields suppression of intermodulation products of -65 dBc minimum.

The following paragraphs describe each of the functional elements of the MCPA.

4.4.1 Main Amplifier

The main amplifier operates class AB, and provides approximately 29.5 dB of gain over the operating frequency band of 869-894 MHz. It operates from 27 VDC and utilizes 15 VDC to derive bias. The main amplifier is directly mounted to the heatsink. Within the main amplifier are temperature sensors, which detect the baseplate (heatsink) temperature. In the event that the heatsink temperature reaches approximately +80 °C, the TEMP WARNING (yellow) LED will be illuminated. Operation of the MCPA may continue during this condition. In addition, should the heatsink temperature further rise to approximately +90°C, bias to the internal amplifier is shut down to prevent damage during the over temperature condition. The TEMP ALARM (red) LED will be illuminated. Operation of the MCPA is inhibited until the heatsink temperature has returned to a safe operating level. The fault condition will automatically self-clear when the heatsink has cooled to a safe level, and normal operation will again be restored. The cause of any TEMP WARNING or TEMP ALARM condition should be investigated as soon as possible to ensure continuous uninterrupted MCPA operation.

4.4.2 Error Amplifier

The main function of the error amplifier is to amplify the distortion products generated by the main amplifier. These distortion products are amplified and precisely phase shifted (180° with those at the output), such that when they are combined with the main signal at the output of the amplifier, the result is cancellation of the distortion products. The error amplifier operates class A, has 57 dB of gain, and produces 2 watts of output. The amplifier operates from 27 VDC, and utilizes 15 VDC to derive bias. The error amplifier is mounted to the heatsink, and utilizes an output circulator to protect the error amplifier output. The load port of the circulator is connected to a detector to monitor reflected power. The resulting analog voltage is monitored by the microprocessor to prevent operation and damage to the MCPA in the event of excessive load VSWR. In the event of a load VSWR of greater than 3.0:1, the microprocessor will cause the MCPA to go into a VSWR FAULT mode, and remove bias to the internal amplifier for protection. Illumination of the front panel VSWR alarm indicator confirms this condition. The fault condition may be reset by re-setting power to the MCPA. Refer to Figure 4 for sequence.

4.4.3 Amplitude and Phase Adjustment

The two loops are controlled via the microprocessor through the main and error driver amplifiers. The amplifiers include vector control circuitry to adjust amplitude and phase

of the RF signals. The microprocessor controls the amplitude and phase adjustments of the two loops. The loop processor responds to the amplitude and phase of the IMD loops. In the event of a failure of the loops or processor, the front panel LOOP alarm indicator will be illuminated, and further operation of the MCPA will be inhibited. The fault condition may be reset by re-setting power to the MCPA. Refer to Figure 4 for sequence.

4.4.4 Amplifier Module Cooling

The amplifier is cooled via forced air through the heatsink. Two rear fans are used to draw air through the heatsink. The fans are field replaceable and are monitored for fan faults. In the event of a fan failure, the front panel FAN alarm indicator will be illuminated. Operation of the MCPA will continue, however, at some point, the TEMP WARN/ALARM circuitry may be activated due to reduced cooling, and may inhibit MCPA operation (refer to paragraph 4.4.1). The fan(s) are externally mounted and are easily replaced without removal of any of the MCPA covers, and without the need to shut down the MCPA. Refer to Maintenance section 5.4 for fan assembly replacement and ordering instructions.

4.5 Power Distribution

The amplifier employs a DC/DC converter to regulate the amplifier sub-circuits to the required voltage, based on a 26-28 VDC input. The power supply board converts the input voltage to +/-5V, and +/-15V used by the loop processor and microprocessor. Internal monitoring circuitry monitors the supply voltages, and activates the front panel POWER SUPPLY alarm LED indicator in the event of a fault. Operation of the MCPA is inhibited following detection of this fault. The fault condition may be reset by re-setting power to the MCPA. Refer to Figure 4 for sequence.

4.6 Intermodulation Distortion Performance

The MCPA amplifier is designed to deliver a 120W average power, multicarrier signal, with extremely low intermodulation products, over the passband of 869-894 MHz.

4.6.1 Intermodulation Distortion

When measured with fifty (50) random phase sets, intermodulation products are below -63 dBc.

4.7 Description of Operating Modes

4.7.1 Default mode

When **initially** powered up (or installed into the shelf), the MCPA amplifier defaults to the standby mode after a brief initialization sequence is completed. During the initialization sequence, the LEDs on the front panel will briefly illuminate.

4.7.2 **Standby** Mode:

(All LEDs off)

The MCPA has not had the DC power switch pressed and is not biased on. Low level communication (e.g. between the subrack and amplifier) is enabled.

4.7.3 **DC On** Mode

(DC Switch LED – ON)

The front panel DC on switch has been depressed, and the integral LED indicator is illuminated. When used with the Ericsson Amplifier Technologies subrack, the subrack acknowledges the initial operation of the module and configures the subrack to insert the module into the combining circuit, provided the module does not indicate an alarm which would shutdown the module. Thus the module system will reconfigure itself automatically as the additional modules are (DC) powered-up, to effectively use the new module.

4.7.4 **Enable** Mode

(DC Switch and Enable LED – ON)

The MCPA is amplifying the signal. (When used with Ericsson Amplifier Technologies subrack, all power is being combined.)

4.7.5 **Shutdown** Mode

Any of these LEDs ON: VSWR, OVER PWR, TEMP/WARN, LOOP or PWR SPLY

The MCPA amplifier has turned itself off for protection. All alarm indications are latched, and the amplifier is shutdown. The amplifier can be reset by pressing the DC switch. If the alarm still exists, the amplifier will re-enter the shutdown mode.

4.7.6 **ALC** Mode

(Blinking OVER PWR LED)

The module supports power limiting to mitigate an overdrive condition. When the OVER PWR LED blinks, the module has entered the ALC mode. In the ALC mode, the module limits the maximum transmit power to 0.5 dB above nominal output power by reducing the gain of the MCPA. The gain of the MCPA is continuously adjusted to maintain this limited value. If the loop circuits can no longer maintain the limited value due to excessive input power, the MCPA will protect itself by shutting down and indicate a overdrive condition with a steady OVER PWR LED indication. After 30 seconds, the MCPA will turn back on in the minimum gain setting, and attempt to limit power once again.

If the power is still too high during the subsequent attempt, the module will overdrive again and shutdown. The re-enable sequence will be performed three times before the module remains shutdown, and will require re-initialization (power up sequence) in order to reset.

If the output power is below the limited value during a subsequent attempt, the gain of the module will be increased until either the limited value is reached, or nominal gain is restored.

4.7.7 **Locking Mode**

(Blinking LOOP LED)

The locking mode is used to indicate that the module is unable to minimize IMD performance, and is attempting to adjust loop coefficients. During this mode IMD performance may not meet specified values. The module will attempt to improve performance for 1 minute. If unable to improve performance during this period, the module will indicate a loop alarm and enter the shutdown mode.

4.8 **Description of Alarm Conditions**

The amplifier reports various alarms, indicated via a front panel LED, and via the I/O connector on the rear. The following paragraphs detail the alarm conditions, and expected operation during each. Refer also to Table 3 for a description of the alarm indications.

NOTE



Activation of the LOOP ALARM, VSWR ALARM, POWER SUPPLY ALARM, TEMP ALARM or OVERPOWER ALARM will cause the MCPA to shut down. The fault condition may be reset by re-setting power to the MCPA. Refer to Figure 4 for sequence.

4.8.1 LOOP Alarm

Indicates control loops can no longer minimize IMD performance. The sequence of disable and enable commands may be used to reset the loops to their nominal setting.

4.8.2 VSWR Alarm

When the reverse power is more than 30 Watts for 5 seconds a VSWR is given.

4.8.3 TEMP/WARN Alarm

Two levels of temperature warnings are provided via the dual color TEMP/WARN LED. A yellow TEMP/WARN LED indicates module heatsink temperature has risen to a high level, approximately 80 degrees C. . Normal operation can continue, provided the temperature remains below the 90 degree C TEMP/WARN shutdown level. At approximately 90 degrees C, the TEMP/WARN indicator will switch to a red color,

indicating the excessive module heat sink temperature. The module will enter the shutdown mode. After sufficient cooling has occurred, and the fault no longer exists, the module will automatically re-enable itself.

4.8.4 PWR SPLY Alarm

This LED indicates a fault in a power supply generated voltage. The module will enter the shutdown mode, requiring re-initialization (power up sequence) in order to reset the fault condition.

4.8.5 FAN Alarm

This LED indicates that a fan is not operating or has been removed.

4.8.6 OVER PWR Alarm

This LED indicates that output power from the amplifier is above 52.8 dBm. The amplifier will enter the shutdown mode, requiring re-initialization (power up sequence) in order to reset the fault condition.

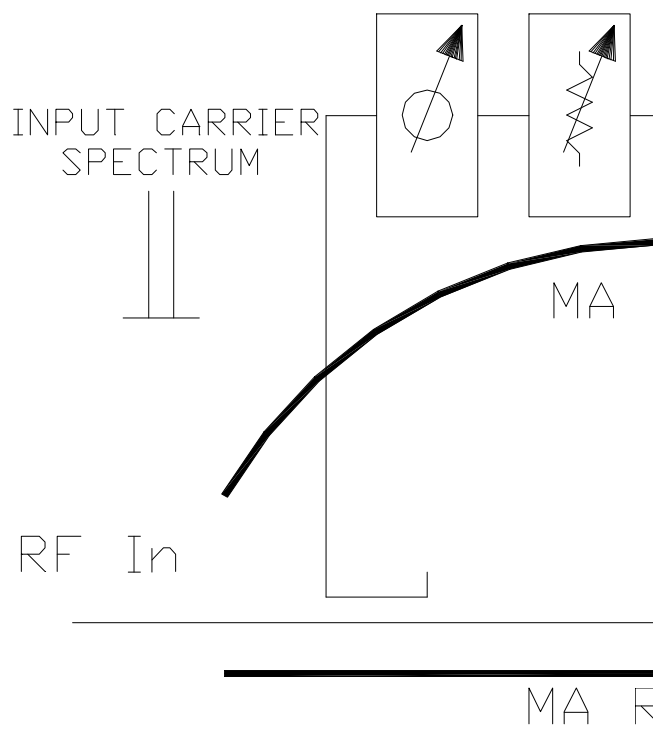

5. MAINTENANCE

5.1 Introduction

This section provides information for periodic maintenance of the MCPA, as well as tests which are recommended in order to evaluate performance of the amplifier. Refer to paragraph 5.3 for troubleshooting procedures for the MCPA.

CAUTION



Do not attempt to repair the MCPA. The amplifier contains no user-serviceable components, with the exception of the fan assemblies. Further damage will result from improper repairs.

NOTE



Do not break the seals on the equipment, as this will void the warranty.

5.2 Periodic Maintenance

Periodic maintenance tasks and recommended intervals are listed in Table 4.

Table 4. Periodic Maintenance Tasks

CATEGORY	TASK	RECOMMENDED INTERVAL	MAINTENANCE ACTION
Cleaning	Fans, Air Inlets/Outlets	30 Days	Inspect and clean in accordance with paragraph 5.2.1.
Inspection	Cables and Connectors	12 Months	Inspect all cables for any signs of damage or wear. Check and verify that all connections are secure.
Performance Tests		12 Months	Perform tests as outlined in paragraph 5.2.3.

5.2.1 Cleaning Air Inlets/Outlets

The air inlets and outlets are located at the front and rear of the unit. Air is drawn in from the front, and exhausted through the fans at the rear of the MCPA. These areas should be cleaned at 30 day intervals, or sooner, if the equipment is operated in a severe dust environment. Use dry, low-pressure compressed air, or a brush with soft bristles to loosen, remove and clean off any accumulated dust from the fans and the air inlet and outlet areas.

5.2.2 Test Equipment Required

Table 5 lists the test equipment required for evaluating MCPA performance. Suitable equivalents may be substituted.

Table 5. Test Equipment Required

NOMENCLATURE	QTY	MANUFACTURER	MODEL
Signal Generator	1	H/P	ESG
Attenuator, 40 dB, 250 Watt	1	Weinschel	S3-40-43
Attenuator, 20 dB, 20 Watt	2	Weinschel	AT20
Spectrum Analyzer	1	H/P	8560E
Directional Coupler, 30 dB	1	RF Power	DDC-901-931-R5-30
Power Meter/Sensor	1	H/P	437B/8481A
Power Supply	1	H/P	6673A

5.2.3 Performance Tests

Performance tests should be performed at 12-month intervals, or as directed by the resident maintenance authority, to ensure that the MCPA is functioning properly and within expected specification limits.

5.3 Troubleshooting Procedures

Figure 6 is the troubleshooting flow chart for the MCPA.

CAUTION



Do not attempt to repair the MCPA. The amplifier contains no user-serviceable components, with the exception of the fan assemblies. Further damage will result from improper repairs.



NOTE

Do not break the seals on the equipment, as this will void the warranty.

5.4 Fan Assembly Replacement Procedure

The fan assemblies are mounted to the rear of the MCPA. Replacement is accomplished by unlocking the 2 quick disconnects, which secure the fan to the rear panel. Disconnect fan wiring harness connector. Reconnect the fan wiring harness connector to the replacement fan. Mount replacement fan to rear panel by inserting the tabs and locking the 2 quick disconnects on the fan assembly to the rear panel of the amplifier chassis.

Replacement fan assemblies (part number BKV 106 59/1) can be ordered directly from Ericsson Amplifier Technologies.

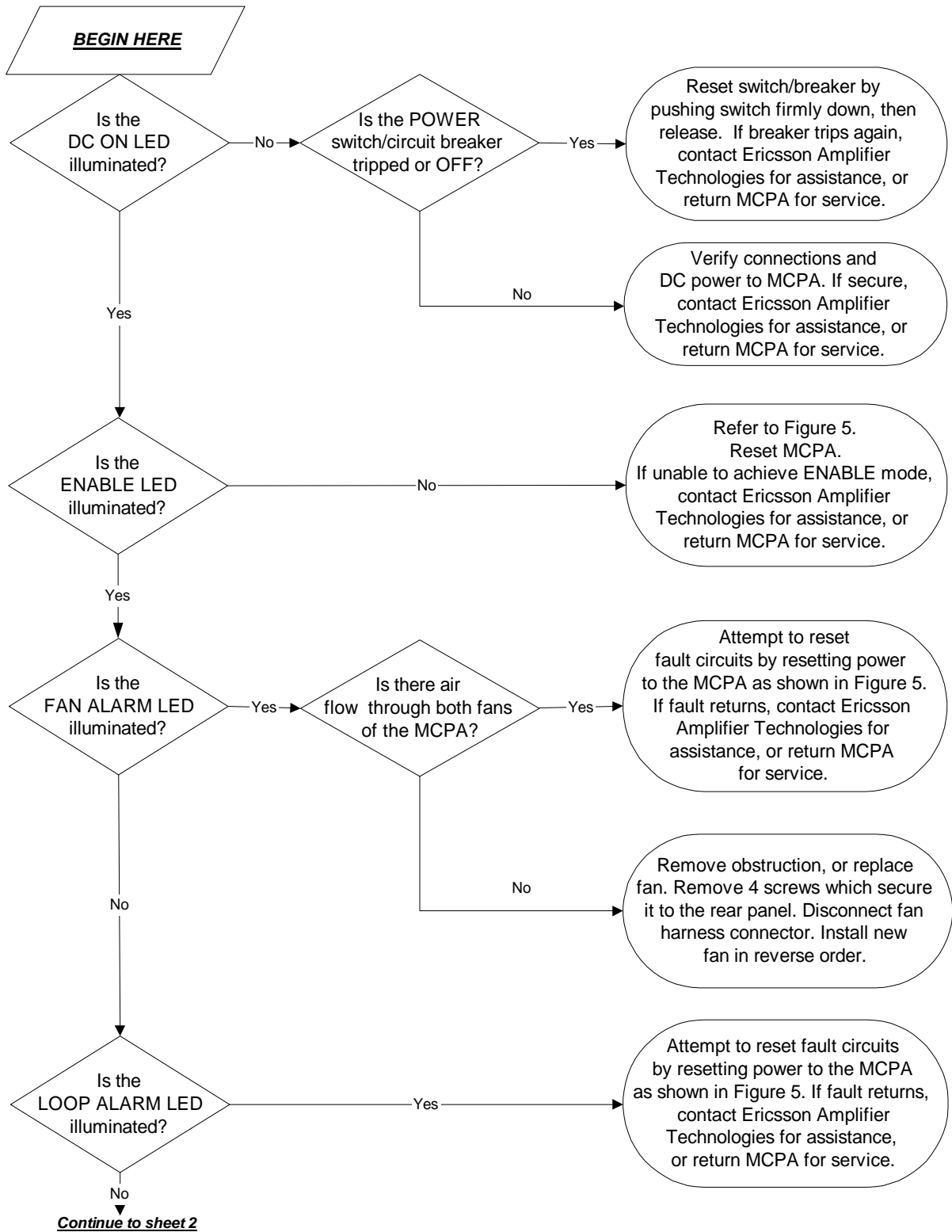

Figure 8. MCPA Troubleshooting Flow Chart (Sheet 1 of 2)

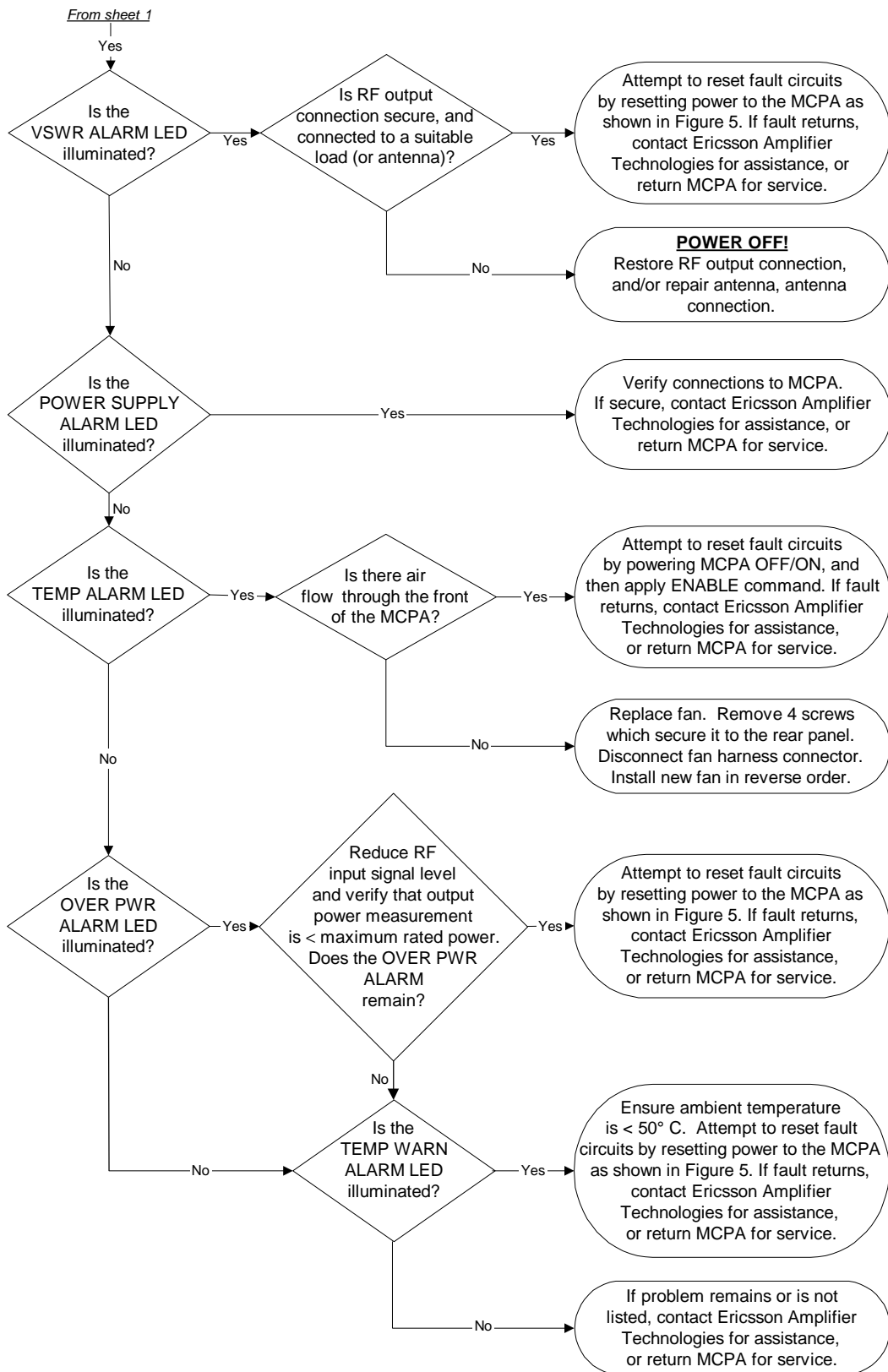

Figure 8. MCPA Troubleshooting Flow Chart (Sheet 2 of 2)