

MULTIMEDIA CAMERA

Owner's Manual

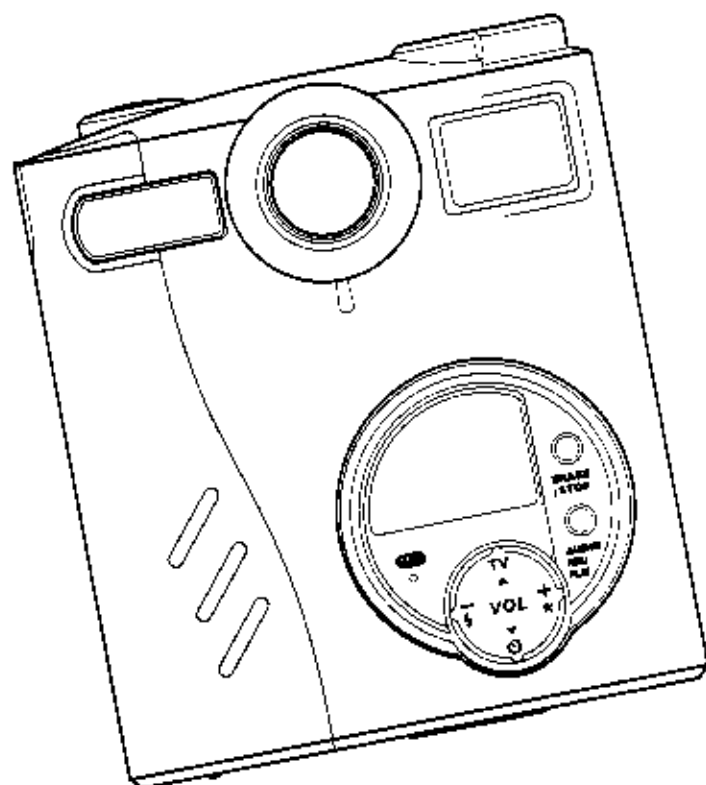

Warranty Policy

This camera is under warranty for one full year from the date of purchase by the original purchaser. In case of defects in materials or workmanship, we will replace or repair the camera free of charge. This warranty applies to the camera only. This warranty does not include batteries, or other accessories which have not been manufactured by our company. This warranty will not be honored if the camera has been mishandled or tampered with, or altered by anyone other than the manufacturer. Other than for the warranty herein, we are not responsible for loss, damage, or inconvenience of any kind.

A defective camera being returned under warranty must be accompanied by a brief description of the difficulties encountered and also by a proof of purchase with the date of purchase clearly indicated. All related transportation costs and insurances are at the owner's expense. Any alteration of this warranty cannot be made without the written approval from our company.

FCC Notice

This equipment has been tested and found to comply with the limits for a Class B digital device, pursuant to part 15 of the FCC Rules. These limits are designed to provide reasonable protection against harmful interference in commercial installation. This equipment generates, uses and can radiate radio frequency energy and if not installed and used in accordance with the instructions, may cause harmful interference to radio communications. However, there is no guarantee that interference will not occur in a particular installation. If this equipment does cause harmful interference to radio or television reception, detectable by turning the equipment in question off and on, the user is encouraged to try to correct the interference by one or more of the following measures: Reorient or relocate the receiving antenna; Increase the distance between the equipment and the receiver; Connect the equipment to an outlet on a different circuit than that which the receiver is connected to; Or consult the dealer or an experienced radio/TV technician for help.

Note

A shielded-type DC power cable incorporated with a ferrite core is required in order to meet the FCC emission limits and also to prevent interference to the nearby radio and television reception.

Use only shielded I/O cable incorporated with a ferrite core to connect this equipment to host computer and TV set. Shielded A.C. power cord and shielded I/O cables are required in order to meet the FCC emission limits. It is essential that only the supplied power cord and I/O cable(s) be used.

CAUTION



Do not place this camera in damp or dusty location. This may cause a fire or electric shock.



Do not place this camera in a location affected by oil fumes or steam, such as near a cooking stove or humidifier. This may cause a fire or electric shock.



Do not leave this camera in places subject to extremely high temperatures, such as in a sealed vehicle or in direct sunlight. Exposure to high temperatures may adversely affect the camera case and internal components and cause a fire.



Do not cover or wrap the camera or the AC power adapter with a cloth or quilt. This may cause heat to build up and distort the case or cause a fire. Always use the camera and its accessories in well-ventilated locations.



Take care that the camera is not bumped when it is being moved. This may cause the camera to malfunction.



Do not move the camera while it is switched on. (if you are using the AC power adapter, unplug the adapter from the AC power outlet after you have switched off the camera.) Then ensure that any connector cords or cables to other devices are disconnected before moving the camera. Failure to do so may damage the cords or cables and cause a fire or electric shock.



When handling the camera, always unplug it from the power source (batteries or AC power adapter) for safety. (if you are using the AC power adapter, unplug the adapter from the AC power outlet after you have disconnected the camera.) Failure to do so could result in an electric shock.

CAUTION



When leaving the camera unused for long periods, such as during a vacation, always unplug the camera from the power source (batteries or AC power adapter) for safety. (if you are using the AC power adapter, unplug the adapter from the AC power outlet after you have disconnected the camera.) Failure to do so could result in a fire.



Contact your dealer or local authorized service facility to request cleaning of the interior of the camera every two years. Allowing dust to accumulate in the camera for long periods without cleaning the camera interior may cause a fire or electric shock.

Cleaning is best performed prior to seasonal periods of high humidity.

Consult with your dealer or local authorized service facility for information on the cost of cleaning your camera.



Do not use batteries other than those specified for use with your camera.

The use of unsuitable batteries may result in the batteries splitting or leaking and causing a fire, injury, or soiling of the battery compartment.



When fitting a battery into the camera, check the polarity markings on the battery (+ and -) to ensure that you insert the battery correctly.

Incorrect battery polarity may result in the batteries splitting or leaking and causing a fire, injury, or soiling of the battery compartment.



Remove the batteries if the camera will not be used for an extended period of time. The batteries may leak and cause a fire, injury or soiling of the battery compartment. If the batteries leak, clean and wipe the battery compartment carefully and install new batteries. Wash your hands carefully if you touch the battery fluid.

WARNING

Unplug from
power socket.



Do not use this camera when it is emitting smoke, is unusually hot to the touch, is emitting any unusual odor or noise, or is in any other abnormal state. Use of the camera in any of these situations may cause a fire or electric shock. Stop using the camera immediately, turn the camera off, and then disconnect the power source (batteries or AC power adapter). (If you are using the AC power adapter, unplug the adapter from the AC power outlet after you have disconnected the camera.) After checking that smoke is no longer being emitted, contact your dealer or your local authorized service facility and request repairs. Never attempt to repair this camera yourself as this is dangerous.



Do not use the camera if any water has entered the camera. Switch the camera off, and then disconnect the power source (batteries or AC power adapter). (If you are using the AC power adapter, unplug the adapter from the AC power outlet after you have disconnected the camera.) Then contact your dealer or your local authorized service facility. Do not continue to use the camera as this may cause a fire or electric shock.



Do not use the camera if any foreign objects have entered the camera. Turn the camera off, and then disconnect the power source (batteries or AC power adapter). (If you are using the AC power adapter, unplug the adapter from the AC power outlet after you have disconnected the camera.) Then contact your dealer or your local authorized service facility. Do not continue to use the camera as this may cause a fire or electric shock.



If the camera has been dropped or the camera case has been damaged, switch the camera off, and then disconnect the power source (batteries or AC power adapter). (If you are using the AC power adapter, unplug the adapter from the AC power outlet after you have disconnected the camera.) Then contact your dealer or your local authorized service facility. Do not continue to use the camera as this may cause a fire or electric shock.

WARNING



Do not place the camera in unstable locations such as on a wobbly table or sloping surface where the camera may fall or tip over and cause injury.



Take care that the camera is not exposed to moisture and that water does not get into the camera. Take particular care when it is raining or snowing or when you are using the camera at the beach or near water.
Water in the camera may cause a fire or electric shock.



Do not insert or drop metallic or inflammable foreign objects into the camera through access points such as the Compact Flash card slot.
This may cause a fire or electric shock.



Do not attempt to modify this camera. This may cause a fire or electric shock.

Do not disassemble



Do not remove the camera casing. This may cause an electric shock. Internal inspection, maintenance and repairs should be carried out by your dealer or local authorized service facility.

Do not use in wet areas



Do not use this camera in the bathroom. This may cause a fire or electric shock.

Do not touch



Do not touch the power plug during a thunderstorm if you are using the AC power adapter.
This may cause an electric shock.

WARNING



Never use this camera, look through the viewfinder, or watch the LCD (liquid crystal display) while you are operating a moving car, motorcycle or bicycle.
This may cause a traffic accident.



Do not attempt to charge the alkaline battery.
This may cause the battery to split or leak, causing fire or injury.



Do not carry or store a battery with objects such as metal pens, necklaces, coins or hairpins. This could short circuit the positive \oplus and negative \ominus poles of the battery.
This may cause the battery to split or leak, resulting in fire or injury.



Do not heat or attempt to disassemble a battery, and do not place a battery in water or in a fire.
Any of these may cause the battery to split or leak, cause fire or injury.



Do not subject a battery to strong impacts, such as hitting it with a hammer, stepping on it or dropping it. Any of these may cause the battery to split or leak, cause fire or injury.



Use only the specified batteries or AC power adapter specified for use with this camera.
The use of other power sources may cause a fire.

Table of Contents

Introduction	8
Overview	8
What's included in the package.....	8
System Requirements (Windows).....	8
Getting to Know your camera	9
Getting Started	10
Inserting Batteries	10
Using the Power Adapter (Optional Accessory)	11
Attaching the Strap	11
Using a Compact Flash Card (Optional Accessory).....	12
Operating the Camera.....	12
Using Multimedia Camera as a Digital Camera	14
Taking Pictures.....	14
Camera Function Controls.....	15
Viewing Pictures	16
Downloading Pictures into your PC	18
Using Multimedia Camera as a MP3 Player	20
Where to get MP3 music files.....	20
Transferring MP3 files into multimedia camera.....	20
MP3 Playback Controls	21
Playing MP3 Music.....	21
Using Multimedia Camera as an Audio Recorder	22
Recording Controls.....	22
Recording Audio.....	23
Playing Recorded Audio.....	24
Transferring Recorded Audio into your PC.....	24
Erasing Contents from Multimedia Camera	25
Erasing a Single Picture, MP3 Song or Recorded Audio	25
Erasing All Pictures, MP3 Songs or Recorded Audio Tracks	26
Using Multimedia Camera as a PC Camera	27
Appendix 1 : LCD Icons	27
Appendix 2 : Specifications	28

Introduction

Overview

Digital Camera, MP3 Player, Digital Audio Recorder, and PC Camera in One!

Thank you for purchasing the MULTIMEDIA CAMERA, which is the most incredible camera ever been developed. This portable digital camera does not only take pictures, but also features a built-in MP3 player, audio recorder, and PC camera in the same camera unit.

The MULTIMEDIA CAMERA is equipped with 2MB built-in memory. In addition, it provides a memory card slot which can be inserted with a (Type I) Compact Flash Card. To download digital pictures and audio from the camera into your PC, a USB cable connection is all that is required. This single USB connection also allows you to transfer MP3 songs into the camera. When you use it as a PC camera, you can videoconference over the Internet. Look and talk to people on the internet face-to-face.

What's Included in the Package

- Multimedia camera unit
- USB cable
- Video cable
- Earphone
- 2 x AA alkaline batteries
- Software CD-ROM
- Quick start guide
- Owner's Manual
- Pouch and Strap

CD-ROM content :

Disk 1: MGI Photosuite III SE, Multimedia Camera Manager, MP3 software

Disk 2 : MGI Video Wave SE+

Optional accessories include:

Compact Flash Card

AC Adapter

System Requirements (Windows)

Personal computer with minimum Pentium 166 MHz with graphic card

Microsoft windows 98/2000 operating system

32 MB or more of RAM

80 MB of hard disk space available

Available USB, and CD-ROM drive

Color Display (800x600 24 bit or higher recommended)

Getting to Know your Camera

Before you start using camera, try to familiarize first with its various controls. This section shows the different parts of the camera in detail.

- A. Power Button
- B. Shutter Release
- C. Ready LED
- D. Mode Dial
- E. Lens
- F. Viewfinder Window
- G. Flash
- H. Compact Flash Card slot
- I. Self-Timer LED
- J. Stop/Erase Button
- K. Audio Record / Play Mode Selection Button
- L. Microphone
- M. 4-Way Toggle Control
- N. Earphone Jack
- O. DC IN 5V port
- P. Video port
- Q. USB port
- R. Battery door
- S. Viewfinder

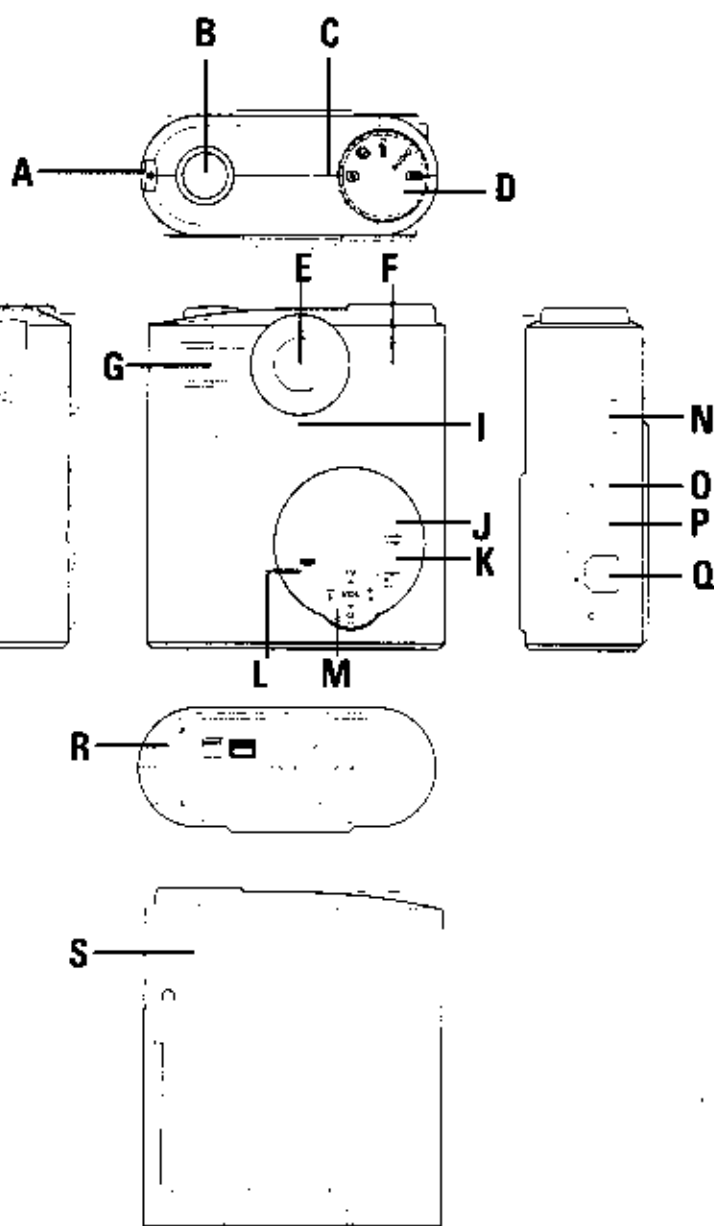

Getting Started

The multimedia camera comes with standard accessories such as batteries, and strap. This section shows how you can use them with the camera. Basic camera operations are also described in this section.

Inserting Batteries

The battery compartment is located the bottom side of the camera. You will need to use two AA-size batteries.

To install the batteries:

1. Open the battery cover.
2. Insert the batteries properly. When inserting, make sure that you follow the polarity directions which are indicated on the inner side of the battery cover.
3. Close the battery cover.

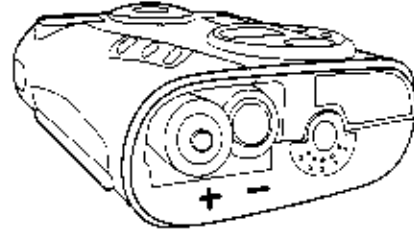

Note



You do not need to use batteries when you connect a USB cable between the camera and your PC. The camera consumes power from the PC through the USB port.

Warning

- If you won't be using the camera for an extended period of time, remove the batteries to prevent leaks or corrosion.
- Never use manganese batteries. Never mix old and new batteries.
- Low temperatures under 0°C may reduce the output efficiency of batteries, thereby shortening the operation time of the camera.
- The recommended battery is AA-size alkaline battery.

Battery Life Indicator

When the camera has full power, the Battery Power icon on the LCD panel will be fully shaded. When power is low, only the lower portion of the icon will be shaded. This indicates that the batteries are weak and need to be replaced. When the batteries are completely dead, the camera will not turn on.

-  Full Battery power
-  Medium Battery power
-  Low Battery Power

Using the Power Adapter (Optional Accessory)

If you prefer to operate the camera on AC power, Power Adapter (5V/2.4A) at your choice. Simply connect the power adapter into the DC IN port on the camera, and then plug the power adapter to a wall socket.

Note

You do not need to use the power adapter when you connect a USB cable between the camera and your PC. The camera consumes power from the PC through the USB port.

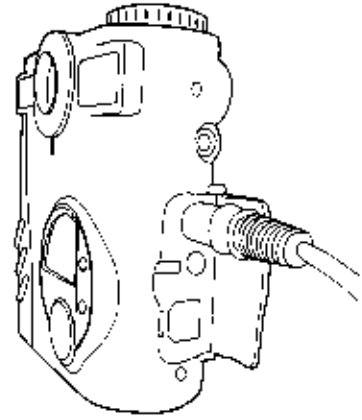

Warning

- Always be sure to use the power adapter from the manufacturer. Any other adapter may cause damage to the camera, which is not covered under the warranty.
- Grasp the power adapter, not the cord, when unplugging it from a wall socket.
- If the power cord gets damaged (exposed or severed wires, etc.), purchase a new power adapter from your local dealer. Using a damaged cord may cause fire or electrical shock.
- Switch off and disconnect the AC adapter from the camera before unplugging it from the wall socket.

Attaching the Strap

If you intend to take pictures outdoors, it will be rather convenient to carry the camera using the provided strap.

To attach the strap to the camera:

1. Insert the small loop at the end of the strap into the hole of the camera's strap holder.
2. Push inward until the loop comes out of the other hole of the camera's strap holder.
3. Insert the other end of the strap through the loop and pull it all the way until the strap is securely attached to the camera.

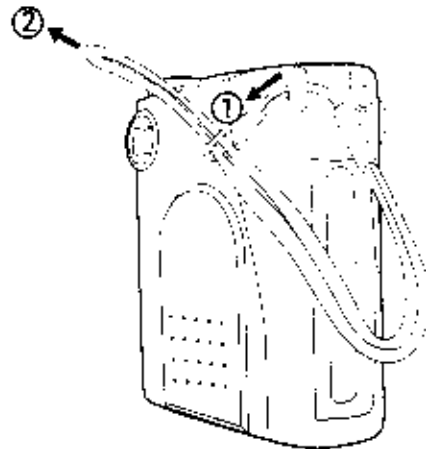

Using a Compact Flash Card (Optional Accessory)

The camera already comes with 2MB internal memory for storing pictures, MP3 songs and recorded audio. If this is not enough for you, you can extend the camera's storage capacity by inserting a compact flash memory card.

To insert a Compact Flash memory card:

1. Open the card slot located at the side of the camera.
2. Push the memory card all the way into the card slot until you hear a clicking sound.
3. Close the card slot cover.

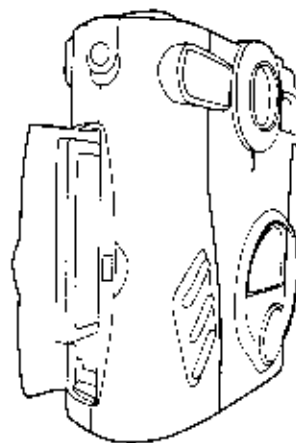

Note

To remove the Compact Flash memory card, push the Eject button located inside the card slot.

Operating the Camera

Once there is power supplied to the camera (through installed batteries, the optional power adapter or through a USB cable connected between the camera and your PC), you can start using the camera.

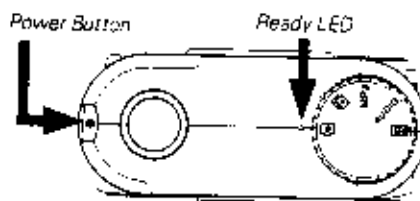

Starting up the Camera

To switch the camera on, press down the Power Button which is located at the side of the camera. The LED located at the top side of the camera then lights up, indicating that the camera is on.

Auto Power Off Feature

The camera automatically switches off when there are no operations performed for over 2 minutes. However, this feature is not available when the camera is supplied with power from a USB or AC Adapter connection.

Changing Mode

The Mode Dial located at the top side of the camera lets you easily change from one operation mode to another. Just turn the Mode Dial clockwise or counterclockwise to switch to a different mode.

The five icons shown on the Mode Dial indicate the five operation modes of the camera. To select a mode that you want, keep on turning the Mode Dial until its icon is situated at the middle, uppermost side of the Mode Dial. Refer to the succeeding pages for more information on each of these operation modes.

Function Controls

The front panel buttons provide different types of controls, depending on which operation mode is currently selected. For instance, in DSC mode, the 4-Way Toggle Control allows you to set the flash mode, select picture quality, self-timer. In other operation modes, such as MP3 and Audio modes, all these buttons are used but they function differently in each mode.

The next sections will discuss each operation mode in detail and how to adjust the controls at each mode.

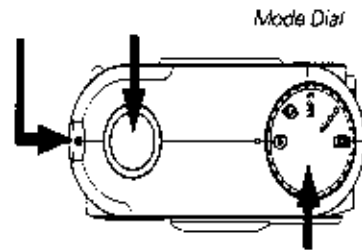

-  PC mode
-  DSC mode
-  TV mode
-  MP3 Mode
-  Audio Mode



Function Controls



Using MULTIMEDIA CAMERA as a Digital Camera

The camera allows you to easily take digital photo shots. This section shows you how to take pictures with the camera.

Taking Pictures

Set the camera to DSC mode  when you want to take pictures. To take digital photo shots with the camera, make sure that there is enough battery power or that the optional power adapter is properly connected. (See page 10 to 11 for details on how to insert batteries or connect a power adapter.) Connecting a USB cable between the camera and your PC can also provide power to the camera. (See page 18 to see a clear illustration on how to connect a USB cable.)

If you want to use a Compact Flash memory card to store your pictures, insert the memory card before you start taking pictures. Without a Compact Flash memory card installed, the pictures are stored in built-in memory. (For information on inserting memory card, see page 12.)

To take a picture:

1. Turn the camera on by pressing the Power Button. The Ready LED located at the top side of the camera then lights up.
2. Make sure that the camera is in DSC mode. To set the camera to **DSC mode**, turn the Mode Dial repeatedly until you see the DSC icon appear on the LCD panel.
3. Using the Viewfinder, focus on the object you want to capture.
4. Hold still and press the Shutter Release button to take the picture.
5. The Ready LED blinks continuously as the camera captures an image and processes the image.
6. When the Ready LED stops blinking, you can take the next picture. (The Ready LED always remains lighted up while the camera is on.)

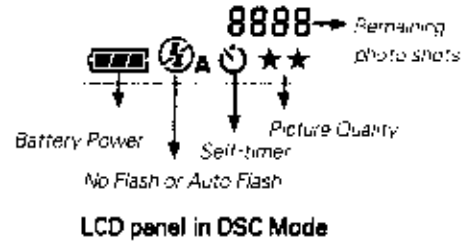
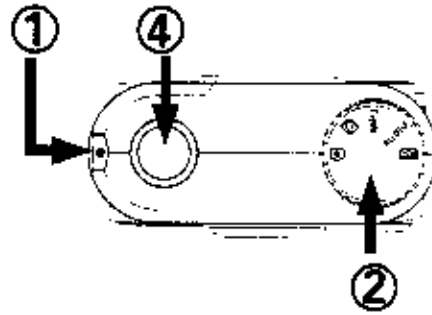

Erasing Pictures

You cannot erase pictures from the camera memory while in DSC mode. To erase pictures, set the camera to TV mode. For more information, see page 25.

Camera Function Controls

When you're using Multimedia Camera as a digital camera, use the 4-Way Toggle Control located in front of the camera to select options that are suitable for your picture taking needs.

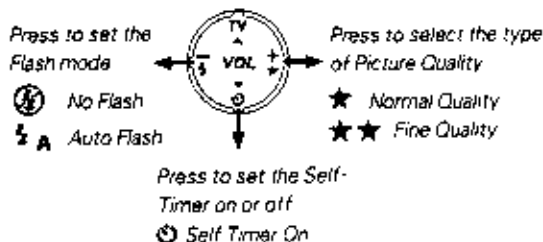

Flash Mode

The camera has two different flash modes:

- ⊘ No Flash - The flash is disabled no matter what the ambient brightness of the surroundings is.
- ⚡ A Auto - The camera automatically fires the flash when lighting in your surrounding is not bright enough.

Picture Quality

Two different elements determine the quality of the pictures that you take. The first is resolution. The camera can take pictures at 640 X 480 resolution. The second element is the amount of compression applied to captured images. This camera can capture images using two types of compression settings: Normal (high compression) and Fine (low compression). The lower the compression, the higher the image quality will be but lesser number of pictures can be taken. Higher compression allows more pictures to be taken and the image quality is acceptable.

- ★ Normal Quality - 31 pictures
- ★★ Fine Quality - 15 pictures

(The total number of stored images may be varied with the free space of the card, the mixture of the image quality mode, and also the complexity of the subject.)

⌚ Self-Timer

The Self-Timer creates a 10-second delay between the time you press the Shutter Release button and the time the picture is taken. The 10-second delay is indicated by the Self-Timer LED flashing once per second for seven seconds, then twice per second for the last three seconds.

After a picture has been taken, the Self-Timer sets off automatically. You need to set the Self-Timer on every time you want to use it.

▣ Viewing Pictures

Show off your pictures to an audience by connecting your camera to a TV. This section shows you how to properly connect the camera to a TV and display your pictures on TV.

Using the Camera in TV Mode

Set the camera to TV Mode  when you want to use a TV monitor to view the pictures you have taken or when you want to erase pictures from the camera memory.

TV Function Controls

While in TV mode, use the function controls located in front of the camera to properly set the TV standard, advance forward or backward when viewing pictures, and to erase pictures.

Note

For details on erasing pictures, see page 25.

Viewing Pictures on your TV

Set the camera to TV Mode  when you want to use a TV monitor to view the pictures you have taken.

Connecting the Camera to your TV

Use the video cable comes with the package to connect the camera to a TV.

1. Connect one end of the video cable to the video port on the camera.
2. Connect the other end of the cable to the video input socket normally at the back of your TV.

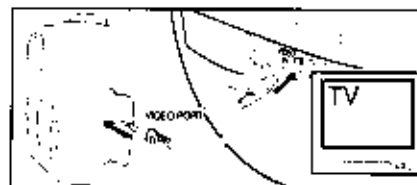
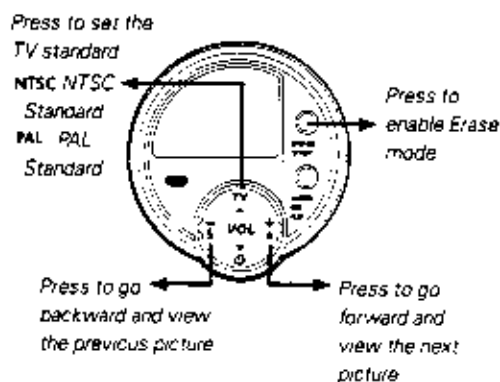

Defining the TV Output

Before you can view pictures on your TV, you need to identify first what TV standard your television uses. If you have an NTSC standard TV, set the camera to NTSC. If you have a PAL standard TV, set the camera to PAL. (The figure on page 16 illustrates clearly how to set the TV output for your camera.)

Viewing your Pictures

After properly connecting your camera to a TV, you can start viewing your pictures.

1. Turn on your TV.
2. Set the camera to TV mode. 
3. Use the 4-Way Toggle Control in front of the MULTIMEDIA CAMERA to select the camera's TV output. Press TV to select NTSC or PAL, depending on the TV system you are using.
4. Also use the 4-Way Toggle Control to select which picture to display on the TV screen. Press Right (+) to display the next picture, or press Left (-) to display the previous picture.

As you advance forward and backward through your pictures, the LCD Panel shows the current picture number you are viewing.

5. If you want to resume taking pictures, disconnect the camera from your TV. Then, set the camera to DSC mode again.

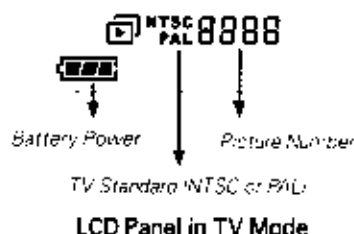
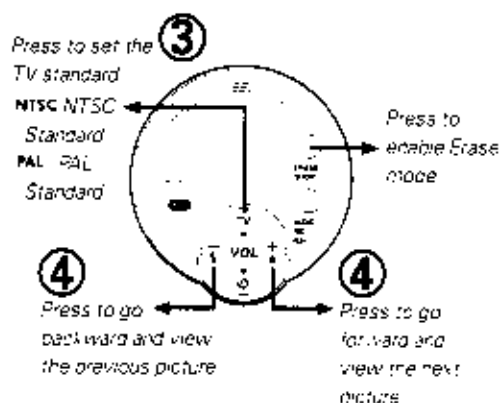
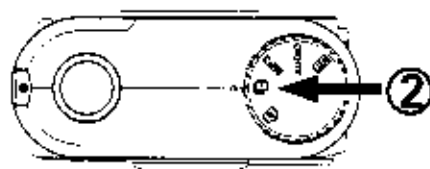

Note

You can also view your pictures on your computer monitor by downloading them to your PC. For more information about downloading pictures into your PC, see page 18.

PC

Downloading Pictures into your PC

Once your camera's memory or the inserted Compact Flash Card is full, you can erase the pictures and take more pictures. Before you erase the pictures, save them first by transferring them to your computer. This section shows you how to download pictures into the computer.

Note

For details on how to erase pictures, see page 25.

Connecting the Camera to Your PC

Use the provided USB cable to connect the camera to your PC.

- 1 Connect one end of the USB cable into the USB port on your PC.
- 2 Connect the other end of the USB cable to the USB port on the camera.
- 3 Turn on the camera.

Note

You do not need to use batteries or the power adapter when you have connected a USB cable between the camera and your PC. The camera consumes power from the PC through the USB port.

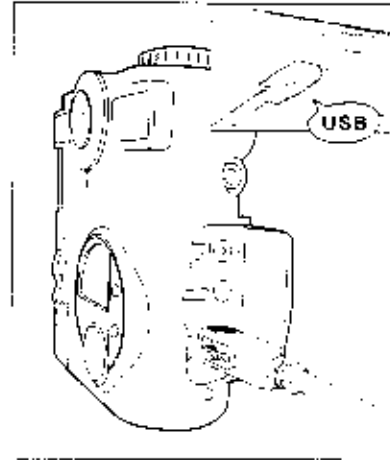

Camera driver and software installation

The following software applications and camera driver are included in the DSC Application Suite CD.

- MGI Photosuite III SE - allows you to enhance the pictures with fast, friendly, fun PC photography software.
- MGI VideoWave SE+ - is powerful PC video software allows even novice users to create professional videos quickly and easily.
- Multimedia Camera Manager- provides you an efficient way to manage and transfer pictures, audio and MP3 files between the camera and computer.
- MP3 - convert your music CD to MP3 file format and enjoy your favorite songs anywhere.

In order to transfer files between Multimedia Camera and PC, you need to install the Multimedia Camera Manager which is under DSC Application Suite. It is implemented with auto-setup program. Once you insert Disk 1 into CD-ROM drive, the DSC Application Suite main menu window will pop-up. Otherwise, you still can run "setup.exe" file in the root directory of CD-ROM drive.

- 1: Insert the Disk 1 into CD-ROM drive
- 2: Click on the checkbox to select the software would like to be installed.
- 3: Follow the on screen instruction to complete driver and the application software installation.
- 4: Restart the computer. After restarting the computer, a DSC Application Suite shortcut icon has now been created on the desktop.



Note

The system requirements and the operation of each bundled software applications may vary. For more information, please refer to their respective software help menu.

Getting your Pictures

To get pictures from the camera and transfer them to your PC:

1. Make sure that the camera is securely connected to your PC and the camera driver is installed.
2. Set the camera to PC mode.
3. Double-click the DSC Application Suite Shortcut icon on the desktop.
4. Click the Multimedia Camera Manager button.
5. Drag or copy the image files in the folder of Multimedia Camera Manager to the folder you specify in your hard disk.
6. Once the copy process has been completed, the images then successfully have downloaded from the camera to your PC.

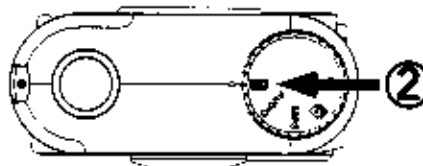



Using MULTIMEDIA CAMERA as an MP3 Player

To use the MULTIMEDIA CAMERA as an MP3 Player, you need to first transfer MP3 songs from your PC into the camera. This section tells you where you can get MP3 files as well as how to upload them into camera and then play them.

Where to Get MP3 Music Files

There are basically three ways you can do to get MP3 songs:

- **From the Internet**

Now, there are numerous Web sites on the Internet which allow you to download MP3 songs for free. There are also Web sites which sell popular music from renowned artists in MP3 format. Using your Web browser, you can try to search for such Web sites and then download MP3 files for free or by purchasing them online.

- **MP3 CDs**

You can purchase MP3 music CDs. These CDs are capable of storing a whole lot more songs than traditional music CDs because of MP3 compression

- **Record from your personal CD collection**

Another way of getting MP3 files is by converting music tracks from traditional music CDs into MP3 files in your PC. You need to use an MP3 encoding software in order to do this. Freeware MP3 encoders are available in the Internet, and you can just download and use them to transform your favorite CD collection into MP3 files.

With MP3 encoding software, you may also convert .WAV audio files into MP3 format. For more information about the operation of MP3 software, please refer to its respective software help.

Copyright Protection

Music especially from renowned artists is protected by copyright. Distributing or sharing MP3 files without authorization is an infringement against international copyright laws.

Transferring MP3 Files into the Multimedia Camera

To transfer MP3 music files into the MULTIMEDIA CAMERA:

1. Make sure that the camera is securely connected to your PC using the provided USB cable. (See page 18 for a clear illustration on how to connect the USB cable.)

2. Set it to PC mode **PC**.
3. Double-click the DSC Application Suite shortcut icon on the desktop.
4. Click the Multimedia Camera Manager button.
5. Select the MP3 songs you want to transfer, and then drag the MP3 files into the Multimedia Camera Manager folder.
6. Once the copy process has been completed, the MP3 songs then have successfully uploaded from your PC to the camera.

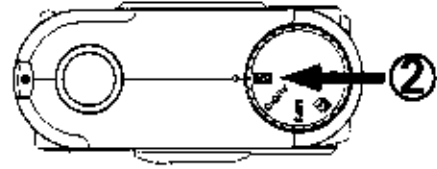

Note

You do not need to use batteries or the power adapter when you have connected a USB cable between the camera and your PC. The camera consumes power from the PC through the USB port.

MP3 Playback Controls

While in MP3 mode, use the Shutter Release button and the 4-Way Toggle Control located in front of the camera to control the playback of MP3 songs.

Note

For details on erasing MP3 songs, see page 25.

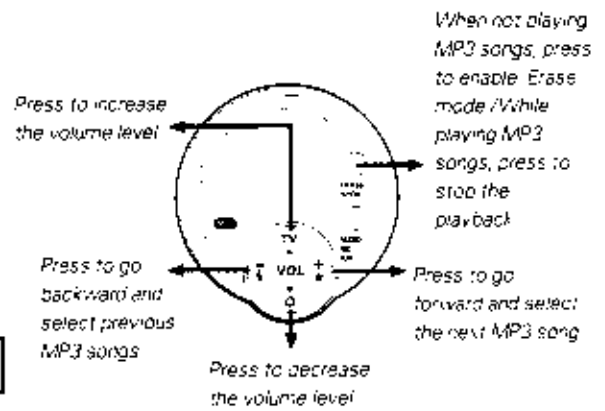

Playing MP3 Music

After you have finished transferring MP3 files, you are ready to play the songs now. When playing MP3 songs, make sure that your camera has enough battery power or that the power adapter is connected.

To play MP3 songs:

1. Connect your earphone to the camera.
2. Set the camera to MP3 mode (MP3).
3. Use the 4-Way Toggle Control in front of the camera to adjust the volume. Press Arrow Up (▲) to increase the volume level, or press Arrow Down (▼) to decrease the volume level.
4. Also use the 4-Way Toggle Control to select the MP3 song you want to play. Press Right (+) to select the next song, or press Left (-) to select the previous song.
5. To play the selected MP3 song, press the Shutter Release button.
To pause or resume playback, also press the Shutter Release button.
6. To stop the playback, press the Erase/Stop button located in the front panel.

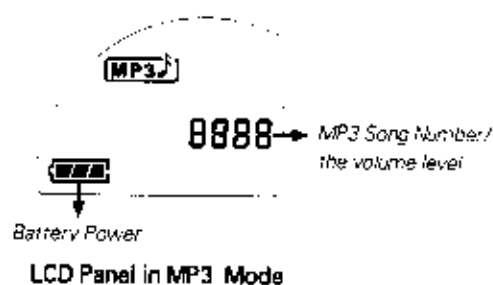
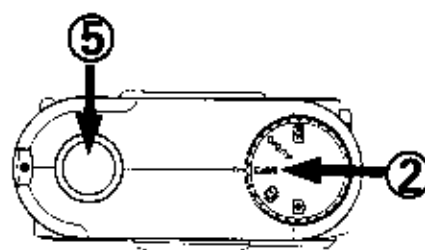

AUDIO Using MULTIMEDIA CAMERA as a Audio Recorder

Another outstanding feature of the MULTIMEDIA CAMERA is its built-in audio recorder, which allows you to record notes, interviews with other people, lectures, or conferences. You can record and then play the audio in camera, as well as transfer the recorded content to your PC.

Recording Controls

Set the camera to Audio Mode (AUDIO) when you want to use the audio recording feature. Use the Shutter Release button and the button controls located in front of the camera to start, pause and stop the recording, play the recorded audio, or erase the audio.

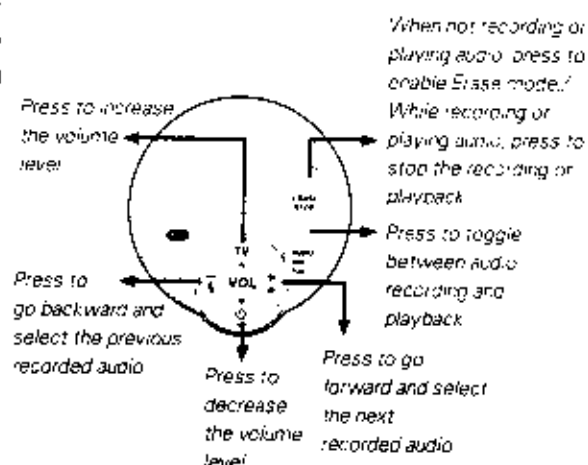

Note

For details on erasing recorded audio, see page 25.

Recording Audio

1. Set the camera to Audio mode **AUDIO**.
2. Press the AUDIO REC/PLAY button to enter Audio Record Mode, the RECORD will appear in the LCD panel.
3. Press the Shutter Release button to start recording.
4. If you are recording your own voice, speak to the microphone that is in front of the camera. Or, if you are recording interviews, meetings or lectures, place the camera in a location where audio can be recorded. Make sure that the microphone is facing the speaker to get a clear recording.
5. To pause the recording, press the Shutter Release button.
6. To continue recording on the same track, press the Shutter Release button again.
7. To stop recording, press the Erase/Stop button located in front of the camera.

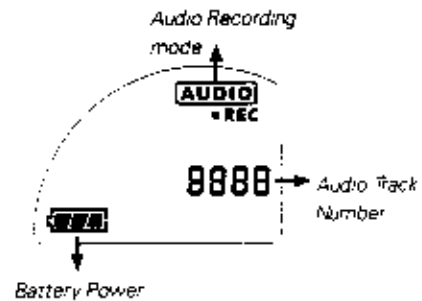
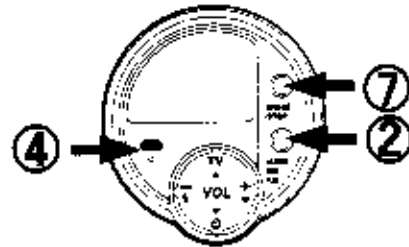
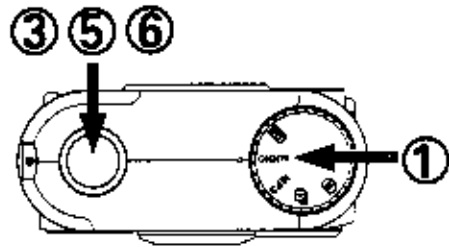

LCD Panel in Audio Mode

Note

If you keep on pressing the Shutter Release button in between recordings, audio will always be recorded in the same track. Make sure you press the Stop button when you want to end an audio segment and do a new recording on the next track.

Playing Recorded Audio

To play the recorded audio:

1. Connect your earphone to the camera.
2. Make sure that camera is set to Audio mode **AUDIO**.
3. Press the Rec/Play button to enter PLAY mode, the PLAY will appear in the LCD panel.
4. Use the 4-Way Toggle Control in front of the camera to adjust the volume. Press Arrow Up (▲) to increase the volume level, or press Arrow Down (▼) to decrease the volume level.
5. Also use the 4-Way Toggle Control to select the audio track you want to play. Press Right (+) to select the next track, or press Left (-) to select the previous track.
6. To play the selected track, press the Shutter Release button.
To pause or resume playback, also press the Shutter Release button.
7. To stop the playback, press the Erase/Stop button.

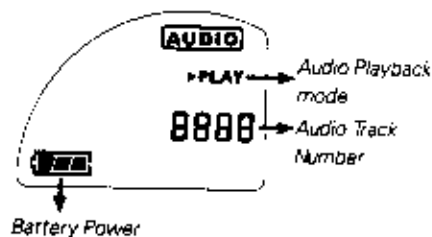
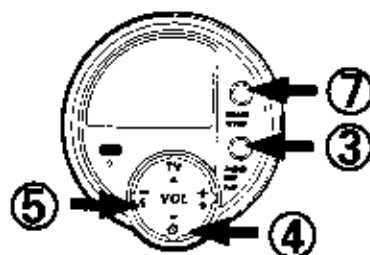
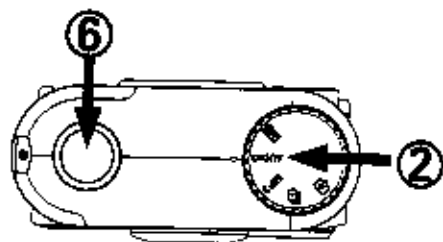

LCD Panel in Audio Playback Mode

Transferring Recorded Audio into your PC

MULTIMEDIA CAMERA records audio in .WAV format. After recording, you can transfer the audio into your computer.

To transfer recorded audio from the Camera into your PC:

1. Connect the Camera to your PC using the provided USB cable. (See page 18 for a clear illustration on how to connect the USB cable.)
2. Set the camera to PC mode. **PC**
3. Double-click the DSC Application Suite short cut button icon on the desktop.
4. Click the Multimedia Camera Manager button.



5. Select the audio track you want to transfer, and then drag the files in the Multimedia Camera Manager folder to the folder you specify in your hard disk.
6. Once the copy process has been completed, the audio then have successfully downloaded from the camera to you PC.

Note

You do not need to use batteries or the power adapter when you have connected a USB cable between the camera and your PC. The camera consumes power from the PC through the USB port.

Erasing Contents from the MULTIMEDIA CAMERA

When both the camera's internal memory and the inserted Compact Flash Card are already full, it is time for you to erase some or all of their contents to free up storage space. But before you erase anything, make sure that you transfer the contents first to your PC if you still want to use them.

Erasing a Single Picture, MP3 Song or Recorded Audio

To erase a single picture, MP3 song or recorded audio:

1. Set the camera to the proper operation mode:
 - To erase a picture, set to TV mode **TV**
 - To erase an MP3 song, set to MP3 mode **MP3**
 - To erase a recorded audio, set to AUDIO mode **AUDIO**
2. To enter Erase mode by pressing the Erase/Stop button located in front of the camera.
3. Use the 4-Way Toggle Control in front of the camera to select the picture, MP3 song, or audio track number you want to erase. Press Right (+) repeatedly to skip forward, or press Left (-) repeatedly to go backwards, until the number that you want appears on the LCD panel.
4. Press the Shutter Release button to erase the selected number.
5. Press the Erase/Stop button to quit from Erase mode.

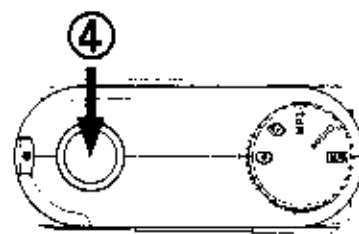
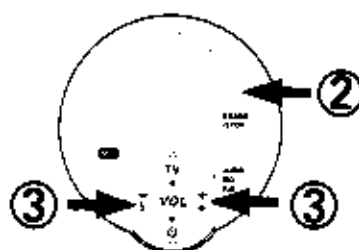



Erasing a Picture (TV mode)

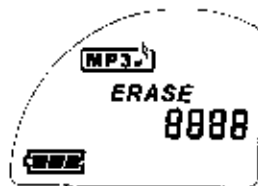



Erasing an MP3 Song (MP3 mode)



Erasing a Recorded Audio (AUDIO mode)

Erasing All Pictures, MP3 Songs or Recorded Audio Tracks

To erase all pictures, MP3 songs or recorded audio tracks:

1. Set the camera to the proper operation mode:
 - To erase all pictures, set to TV mode .
 - To erase all MP3 songs, set to MP3 mode. .
 - To erase all recorded audio tracks, set to AUDIO mode .
2. Switch to Erase mode by pressing the Erase/Stop button located in front of the camera.
3. Keep pressing the Right (+) or Left (-) of the 4-Way Toggle Control until the message Erase All appears on the LCD panel.
4. Press the Shutter Release button to erase all pictures, MP3 songs, or recorded audio tracks, depending on which operation mode you are currently in.

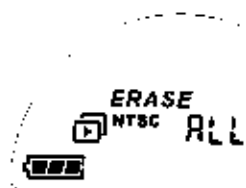
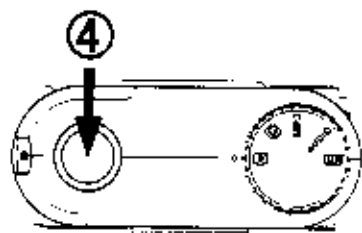
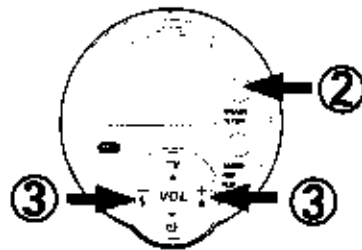

Erasing All Pictures (TV mode)



Erasing All MP3 Songs (MP3 mode)



Erasing All Recorded Audio Tracks (AUDIO mode)

Using MULTIMEDIA CAMERA as a PC Camera























This camera features an USB device for PC, which complies with Windows 98 plug-and-play rule. You don't need to turn off your PC. Just plug camera's USB cable connector into your PC USB port, then everything is ready to go.

- 1: Make sure the multimedia camera manager is installed. (For details, see Camera driver and software installation section on page 18)
- 2: Make sure the camera is connected with PC by USB cable. (For details, see Connecting to the computer on page 18)
- 3: Set the camera to PC mode 
- 4: Launch your own video conference software, such as Microsoft NetMeeting

Note

For more information about the video conference application software, please refer to its respective software help menu.

Appendix 1: LCD Icons

	PC mode		Erase Icon
	DSC Record mode		Volume Icon
	DSC Playback mode		Pause Icon
	MP3 Mode		Digital Icon
	MP3 Play		Auto Flash
	Audio Mode		No Flash
	Audio Play		Normal Quality
	Audio Record		Fine Quality
	Full Battery power		TV (PAL)
	Medium Battery power		TV (NTSC)
	Low Battery Power		Self-Timer On

Appendix 2: Camera Specifications

Image Sensor	CMOS Image Sensor
Image Size (HxV)	640x480 pixels
Resolution Mode	640x480 pixels
Internal Memory	2MB Flash Memory
External Memory	CF Card
Image Storage (2MB)	Approximately up to 31 pictures (Normal)
External Connectors	AC adapter/ USB / Video Output (NTSC / PAL), Earphone Output
Optical Viewfinder	Built-in
LCD Display	B/W LCD for text display
LCD Indicator	Self-timer (red, in front) ; Ready (green, in top)
Lens	Fixed lens
Power supply	2 AA-size Alkaline Battery; AC Adapter 5V DC / 2.4 A ; DC5V from USB port
MP3	Playback MP3 File
Voice	Record/Playback wav File
Flash Mode	Auto, Off
Self-timer	10 sec delay
Exposure	Auto
White Balance	Auto
Shutter	Electronic shutter (Auto)
Compression method	JPEG base
Auto Power OFF	120 sec after no operation
Weight	136 g (without Battery and CF card)
Dimensions	91 x 80 x 35 mm

Design and specifications are subject to change without notice.