

Accent[®] 800



Hardware Manual

Model Name:ACN800-30

Brand Name:Accent

Manufacture:Prentke Romich Company



Acknowledgements

Copyright/Trademark Information

© 2017 Prentke Romich Company. All rights reserved. Under copyright laws this document may not be copied, in whole or in part, without the written consent of the Prentke Romich Company.

Accent, NuEye, NuPoint, and NuVoice are registered trademarks of Prentke Romich Company.

Freedom Switch is a trademark of Prentke Romich Company.

The MINSPEAK®, SEMANTIC COMPACTION®, UNITY®, and UNIDAD® trademarks are under license from Semantic Compaction Systems, Inc. in the United States and other countries.

Microsoft and Windows are registered trademarks of Microsoft Corporation in the United States and/or other countries.

The Skype name, associated trademarks and logos and the "S" logo are trademarks of Skype or related entities.

The Bluetooth® word mark and logos are registered trademarks owned by the Bluetooth SIG, Inc. and any use of such marks by Prentke Romich Company is under license.

CAVIWIPES is a trademark of Metrex Research LLC.

Velcro is a registered trademark of Velcro BVBA.

Windex is a registered trademark of S. C. Johnson & Son, Inc.

18051v1.0 · 10/19/2017

Electronic Interference Information

This device complies with Part 15 of the FCC Rules. Operation is subject to two conditions: (1) this device may not cause harmful interference, and (2) this device must accept any interference received, including interference that may cause undesired operation.

Warning! Changes or modifications to this product not expressly approved by Prentke Romich Company could exceed FCC limits and negate your authority to use this product.

Note: This equipment has been tested and found to comply with the limits for a Class B digital device, pursuant to Part 15 of the FCC Rules. These limits are designed to provide reasonable protection against harmful interference in a residential installation. This equipment generates, uses and can radiate radio frequency energy and, if not installed and used in accordance with the instructions, may cause harmful interference to radio communications. However, there is no guarantee that interference will not occur in a particular installation. If this equipment does cause harmful interference to radio or television reception, which can be determined by turning the equipment off and on, the user is encouraged to try to correct the interference by one or more of the following measures:

- Reorient or relocate the receiving antenna.
- Increase the separation between the equipment and receiver.
- Connect the equipment into an outlet on a circuit different from that to which the receiver is connected.
- Consult the dealer or an experienced radio/TV technician for help.

This Class B digital apparatus meets all requirements of the Canadian Interference-Causing Equipment Regulations. Cet appareil numérique de la classe B respect toutes les exigences du Règlement sur le matériel brouiller du Canada.



Warnings

This device is not intended to be an emergency call device or sole communication aid.

When operating this device in a medical environment, do not use with any product that is not medically approved. Follow all rules for appropriate cell phone and wireless device use.

Do not use this device close to sources of RF radiation or you may encounter interference. Move away, if possible, from the source of the interference.

Any mounts used should be fitted by a qualified person. Failure to install the mounting system according to the manufacturer's instructions may result in an injury to the user. Be certain that the user's view is not obstructed by the mounting.

Analysis of positioning by a qualified person is required to prevent repetitive stress injuries to the user.

Cords and straps are potential entanglement/strangulation hazards. Please consider this prior to placing these items with device users.

Small parts could present a choking or other hazard.

Excessive volume or sound pressure level when using earphones or headphones can cause hearing loss over extended periods of time.

Do not use the device if the screen is cracked or broken.

Implantable Medical Devices

A minimum separation of six (6) inches should be maintained between a handheld wireless mobile device and an implantable medical device, such as a pacemaker, implantable cardioverter defibrillator, vagus nerve stimulator, shunt, or stent, to avoid potential magnetic interference with the device.

Persons who have such devices:

- Should ALWAYS keep the mobile device a minimum of six (6) inches from their implantable medical device;
- Should not carry the mobile device in a breast pocket;
- Should move the mobile device away from themselves immediately if there is any reason to suspect that it is interfering with the implantable medical device;
- Should read and follow the directions from the manufacturer of the implantable medical device. If you have any questions about using your wireless mobile device with an implantable medical device, *consult your health care provider.*

Temperature and Humidity

Operating temperature: 32° to 122°F or 0° to 50°C

Storage temperature: -4° to 140°F or -20° to 60°C

Humidity: -10% to 90%

This device contains two modules, These two modules have been Full approve module certified.
2.4 GHz transceiver module FCC ID is UYI24, BT module FCC ID is SSSBC127-X

End User Licensing Agreement

You have acquired a PRC device which includes software licensed by PRC from Microsoft Licensing Inc. or its affiliates ("MS"). Those installed software products of MS origin, as well as associated media, printed materials and "online" or electronic documentation (software) are protected by international intellectual property laws and treaties.

IF YOU DO NOT AGREE TO THIS END USER LICENSE AGREEMENT (EULA), DO NOT USE THE DEVICE OR COPY THE SOFTWARE. INSTEAD, PROMPTLY CONTACT PRENTKE ROMICH COMPANY FOR INSTRUCTIONS ON RETURN OF THE UNUSED DEVICE(S) FOR A REFUND. **ANY USE OF THE SOFTWARE, INCLUDING BUT NOT LIMITED TO USE ON THE DEVICE, WILL CONSTITUTE YOUR AGREEMENT TO THIS EULA (OR RATIFICATION OF ANY PREVIOUS CONSENT).**

GRANT OF SOFTWARE LICENSE.

This EULA grants you the following license:

- You may use the SOFTWARE only on your PRC device.
- **NOT FAULT TOLERANT.** THE SOFTWARE IS NOT FAULT TOLERANT. PRC HAS INDEPENDENTLY DETERMINED HOW TO USE THE SOFTWARE AND MS HAS RELIED UPON PRC TO CONDUCT SUFFICIENT TESTING TO DETERMINE THAT THE SOFTWARE IS SUITABLE FOR SUCH USE.
- **NO WARRANTIES FOR THE SOFTWARE.** THE SOFTWARE is provided "AS IS" and with all faults. THE ENTIRE RISK AS TO SATISFACTORY QUALITY, PERFORMANCE, ACCURACY, AND EFFORT (INCLUDING LACK OF NEGLIGENCE) IS WITH YOU. ALSO, THERE IS NO WARRANTY AGAINST INTERFERENCE WITH YOUR ENJOYMENT OF THE SOFTWARE OR AGAINST INFRINGEMENT. IF YOU HAVE RECEIVED ANY WARRANTIES REGARDING THE DEVICE OR SOFTWARE, THOSE WARRANTIES DO NOT ORIGINATE FROM, AND ARE NOT BINDING ON, MS.
- **Note on Java Support.** The SOFTWARE may contain support for programs written in Java. Java technology is not fault tolerant and is not designed, manufactured, or intended for use or resale as online control equipment in hazardous environments requiring fail-safe performance, such as in the operation of nuclear facilities, aircraft navigation or communication systems, air traffic control, direct life support machines, or weapons systems, in which the failure of Java technology could lead directly to death, personal injury or severe physical or environmental damage. Sun Microsystems, Inc. has contractually obligated MS to make this disclaimer.
- **No Liability for Certain damages. EXCEPT AS PROHIBITED BY LAW, MS SHALL HAVE NO LIABILITY FOR ANY INDIRECT, SPECIAL CONSEQUENTIAL OR INCIDENTAL DAMAGES ARISING FROM OR IN CONNECTION WITH THE USE OR PERFORMANCE OF THE SOFTWARE. THIS LIMITATION SHALL APPLY EVEN IF ANY REMEDY FAILS OF ITS ESSENTIAL PURPOSE. IN NO EVENT SHALL MS BE LIABLE FOR ANY AMOUNT IN EXCESS OF U.S. TWO HUNDRED FIFTY DOLLARS (U.S. \$250.00).**
- **Limitations on Reverse Engineering, Decompilation and Disassembly.** You may not reverse engineer, decompile, or disassemble the SOFTWARE, except and only to the extent that such activity is expressly permitted by applicable law notwithstanding this limitation.
- **SOFTWARE TRANSFER ALLOWED BUT WITH RESTRICTIONS.** You may permanently transfer rights under this EULA only as part of a permanent sale or transfer of the Device, and only if the recipient agrees to this EULA. If the SOFTWARE is an upgrade, any transfer must also include all prior versions of SOFTWARE.
- **EXPORT RESTRICTIONS.** You acknowledge that SOFTWARE is subject to U.S. export jurisdiction. You agree to comply with all applicable international and national laws that apply to the SOFTWARE, including U.S. Export Administration Regulations, as well as end-user, end-use and destination restrictions issued by U.S. and other governments. For additional information see <http://www.microsoft.com/exporting/>.

PRC HEADQUARTERS

1022 Heyl Rd
Wooster, OH 44691
Telephone: (330) 262-1984 • (800) 262-1984
Fax: (330) 263-4829
E-mail Address: info@prentrom.com
Web Site Address: www.prentrom.com

PRC INTERNATIONAL

Liberator Ltd
"Whitegates", 25-27 High Street
Swinstead, Lincolnshire NG33 4PA UK
Telephone: +44 (0) 1733 370 470
Fax: +44 (0) 1476 552 473
E-mail Address: info@liberator.co.uk
Web Site Address: www.liberator.co.uk

This page intentionally left blank

Contents

Introduction	7
Overview of Features	7
Front View	7
Back View	8
Left Side View	9
Right Side View	9
Commonly Used Features	10
Turning the Device On or Off/Putting it to Sleep	11
Turning on the Device	11
Putting the Device to Sleep/Waking the Device	11
Restarting the Device	11
Powering Off the Device.....	11
Charging the Battery	12
Positioning or Removing the Wire Stand	13
Positioning the Wire Stand.....	13
Removing the Wire Stand.....	14
Removing or Reattaching the Handle	14
Attaching or Removing the Port Cover	15
Mounting the IR Reflector	16
Applying a Screen Protector	18
Removing or Replacing the Device Frame	19
Removing the Frame	19
Attaching the New Frame	20
Attaching the Frame More Securely.....	21
Attaching, Raising, and Removing a Keyguard	22
Attaching the Keyguard.....	22
Raising the Keyguard.....	23
Removing the Keyguard	23
Attaching or Removing a TouchGuide	24
Attaching the TouchGuide.....	24
Removing the TouchGuide	24
Attaching a Carry Strap	25
Attaching a Soft Handle	26
Attaching a Wheelchair Mounting Plate	27
Mounting a NuPoint Module	28
Setting Up and Using a Freedom Switch™	29
Connecting the Freedom Switch	29
Disconnecting the Freedom Switch.....	30
Using Multiple Freedom Switches.....	30

Using the Freedom Switch with Wired Switches.....	30
Mounting the Freedom Switch.....	31
Replacing the Freedom Switch Battery	32
Additional Freedom Switch Tips.....	32
Connecting to a Computer	33
Using the Mini-USB Cable.....	33
Using the PRC Bluetooth Wireless Adapter.....	34
Setting Up Infrared (IR) for Remote Controls	36
Adding a Device	36
Modifying a Device	36
Sending IR Signals to an Appliance.....	36
Using the Cameras	37
Managing Power Settings from the Maintenance Menu.....	38
Setting Up a Wireless Internet Connection	40
Updating the NuVoice Software	41
Updating via the Internet.....	41
Updating via USB Flash Drive	41
Storing Your Device	42
Disposing of the Device or Battery.....	42
Cleaning and Disinfecting.....	43
Routine Cleaning and Disinfecting	43
Disinfecting a Device and Accessories for Multiple Users.....	44
Troubleshooting	45
Battery Troubleshooting	45
General Troubleshooting.....	45
NuVoice Troubleshooting.....	46

Introduction

The Accent® 800 i is a speech-generating device that offers user-friendly features to make speaking fast and easy for individuals with severe speech impairments. This manual describes how to use and maintain your device.

To learn about the NuVoice® software that comes with your device, use the Help button  to the right of the text display area when the device is turned on. You can also download the latest versions of the *NuVoice Software Manual* and this manual from the PRC web site: www.prentrom.com/support.

Overview of Features

Front View

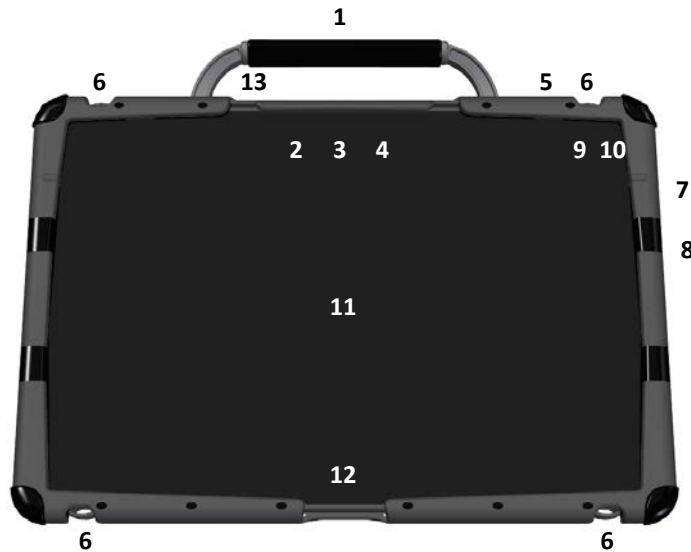

1	Handle	8	Microphone
2	Light sensor	9	Battery/charging LED
3	Camera indicator	10	Power LED
4	Front camera	11	Display screen
5	Power button	12	Tools key
6	Carry strap holders	13	Microphone
7	Volume button		

Back View

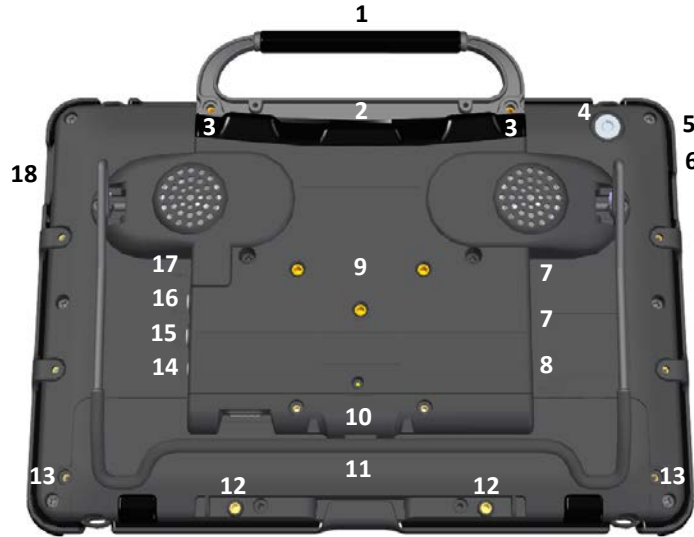

1	Handle	10	USB 2.0 port for NuEye® module
2	Mini USB connector for NuPoint® head tracker	11	Replaceable battery (under cover)
3	Attachment point for handle or NuPoint head tracker	12	Attachment points for device frame
4	Rear camera	13	Battery cover screws
5	SD card slot	14	Headphone jack
6	USB 3.0 port	15	Switch jack B *
7	USB 2.0 ports	16	Switch jack A *
8	External computer access mini port	17	Charging port
9	Wheelchair mounting plate location (plate optional)	18	HDMI port

* If you use a switch or switches for access to your device, plug them into switch jacks A and B. To use a joystick, you will need a Y-adaptor. If you have a joystick plugged in and it does not respond normally, reverse the way it is plugged in (plug switch A into jack B, switch B into jack A).

Left Side View

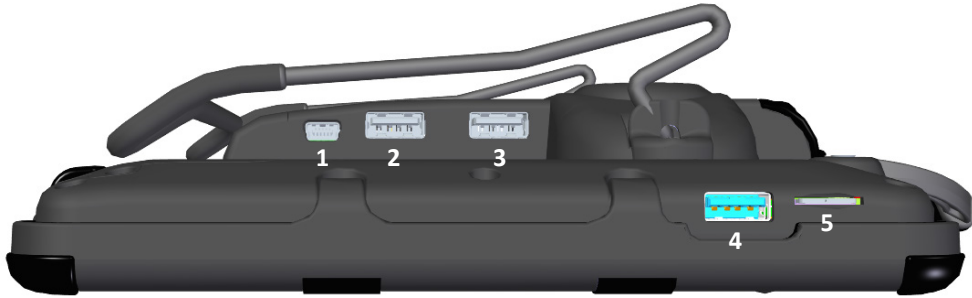

1	External computer access mini port	4	USB 3.0 port *
2	USB 2.0 port **	5	SD card slot
3	USB 2.0 port **		

* The USB 3.0 port supports USB 3.0, USB 2.0, and USB 1.0 accessories.

** The USB 2.0 ports support USB 2.0 and USB 1.0 accessories.

Right Side View



1	Charging port	4	Headphone jack
2	Switch jack A *	5	HDMI port
3	Switch jack B *		

* If you use a switch or switches for access to your device, plug them into switch jacks A and B. To use a joystick, you will need a Y-adaptor. If you have a joystick plugged in and it does not respond normally, reverse the way it is plugged in (plug switch A into jack B, switch B into jack A).

Commonly Used Features

Touch Screen

Important! Do not use sharp, pointed objects on the touch screen. The touch screen is designed to be used with your finger or the stylus that came with your device. This stylus is made specifically for a *capacitive* touch screen. Anything else will harm your touch screen and may cause your device to stop working.

 **The touch screen is a liquid crystal display (LCD). Should the display break (unlikely except in extreme circumstances) and you come into contact with the liquid crystal, wash and rinse your skin thoroughly. Be careful to avoid splintered glass.**

For information on cleaning the touch screen, see “Cleaning the Touch Screen” on page 43.

Power Button

When you press the power button, the power LED will illuminate and the device will open to the NuVoice software. For detailed information about using this button, see “Turning the Device On or Off/Putting it to Sleep” on page 11. For information on changing how the power button operates, see “Managing Power Settings from the Maintenance Menu” on page 38.

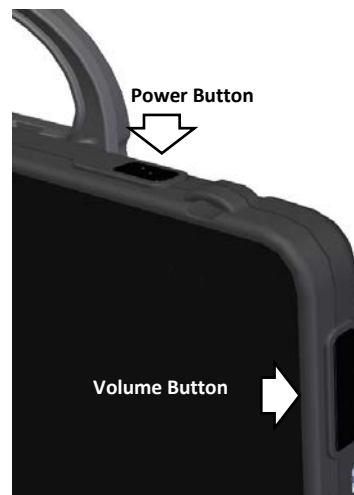

Volume Button

Use the volume button to increase or decrease the volume. You can also use the volume controls in the NuVoice software.

 **To prevent possible hearing damage, do not listen to earphones at high volume levels for long periods.**

Tools Key

On the Device: Press the Tools key *twice* to open the Toolbox. Alternatively, press the Tools key once to open a menu of frequently used tools (including the Toolbox).

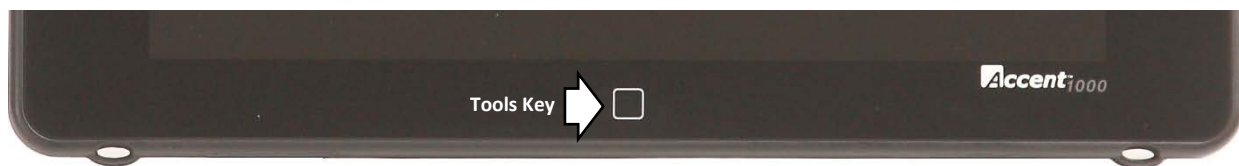

In the NuVoice Software: Select the Tools key *twice* to open the Toolbox. Alternatively, press the Tools key once to open a menu of frequently used tools (including the Toolbox).



Turning the Device On or Off/Putting it to Sleep

To change the operation of the power button in the NuVoice software, see “Managing Power Settings from the Maintenance Menu” on page 38.

Turning on the Device

1. Press and hold the power button located on the top edge of the device. When you hear a beep, release the button. The green power LED will illuminate. The LED will remain illuminated while the device is on and while the device is in sleep mode.
2. Wait for the NuVoice software to load. This will take about 45 seconds.
3. *First time only:* Review the NuVoice Software Agreement and select **I Agree**. The Exploration Wizard will load.
4. Once the Exploration Wizard loads, check the battery status level. For details, see “Charging the Battery” on page 12.

Putting the Device to Sleep/Waking the Device

When you finish using the device for the day, put it in sleep mode overnight. This allows Windows® updates to download. To put the device to sleep, do either of the following:

- Quickly press and release the power button *or*
- Select the **Sleep** key in the NuVoice Toolbox

When the device is inactive for a prolonged period, it will go into sleep mode automatically. The green power LED will remain illuminated while the device is in sleep mode. To wake the device, do either of the following:

- Select the **Tools** key on the front of the device *or*
- Quickly press and release the power button

Note: The device may wake up if a NuEye module is attached or if Windows updates are set to install automatically. To preserve the charge overnight, either connect the charger or power off the device. Transporting the device in a carry case may also wake it. In that case, power off the device.

Restarting the Device

Recommendation: Restart your device once per week if you don't normally turn it off at night or every few days. When the device won't be used for more than a couple days or when it will be transported in a carry case, power it off instead (see “Powering Off the Device” below). To restart the device:

1. Select the **Tools** key and then select the **Toolbox** key.
2. Select **Maint Menu** and then select **Power Management**.
3. Select **Restart** and then select **Yes** at the confirmation prompt.

Powering Off the Device

Recommendation: Power off the device when it won't be used for more than a couple days or when it will be transported in a carry case. If you plan to store it for at least a month, see “Storing Your Device” on page 42.

1. Select the **Tools** key.
2. Select the **Shutdown** option.
3. Select **Yes** at the confirmation prompt.

Charging the Battery

Important! Always use the battery charger that came with your device. Any other charger may damage the batteries. If you think your charger needs to be replaced, call the PRC Service Department at (800) 262-1990; outside the U.S., call your distributor. Service can determine if replacement is necessary and direct you to the correct charger.

How long the battery lasts depends on how you use your device. You may be able to get up to 14 or 15 hours of use from one charge, or you may use your device so heavily that a charge only lasts about 8 hours.

Check the battery status next to the battery icon  in the status display area to quickly view the battery's charge level.

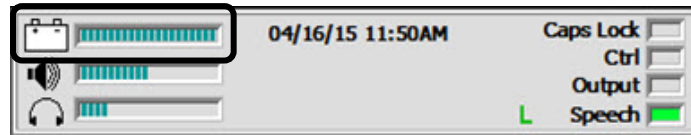

Note: You can also check the Maintenance Menu's Battery Menu for battery information.

The time required to fully charge the battery varies depending on the charge level when the charge begins. When the device needs charging, locate the charging port on the back of the device and connect the battery charger.

Charging a Dangerously Low or Dead Battery

To fully charge a dangerously low battery will take about 10 hours. If the battery is totally dead, an additional two hours may be required. Please note that battery status next to the battery icon  in the status display area will not show a charge for the first few hours of charging. A battery that is not fully depleted will require less time to recharge.

Note: If you need to use the device immediately, plug in the battery charger and leave it plugged in while using the device.

Best Practice

Plug in your battery charger every night when you go to bed and any time you see the low battery warning and/or see the low battery LED come on.

If you cannot plug in the charger overnight, it is best to power off the device to conserve battery charge.

The Battery/Charging LED

When the device is on and the charger is NOT plugged into the device:

- The battery/charging LED is not illuminated.
- When the battery has less than 15% (about three hours) of its power remaining, the battery/charging LED will glow red.

When the device is plugged into the charger:

- *If the device is on:* The battery/charging LED will glow yellow. When the device is fully charged, the LED will turn green.
- *If the device is off:* The battery/charging LED will glow yellow. When the device is fully charged, the LED will turn off.

Positioning or Removing the Wire Stand

 Do not carry the device by the stand. When carrying the device, use the handle or carry strap.

Positioning the Wire Stand

The stand provides three viewing positions. When latched against the back of the device, the stand provides a slight angle for viewing the screen when the device is sitting on a flat surface.

When you need an additional angle, extend the legs of the stand away from the back of the device by doing the following:

1. Place the device face-down on a flat surface.
2. Rotate the stand away from the back of the device.
3. Allow the stand to latch in the middle or fully extended position, depending on your needs.



Stand latched against the back of the device



Stand latched in the middle position



Stand latched in the fully extended position

Note: Your device will be positioned most securely when the stand is latched against the back of the device or fully extended.

Removing the Wire Stand

If you do not want to use the stand, you can remove it from the back of the device. You can reattach it at any time.

1. Place the device face-down on a flat surface.
2. Using a Phillips screwdriver, remove the screws from the holders at the top of each of the stand's legs.

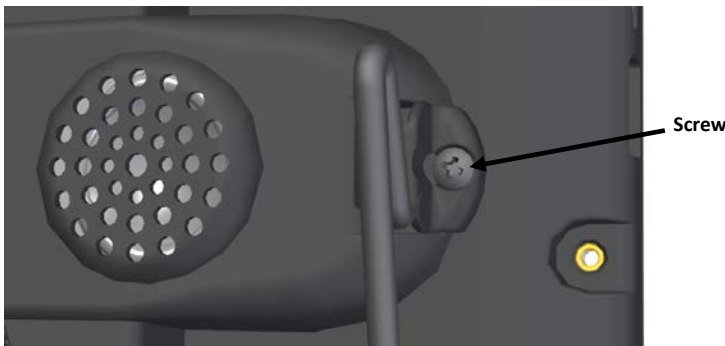

3. Pull the holders free and put the holders and screws in a safe place in case you need to use them later. Alternatively, you can reinsert the screws in the holes in the device.



Loose holders and screws could be a choking hazard.

4. Spread the legs apart to pull them out of the holes in the back of device.
5. Pull the stand free and put it in a safe place in case you need to use it later.

Important! If you reattach the stand, be sure to secure the legs with the holders to prevent someone from pulling it loose accidentally.

Removing or Reattaching the Handle

To remove the handle from the device:

1. Using a Phillips screwdriver, remove the two screws that hold the handle in place.

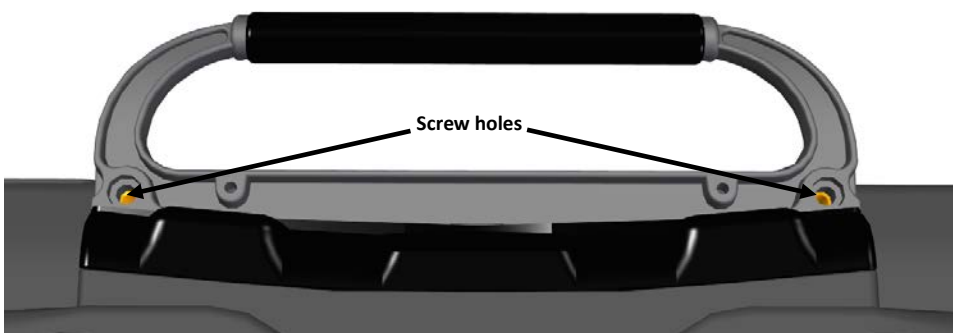

2. Pull the handle away from the device.
3. If you are not going to mount a NuPoint module, it is important to attach the port cover to protect the mini USB connector. See "Attaching or Removing the Port Cover" on page 15.

To reattach the handle:

Remove the port cover or NuPoint module, line up the holes in the handle with the holes on the back of the device, and insert the two screws.

Attaching or Removing the Port Cover

If you removed the handle and are not going to mount a NuPoint module, it is important to attach the port cover to protect the Mini USB Connector on the top of the device.

To attach the port cover to the device:

1. Line up the holes in the cover with the holes on the back of the device.



2. Insert the two screws that previously secured the handle and tighten them using a Phillips screwdriver.

To remove the port cover:

Remove the two screws that hold the port cover in place. Use the screws to mount a NuPoint module or to reattach the handle.

Note: Store the port cover where you can find it if you need to use it again.



Mounting the IR Reflector

Your device emits infrared signals from the IR area on the back of the device. The optional IR reflector allows the user to better “aim” those signals from any position. If you have the IR reflector, follow these instructions to attach it to the device.

The IR reflector can be mounted on the device handle, port cover, or NuPoint module, depending on which is already attached to your device. The reflector kit includes the reflector, two short screws, and two long screws.

1. Using a Phillips screwdriver, remove the appropriate screws, as shown.

Handle: If the handle is attached to your device and the front device frame is held in place with screws, remove the top frame screws.

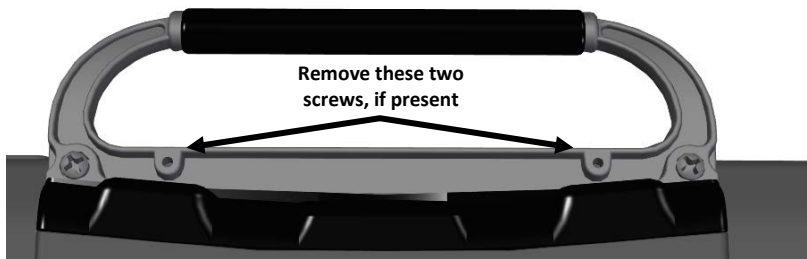

NuPoint Module: If a NuPoint module is attached to your device, remove the two inside screws from the module.



Port Cover: If a port cover is attached to your device, and the front device frame is held in place with screws, remove the top frame screws.

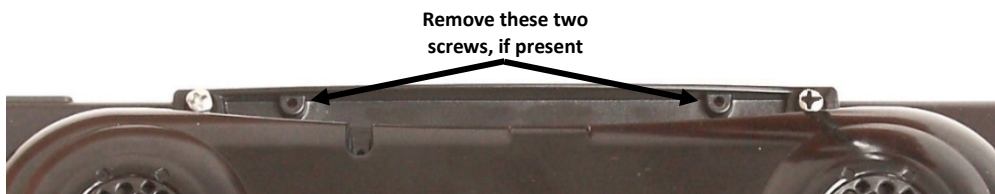

2. Align the holes in the reflector with the empty holes in the handle, port cover, or NuPoint module.

Important! Make sure the reflective shield is aimed downward toward the back of the device, as shown in step 3 on the next page.

3. Insert the appropriate screws in the holes, as shown.

Handle:

Reflector side
pointing downward

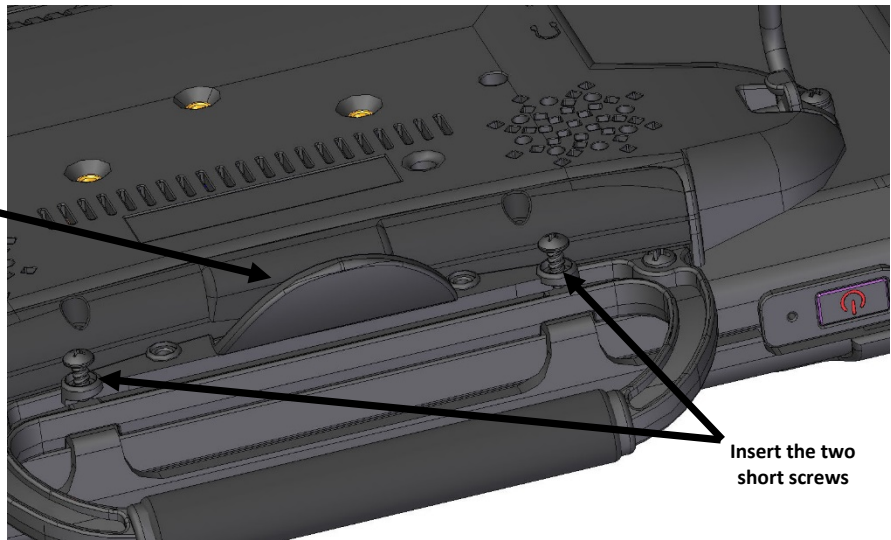

Insert the two
short screws

NuPoint Module:

Reflector side
pointing downward

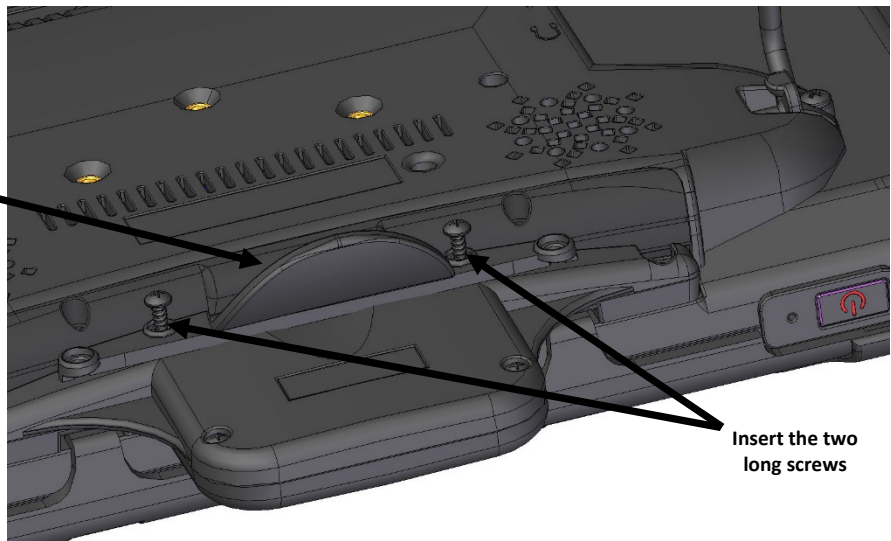

Insert the two
long screws

Port Cover:

Reflector side
pointing downward

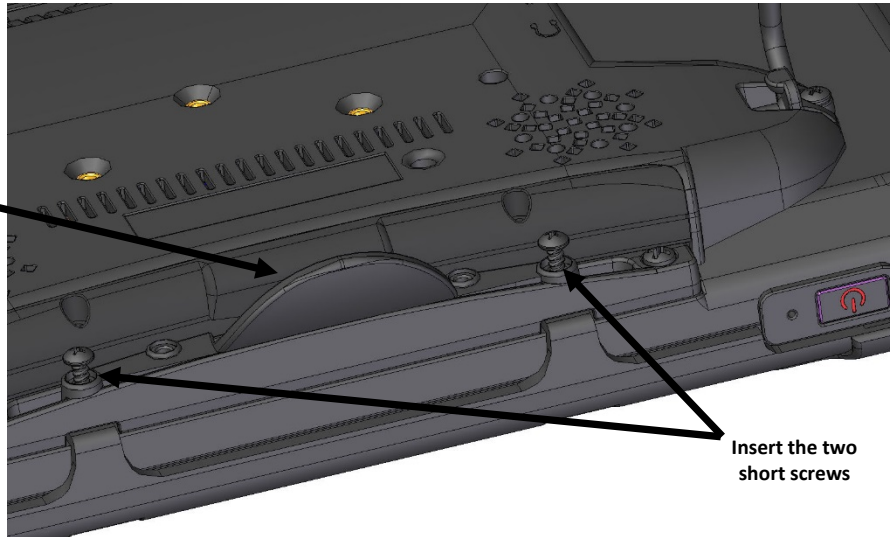

Insert the two
short screws

4. Tighten the screws.

Applying a Screen Protector

If you plan to use a screen protector, you must first remove the device frame. To remove the frame, see “Removing or Replacing the Device Frame” on page 19.

There are six screen protectors in the kit. Three have a matte finish and three have a luster finish. The matte finish offers the most glare resistance. Matte protectors can be identified by the small red square on the backing.

1. Turn your device off and lay it flat on a table.
2. Remove dust and fingerprints from the screen using a lint-free cloth dampened with water or flat-screen TV cleaner.

Hint: Do not dry the screen before applying the screen protector. You may find it easier to smooth out the protector and remove air bubbles (step 7 below) if the screen is slightly damp.

3. Peel a screen protector from its backing.
4. Hold the protector along the edges, with the side that was against the backing now facing the screen.
5. Align one edge of the protector with one edge of the screen.
6. Press the protector onto the screen, adjusting the protector until it covers the screen along all edges.
7. Use the squeegee included to smooth out the protector and remove air bubbles and wrinkles.



8. Wipe the protector with a lint-free cloth to remove any fingerprints.

Hint: Regularly wipe off the protector with a damp lint-free cloth to remove fingerprints, smudges, etc. If the protector becomes too dirty, peel it off and replace it with a new protector.

Removing or Replacing the Device Frame

Your device came with a frame mounted on it. If you need to remove or replace the frame, follow these instructions.

Removing the Frame

1. If you are using a Keyguard or TouchGuide, remove it from the frame. See “Removing the Keyguard” on page 23 or “Removing the TouchGuide” on page 24.
2. Using a Phillips screwdriver, remove the six screws that secure the frame to the device—two on the top and two on each side.
3. Grasp one side of the frame and pull it loose from the device.

Important! If you are replacing the frame, set the screws aside. You will use them to reattach the new frame. If you are not replacing the frame, store the screws in a safe location in case you later decide to reattach the frame.

Hint: You may want to use a flat-head screwdriver or similar tool to gently lift the side and bottom tabs on the back of the device.

 Loose screws could be a choking hazard.

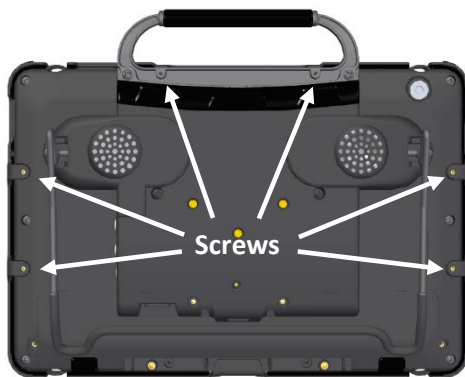

4. Pull the top and bottom tabs loose.



5. Pull the other side loose.



6. Proceed to the next section, “Attaching the New Frame”.

Attaching the New Frame

You must attach the device frame before you can mount a Keyguard or TouchGuide over the screen.

1. Press either the right or left side of the frame onto the edge of the device



2. Pull the top tabs and the other side into place.



3. Pull the bottom tabs into place.



4. The frame is now attached to the device.



5. To secure the frame to the device with screws, proceed to the next section, "Attaching the Frame More Securely".

Attaching the Frame More Securely

If you do not expect to remove and reattach the frame to the device frequently, you may want to insert the original screws in the top and side holes of the frame. If you expect to remove and reattach the frame to the device frequently, you may not want to use the screws.

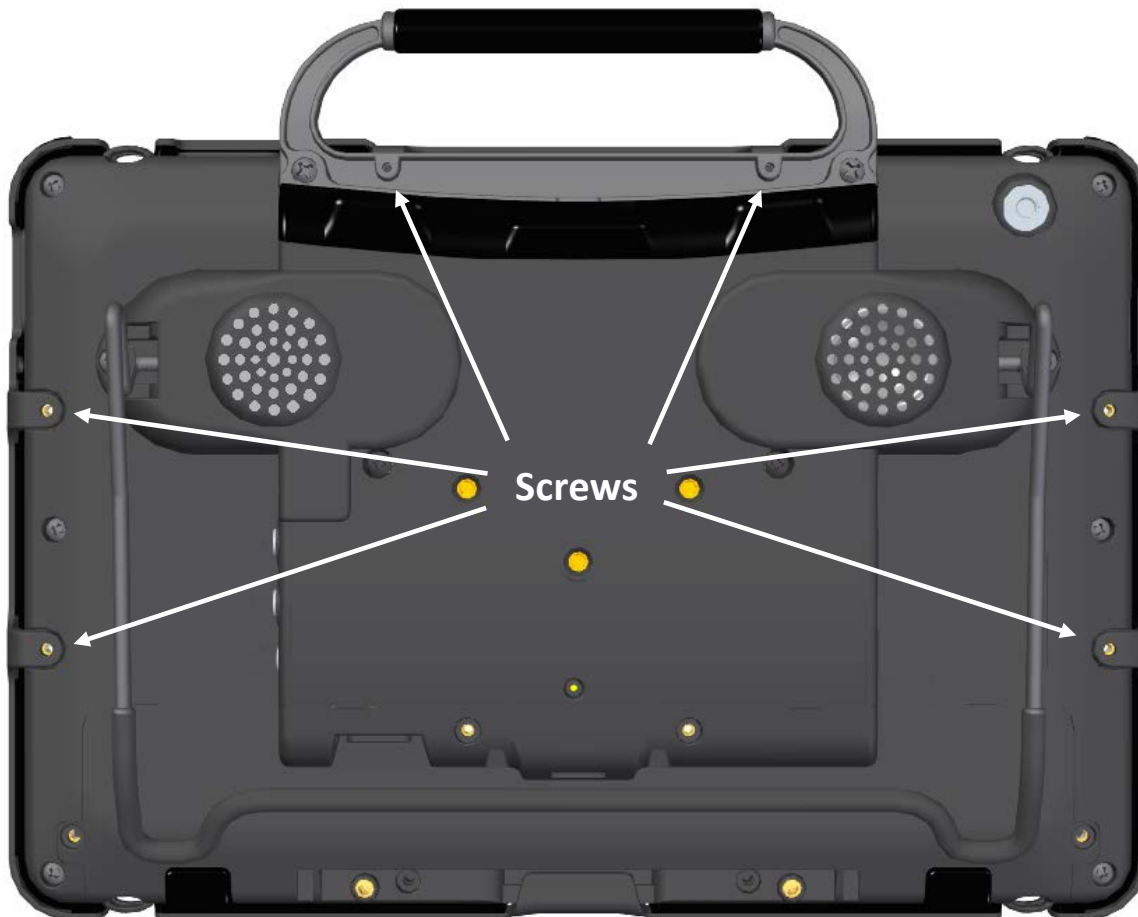

1. Place the device face-down on a flat surface.
2. Insert the two small screws that you removed earlier (page 19, “Removing the Frame”, step 2) through the holes in the top of the frame and into the corresponding holes in the top of the device.
3. Insert the four larger screws through the holes in each side of the frame and into the corresponding holes in the sides of the device.
4. Tighten all six screws with a Phillips screwdriver.

When the device frame is attached securely:

After you attach the frame securely to the device, you can attach a Keyguard or TouchGuide to the frame. See “Attaching the Keyguard” on page 22 or “Attaching the TouchGuide” on page 24.

Attaching, Raising, and Removing a Keyguard

Your device came with a frame mounted on it. The Keyguard attaches to the frame. If you removed the frame, first reattach it, referring to “Removing or Replacing the Device Frame” on page 19.

Attaching the Keyguard

1. Hold the Keyguard over the screen, with the pins toward the top of the screen and the tabs toward the bottom.

Important! Position the Keyguard so that the tabs are on the bottom. The tabs must be able to lie flat against the screen, allowing the Keyguard to snap into place.

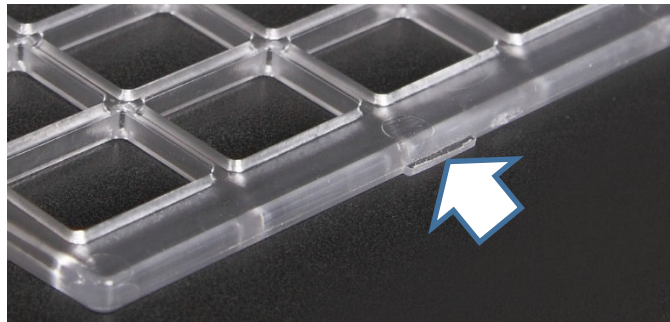

2. Insert one of the Keyguard pins into the opening near the top of the device frame.
3. While holding the pin in place, lift upward with your fingers to bend the middle of the Keyguard upward slightly. Then insert the other pin into the opening on the other side of the device frame.



4. Press down on the bottom portion of the Keyguard to snap the tabs into place.

Note: If the Keyguard tabs at the bottom do not snap into place, make sure that the Keyguard is not upside-down. (See step 1.)

Raising the Keyguard

If you need temporary access to the screen—for example, for programming, changing device settings, cleaning the screen, etc.—you can raise the Keyguard without removing it completely. If you want to remove the Keyguard from the device completely, see “Removing the Keyguard” below.

1. While holding the bottom edge of the device with one hand, use the thumb of your other hand to grasp the bottom edge of the Keyguard in the middle.
2. Pull upward to release the bottom tabs.
3. Leaving the pins inserted in the top of the device frame, simply lift the bottom of the Keyguard to uncover the screen. The Keyguard will remain in the upright position, giving you easy access to the screen.



Removing the Keyguard

1. While holding the bottom edge of the device with one hand, use the thumb of your other hand to grasp the bottom edge of the Keyguard in the middle.
2. Pull upward to release the bottom tabs.
3. Lift upward with your fingers to bend the top-middle portion of the Keyguard upward slightly.

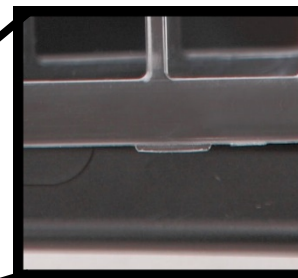

Bottom tabs already pulled loose from the device.

4. Pull the pins out of the openings at the top of the device frame.

Attaching or Removing a TouchGuide

Your device came with a frame mounted on it. The TouchGuide attaches to the frame. If you removed the frame, first reattach it, referring to “Removing or Replacing the Device Frame” on page 19.

Attaching the TouchGuide

1. Align the TouchGuide so that the two squares at the top are positioned at the upper right corner of the display.
2. With the bottom tabs in place, lift upward with your fingers to bend the top right corner of the TouchGuide slightly and insert the tab into the top right slot of the frame.

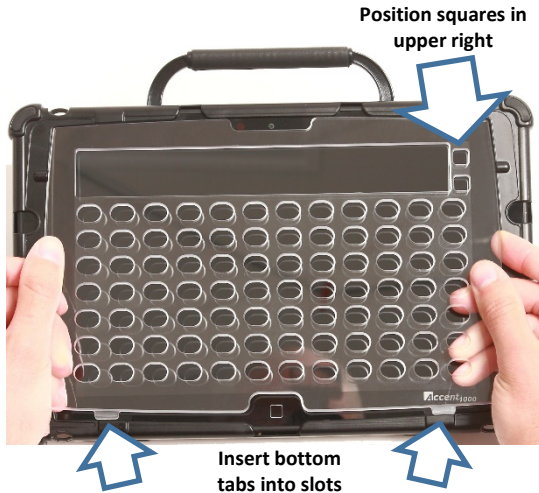

Then insert the bottom tabs of the TouchGuide into the slots at the bottom edge of the frame.



Note: The TouchGuide plastic is stiff and may require some effort to bend.

3. Insert the left tab into the top left slot of the frame using the same method as in step 3. The TouchGuide is now ready to use.

Removing the TouchGuide

1. Grasp the plastic above the first row of keyholes.
2. Pull out and down on the TouchGuide until the upper tabs pop out.



Attaching a Carry Strap

The strap included with your device adjusts from 28 inches to 36 inches. PRC offers a longer strap that adjusts from 38 inches to 60 inches. For details and pricing for this longer strap, please call PRC inside sales at 800.262.1933 or visit <https://store.prentrom.com> and select Accessories and then Carry Case & Strap.

At each end of the strap there is a loop connector with a quick-release connector on the strap side. The device strap holders are located on the top and bottom of the device.

1. Decide whether to connect the carry strap to the top or bottom holders on the device.
2. Detach the loop connector from the strap by pressing in on the sides of the quick-release connector.

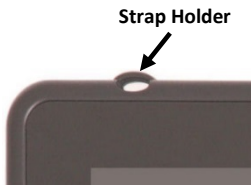

3. Thread the loop through a strap holder on the device. A small straight object like a needle may be helpful to pull the loop through the holder.
4. Thread the loop connector through the loop.



5. Pull the connector through until it is tied securely to the device.
6. Insert the loop connector into the strap connector until they click and hold together.



7. Repeat these steps to connect the other end of the strap to the device.

Attaching a Soft Handle

The soft handle allows you to carry your Accent device with one hand comfortably.

Connectors on the ends of the handle attach to the holders on the top (or bottom) of the device.

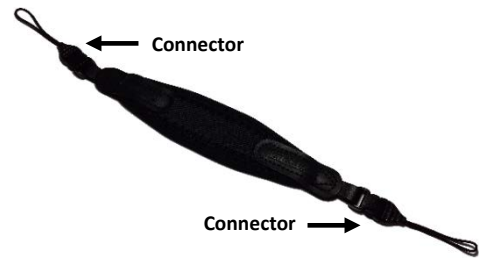

1. If the standard handle is attached to your device, remove it by removing the screws. See “Removing or Reattaching the Handle” on page 14.
2. Attach the port cover included with your device to protect the Mini USB Connector on the top of the device. See “Attaching or Removing the Port Cover” on page 15.
3. Attach the soft handle the same way you would attach a carry strap. Follow steps 2 through 7 under “Attaching a Carry Strap” on page 25.

Attaching a Wheelchair Mounting Plate

Your device can be mounted on a table stand or a wheelchair mount. If you purchased the mounting plate with your device, the plate is already mounted on the back of your device. If you purchased the mounting plate separately, or if you need to replace the mounting plate, follow these instructions.

Important! The mounting plate's screws are held in place on the plate with retaining washers. *Do not remove the washers.*

To attach the mounting plate to the device:

1. Place the device face-down on a flat surface. Be careful not to scratch the display.
2. Using a Phillips screwdriver, remove the three screws that are already in the mounting holes.
3. Align the screws in the mounting plate with the threaded holes on the back of the device.
4. Tighten the screws.



To remove the mounting plate:

1. Loosen the screws just enough that you can pull the plate off the back of the device.
2. Leave the screws held in place by the washers.
3. Store the plate (with the screws held in place) in a safe location in case you need to mount it later.

Mounting a NuPoint Module

Important!

The NuPoint module must be securely attached to the device with all screws to operate properly.

If you purchased a NuPoint module with your device, the module is already mounted on the device. If you purchased the module later, follow these instructions to attach it to the device. You can attach the module to a device with or without a frame.

Note: Your device may look slightly different from the device shown in these photos.

1. Using a Phillips screwdriver, remove the device handle or port cover. See “Removing or Reattaching the Handle” on page 14 or “Attaching or Removing the Port Cover” on page 15. You will use the screws you remove from the handle or port cover to fasten the NuPoint module to the device.

Important! If the device has a frame attached, remove the two top screws that hold the frame in place. Otherwise, the NuPoint module will not mount properly. Store these screws in a safe location or discard them.

 **Loose screws can be a choking hazard.**

2. Align the connector and screw holes on the NuPoint module with the NuPoint USB connector and screw holes on the top edge of the back of the device.



3. Slide the module into place, making the sure the connectors are engaged completely.
4. Tighten the two screws you removed in step 1 to secure the module to the device.

The NuPoint module is ready to set up for use. For detailed instructions on customizing settings, refer to the *NuPoint User's Guide*.

Setting Up and Using a Freedom Switch™

You can connect (pair) one or two Freedom Switches to a device. For 2-switch scanning, you can set up two Freedom Switches or a Freedom Switch with a wired switch. You can also use Freedom Switch along with other access methods. For example, if you are using a headpointer or a joystick, you could connect a Freedom Switch to provide additional access.

Connecting the Freedom Switch

1. In the NuVoice software, go to the Toolbox and select **Access Method Menu**.
2. If switch scanning is not already selected, select **Choose Different Access Method**, select **1 Switch** or **2 Switch**, and select a specific switch scanning method. The Access Method Menu shows the access method you selected.
3. Turn on the Freedom Switch by sliding the On/Off switch to the ON position. The blue LED briefly illuminates.

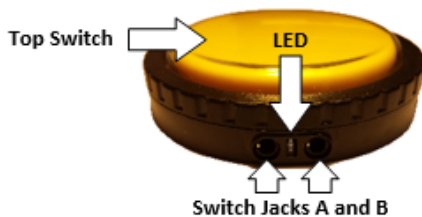

Note: When the Freedom Switch is turned on, the LED illuminates only when the switch is activated.

4. From the Access Method Menu, select **Connect Freedom Switch**. The following message appears: "Freedom Switch is ON. Hit the switch to pair it with NuVoice."
5. **Within 10 seconds**, activate the switch by pressing the large button on the top of the switch.

Note: If you do not press the switch within 10 seconds of seeing the message, the switch will not connect.

6. Select **OK** twice to return to the vocabulary.
7. Press the switch to start scanning.

Note: To activate a second Freedom Switch, repeat steps 4 through 6. To use Freedom Switch with a different access method, select **Headpointing/Joystick** in step 2 above and then **Joystick Auto Scan**, **Joystick Hold Scan**, or **Mouse/Trackball/USB Joystick**.

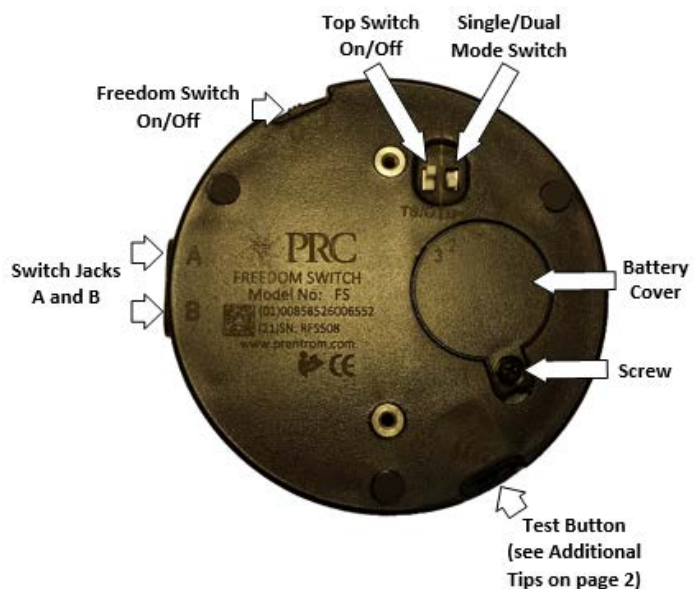

Disconnecting the Freedom Switch

Important! When multiple switches are connected, you cannot disconnect them individually. Selecting **Disconnect ALL Freedom Switches** disconnects *all* switches from the device.

1. In the NuVoice software, go to the Toolbox and select **Access Method Menu**.
2. Select **Disconnect ALL Freedom Switches**.
3. Turn off the Freedom Switch if it is not going to be used for an extended period of time.

Using Multiple Freedom Switches

You can use the Freedom Switch as a single switch or in combination with a second Freedom Switch for 2-switch scanning. By default, the switch is set up to be used as a single switch. To use multiple switches, you'll need to set an internal switch.

1. Turn off the first Freedom Switch by sliding the On/Off switch to the OFF position.
2. Remove the battery cover using a Phillips screwdriver.

Note: You do **not** need to remove the battery.

3. Verify that the internal slide bar (which may be either black or white) is set to position 1 as shown by the numbers on the battery cover. If the slide bar is not set to position 1, **move it as far as it will go to the right**.*

Note: A small screwdriver or the tip of a pen or pencil may be helpful to move the slide bar.

4. Refasten the battery cover.
5. Set the identification of the second Freedom Switch by following steps 1 and 2 and then moving the slide bar (which may be either black or white) to position 2 as shown on the label. **You should feel the slide bar lightly snap into place**.* Position 2 is one position to the left of position 1. Refasten the battery cover.

6. Connect the Freedom Switches as described under "Connecting the Freedom Switch" on page 29.

* If the slide bar is not firmly seated in either position 1 or position 2, the Freedom Switch may not turn on or function properly.

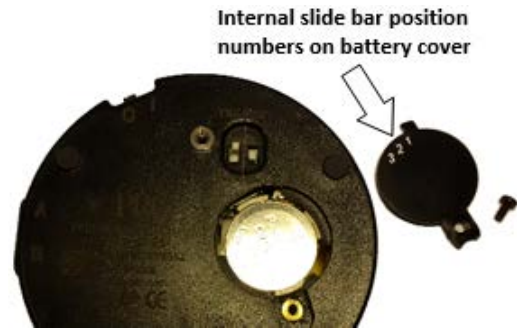

Using the Freedom Switch with Wired Switches

You can also use single or dual wired switches with the Freedom Switch for 2-switch scanning.

1. Connect the Freedom Switch to the device as described under "Connecting the Freedom Switch" on page 29.
2. Do one of the following: Plug a single switch into jack A. *OR* Plug 2 single switches into jacks A and B. *OR* Plug a dual switch into jack A. (*Note:* Only jack A supports dual switches.)
3. If you use 1 or 2 single switches, position the SS/DS switch to **SS**. If you use a dual switch, position the SS/DS switch to **DS**.



Note: To use the Freedom Switch as a hub for wired switches, turn the Top Switch On/Off switch to the OFF position. This will disable the Freedom Switch's large top button, but allow the wired switches to function.

Mounting the Freedom Switch

Freedom Switch includes two different mounting options: (1) A Velcro® brand “donut” and disc for attaching the switch to a loc-line mount and (2) a mounting plate and screws for attaching the switch to a switch mounting kit (SMW-1).

Note: The loc-line mount and switch mounting kit are not included with the switch. The switch mounting kit (SMW-1) is available from the PRC website at Store/Prentrom.com under “Mounts and Brackets”.

To attach the switch to a loc-line mount:

You will affix the ring to the bottom of the Freedom Switch ...



and affix the disc to the switch mount.

1. Peel off the paper backing from the ring and press the adhesive side firmly onto the bottom of the Freedom Switch.



2. Peel off the paper backing from the disc and press the adhesive side firmly onto the switch mount.

3. Fasten the switch to the mount, making sure it is held firmly in place.



To attach the switch to a switch mounting kit (SMW-1):

1. Line up the holes in the plate with the holes on the switch.

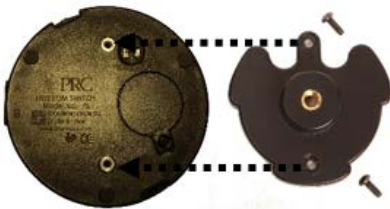

2. Insert the screws in the holes and tighten.



Replacing the Freedom Switch Battery

1. Leave the Freedom Switch On/Off switch turned ON.
2. Remove the battery cover screw and the cover.
3. Remove the battery. Information needed to purchase a replacement battery is printed on the battery.
4. Insert the replacement battery (3V CR2032) with the plus sign (+) facing up toward you.
5. Press the large Freedom Switch button. If the blue LED illuminates, you know you have inserted the battery correctly.
6. Replace the cover and screw.



Dispose of the old battery in accordance with your local, state, and/or country regulations.

Battery Life

With normal use and proper care, the battery should last about one year. This will vary by user and will depend on how much the switch is used. The Freedom Switch uses low energy and draws power only when it is activated.

Battery Tips

- Be sure the blue LED illuminates only when the Freedom Switch or a connected switch is activated. The LED should not remain on continuously.
- During daily use, the Freedom Switch does not need to be turned off.
- If the Freedom Switch is going to be placed in a case or carry bag for transporting, turn it off to prevent the switch from being activated accidentally.
- Turn off the Freedom Switch if it is going to be stored or not used for an extended period of time.

Additional Freedom Switch Tips

- When the top switch is turned off, press the Test button. The LED will illuminate, indicating your Freedom Switch is operational.
- You can use your Freedom Switch as though it were a wired switch.
 - (1) Turn the Freedom Switch off.
 - (2) Connect a cable to switch jack B of the Freedom Switch.
 - (3) Connect the other end of the cable to a switch jack on your device.
 - (4) Use the Freedom Switch as you would any other wired switch.

Connecting to a Computer

You can connect your device to a computer using the mini-USB cable that came with your device. You can also use a PRC Bluetooth® wireless adapter.

Using the Mini-USB Cable

Connect the Cable

1. Plug one end of the cable into the mini-USB port on the back of your device.
2. Plug the other end of the cable into the mini-USB port on your computer.
3. If your device and your computer are not already turned on, turn them on now.

On Your Device

1. Select the **Tools** key on the front of the device or select the **Tools** key to the right of the text display area.
2. Select the **Toolbox** key.
3. In the Toolbox, select **Output Menu**.
4. Set Output to **On**.
5. Set Output Destination to **External**.
6. Set Output Method to **USB**.
7. Set Host Computer to the type of computer you are using: **IBM (PC)** or **Mac**.
8. Select **OK** to exit the menu.

Using the PRC Bluetooth Wireless Adapter



To connect wirelessly to a computer, you must use the PRC Bluetooth wireless adapter. Other wireless adapters will not make the connection.

The adapter is available from the PRC Website: www.prentrom.com. Select **Products, Accessories, Bluetooth**. You can also call the PRC Sales Department: (330)-262-1933 or (800)-262-1933.

You can only use one Bluetooth device at a time with your device. If you are using a Bluetooth switch and want to connect to an external computer, you must unpair your switch and pair with the wireless adapter instead.

Before You Plug In the Adapter

Notice that the wireless adapter has a PRC label on one side and a label with a white circle and an arrow pointing down on the other. The circle label covers a small switch called the "pair button".



You will need to press this white circle during the setup process. Depending on where the USB ports are on your computer, it may be difficult to reach the circle and also reach your device. You may want to ask someone to help you.

Setting up the Adapter

1. Plug the Bluetooth wireless adapter into the USB port on your computer. Remember where the white circle is on the adapter. The LED on the adapter may flash for a moment when you plug it in.
2. Make sure your device is turned on.
3. Select the **Tools** key on the front of the device or select the **Tools** key to the right of the text display area.
4. Select the **Toolbox** key.
5. In the Toolbox, select **Output Menu**.
6. Set Output to **On**.
7. Set Output Destination to **External**.
8. Set Output Method to **Bluetooth**.
9. You will see a yellow box telling you to press the Pair button on the adapter. Press the **white circle** label on the Bluetooth adapter.
10. The LED on the adapter will begin to blink. When you see a solid light, the adapter has paired with your device and computer. This can take up to 20-30 seconds. In the status box in the Output menu you will see "Paired, Connected".
11. Exit the Output menu.

Use the Connection

1. On your device, go to the spelling keyboard.
2. On your computer, open a Word document or other application that will accept typing.
3. Begin typing on your device's spelling keyboard. The information you type will appear on your computer screen. You can now print or distribute your document.

Notes

- Once the adapter is paired with your computer, it should always be paired. You can remove it from your computer. The next time you plug it in, the LED should light and it should be ready to go as long as the Output menu is set correctly.
- The Bluetooth adapter has a wide range. Your device and the adapter do not have to "see" each other to work.
- The **Paired Devices** option in the Output menu allows you to see and reconnect to any Bluetooth devices you have been paired with. **Disconnect** allows you to disconnect from your current Bluetooth device.

Setting Up Infrared (IR) for Remote Controls

IR capability is enabled automatically with the device. The IR area of your device is on the back of the case on each side of the headphone jack, near the top. When you are facing the front of the device, the **IR learning receiver** is on the top left and the **IR transmitter** is on the top right of the IR area.

You can teach infrared signals for almost any appliance you own that has a remote control. If you want to teach a remote control signal to your device, point your remote control at the IR area.

If you want to send an IR signal from your device, make sure the IR area is facing in the general direction of the appliance you want to send the signal to.

Use the IR Setup Menu in the NuVoice Toolbox to teach remote signals to your device. The following IR functions can be performed in the NuVoice software by using **IR Setup Menu** in the Toolbox:

- Add, modify, delete, or rename a device/appliance
- Add, change, delete, and test IR functions

Adding a Device

Several devices are already set up in the Accent device. You only need to teach the signals to your device. To add additional devices, select **Add a Device** and follow the instructions on the display.

Modifying a Device

1. Use the Up/Down arrows to select the appropriate device. When the appropriate device is found, tap the button for the desired function and follow the instructions on the display.
2. Select **Modify Selected Device**.
3. Select the function to be changed and follow the instructions on the display.
4. When instructed, point the appliance's remote control at the top of the Accent device and press the appropriate function button on the remote (for example, the power button).

Note: When teaching the device a new signal or re-learning a signal, make sure the remote is pointed directly at the IR learning receiver on the left side of the headphone jack.

5. The Accent device will beep when it receives the signal.
6. Select **Test Signal** to confirm that the signal functions properly.

Note: The Re-Learn All Signals option allows each signal for an appliance to be re-learned without re-entering the menu each time.

Sending IR Signals to an Appliance

1. Make sure the IR area on the Accent device is facing toward the appliance that will receive the signal.
2. Select the device remote from the vocabulary screen.
3. Select the desired function.

Using the Cameras

The front camera is located in the center of the device at the top of the display.

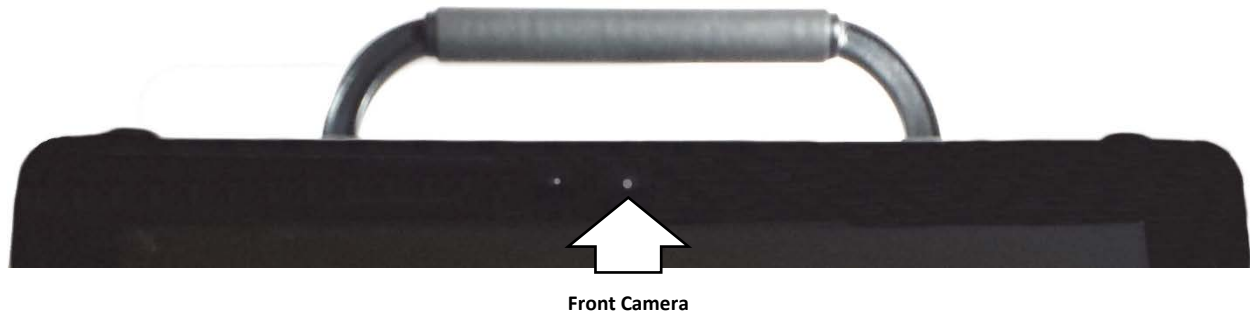

The rear camera is located on the upper right side on the back of the device.



The NuVoice Toolbox contains a **Camera Menu**. Your vocabulary may also have a camera page or camera activity that contains the Camera Menu. The Camera Menu provides an option to zoom in or pan in any direction.

Hold a photograph 6-8 inches away from the lens and take a picture of the photo and use it as an icon or visual scene.

Camera applications such as Skype™, Windows Movie Maker, etc. can be used. Follow the directions provided with each specific camera application.

To switch between the front and rear cameras, select the **Change Camera** icon in the lower left corner of the Camera toolbar.

To use the cameras in the NuVoice software:

1. Select the **Tools** key to the right of the text display area.
2. Open the **Toolbox**.
3. Select **Camera Menu**.
4. To switch between the front and rear cameras, select **Choose Camera**.
5. Select **Front Camera** or **Rear Camera**.

Managing Power Settings from the Maintenance Menu

To manage your device's power settings, go to the Toolbox, select **Maint Menu**, and select **Power Management**. The power management options are I/O Function, Shutdown, Restart, Auto Backlight Dim, and Auto Sleep.

I/O Function

The I/O Function options are Sleep, Hibernate, Shutdown, and Disable. Sleep is the default setting. You can select one of the other options. The options operate as follows when selected.

- Sleep** When Sleep is selected, your device will go to sleep when you press the power button. Press the button again to “wake” the device. In Sleep mode, the device uses only a small amount of battery energy and will come back up more quickly than after a shutdown. The device will also return you to where you were before it went to sleep. Select this mode if you won't be using the device for a relatively short amount of time (less than an hour, for example).
- Hibernate** When Hibernate is selected, your device will hibernate when you press the power button. Press the button again to “wake” the device. In Hibernate mode, the device virtually shuts down, thus saving even more battery energy than Sleep mode. The device will take longer to come back up than it would in Sleep mode, but it will come up faster than after a shutdown. The device will also return you to where you were before it went to sleep. Select this mode if you won't be using the device for a prolonged amount of time (more than a few hours, for example).
- Shutdown** When Shutdown is selected, your device will shut down completely when you press the power button. In this state, your device uses almost no battery energy. It also will take your device longer to come back up when you turn it back on.
- Disable** When you select Disable, the power button is disabled. If you select this option, once you turn your device on, it will not turn off again. This option does *not* save battery energy.

Shutdown

The Shutdown key allows you to completely shut down your device.

1. In the NuVoice software, select the **Tools** key to open the Tools menu.
2. Open the **Toolbox**.
3. Select **Maint Menu**.
4. Select **Power Management**.
5. Select **Shutdown**.
6. A yellow prompt box asks “Are you sure?” Select **Yes**.

When the device shuts down, it will automatically return to the NuVoice software when powered on again.

Restart

The Restart key provides a way to restart your device without having to go to the Windows Start menu. You should rarely need to use this key.

Auto Backlight Dim

Auto Backlight Dim will dim your backlight automatically after the amount of time you set passes. Setting a time will help conserve battery power. The default setting is 2 Minutes. You can change the setting to 1 Minute, 3 Minutes, 4 Minutes, 5 Minutes, 10 Minutes, 20 Minutes, 30 Minutes, or OFF.

Auto Sleep

Auto Sleep will put your device to sleep automatically after the amount of time you set passes. If you set Auto Sleep to **Off**, your device will never go to sleep. The default setting is 30 Minutes. You can change the setting to 1 Minute, 2 Minutes, 3 Minutes, 4 Minutes, 5 Minutes, 10 Minutes, 20 Minutes, or OFF.

Setting Up a Wireless Internet Connection

You can set up your device for a wireless Internet connection. You must have access to a local Wi-Fi network. In the device, Wi-Fi and Bluetooth are always turned on.

Note: PRC is not responsible for the setup of your wireless network.

Hint: If you have a USB mouse, you can plug it into your device and use it to navigate through the setup process.

1. Turn your device on.
2. Select the **Tools** key on the front of the device or select the **Tools** key to the right of the text display area.
3. Select the **Toolbox** key from the Tools menu.
4. Select **Maint Menu** from the Toolbox.
5. Select **Hardware Diagnostics**.
6. Select **Network Setup**.
7. From the Network screen, select the **Connect or disconnect** link.

You will see a list of available networks to connect to and their signal strength. If you are at home, your home network should be visible. If you are at school or work, you will probably see more networks to choose from.

8. Select the network you want to connect to.

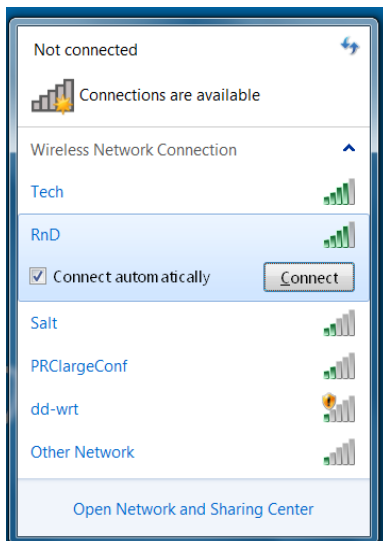

9. Select **Connect**.
10. Follow the directions on your display. You may need to enter a network key or password.
11. When you are connected, the Wi-Fi icon in the task bar changes to bright white.
12. Exit the menu and go to the Internet to test the connection.

Updating the NuVoice Software

Recommendation: Install NuVoice software updates as soon as they are available.

Updating via the Internet

To perform this type of update, your device must be connected to a Wi-Fi network.

1. Plug in the battery charger.
2. Select the **Tools** key.
3. Select the **Toolbox**.
4. Select **Maint Menu**.
5. Select **Software Update Menu**.
6. Select **Internet Update** and follow the on-screen prompts.

Updating via USB Flash Drive

1. Insert your USB flash drive into the computer to which you will download the software update.
2. Go to <https://www.prentrom.com/support/accent>.
3. Under “Featured Downloads” select **Download: USB Flashdrive Software Update**.
4. Under “Accent USB Flashdrive Software Update”, click **Download**.
5. At the “Do you want to open or save” prompt, click the arrow to the right of “Save”, select **Save As**, and save the file to your computer’s desktop.

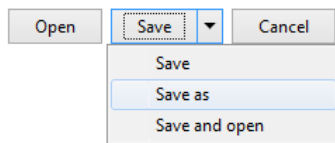

6. Turn on your device and plug in the battery charger.
7. Copy the downloaded file from your computer’s desktop to your USB flash drive.
8. Remove the USB flash drive from your computer and insert it into your device.
9. On the device, go to the Toolbox and select **Maint Menu**.
10. Select **Software Update Menu**, select **USB Update**, and follow the on-screen prompts.
11. When the update process is finished, remove the USB flash drive from your device.

Note: Once your device is running the updated software, you can unplug the battery charger.

Storing Your Device

If you are not going to use the device for at least a month, store it in a dry place with moderate temperatures (not too cold or too hot).

1. Charge the battery to 100%.
2. When the battery is fully charged, go to the Toolbox and select **Maint Menu**.
3. Open the **Battery Menu**.
4. Select **Enter Ship Mode**.
5. Respond **Yes** to put your device into Ship Mode.
6. Select **OK** to exit the Battery Menu.
7. Select **OK** to exit the Maintenance Menu.
8. **Unplug** the battery charger.

When you are ready to use your device again:

1. Plug in the battery charger.
2. Press the power button on your device. Your device will boot up. Leave the charger plugged in until the battery is fully charged.

You can always check the status of the charge by looking at the bar graph next to the battery icon  in the status display area.

If the battery has gone completely dead: Plug in the battery charger. The charging LED on the front of the device will begin to flash rapidly, indicating the battery is charging. Leave the battery charger plugged in until the charging LED is only flashing about once a second which indicates the battery is fully charged. For additional information, see “Battery Troubleshooting” on page 45.

Disposing of the Device or Battery



Device Disposal

Please dispose of your device in accordance with your local, state, and/or federal electronic recycling laws.



Battery Disposal

If the battery in your device needs to be replaced, dispose of the old battery in accordance with your local, state, and/or country regulations.

Cleaning and Disinfecting

If your device will only be used by one person, routine cleaning and disinfecting should be sufficient. If, however, more than one person will be using the device, take additional measures to clean and disinfect the device after it has been used by one person before allowing it to be used by another.

Routine Cleaning and Disinfecting

Important! Do not use solvents or abrasives or spray water or cleaner on the screen or case.

Cleaning the Case

Before cleaning the case or the display, turn the device off. Clean the case with a slightly dampened, lint-free cloth. Dry the case thoroughly with another lint-free cloth before turning the device on.

Cleaning the Touch Screen

The touch screen is very sensitive. Fingerprint smears, dust, grime, saliva, etc. will affect its performance. The screen also reacts to raindrops and extremes in temperature (condensation).

To dust the touch screen, use a soft, lint-free cloth. For heavier cleaning, use a slightly dampened, lint-free cloth and then dry the screen with another soft, lint-free cloth.

Cleaning Keyguard Frames, Keyguards, and TouchGuides

All of these accessories can be removed from the case and washed in hot, soapy water. Dry them **thoroughly** before putting them back on the device. The best practice for regular cleaning is to dry accessories by hand, lay them on a dry towel, and let them air dry for about 5 minutes before placing them back on the device.

Disinfecting

To disinfect everything but the display, use a solution of vinegar and water ($\frac{1}{4}$ cup vinegar to 1 cup water). Wipe the case (not the display) using a cloth dampened with this solution.

Wash the Keyguard frame, Keyguard, and TouchGuide separately with the vinegar and water solution. Allow all equipment to air dry. **Do not use vinegar and water on the display!**

What about drooling/saliva?

Any saliva should be wiped up immediately, especially on the touch screen or around any of the connectors. Use a slightly dampened, lint-free cloth to wipe the device.

What about spills, rain, or accidental immersion?

If you spill liquid or any runny substance on your device; if you're caught in a downpour; or if the device is accidentally dropped in liquid, immediately dry the device as thoroughly as possible. Try using the device. If it does not work, call the PRC Service Department and tell them what happened. They may ask you to send in your device for servicing.

Disinfecting a Device and Accessories for Multiple Users

Important! This section applies only when more than one person will be using the same device. In that situation, it's vital to effectively disinfect the device and accessories that have been used by one person before allowing it to be used by another.

First Step: Put on protective gloves

Next Step: Clean the device and accessories

1. Wipe down the device and accessories with disinfectant wipes (Virucidal, Bactericidal, Pseudomonacidal, Tuberculocidal, Fungicidal)—Metrex CaviWipes™. Follow the disinfectant product manufacturer's instructions for *cleaning*.
2. Take a Q-tip with cleaner applied (for example, Windex® or another commercial cleaner) and clean inside all cracks and crevices. You may want to use a toothbrush or similar brush.
3. Blow the device off with an air hose, or wipe it dry.

Important! Make sure all soil is removed from the device and accessories. This is vital before proceeding to disinfecting the equipment.

Next Step: Disinfect the device and accessories

1. Wipe down the device and accessories with a new disinfectant wipe (Virucidal, Bactericidal, Pseudomonacidal, Tuberculocidal, Fungicidal)—Metrex CaviWipes. Follow the disinfectant product manufacturer's instructions for *disinfecting*.
2. Make sure to clean inside all cracks and corners, and wipe more than once if necessary to keep the device wet for a minimum of three (3) minutes.
3. Allow the device and accessories to dry.

Final Step: Wipe the touch screen

1. When the device and accessories are dry, wipe down the viewing area (device touch screen, TouchGuide, Keyguard, etc.) with glass cleaner, so the screen doesn't discolor.
2. Allow the equipment to dry.

Troubleshooting

Battery Troubleshooting

The battery died while the NuVoice software was running

The battery charger LED and the charging LED on the front of the device will begin to alternate flashing. Plug in the battery charger to continue using the device. If you do not plug in the battery charger, the NuVoice software and/or the operating system will shut down, the LEDs will stop blinking, and the device will turn off.

To restart the device, plug in the battery charger, press and hold the power button for a few seconds, and watch the display screen. If the battery was completely dead, you may want to let it charge for awhile before you turn your device on.

You think the device battery needs to be replaced

The battery in your device is replaceable. If the battery will not recharge or hold a charge, call the PRC Service Department before replacing the battery: (800) 262-1990. Outside the United States, call your local distributor.



There is a slight risk of explosion if you replace the battery with an incorrect type.

You think the battery charger needs to be replaced

Use only the battery charger that came with the device. Any other charger may damage the batteries. If you think your charger needs to be replaced, call the PRC Service Department at (800) 262-1990; outside the U.S., call your distributor. Service can determine if replacement is necessary and direct you to the correct charger.

General Troubleshooting

You select a key but get the wrong response

If you are selecting keys on the keyboard but not getting the correct responses, thoroughly clean the display screen as described under “Cleaning and Disinfecting” on page 43. Then try again.

High-Efficiency Fluorescent Lights and the Use of Infrared

There is often a compatibility problem between many infrared controls and high-efficiency fluorescent lights.

If the device is being used in a room that has high-efficiency fluorescent lighting, the infrared, including headpointing, computer access, remote control commands, etc., may not work. Turn the lights off and the IR will work correctly.

NuVoice Troubleshooting

If you are experiencing problems with the device operating system or the NuVoice software, it is important to read and follow these instructions.

For any internal system software troubleshooting, **always** plug in the battery charger first.

The Device Stops Speaking

1. In the NuVoice software, select the **Tools** icon and then select the **Toolbox** key.
2. Select **Maint Menu**.
3. Select **Power Management**.
4. Select **Shutdown**.
5. After the device has shut down, press the power button to restart the device.

The Device is Not Working Correctly or Freezes, but You Can Access the NuVoice Software

Important! Do not use the power button.

1. In the NuVoice software, select the **Tools** icon and then select the **Toolbox** key.
2. Select **Maint Menu**.
3. Select **Power Management**.
4. Select **Restart**.

The NuVoice Toolbox is Not Responding or is Unavailable

1. Open the Windows **Start** menu.
2. Pull the Windows **Charms** menu from the right side of the display.
3. Tap the **Power** icon.
4. Select **Restart**. **Do not select Shutdown**.

If you have access to a USB keyboard:

1. Plug the keyboard into a USB port on the device.
2. Press **Ctrl-Alt-Del**.
3. If a blue screen appears with **Lock, Switch, Sign-out**, etc. on it, use the **Tab** key until it highlights the **I/O** option in the lower left corner.
4. Select **Enter**.
5. Select **Restart**.

As a Last Resort

Insert an unbent paper clip into the small hole in the power button until the device shuts down. Then press the power button to restart the device.

Important! This action may cause issues with the memory and performance of the device.

FCC Caution.

This device complies with part 15 of the FCC Rules. Operation is subject to the following two conditions:

- (1) This device may not cause harmful interference, and
- (2) this device must accept any interference received, including interference that may cause undesired operation.

Any Changes or modifications not expressly approved by the party responsible for compliance could void the user's authority to operate the equipment.

Note: This equipment has been tested and found to comply with the limits for a Class B digital device, pursuant to part 15 of the FCC Rules. These limits are designed to provide reasonable protection against harmful interference in a residential installation. This equipment generates uses and can radiate radio frequency energy and, if not installed and used in accordance with the instructions, may cause harmful interference to radio communications. However, there is no guarantee that interference will not occur in a particular installation. If this equipment does cause harmful interference to radio or television reception, which can be determined by turning the equipment off and on, the user is encouraged to try to correct the interference by one or more of the following measures:

- Reorient or relocate the receiving antenna.
- Increase the separation between the equipment and receiver.
- Connect the equipment into an outlet on a circuit different from that to which the receiver is connected.
- Consult the dealer or an experienced radio/TV technician for help.

The device has been evaluated to meet general RF exposure requirement. The device can be used in portable exposure condition without restriction.

Operations in the 5.15-5.25GHz band are restricted to indoor usage only.

IC Warning

This device complies with Industry Canada licence-exempt RSS standard(s). Operation is subject to the following two conditions:

- (1) This device may not cause interference, and
- (2) This device must accept any interference, including interference that may cause undesired operation of the device.

Le présent appareil est conforme aux CNR d'Industrie Canada applicables aux appareils radio exempts de licence. L'exploitation est autorisée aux deux conditions suivantes:

- (1) l'appareil ne doit pas produire de brouillage, et
- (2) l'utilisateur de l'appareil doit accepter tout brouillage radioélectrique subi, même si le brouillage est susceptible d'en compromettre le fonctionnement

The device has been evaluated to meet general RF exposure requirement. The device can be used in portable exposure condition without restriction.

L'appareil a été évalué pour répondre aux exigences générales d'exposition aux RF.

L'appareil peut être utilisé dans une condition d'exposition portable sans restriction.

Operations in the 5.15-5.25GHz band are restricted to indoor usage only.

Les opérations dans la bande 5.15-5.25GHz sont limitées à une utilisation en intérieur.