



Hardware Manual

For Accent 1000 Models with Serial Numbers xxxxxx and Higher

Prentke Romich Company



Acknowledgements

Important! Data can be uploaded from this unit to a personal computer for storage on a hard disk, CD, or other storage medium. Be sure to make multiple copies of all important data to protect against accidental loss.

Accent, NuEye, and NuVoice are trademarks of Prentke Romich Company.

Minspeak and Unity are registered trademarks of Semantic Compaction Systems, Inc. in the United States and in other countries.

Semantic Compaction is a trademark of Semantic Compaction Systems, Inc.

Windows, Windows Explorer, Windows Media Player, Windows Movie Maker and Windows Live Movie Maker are registered trademarks of Microsoft, Inc.

The Skype name, associated trademarks and logos, and the "S" logo are trademarks of Skype Limited

Bluetooth Wireless Technology is a registered trademark. The Bluetooth word mark and logos are owned by the Bluetooth SIG, Inc. and any use of such marks by PRC is under license. Other trademarks and trade names are those of their respective owners.

ELECTRONIC INTERFERENCE INFORMATION

This device complies with Part 15 of the FCC Rules. Operation is subject to two conditions: (1) this device may not cause harmful interference, and (2) this device must accept any interference received, including interference that may cause undesired operation.

Warning! Changes or modifications to this product which are not authorized by Prentke Romich Company could exceed FCC limits and negate your authority to use this product.

This equipment has been tested and found to comply with the limits for a Class B digital device, pursuant to Part 15 of the FCC Rules. These limits are designed to provide reasonable protection against harmful interference in a residential installation. This equipment generates, uses and can radiate radio frequency energy and, if not installed and used in accordance with the instructions, may cause harmful interference to radio communications. However, there is no guarantee that interference will not occur in a particular installation. You can determine whether this product is causing interference in your radio or television by turning this product off. If the interference stops, it was probably caused by this product or one of its accessories. You can attempt to correct the interference by using one or more of the following measures:

- Turn the television or radio antenna until the interference stops.
- Move this product to one side or the other of the television or radio.
- Move this product farther away from the television or radio.
- Plug this product into an outlet that is on a different circuit from the television or radio; that is, this product should be controlled by different circuit breakers/fuses from the television or radio.
- If necessary, contact a Prentke Romich Company service technician for assistance.

Bluetooth Adapter

These devices comply with Part 15 of the FCC Rules. Operation is subject to the following two conditions: (1) these devices may not cause harmful interference, and (2) these devices must accept any interference received, including interference that may cause undesired operation. The Bluetooth device contains FCC-ID POOWML-C40. Bluetooth QD ID B013848

This Class B digital apparatus meets all requirements of the Canadian Interference-Causing Equipment Regulations. Cet appareil numérique de la classe B respect toutes les exigences du Règlement sur le matériel brouiller du Canada.

CE ENVIRONMENTAL INFORMATION: Use: 0° - 45° C; Storage: (-20°) - 50° C; 95% maximum relative humidity @ ambient temperatures less than 40° C.



Attention! Consult accompanying documents. This device not intended to be an emergency call device or sole communication aid.



Warnings!

- When operating this device in a medical environment, do not use with any product that is not medically approved. Follow all rules for appropriate cell phone and wireless device use
- Any mounts used should be fitted by a qualified person. This product can only be installed on wheelchair bracket, and the distance away from the body must be greater than 20cm.
- Analysis of positioning by a qualified person is required to prevent repetitive stress injuries.
- Small parts could present a choking or other hazard.

© 2015 Prentke Romich Company. All rights reserved. Under copyright laws this document may not be copied, in whole or in part, without the written consent of the Prentke Romich Company.

PRC HEADQUARTERS

1022 Heyl Rd
Wooster, OH 44691

Telephone: (330) 262-1984 • (800) 262-1984

Fax: (330) 263-4829

E-mail Address: info@prentrom.com

Web Site Address: www.prentrom.com

PRC INTERNATIONAL

Liberator Ltd

"Whitegates", 25-27 High Street
Swinstead, Lincolnshire NG33 4PA UK

Telephone: +44 (0) 1733 370 470

Fax: +44 (0) 1476 552 473

E-mail Address: info@liberator.co.uk

Web Site Address: www.liberator.co.uk

End User Licensing Agreement

You have acquired a PRC device which includes software licensed by PRC from Microsoft Licensing Inc. or its affiliates ("MS"). Those installed software products of MS origin, as well as associated media, printed materials and "online" or electronic documentation (software) are protected by international intellectual property laws and treaties.

IF YOU DO NOT AGREE TO THIS END USER LICENSE AGREEMENT (EULA), DO NOT USE THE DEVICE OR COPY THE SOFTWARE. INSTEAD, PROMPTLY CONTACT PRENTKE ROMICH COMPANY FOR INSTRUCTIONS. ON RETURN OF THE UNUSED DEVICE(S) FOR A REFUND. **ANY USE OF THE SOFTWARE, INCLUDING BUT NOT LIMITED TO USE ON THE DEVICE, WILL CONSTITUTE YOUR AGREEMENT TO THIS EULA (OR RATIFICATION OF ANY PREVIOUS CONSENT).**

GRANT OF SOFTWARE LICENSE.

This EULA grants you the following license:

- You may use the SOFTWARE only on your PRC device.
- **NOT FAULT TOLERANT.** THE SOFTWARE IS NOT FAULT TOLERANT. PRC HAS INDEPENDENTLY DETERMINED HOW TO USE THE SOFTWARE AND MS HAS RELIED UPON PRC TO CONDUCT SUFFICIENT TESTING TO DETERMINE THAT THE SOFTWARE IS SUITABLE FOR SUCH USE.
- NO WARRANTIES FOR THE SOFTWARE. **THE SOFTWARE is provided "AS IS" and with all faults. THE ENTIRE RISK AS TO SATISFACTORY QUALITY, PERFORMANCE, ACCURACY, AND EFFORT (INCLUDING LACK OF NEGLIGENCE) IS WITH YOU. ALSO THERE IS NO WARRANTY AGAINST INTERFERENCE WITH YOUR ENJOYMENT OF THE SOFTWARE OR AGAINST INFRINGEMENT.** IF YOU HAVE RECEIVED ANY WARRANTIES REGARDING THE DEVICE OR SOFTWARE, THOSE WARRANTIES DO NOT ORIGINATE FROM, AND ARE NOT BINDING ON, MS.
- **Note on Java Support.** The SOFTWARE may contain support for programs written in Java. Java technology is not fault tolerant and is not designed, manufactured, or intended for use or resale as online control equipment in hazardous environments requiring fail-safe performance, such as in the operation of nuclear facilities, aircraft navigation or communication systems, air traffic control, direct life support machines, or weapons systems, in which the failure of Java technology could lead directly to death, personal injury or severe physical or environmental damage. Sun Microsystems, Inc. has contractually obligated MS to make this disclaimer.
- No Liability for Certain damages. **EXCEPT AS PROHIBITED BY LAW, MS SHALL HAVE NO LIABILITY FOR ANY INDIRECT, SPECIAL CONSEQUENTIAL OR INCIDENTAL DAMAGES ARISING FROM OR IN CONNECTION WITH THE USE OR PERFORMANCE OF THE SOFTWARE. THIS LIMITATION SHALL APPLY EVEN IF ANY REMEDY FAILS OF ITS ESSENTIAL PURPOSE. IN NO EVENT SHALL MS BE LIABLE FOR ANY AMOUNT IN EXCESS OF U.S. TWO HUNDRED FIFTY DOLLARS (U.S. \$250.00).**
- Limitations on Reverse Engineering, Decompilation and Disassembly. You may not reverse engineer, decompile, or disassemble the SOFTWARE, except and only to the extent that such activity is expressly permitted by applicable law notwithstanding this limitation.
- **SOFTWARE TRANSFER ALLOWED BUT WITH RESTRICTIONS.** You may permanently transfer rights under this EULA only as part of a permanent sale or transfer of the Device, and only if the recipient agrees to this EULA. If the SOFTWARE is an upgrade, any transfer must also include all prior versions of SOFTWARE.
- **EXPORT RESTRICTIONS.** You acknowledge that SOFTWARE is subject to U.S. export jurisdiction. You agree to comply with all applicable international and national laws that apply to the SOFTWARE, including U.S. Export Administration Regulations, as well as end-user, end-use and destination restrictions issued by U.S. and other governments. For additional information see <http://www.microsoft.com/exporting/>.

PRELIMINARY

17418v1.0 · 05/08/2015

Introduction

The Accent™ 1000 is a speech-generating device that offers user-friendly features to make speaking fast and easy for individuals with severe speech impairments. This manual describes how to use and maintain your device.

To learn about the NuVoice™ software that comes with your device, use the Help button  to the right of the text display area when the device is turned on. You can also download the latest versions of the *NuVoice Software Manual* and this manual from the PRC web site: www.prc.com/support.

Overview of Features

Front View

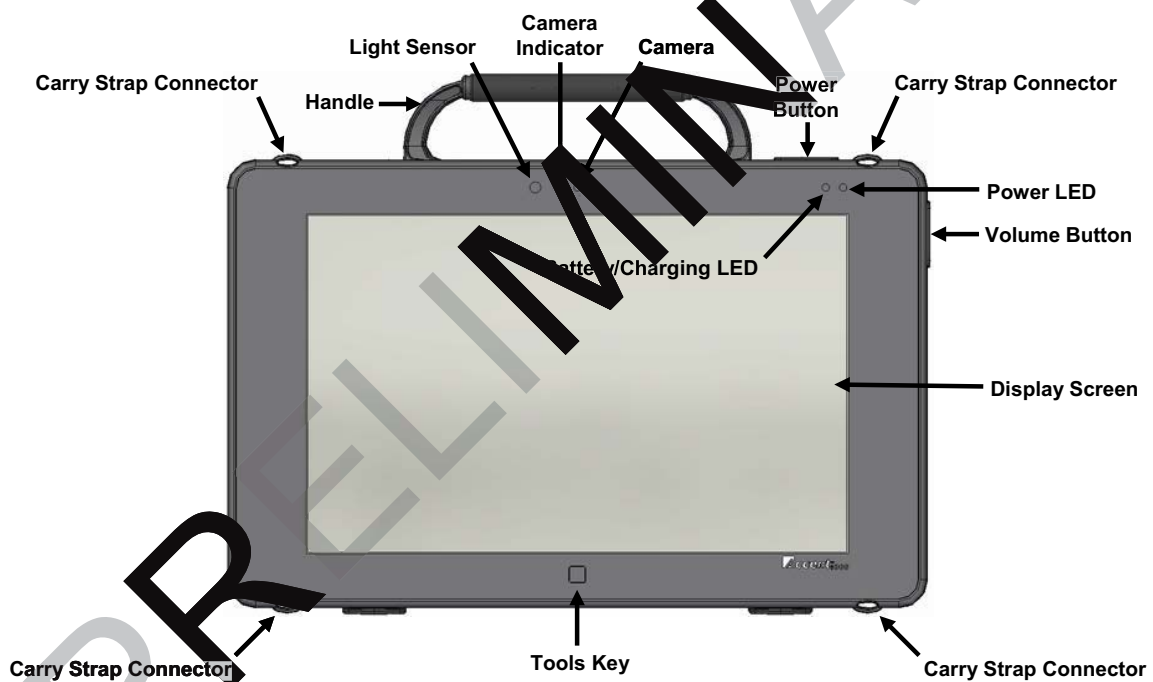

Commonly Used Features

Touch Screen

Important! Do not use sharp, pointed objects on the touch screen. The touch screen is designed to be used with your finger or the stylus that came with your device. This stylus is made specifically for a *capacitive* touch screen. Anything else will harm your touch screen and may cause your device to stop working.

⚠ The touch screen is a liquid crystal display (LCD). Should the display break (unlikely except in extreme circumstances) and you come into contact with the liquid crystal, wash and rinse your skin thoroughly. Be careful to avoid splintered glass.

For information on cleaning the touch screen, see “Cleaning the Touch Screen” on page 55.

Power Button

When you press the power button, the power LED will illuminate and the device will open to NuVoice. For detailed information about using this button, see “Turning the Accent On or Off/Putting to Sleep” on page 11. For information on changing how the power button operates, see “Managing Power Settings” on page 34.

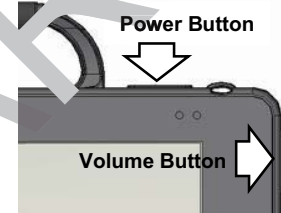

Volume Button

Use the volume button to increase or decrease the volume. You can also use the volume controls in NuVoice.

Tools Key

On the Device: Press the Tools key *twice* to open the Toolbox. Alternatively, press the Tools key once to open a menu of frequently used tools (including the Toolbox).



In NuVoice: Select the Tools key *twice* to open the Toolbox. Alternatively, press the Tools key once to open a menu of frequently used tools (including the Toolbox).



Turning the Accent On or Off/Putting to Sleep

This section explains how to turn on the device, put the device into sleep mode and wake it, restart the device, and power the device off. You can change the operation of the power button. For information about setting up the power button in NuVoice, see “Managing Power Settings” on page 34.

Turning on the Accent

1. Press and hold the power button located on the top edge of the device. When you hear a beep, release the button. The green power LED will illuminate.
 - The LED will remain illuminated while the device is on.
 - The LED will blink when the device is in sleep mode.
2. Wait for the NuVoice software to load. This will take about 45 seconds.
3. *First time only:* Review the NuVoice Software Agreement and select **I Agree**. The Exploration Wizard will load.
4. Once the Exploration Wizard loads, check the battery status level. For details, see “Charging the Battery” on page 12.

Putting to Sleep/Waking the Accent

When you finish using the Accent for the day, put it in sleep mode overnight. This allows Windows updates to download. To put the device to sleep, do either of the following:

- Quickly press and release the power button *or*
- Select the **Sleep** key in the NuVoice Toolbox

When the device is inactive for a prolonged period, it will go into sleep mode automatically. The green power LED will blink while the device is in sleep mode.

To wake the device, do either of the following:

- Select the **Tools** key on the front of the device *or*
- Quickly press and release the power button

Restarting the Accent

It is recommended that you restart your Accent once per week. To restart the device:

1. Select the **Tools** key and then select the **Toolbox** key.
2. Select **Maint Menu** and then select **Power Management**.
3. Select **Restart** and then select **Yes** at the confirmation prompt.

Powering Off the Accent

When you don't plan to use the Accent or want to store it for more than a couple days, it is best to power off the device completely.

1. Select the **Tools** key.
2. Select the **Shutdown** option.
3. Select **Yes** at the confirmation prompt.

Charging the Battery

⚠ Always use the battery charger that came with your device. Any other charger may damage the battery.

How long the battery lasts depends on how you use your device. You may be able to get up to 18 hours of use from one charge, or you may use your device so heavily that a charge only lasts about 10 hours.

Check the battery status next to the battery icon  in the status display area to quickly view the battery's charge level.

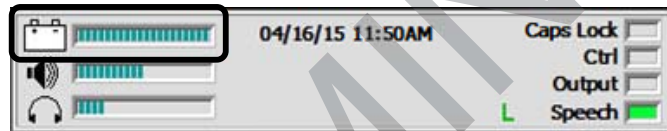

Note: You can also check the Maintenance Menu's Battery Menu for battery information.

The time required to fully charge the battery varies depending on the charge level when the charge begins. When the device needs charging, locate the charging port on the back of the device and connect the battery charger.

Charging a Dangerously Low or Dead Battery

To fully charge a dangerously low battery will take about 10 hours. If the battery is totally dead, an additional two hours may be required. Please note that battery status next to the battery icon  in the status display area will not show a charge for the first few hours of charging.

A battery that is not fully depleted will require less time to recharge.

Best Practice

Plug in your battery charger every night when you go to bed and any time you see the low battery warning and/or see the low battery LED come on.

The Battery/Charging LED

When the device is on: The battery/charging LED is not illuminated. When the battery has less than 15% (about three hours) of its power remaining, the LED will blink yellow.

When the device is plugged into the charger: The battery/charging LED will glow yellow. When the device is fully charged, the LED will turn green and remain on until the charger is unplugged.

Attaching Bumper Guards

Your Accent shipped with protective bumper guards. These guards fit over the corners of the device to provide extra protection. If your device is likely to be subjected to heavy stress, you may want to attach the bumper guards.



⚠ If you attach the bumper guards, be sure to secure them **with the screws**. Otherwise they can be pulled loose, creating a choking hazard.

1. Select the set of bumper guards you want.
2. From one of the corners of the device, remove the mounting screw that is already in place.

Note: Save this screw. You will need it to attach the bumper guard (in step 4).

3. Push the bumper guard onto the corner.
4. Insert the mounting screw through the hole in the guard and into the hole in the device.

Note: Be sure to insert the same screw that you removed in step 2.

5. Tighten the screw.



6. Repeat steps 1 – 5 for the other three corners.

Removing the Wire Stand

If you do not want to use the stand, you can remove it from the back of the device. You can reattach it at any time.

1. Place the device face-down on a flat surface.
2. Remove the screws from the holders at the end of each of the stand's legs.



3. Pull the holders free and put them in a safe place in case you need to use them later.

⚠ Loose holders could be a choking hazard.

4. Spread the legs apart to pull them out of the holes in the back of device.



5. Pull the stand free and put it in a safe place in case you need to use it later.

Important! If you reattach the stand, be sure to secure the legs with the holders to prevent someone from pulling it loose accidentally.

Removing or Reattaching the Handle

If you want to remove the handle from the device, simply remove the two screws that hold it in place. To reattach the handle, line up the holes in the handle with the holes on the back of the device.



Applying a Screen Protector

If you plan to use a screen protector, apply it before attaching the device frame. If the frame is already in place, you must remove it before applying the screen protector. If you need to remove the frame, see “Replacing the Device Frame” on page 21.

1. Turn your device off and lay it flat on a table.
2. Remove dust and fingerprints from the screen using a lint-free cloth dampened with **water** or flat-screen TV cleaner.
3. Peel a screen protector from its backing.
4. Hold the protector along the edges with the side that was against the backing **facing the screen**.
5. Align one edge of the protector with one edge of the screen.
6. Press the protector onto the screen, adjusting the protector until it covers the screen along all edges.
7. Use the squeegee included to smooth out the protector and **remove air bubbles** and wrinkles.



8. Wipe the protector with a lint-free cloth to **remove any fingerprints**.

Hint: Regularly wipe off the protector with a **damp lint-free cloth** to remove fingerprints, smudges, etc. If the protector becomes too dirty, **peel it off and replace it with a new protector**.

Attaching the Device Frame

Removing the Screws from the Bottom of the Device

Before you can attach the frame, you must remove two screws from the bottom of the device.

Important! After removing these screws, set them aside. You will need them later if you want to secure the frame to the device with screws.

1. Place the device face-down on a flat surface with the bottom facing toward you.
2. Remove the screws shown below with a Phillips screwdriver.



Remove these two screws

3. Set the screws aside. For information on using these screws, see “For an Even More Secure Fit” on page 20.

Attaching the Device Frame

Note: You must attach the device frame before you can mount a Keyguard or TouchGuide over the screen.

1. Line up the Keyguard tabs with the slots on the top of the device.



2. Press the tabs into the slots.

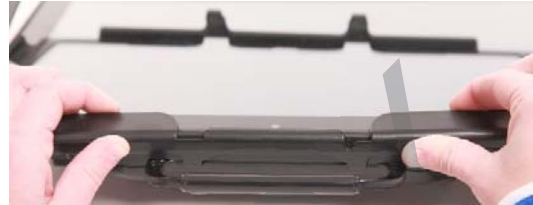

3. Pull out slightly on the sides of the frame.



4. Push the sides down until they fit over the edges of the device.

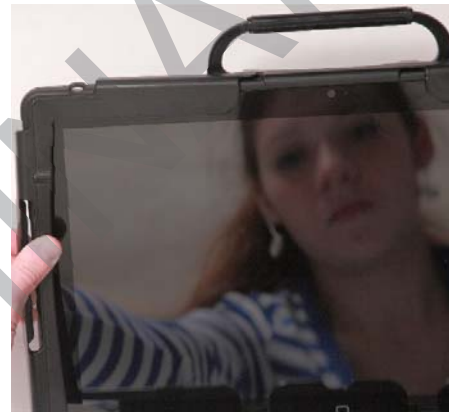

5. Pull out slightly on the bottom of the frame



6. Push the bottom of the frame over the bottom edge of the device. Snap the frame into place.

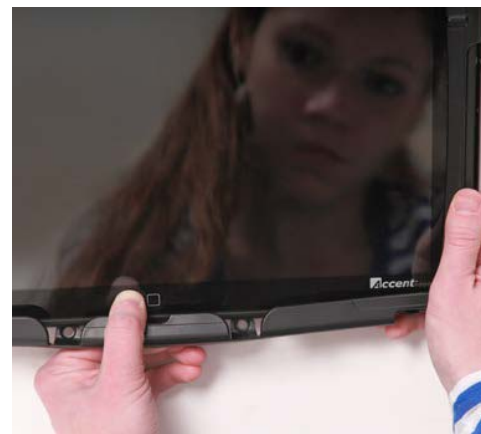

Attaching the Device Frame More Securely

When you initially attach the frame, the sides rest against the sides of the device loosely. When you insert a Keyguard into the frame, a user could pull hard on the Keyguard and pull it loose from the frame. To prevent this from happening, secure the sides of the frame by pressing hard on each side until it snaps into place.



The sides now fit tightly against the device, and the Keyguard cannot be pulled loose. Once you snap the sides of the frame into place, they are designed to hold securely.

For an Even More Secure Fit

If you do not expect to remove and reattach the frame to the device frequently, you may want to insert screws in the top and bottom holes of the frame. If you expect to remove and reattach the frame to the device frequently, you may not want to use the screws.

1. Place the device face down on a flat surface.
2. Insert the two small screws from the plastic bag through the holes in the top of the frame and into the corresponding holes in the top of the device.
3. Insert the two screws you removed earlier from the bottom of the device (*see page 18*) through the holes in the bottom of the frame and into the corresponding holes in the bottom of the device.
4. Tighten all four screws with a Phillips screwdriver.

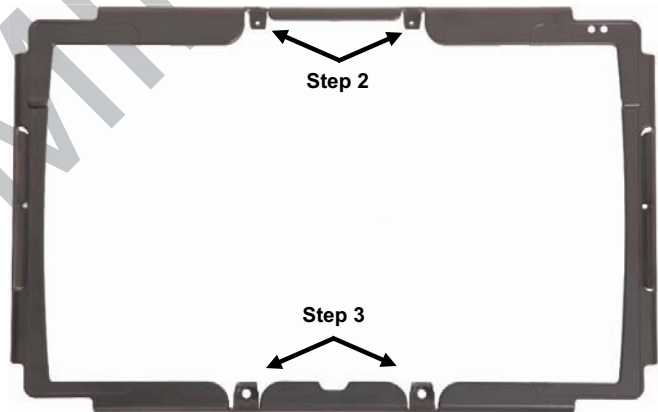

When the Device Frame is Attached Securely

After you attach the frame securely to the device, you can attach a Keyguard or TouchGuide to the frame. See “Attaching the Keyguard” on page 22 or “Attaching the TouchGuide” on page 24.

Replacing the Device Frame

If it becomes necessary to remove or replace the device frame, do the following:

1. If you are using a Keyguard or TouchGuide, remove it from the frame.*
2. If you secured the frame to the device with screws, remove the screws.
3. Pull the sides of the frame loose from the device. If you snapped the sides in place, you'll need to grip the sides and pull hard.
4. Snap the bottom of the frame loose from the device.



Hint: You may want to use a flat-head screwdriver or a similar tool.

5. Lift out the tabs at the top of the device and lift the frame off the device.
6. Attach the new frame.



See "Attaching the Device Frame" on page 19.

* See "Removing the Keyguard" on page 23 or "Removing the TouchGuide" on page 24.

Attaching, Raising, and Removing a Keyguard

Attaching the Keyguard

1. Attach the device frame, if you have not already done so. See “Attaching the Device Frame” on page 18.
2. Hold the Keyguard over the screen, with the pins toward the top of the screen and the tabs toward the bottom.

Important! Position the Keyguard so that the tabs are on the bottom. The tabs must be able to lie flat against the screen, allowing the Keyguard to snap into place.

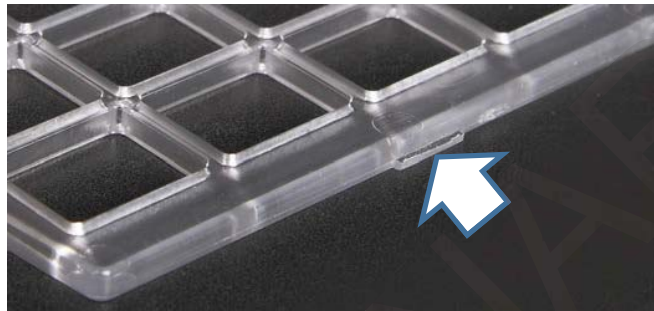

3. Insert one of the Keyguard pins into the opening near the top of the device frame.
4. While holding the pin in place, lift upward with your fingers to bend the middle of the Keyguard upward slightly. Then insert the other pin into the opening on the other side of the device frame.



5. Press down on the bottom portion of the Keyguard to snap the tabs into place.

Note: If the Keyguard tabs at the bottom do not snap into place, make sure that the Keyguard is not upside-down. (See step 1.)

Raising the Keyguard

If you need temporary access to the screen—for example, for programming, changing device settings, cleaning the screen, etc.—you can raise the Keyguard without removing it completely. If you want to remove the Keyguard from the device completely, see “Removing the Keyguard” below.

1. While holding the bottom edge of the device with one hand, use the thumb of your other hand to grasp the bottom edge of the Keyguard in the middle.
2. Pull upward to release the bottom tabs.
3. Leaving the pins inserted in the top of the device frame, simply lift the bottom of the Keyguard to uncover the screen. The Keyguard will remain the upright position, giving you easy access to the screen.



Removing the Keyguard

1. While holding the bottom edge of the device with one hand, use the thumb of your other hand to grasp the bottom edge of the Keyguard in the middle.
2. Pull upward to release the bottom tabs.
3. Lift upward with your fingers to bend the middle of the Keyguard upward slightly.



Bottom tabs already pulled loose from the device.

4. Pull the pins out of the openings at the top of the device frame.

Attaching or Removing a TouchGuide

Attaching the TouchGuide

1. Attach the device frame, if you have not already done so. See “Attaching the Device Frame” on page 18.
2. Align the TouchGuide so that the two squares at the top are positioned at the upper right corner of the display.
3. With the bottom tabs in place, lift upward with your fingers to bend the top right corner of the TouchGuide slightly and insert the tab into the top right slot of the frame.

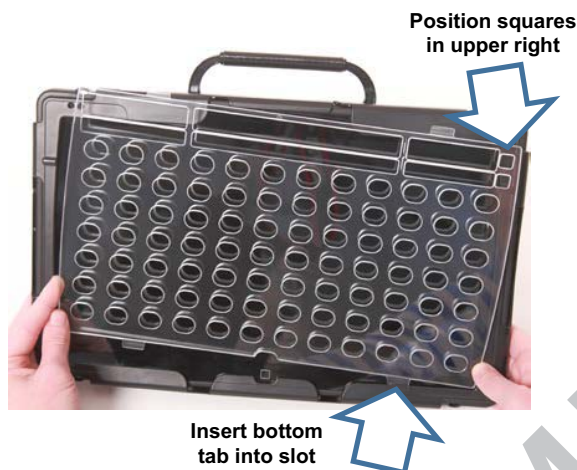

Then insert the bottom tabs of the TouchGuide into the slots at the bottom edge of the frame.

Note: The TouchGuide plastic is stiff and may require some effort to bend.

4. Insert the left tab into the top left slot of the frame using the same method as in step 3. The TouchGuide is now ready to use.

Removing the TouchGuide

Note: Avoid pulling on the thin pieces of plastic.

1. Grasp the thicker plastic above the first row of keyholes.
2. Pull out and down on the TouchGuide until the upper tabs pop out.

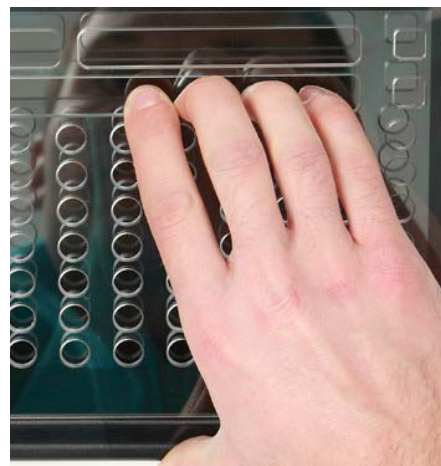

Grasp the thicker plastic

Attaching a Carry Strap

The carry strap connectors are located on the top and bottom of the device. At the end of each side of the strap there is loop connector and, on the strap side, a quick-release connector.

1. Decide whether to connect the carry strap to the top or bottom connectors on the device.
2. Detach the loop connector from the strap by pressing in on the sides of the quick-release connector.



3. Thread the loop through a strap connector on the device.
4. Thread the loop connector through the loop.



5. Pull the connector through until it is tied securely to the device.
6. Insert the loop connector into the strap connector until they click and hold together.



7. Repeat these steps to connect the other end of the strap to the device.

Installing a Wheelchair Mounting Plate

With the mounting plate in place, the device can be mounted on a table stand or a wheelchair mount.

If you purchased the wheelchair mounting plate, you received the mounting plate and four screws in a plastic bag.



Note: If you ordered a separate NuEye™ Tracking System, a different mounting plate will be needed. See “Mounting a NuEye Module” on page 27.

1. Place the device-face down on a flat surface. Be careful not to scratch the display.
2. Line up the holes on the mounting plate with the four holes on the device circled in white below.



3. Place the screws through the mounting plate into the device holes and tighten the screws.



Note: If you remove the mounting plate at any time, be sure to store the screws in a safe location. You may need them later.

 Loose screws can be a choking hazard.

Mounting a NuEye Module

If you purchased NuEye™ with your Accent 1000, the NuEye module is already mounted on the device. If you purchased NuEye later, follow these instructions to attach the module to the device.

Hint: You might find it easier to attach the module if you line up the bottom edge of the device with the edge of a table or counter.

1. Place the device-face down on a flat surface. Be careful not to scratch the display.
2. Line up the connector on the NuEye module with the NuEye USB connector on the bottom edge of the back of the device.



3. Slide the module into place, making sure the connectors are engaged completely.
4. Tighten the two screws to secure the module to the device.

Note: The screws are already in the screw holes. You only need to tighten them.

5. The NuEye module is ready to set up for use.

The *NuEye Tracking System User's Guide* contains detailed instructions on mounting the NuEye module, positioning the device, calibration, customizing settings, managing eyegaze profiles, and cleaning the module.



Connecting/Disconnecting a Freedom Switch®

In NuVoice, the Connect Freedom Switch key allows you to connect (pair) one or more Freedom Switches to NuVoice on a device. You can connect multiple switches. The Disconnect All Freedom Switch key allows you disconnect (unpair) **all** Freedom Switches previously connected.

You can also use Freedom Switch along with other access methods. For example, if you are using a headpointer or a joystick, you could connect a Freedom Switch to provide additional access.

To connect a Freedom Switch to NuVoice on a device:

1. In NuVoice, select **Access Method Menu**.
2. If switch scanning is not already selected, select **Choose Different Access Method**, select **1 Switch** or **2 Switch**, and select a specific switch scanning method.

Note: To use Freedom Switch with another access method, select **Headpointing/Joystick** and then **Joystick Auto Scan, Joystick Hold Scan, or Mouse/Trackball/USB Joystick**.

3. The Access Method Menu will show the access method you selected.
4. Turn on the Freedom Switch.
5. From the Access Method Menu, select **Connect Freedom Switch**. The following message will be displayed:

Freedom Switch is ON. Hit the switch to pair it with NuVoice.

6. **Within 10 seconds**, press the Freedom Switch.

Note: if you do not press the switch within 10 seconds of seeing the message, the switch will not connect to NuVoice.

7. For each additional switch you want to connect, repeat steps 4 through 6.

To disconnect all Freedom Switches from NuVoice on a device:

If you want to disconnect (unpair) **all** Freedom Switches from NuVoice on a device, select **Disconnect ALL Freedom Switch**.

Important! If multiple switches are connected, you cannot disconnect only one. Selecting the Disconnect ALL Freedom Switch key disconnects ALL previously connected switches.

Before You Plug In the Adapter

Notice that the wireless adapter has a PRC label on one side and a label with a white circle and an arrow pointing down on the other. The circle label covers a small switch called the "pair button".



You will need to press this white circle during the setup process. Depending on where the USB ports are on your computer, it may be difficult to reach the circle and also reach your device. You may want to ask someone to help you.

Setting up the Adapter

1. Plug the Bluetooth wireless adapter into the USB port on your computer. Remember where the white circle is on the adapter. The LED on the adapter may flash for a moment when you plug it in.
2. Make sure your device is turned on.
3. Select the **Tools** key on the front of the device or select the **Tools** key to the right of the text display area.
4. Select the **Toolbox** key.
5. In the Toolbox, select **Output Menu**.
6. Set Output to **On**.
7. Set Output Destination to **External**.
8. Set Output Method to **Bluetooth**.
9. You will see a yellow box telling you to press the Pair button on the adapter. Press the **white circle** label on the Bluetooth adapter.
10. The LED on the adapter will begin to blink. When you see a solid light, the adapter has paired with your device and computer. This can take up to 20-30 seconds. In the status box in the Output menu you will see "Paired, Connected".
11. Exit the Output menu.

Use the Connection

1. On your device, go to the spelling keyboard.
2. On your computer, open a Word document or other application that will accept typing.
3. Begin typing on your device's spelling keyboard. The information you type will appear on your computer screen. You can now print or distribute your document.

Notes

- Once the adapter is paired with your computer, it should always be paired. You can remove it from your computer. The next time you plug it in, the LED should light and it should be ready to go as long as the Output menu is set correctly.
- The Bluetooth adapter has a wide range. Your device and the adapter do not have to "see" each other to work.
- The **Paired Devices** option in the Output menu allows you to see and reconnect to any Bluetooth devices you have been paired with. **Disconnect** allows you to disconnect from your current Bluetooth device.

Setting Up Infrared (IR) for Remote Controls

IR capability is enabled automatically with the Accent. The IR area of your device is on the back of the case on each side of the headphone jack, near the top. When you are facing the front of the device, the **IR learning receiver** is on the top left and the **IR transmitter** is on the top right of the IR area.

You can teach infrared signals for almost any appliance you own that has a remote control. If you want to teach a remote control signal to your device, point your remote control at the IR area.

If you want to send an IR signal from your device, make sure the IR area is facing in the **general** direction of the appliance you want to send the signal to.

Use the IR Setup Menu in the NuVoice Toolbox to teach remote signals to your Accent. The following IR functions can be performed in NuVoice by using **IR Setup Menu** in the Toolbox:

- Add, modify, delete, or rename a device/appliance
- Add, change, delete, and test IR functions

Adding a Device

Several devices are already set up in the Accent. You only need to teach the signals to your device. To add additional devices, select **Add a Device** and follow the instructions on the display.

Modifying a Device

1. Use the Up/Down arrows to select the appropriate device. When the appropriate device is found, tap the button for the desired function and follow the instructions on the display.
2. Select **Modify Selected Device**.
3. Select the function to be changed and follow the instructions on the display.
4. When instructed, point the appliance's remote control at the top of the Accent and press the appropriate function button on the remote (for example, the power button).

Note: When teaching the device a new signal or re-learning a signal, make sure the remote is pointed directly at the IR learning receiver on the left side of the headphone jack.

5. The Accent will beep when it receives the signal.
6. Select **Test Signal** to confirm that the signal functions properly.

Note: The Re-Learn All Signals option allows each signal for an appliance to be re-learned without re-entering the menu each time.

Sending IR Signals to an Appliance

1. Make sure the IR area on the Accent is facing toward the appliance that will receive the signal.
2. Select the device remote from the vocabulary screen.
3. Select the desired function.

Setting Up a Wireless Internet Connection

You can set up your device for a wireless Internet connection. You must have access to a local Wi-Fi network. In the Accent, Wi-Fi and Bluetooth are always turned on.

Note: PRC is not responsible for the setup of your wireless network.

Hint: If you have a USB mouse, you can plug it into your device and use it to navigate through the setup process.

1. Turn your device on.
2. Select the **Tools** key on the front of the device or select the **Tools** key to the right of the text display area.
3. Select the **Toolbox** key from the Tools menu.
4. Select **Maint Menu** from the Toolbox.
5. Select **Hardware Diagnostics**.
6. Select **Network Setup**.
7. From the Network screen, select the **Connect or disconnect** link.

You will see a list of available networks to connect to and their signal strength. If you are at home, your home network should be visible. If you are at school or work, you will probably see more networks to choose from.

8. Select the network you want to connect to.



9. Select **Connect**.
10. Follow the directions on your display. You may need to enter a network key or password.
11. When you are connected, the Wi-Fi icon in the task bar changes to bright white.
12. Exit the menu and go to the Internet to test the connection.

Using the Cameras

The front camera is located in the center of the device at the top of the display.

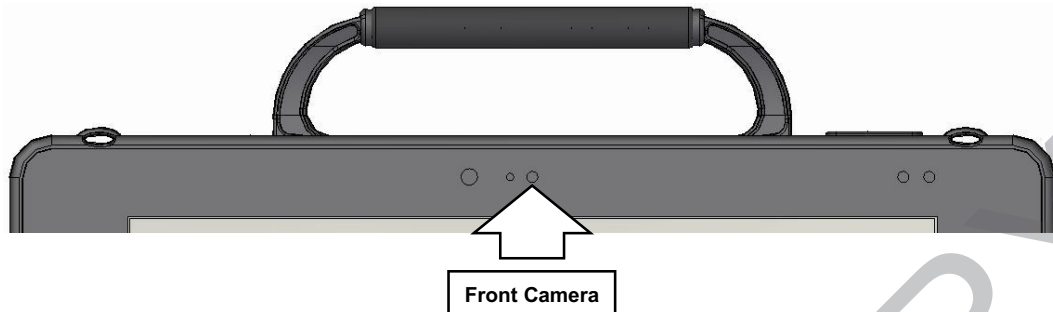

The rear camera is located on the upper right side on the back of the device.

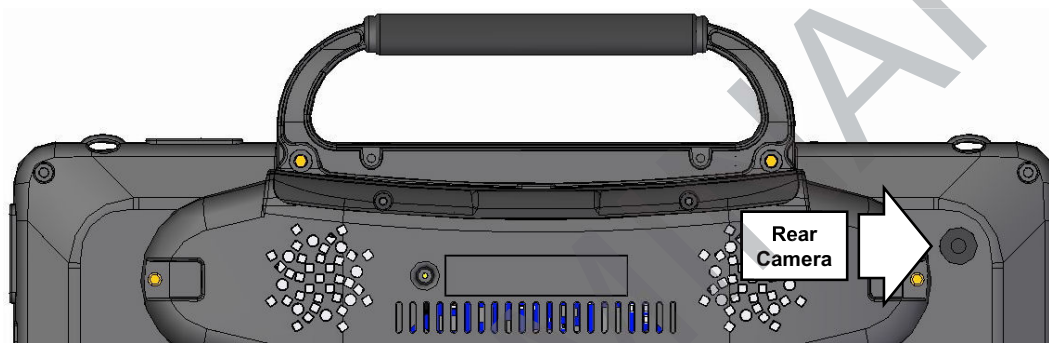

The NuVoice Toolbox contains a **Camera Menu**. Your vocabulary may also have a camera page or camera activity that contains the **Camera Menu**. The **Camera Menu** provides an option to zoom in or pan in any direction.

Hold a photograph 6-8 inches away from the lens and take a picture of the photo and use it as an icon or visual scene.

Camera applications such as Skype™, Windows Movie Maker, etc. can be used. Follow the directions provided with each specific camera application.

To switch between the front and rear cameras, select the **Change Camera** icon in the lower left corner of the **Camera** toolbar.

To Use the Cameras in NuVoice

1. Select the **Tools** key to the right of the text display area.
2. Open the **Toolbox**.
3. Select **Camera Menu**.
4. To switch between the front and rear cameras, select **Choose Camera**.
5. Select **Front Camera** or **Rear Camera**.

Managing Power Settings

To manage your device's power settings, go to the Toolbox, select **Maint Menu**, and select **Power Management**. The power management options are I/O Function, Shutdown, Restart, Auto Backlight Dim, and Auto Sleep.

Using the Maintenance Menu Power Options

I/O Function

The options are Sleep, Hibernate, Shutdown, and Disable. The options operate as follows when selected.

- Sleep** When Sleep is selected, your device will go to sleep when you press the power button. Press the button again to “wake” the device. In Sleep mode, the device uses only a small amount of battery energy and will come back up more quickly than after a shutdown. The device will also return you to where you were before it went to sleep. Select this mode if you won't be using the device for a relatively short amount of time (less than an hour, for example). Sleep is the default setting.
- Hibernate** When Hibernate is selected, your device will hibernate when you press the power button. Press the button again to “wake” the device. In Hibernate mode, the device virtually shuts down, thus saving even more battery energy than Sleep mode. The device will take longer to come back up than it would in Sleep mode, but it will come up faster than after a shutdown. The device will also return you to where you were before it went to sleep. Select this mode if you won't be using the device for a prolonged amount of time (more than a few hours, for example).
- Shutdown** When Shutdown is selected, your device will shut down completely when you press the power button. In this state, your device uses almost no battery energy. It also will take your device longer to come back up when you turn it back on.
- Disable** When you select Disable, the power button is disabled. If you select this option, once you turn your device on, it will not turn off again. This option does *not* save battery energy.

Shutdown

The Shutdown key allows you to completely shut down your device. For details on using this key, see “Performing a Full Shutdown” on page 35.

Restart

The Restart key provides a way to restart your device without having to go to the Windows Start menu. You should rarely need to use this key.

Auto Backlight Dim

Auto Backlight Dim will dim your backlight automatically after the amount of time you set passes. Setting a time will help conserve battery power.

Auto Sleep

Auto Sleep will put your device to sleep automatically after the amount of time you set passes. If you set Auto Sleep to **Off**, your device will never go to sleep.

Shutting Down the Accent using Windows

Selecting **Shutdown** from the **Power Off** menu in the **Charms** menu only puts the device into sleep mode. Waking the device from sleep mode will bring the device back up more quickly than after a full shutdown and will return you to where you were before the device went to sleep. The green power LED will blink while the device is in sleep mode.

1. Bring up the Windows Start screen.
2. Pull out the **Charms** menu from the right side of the display.
3. Select **Settings**.
4. Select the **Power** icon and **Shutdown**.

Remember: This does *not* perform a full shutdown.

Waking Up the Accent

1. Lightly press the power button.
2. The device will wake up and return to the Windows Start screen.
3. If NuVoice does not open on its own, open NuVoice by selecting the NuVoice tile on the Start screen. As an alternative, select the Accent screen and then select the NuVoice icon.

Performing a Full Shutdown

A full shutdown should be done at least once a **week**. Follow these steps to ensure a complete shutdown of the device.

1. In NuVoice, select the **Tools** key to open the Tools menu.
2. Open the **Toolbox**.
3. Select **Maint Menu**.
4. Select **Power Management**.
5. Select **Shutdown**.
6. A yellow prompt box asks "Are you sure?" Select **Yes**.

When the device has shut down, it will automatically return to NuVoice when powered on again.

Hint: You can set up a key in NuVoice to perform a complete shutdown by inserting the **Shutdown** tool.

Updating NuVoice

We recommend that you install NuVoice updates as soon as they are available.

Updating via the Internet

1. Plug in the battery charger.
2. Select the **Tools** key.
3. Select the **Toolbox**.
4. Select **Maint Menu**.
5. Select **Software Update Menu**.
6. Select **Internet Update**. A yellow dialog box will display an option to **update the software**. Select **Yes** and follow the instructions that appear on the display.

Updating via USB Flash Drive

1. Plug a USB flash drive into your computer.
2. Go to www.prentrom.com/downloads/updates
3. Find the latest Accent 1000 update and **download it to your computer desktop**.
Note: You can also download update instructions.
4. Copy the downloaded software update to your USB drive.
5. Remove the USB drive from your computer and plug it into one of the USB ports on your Accent.
6. Select the **Tools** icon.
7. Select the **Toolbox**.
8. Select **Maint Menu**.
9. Select **Software Update Menu**.
10. Select **USB Update**.
11. A yellow dialog box appears with an option to update the software. Select **Yes** and follow the instructions that appear on the display.

Storing Your Device

If you are not going to use the device for at least a month, store it in a dry place with moderate temperatures (not too cold or too hot).

1. Charge the battery to 100%.
2. When the battery is fully charged, go to the Toolbox and select **Maint Menu**.
3. Open the **Battery Menu**.
4. Select **Enter Ship Mode**.
5. Respond **Yes** to put your device into Ship Mode.
6. Select **OK** to exit the Battery Menu.
7. Select **OK** to exit the Maintenance Menu.
8. **Unplug** the battery charger.

When you are ready to use your device again:

1. Plug in the battery charger.
2. Press the power button on your device. Your device **will boot up**. Leave the charger plugged in until the battery is fully charged.

You can always check the status of the charge by looking at the bar graph next to the battery icon  in the status display area.

If the battery has gone completely dead: Plug in the battery charger. The charging LED on the front of the device will begin to flash rapidly, indicating the battery is charging. Leave the battery charger plugged in until the charging LED is **only flashing about once a second** which indicates the battery is fully charged. For additional information, see “Battery Troubleshooting” on page 41.

Disposing of the Device or Battery

Device Disposal

Please dispose of your device in accordance with your local, state, and/or federal electronic recycling laws.

Battery Disposal

If the battery in your device needs to be replaced, dispose of the old battery in accordance with your local, state, and/or country regulations.

PRELIMINARY

Cleaning and Disinfecting

If your device will only be used by one person, routine cleaning and disinfecting should be sufficient. If, however, more than one person will be using the device, take additional measures to clean and disinfect the device after it has been used by one person before allowing it to be used by another.

Routine Cleaning and Disinfecting

Important! Do not use solvents or abrasives or spray water or cleaner on the screen or case.

Cleaning the Case

Before cleaning the case or the display, turn the device off. Clean the case with a slightly dampened, lint-free cloth. Dry the case thoroughly with another lint-free cloth before turning the device on.

Cleaning the Touch Screen

The touch screen is very sensitive. Fingerprint smears, dust, grime, saliva, etc. will affect its performance. The screen also reacts to raindrops and extremes in temperature (condensation).

To dust the touch screen, use a soft, lint-free cloth. For heavier cleaning, use a slightly dampened, lint-free cloth and then dry the screen with another soft, lint-free cloth.

Cleaning Keypad Frames, Keypads, and TouchGuides

All of these accessories can be removed from the case and washed in hot, soapy water. Dry them **thoroughly** before putting them back on the device. The best practice for regular cleaning is to dry accessories by hand, lay them on a dry towel, and let them air dry for about 5 minutes before placing them back on the device.

Disinfecting

To disinfect everything but the display, use a solution of vinegar and water (¼ cup vinegar to 1 cup water). Wipe the case (not the display) using a cloth dampened with this solution.

Wash the Keypad frame, Keypad, and TouchGuide separately with the vinegar and water solution. Allow all equipment to air dry. **Do not use vinegar and water on the display!**

What about drooling/saliva?

Any saliva should be wiped up immediately, especially on the touch screen or around any of the connectors. Use a slightly dampened, lint-free cloth to wipe the device.

What about spills, rain, or accidental immersion?

If you spill liquid or any runny substance on your device; if you're caught in a downpour; or if the device is accidentally dropped in liquid, immediately dry the device as thoroughly as possible. Try using the device. If it does not work, call the PRC Service Department and tell them what happened. They may ask you to send in your device for servicing.

Disinfecting a Device and Accessories for Multiple Users

Important! This section applies only when more than one person will be using the same device. In that situation, it's vital to effectively disinfect the device and accessories that have been used by one person before allowing it to be used by another.

First Step: Put on protective gloves

Next Step: Clean the device and accessories

1. Wipe down the device and accessories with disinfectant wipes (Virucidal, Bactericidal, Pseudomonacidal, Tuberculocidal, Fungicidal)—Metrex CaviWipes™. Follow the disinfectant product manufacturer's instructions for *cleaning*.
2. Take a Q-tip with cleaner applied (for example, Windex® or another commercial cleaner) and clean inside all cracks and crevices. You may want to use a toothbrush or similar brush.
3. Blow the device off with an air hose, or wipe it dry.

Important! Make sure all soil is removed from the device and accessories. This is vital before proceeding to disinfecting the equipment.

Next Step: Disinfect the device and accessories

1. Wipe down the device and accessories with a new disinfectant wipe (Virucidal, Bactericidal, Pseudomonacidal, Tuberculocidal, Fungicidal)—Metrex CaviWipes. Follow the disinfectant product manufacturer's instructions for *disinfecting*.
2. Make sure to clean inside all cracks and corners, and wipe more than once if necessary to keep the device wet for a minimum of three (3) minutes.
3. Allow the device and accessories to dry.

Final Step: Wipe the touch screen

1. When the device and accessories are dry, wipe down the viewing area (device touch screen, TouchGuide, Keypad, etc.) with glass cleaner, so the screen doesn't discolor.
2. Allow the equipment to dry.

Troubleshooting

Battery Troubleshooting

⚠ There is a slight risk of explosion if you replace the battery with an incorrect type.

Call the PRC Service Department before replacing the battery: (800) 262-1990. Outside the United States, call your local distributor.

Use only the battery charger that came with the device. Other chargers may damage the battery in the device.

If the battery dies while the NuVoice software is running:

The battery charger LED and the charging LED on the front of the device will begin to alternate flashing. Plug in the battery charger to continue using the device. If you do not plug in the battery charger, NuVoice and/or the operating system will shut down, the LEDs will stop blinking, and the device will turn off.

To restart the device, plug in the battery charger, press and hold the **power button** for a few seconds, and watch the display screen. If the battery was completely dead, you may want to let it charge for awhile before you turn your device on.

General Troubleshooting

You select a key but get the wrong response

If you are selecting keys on the keyboard but not getting the correct responses, thoroughly clean the display screen as described in “Cleaning and Disinfecting” on page 39. Then try again.

High-Efficiency Fluorescent Lights and the Use of Infrared

There is often a compatibility problem between many infrared controls and high-efficiency fluorescent lights.

If the device is being used in a room that has high-efficiency fluorescent lighting, the infrared, including headpointing, computer access, remote control commands, etc., may not work. Turn the lights off and the IR will work correctly.

NuVoice Troubleshooting

If you are experiencing problems with the device operating system or the NuVoice software, it is important to read and follow these instructions.

For any internal system software troubleshooting, **always** plug in the battery charger first.

The Device Stops Speaking

1. In NuVoice, select the **Tools** icon and then select the **Toolbox** key.
2. Select **Maint Menu**.
3. Select **Power Management**.
4. Select **Shutdown**.
5. After the device has shut down, press the power button to restart the device.

The Device is Not Working Correctly or Freezes, but You Can Access NuVoice

Important! Do not use the power button.

1. In NuVoice, select the **Tools** icon and then select the **Toolbox** key.
2. Select **Maint Menu**.
3. Select **Power Management**.
4. Select **Restart**.

The NuVoice Toolbox is Not Responding or is Unavailable

1. Open the Windows **Start** menu.
2. Pull the Windows **Charms** menu from the right side of the display.
3. Tap the **Power** icon.
4. Select **Restart**. **Do not select Shutdown**.

If you have access to a USB keyboard:

1. Plug the keyboard into a USB port on the Accent.
2. Press **Ctrl-Alt-Del**.
3. If a blue screen appears with **Lock, Switch, Sign-out**, etc. on it, use the **Tab** key until it highlights the **I/O** option in the lower left corner.
4. Select **Enter**.
5. Select **Restart**.

As a Last Resort

Insert an unbent paper clip into the small hole in the power button until the device shuts down. Then press the power button to restart the device.

Important! This action may cause issues with the memory and performance of the device.

If the Device is Still not Working Correctly

If the device is still not working correctly, proceed to the next section, "Restoring Windows".

Restoring Windows

If you are having problems with Windows or the NuVoice software, and the suggestions under “NuVoice Troubleshooting” did not solve them, it is important that you read the following directions carefully.

In the event that the device's hard drive or the Windows operating system quits working, the Windows system software may need to be restored. As a rule, Windows will sense when something is wrong and repair itself or display an “Advanced Boot Options” screen with a list of options.

Important! The Restore process will **erase everything** on the device's hard drive. This includes Internet access, programs, hardware drivers, etc. Before restoring the device, call the PRC Service Department at (800) 262-1990. Outside the U.S., call your distributor.

The Restore process generally takes anywhere from 30 minutes to an hour. You need to be available when the restore is complete.

1. Plug in the battery charger.
2. Pull the Windows **Charms** menu from the right side of the display.
3. Select **Settings**.
4. Select **Change PC Settings** in the lower right corner of the menu.
5. Select **General** from the **PC Settings** menu on the right side of the screen.
6. On the right side of the screen, scroll down to **Remove everything and reinstall Windows**.
7. Select **Get Started**.
8. A blue screen appears explaining what will happen next. Select **Next**.
9. A blue screen appears with “Just remove my files” and “Fully clean the drive” on it. Select **Just remove my files**.
Note: The “Fully clean the drive” option may take 2.5 hours to complete and is not necessary.
10. Another blue screen appears stating that Windows is ready to reset the computer. Select **Reset** to continue or **Cancel** to stop the Restore process.

When the Restore is Complete

1. Follow the Windows Setup and Customizing instructions that appear on the screen.
2. When prompted, use **accent 1000** for a username or account name.
3. From the Windows **Start** screen, select the **Accent** icon to go directly to NuVoice or select the **Account tile** to go to the Accent screen. Then select the NuVoice icon in the upper right portion of the screen.
4. NuVoice will automatically install and generate the icon sets. This process will take several minutes.
5. When NuVoice is set up, the system will restart and open NuVoice automatically.
6. Select **I Agree** on the Software License Agreement.
7. NuVoice will open the Exploration Wizard.
8. To exit the Exploration Wizard, select the vocabulary you want to use.

If the Wizard does not show the vocabulary you want, open the Toolbox, select **User Area Menu**, select **Replace User Area**, and follow the directions displayed to select the vocabulary you want.

Activating Your Copy of Windows

Note: If you don't see "Activate Windows", Windows is already activated and you don't need to do anything.

"Activate Windows" is only visible if you had to restore your Windows operating system. In that case, if you do not activate your copy of Windows within 30 days, Windows will quit working and you will not be able to use your device until you restore or activate Windows. You can activate Windows by Internet or phone. If you use a phone, you must have a USB keyboard to plug into your device.

To begin:

1. Select the **Tools** key and open the **Toolbox**.
2. Select **Maint Menu**.
3. Select **Activate Windows**.

To activate Windows over the Internet:

1. After making sure your Internet connection is working, tap on the time/date area in the task bar at the top of your device screen.
2. In the menu that appears, make sure the date and time are **set correctly**. If they are not, set them to the correct date and time. Tap the menu (or the display) **to exit**.
3. Select **Activate** from the Windows Activation window.
4. When "Thanks, you're all finished" appears, select **OK**.

To activate Windows by phone:

If you want to use the phone to activate Windows, you must have a USB keyboard to plug into your device. You will need to speak into the phone and type onto the display screen.

1. Position your device near your phone.
2. Select **Activate by Phone** from the Windows Activation window.
3. Select your location.
4. Dial the number you see on the screen.
5. Listen to the introduction. Respond **Yes** to the "Activate Windows" question.
6. Recite the **blocks of numbers** you see on your display when you are asked. The voice on the phone will give you **blocks of numbers** in return.
7. Type these numbers into the blocks on your screen as you receive them.
8. Click on **Next** when asked.
9. Click on **Finish**.