



2.4 GHz Wireless Combo

RF-CMBO

User Guide



2.4 GHz Wireless Combo

Contents

Important safety instructions	3
Introduction	4
Features.....	4
Package contents	5
System requirements	5
Keyboard top	5
Keyboard status LED.....	7
Keyboard bottom	7
Mouse top	8
Mouse status LED	8
Mouse bottom.....	9
Setting up the keyboard and mouse.....	10
Installing keyboard batteries.....	10
Installing the mouse batteries	11
Setting up the keyboard and mouse.....	13



Using the combo driver	13
Installing the combo driver	14
Configuring the mouse	14
Uninstalling the combo driver.....	19
Maintaining	20
Troubleshooting	20
Specifications.....	20
Legal notices	22
One-year limited warranty.....	25

Important safety instructions

- 1 Read these instructions.
- 2 Keep these instructions.
- 3 Heed all warnings.
- 4 Follow all instructions.
- 5 Do not use this apparatus near water.
- 6 Clean only with dry cloth.
- 7 Do not install near any heat sources such as radiators, heat registers, stoves, or other apparatus (including amplifiers) that produce heat.
- 8 Only use attachments/accessories specified by the manufacturer.
- 9 To reduce the risk of fire or electric shock, do not expose this device to rain, moisture, dripping, or splashing, and no objects filled with liquids, such as vases, shall be placed on it.
- 10 Batteries should not be exposed to excessive heat such as sunshine, fire, or the like.

Caution: Danger of explosion if battery is incorrectly replaced. Replace only with the same or equivalent type.

Introduction

Congratulations on your purchase of a Rocketfish 2.4 GHz Wireless Combo.

This guide explains how to correctly operate and get the best performance from your wireless keyboard and mouse. Read this user guide carefully before using your product, then keep it next to your computer for quick reference.

Features

- **Keyboard**
 - 104-key design
 - Eighteen hotkeys
 - One connect button
 - Power switch
 - Soft palm rest
- **Laser mouse**
 - Tilt/ scroll wheel
 - Three mouse buttons
 - Two hotkey buttons
 - One pairing button
 - Power switch
 - Power saving mode
 - Working range up to 10 meters (line-of-sight)
 - Dual color status LED indicator

If any item is missing or damaged, contact Rocketfish at 1-800-620-2790.



Package contents

Before you start using your keyboard and mouse the first time, verify that your package contains the following:

- Keyboard
- Laser Mouse
- 2.4 GHz receiver
- Installation CD
- Batteries for the keyboard and mouse
- *Quick setup guide*







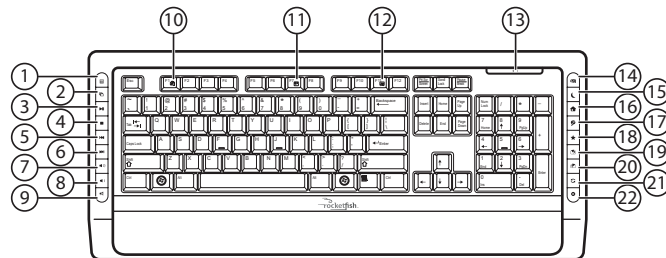











System requirements

- Computer with a USB port
- Microsoft Windows® XP Service Pack 3 or higher, Windows® Vista, Windows® 7

Keyboard top



#	Icon	Description
1		Calculator button. Press to open the calculator.
2		Application Switch button. Press to switch between open programs.
3		Play/Pause button. Press to start or pause CD or DVD playback.
4		Stop button. Press to stop CD or DVD playback.

#	Icon	Description
5		Previous track button. Press to go to the previous track on a CD or previous chapter on a DVD.
6		Next track button. Press to go to the next track on a CD or next chapter on a DVD.
7		Increase volume button. Press to increase the volume.
8		Decrease volume button. Press to decrease the volume.
9		Mute volume button. Press to mute the sound. Press again to unmute the sound.
10		Help button. Press to open online help for the currently active application.
11		Spelling button. Press to run the spell checker for the currently active program (if available).
12		Slideshow button. Press to enter slideshow mode in Windows Picture and Fax Viewer.
13		Status LED. For more information, see "Keyboard status LED" on page 7.
14		E-mail button. Press to open your e-mail program.
15		Sleep button. Press to put your computer in sleep mode. Press again to wake your computer.
16		Home button. Press to go to your home page in a Web browser.
17		Search button. Press to open the <i>Search</i> window.
18		My Favorite button. Press to open the list of your favorite Web sites.
19		Back Web page button. Press to go to the previous page in a Web browser.
20		Forward Web page button. Press to go to the next page in a Web browser.
21		Refresh Web page button. Press to refresh (reload) a page in a Web browser.
22		Stop Web page button. Press to stop loading a page in a Web browser.



Keyboard status LED

Color	Description
Green	The keyboard is turned on and the battery level normal.
Flashing red	The battery level is low.
Flashing red and green	The keyboard is pairing.

Keyboard bottom

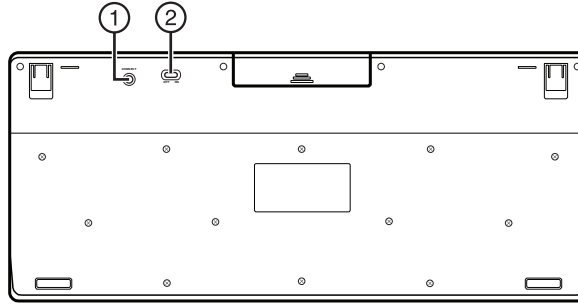

#	Item	Description
1	CONNECT button	Press to put the keyboard in pre-pairing mode.
2	OFF ON switch	Slide to turn the keyboard on or off.

Mouse top

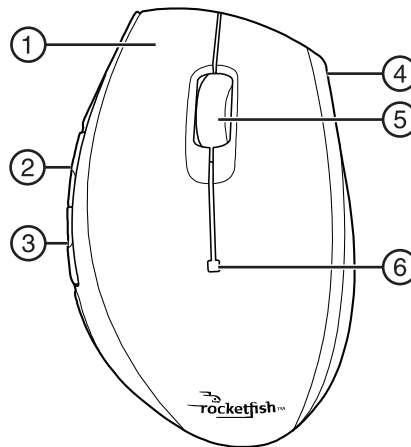

#	Item	Description
1	Left button	Press to perform left-button actions like selecting items or opening programs.
2	Forward button	Press to go to the next page in a Web browser.
3	Back button	Press to go to the previous page in a Web browser.
4	Right button	Press to perform standard right-mouse actions such as opening pop-up menus or viewing help information.
5	Tilt/scroll wheel	Roll to move the screen image up or down or tilt to move the screen left or right. If you press down on the scroll wheel, a four-way icon appears on the screen. Move the mouse up, down, left, or right to scroll.
6	LED indicator	Status LED. For more information, see "Mouse status LED" on page 8.

Mouse status LED

Color	Description
Green	The mouse is turned on and the battery level normal.
Flashing red	The battery level is low.
Flashing green	The mouse is pairing.



Mouse bottom

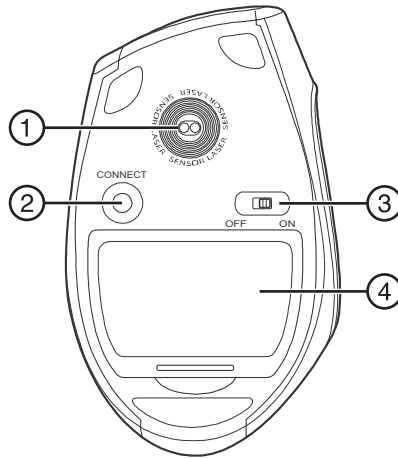

#	Item	Description
1	Laser sensor	Detects the mouse movements and sends signals to the computer to move the mouse pointer on the screen.
2	CONNECT button	Press to put the mouse in pre-pairing mode.
3	OFF ON switch	Slide to turn the mouse on or off.
4	Battery compartment	Provides storage for the batteries and receiver.

Setting up the keyboard and mouse

Installing keyboard batteries

To install keyboard batteries:

- 1 Remove the battery compartment cover.

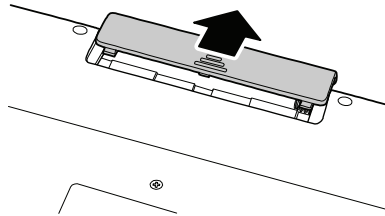

- 2 Insert two AA batteries into the battery compartment. Make sure that the + and – symbols on the batteries align with the + and – symbols in the battery compartment.

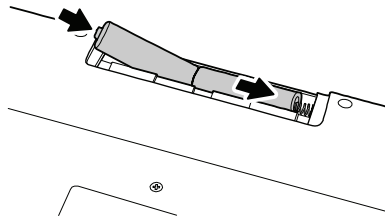

- 3 Replace the battery compartment cover.

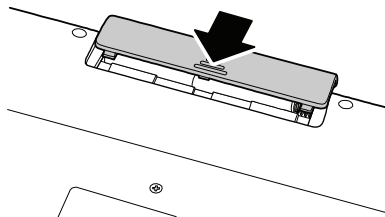



Installing the mouse batteries

To install mouse batteries:

- 1 Press the tab to release the battery compartment cover, then remove the cover.

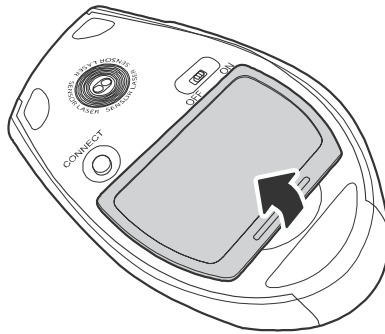

- 2 Pull the receiver out of the battery compartment.

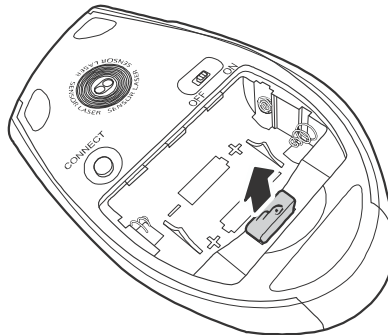

- 3 Insert two AA batteries into the battery compartment. Make sure that the + and – symbols on the batteries align with the + and – symbols in the battery compartment.

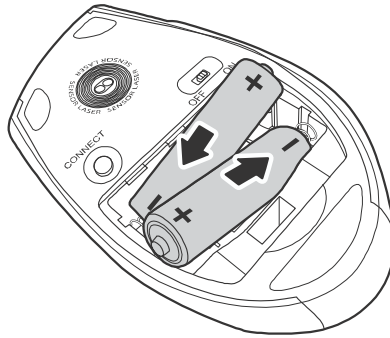

- 4 Replace the battery compartment cover.

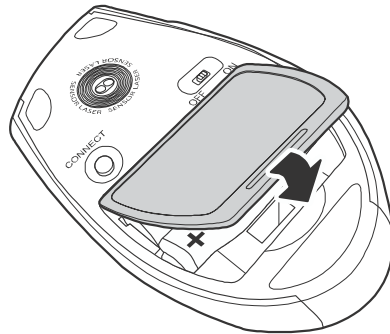



Setting up the keyboard and mouse

To set up the keyboard and mouse:

- 1 Plug the 2.4 GHz receiver into an available USB port on your computer.

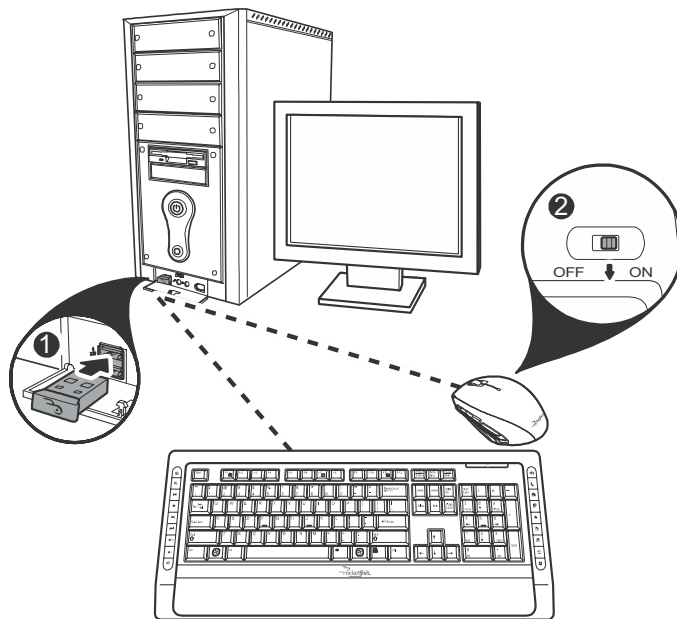

- 2 Slide the power switch of the mouse to **ON**, to turn the mouse on.
- 3 Slide the power switch of the keyboard to **ON**, to turn the keyboard on.
The computer recognizes the keyboard and mouse automatically.
The keyboard and mouse are ready to use.

Using the combo driver

To use advanced functions, such as tilt wheel driver, dynamic search and magnifier, you need to install the mouse driver and software.

Installing the combo driver

To install the combo driver:

- 1 Insert the installation CD (provided) in the CD drive on your computer. The installation program should start automatically. If it does not start automatically, open Windows Explorer, browse to the CD, then double-click **autorun.exe**. The Rocketfish Wireless combo screen opens.
- 2 Click **Install Combo Driver**. The Welcome screen opens.
- 3 Click **Next**. The Start installation screen opens.
- 4 Click **Next**. An installation progress bar appears.
When the installation is complete, the *Setup Complete* screen opens.
- 5 Click **Finish**.

Configuring the mouse

To configure the mouse:

- Double-click the mouse icon  on the system tray to open the mouse program, then click a tab to adjust a mouse function. You can select any of the following tabs:
 - **Buttons**—See “Configuring mouse buttons” on page 15.
 - **Double-Click**—See “Adjusting the double-click speed” on page 16.
 - **Orientation**—See “Adjusting the orientation” on page 16.
 - **Wheel**—See “Adjusting the wheel settings” on page 17.
 - **Pointer Utility**—See “Adjusting pointer behavior” on page 18.
 - **Mouse Suite**—See “Hiding the system tray’s mouse icon” on page 18.