



## 2.4 GHz Wireless Combo

**RF-RCMBO2**

**User Guide**



## 2.4 GHz Wireless Combo

### Contents

Important safety instructions .....	3
Introduction .....	4
Features.....	4
Package contents .....	5
System requirements .....	5
Keyboard top .....	5
Keyboard status LED.....	7
Keyboard bottom .....	7
Mouse top .....	8
Mouse status LED .....	8
Mouse bottom .....	9
Setting up the keyboard and mouse.....	10
Installing keyboard batteries.....	10
Installing the mouse batteries .....	11
Setting up the keyboard and mouse.....	13

Using the combo driver .....	14
Installing the combo driver .....	14
Configuring the mouse .....	14
Uninstalling the combo driver.....	19
Maintaining .....	20
Troubleshooting .....	20
Specifications.....	21
Legal notices .....	22
One-year limited warranty.....	25

## Important safety instructions

- 1 Read these instructions.
- 2 Keep these instructions.
- 3 Heed all warnings.
- 4 Follow all instructions.
- 5 Do not use this apparatus near water.
- 6 Clean only with dry cloth.
- 7 Do not install near any heat sources such as radiators, heat registers, stoves, or other apparatus (including amplifiers) that produce heat.
- 8 Only use attachments/accessories specified by the manufacturer.
- 9 To reduce the risk of fire or electric shock, do not expose this device to rain, moisture, dripping, or splashing, and no objects filled with liquids, such as vases, shall be placed on it.
- 10 Batteries should not be exposed to excessive heat such as sunshine, fire, or the like.

**Caution:** *Danger of explosion if battery is incorrectly replaced. Replace only with the same or equivalent type.*

# Introduction

Congratulations on your purchase of a Rocketfish 2.4 GHz Wireless Combo.

This guide explains how to correctly operate and get the best performance from your wireless keyboard and mouse. Read this user guide carefully before using your product, then keep it next to your computer for quick reference.

## Features

- **Keyboard**
  - 104-key design
  - Eighteen hotkeys
  - One connect button
  - Power switch
  - Soft palm rest
- **Laser mouse**
  - Tilt/ scroll wheel
  - Three mouse buttons
  - Two hotkey buttons
  - One pairing button
  - Power switch
  - Power saving mode
  - Working range up to 10 meters (line-of-sight)
  - Dual color status LED indicator

If any item is missing or damaged, contact Rocketfish at 1-800-620-2790.

## Package contents

Before you start using your keyboard and mouse the first time, verify that your package contains the following:

- Keyboard
- Laser Mouse
- 2.4 GHz receiver
- Installation CD
- Batteries for the keyboard and mouse
- *Quick setup guide*



## System requirements





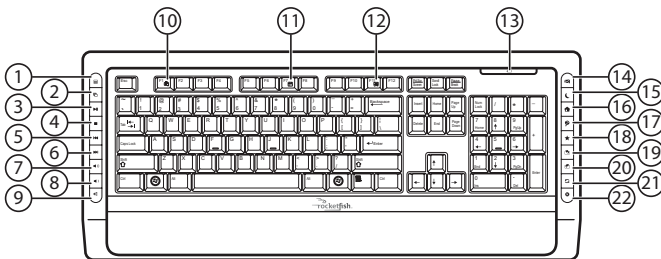













- Computer with a USB port
- Microsoft Windows® XP Service Pack 3 or higher, Windows® Vista, Windows® 7

**Note:** For optimal performance, we recommend that you place the dongle on the front of the computer.

## Keyboard top



#	Icon	Description
1		Calculator button. Press to open the open the calculator.
2		Application Switch button. Press to switch between open programs.
3		Play/Pause button. Press to start or pause CD or DVD playback.

#	Icon	Description
4		Stop button. Press to stop CD or DVD playback.
5		Previous track button. Press to go to the previous track on a CD or previous chapter on a DVD.
6		Next track button. Press to go to the next track on a CD or next chapter on a DVD.
7		Increase volume button. Press to increase the volume.
8		Decrease volume button. Press to decrease the volume.
9		Mute volume button. Press to mute the sound. Press again to unmute the sound.
10		Help button. Press to open online help for the currently active application.
11		Spelling button. Press to run the spell checker for the currently active program (if available).
12		Slideshow button. Press to enter slideshow mode in Windows Picture and Fax Viewer.
13		Status LED. For more information, see "Keyboard status LED" on page 7.
14		E-mail button. Press to open your e-mail program.
15		Sleep button. Press to put your computer in sleep mode. Press again to wake your computer.
16		Home button. Press to go to your home page in a Web browser.
17		Search button. Press to open the <i>Search</i> window.
18		My Favorite button. Press to open the list of your favorite Web sites.
19		Back Web page button. Press to go to the previous page in a Web browser.
20		Forward Web page button. Press to go to the next page in a Web browser.
21		Refresh Web page button. Press to refresh (reload) a page in a Web browser.
22		Stop Web page button. Press to stop loading a page in a Web browser.

## Keyboard status LED

Color	Description
Green	The keyboard is turned on and the battery level normal.
Flashing red	The battery level is low.
Flashing green	The keyboard is pairing.

## Keyboard bottom

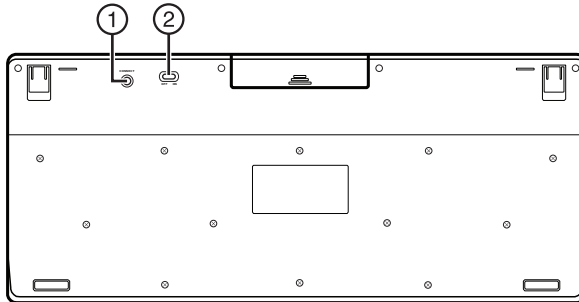

#	Item	Description
1	CONNECT button	Press to put the keyboard in pre-pairing mode.
2	OFF ON switch	Slide to turn the keyboard on or off.

## Mouse top

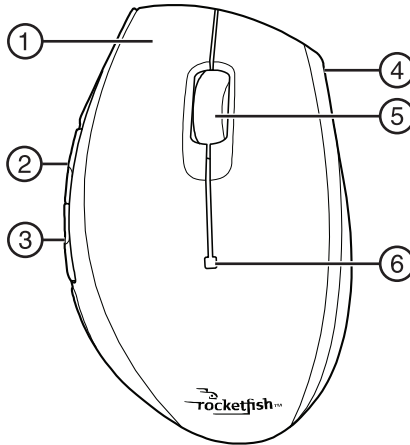

#	Item	Description
1	Left button	Press to perform left-button actions like selecting items or opening programs.
2	Forward button	Press to go to the next page in a Web browser.
3	Back button	Press to go to the previous page in a Web browser.
4	Right button	Press to perform standard right-mouse actions such as opening pop-up menus or viewing help information.
5	Tilt/scroll wheel	Roll to move the screen image up or down or tilt to move the screen left or right. If you press down on the scroll wheel, a four-way icon appears on the screen. Move the mouse up, down, left, or right to scroll.
6	LED indicator	Status LED. For more information, see "Mouse status LED" on page 8.

## Mouse status LED

Color	Description
Green	The mouse is turned on and the battery level normal.
Flashing red	The battery level is low.
Flashing green	The mouse is pairing.



## Mouse bottom

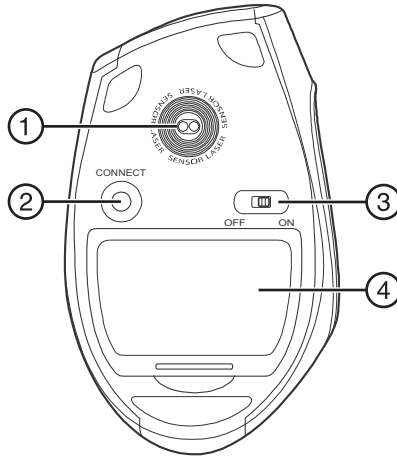

#	Item	Description
1	Laser sensor	Detects the mouse movements and sends signals to the computer to move the mouse pointer on the screen.
2	CONNECT button	Press to put the mouse in pre-pairing mode.
3	OFF ON switch	Slide to turn the mouse on or off.
4	Battery compartment	Provides storage for the batteries and receiver.

# Setting up the keyboard and mouse

## Installing keyboard batteries

*To install keyboard batteries:*

- 1 Remove the battery compartment cover.

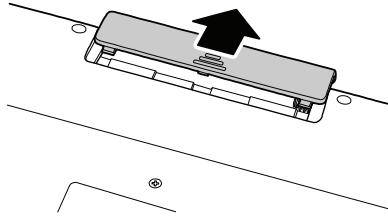

- 2 Insert two AA batteries into the battery compartment. Make sure that the + and – symbols on the batteries align with the + and – symbols in the battery compartment.

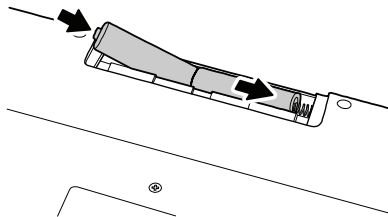

- 3 Replace the battery compartment cover.

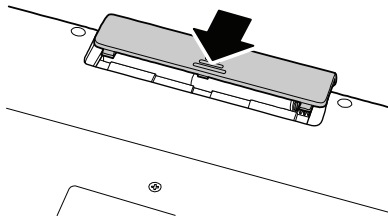

## Installing the mouse batteries

### *To install mouse batteries:*

- 1 Press the tab to release the battery compartment cover, then remove the cover.

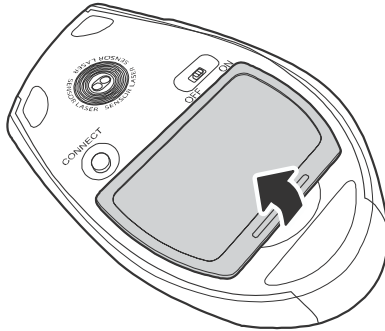

- 2 Insert two AA batteries into the battery compartment. Make sure that the + and - symbols on the batteries align with the + and - symbols in the battery compartment.

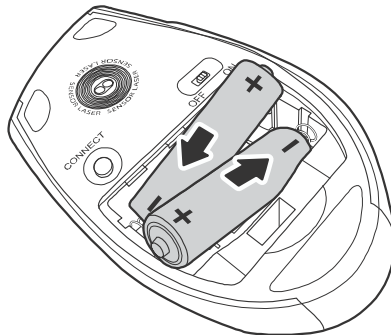

3 Replace the battery compartment cover.

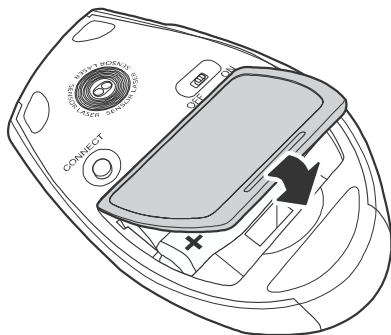

## Setting up the keyboard and mouse

### *To set up the keyboard and mouse:*

- 1 Plug the 2.4 GHz receiver into an available USB port on your computer.

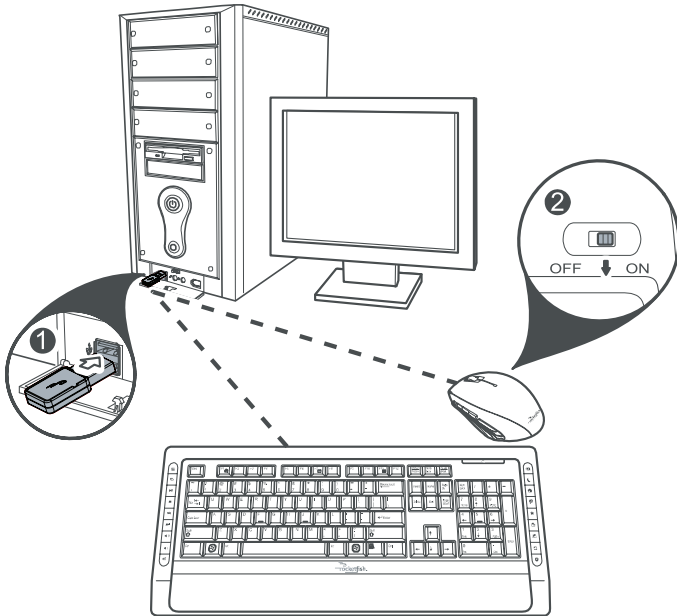

- 2 Slide the power switch of the mouse to **ON**, to turn the mouse on.
- 3 Slide the power switch of the keyboard to **ON**, to turn the keyboard on. The computer recognizes the keyboard and mouse automatically. The keyboard and mouse are ready to use.

# Using the combo driver

To use advanced functions, such as tilt wheel driver, dynamic search and magnifier, you need to install the mouse driver and software.

## Installing the combo driver

### *To install the combo driver:*

- 1 Insert the installation CD (provided) in the CD drive on your computer. The installation program should start automatically. If it does not start automatically, open Windows Explorer, browse to the CD, then double-click **autorun.exe**. The Rocketfish Wireless combo screen opens.
- 2 Click **Install Combo Driver**. The Welcome screen opens.
- 3 Click **Next**. The Start installation screen opens.
- 4 Click **Next**. An installation progress bar appears.  
When the installation is complete, the *Setup Complete* screen opens.
- 5 Click **Finish**.

## Configuring the mouse

### *To configure the mouse:*

- Double-click the mouse icon  on the system tray to open the mouse program, then click a tab to adjust a mouse function. You can select any of the following tabs:
  - **Buttons**—See “Configuring mouse buttons” on page 15.
  - **Double-Click**—See “Adjusting the double-click speed” on page 16.
  - **Orientation**—See “Adjusting the orientation” on page 16.
  - **Wheel**—See “Adjusting the wheel settings” on page 17.
  - **Pointer Utility**—See “Adjusting pointer behavior” on page 18.
  - **Mouse Suite**—See “Hiding the system tray’s mouse icon” on page 18.

## Configuring mouse buttons

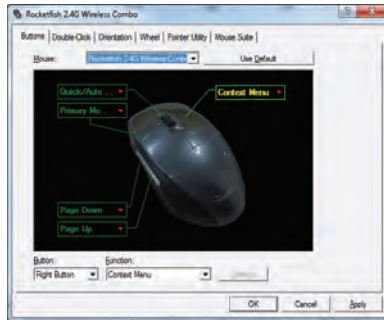

### *To configure the buttons:*

- 1 Click the **Button** list arrow to open the list of buttons, then click the button you want to configure.
- 2 Click the **Function** list arrow to open the list of functions, then click the function you want to assign to the button.
- 3 To restore default button functions, click **Use Default**. The default settings for the mouse buttons are:

Button	Function
Left button	Primary mouse button
Right button	Context menu
Wheel button	Quick/Auto scroll
Button A	Forward
Button B	Back

- 4 Click other tabs to make more adjustments, or click **OK** to save your selections and close the program.

## Adjusting the double-click speed



### *To adjust the double-click speed:*

- 1 To adjust double-click speed, drag the slider.
- 2 To test the click speed, double-click the **Test Area** icon.
- 3 To restore to default settings, click **Reset to Default Value**.
- 4 Click other tabs to make more adjustments, or click **OK** to save your selections and close the program.

## Adjusting the orientation

Use this tab to adjust the angle at which you use the mouse.

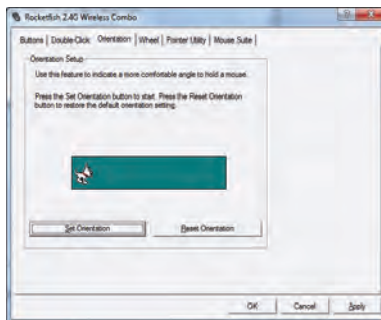

### *To adjust the orientation:*

- 1 Click **Set Orientation** to activate orientation setup, then use the on-screen pointer to follow the dog as it moves around.



- 2 To restore the default orientation settings, click **Reset Orientation**.
- 3 Click other tabs to make more adjustments, or click **OK** to save your selections and close the program.

## Adjusting the wheel settings

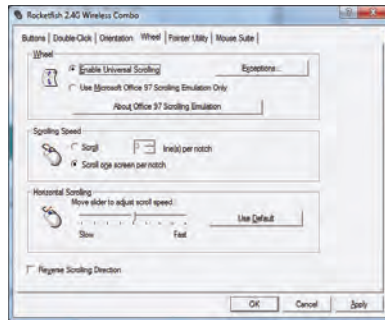

### *To adjust the wheel settings:*

- 1 To select the wheel scrolling method, click:
  - **Enable Universal Scrolling**—Uses common scrolling functions.
  - **Use Microsoft Office 97 Scrolling Emulation Only**—Uses Microsoft Office 97 scrolling emulation.
- 2 To specify scrolling exceptions, click **Exceptions**.
- 3 To adjust vertical scrolling speed, click:
  - **Scroll X line(s) per notch**—Selects the number of lines to scroll when the scroll wheel is moved one notch. Click the up or down arrow keys to specify the number of lines.
  - **Scroll one screen per notch**—Scrolls an entire screen when the scroll wheel is moved one notch.
- 4 To adjust the horizontal scrolling speed, drag the slider.
- 5 To restore to default scrolling speed, click **Use Default**.
- 6 To reverse scrolling direction, click **Reverse Scrolling Direction**.
- 7 Click other tabs to make more adjustments, or click **OK** to save your selections and close the program.

## Adjusting pointer behavior

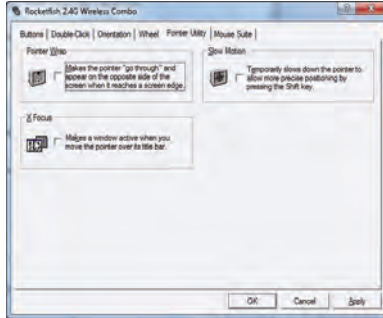

### *To adjust pointer behavior:*

- 1 Click the pointer options. You can select:
  - **Pointer Wrap**—The pointer goes to the opposite side of the screen when it reaches the screen edge.
  - **X Focus**—Activates a window when the pointer moves over the title bar.
  - **Slow Motion**—Slows down the pointer when the **Shift** key is pressed for a more precise positioning.
- 2 Click other tabs to make more adjustments, or click **OK** to save your selections and close the program.

## Hiding the system tray's mouse icon

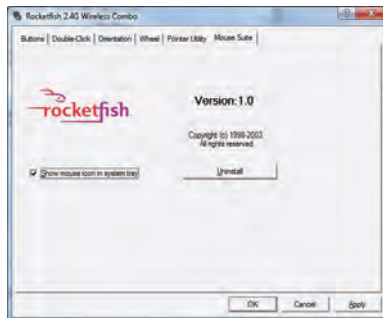

### To hide the system tray's mouse icon:

- Uncheck **Show mouse icon in systray**, then click **OK** to save changes and close application.

## Uninstalling the combo driver

### To uninstall the combo driver:

- 1 Click **Start, All Programs, Rocketfish 2.4G Wireless Combo**, then click **Uninstall Rocketfish 2.4G Wireless Combo Driver**. A message asks if you are sure you want to uninstall the driver.
- 2 Click **Yes** to continue. The *Remove Programs From Your Computer* screen opens and displays the progress.

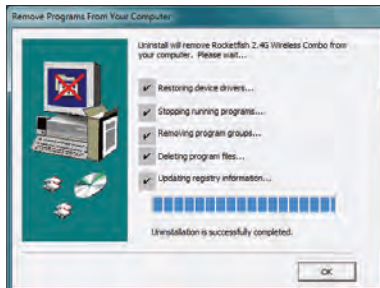

- 3 When the uninstallation is complete, click **OK** to continue. The *Uninstall Complete* screen opens.



- 4 Click **Finish**. Your computer restarts and the uninstallation is complete.

## Maintaining

To clean your keyboard and mouse, wipe them with a soft, lint-free cloth slightly moistened with water.

## Troubleshooting

If you have any problems with your 2.4 GHz keyboard or mouse, check the following:

- Make sure that your computer meets the system requirements.
- Make sure that the batteries in the keyboard and mouse are installed correctly. Make sure that the + and – symbols on the batteries align with the + and – symbols inside the keyboard and mouse battery compartments.
- When the mouse LED is red, battery power is low. Replace the batteries immediately.
- If your computer's BIOS setup has options for the keyboard or mouse, make sure that they are set to default settings. If you are not familiar with the BIOS, see your the documentation that came with your computer.
- Only use the mouse on a clean, flat surface in order to ensure smooth and accurate cursor movement. If you use a mousepad, choose a light-colored one, not a dark one, to use less battery power. Also, do not use the mouse on a reflective surface such as metal, glass, or polished wood.
- For further assistance with any other questions you may have, contact Rocketfish at 1-800-620-2790 for technical support.

## Specifications

	Mouse	Keyboard
<b>Dimensions H x L x W</b>	Mouse: 1.7 x 4.9 x 2.88 inches (43.28 x 124.57 x 73.2 mm) Dongle: 0.63 x 1.26 x 0.216 inches (16 x 32 x 5.5 mm)	1.14 x 19.8 x 8.35 inches (29 x 503 x 212 mm)
<b>Resolution</b>	1200 DPI @ 10 inch/sec	n/a
<b>Tracking speed</b>	Maximum 30 inch/sec (76.2 cm/sec)	n/a
<b>Weight</b>	Mouse (without battery): 3.17 oz. (90 g) Dongle: 0.09 oz. (2.5 g)	30.69 oz. (870 g) (without battery)
<b>Buttons</b>	5 buttons with tilt scroll wheel	104-key standard key with 18-multimedia hot keys
<b>Compatibility</b>	Windows XP Service Pack 3 Windows Vista 32-bit or 64-bit Windows 7 32-bit or 64-bit	
<b>Operating temperature</b>	32°F to 104°F (0°C to 40°C)	
<b>Storage temperature</b>	-40°F to 140°F (-40°C to 60°C)	
<b>Operating humidity</b>	90% RH or less	
<b>Storage humidity</b>	95% RH or less	
<b>Battery</b>	AA x 2	AA x 2
<b>Regulations and certifications</b>	EMI, ESD, RS, EFT, FCC, IC, WHQL	

# Legal notices

## **FCC Part 15**

This device complies with Part 15 of the FCC Rules. Operation of this product is subject to the following two conditions: (1) this device may not cause harmful interference, and (2) this device must accept any interference received, including interference that may cause undesired operation.

This equipment has been tested and found to comply within the limits for a class B digital device, pursuant to Part 15 of the FCC Rules. These limits are designed to provide reasonable protection against harmful interference in a residential installation. This equipment generates, uses, and can radiate radio frequency energy and, if not installed and used in accordance with the instructions, may cause harmful interference to radio communications. However, there is no guarantee that interference will not occur in a particular installation. If this equipment does cause harmful interference to radio or television reception, which can be determined by turning the equipment off and on, the user is encouraged to try to correct the interference by one or more of the following measures:

- Reorient or relocate the receiving antenna.
- Increase the separation between the equipment and receiver.
- Connect the equipment into an outlet on a circuit different from that to which the receiver is connected.
- Consult the dealer or an experienced radio/TV technician for help.

## **FCC warning**

Changes or modifications not expressly approved by the party responsible for compliance with the FCC Rules could void the user's authority to operate this equipment.



### **DHHS and FDA safety certification**

This product is made and tested to meet safety standards of the FCC, requirements and compliance with safety performance of the U.S. Department of Health and Human Services, and also with FDA Radiation Performance Standards 21 CFR Subchapter J.

### **Canada ICES-003 statement**

This Class B digital apparatus complies with Canadian ICES-003.  
Cet appareil numérique de la classe (B) est conforme à la norme NMB-003 du Canada."

### **RSS 210 statement**

Operation is subject to the following two conditions: 1) this device may not cause interference and 2) this device must accept any interference, including interference that may cause undesired operation of the device.

Ce dispositif est conforme à la norme CNR-210 d'Industrie Canada applicable aux appareils radio exempts de licence. Son fonctionnement est sujet aux deux conditions suivantes:  
(1) le dispositif ne doit pas produire de brouillage préjudiciable, et (2) ce dispositif doit accepter tout brouillage reçu, y compris un brouillage susceptible de provoquer un fonctionnement indésirable.





## One-year limited warranty

Rocketfish Products ("Rocketfish") warrants to you, the original purchaser of this new **RF-RCMBO2** ("Product"), that the Product shall be free of defects in the original manufacture of the material or workmanship for one (1) year from the purchase of the Product ("Warranty Period"). This Product must be purchased from an authorized dealer of Rocketfish brand products and packaged with this warranty statement. This warranty does not cover refurbished Product. If you notify Rocketfish during the Warranty Period of a defect covered by this warranty that requires service, terms of this warranty apply.

### How long does the coverage last?

The Warranty Period lasts for one year (365 days), beginning on the date you purchased the Product. The purchase date is printed on the receipt you received with the product.

### What does this warranty cover?

During the Warranty Period, if the original manufacture of the material or workmanship of the Product is determined to be defective by an authorized Rocketfish repair center or store personnel, Rocketfish will (at its sole option): (1) repair the Product with new or rebuilt parts; or (2) replace the Product at no charge with new or rebuilt comparable products or parts. Products and parts replaced under this warranty become the property of Rocketfish and are not returned to you. If service of Products and parts are required after the Warranty Period expires, you must pay all labor and parts charges. This warranty lasts as long as you own your Rocketfish Product during the Warranty Period. Warranty coverage terminates if you sell or otherwise transfer the Product.

### How to obtain warranty service?

If you purchased the Product at a retail store location, take your original receipt and the Product to the store you purchased it from. Make sure that you place the Product in its original packaging or packaging that provides the same amount of protection as the original packaging. If you purchased the Product from an online web site, mail your original receipt and the Product to the address listed on the web site. Make sure that you put the Product in its original packaging or packaging that provides the same amount of protection as the original packaging.

### Where is the warranty valid?

This warranty is valid only to the original purchaser of the Product in the United States, Canada, and Mexico.

### What does the warranty not cover?

This warranty does not cover:

- Customer instruction
- Installation
- Set up adjustments
- Cosmetic damage

- Damage due to acts of God, such as lightning strikes
- Accident
- Misuse
- Abuse
- Negligence
- Commercial use
- Modification of any part of the Product, including the antenna

This warranty also does not cover:

- Damage due to incorrect operation or maintenance
- Connection to an incorrect voltage supply
- Attempted repair by anyone other than a facility authorized by Rocketfish to service the Product
- Products sold as is or with all faults
- Consumables, such as fuses or batteries
- Products where the factory applied serial number has been altered or removed

REPAIR REPLACEMENT AS PROVIDED UNDER THIS WARRANTY IS YOUR EXCLUSIVE REMEDY. ROCKETFISH SHALL NOT BE LIABLE FOR ANY INCIDENTAL OR CONSEQUENTIAL DAMAGES FOR THE BREACH OF ANY EXPRESS OR IMPLIED WARRANTY ON THIS PRODUCT, INCLUDING, BUT NOT LIMITED TO, LOST DATA, LOSS OF USE OF YOUR PRODUCT, LOST BUSINESS OR LOST PROFITS. ROCKETFISH PRODUCTS MAKES NO OTHER EXPRESS WARRANTIES WITH RESPECT TO THE PRODUCT, ALL EXPRESS AND IMPLIED WARRANTIES FOR THE PRODUCT, INCLUDING, BUT NOT LIMITED TO, ANY IMPLIED WARRANTIES OF AND CONDITIONS OF MERCHANTABILITY AND FITNESS FOR A PARTICULAR PURPOSE, ARE LIMITED IN DURATION TO THE WARRANTY PERIOD SET FORTH ABOVE AND NO WARRANTIES, WHETHER EXPRESS OR IMPLIED, WILL APPLY AFTER THE WARRANTY PERIOD. SOME STATES, PROVINCES AND JURISDICTIONS DO NOT ALLOW LIMITATIONS ON HOW LONG AN IMPLIED WARRANTY LASTS, SO THE ABOVE LIMITATION MAY NOT APPLY TO YOU. THIS WARRANTY GIVES YOU SPECIFIC LEGAL RIGHTS, AND YOU MAY ALSO HAVE OTHER RIGHTS, WHICH VARY FROM STATE TO STATE OR PROVINCE TO PROVINCE.

Contact Rocketfish:

For customer service please call 1-800-620-2790  
[www.rocketfishproducts.com](http://www.rocketfishproducts.com)

Distributed by Best Buy Purchasing, LLC

7601 Penn Avenue South, Richfield, Minnesota, U.S.A. 55423-3645

© 2010 BBY Solutions, Inc.

All rights reserved. ROCKETFISH is a trademark of BBY Solutions, Inc. Registered in some countries. All other products and brand names are trademarks of their respective owners.



[www.rocketfishproducts.com](http://www.rocketfishproducts.com) (800) 620-2790  
Distributed by Best Buy Purchasing, LLC  
7601 Penn Avenue South, Richfield, MN 55423-3645 USA  
© 2010 BBY Solutions, Inc.

All rights reserved. ROCKETFISH is a trademark of BBY Solutions, Inc.  
All other products and brand names are trademarks of their respective owners.

10-1280  
ENGLISH