



Bluetooth Combo

RF-BTCMB02

User Guide



Bluetooth Combo

Contents

Important safety instructions	3
Introduction	4
Features.....	4
Package contents	5
System requirements	5
Keyboard top	6
Keyboard status LED.....	7
Keyboard bottom	8
Mouse top	9
Mouse status LED	10
Mouse bottom	10
Setting up the keyboard and mouse.....	11
Installing keyboard batteries.....	11
Installing the mouse batteries	12
Pairing the keyboard and mouse.....	14

Installing and using software.....	18
Installing the software.....	18
Using the Bluetooth stack for the first time in Windows XP.....	19
Using the keyboard and mouse.....	23
Checking battery status.....	23
Changing the low battery alarm settings...	25
Adjusting the tilt/scroll wheel	26
Maintaining	28
Troubleshooting	28
Specifications.....	29
Legal notices	30
One-year limited warranty.....	33

Important safety instructions

- 1 Read these instructions.
- 2 Keep these instructions.
- 3 Heed all warnings.
- 4 Follow all instructions.
- 5 Do not use this apparatus near water.
- 6 Clean only with dry cloth.
- 7 Do not install near any heat sources such as radiators, heat registers, stoves, or other apparatus (including amplifiers) that produce heat.
- 8 Only use attachments/accessories specified by the manufacturer.

- 9 To reduce the risk of fire or electric shock, do not expose this device to rain, moisture, dripping, or splashing, and no objects filled with liquids, such as vases, shall be placed on it.
- 10 Batteries should not be exposed to excessive heat such as sunshine, fire, or the like.
Caution: *Danger of explosion if battery is incorrectly replaced. Replace only with the same or equivalent type.*

Introduction

Congratulations on your purchase of the RF-BTCMBO2 Bluetooth keyboard and mouse. This keyboard and mouse represent the state of the art in Bluetooth keyboard and mouse design and are designed for reliable and trouble-free performance.

Features

- Power-saving mode
- Working range up to 33 feet (10 meters) (line-of-sight)
- Dual-color status LED indicator

Keyboard

- 104-key design
- Eighteen hotkeys
- One connect button
- Power switch

Mouse

- Tilt/scroll wheel
- Three mouse buttons
- Two hotkey buttons
- One pairing button
- Power switch

USB Bluetooth receiver

- Bluetooth specification v1.0, v2.0, and v2.1 compliant
- Supports both keyboard and mouse
- Supports additional Bluetooth devices

Package contents

- Keyboard
- Laser mouse
- USB Bluetooth receiver (inside the mouse battery compartment)
- Installation CD including software and *User Guide*
- Batteries for the keyboard and mouse
- *Quick Setup Guide*

System requirements







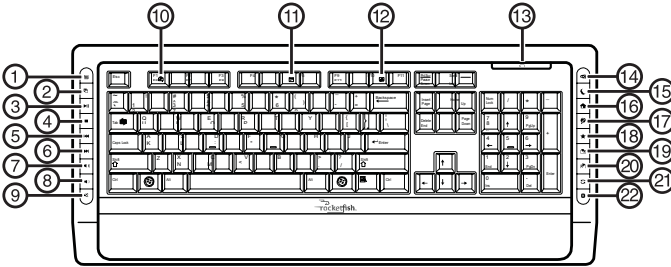



- Computer with a USB port
- Microsoft Windows® 7, Windows Vista®, Windows® XP with Service Pack 3 or higher

Keyboard top

Note: To use the keyboard hotkeys, you must install the WIDCOMM Bluetooth stack. See “Installing the software” on page 18.



#	Icon	Description
1		Gadget button (Windows Vista and Windows7) or Calculator button (Windows XP). Press to open the Gadget interface in Windows Vista or Windows 7 or press to open the Calculator in Windows XP.
2		Flip 3D button (Windows Vista and Windows 7) or Application Switch button (Windows XP). Press to switch between open programs.
3		Play/Pause button. Press to start or pause CD or DVD playback.
4		Stop button. Press to stop CD or DVD playback.
5		Next track button. Press to go to the next track on a CD or next chapter on a DVD.
6		Previous track button. Press to go to the previous track on a CD or previous chapter on a DVD.
7		Increase volume button. Press to increase the volume.
8		Decrease volume button. Press to decrease the volume.
9		Mute volume button. Press to mute the sound. Press again to unmute the sound.
10		Help button. Press to open online help for the currently active application.
11		Spelling button. Press to run the spell checker for the currently active program (if available).
12		Slideshow button. Press to enter slideshow mode in Windows Picture and Fax Viewer.

#	Icon	Description
13		Status LED. For more information, see "Keyboard status LED" on page 7.
14		E-mail button. Press to open your e-mail program.
15		Sleep button. Press to put your computer in sleep mode. Press again to wake your computer.
16		Home button. Press to go to your home page in a Web browser.
17		Search button. Press to open the <i>Search</i> window.
18		My Favorite button. Press to open the list of your favorite Web sites.
19		Back Web page button. Press to go to the previous page in a Web browser.
20		Forward Web page button. Press to go to the next page in a Web browser.
21		Refresh Web page button. Press to refresh (reload) a page in a Web browser.
22		Stop Web page button. Press to stop loading a page in a Web browser.

Keyboard status LED

Color	Description
Green	The keyboard is turned on and the battery level normal.
Flashing red	The battery level is low.
Flashing red and green	The keyboard is pairing.

Keyboard bottom

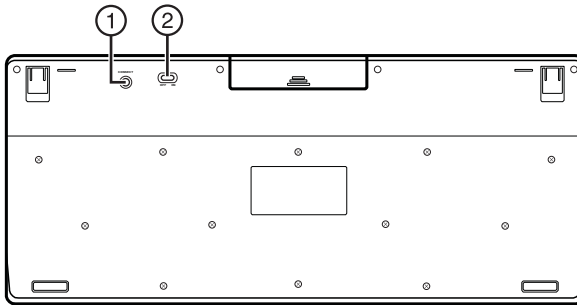

#	Item	Description
1	CONNECT button	Press to put the keyboard in pre-pairing mode.
2	OFF ON switch	Slide to turn the keyboard on or off.

Mouse top

Note: To use the mouse hotkey buttons, you must install the WIDCOMM Bluetooth stack. See “Installing the software” on page 18.

To use horizontal scrolling, you must install the Bluetooth mouse software. See “Installing the software” on page 18.

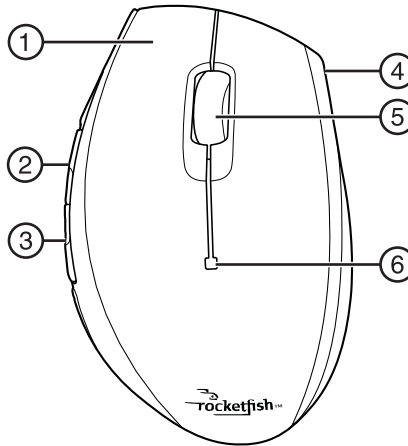

#	Item	Description
1	Left button	Press to perform left-button actions like selecting items or opening programs.
2	Forward button	Press to go to the next page in a Web browser.
3	Back button	Press to go to the previous page in a Web browser.
4	Right button	Press to perform standard right-mouse actions such as opening pop-up menus or viewing help information.
5	Tilt/scroll wheel	Roll to move the screen image up or down or tilt to move the screen left or right. If you press down on the scroll wheel, a four-way icon appears on the screen. Move the mouse up, down, left, or right to scroll.
6	LED indicator	Status LED. For more information, see “Mouse status LED” on page 10.

Mouse status LED

Color	Description
Green	The mouse is turned on and the battery level normal.
Flashing red	The battery level is low.
Flashing green	The mouse is pairing.

Mouse bottom

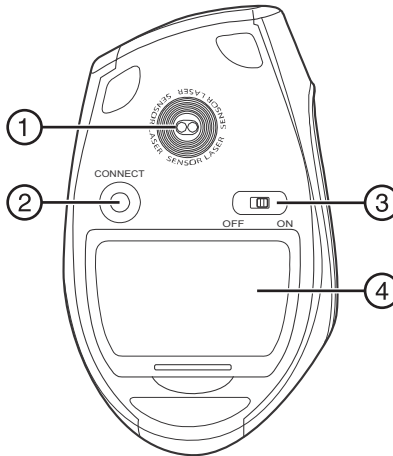

#	Item	Description
1	Laser sensor	Detects the mouse movements and sends signals to the computer to move the mouse pointer on the screen.
2	CONNECT button	Press to put the mouse in pre-pairing mode.
3	OFF ON switch	Slide to turn the mouse on or off.
4	Battery compartment	Provides storage for the batteries and receiver.

Setting up the keyboard and mouse

Installing keyboard batteries

To install keyboard batteries:

- 1 Remove the battery compartment cover.

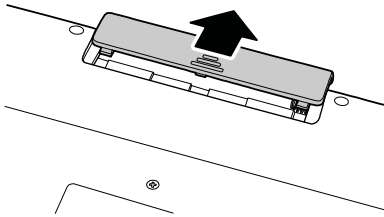

- 2 Insert two AA batteries into the battery compartment. Make sure that the + and - symbols on the batteries align with the + and - symbols in the battery compartment.

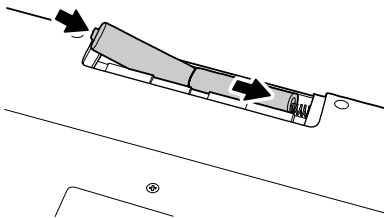

- 3 Replace the battery compartment cover.

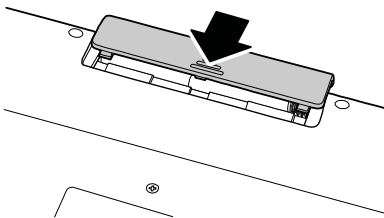

Installing the mouse batteries

To install mouse batteries:

- 1 Press the tab to release the battery compartment cover, then remove the cover.

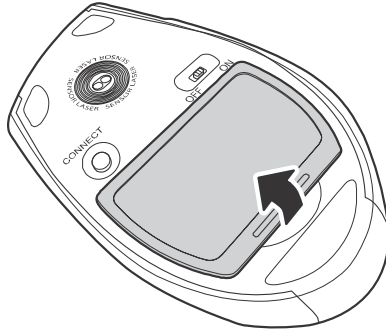

- 2 Pull the receiver out of the battery compartment.

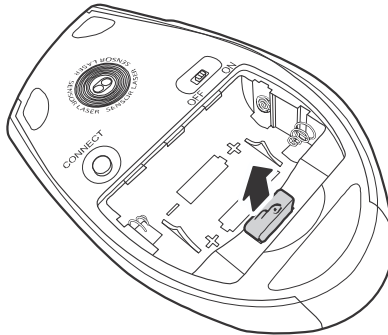

- 3 Insert two AA batteries into the battery compartment. Make sure that the + and - symbols on the batteries align with the + and - symbols in the battery compartment.

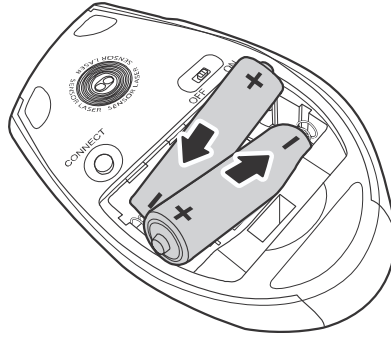

- 4 Replace the battery compartment cover.

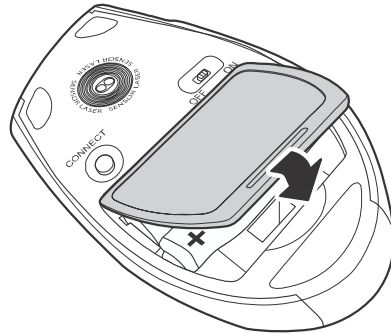

Pairing the keyboard and mouse

There are three methods for pairing the keyboard and mouse:

- “Automatic pairing in boot mode” on page 14.
- “Pairing by using the WIDCOMM Bluetooth stack” on page 15

Automatic pairing in boot mode

To pair automatically in boot mode:

- 1 With your computer turned off, plug the USB Bluetooth receiver into an available USB port.

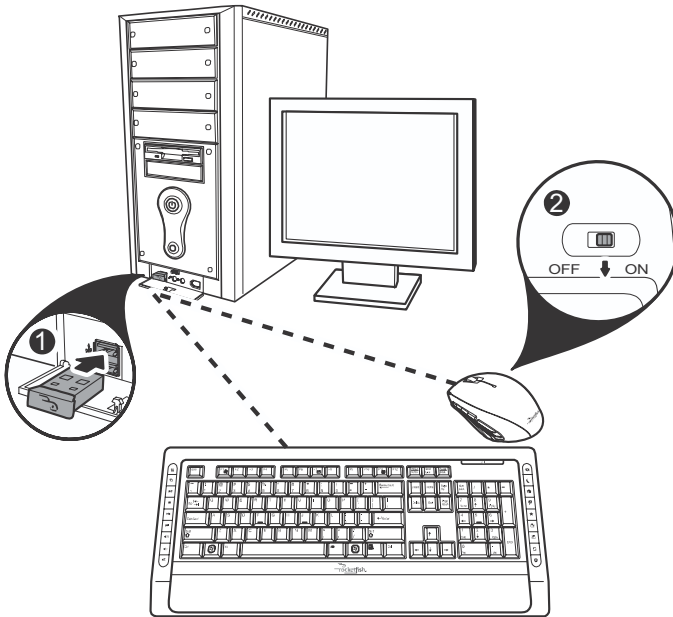

- 2 Slide the power switch of the mouse to turn the mouse on.
- 3 Turn on the computer and use the keyboard to enter the BIOS setup.
- 4 Use the keyboard and mouse to view the menu and configure the settings.

Turning on the USB keyboard and mouse settings in BIOS

If pairing in boot mode did not work, you may need to turn on the USB keyboard and mouse settings in the BIOS.

To turn on the USB keyboard and mouse settings in BIOS:

- 1 Make sure that the Bluetooth connection has been established before turning on your computer.

Note: If the keyboard did not automatically connect, you need to use a different keyboard for this task.

- 2 Turn on your computer, then follow the on-screen instructions to enter the BIOS Setup utility.
- 3 Use the cursor keys on the keyboard to navigate through the menu items and enable the USB keyboard and mouse. (In some BIOS settings, you can use the Bluetooth mouse to navigate through the items.)

Note: Some older computers do not support the USB keyboard and mouse in BIOS or a DOS environment.

Pairing by using the WIDCOMM Bluetooth stack

Before using the Bluetooth stack for keyboard and mouse pairing, make sure of the following:

- The WIDCOMM Bluetooth stack is installed and set up. See "Installing the software" on page 18.
- The batteries are inserted properly and fully charged.
- The USB Bluetooth receiver is plugged into a USB port on your computer.
- The mouse is turned on.

Note: To start the Bluetooth stack for the first time, see "Using the Bluetooth stack for the first time in Windows XP" on page 19.

To pair using the Bluetooth stack:

- 1 Press the **CONNECT** buttons on the mouse and keyboard to start pairing. Your computer starts to search for all Bluetooth devices.



When the mouse is connected, the *Confirmation Required* message appears.



- 2 Click to confirm that the mouse is connected. When the keyboard is connected, the *Bluetooth Security Setup* dialog box appears.

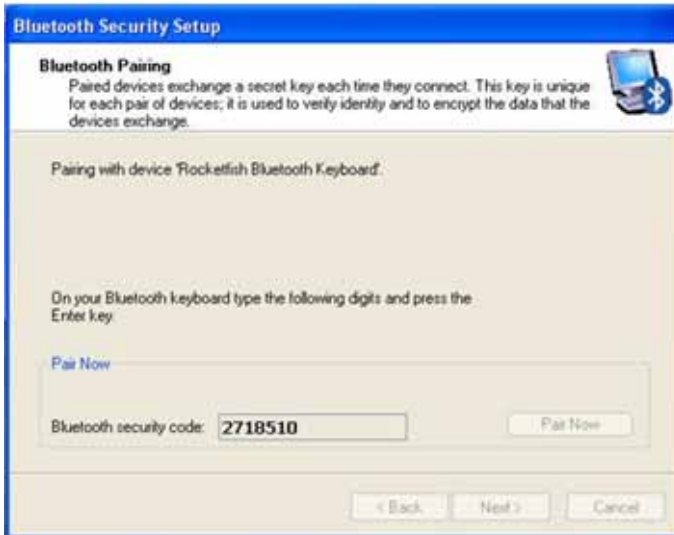

- 3 Use the paired keyboard to type the digits shown on the screen, then press **Enter**. The keyboard is connected.
Note: The keyboard and mouse enter the power saving mode when not used for a period of time.

Installing and using software

Installing the software

To use the keyboard and mouse hotkey buttons, you must install the software on the included CD.

To install the software:

- 1 Plug the USB Bluetooth receiver into a USB port on your computer.
- 2 Insert the **included** CD in the disc drive. The introductory screen appears automatically. If the screen does not appear automatically, double-click the `autorun.exe` file on the CD.
- 3 Click **Install Driver**. The *Welcome* screen appears.
- 4 Follow the on-screen instructions to complete the software installation.
*Note: If the "Bluetooth device not found" message appears, plug the USB Bluetooth receiver into a USB port on your computer, then click **OK**. The Found New Hardware Wizard starts installing the software.*
- 5 When the installation is complete, click **Finish**.

To uninstall the Bluetooth stack:

- 1 Remove the USB Bluetooth receiver.
- 2 In Windows Vista or Windows 7, click **Start, Control Panel**, then click **Programs and Features**.
Or
In Windows XP, click **Start, Settings, Control Panel**, then click **Add/Remove Programs**.
- 3 Click **WIDCOMM Bluetooth Software** in the program list, then click **Uninstall** (Windows Vista or Windows 7) or **Remove** (Windows XP). A confirmation message appears.
- 4 Click **Yes** to uninstall or **No** to cancel. When the program has been removed, a prompt tells you to restart the computer.
- 5 Click **Yes** to restart your computer now or **No** to restart later.

To uninstall the Rocketfish Bluetooth Combo software:

- 1 Remove the USB Bluetooth receiver.
- 2 In Windows Vista or Windows 7, click **Start, Control Panel**, then click **Programs and Features**.
Or
In Windows XP, click **Start, Settings, Control Panel**, then click **Add/Remove Programs**.
- 3 Click **Rocketfish Bluetooth Combo** in the program list, then click **Uninstall** (Windows Vista or Windows 7) or **Remove** (Windows XP). A confirmation message appears.
- 4 Click **Yes** to uninstall or **No** to cancel.

Using the Bluetooth stack for the first time in Windows XP

To use the Bluetooth stack for the first time in Windows XP:

- 1 Double-click the Bluetooth  icon in the system tray. The Initial Bluetooth Configuration Wizard opens.

- 2 Follow the on-screen instructions to complete the configuration. When the Bluetooth configuration is complete, the *Bluetooth Device Selection* dialog box appears and the computer starts searching for Bluetooth devices.



- 3 Click on the device you want to connect with, then follow the on-screen instructions to enable the selected device.

Interpreting the Bluetooth icon

The Bluetooth icon acts as an indicator for receiver status.

Icon Color	Indicates
Red	No receiver inserted
White	Receiver plugged in
Green	Receiver has detected the devices

Connecting to other Bluetooth devices in Windows XP

Note: You must install the software on the included CD in order to connect to other Bluetooth devices.

To connect to other Bluetooth devices:

- 1 Make sure that the USB Bluetooth receiver has been plugged in to your computer.
- 2 Put Bluetooth devices, such as printers, modems, and PDAs, into search/pair mode so the Bluetooth receiver will recognize and connect to them (see the device's documentation for instructions). The *Bluetooth Device Selection* dialog box opens.



- 3 Click the device list to open the list of Bluetooth devices, then click the type of device you want to search for. The detected devices are displayed.
- 4 Click a device, then follow the on-screen instructions to connect to the device.

Setting up Bluetooth in Windows Vista or Windows 7

To set up Bluetooth stack in Windows Vista or Windows 7:

- 1 Double-click the Bluetooth  icon in the system tray. The *Bluetooth Settings* screen opens.
- 2 Click the **Devices** tab, then click **Add**. The *Add Bluetooth Device Wizard* starts.
- 3 Click **My device is set and ready to be found**, then click **Next**.
- 4 Select the device(s) you want to enable, then click **Next**.
- 5 Set a passkey yourself or let the setup wizard choose one for you.
- 6 Click **Next** to continue. Setup is complete.
- 7 Click **Finish** to exit the setup wizard.

Using the keyboard and mouse

Checking battery status

Note: You must install the software on the included CD and pair the keyboard and mouse before you can check battery status.

To check the keyboard battery status:

- Click **Start**, **Control Panel**, **Keyboard**, then click **Bluetooth**. The *Keyboard Properties* dialog box opens with the **Bluetooth** tab on top. The remaining battery power level is shown.



To check the mouse battery status:

- Click **Start, Control Panel, Mouse**, then click **Bluetooth**. The *Mouse Properties* dialog box opens with the **Bluetooth** tab on top. The remaining battery power level is shown.



Changing the low battery alarm settings

To change the low battery alarm settings:

- 1 Open the *Keyboard Properties* dialog box or the *Mouse Properties* dialog box. For instructions, see “Checking battery status” on page 23.
- 2 Click **Low Battery Alarm**. The *Low Battery Alarm* dialog box opens.



- 3 Change the settings you want, then click **OK**. You can change the level at which you want the alarm to occur and turn the audio and visual notifications on or off.

Adjusting the tilt/scroll wheel

Your mouse comes with an advanced scroll wheel that lets you scroll horizontally as well as vertically.

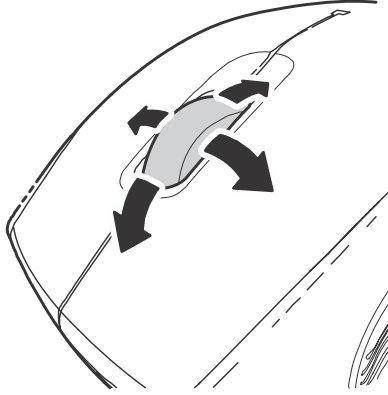

To adjust the tilt/scroll wheel:

- 1 Right-click the **Mouse** icon in the system tray, then click **Adjust Property**. The *Bluetooth Mouse Property* dialog box opens.

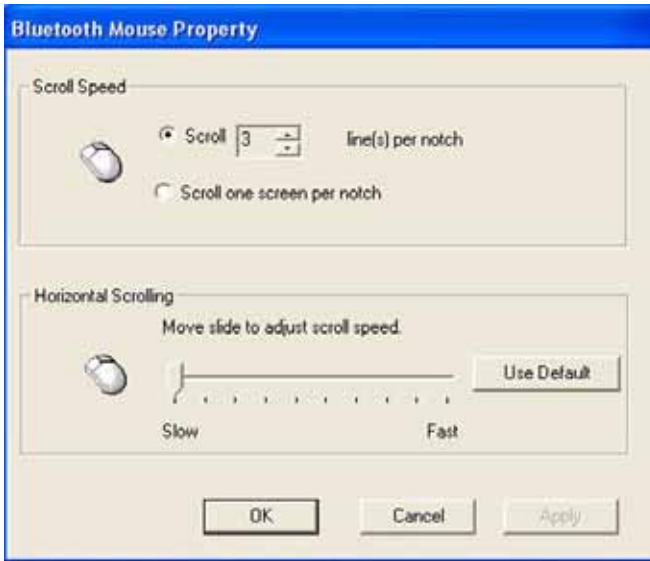

- 2 To set the vertical scroll speed, click one of the following, then click **OK**.
 - **Scroll x line(s) per notch**—Sets the number of lines to scroll when the scroll wheel is moved one notch. Specify the number of lines with the up and down arrows.
 - **Scroll one screen per notch**—Scrolls the entire window when the scroll wheel is moved one notch.
- 3 To set the horizontal scroll speed, move the **Horizontal Scroll** slider toward **Slow** or **Fast**, or click **Use Default** to restore the factory settings.
- 4 Click **OK**.

Maintaining

To clean your Bluetooth keyboard and mouse, wipe them with a soft, lint-free cloth slightly moistened with water.

Troubleshooting

If you have any problems with your Bluetooth keyboard or mouse, check the following:

- Make sure that your computer meets the system requirements.
- Make sure that the batteries in the keyboard and mouse are installed correctly. Make sure that the + and – symbols on the batteries align with the + and – symbols inside the keyboard and mouse battery compartments.
- When the mouse LED is red, battery power is low. Replace the batteries immediately.
- After the Bluetooth stack (see “Installing the software” on page 18) has been installed on your computer, you can check the battery status of keyboard and mouse by clicking **Start, Control Panel, Keyboard or Mouse**, then clicking **Bluetooth**.
- If the keyboard and mouse do not work, check the USB keyboard and mouse settings in your system's BIOS. The settings should be enabled for the normal use of keyboard and mouse. See “Turning on the USB keyboard and mouse settings in BIOS” on page 15.
- If your computer's BIOS setup has options for the keyboard or mouse, make sure that they are set to default settings. If you are not familiar with the BIOS, see your the documentation that came with your computer.
- Only use the mouse on a clean, flat surface in order to ensure smooth and accurate cursor movement. If you use a mousepad, choose a light-colored one, not a dark one, to use less battery power. Also, do not use the mouse on a reflective surface such as metal, glass, or polished wood.

Specifications

	Mouse	Keyboard
Dimensions H × L × W	Mouse: 1.7 × 4.9 × 2.88 inches (43.28 x 124.57 x 73.2 mm) Dongle: 0.18 × 0.75 × 0.53 inches (4.5 x 19.15 x 13.55 mm)	1.14 × 19.8 × 8.35 inches (29 x 503 x 212 mm)
Resolution	1200 DPI @ 10 inch/sec	n/a
Tracking speed	Maximum 30 inch/sec (76.2 cm/sec)	n/a
Weight	Mouse (without battery): 3.17 oz. (90 g) Dongle: 0.1 oz. (3 g)	31.75 oz. (900 g) (without battery)
Buttons	4 buttons with tilt scroll wheel	104-key standard key with 18-multimedia hot keys
Compatibility	Windows XP Service Pack 3 Windows Vista 32-bit or 64-bit Windows 7 32-bit or 64-bit	
Operating temperature	32°F to 104°F (0°C to 40°C)	
Storage temperature	-40°F to 140°F (-40°C to 60°C)	
Operating humidity	90% RH or less	
Storage humidity	95% RH or less	
Battery	AA x 2	AA x 2
Regulations and certifications	EMI, ESD, RS, EFT, FCC, IC, BQB, WHQL	

Legal notices

FCC Part 15

This device complies with Part 15 of the FCC Rules. Operation of this product is subject to the following two conditions: (1) this device may not cause harmful interference, and (2) this device must accept any interference received, including interference that may cause undesired operation.

This equipment has been tested and found to comply within the limits for a class B digital device, pursuant to Part 15 of the FCC Rules. These limits are designed to provide reasonable protection against harmful interference in a residential installation. This equipment generates, uses, and can radiate radio frequency energy and, if not installed and used in accordance with the instructions, may cause harmful interference to radio communications. However, there is no guarantee that interference will not occur in a particular installation. If this equipment does cause harmful interference to radio or television reception, which can be determined by turning the equipment off and on, the user is encouraged to try to correct the interference by one or more of the following measures:

- Reorient or relocate the receiving antenna.
- Increase the separation between the equipment and receiver.
- Connect the equipment into an outlet on a circuit different from that to which the receiver is connected.
- Consult the dealer or an experienced radio/TV technician for help.

FCC warning

Changes or modifications not expressly approved by the party responsible for compliance with the FCC Rules could void the user's authority to operate this equipment.

DHHS and FDA safety certification

This product is made and tested to meet safety standards of the FCC, requirements and compliance with safety performance of the U.S. Department of Health and Human Services, and also with FDA Radiation Performance Standards 21 CFR Subchapter J.

Canada ICES-003 statement

This Class B digital apparatus complies with Canadian ICES-003.

IMPORTANT NOTE:

FCC Radiation Exposure Statement:

This equipment complies with FCC radiation exposure limits set forth for an uncontrolled environment. End users must follow the specific operating instructions for satisfying RF exposure compliance.

This transmitter must not be co-located or operating in conjunction with any other antenna or transmitter.

IC Statement

Operation is subject to the following two conditions: 1) this device may not cause interference and 2) this device must accept any interference, including interference that may cause undesired operation of the device.

One-year limited warranty

Rocketfish Products ("Rocketfish") warrants to you, the original purchaser of this new **RF-BTCMB02** ("Product"), that the Product shall be free of defects in the original manufacture of the material or workmanship for one (1) year from the purchase of the Product ("Warranty Period"). This Product must be purchased from an authorized dealer of Rocketfish brand products and packaged with this warranty statement. This warranty does not cover refurbished Product. If you notify Rocketfish during the Warranty Period of a defect covered by this warranty that requires service, terms of this warranty apply.

How long does the coverage last?

The Warranty Period lasts for one year (365 days), beginning on the date you purchased the Product. The purchase date is printed on the receipt you received with the product.

What does this warranty cover?

During the Warranty Period, if the original manufacture of the material or workmanship of the Product is determined to be defective by an authorized Rocketfish repair center or store personnel, Rocketfish will (at its sole option): (1) repair the Product with new or rebuilt parts; or (2) replace the Product at no charge with new or rebuilt comparable products or parts. Products and parts replaced under this warranty become the property of Rocketfish and are not returned to you. If service of Products and parts are required after the Warranty Period expires, you must pay all labor and parts charges. This warranty lasts as long as you own your Rocketfish Product during the Warranty Period. Warranty coverage terminates if you sell or otherwise transfer the Product.

How to obtain warranty service?

If you purchased the Product at a retail store location, take your original receipt and the Product to the store you purchased it from. Make sure that you place the Product in its original packaging or packaging that provides the same amount of protection as the original packaging. If you purchased the Product from an online web site, mail your original receipt and the Product to the address listed on the web site. Make sure that you put the Product in its original packaging or packaging that provides the same amount of protection as the original packaging.

Where is the warranty valid?

This warranty is valid only to the original purchaser of the Product in the United States, Canada, and Mexico.

What does the warranty not cover?

This warranty does not cover:

- Customer instruction
- Installation
- Set up adjustments
- Cosmetic damage

- Damage due to acts of God, such as lightning strikes
- Accident
- Misuse
- Abuse
- Negligence
- Commercial use
- Modification of any part of the Product, including the antenna

This warranty also does not cover:

- Damage due to incorrect operation or maintenance
- Connection to an incorrect voltage supply
- Attempted repair by anyone other than a facility authorized by Rocketfish to service the Product
- Products sold as is or with all faults
- Consumables, such as fuses or batteries
- Products where the factory applied serial number has been altered or removed

REPAIR REPLACEMENT AS PROVIDED UNDER THIS WARRANTY IS YOUR EXCLUSIVE REMEDY. ROCKETFISH SHALL NOT BE LIABLE FOR ANY INCIDENTAL OR CONSEQUENTIAL DAMAGES FOR THE BREACH OF ANY EXPRESS OR IMPLIED WARRANTY ON THIS PRODUCT, INCLUDING, BUT NOT LIMITED TO, LOST DATA, LOSS OF USE OF YOUR PRODUCT, LOST BUSINESS OR LOST PROFITS. ROCKETFISH PRODUCTS MAKES NO OTHER EXPRESS WARRANTIES WITH RESPECT TO THE PRODUCT, ALL EXPRESS AND IMPLIED WARRANTIES FOR THE PRODUCT, INCLUDING, BUT NOT LIMITED TO, ANY IMPLIED WARRANTIES OF AND CONDITIONS OF MERCHANTABILITY AND FITNESS FOR A PARTICULAR PURPOSE, ARE LIMITED IN DURATION TO THE WARRANTY PERIOD SET FORTH ABOVE AND NO WARRANTIES, WHETHER EXPRESS OR IMPLIED, WILL APPLY AFTER THE WARRANTY PERIOD. SOME STATES, PROVINCES AND JURISDICTIONS DO NOT ALLOW LIMITATIONS ON HOW LONG AN IMPLIED WARRANTY LASTS, SO THE ABOVE LIMITATION MAY NOT APPLY TO YOU. THIS WARRANTY GIVES YOU SPECIFIC LEGAL RIGHTS, AND YOU MAY ALSO HAVE OTHER RIGHTS, WHICH VARY FROM STATE TO STATE OR PROVINCE TO PROVINCE.

Contact Rocketfish:

For customer service please call 1-800-620-2790
www.rocketfishproducts.com

Distributed by Best Buy Purchasing, LLC
 7601 Penn Avenue South, Richfield, Minnesota, U.S.A. 55423-3645
 © 2009 Best Buy Enterprise Services, Inc.

All rights reserved. ROCKETFISH is a trademark of Best Buy Enterprise Services, Inc. Registered in some countries. All other products and brand names are trademarks of their respective owners.

www.rocketfishproducts.com (800) 620-2790

Distributed by Best Buy Purchasing, LLC

7601 Penn Avenue South, Richfield, MN 55423-3645 USA

© 2009 Best Buy Enterprise Services, Inc.

All rights reserved. ROCKETFISH is a trademark of Best Buy Enterprise Services, Inc.
All other products and brand names are trademarks of their respective owners.

09-0511
ENGLISH