

v1
R3



2.4Ghz Ergo Laser Mouse

DRAFT

RF-MSE14

User Guide



2.4Ghz Ergo Laser Mouse

Contents

Introduction	4
Features	4
Package contents	4
System requirements.....	4
Top.....	5
Bottom	7
Setting up the mouse	8
Installing the battery.....	8
Setting up the mouse	11
Installing the mouse driver and software	12
Configuring the Mouse	18
Uninstalling the mouse driver and software	25
Maintaining	26
Troubleshooting	27

Specifications	27
Legal notices.....	28
One-year limited warranty	31

Important safety instructions

- 1 Read these instructions.
- 2 Keep these instructions.
- 3 Heed all warnings.
- 4 Follow all instructions.
- 5 Do not use this apparatus near water.
- 6 Clean only with a dry cloth.
- 7 Batteries should not be exposed to excessive heat such as sunshine, fire, or the like.
- 8 **Caution:** Danger of explosion if battery is incorrectly replaced. Replace only with the same or equivalent type.

Introduction

Congratulations on your purchase of the 2.4Ghz Ergo Laser Mouse. This mouse represents the state of the art in wireless mouse design and is designed for reliable and trouble-free performance.

Features

- Nano dongle
- 2.4 GHz wireless connection
- Tilt/scroll wheel
- Six mouse buttons
- Excellent performance working range of more than 32.8 feet (10 meters) (with no interference)
- Four LED indicators

Package contents

- Mouse
- Nano dongle
- Installation CD (includes software and *User Guide*)
- AA battery
- *Quick Setup Guide*

System requirements

- USB port (USB 2.0 OR 1.1)
- CD drive
- Operating system: Windows® XP with Service Pack 3 or higher, Windows Vista®, or Windows® 7

Top

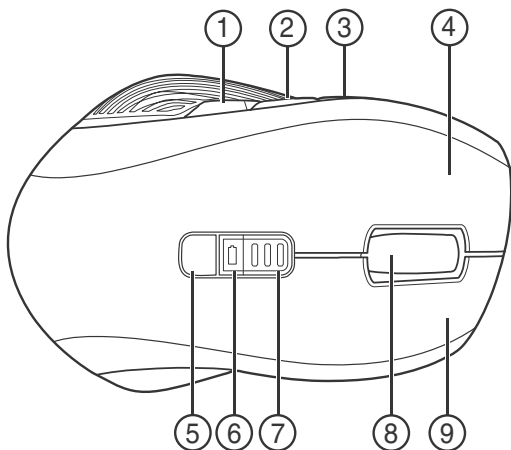

#	Item	Description
1	C button	Press to go to the previous page in a Web browser.
2	B button	Press to activate dynamic search. You must install the mouse driver to use this feature.
3	A button	Press to go to the next page in a Web browser.
4	Left button	Press to perform standard left-mouse actions such as selecting items and opening programs.
5	DPI button	Press to select the screen resolution. You can select 800 dpi, 1200 dpi, or 1600 dpi.
6	Battery LED	Lights red when the battery is low.

#	Item	Description
7	DPI LED	Indicates the current DPI setting. One LED lit— DPI is set to 800. Two LEDs lit— DPI is set to 1200. Three LEDs lit— DPI is set to 1600.
8	Scroll wheel	Roll to move the screen image up or down or tilt to move the screen left or right. If you press down on the scroll wheel, a four- way icon appears on the screen. Move the mouse up, down, left, or right to scroll.
9	Right button	Press to perform standard right mouse actions such as opening popup menus or viewing help information.

Bottom

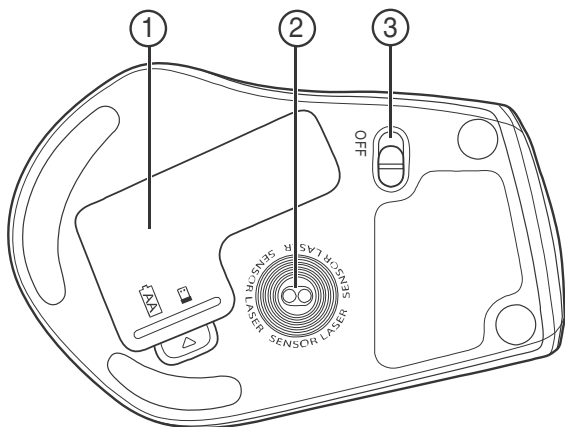

#	Item	Description
1	Battery compartment	Provides storage for the battery and dongle.
2	Laser sensor	Detects the mouse movements and sends signals to the computer to move the mouse pointer on the screen.
3	Power button	Slide to turn the mouse on or off.

Setting up the mouse

Installing the battery

To install the battery:

- 1 Press the tab on the battery compartment cover, then lift the cover away from the mouse.

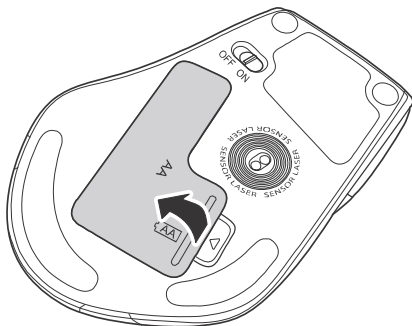

- 2 Pull the dongle out of the battery compartment.

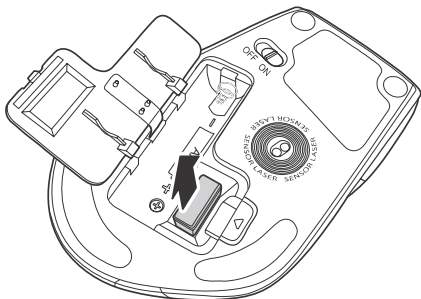

- 3 Insert one AA battery into the battery compartment. Make sure that the + and - symbols on the battery match the + and - symbols in the battery compartment.

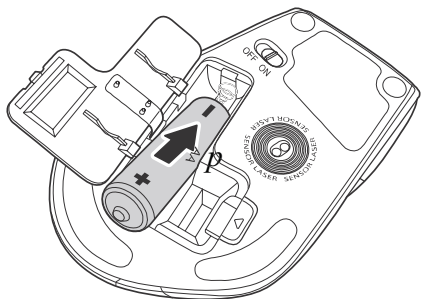

4 Replace the battery compartment cover.

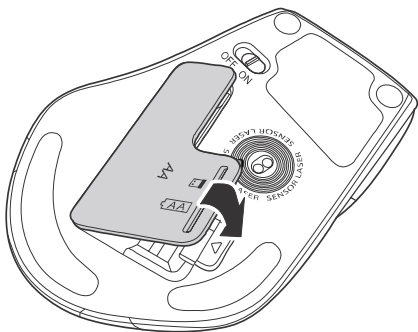

Setting up the mouse

To set up the mouse:

- 1 Plug the USB dongle into a USB port on the computer.

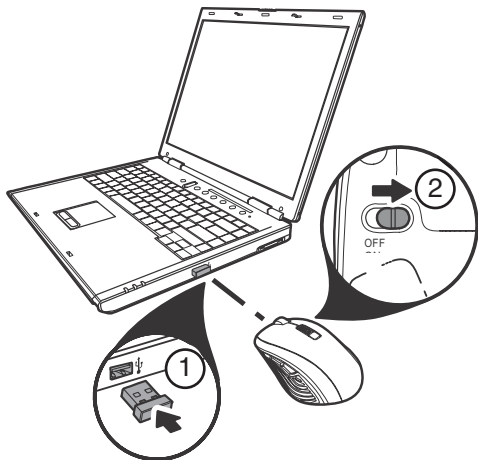

- 2 Slide the power button on the bottom of the mouse to the right to turn on the mouse. The computer detects the mouse.

Installing the mouse driver and software

To use advanced functions, such as dynamic search and magnifier, you need to install the mouse driver and software.

Note: The following instructions are based on the Windows® XP operating system.

To install the mouse driver and software:

- 1 Make sure that you have installed the battery, connected the dongle, and turned on the mouse.
- 2 Insert the provided installation CD in the CD drive on the computer. The installation program should start automatically. If it does not start automatically, open Windows Explorer, browse the CD, then double-click **setup.exe**. The mouse installation screen opens.

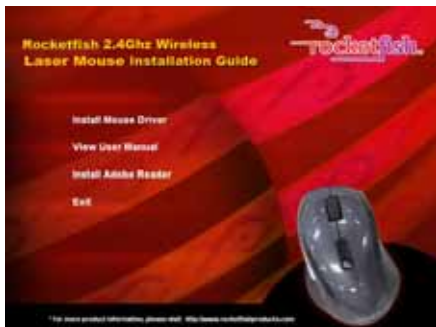

- 3 Click **Install Mouse Driver**. The *Welcome* screen opens.



- 4 Click **Next**. The *Start Installation* screen opens.



- 5 Click **Next**. An installation progress bar appears. When the installation is complete, the *Setup Complete* screen opens.



- 6 Click **Finish**.

Using the mouse

To use the mouse:

- Press the left or right mouse buttons to perform standard left and right mouse clicks.
- Move the scroll wheel to move the screen image up, down, left, or right.

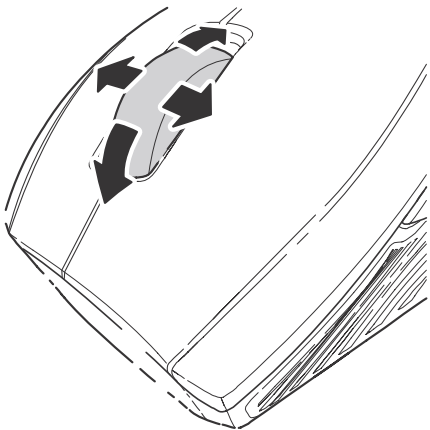

Tip: You can also scroll the screen by sliding your mouse instead of using the scroll wheel. To do this, press down on the scroll wheel. A four-way icon appears on the screen. Move your mouse up, down, left, or right to scroll.

- Press button **A** to go to the next page in a Web browser or press button **C** to go the previous page in a Web browser.

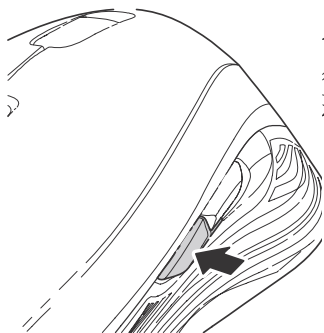

A button

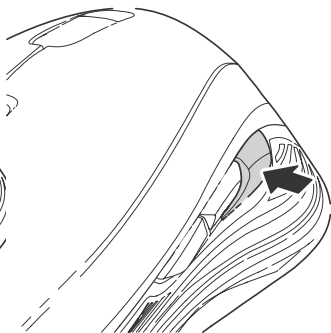

C button

- Press button **B** to use the dynamic search function.

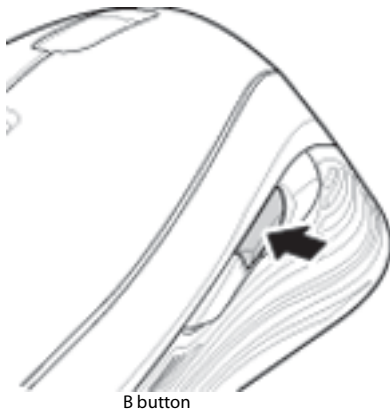

Note: To use dynamic search, press the left mouse button and drag the mouse to highlight a word. Press the dynamic search button. The Google™ Web site opens and displays information about the word.

Configuring the Mouse

To configure the mouse:

- Double-click the mouse icon on the system tray to open the mouse program, then click a tab to adjust a mouse function. If the mouse icon is not in your system tray, click **Start, Settings, Control Panel**, then click **RF 2.46Ghz Ergo Laser Mouse**. You can select any of the following tabs:
 - **Buttons**—See “Configuring mouse buttons” on page 19.
 - **Double-Click**—See “Adjusting the double-click speed” on page 20.
 - **Orientation**—See “Adjusting the orientation” on page 21.
 - **Wheel**—See “Adjusting the wheel settings” on page 22.
 - **Pointer Utility**—See “Adjusting the pointer behavior” on page 23.
 - **Mouse Suite**—See “Hiding the system tray’s mouse icon” on page 24.

Configuring mouse buttons

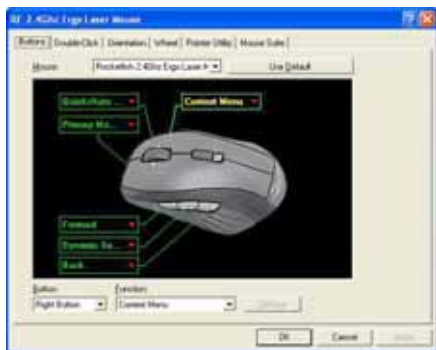

To configure the buttons:

- 1 Click the **Button** list arrow to open the list of buttons, then click the button you want to configure.
- 2 Click the **Function** list arrow to open the list of functions, then click the function you want to assign to the button.

The default settings for the mouse buttons are:

Button	Function	Button	Function
Left	Primary mouse button	A	Forward
Right	Context menu	B	Dynamic search
Wheel	Quick/Auto scroll	C	Back

- 3 Click other tabs to make more adjustments, or click **OK** to save your selections and close the program.

*Note: To restore default button functions, click **Use Default**.*

Adjusting the double-click speed



To adjust the double-click speed:

- 1 To adjust double-click speed, drag the slider.
- 2 To test the click speed, double-click the **Test Area** icon.
- 3 Click other tabs to make more adjustments, or click **OK** to save your selections and close the program.

*Note: To restore to default settings, click **Reset to Default Value**.*

Adjusting the orientation

Use this tab to adjust the angle at which you use the mouse.



To adjust the orientation:

- 1 Click **Set Orientation** to activate orientation setup, then use the on-screen pointer to follow the dog as it moves around.
- 2 Click other tabs to make more adjustments, or click **OK** to save your selections and close the program.

Note: *To restore the default orientation settings, click **Reset Orientation**.*

Adjusting the wheel settings

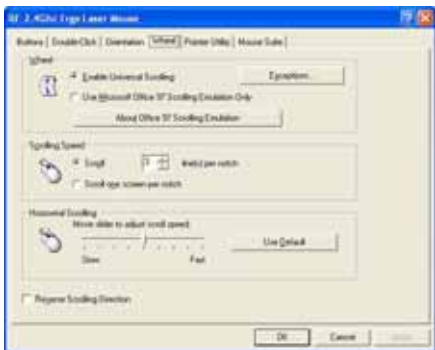

To adjust the wheel settings:

- 1 To select the wheel scrolling method, click:
 - **Enable Universal Scrolling**—Uses common scrolling functions.
 - **Use Microsoft Office 97 Scrolling Emulation Only**—Uses Microsoft Office 97 scrolling emulation.
- 2 To specify scrolling exceptions, click **Exceptions**.
- 3 To adjust vertical scrolling speed, click:
 - **Scroll X line(s) per notch**—Selects the number of lines to scroll when the scroll wheel is moved one notch. Click the up or down arrow keys to specify the number of lines.
 - **Scroll one screen per notch**—Scrolls an entire screen when the scroll wheel is moved one notch.
- 4 To adjust the horizontal scrolling speed, drag the slider.

- 5 To reverse scrolling direction, click **Reverse Scrolling Direction**.
- 6 Click other tabs to make more adjustments, or click **OK** to save your selections and close the program.
Note: To restore to default scrolling speed, click Use Default.

Adjusting the pointer behavior

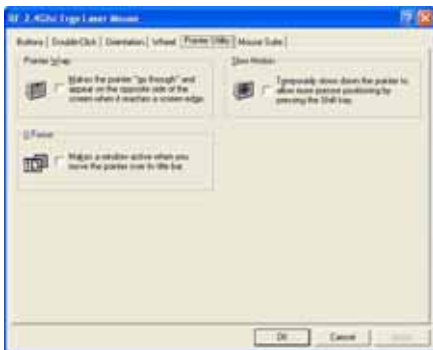

To adjust the pointer behavior:

- 1 Click a pointer option. You can select:
 - **Pointer Wrap**—The pointer goes to the opposite side of the screen when it reaches the screen edge.
 - **X Focus**—Activates a window when the pointer moves over the title bar.
 - **Slow Motion**—Slows down the pointer when the **Shift** key is pressed for a more precise positioning.
- 2 Click other tabs to make more adjustments, or click **OK** to save your selections and close the program.

Hiding the system tray's mouse icon



To hide the system tray's mouse icon:

- Uncheck **Show mouse icon in systray**, then click **OK** to save changes and close the application.

Uninstalling the mouse driver and software

To uninstall the mouse driver and software:

- 1 Unplug the dongle.
- 2 Click **Start, Programs, RF 2.4Ghz Ergo Laser Mouse**, then click **Uninstall RF 2.4Ghz Ergo Laser Mouse Driver**. A message asks if you are sure you want to uninstall the driver.

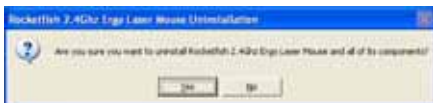

- 3 Click **Yes** to continue. The *Remove Programs From Your Computer* screen opens and displays the progress.



- 4 When the uninstallation is complete, click **OK** to continue. The *Uninstall Complete* screen opens.



- 5 Click **Finish**. Your computer restarts and the uninstallation is complete.

Maintaining

To clean the mouse:

- Wipe the surface and the optical sensor with a soft, lint-free cloth slightly moistened with water.

Troubleshooting

If you experience any problems with the mouse, check the following:

- Make sure that your computer meets the system requirements.
- Make sure that the battery in the laser mouse is installed correctly. Make sure the polarity of the battery corresponds with the polarity symbols inside the battery compartment.
- When the mouse LED lights red, the battery power is low. Replace the battery with a new one.
- If the laser mouse fails to work, check the USB port to see if the dongle is correctly connected.
- Only use the mouse on a clean, flat, non-slippery surface to ensure smooth and accurate cursor action.

Specifications

Specifications are subject to change without notice.

Dimensions H × L × W	Mouse: 1.54 × 4.84 × 2.92 inches (39 × 113.9 × 74.1 mm) Dongle: 0.26 × 0.74 × 0.59 inches (6.6 × 18.8 × 15.0 mm)
Resolution	800, 1200, 1600 dpi
Tracking speed	Maximum 30 inch/sec (76.2 cm/sec)
Weight	Mouse (without battery): 2.82 oz. (80 g) Dongle :0.11 oz. (3 g)
Buttons	5 buttons with tilt scroll wheel
Compatibility	Windows XP Service Pack 3 Windows Vista 32-bit or 64-bit Windows 7 32-bit or 64-bit
Operating temperature	32° to 104°F (0° to 40°C)

Storage temperature	-40° to 140°F (-40° to 60°C)
Operating humidity	90% RH or less
Storage humidity	95% RH or less
Battery	AA (1)
Regulations and certifications	EMI, ESD, RS, EFT, FCC, EC, IC, IEC-003

Legal notices

FCC Part 15

This device complies with Part 15 of the FCC Rules. Operation of this product is subject to the following two conditions: (1) this device may not cause harmful interference, and (2) this device must accept any interference received, including interference that may cause undesired operation.

This equipment has been tested and found to comply within the limits for a class B digital device, pursuant to Part 15 of the FCC Rules. These limits are designed to provide reasonable protection against harmful interference in a residential installation. This equipment generates, uses, and can radiate radio frequency energy and, if not installed and used in accordance with the instructions, may cause harmful interference to radio communications. However, there is no guarantee that interference will not occur in a particular installation. If this equipment does cause harmful interference to radio or television reception, which can be determined by turning the equipment off and on, the user is encouraged to try to correct the interference by one or more of the following measures:

- Reorient or relocate the receiving antenna.
- Increase the separation between the equipment and receiver.
- Connect the equipment into an outlet on a circuit different from that to which the receiver is connected.
- Consult the dealer or an experienced radio/TV technician for help.

FCC warning

Changes or modifications not expressly approved by the party responsible for compliance with the FCC Rules could void the user's authority to operate this equipment.

DHHS and FDA safety certification

This product is made and tested to meet safety standards of the FCC, requirements and compliance with safety performance of the U.S. Department of Health and Human Services, and also with FDA Radiation Performance Standards 21 CFR Subchapter J.

Canada ICES-003 statement

This Class B digital apparatus complies with Canadian ICES-003.

Cet appareil numérique de la classe B est conforme à la norme NMB-003 du Canada.

Important notice

FCC Radiation Exposure Statement: This equipment complies with FCC radiation exposure limits set forth for an uncontrolled environment. End users must follow the specific operating instructions for satisfying RF exposure compliance. This transmitter must not be co-located or operating in conjunction with any other antenna or transmitter. IC Statement Operation is subject to the following two conditions:

- 1 This device may not cause harmful interference and
- 2 This device must accept any interference, including interference that may cause undesired operation of the device.

One-year limited warranty

Rocketfish Products ("Rocketfish") warrants to you, the original purchaser of this new **RF-MSE14** ("Product"), that the Product shall be free of defects in the original manufacture of the material or workmanship for one (1) year from the purchase of the Product ("Warranty Period"). This Product must be purchased from an authorized dealer of Rocketfish brand products and packaged with this warranty statement. This warranty does not cover refurbished Product. If you notify Rocketfish during the Warranty Period of a defect covered by this warranty that requires service, terms of this warranty apply.

How long does the coverage last?

The Warranty Period lasts for one year (365 days), beginning on the date you purchased the Product. The purchase date is printed on the receipt you received with the product.

What does this warranty cover?

During the Warranty Period, if the original manufacture of the material or workmanship of the Product is determined to be defective by an authorized Rocketfish repair center or store personnel, Rocketfish will (at its sole option): (1) repair the Product with new or rebuilt parts; or (2) replace the Product at no charge with new or rebuilt comparable products or parts. Products and parts replaced under this warranty become the property of Rocketfish and are not returned to you. If service of Products and parts are required after the Warranty Period expires, you must pay all labor and parts charges. This warranty lasts as long as you own your Rocketfish Product during the Warranty Period. Warranty coverage terminates if you sell or otherwise transfer the Product.

How to obtain warranty service?

If you purchased the Product at a retail store location, take your original receipt and the Product to the store you purchased it from. Make sure that you place the Product in its original packaging or packaging that provides the same amount of protection as the original packaging. If you purchased the Product from an online web site, mail your original receipt and the Product to the address listed on the web site. Make sure that you put the Product in its original packaging or packaging that provides the same amount of protection as the original packaging.

Where is the warranty valid?

This warranty is valid only to the original purchaser of the Product in the United States, Canada, and Mexico.

What does the warranty not cover?

This warranty does not cover:

- Customer instruction
- Installation
- Set up adjustments
- Cosmetic damage
- Damage due to acts of God, such as lightning strikes
- Accident
- Misuse
- Abuse
- Negligence
- Commercial use
- Modification of any part of the Product, including the antenna

This warranty also does not cover:

- Damage due to incorrect operation or maintenance
- Connection to an incorrect voltage supply
- Attempted repair by anyone other than a facility authorized by Rocketfish to service the Product
- Products sold as is or with all faults
- Consumables, such as fuses or batteries
- Products where the factory applied serial number has been altered or removed

REPAIR REPLACEMENT AS PROVIDED UNDER THIS WARRANTY IS YOUR EXCLUSIVE REMEDY. ROCKETFISH SHALL NOT BE LIABLE FOR ANY INCIDENTAL OR CONSEQUENTIAL DAMAGES FOR THE BREACH OF ANY EXPRESS OR IMPLIED WARRANTY ON THIS PRODUCT, INCLUDING, BUT NOT LIMITED TO, LOST DATA, LOSS OF USE OF YOUR PRODUCT, LOST BUSINESS OR LOST PROFITS. ROCKETFISH PRODUCTS MAKES NO OTHER EXPRESS WARRANTIES WITH RESPECT TO THE PRODUCT, ALL EXPRESS AND IMPLIED WARRANTIES FOR THE PRODUCT, INCLUDING, BUT NOT LIMITED TO, ANY IMPLIED WARRANTIES OF AND CONDITIONS OF MERCHANTABILITY AND FITNESS FOR A PARTICULAR PURPOSE, ARE LIMITED IN DURATION TO THE WARRANTY PERIOD SET FORTH ABOVE AND NO WARRANTIES, WHETHER EXPRESS OR IMPLIED, WILL APPLY AFTER THE WARRANTY PERIOD. SOME STATES, PROVINCES AND JURISDICTIONS DO NOT ALLOW LIMITATIONS ON HOW LONG AN IMPLIED WARRANTY LASTS, SO THE ABOVE LIMITATION MAY NOT APPLY TO YOU. THIS WARRANTY GIVES YOU SPECIFIC LEGAL RIGHTS, AND YOU MAY ALSO HAVE OTHER RIGHTS, WHICH VARY FROM STATE TO STATE OR PROVINCE TO PROVINCE.

Contact Rocketfish:

For customer service please call 1-800-620-2790

www.rocketfishproducts.com

Distributed by Best Buy Purchasing, LLC

7601 Penn Avenue South, Richfield, Minnesota, U.S.A. 55423-3645

© 2009 Best Buy Enterprise Services, Inc.

All rights reserved. ROCKETFISH is a trademark of Best Buy Enterprise Services, Inc. Registered in some countries. All other products and brand names are trademarks of their respective owners.

www.rocketfishproducts.com (800) 620-2790

Distributed by Best Buy Purchasing, LLC
7601 Penn Avenue South, Richfield, MN 55423-3645 USA
© 2009 Best Buy Enterprise Services, Inc.

All rights reserved. ROCKETFISH is a trademark of Best Buy Enterprise Services, Inc.
All other products and brand names are trademarks of their respective owners.

09-0482
ENGLISH