

Dell KM636p Wireless Keyboard and Mouse User's Guide

Regulatory model: KM636p



Notes, Cautions, and Warnings

 **NOTE:** A NOTE indicates important information that helps you make better use of your computer.

 **CAUTION:** A CAUTION indicates potential damage to hardware or loss of data if instructions are not followed.

 **WARNING:** A WARNING indicates a potential for property damage, personal injury, or death.

Restrictions and Disclaimers

The information contained in this document, including all instructions, cautions, and regulatory approvals and certifications, is provided by the supplier and has not been independently verified or tested by Dell. Dell cannot be responsible for damage caused as a result of either following or failing to follow these instructions.

All statements or claims regarding the properties, capabilities, speeds or qualifications of the part referenced in this document are made by the supplier and not by Dell. Dell specifically disclaims knowledge of the accuracy, completeness or substantiation for any such statements. All questions or comments relating to such statements or claims should be directed to the supplier.

Export Regulations

Customer acknowledges that these Products, which may include technology and software, are subject to the customs and export control laws and regulations of the United States ("U.S.") and may also be subject to the customs and export laws and regulations of the country in which the Products are manufactured and/or received. Customer agrees to abide by those laws and regulations. Further, under U.S. law, the Products may not be sold, leased or otherwise transferred to restricted end-users or to restricted countries. In addition, the Products may not be sold, leased or otherwise transferred to, or utilized by an end-user engaged in activities related to weapons of mass destruction, including without limitation, activities related to the design, development, production or use of nuclear weapons, materials, or facilities, missiles or the support of missile projects, and chemical or biological weapons.

Information in this document is subject to change without notice. © 2015 Dell Inc. All rights reserved. Reproduction of these materials in any manner whatsoever without the written permission of Dell Inc. is strictly forbidden. Trademarks used in this text : Dell™ and the DELL logo are trademarks of Dell Inc.; Microsoft® and the Windows start button logo are either trademarks or registered trademarks of Microsoft Corporation in the United States and/or other countries.

Other trademarks and trade names may be used in this document to refer to either the entities claiming the marks and names or their products. Dell Inc. disclaims any proprietary interest in trademarks and trade names other than its own.

Contents

Package Contents	5
Setup	5
System Requirements	5
Identifying Parts and Controls (Keyboard Features)	6
Top View	6
Side View	7
Bottom View	7
Identifying Parts and Controls (Mouse Features) ...	8
Top View	8
Bottom View	9
Setting Up Your Wireless Keyboard and Mouse ...	10
Unifying Pairing Features for Windows and Chrome ..	11
Increasing the Battery Life of Your Mouse	14
Troubleshooting	15
Keyboard Specifications	16
General	16
Electrical	16
Physical Characteristics	16
Environmental	16
2.4 GHz Wireless	16
Mouse Specifications	17
General	17

Electrical	17
Physical Characteristics	17
Environmental	17
2.4 GHz Wireless	17
Statutory Information.	18
Warranty	18
Limited Warranty and Return Policies	18
For U.S. customers.	18
For European, Middle Eastern and African customers	18
For non-U.S. customers	18
Regulatory.	19
Regulatory Information	19
Certification	20
Microsoft WHQL Logo	20

Package Contents

Setup

System Requirements

- USB port (for the USB receiver)
- Microsoft Windows 10/8/7/XP/Vista/Server 2003/Server 2008/Server 2012, Linux 6.x, Ubuntu, Neoklyin, Free DOS, Chrome and Android

Contents of the Box

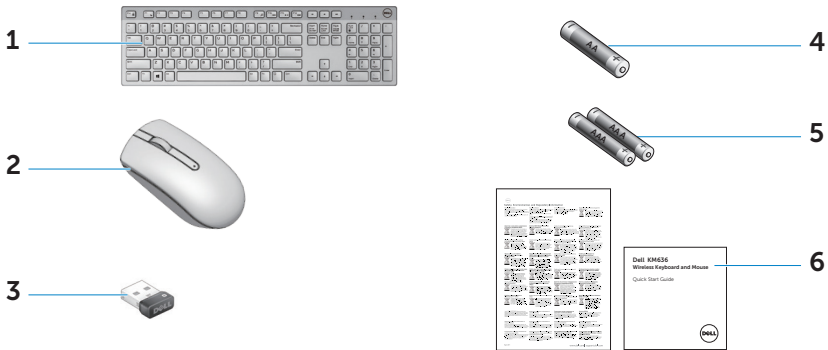









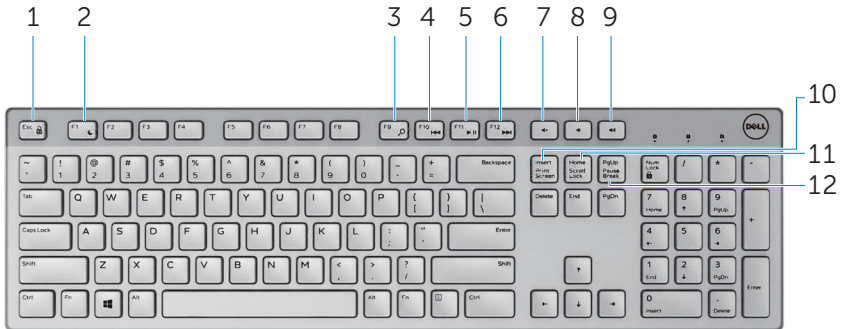









- | | |
|---|---|
| 1 | Wireless Keyboard |
| 2 | Wireless Mouse |
| 3 | USB Receiver |
| 4 | AA-type battery for the Mouse |
| 5 | AAA-type batteries for the Keyboard (2) |
| 6 | Documents |

 **NOTE:** The documents that shipped with the keyboard and mouse may vary based on your region.

Identifying Parts and Controls (Keyboard Features)

Top View



1	 + 	Toggle Fn-key lock	7		Mute
2	 + 	Sleep	8		Decrease volume
3	 + 	Search	9		Increase volume
4	 + 	Play previous track/chapter	10		Print Screen
5	 + 	Play/Pause	11		Scroll Lock
6	 + 	Play next track/chapter	12		Pause Break

Locking/Unlocking the Function Keys

The function keys provide convenient, secondary functions. These functions are marked in blue on the function keys and are listed in the table above.

When the keyboard is powered up, all keys are in their primary functions. To activate the blue function keys, you should hold down the **Fn** key and press the desired function key.

The secondary functions for keys **F1**, **F9**, **F10**, **F11** and **F12** can be locked. You can lock the function keys by holding down the **Fn** key and by pressing the **Esc** key. When the function keys are locked, you can activate each function by pressing the key without holding down **Fn**.

 **NOTE:** When the function keys are locked, their primary functions are disabled. To unlock the function keys, hold down the **Fn** key and press the **Esc** key. This returns all keys to their primary functions.

Side View



- 1 Battery status light – Indicates the status of the batteries installed in your keyboard.
 - **Solid white** – Appears for about 15 seconds after the batteries are installed then turns off.
 - **Blinking amber** – Battery level is low. Replace the batteries.

Bottom View

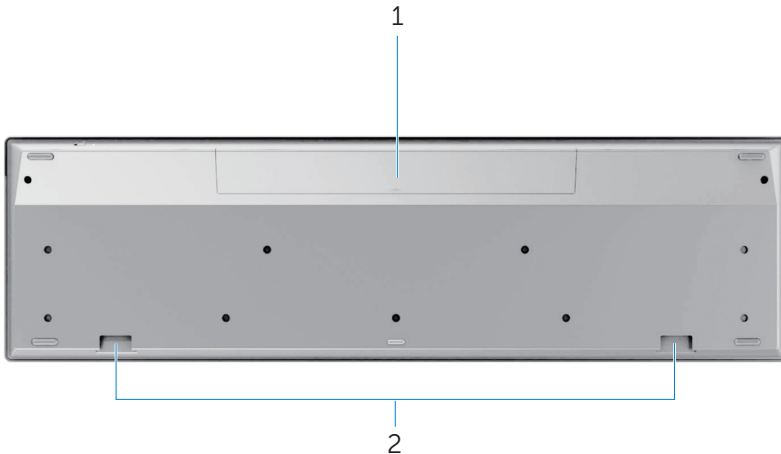

- 1 Battery compartment – The battery compartment holds two AAA batteries to power the keyboard.
- 2 Palm rest attachment slots – Attach the Dell keyboard palm rest PR216 to the keyboard by inserting the two latches on the palm rest into these two slots.

Identifying Parts and Controls (Mouse Features)

Top View



1 Left button

3 Right button

2 Middle / Scroll button

4 Battery status light

 **NOTE:** Blinking amber indicates that the battery level is low. Replace the battery.

Bottom View

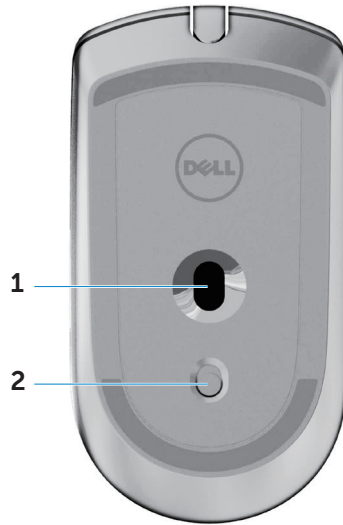

1 Optical sensor

2 Power button

Setting Up Your Wireless Keyboard and Mouse

1. Install the two AAA batteries in your keyboard.

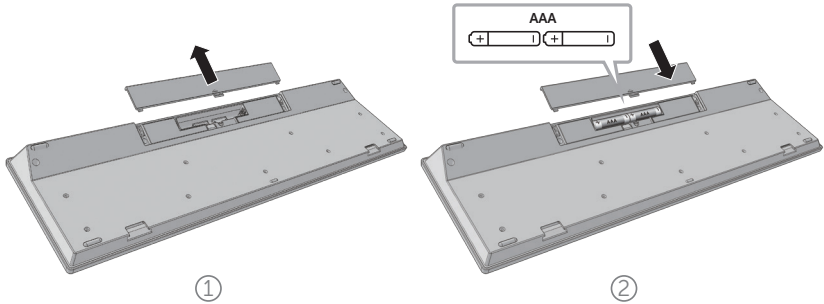

2. Install the AA battery in your mouse.

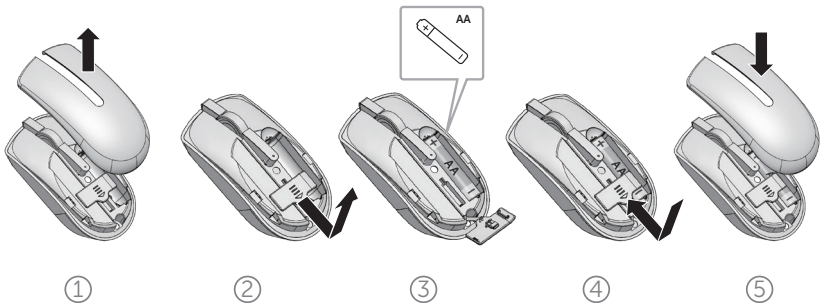

3. Connect the USB receiver to the computer.

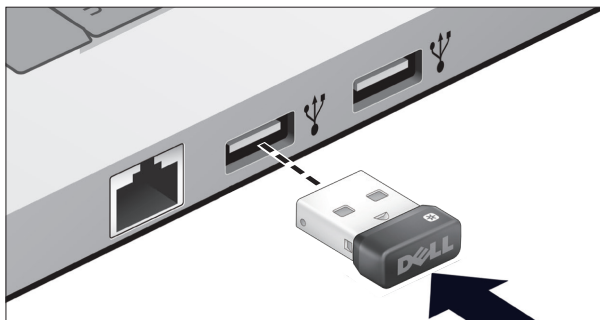

If your keyboard or mouse is not working, see the **Troubleshooting** section.

Unifying Pairing Features for Windows and Chrome

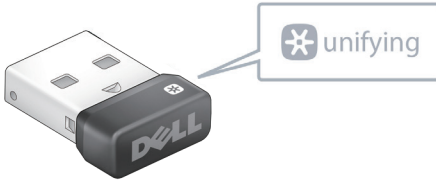

The USB unifying receiver is a wireless receiver that can stay plugged into your computer's USB port, allowing you to easily connect your wireless mouse and keyboard to your computer. Up to four additional unifying-compatible wireless devices can be connected at the same time, for a total of six devices.

The receiver, mouse and keyboard shipped with your system are paired at the factory. No installation is required. However, if the original receiver is lost or misplaced, the wireless devices must be re-paired with the new receiver.

Re-pairing Devices with the New Receiver

To re-pair devices with a new wireless receiver:

1. Download and install the unifying software in your system. If the Unifying software is not installed on your Windows system, it can be downloaded from dell.com/support/unifying. Chrome book users can download the Unifying application from the Chrome web store. Follow the installation instructions on the download page to install and run the downloaded file.
2. Run the unifying software to pair each device. To connect unifying devices to your unifying USB receiver:
 - a) Launch the unifying software.

b) At the bottom of the Welcome screen, click **Next**.



c) When you see the "Restart the device..." screen, follow the on-screen instructions to turn your device off and then back on.

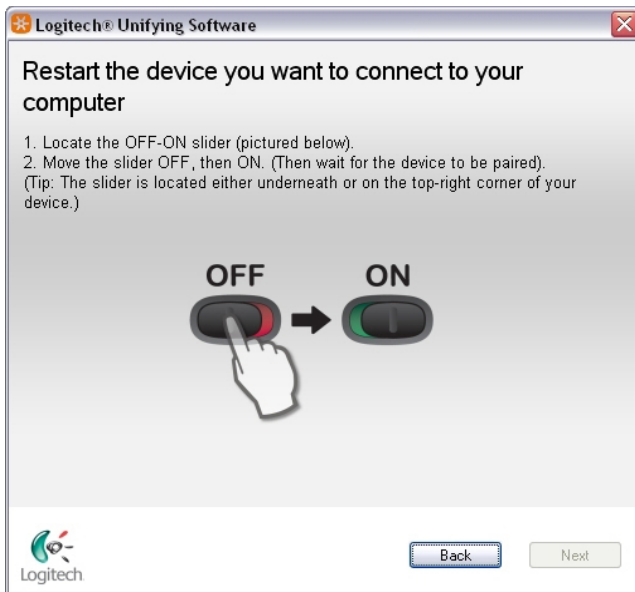

d) When your device is detected, you'll see a confirmation screen opens.
If you connected a:

- **Keyboard:** Type a test message in the field provided to make sure it works.
- **Mouse:** Move the mouse around to see if the cursor moves with it.

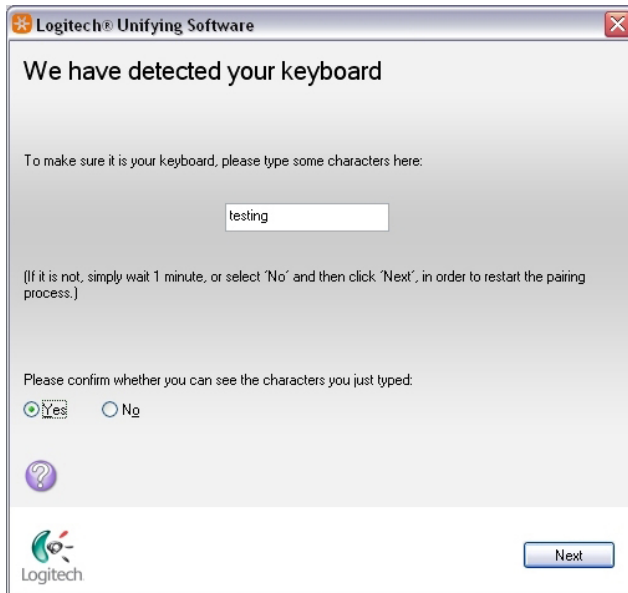

e) If your device connected successfully, click **Yes** and then **Next**.

If your device does not work right away, wait a few minutes to see if it connects. If it doesn't, select **No** and then click **Next** to restart the pairing process from step a).

f) Click **Finish** to exit the unifying software (or **Pair Another Device** to pair additional devices). Your devices should now be connected.

Increasing the Battery Life of Your Mouse

The mouse has three operating modes built in to conserve battery power:

- 1. Sleep mode:** When the mouse has been inactive for 5 seconds.
To wake the mouse: Move or click.
- 2. Deep sleep mode:** When the mouse has been inactive for 5 minutes.
To wake the mouse: Move or click.
- 3. Cut-off mode:** When the mouse has been carried around or left facing upwards for 5 minutes or when the mouse has been inactive for 4 hours.
To wake the mouse: Switch the power button off and then on again.

Troubleshooting

Common Symptoms

The following table contains information about common issues you might encounter and the possible solutions.

Common Symptoms	What You Experience	Possible Solutions
Unable to use the keyboard	No response when operating your keyboard	<ol style="list-style-type: none">1. Check if the batteries are inserted in the correct orientation.<ul style="list-style-type: none">• Batteries + and - ends should follow those indicated on the battery compartment label.2. Check if the keyboard's power switch is set to On.3. Remove and reinstall the batteries. The power status light turns on (solid white) for about 15 seconds and turns off.4. Remove and reconnect the USB receiver on your computer.5. Connect the USB receiver into another USB port on your computer.6. Restart your computer.

Keyboard Specifications

General

Model Number	WK636p
Connection Type	2.4 GHz wireless technology
Supported Operating Systems	Microsoft Windows 10/8/7/XP/Vista/Server 2003/Server 2008/Server 2012 Linux 6.x, Ubuntu, Neokylin, Free DOS, Chrome and Android
Key Mechanism	Plunger

Electrical

Operating Voltage	2.05V to 3.2V
Battery Required	AAA Alkaline (2)

Physical Characteristics

Height	25.5mm (\pm 0.5mm)
Length	442.0mm (\pm 0.7mm)
Width	127.5mm (\pm 0.5mm)
Weight	425g, without batteries

Environmental

Operating Temperature	0°C to 40°C
Storage Temperature	-40°C to 65°C
Operating Humidity	90% maximum Relative Humidity, non condensing.
Storage Humidity	95% maximum Relative Humidity, non condensing

2.4 GHz Wireless

Radio Transmission	Bi-directional communication (Transceiver)
Range	Up to 10 meters

Mouse Specifications

General

Model Number	WM116p
Connection Type	2.4 GHz wireless technology
Supported Operating Systems	Microsoft Windows 10/8/7/XP/Vista/Server 2003/Server 2008/Server 2012 Linux 6.x, Ubuntu, Neokylin, Free DOS, Chrome and Android

Electrical

Operating Voltage	0.95 V to 1.8 V
Battery Required	One AA Alkaline

Physical Characteristics

Height	36.0mm(\pm 0.3 mm)
Width	61.0mm(\pm 0.3 mm)
Length	113.6mm(\pm 0.5 mm)
Weight	65g, without battery

Environmental

Operating Temperature	0°C to 40°C
Storage Temperature	-40°C to 65°C
Operating Humidity	90% maximum Relative Humidity, non condensing.
Storage Humidity	95% maximum Relative Humidity, non condensing

2.4 GHz Wireless

Radio Transmission	Bi-directional communication (Transceiver)
Range	Up to 10 meters

Statutory Information

Warranty

Limited Warranty and Return Policies

Dell-branded products carry a 1-year limited hardware warranty. If purchased together with Dell system, it will follow the system warranty.

For U.S. customers:

This purchase and your use of this product are subject to Dell's end user agreement, which you can find at www.dell.com/terms. This document contains a binding arbitration clause.

For European, Middle Eastern and African customers:

Dell-branded products that are sold and used are subject to applicable national consumer legal rights, the terms of any retailer sale agreement that you have entered into (which will apply between you and the retailer) and Dell's end user contract terms.

Dell may also provide an additional hardware warranty – full details of the Dell end user contract and warranty terms can be found by going to www.dell.com, selecting your country from the list at the bottom of the "home" page and then clicking the "terms and conditions" link for the end user terms or the "support" link for the warranty terms.

For non-U.S. customers:

Dell-branded products that are sold and used are subject to applicable national consumer legal rights, the terms of any retailer sale agreement that you have entered into (which will apply between you and the retailer) and Dell's warranty terms. Dell may also provide an additional hardware warranty – full details of Dell's warranty terms can be found by going to www.dell.com, selecting your country from the list at the bottom of the "home" page and then clicking the "terms and conditions" link or the "support" link for the warranty terms.

Regulatory

Keyboard Regulatory Model: WK636p

Mouse Regulatory Model: WM116p

Dongle Regulatory Model: DGRFEO

Regulatory Information

These devices comply with Part 15 of the FCC Rules. Operation of the devices is subject to the following two conditions : a) The devices may not cause harmful interference, and b) The devices must accept any interference that may cause undesired operation.

This equipment has been tested and found to comply with the limits for a Class B digital device, pursuant to Part 15 of the FCC Rules. These limits are designed to provide reasonable protection against harmful interference in a residential installation. This equipment generates, uses, and can radiate radio frequency energy. If the equipment is not installed and used in accordance with the instructions, the equipment may cause harmful interference to radio communications. There is no guarantee, however, that such interference will not occur in a particular installation.

If this equipment does cause harmful interference to radio or television reception (which can be determined by turning the equipment off and on), the user is encouraged to try to correct the interference by taking one or more of the following measures:

- Relocate this device.
- Increase the separation between the device and the receiver.
- Connect the device into an outlet on a circuit different from that of other electronics.
- Consult the dealer or an experienced radio technician for help.

Certifications

Microsoft WHQL Logo

The Dell KM636p Wireless Keyboard and Mouse have passed WHQL logo testing by Microsoft Windows Hardware Quality Labs.

WHQL Logo is a certification scheme operated by Microsoft Windows Hardware Quality Labs. In this case it ensures that hardware is compatible with Microsoft Operating Systems. The keyboard and mouse are qualified through the use of WHQL test kits and have been included in the Microsoft Hardware Compatibility List.