

User Manual v1.0

ProDrone Byrd



1

ProDrone

Instructions

Warnings

Thank you for using the product of ProDrone. This is a special electronic product. Faulty operation might damage articles, injure human body and even cause deaths. The caused legal consequences should be shouldered on your own. Juveniles younger than 18 years old are not suggested to use this aircraft.

CAUTION
RISK OF EXPLOSION IF BATTERY IS REPLACED
BY AN INCORRECT TYPE.
DISPOSE OF USED BATTERIES ACCORDING
TO THE INSTRUCTIONS

To ensure the quality of your experience and your personal security, please carefully read the following profiles before using the aircraft:

1. *Disclaimer*
2. *Battery Safety Guidelines*
3. *Routine Maintenance Manual*
4. *List*
5. *Quick Start Guide*
6. *User Manual*
7. *After-Sale Service Manual*

Tutorial Video

Besides the above profiles, ProDrone also prepares tutorial video for you.

You can visit www.prodrone-tech.com or scan the following QR code to watch and download the tutorial video to better learn how to use the aircraft.



App Download

To ensure the best experience, please scan the QR code with your mobile device, download and install the ProFlight App.



For best experience, following devices are suggested to use:

IOS: iPad3、iPad4、iPad_Air、iPad_Air2、iPad_Mini、iPad_Mini2、iPad_Mini3、iPad_Pro.

Android: Samsung tabs 705c、Samsung S6、Samsung S5、Samsung NOTE4、Samsung NOTE3、HUAWEI Mate 7、HUAWEI P8、HUAWEI Honour 6、HUAWEI Pad、Google Nexus 9、Google Nexus 7 II、Ascend Mate7、Nubia Z7 mini、SONY Z3 EXPERIA、MIUI 3、MIUI4、MIUI PAD.

※ **The supported device list will keep update.**

Register

To enjoy perfect after-sale services, please complete your register by visiting www.prodrone-tech.com. Registering or not will not affect product's normal use, but we still invite you to be our VIP. Unscheduled official activities and more privileges have been prepared for you, stay tuned!

※ **Your registration information would be kept strictly confidential.**

Aircraft



- | | | |
|-------------------------|----------------------------|--------------------------------------|
| ① Nose LEDs | ⑤ Battery Hatch | ⑨ Micro-USB Interface |
| ② Tail LEDs | ⑥ Power Button | ⑩ Vision Positioning System |
| ③ Foldable Landing Gear | ⑦ Motors | ⑪ Dropping Box Interface |
| ④ Foldable Propeller | ⑧ Battery Level Indicators | ⑫ HD Video Download System Interface |

※ Only Advanced and Premium versions have the capacity of 'Visual and acoustic positioning'.

※ Only Premium version is equipped with the 'Dropping Box'.

Flight Mode

ProDrone Byrd supports the following three modes:

1. P-Mode (Positioning Mode)

When the GPS signal is good, the GPS module is used to position;

When the GPS signal is not good enough or is lost, it will turn to the visual and acoustic positioning;

When both GPS positioning and the visual and acoustic positioning do not work, only the attitude stabilization is provided.

2. F-Mode (Course Lock Mode)

In recording the flight direction, its forward direction is that of the aircraft head. In flight, the flight direction and the forward direction have no relationship with the change of that of the head. You need not care about the direction of the head and you can conveniently control the flight. This mode relies on GPS data, so please use it when GPS signal is good.

3. A-Mode (Attitude Mode)

GPS positioning and the visual and acoustic positioning are not used and only the attitude stabilization is provided.

※ **The switch of flight mode on the remote controller could be used to switch the mode of the aircraft.**
Please read [‘the switch of flight mode’](#) for more details.

RTH Mode

ProDrone Byrd has the function of returning to home automatically. If the home point is recorded successfully before the flight and when the remote controller and the aircraft loss connection, the aircraft would return to the home point automatically and land on the ground. The following three conditions would cause the returning: returning to home instantly, returning to home in low battery and returning to base when the aircraft is out of touch.

1. Home Point

Home point refers to the point at which the aircraft has been unlocked for the first time successfully, when it is in Mode P and the GPS signal is good. Home point is only effective for the flight at this time.

2. RTH Mechanism

When this mechanism is started, the red LED indicator light at the head of the aircraft keep on and the blue LED indicator light at the end keep on. At this moment, the aircraft will rise or descend to the pre-set height (if the current height is lower than the pre-set height, the aircraft will rise to the pre-set height; if it is higher, and the aircraft will descend to the pre-set height). And it will fly to the point above the home point and hover for five seconds and then it will slowly land to the ground.

- ※ **In returning to home, the aircraft could not keep away from barriers automatically. Please change the set of returning height according to actual conditions to ensure the flight security.**
- ※ **Please connect the parameter adjustment software of the flight control system to set the returning height.**

3. RTH Instantly

During the flight, click the 'Return to home' button in the remote controller or the 'Return to home' icon in the APP interface, the aircraft will return to home automatically. (Click [Return to Home Instantly with the Remote Controller](#) and [Return to Home Instantly with the APP](#))



4. RTH in Low Battery

There are two mechanisms in this condition, including forewarning for the low battery and returning to home in serious low battery.

- **Forewarning for Low Battery**

When the electric quantity is less than 30%, the forewarning for the low battery will be triggered.

And APP will alarm the warning tone to suggest you to return to home as soon as possible.

- **RTH in Severe Low Battery**

When the electric quantity is less than 20%, the battery is serious low and the aircraft will return to home mandatorily.

5. RTH in Lose Control

In normal conditions, the GPS signal is good, the compass works normally and the aircraft could record the home point successfully. If the signal between the remote controller and the aircraft is interrupted, the aircraft will stay hovering. If the signal interruption lasts for over three seconds, the aircraft will return to home automatically. In returning, if the signal is back to normal, the returning will be stopped automatically and you can operate the aircraft again.

※ **When the GPS signal is not good enough or there is no GPS signal, the aircraft could not return.**

Follow Me

This intelligent tracking mode is also called Follow Me Mode. When the aircraft is in Mode P and

when the GPS signal is good, press the icon  the aircraft will be in the intelligent tracking mode and will follow you (your mobile device) to fly at the height of 5 meters.

※ **The moving speed of the mobile device at the ground should not be over 15m/s. Or, the aircraft is unable to follow you (your mobile device).**

※ **Since the height of tracking could not be changed, the aircraft might run into barriers in its tracking. Therefore, it is suggested to operate this tracking function in an open and broad ground.**

Indicators of Aircraft Status

The flight status of the ProDrone Byrd could be judged from the two groups of LED indicator lights at the head and the end of the aircraft. Their places are shown in the following picture.

The two groups of LED indicator lights show the current status of the flight control system through different groups of colors and flickers. See the following table for more details.

	LED 1	LED 2	LED 3	LED 3	Definition
Normal State	● Red light on	● Red light on	○ Green light blinks	○ Green light blinks	Ready to Fly (P mode)
	● Red light on	● Red light on	○ Yellow light blinks	○ Yellow light blinks	Ready to Fly (A mode)
	● Yellow light on	● Yellow light on	○ Yellow light blinks	○ Yellow light blinks	Compass Calibration (Horizontal)
	● Green light on	● Green light on	○ Green light blinks	○ Green light blinks	Compass Calibration (Vertical)
Abnormal State	● Red light blinks fast	● Red light blinks fast	○ Yellow light blinks	○ Yellow light blinks	Low battery
	● Red light blinks fast	● Red light blinks fast	○ Red light blinks	○ Red light blinks	Serious low battery
	● Yellow light blinks fast	● Yellow light blinks fast	○ Yellow light blinks	○ Yellow light blinks	Losing connection with the remote controller
	● Yellow light blinks fast	● Yellow light blinks fast	○ Red light blinks	○ Red light blinks	Return to home automatically

Vision Positioning System

This positioning system consists of the visible light camera and the ultrasonic module. The former is used to obtain the position information of the flight to provide reference for the horizontal direction of the aircraft. And the latter could judge the current flight height to provide reference for the height from the ground to realize the flight at a certain height.

This system is adaptable to the environment in which the height is lower than 6 meters, where there is no GPS signal or the GPS signal is not good enough. It could be especially used for indoor flight.

The precision of the visual and acoustic system is prone to be affected by the illumination

intensity and the surface texture of articles. And the ultrasonic could not measure the distance in certain damping materials. If both vision and ultrasonic do not work, the flight mode will be turned into the Attitude mode automatically. Therefore, please notice the following conditions in flight:

- The normal flight height of this system ranges from 0.2m to 6m. Please stay in this range when the aircraft is used indoor;
- The illumination condition is 10 lux–100000 lux;
- Within the required range of the illumination conditions, all textures could be used to position the flight except pure colors (such as pure black, pure red, pure white and pure green);
- Be cautious on the surface where there is intensive reflect lights or inverted images;
- The flight speed should not be too fast and the highest speed should be no more than 8m/s.
- The maximum flight inclination should not be more than 30°.
- The range of flight temperature is -10°C-55°C.
- The flight altitude should not be more than 4000 meters.

※ **In Mode P and when the GPS signal is lost or not good enough, the system will turn to the visual and acoustic positioning mode and no manual operation is needed.**

※ **This system is only open to ProDrone Byrd Advanced/Premium version.**

Stowage Dropping

ProDrone Byrd could be loaded with loads less than 500g (not including the gimbal and the camera) to eject objects from a long distance.

Before the ejection, the buttons C1 and C2 should be customized to choose the 'steering gear control' in the APP setting interface (see Pxx for more details). The objects to be ejected are to be put into the container carrier and the container is inserted into the steering gear hole. Operate the aircraft to the place above the ejection point and press C1 or C2 button to let the container break away from the aircraft. The ejection is finished.

※ This system is only open to ProDrone Byrd Premium version.

Remote Controller

The remote controller belongs to the advanced wireless communication system of automatic frequency jump. It could realize the real time control of three degrees of freedom to the aircraft within the control distance (decided by the actual environment). Besides, it supports several aircrafts to work at the same time within the same airspace.

The highly integrated wireless high-definition video transmission system within the controller is connected to the ProDrone APP by WIFI. In this way, you can watch the real time video in your personal mobile equipment (mobile phone or table computer). All parameters of the aircraft would also be fully showed in the screen of your mobile equipment. The advanced innovative ideal of folding and delicate ergonomic design would also make you love this product.



- ① Mobile Device Holder
- ② Antenna
- ③ Control Sticks
- ④ Take Off Button
- ⑤ Power Button
- ⑥ Gimbal Position Reset Button
- ⑦ Video Recording Buttons
- ⑧ Gimbal Dial for Pitching
- ⑨ Customizable Button C2
- ⑩ Handle Bar
- ⑪ Lanyard Hole
- ⑫ Return to Home Button
- ⑬ Battery Level Indicators of the Aircraft
- ⑭ Remote Controller Status LED
- ⑮ Micro-USB Port & Charging Port
- ⑯ Equipment Support Lock
- ⑰ Flight Mode Switch
- ⑱ Shutter Button
- ⑲ Gimbal Dial for Yawing
- ⑳ Customizable Button C1



HD Video Downlink System

ProDrone Byrd series products are equipped with the image transmission of high definition module which consists of the aircraft end and the remote controller end. And it could be used in real-time transmitting of 50 frames of 1080P video (P mode). This image transmission of high definition module in ProDrone Byrd Standard adopts common WIFI system and the transmitting distance is 500 meters. This image transmission of high definition module in ProDrone Byrd Advanced/Premium adopts OFDM system and the transmitting distance is 2000 meters.

Gimbal Control

The control dial wheels for the gimbal yaw and pitch could control the yaw and pitch. The Back-to-center button of the gimbal could let the gimbal return to the initialization place.

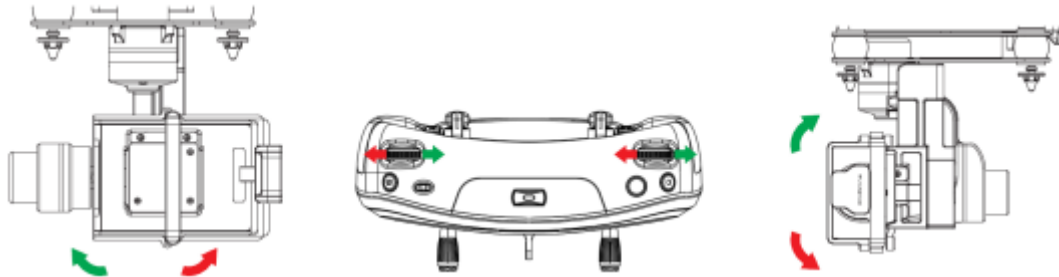

※ The type of the gimbal in the above picture is only for indication. Different types of gimbals are used for different aircrafts with different configurations.

Aircraft Operation

The remote controller supports three operation modes: American customization, Japanese customization and Chinese customization. Definitions of the control sticks of the three modes are as follows:

1. American Customization: throttle and yaw for left hand and pitch and row for right hand.
2. Japanese Customization: pitch and yaw for left hand and throttle and row for right hand
3. Chinese Customization: pitch and roll for left hand and throttle and yaw for right hand

The default operation mode of the remote controller is the ‘American customization’. You can change the mode by the parameter adjustment software or in the ‘Control setting’ interface of the APP. (See [APP Settings of the Operation Mode](#) for more details.)

Link

When the remote controller is delivered, the frequency adjustment between the remote controller and the internal receiver of the aircraft has been finished and you can use it directly. If the aircraft or the remote controller is replaced, the frequency adjustment should be made again. And the steps are as follows:

1. Turn on the powers of the remote controller and the aircraft respectively.
2. Press and hold the 'Return to home button' in the remote controller and then press the 'the power switch' button in the remote controller. At this moment, the remote controller gives a warning tone, the red LED indicator light is on, and the four indicator lights of the power of the aircraft in the remote controller flicker sequentially.
3. Press the power button of the aircraft for five times and wait for several seconds to finish the frequency adjustment. At this time, the green LED indicator light showing the status of the remote controller is on.

Gimbal

There are a total of three types of gimbals for ProDrone Byrd series products, and completely new integrated control algorithm is applied to them, making the high definition three-axle stabilization gimbal. The jittering of the angel is $\pm 0.05^\circ$. Therefore, when the big maneuvering flight is made, stabilized pictures and videos could also be shot.

According to the design philosophy of ProDrone Byrd series, the unmanned aircraft consists of the platform and the load mission. Three types of gimbals could be used in any type of platform to meet your needs.



※ After powering on, the gimbal and the camera will work automatically. The real-time image will be sent to the remote controller.

Byrd-001 Gimbal

The standard configuration of ProDrone Byrd Advanced is Byrd-001 multi-function gimbal (without the camera). You can buy the gimbal according to your own needs.

What's more, Byrd-001 Gimbal can realize the controllable two-axle of pitch and yaw, providing you broader shooting angles.

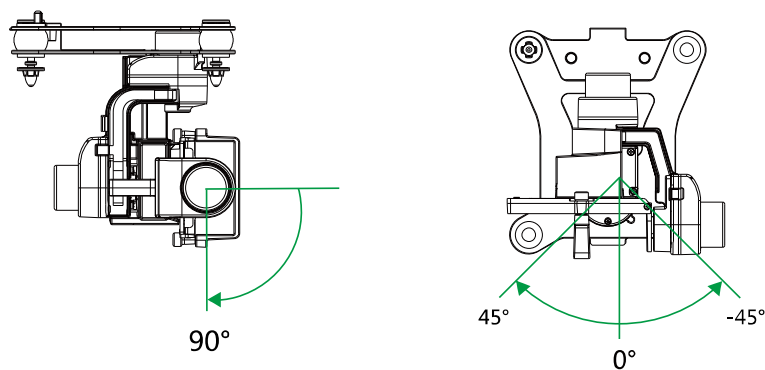

Byrd-002 Gimbal

The standard configuration of ProDrone Byrd Standard is the Byrd-002 integrated camera gimbal.

The independently developed 1080P high definition sports camera is carried on this gimbal. And it could record and shoot 1080P high definition videos and 16 mega-pixel photos. Besides, the camera and the gimbal are connected together and could not be dismounted.

What's more, Byrd-002 Gimbal can realize the controllable two-axle of pitch and yaw, providing you broader shooting angels.

Byrd-003 Gimbal

The standard configuration of ProDrone Byrd Standard is equipped with the Byrd-003 integrated camera gimbal. The independently developed 1080P high definition sports camera is carried on this gimbal. And it could record and shoot 1080P high definition videos and 16 mega-pixel photos. Besides, the camera and the gimbal are connected together and could not be dismounted.

What's more, Byrd-003 Gimbal can realize the controllable two-axle of pitch and yaw, providing you broader shooting angels.

WiFi Connection and Camera Use

After powering on, the gimbal and the camera will work automatically. The real-time image will be sent to the remote controller.

Start up the WLAN of the mobile device. And search and connect the WiFi pot of the remote controller. See the information on the label at the back of the remote controller for the pot name and its passwords.

In dismounting, press down the 'Equipment support lock' and pull the support upward.

※ **Before searching for the Wi-Fi pot, please turn on powers of the remote controller and the aircraft. If not, the mobile device could not show the Wi-Fi spot.**

Photograph/Video



The icons of Taking pictures/ Recording videos on ProFlight App have the same functions with those on remote controller. Click the button to start taking pictures/ recording video, and click again to stop.

ProFlight App

FCS Firmware Version Update

The ProDrone authority will continuously promote the update of the firmware in the flight control system. You need to download and install the 'Update tool of the firmware in the flight control system' on your own to update the firmware. The steps of using the software are as follows:

1. Visit www.prodrone-tech.com to download and install the latest firmware version in PC device.
2. Decompress the firmware file, finding and installing the drive that matching with your computer system.
3. After the drive installation, run the 'Updatetool.exe' under the installation directory to open the software.
4. Stay connected to the internet and click the auto update button, the software will download the related firmware version automatically.
5. Follow the prompt, making sure your aircraft power is shut down, and connecting the aircraft parameter adjustment port and PC with USB.
6. Confirm and start updating.
7. Update successfully, and close the software.

✘ **Make sure the power of the aircraft is turned off when connecting the 'FCS Firmware Update Tool'.**

✘ **The 'FCS Firmware Update Tool' could only be used at the PC device.**

ProFlight App

ProFlight APP is the interactive software which is specially designed for ProDrone Byrd series products. With this software, you could control the aircraft, the gimbal, the camera and the steering engine to take pictures, record videos, eject objects, and set parameters of the aircraft. To coordinate with the image transmission of high definition, it is suggested to be used on tablet devices or mobile phones with large screens to gain the best visual experience.

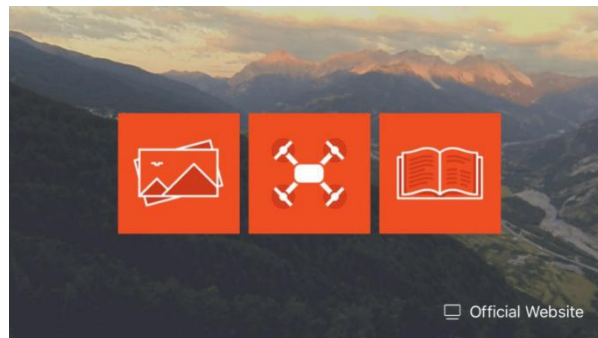

With rhythmic starting music and active animation, you will enter the Homepage of ProFlight APP. The three function icons in the Homepage are Replay of pictures, Flight interface, and Help profile.

1. Playback

Click the left icon, it will enter the playback interface. You could browse pictures and videos which are photographed before.

2. Help

Click the right icon, it will enter the Help interface. If your mobile device is connected to the internet, you could browse all instruction profiles and tutorial videos, which could effectively help you to use this product.

3. Flight Page

Click the middle icon, it will enter the Flight Page. In normal conditions, the real-time image transmitted from the aircraft will be shown in this Page.





- Flight Status Bar

: Show quantities of searched satellites;

: Show strength of WIFI signal of the remote controller;

Connected: Show the status of the connection between APP and the remote controller;

: Show the remained electricity quantity of the aircraft;

: Show the remained electricity quantity of the remote controller;

HT: -6.8 m: Show the current flight height;

None: Show the current flight mode;

DIS: N/A: Show the current flight distance.

- Return to Homepage



Click the  icon and it will return to Homepage of APP.

- Map Page



Click the  icon and it will enter the Map mode.

[1] Positioning



Click the  icon, the position of the aircraft will be shown in the center of the screen.



[2] Delete the Flight Points



Click the  icon and it will delete all the flight points.

[3] Flight Planning



After clicking the  icon, its background will turn to red , which means the function of planning the flight track has been activated. At this time, you can click anywhere on the map to form the flight dot. When the dots are confirmed, click the 'GO' at the bottom of the screen, the aircraft will fly to these dots according to their order.

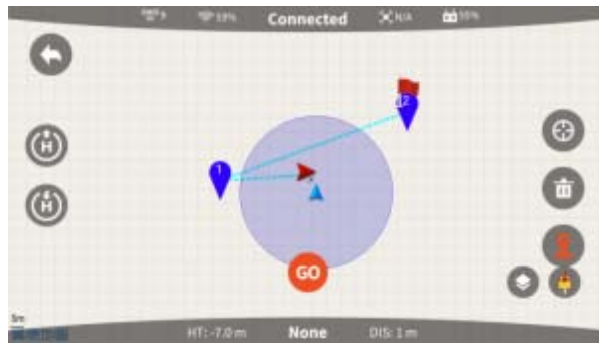

[4] Compass Display



Click the  icon to change the display mode of the compass between the fixed vision and the following version.

- Follow Me



Click the  icon to enter the intelligent tracking mode (Follow Me). See [Introductions of Intelligent Tracking Mode](#) for more details.

- Camera Setting



Click the  icon and the page of camera setting would appear. In this page, parameters of EV value, ISO, and white balance could be set.

- System Setting



Click the  icon and it will enter the interface of the system setting, which includes three pages of the control setting, the camera setting and the general setting.

In ‘Control setting ’ page, three operation modes could be chosen: Japanese customization, American customization, and Chinese customization.

To the right page, you can enter the ‘Camera Settings’. In this page, settings could be made for the photo format, video format, whether to reserve local copies and the resolution ratio of the video.



(Need the aircraft is on power) .

Continue to the right page, you can enter the ‘General Settings’. In this page, settings could be made for units of the parameters, whether to show the grid, whether to show the flight track and whether to broadcast the sound effect. What’s more, formatting could be made for the SD card of the camera.

- Take Off Button

With the premise of unlocking the aircraft, this function could only be used in Mode P. In Mode P



and after the unlocking, click the icon  (or the  button in the remote controller), and the aircraft will fly automatically to 4 meters high from the ground and stay hovering.

- RTH Button



Click the  icon, the aircraft will return to home automatically, which has the same function

of the  in the remote controller.

- Photograph/Video

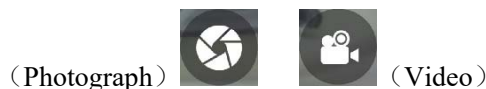

The icons of Taking pictures/ Recording videos on ProFlight App have the same functions with those on remote controller. Click the button to start taking pictures/ recording video, and click again to stop.

- ※ **The language in the APP interface is the same with that in the system of the mobile device. If you want to change the language, please first change that in the system.**

Assembling

Aircraft Preparation

Unfold the aircraft arm and the food stools are unfolded to the limited places shown in the picture. And make sure that the places after unfolding are in geometrical symmetry.

- ✘ **In unfolding, please control the strength of rotating the arm and the stool. Stop unfolding after they are in the limited places.**
- ✘ **In folding, please make sure the rotation is in the right direction. If it is in the wrong direction, the limit structure would be damaged.**

1. Propellers Installation and Dismounting

Foldable propeller is used in ProDrone Byrd. The two types of Propeller A and Propeller B are corresponding to the different rotation directions of the motor.

Letters A and B are signed respectively on the root of the propeller, in the internal surface of the propeller cap, and the motor rotor. Make sure signs of the three are the same in the installation and dismounting.

In installation, choose the same type of propeller with that on the motor. Put the side with the letter up and insert it to the spacer pin of the propeller in the electric motor. Press the performing of the propeller to the card slot of the motor spindle in the direction vertical to the spacer pin. Rotate the performing for 90° to align the hole sides at two ends with the spacer pin and press it in. In the end, rotate the propeller cap according to the direction shown in the cap.

In dismounting, take down the propeller cap according to the direction shown in the cap. Lift the propeller cap up slightly and rotate it for 90° to take down the performing. In the end, take down the propeller.

- Anti-Shooting Propellers

The anti-shooting propeller serves as the second security assurance besides the self-locking design

of the propeller cap. Even if the cap falls off in flight, this mechanism could effectively prevent the paddle from being ejected out. The card slot in the performing coordinates with that in the motor spindle. Only when the performing is rotated to certain angel, it could be taken down from the spindle.

2. Battery Installation and Dismounting

A high capacity Li-polymer battery, whose capacity is 7000mAh and voltage is 14.2 V, is used in this aircraft. The snap joint design is used here and you can snap the battery into the battery cabin in the direction shown in the following picture. After installation, tighten the cover of the battery cabin.

After flight, please take down the battery. Take down the cover and press the snap joints at two sides of the battery at the same time. You can dismount the battery.

- ※ **Please turn down the power of the aircraft before taking down the battery.**
- ※ **The battery contains the dangerous chemical. Please read the *Battery Safety Guidelines* and other Matters need attention printed on the surface of the battery carefully before using the aircraft.**

3. Gimbal Installation

Insert, with a diagonal angle, the plug of the butt strap of the gimbal into the card slot at the bottom of the aircraft. Pull to open the snap joint of the spring at the bottom of the aircraft. Press the other end of the gimbal into the snap joint to connect the gimbal and the bottom surface of the aircraft. Unclamp the snap joint to check whether the gimbal has been fixedly installed.

- ※ **The type of the gimbal in the above picture is only for indication. Different types of gimbals are used for different aircrafts with different configurations.**
- ※ **The gimbal is precise equipment and its performance would be reduced by crash or strong force. Therefore, please pay special attention to the gimbal.**
- ※ **Do not move the aircraft while the gimbal is on self-checking.**
- ※ **Before installing and dismounting, please turn off the power of the aircraft. It is forbidden to install or dismount the gimbal with the power on.**

4. Dropping Box Installation and Dismounting

There is a plug at the top of the container. Insert it to the steering gear hole at the bottom of the end of the aircraft and the installation is finished.

In dismounting, the powers of the aircraft and the remote controller should be turned on. And then the ejection would be carried out (See Pxx for more details) and the container would break away from the aircraft.

5. ON/OFF

Press the power switch of the aircraft for three seconds, and it will be turned on. Repeat this operation and the aircraft will be turned off.

6. Aircraft Battery Check

There are two methods to examine the electric quantity:

- After turning on the power switch of the aircraft, you could see the remained electric quantity by observing the LED indicator lights.



LED1	LED2	LED3	LED4	Current battery level
● Green	● Green	● Green	● Green	75%~100%
● Green	● Green	● Green	○ OFF	50%~75%
● Green	● Green	○ OFF	○ OFF	25%~50%
● Red	○ OFF	○ OFF	○ OFF	0%~25%

- After turning on the power switches of the aircraft and the remote controller, you could see the remained electric quantities by observing the LED indicator lights for the aircraft in the remote controller.

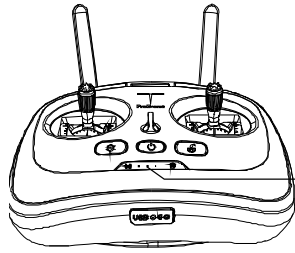

LED1	LED2	LED3	LED4	Current battery level
●Green	●Green	●Green	●Green	75%~100%
●Green	●Green	●Green	○OFF	50%~75%
●Green	●Green	○OFF	○OFF	25%~50%
●Red	○OFF	○OFF	○OFF	0%~25%

7. Charging

The power battery of could not be charged when it is in the aircraft. Please take it down from the aircraft and charge it with the charger. It takes about 2.5 hours to finish the charging.

In charging, the LED indicator light in the charger is red. When the light turns green, it means the battery has been fully charged. Please disconnect the charger timely.

- ※ **Make sure to use the original charger to charge the battery and the remote controller. ProDrone will shoulder no responsibilities if faults and damages are caused by not using the original accessories.**
- ※ **If the type of the charger plug does not match with that of the power plug, please visit the official mall to buy the same type of the power line.**

Remote Controller Preparation

1. ON/OFF

Press the power switch of the remote controller for three seconds, and it will be turned on. Repeat this operation and the remote controller will be turned off.

2. Battery Check

The electric quantity of the remote controller is shown through the color of the back light of the power switch. If it is green, it means the electric quantity is enough for the flight; if it is red, it means the quantity is not enough and it needs to be charged.

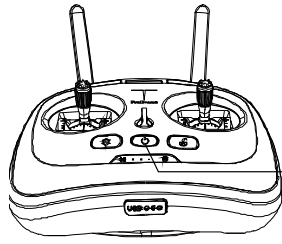

Indicator status	Current battery level
● Green light on	40%~100%
◉ Green light on	15%~40%
● Red light on	0%~15%

3. Charging

The remote controller could be charged no matter it is on or off, but it is suggested to charge it when it is off.

In charging, you could judge whether it has been fully charged by the color of the LED indicator light of its electric quantity. If the red light flickers, it means it is being charged. If the green light flickers, it means it has been fully charged. It needs about five hours to finish the charging and the remote controller could be used for about two weeks.

- ※ **Make sure to use the original charger to charge the battery and the remote controller. ProDrone will shoulder no responsibilities if faults and damages are caused by not using the original accessories.**
- ※ **If the type of the charger plug does not match with that of the power plug, please visit the official mall to buy the same type of the power line.**

4. Antenna Placement

Please hold the antenna in the direction shown in the following picture.

The remote controller will receive signals of different strengths if the antenna is placed in different positions. Therefore, please keep the antenna in parallel with the screen of the mobile device. In flight, the direction of the antenna needs to be changed to keep the aircraft always in the communication range.

- ※ **When using the remote controller, please keep it away from the human body (especially the head) for at least 20 centimeters in case that the antenna and the transmitter module might influence the body.**

5. Mobile Device Holder Installation and Dismounting

Unfold the joint lever of the support of the mobile device to the limited position and insert it downward to the installation hole. And adjust the seat to put the device in a secure and fixed place.

Start up the WLAN of the mobile device. And search and connect the WiFi pot of the remote controller. See the information on the label at the back of the remote controller for the pot name and its passwords.

In dismounting, press down the 'Equipment support lock' and pull the support upward.

※ **Before searching for the Wi-Fi pot, please turn on powers of the remote controller and the aircraft. If not, the mobile device could not show the Wi-Fi spot.**

Flight

Safety Alarms

1. Environment

- Do not fly in severe weather such as rain, thunder, high wind, snow, heavy fog, deep cold, the sand and dust weather.
- Do not fly between the high buildings. In this condition, the signal would be shielded, so the GPS is unable to locate the aircraft. Choose an open ground where there are no high buildings around to fly.
- Stay in the sight in flight and stay away from barriers, people and waters.
- Do not fly in places where there are communication base stations of high-tension cable or launch towers to avoid the interference of the signals from the remote controller.
- When the aircraft is flying above 4000 meters, the motor and the propellers could not work normally because of environmental factors. And the flight performance of the aircraft would be seriously influenced, so be cautious.
- Do not fly in the regions which are limited according to related laws and regulations.

2. Attentions

- Do not fly when there is interference of other same frequency wireless signals nearby.
- Do not answer the telephone or make telephone calls in the flight. Keep close attention to the display of the APP interface to secure the flight.
- Return to base and land as soon as possible when receiving the signal of the low electric quantity alarm;
- The aircraft will land by themselves when receiving the signal of the serious low electric quantity alarm. The user could control the aircraft to fall down to safe places;
- Turn off the motive power source first and then do other operations after the flight is landed.
- Do not stop the electric motor arbitrarily in non-emergency conditions. This is because the falling down of the aircraft will injure others.
- The propeller is very dangerous for it is in high speed revolution in the flight. The aviator should keep safety distance with the aircraft to avoid being injured.

Pre-Check

- Check whether each spare part is in good condition. If there is any crack or damage, please stop

the flight.

- Check whether the electricity quantities of the battery and the remote controller are full enough to support the flight.
- Make sure the engine arm and the foot stool are in place, and the propeller has been fixedly installed.
- Check whether the connection between the remote controller and the aircraft is normal.
- Check whether all firmware versions are the latest. And check whether the APP and the remote controller are connected normally.
- Check whether the electric motor and the gimbal are working normally after it is electrified.
- Make sure that the SD card has been inserted into the camera.

Accelerator Calibration

When the aircraft leaves the factory, the accelerometer has already been calibrated. It is suggested to calibrate it again before the first flight to ensure the flight security according to the following steps.

- Visit www.prodrone-tech.com to download and install the 'Byrd Parameter adjustment software of the aircraft' on the PC end.
- Connect the parameter adjustment port of the aircraft with the PC, the parameter adjustment software would identify the hardware of aircraft automatically.
- Put the aircraft horizontally, enter the preface of 'Accelerometer' in the parameter adjustment software, and click the 'Click to start the single axis calibration'.
- Wait for three seconds and the calibration is finished.

✘ **Make sure the aircraft has been turned off before it is connected to the PC.**

Compass Calibration

- Power on the remote control and then the aircraft. At this time, the aircraft will start a self-check and a series of beeps will sound.
- After the beep stops, toggle the "Flight Mode Switch" back and forth for several times. Observe the color of the LED indicator light in the aircraft and stop toggling when the yellow LED indicator light at the head of the aircraft is on and the yellow light at the tail flashes slowly.

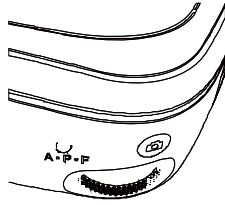

- Hold the aircraft upside down and rotate it clock-wisely and **HORIZONTALLY**. Observe the color of the LED indicator light in the aircraft and go to the next step when the yellow LED indicator light at the head of the aircraft keep on and the green light at the tail flashes. Otherwise, please return to the step 2.

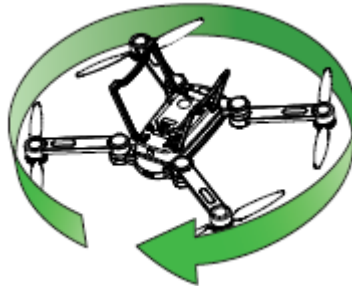

- Hold the aircraft with its **HEAD DOWN** and rotate it clock-wisely and **VERTICALLY**. Observe the color of the LED indicator light in the aircraft, the compass calibration is successful when the yellow LED indicator light at the head of the aircraft and the green light at the tail keep on. The compass calibration is not so good while all the yellow lights keep on. You'd better calibrate the compass once more. Otherwise, please return to the step 2.

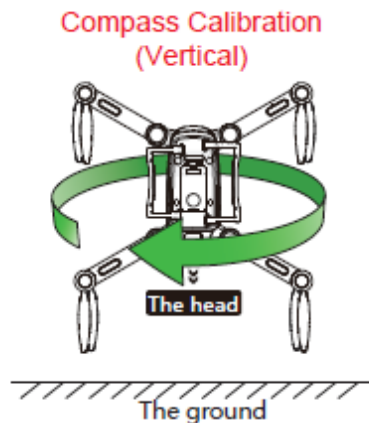

- ✘ **Do not move the aircraft during the self-check startup.**
- ✘ **When the aircraft is used for the first time or it is used in a new place, please calibrate the compass.**
- ✘ **Do not calibrate the compass indoor, or near large metal objects, or in the place where there may be high magnetic fields.**
- ✘ **When calibrating the compass, do not carry the mobile phone, hand-watch, keys and other metal objects.**
- ✘

Take Off

You could choose to press the 'Take off' button (See Take off button for more details) or to start up the flight by hand. After calibrating the compass, move the control stick in the toe-in directions. After the motor is started, loosen two sticks at the same time to unlock the motor. At this time, push the throttle rod upward slowly and the aircraft will take off.

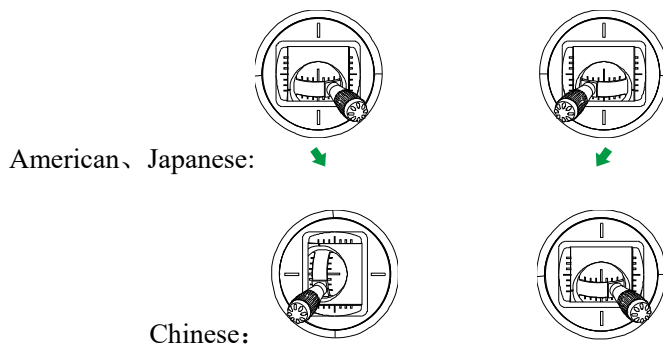

- ※ **Before the flight, please put the head of the aircraft forward and keep over three meters away from the aircraft.**
- ※ **Do not unlock the aircraft in slopes with big angles of inclination.**

Landing

During the flight, push the throttle rod downward slowly and the aircraft will land slowly. At this time, push the rod to its lowest place and hold for several seconds until the motor stop, and then loosen the rod to lock the aircraft.

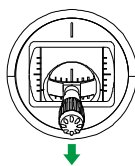

Questions

1. What is the control distance of the remote controller? How the aircraft, the mobile phone and the remote controller are connected?

The control distance of the remote controller is 2000 meters (this distance would also be influenced by the environment). The mobile phone and the remote controller are connected by WIFI and the aircraft and the remote controller communicate with each other by radio waves.

2. What are the endurance, capacity and type of the battery?

The endurance of the Standard version is 25 min, and of the Advanced version and Premium version are 29min. The capacities of the three versions are all 6700mA, and 14.8 V.

3. What are the type and the pixel of the camera? (Could it be replaced by other cameras?)

Products with different configurations are equipped with different cameras. The Standard version is equipped with 1080P integrated camera gimbal and the camera could not be replaced. The Advanced version is equipped with multi-function gimbal (without the camera) . And the Premium version is equipped with a 4K integrated camera gimbal and the camera could not be replaced.

4. What is the maximum load of the aircraft?

The maximum load of the aircraft is 500g. And the endurance of the aircraft would be reduced if it is flying with load.

5. Does it have the function of transmitting real-time image?

The aircraft is equipped with high definition image transmission module and can transmit high definition image in real time. The transmission distance of Standard version is 500m, and the distances of Advanced and Premium versions could be as long as 2000m.

6. Could this camera take pictures or record videos at night?

There is the LED indicator light of status in the airplane arms, so the direction of the aircraft head could be judged correctly and it could fly at night. Whether the camera could take pictures or record videos at night is decided by whether the camera supports this function or not.

7. What will happen if the aircraft is battery low in flight? What will happen if there is telephone call in flight? What will happen if the aircraft flies beyond the control range? What will happen if it flies so far that there is no image transmission and there are barriers? Does it have the function of keeping away from the barriers?

The aircraft has the function of returning to home automatically in low battery. When there is

telephone call in flight, APP will operate in the backstage automatically and carry out your order continuously. However, it is not suggested to receive or make telephone calls. If the aircraft flew beyond control, the function of returning to home automatically will be triggered. When it flies beyond the distance of transmitting images, please stop all operations and return to home. This product could not keep away from barriers automatically, but we will consider adding this function in the future products.

8. How to download ProFlight APP?

You can visit www.prodrone-tech.com or scan the two-dimension code in the instruction profile to download ProFlight APP.

9. Whether it could take off in windows of high buildings or in comparatively narrow spaces? (Whether it only could take off in flat ground?)

Yes, it could. However, the signals might disappear in high buildings, which is to the disadvantage of flight. For your and others' personal safety, it is suggested to let it take off in an open place and keep it fly below the height of 120 meters.

10. There is loud noise in flight. Is it normal?

The noise of the aircraft has directly relationship with the rotation speed of the propeller and the performance of the aircraft. Please understand that, the huge redundancy of the power system is definitely accompanied by unpleasant noise. We will consider adding silencing instruments in the future products.

11. What's the GPS precision of the map in the mobile phone?

It is decided by the precision of the GPS module of your mobile phone.

12. What is the highest flight speed of the aircraft?

The highest vertical speed is 6m/s, and the highest horizontal speed is 15m/s.

13. Will the aircraft return to home automatically if its battery is low?

There are two low battery alarming mechanism. When the rest electricity quantity is 20%, the low battery alarm will be triggered and APP will remind you to return to home. If you continue to fly, the serious low battery alarm will be triggered in several minutes. At this time, the aircraft will return to home mandatorily.

14. How dose APP control the aircraft?

The control instructions of the APP are transmitted to the remote controller by WIFI and to the aircraft by the remote controller. Please read the help profiles in the first page of APP or read the

tutorial video in ProFlight APP.

15. What is the shooting time of the camera?

The camera relies on the battery loaded in the aircraft for power supply. Therefore, the shooting time is decided by the endurance of the aircraft and the memory capacity of the SD card.

16. Will there be a memory card in the products we buy?

There will be a 16G memory card for the standard configuration of the Standard version and a 64G for the Premium version. Visit www.prodrone-tech.com for more accessories.

17. What kind of motors are your products using?

The high-performance brushless motor which is developed especially for this product is used in the power system. Its service life could be as long as 40,000 hours. Each motor has undergone serious routine inspection and its performance is reliable and stable.

18. Why i could not unlock the aircraft?

Watch the status indicator light of the remote controller to check whether the connection between the remote controller and the aircraft is normal. The aircraft could not be unlocked if the magnetism check is unsuccessful, if there is interference of strong magnetic, if the GPS signal is not good enough, and if the GPS precision does not meet the requirements.

19. Will it show my place only if I turn on the WIFI and connect it to the internet?

Yes. The place of operator is positioned by the GPS in the mobile phone and the place of the aircraft is positioned by the GPS loaded in the aircraft. The information of the two places are transmitted to the APP by the remote controller and are shown in the APP interface.

20. What is the material of the gimbal? And what is the control range of the pitch?

This aircraft is equipped with a three-axle high definition gimbal developed by ProDrone. It is made of light aluminum alloy. The three types of gimbals are two-axle controllable. Their controllable pitch range is -125° - 30° and their controllable yaw range is -30° - 30° .

21. What's the material of the body of the airplane? Is break-resistant?

The body of aircraft is made of compound materials of high strength. It has been testified that the aircraft still keeps comparatively integral structure when it falls from a several meters high place.

22. Is the APP adaptable to any operation system of the mobile phone?

Currently, ProFlight APP could only be used in mobile phones with versions more advanced than Android 4.0 and IOS 8.0.

23. What are the meanings of the red full lines and blue dotted lines in the map in the APP of the mobile phone?

The red full lines show the flight track while the blue dotted line show the flight lines made by the planning function of flight track.

24. How to charge the power battery?

Connect the battery and the charger and connect the charge with the 220 V power source to start the charging. When the LED indicator light in the charger is red, it means the battery is being charged; when the light is green, it means the battery has been fully charged.

25. What will the aircraft do if the mobile phone is power off?

If the mobile phone is power off, you only could not see the images sent by the image transmission, but the remote controller could control the aircraft normally.

26. Why there are tweet sounds after turning on the power for a short time? Is it normal?

After turning on the power and there is no instruction for a long time, there will be tweet sounds. This is normal and will happen in 12 minutes after turning on the power.

Specifications

ProDrone Byrd Standard

● Aircraft

Weight	1890 g
Rated Load	200 g
Max. Load	500 g
Wind Resistance	3 Grade
Max. Ascent Speed	6 m/s
Max. Speed	15m/s
Hover Precision (P Mode)	±0.8 m (Vertical) ±1.0 m (Horizontal)
Max. Flight Altitude	4000 m
Endurance	25 min
Operating Temperature	-10°C to 50°C

● Gimbal

Controllable Angle Range	Pitching: -90° to 0° Yawing: -45° to 45°
--------------------------	---

● Camera

Image Resolution	1080P (16: 9) 720P (16: 9) 960P (4: 3)
Pixel	16 million
Video Format	.MP4 (H.264 codec) and .AVI
Picture Format	.JPEG.RAW
Sensor Type	CMOS

Frame Rate	1080P: 25/30/50/60fps 960P: 25/30/48/50/60fps 720P: 25/30/50/60/100/120fps
Field Angle (Opposite Angles)	1080P: 120° 960P: 140° 720P: 120°
Focal Length	3.64 mm
Photo Mode	16/14/12M (4: 3) Pixel
Supported SD Card Types	Support 32GB Micro-SD
Operation Temperature	-10°C to 50°C

● **Remote Controller**

Image transmission frequency	2412MHz-2462MHz
Digital transmission frequency	5745MHz~5810MHz
Max. Communication Distance	2000m
Battery Voltage	7.4V
Battery Capacity	5000mAh (2S)
Mobile Device Holder	Support Pad & Mobile Phone
Equivalent Isotropically Radiated Power (EIRP)	18mW
Operating Temperature	-10°C to 50°C

● **Charger**

Voltage/Current	16.8V / 2.5A (Battery) 16.8V / 1A (Remote Controller)
Rated Power	67.2 W

● **Battery**

Capacity	6700 mAh
----------	----------

Voltage	14.8V
Energy	99.16 Wh
Weight	560 g
Operating Temperature	0°C to 40°C

ProDrone Byrd Advanced

● Aircraft

Weight	1866 g
Rated Load	200 g
Max. Load	500 g
Wind Resistance	3 Grade
Max. Ascent Speed	6 m/s
Max. Speed	15m/s
Hover Precision (P Mode)	±0.2 m (Vertical) ±0.2 m (Horizontal)
Max. Flight Altitude	4000 m
Endurance	29 min
Operating Temperature	-10°C to 50°C

● Gimbal

Controllable Angle Range	Pitching: -90° to 0° Yawing: -45° to 45°
--------------------------	---

● Vision Positioning System

Velocity Range	< 8 m/s
Altitude Range	20 cm – 600 cm
Positioning Accuracy	±3.0 cm (Horizontal) ±2.54 cm (Vertical)
Operating Environment	Surface with clear pattern and Adequate lighting

● Remote Controller

Image transmission frequency	2412MHz-2462MHz
Digital transmission frequency	5745MHz~5810MHz

Max. Communication Distance	2000m
Battery Voltage	7.4V
Battery Capacity	5000mAh (2S)
Mobile Device Holder	Support Pad & Mobile Phone
Equivalent Isotropically Radiated Power (EIRP)	18mW
Operating Temperature	-10°C to 50°C

● **Charger**

Voltage/Current	16.8V / 2.5A (Battery) 16.8V / 1A (Remote Controller)
Rated Power	67.2 W

● **Battery**

Capacity	6700 mAh
Voltage	14.8 V
Energy	99.16 Wh
Weight	560 g
Operating Temperature	0°C to 40°C

ProDrone Byrd Premium

● **Aircraft**

Weight	1930 g
Rated Load	200 g
Max. Load	500 g
Wind Resistance	3 Grade
Max. Ascent Speed	6 m/s
Max. Speed	15m/s
Hover Precision (P Mode)	±0.2 m (Vertical)

	±0.2 m (Horizontal)
Max. Flight Altitude	4000 m
Endurance	29 min
Operating Temperature	-10°C to 50°C

● **Gimbal**

Controllable Angle Range	Pitching: -90° to 0° Yawing: -45° to 45°
--------------------------	---

● **Vision Positioning System**

Velocity Range	< 8 m/s
Altitude Range	20 cm – 600 cm
Positioning Accuracy	±3.0 cm (Horizontal) ±2.54 cm (Vertical)
Operating Environment	Surface with clear pattern and Adequate lighting

● **Camera**

Image Resolution	4K (16: 9) , 2.7K (16: 9) , 1440P (4: 3) , 1080P (16: 9)
Effective Pixel	12million
Video Format	.MP4 (H.264 codec) and .AVI
Picture Format	.JPEG & .RAW
Burst Shooting	30 pieces/s (12 million)
Aperture	F/2.8
Frame Rate	4K: 24/25/30 fps 2.7K: 25/50/60 fps

	1440P: 25/50 fps
	1080P: 25/30/50/60/120 fps
Field Angle	104° (Opposite)
	82° (Horizontal)
Distortion	<27%
Output Mode	USB
RAM	2GB flash + 8GB DDR
Supported SD Card Types	Support Maximum 64GB
Operation Temperature	-10°C to 50°C
● Remote Controller	
Image transmission frequency	2412MHz-2462MHz
Digital transmission frequency	5745MHz~5810MHz
Max. Communication Distance	2000m
Battery Voltage	7.4V
Battery Capacity	5000mAh (2S)
Mobile Device Holder	Support Pad & Mobile Phone
Equivalent Isotropically Radiated Power (EIRP)	18mW
Operating Temperature	-10°C to 50°C
● Charger	
Voltage/Current	16.8V / 2.5A (Battery)
	16.8V / 1A (Remote Controller)
Rated Power	67.2 W
● Battery	
Capacity	6700 mAh
Voltage	14.8 V

Energy	99.16 Wh
Weight	560 g
Operating Temperature	0°C to 40°C

FCC Compliance

FCC Compliance

This device complies with part 15 of the FCC Rules. Operation is subject to the following two conditions:

- (1) This device may not cause harmful interference, and
- (2) This device must accept any interference received, including interference that may cause undesired operation.

Changes or modifications not expressly roved by the party responsible for compliance could void the user's authority to operate the equipment.

FCC Warning Message

Any Changes or modifications not expressly roved by the party responsible for compliance could void the user's authority to operate the equipment.

This device complies with part 15 of the FCC Rules. Operation is subject to the following two conditions: (1) This device may not cause harmful interference, and (2) this device must accept any interference received, including interference that may cause undesired operation.

FCC Radiation Exposure Statement:

Aircraft

This equipment complies with FCC radiation exposure limits set forth for an uncontrolled environment. This equipment should be installed and operated with minimum distance 20cm between the radiator and your body. This transmitter must not be co-located or operating in conjunction with any other antenna or transmitter.

Remoter

This equipment complies with FCC radiation exposure limits set forth for an uncontrolled environment. This equipment should be installed and operated with minimum distance 10mm between the radiator and your body. This transmitter must not be co-located or operating in conjunction with any other antenna or transmitter.

Note: This equipment has been tested and found to comply with the limits for a Class B digital device, pursuant to part 15 of the FCC Rules. These limits are designed to provide reasonable protection against harmful interference in a residential installation. This equipment generates uses and can radiate radio frequency energy and, if not installed and used in accordance with the instructions, may cause harmful interference to radio communications. However, there is no guarantee that interference will not occur in a particular installation. If this equipment does cause harmful interference to radio or television reception, which can be determined by turning the equipment off and on, the user is encouraged to try to correct the interference by one or more of the following measures:

---Reorient or relocate the receiving antenna.

---Increase the separation between the equipment and receiver.

---Connect the equipment into an outlet on a circuit different from that to which the receiver is connected.

---Consult the dealer or an experience radio/TV technician for help.

