

# **Tsunami® 800 and 8000 Series (Point-to-point and Point-to-multipoint Products) Hardware Installation Guide**

## **Products Covered**

--> Tsunami® Multipoint

- MP-820-BSU-100
- MP-825-BS3-100
- MP-8100-BSU
- MP-8200-BSU; MP-8250-BS9; MP-8250-BS1
  - MP-820-SUA-50+
  - MP-825-SUR-50+
  - MP-825-CPE-50
  - MP-825-CPE-100
  - MP-8100-SUA
  - MP-8150-SUR
  - MP-8150-SUR-100
  - MP-8150-CPE
  - MP-8200-SUA
  - MP-8250-SUR
- MP-8160-BSU and MP-8160-BS9
  - MP-8160-SUA
  - MP-8160-CPE
  - MP-826-CPE-50

--> Tsunami Quickbridge®

- QB-8100-EPA / LNK
- QB-8150-EPR / LNK
- QB-8150-LNK-100
- QB-8150-LNK-12/50
- QB-8151-EPR / LNK
- QB-8200-EPA / LNK
- QB-8250-EPR / LNK
- QB-825-EPR / LNK-50
- QB-825-EPR / LNK-50+



---

## Copyright

© 2013 Proxim Wireless Corporation, Milpitas, CA. All rights reserved. Covered by one or more of the following U.S. patents: 5,231,634; 5,875,179; 6,006,090; 5,809,060; 6,075,812; 5,077,753. The content described herein are copyrighted with all rights reserved. No part of this publication may be reproduced, transmitted, transcribed, stored in a retrieval system, or translated into any language in any form by any means without the written permission of Proxim Wireless Corporation.

## Trademarks

Tsunami<sup>®</sup>, Proxim, and Proxim logo are the trademarks of Proxim Wireless Corporation. All other trademarks mentioned herein are the property of their respective owners.

## Disclaimer

Proxim reserves the right to revise this publication and to make changes in content from time-to-time without obligation on the part of Proxim to provide notification of such revision or change. Proxim may make improvements or changes in the product(s) described in this guide at any time. When using these device, basic safety precautions should always be followed to reduce the risk of fire, electric shock and injury to persons.

## Tsunami<sup>®</sup> 800 and 8000 Series - Hardware Installation Guide

Documentation Version: 5.1  
P/N 765-00132, April 2014

---

<b>Preface</b> .....	<b>6</b>
<b>1 Introduction</b> .....	<b>9</b>
About Tsunami® 800 and 8000 Series Products .....	9
Multiple-Input-Multiple-Output (MIMO) .....	13
<b>2 800 Series - Hardware Overview and Installation</b> .....	<b>14</b>
MP-820-BSU-100 / MP-820-SUA-50+ / MP-820-SUA-100/ MP-825-SUR-50+ / MP-825-BS3-100 / QB-825-EPR/LNK-50+ 14	
Hardware Overview .....	14
Gigabit Ethernet Port .....	15
Serial Port .....	15
Antenna Ports .....	16
Grounding Point .....	17
Product Package .....	17
Installation Procedure .....	19
MP-825-CPE-100/ MP-825-CPE-50 / QB-825-EPR&LNK-50 .....	28
Hardware Overview .....	28
Ethernet Port (PoE IN and Data).....	28
Grounding Point .....	29
Product Package .....	29
Installation Procedure .....	30
MP-826-CPE-50 .....	36
Hardware Overview .....	36
Ethernet Port (PoE IN and Data).....	36
Grounding Point .....	37
Product Package .....	37
Installation Procedure .....	38
<b>3 8000 Series - Hardware Overview and Installation</b> .....	<b>44</b>
MP-8100-BSU&SUA / MP-8150-SUR / QB-8100-EPA&LNK / QB-8150- EPR&LNK / QB-8151-EPR&LNK 44	
Hardware Overview .....	44
Gigabit Ethernet Ports.....	45
Serial Port .....	46
Antenna Ports .....	47
Grounding Points .....	47
Product Package .....	47
Installation Procedure .....	49
MP-8160-BSU / MP-8160-SUA / MP-8160-BS9 .....	58
Hardware Overview .....	58
Gigabit Ethernet Ports.....	58
Serial Port .....	59
Antenna Ports .....	60

---

Grounding Point .....	60
Product Package .....	61
Installation Procedure .....	62
MP-8150-CPE / QB-8150-LNK-12/50 .....	72
Hardware Overview .....	72
Ethernet Port (PoE IN and Data) .....	72
Serial Port .....	72
Grounding Point .....	73
Product Package .....	74
Installation Procedure .....	75
MP-8160-CPE-A100 .....	81
Hardware Overview .....	81
Ethernet Port (PoE IN and Data) .....	81
Grounding Point .....	81
Product Package .....	82
Installation Procedure .....	82
MP-8150-SUR-100 / QB-8150-LNK-100 .....	88
Hardware Overview .....	88
Gigabit Ethernet Port .....	88
Serial Port .....	89
Grounding Point .....	89
Product Package .....	90
Installation Procedure .....	91
MP-8200-BSU / MP-8200-SUA / MP-8250-SUR / QB-8200-EPA&LNK / QB-8250-EPR&LNK / MP-8250-BS9 / MP-8250-BS1 98	
Hardware Overview .....	98
Gigabit Ethernet Ports .....	98
Serial Port .....	99
Antenna Ports .....	100
Grounding Points .....	101
Product Package .....	101
Installation Procedure .....	103
<b>4 Technical Specifications .....</b>	<b>112</b>
Device Models .....	112
Accessories .....	116
OFDM Modulation Rates .....	118
Wireless Protocol .....	118
Interfaces .....	119
.....	119
Transmit Power Settings .....	120

---

Receive Sensitivity .....	123
Management .....	131
Power Supply .....	132
Hardware Specifications .....	135
Integrated Antenna Specifications .....	137
Physical Specifications .....	147
Environmental Specifications .....	148
MTBF .....	149
<b>A Appendix - Additional Weatherproofing Steps .....</b>	<b>150</b>
Material for Weatherproofing .....	150
Weatherproofing Steps .....	150
<b>B Appendix - Lightning Protection.....</b>	<b>152</b>
<b>C Appendix - Abbreviations .....</b>	<b>153</b>
<b>D Appendix - Statement of Warranty .....</b>	<b>154</b>
<b>E Appendix - Technical Services and Support .....</b>	<b>156</b>

# Preface

This chapter contains the following information:

- About this Guide
- Products Covered
- Audience
- Prerequisites
- Related Documents
- Documentation Conventions

## About this Guide

A comprehensive guide that provides an overview about the Tsunami® 800 and 8000 series products, their installation methods and hardware specifications.

## Products Covered

Product(s)	Supported Countries
MP-820-BSU-100	US, WD, EU
MP-825-BS3-100	US, WD, EU
MP-8100-BSU	US, WD, EU
MP-8200-BSU	US, WD, EU, JP
MP-8250-BS9	US, WD, EU
MP-8250-BS1	US, WD, EU
MP-820-SUA-50 <sup>+</sup>	US, WD, EU
MP-825-SUR-50 <sup>+</sup>	US, WD, EU
MP-825-CPE-50	US, WD, EU
MP-825-CPE-100	US, WD, EU
MP-8100-SUA	US, WD, EU
MP-8150-SUR	US, WD, EU
MP-8150-SUR-100	US, WD, EU
MP-8150-CPE	US, WD
MP-8200-SUA	US, WD, EU, JP
MP-8250-SUR	US, WD, EU, JP
MP-8160-BSU	WD
MP-8160-BS9	WD
MP-8160-SUA	WD
MP-8160-CPE-A100	WD

Product(s)	Supported Countries
MP-826-CPE-50	WD
QB-8100-EPA/LNK	US, WD, EU
QB-8150-EPR/LNK	US, WD, EU
QB-8150-LNK-100	US, WD, EU
QB-8150-LNK-12	WD
QB-8150-LNK-50	US, WD
QB-8151-EPR / LNK	US, WD
QB-8200-EPA / LNK	US, WD, EU, JP
QB-8250-EPR / LNK	US, WD, EU, JP
QB-825-EPR/LNK-50	US, WD
QB-825-EPR/LNK-50+	US, WD, EU

## Audience

The intended audience for this guide is the network administrator who installs and/or manages the device.

## Prerequisites

The reader of this document should have working knowledge of Wireless Networks, Local Area Networking (LAN) concepts, Network Access Infrastructures and Client-Server Applications.

## Related Documents



In addition to this guide, you can refer to the following documents that are available on the Proxim's support site at <http://my.proxim.com>

- **Quick Installation Guide (QIG)** - A quick reference guide that provides essential information to install and configure the device.
- **Software Management Guide** - A guide that provides step-by-step instructions to configure, manage and monitor the device by using Web Interface.
- **Reference Guide** - A guide that provides step-by-step instructions to configure, manage and monitor the device by using Command Line Interface (CLI).
- **Antenna Guides** - A guide that gives insight on the recommended antennas for your product and ways to align the antennas.
- **Safety and Regulatory Compliance Guide** - A guide that provides country specific safety and regulatory norms to be followed while installing the device.

---

## Documentation Conventions

### Icon Representation

Name	Image	Meaning
Note		A special instruction that draws attention of a user.
Important		A note of significant importance that the user should be aware of.
Caution		A warning that cautions the user of a possible danger.





















## Introduction











This chapter contains information on the following:









- About Tsunami® 800 and 8000 Series Products
- Multiple-Input-Multiple-Output (MIMO)

### 1.1 About Tsunami® 800 and 8000 Series Products

Product	Description	Image
MP-820-BSU-100	The MP-820 Base Station unit, is a flexible wireless outdoor product that operates in 5.150 – 5.925 GHz frequency band. This connectorized device comes with 2x2 MIMO radio and two N-Type connectors to connect external antennas. It provides an aggregate throughput of 100 Mbps.	
MP-825-BS3-100	The MP-825 Base Station unit comes with a 2x2 MIMO radio and 15 dBi integrated dual-polarized panel antenna that operates in 5.150 - 5.925 GHz frequency band. It provides an aggregate throughput of 100 Mbps.	
MP-8100-BSU	The MP-8100 Base Station unit, is a flexible wireless outdoor product that operates in 2.3 – 2.5 and 4.9 – 6.0 GHz frequency band. This connectorized device comes with a 3x3 MIMO radio and three N-Type connectors to connect external antennas.	
MP-8200-BSU	The MP-8200 Base Station unit, is a flexible wireless outdoor product that operates in 4.900 to 5.925 GHz frequency band. This connectorized device comes with a 3x3 MIMO high power radio and three N-Type connectors to connect external antennas.	
MP-8250-BS9	The MP-8250 Base Station unit comes with a high power 2x2 MIMO radio and 16 dBi integrated 90° sector antenna that operates in 4.900 – 5.925 GHz frequency band.	
MP-8250-BS1	The MP-8250 Base Station unit comes with a high power 2x2 MIMO radio and 23 dBi integrated 10° panel antenna that operates in 4.900 – 5.925 GHz frequency band.	
MP-820-SUA-50+	The MP-820 Subscriber unit, is a flexible wireless outdoor product that operates in 5.150 to 5.925 GHz frequency band. This connectorized device comes with a 2x2 MIMO radio and two N-Type connectors to connect external antennas. It provides an aggregate throughput of 50 Mbps, license upgradable to 100 Mbps.	
MP-825-SUR-50+	The MP-825 Subscriber unit comes with a 2x2 MIMO radio and 15 dBi integrated dual-polarized panel antenna that operates in 5.150 - 5.925 GHz frequency band. It provides an aggregate throughput of 50 Mbps, license upgradable to 100 Mbps.	

MP-825-CPE-50	The MP-825 Customer Premises Equipment comes with a 2x2 MIMO radio and 15 dBi integrated dual-polarized panel antenna that operates in 5.15 - 5.925 GHz frequency band with aggregate throughput of 50 Mbps.	
MP-825-CPE-100	The MP-825 Customer Premises Equipment comes with a 2x2 MIMO radio and 15 dBi integrated dual-polarized panel antenna that operates in 5.150 - 5.925 GHz frequency band with aggregate throughput of 100 Mbps.	
MP-8100-SUA	The MP-8100 Subscriber unit, is a flexible wireless outdoor product that operates in 2.3 – 2.5 and 4.9 – 6.0 GHz frequency band. This connectorized device comes with a 3x3 MIMO radio and three N-Type connectors to connect external antennas.	
MP-8150-SUR	The MP-8150 Subscriber unit comes with a 2x2 MIMO radio and 23 dBi integrated dual-polarized panel antenna that operates in 4.900 – 5.925 GHz frequency band.	
MP-8150-SUR-100	The MP-8150 Subscriber unit comes with a 2x2 MIMO radio and 21 dBi integrated dual-polarized panel antenna that operates in 4.900 – 5.875 GHz frequency band. It provides a throughput of up to 50 Mbps (Uplink) and 50 Mbps (Downlink).	
MP-8150-CPE	The MP-8150 Customer Premises Equipment comes with a high power 2x2 MIMO radio and 16 dBi integrated dual-polarized panel antenna that operates in 5.3 – 6.1 GHz frequency band.	
MP-8200-SUA	The MP-8200 Subscriber unit, is a flexible wireless outdoor product that operates in 4.900 to 5.925 GHz frequency band. This connectorized device comes with a 3x3 MIMO high power radio and three N-Type connectors to connect external antennas.	
MP-8250-SUR	The MP-8250 Subscriber unit comes with a 2x2 MIMO high power radio and 23 dBi integrated dual-polarized panel antenna that operates in 4.900 – 5.925 GHz frequency band.	
MP-8160-BSU	The MP-8160 Base Station unit, is a flexible outdoor product that operates in 5.900 – 6.425 GHz frequency band. This connectorized device comes with a high power 2x2 MIMO radio and two N-Type connectors to connect external antennas.	
MP-8160-BS9	The MP-8160 Base Station unit comes with a 2x2 MIMO radio and 16 dBi integrated 90° sector antenna that operates in 5.900 – 6.425 GHz frequency band.	
MP-8160-SUA	The MP-8160 Subscriber unit, is a flexible outdoor product that operates in 5.900 – 6.425 GHz frequency band. This connectorized device comes with a high power 2x2 MIMO radio and two N-Type connectors to connect external antennas.	

MP-8160-CPE-A100	The MP-8160 Customer Premises Equipment comes with a single high power 2x2 MIMO radio and 15 dBi integrated dual-polarized panel antenna that operates in 5.900 – 6.425 GHz frequency band.	
MP-826-CPE-50	The MP-826 Customer Premises Equipment comes with a 2x2 MIMO radio, and 15 dBi integrated dual-polarized panel antenna that operates in 5.900 – 6.425 GHz frequency band with a aggregate throughput of 50 Mbps.	
QB-8100-EPA	The QB-8100-EPA QuickBridge operates in 2.3 – 2.5 and 4.9 – 6.0 GHz frequency band. This connectorized device comes with a 3x3 MIMO radio and three N-Type connectors to connect external antennas.	
QB-8100-LNK	A pair of QB-8100-EPA devices form a link.	
QB-8150-EPR	The QB-8150-EPR QuickBridge comes with a 2x2 MIMO radio and 23 dBi integrated dual-polarized panel antenna that operates in 4.900 – 5.925 GHz frequency band.	
QB-8150-LNK	A pair of QB-8150-EPR devices form a link.	
QB-8150-LNK-100	A pair of QB-8150-EPR-100 devices form a link.  The QB-8150-EPR-100 device comes with a 2x2 MIMO radio, 21 dBi integrated dual-polarized panel antenna that operates in 4.900 – 5.875 GHz frequency band. It provides a throughput of up to 50 Mbps (Uplink) and 50 Mbps (Downlink).	
QB-8150-LNK-12	A pair of QB-8150-EPR-12 devices form a link.  The QB-8150-EPR-12 device comes with a high power 2x2 MIMO radio, 12 Mbps speed and 16 dBi integrated dual-polarized panel antenna that operates in 5.3 - 6.1 GHz frequency band.	
QB-8150-LNK-50	A pair of QB-8150-EPR-50 devices form a link.  The QB-8150-EPR-50 device comes with a high power 2x2 MIMO radio, 50 Mbps speed and 16 dBi integrated dual-polarized panel antenna that operates in 5.3 – 6.1 GHz frequency band.	
QB-8151-EPR	The QB-8151-EPR QuickBridge comes with a 2x2 MIMO radio and 21 dBi integrated dual-polarized panel antenna that operates in 4.900 – 5.875 GHz frequency band.	

QB-8151-LNK	A pair of QB-8151-EPR devices form a link.	
QB-8200-EPA	The QB-8200-EPA QuickBridge operates in 4.900 – 5.925 GHz frequency band. This connectorized device comes with a 3x3 MIMO high power radio and three N-Type connectors to connect external antennas.	
QB-8200-LNK	A pair of QB-8200-EPA devices form a link.	
QB-8250-EPR	The QB-8250-EPR QuickBridge comes with a 2x2 MIMO high power radio and 23 dBi integrated dual-polarized panel antenna that operates in 4.900 – 5.925 GHz frequency band.	
QB-8250-LNK	A pair of QB-8250-EPR devices form a link.	
QB-825-EPR-50	The QB-825-EPR-50 device comes with a 2x2 MIMO radio and 15 dBi integrated dual-polarized panel antenna that operates in 5.15 - 5.925 GHz frequency band with aggregate throughput of 50 Mbps.	
QB-825-LNK-50	A pair of QB-825-EPR-50 devices form a link.	
QB-825-EPR-50+	The QB-825-EPR-50+ device comes with a 2x2 MIMO high power radio and 15 dBi integrated dual-polarized panel antenna that operates in 5.150 – 5.925 GHz frequency band. It provides an aggregate throughput of 50 Mbps, license upgradable to 100 Mbps.	
QB-825-LNK-50+	A pair of QB-825-EPR-50+ devices form a link.	

---

## 1.2 Multiple-Input-Multiple-Output (MIMO)

Proxim's Point-to-point and Point-to-multipoint devices support Multiple-Input-Multiple-Output (MIMO) antenna technology that uses multiple antennas at both the transmitter and receiver to improve communication performance. The underlying technology of Proxim's product radios are based on a combination of MIMO and OFDM (Orthogonal Frequency Division Multiplexing). MIMO-OFDM combination radios solve interference, fading and multi-path problems. On the receiver side, having multiple receivers increases the amount of received power and also reduces multi-path problems by combining the received signals for each frequency component separately. Hence, MIMO significantly improves the overall gain.

MIMO also uses Spatial multiplexing transmission technique to transmit independent and separately encoded data signals from each of the multiple transmit antennas while reusing or multiplexing in the space dimension. These independent data signals are called Spatial streams. The transmitting antenna uses multiple radio Tx chains and signal paths to simultaneously transmit different data streams, whereas the receiver combines the Rx signals resulting in higher throughput.

By increasing the number of receiving and transmitting antennas, the throughput of the channel increases linearly resulting in high spectral efficiency.

## 800 Series - Hardware Overview and Installation

This chapter provides hardware overview, and step-by-step procedure to install and mount the following Tsunami® 800 series products.

- MP-820-BSU-100 / MP-820-SUA-50+ / MP-820-SUA-100/ MP-825-SUR-50+ / MP-825-BS3-100 / QB-825-EPR/LNK-50+
- MP-825-CPE-100/ MP-825-CPE-50 / QB-825-EPR&LNK-50
- MP-826-CPE-50

### 2.1 MP-820-BSU-100 / MP-820-SUA-50+ / MP-820-SUA-100/ MP-825-SUR-50+ / MP-825-BS3-100 / QB-825-EPR/LNK-50+

This section provides the hardware overview and installation procedure for the following products:

- MP-820-BSU-100
- MP-820-SUA-50+
- MP-825-SUR-50+
- MP-825-BS3-100
- QB-825-EPR/LNK-50+

#### 2.1.1 Hardware Overview

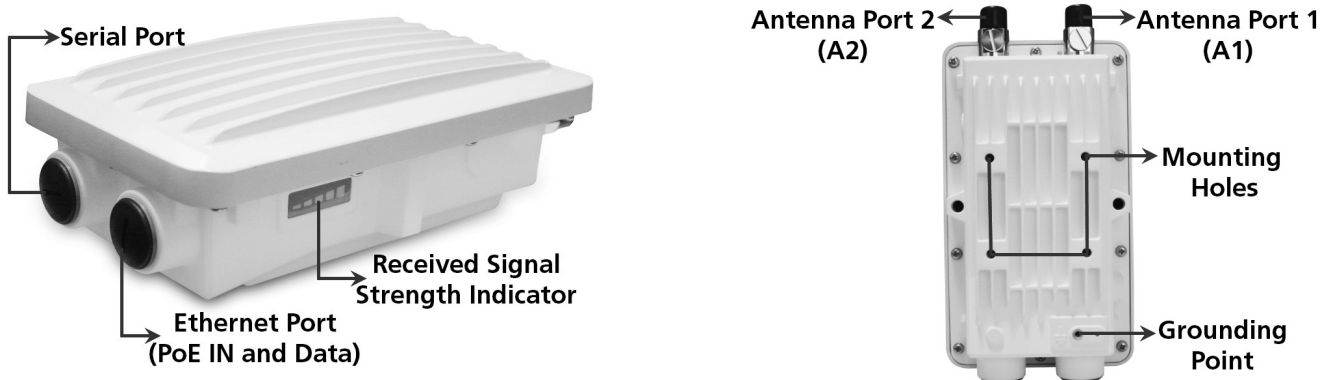

Figure 2-1 MP-820-BSU-100 / MP-820-SUA-50+

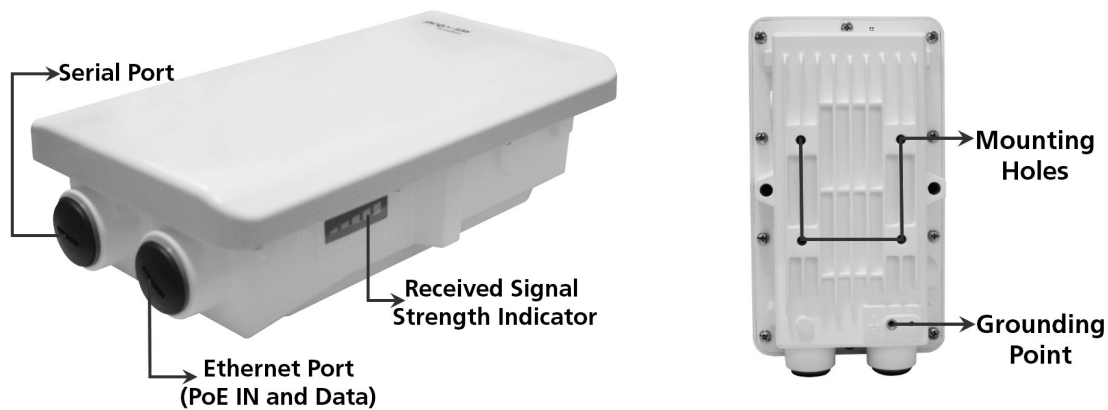

Figure 2-2 MP-825-SUR-50+ / MP-825-BS3-100/ QB-825-EPR-50+

A detailed description about the various components of the device are explained in the following sections.

### 2.1.1.1 Gigabit Ethernet Port

The device comes with one auto-sensing 10/100/1000 BASE-T Ethernet port with configurable Tx modes and speeds.

The Gigabit Ethernet port (PoE IN and Data) of the device allows the user to connect to the LAN by using Cat5e/Cat6 Ethernet cable, and also power ON the device by using the Power over Ethernet (PoE) Injector supplied with the product package.

- The device receives 48 VDC via a standard Cat5e/Cat6 cable connected between the PoE and the device.
- Maximum power supplied to the device is 32 Watts and the device typically draws 10 Watts.

Above 0° Celsius internal temperature, the device need not regulate its temperature, so the power drawn is generally lower in this temperature range. When the internal temperature gets close to the limits, the device starts to heat itself and the power draw increases. Powering the device when it is cold, triggers a special self-heat mode where the device is inoperable until the internal temperature is above -20° Celsius. This is signaled by a solid yellow LED on the Ethernet connector. Once the internal temperature is above -20° Celsius, the device boots normally.

Recommended Ethernet Cable Specifications	
Type	Cat5e/Cat6, STP, 24 AWG, UL rated, UV-shielded and outdoor-rated
Impedance	100 ohms
Cable Length	330 feet / 100 meters
	 <p><i>The total length of cabling between the Personal Computer and the device cannot exceed 100 meters (includes cable from the Personal Computer to the PoE, and the cable from the PoE to the device. Due to DC power requirements, the maximum cable length between the PoE Injector and the device is 75 meters.</i></p>

### 2.1.1.2 Serial Port

The Serial Port is used for debugging and management and GPS Sync (Only for BSU).

The serial connection is established with an RJ11 to DB9 connector (also referred to as a “dongle”) by connecting the RJ11 end of the dongle connector to the device and the other end to your Personal Computer.





















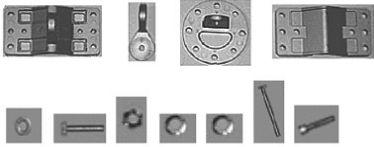











**2.1.1.4 Grounding Point**

To protect the device against lightning or ESD events, you must ground the device properly. To ensure proper grounding, use either of the ground points that are situated at the bottom corner of the device and the grounding screw (M4 thread size) provided to attach a ground wire of at least 12 AWG stranded to the device.

**2.1.2 Product Package**

Each shipment includes the items listed in the following table. Please verify that you have received all the parts in this shipment, prior to installation.

What's in the Kit	Image
MP-820-BSU-100/ MP-820-SUA-50+/ MP-825-SUR-50+/ MP-825-BS3-100/ QB-825-EPR-50+	 <p data-bbox="614 902 957 929"><b>MP-820-BSU-100 / MP-820-SUA-50+</b></p> <p data-bbox="1029 896 1369 945"><b>MP-825-SUR-50+ / MP-825-BS3-100/ QB-825-EPR-50+</b></p>
32 W PoE Injector with reload button and country specific Power Cord WD - US, UK, and EU power cords US - US power cord EU - UK and EU power cords	
RJ11 to DB9 Serial Connector	
Connector Weather Proofing Kit	
Grounding Kit	
Quick Installation Guide	

What's in the Kit	Image																								
Mounting Kit and Hardware	<div style="text-align: center;">  </div> <p>The mounting kit includes the following:</p> <ul style="list-style-type: none"> <li>• Mounting clamp for wall/pole</li> <li>• Extension arm</li> <li>• Mounting plate to enclosure</li> <li>• Mounting clamp for pole mounting</li> </ul> <p>The following table lists and describes some of the items included with the mounting kit:</p> <table border="1" data-bbox="651 922 1326 1603"> <thead> <tr> <th>Quantity</th> <th>Description</th> <th>Image</th> </tr> </thead> <tbody> <tr> <td>6 each</td> <td>Plain washer #5/16</td> <td></td> </tr> <tr> <td>2 each</td> <td>Hex Cap Screw NC 5/16-18 x 35</td> <td></td> </tr> <tr> <td>2 each</td> <td>Nut NC 5/16-18</td> <td></td> </tr> <tr> <td>4 each</td> <td>Helical Spring Lock Washer #1/4</td> <td></td> </tr> <tr> <td>4 each</td> <td>Helical Spring Lock Washer #5/16</td> <td></td> </tr> <tr> <td>2 each</td> <td>Hex Cap Screw NC 5/16-18 x 80</td> <td></td> </tr> <tr> <td>4 each</td> <td>68764, Screw, Machine, Pan, Philips, 1/4"-20, 5/8" L</td> <td></td> </tr> </tbody> </table>	Quantity	Description	Image	6 each	Plain washer #5/16		2 each	Hex Cap Screw NC 5/16-18 x 35		2 each	Nut NC 5/16-18		4 each	Helical Spring Lock Washer #1/4		4 each	Helical Spring Lock Washer #5/16		2 each	Hex Cap Screw NC 5/16-18 x 80		4 each	68764, Screw, Machine, Pan, Philips, 1/4"-20, 5/8" L	
Quantity	Description	Image																							
6 each	Plain washer #5/16																								
2 each	Hex Cap Screw NC 5/16-18 x 35																								
2 each	Nut NC 5/16-18																								
4 each	Helical Spring Lock Washer #1/4																								
4 each	Helical Spring Lock Washer #5/16																								
2 each	Hex Cap Screw NC 5/16-18 x 80																								
4 each	68764, Screw, Machine, Pan, Philips, 1/4"-20, 5/8" L																								

 : QB-825-LNK-50+ contains two sets of all the above accessories.

### 2.1.3 Installation Procedure



*Please note that we have taken MP-820-BSU-100 as an example to explain the steps to install and mount the device. Please correlate the same with your device.*



*The device must be installed by a trained professional who is familiar with radio frequency planning and regulatory limits.*

Perform the following steps to install and mount the device.

#### Step 1: Plan for Installation

There are several planning factors to be considered before installing the device. In addition to selecting the installation site, you should do the following:

Calculate:

- Required RSL and fade margin to achieve link availability objectives. For more details on how to calculate RSL and fade margin, please refer to the 'Antenna Installation Guide' and 'Proxim Link Calculator' that are available on the support site at <http://my.proxim.com>.
- Required path availability
- Anticipated multi-path reflection points

Determine:

- System frequency plan
- Required antenna mounting height to obtain proper path clearance
- Required transmission line types (like cable, waveguides) and lengths

Plan for:

- Device's continuous power consumption needs
- Lightning protection and system grounding
- Hardware mounting
- Cable installation including egress
- Pre-testing equipment (back-to-back test procedure)

#### Step 2: Choose a Location

To make optimal use of the device, you must find a suitable location to install the hardware. The range of the radio device largely depends upon the position of the antenna. Proxim recommends you do a site survey, observing the following requirements, before mounting the hardware.

- The location must allow easy disconnection of power to the radio, if necessary.
- Ensure free flow of air around the hardware.
- The radio device must be kept away from vibration and excessive heat.
- The installation must conform to local regulations at all times.

The devices are designed to directly mount to a pole. By using the supplied brackets and hardware, you can mount them to a 1.25 inch to 3-inch pole (outside diameter). Longer bolts (not supplied) are required to mount the device to a larger diameter pole. By using just one of the pole mounting brackets, you can mount the device to a wall or other flat surface.

### Step 3: Gather Required Tools

You should have the following tools available before installing the device:

- Cross-tip screwdrivers
- Small blade standard screwdriver
- Large blade standard screwdriver
- Wire crimpers (if using connectors that are not pre-made)
- Adjustable 6" wrench
- Weatherproofing material for sealing external connectors (such as butyl tape)
- Straight-through UV-protected STP-rated Cat5e/Cat6 Ethernet cable for connecting to PC, or cable for connecting to a hub or a switch.

### Step 4: Unpack the Product Package

- Unpack the device and its accessories from the shipping box.
- Please make a note of the Ethernet addresses, the MAC addresses and the serial number. These addresses may be used when configuring the device. Note that the serial number helps you to seek support from the Proxim's Customer support team.

### Step 5: Weatherproofing RJ45 Connectors

The following steps explain how to weatherproof the RJ45 connectors:

1. Use a straight-through cable (Cat5e/Cat6) with one end bare.
2. Connect the crimped RJ45 connector end of the cable into the RJ45 Ethernet port inside the enclosure. The cable connector should latch into the Ethernet port.
3. Slide the Flat Washer (A) into the Connector Body (B) to make it waterproof and onto the bare end of the cable. Next, fasten the Connector Body into the Ethernet connector hole on the device.
4. Slide the tube-shaped Compression Washer (C) into the Compression Ring (D) and onto the cable from the bare end, and insert into the fixed Connector Body.
5. Slide the Sealing Nut (E) over the bare end of the cable and fasten it on the fixed Connector Body.
6. Crimp the bare end of the cable with RJ45 connector and connect it to the **PWR LAN-OUT** port on the PoE Injector.

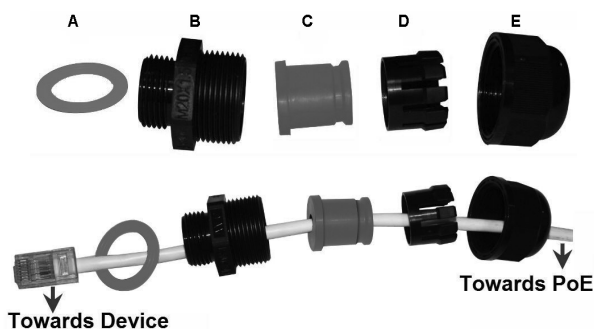

Figure 2-4 Weatherproofing RJ45 Connector

#### Additional Weatherproofing Steps

To add an additional layer of protection to the connectors against the environment, see Appendix - Additional Weatherproofing Steps.

For detailed explanation to weatherproof RF connections, refer to *Antenna Installation Guide*, which is available at <http://my.proxim.com>.

**Step 6: Assemble Mounting Hardware**

1. Fix the mounting plate (A) by using the provided screws and washers (Torque 9 N-m/75 in-lbs).

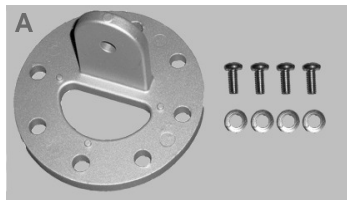

**Mounting Plate**



**Mounting Plate fixed to the device**

2. Fix the extension arm (B) to the fixed mounting plate with the provided screw, nut and washers. The extension arm gives the device more possible tilt, letting you adjust for azimuth or elevation over a larger angle.



**Extension Arm**

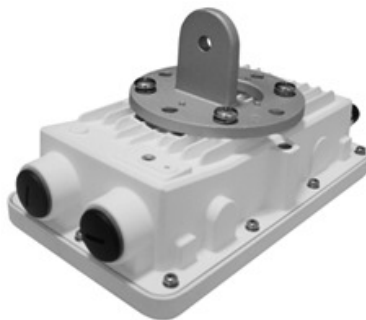

**Mounting Plate fixed to the device**

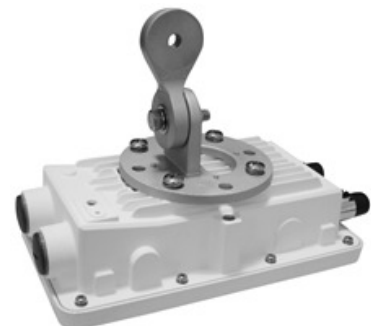

**Extension Arm fixed to Mounting Plate**

3. Fix the mounting bracket (C) to fixed extension arm with the provided screw, nut and washers.

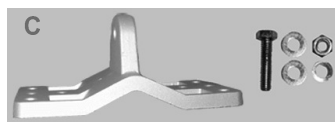

**Mounting Bracket**

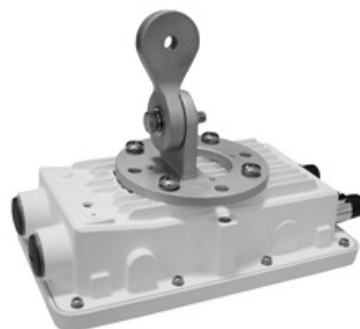

**Extension Arm fixed to Mounting Plate**



**Mounting Bracket fixed to Extension Arm**

4. Tighten the assembled parts (Torque 15 N·m/130 in-lbs).



The following figure shows the full assembled mounting hardware fixed to the device.



Figure 2-5 Assembled Device

### Step 7: Mount the Device

1. To pole-mount the device, insert the provided screws and washers through bracket (F). Fasten around the pole to bracket (C) and secure (Torque 11 N·m/100 in-lbs).



Figure 2-6 Pole Mounting

2. To wall-mount the device, mount the bracket (C) to a wall using 4 screws (not provided), as shown:



**Figure 2-7 Wall Mounting**

### Step 8: Plug in the Cables



*Unscrew the sealing cap for installation of the cable.*

1. Plug one end of the straight-through Cat5e/Cat6 cable into the Ethernet Port of the device by following the Weatherproofing steps as explained in Step 5. Connect the other end of the cable into the **PWR LAN-OUT** port on the PoE Injector.



*Always use a straight cable from PoE to the device.*



**Figure 2-8 Cable Plugged In**

2. Optionally, connect a RJ11 to DB9 Serial Connector to device's Serial Port for debugging and management, and GPS Sync.



**Figure 2-9 PoE Injector**

3. To connect the device through a hub or a switch to a Personal Computer, connect an Ethernet cable between the network interface card in the Personal Computer and the hub, and between the hub and the RJ45 "LAN-IN" port on the PoE Injector.
4. To connect the device directly to a Personal Computer, connect an Ethernet cable between the network interface card in the Personal Computer and the RJ45 "LAN IN" port on the PoE Injector.

### Step 9: Connect the Antenna



*:Applicable only to MP-820-BSU-100 and MP-820-SUA-50+*

Connect the antenna to the device antenna port by connecting the straight N-male end of the cable to the device antenna port and the right angle N-male end of the cable at the antenna.



- Record which port each antenna polarization is associated with to ensure that each side matches and aid in configuration.
- Ensure to use antenna ports A1 and A2 for dual polarization antennas

### Step 10: Install Surge Protector

Proxim recommends two approved lightning surge protectors to be installed, one near to the device and the other at the building ingress point.



*: For an additional Surge Protector, place an order separately with your distributor.*

Perform the following steps to ensure proper surge protection:

1. Mount the provided surge protector near the outdoor device and use 10 AWG or a better gauge wire to connect the protector's ground lug to the appropriate mounting ground point. The outdoor device and co-located surge protector should have a common grounding point by using the shortest possible grounding cable.
2. Mount a second surge protector near the building ingress and use 10 AWG or a better gauge wire to connect the surge protector's ground lug to earth ground as shown in the figure below.



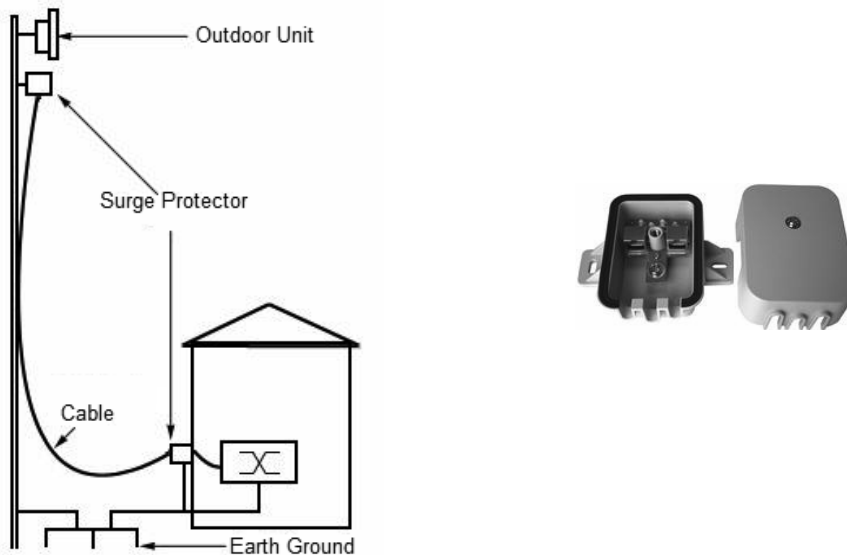

**Figure 2-10 Surge Protector**



*Use Outdoor-rated, UV protected, shielded Cat5e/Cat6 cable for the following:*

3. Connect an RJ45 terminated cable between the indoor device and to the port on the surge protector at the building ingress.
4. Connect a short RJ45 terminated cable between the outdoor device and the port on the co-located surge protector.
5. Connect an RJ45 terminated cable between the two surge protectors on their remaining ports.



*Ensure to loop the cable before entering the premise to prevent water ingress.*



### Step 11: Ground the Unit

To ensure proper grounding, use either of the ground points which are situated at the bottom corners of the device and the grounding screw(M24 thread size) provided to attach a ground wire of at least 12 AWG stranded to the device. It is important that the following ground guidelines are followed during installations to protect the device against lightning or ESD events:

1. Connect one end of the grounding cable to the device and the other end to the closest earthing system point at the installation.
2. Cut any extra ground wire length when finished connecting it to the single point earth ground.
3. Avoid sharp bends and never loop or coil up the ground wire, always connect it straight to ground.
4. A good earth ground impedance is less than 1.0 ohm.
5. Measure ground impedance at the point where the protector ground wire is connected and not at the ground rod.
6. Connect the surge protector ground wire and equipment ground (both power ground and telecomm ground) to a single common ground.
7. Make sure all connections are fastened securely and are tight.
8. Never install during a storm and always follow your local safety codes.

Connect the grounding wire, which is supplied with the product package, to the device as shown below:



Figure 2-11 Ground the device

### Step 12: Power ON the Device

Plug in the power cord into a power outlet after having connected the PoE Injector and the device using Cat5e/Cat6 cable. There is no ON/OFF switch on the device. To disconnect power, unplug the RJ45 connector from the **“PWR LAN-OUT”** port on the PoE injector.



- When you power ON the device, LEDs on the scaling mask glow. The more LEDs on the scaling mask glow, better is the signal. For better signal strength, try adjusting the position of the device.
- Device can also be powered via serial port(12VDC). Refer Serial Port for more details.



The number of LEDs glowing and their corresponding SNR ranges are as follows:

Number of LEDs Glowing	SNR Ranges
1	1-12
2	13-18
3	19-24
4	25-30
5	SNR > 30

### Step 13: View LEDs

When the device is powered on, it performs startup diagnostics. When startup is complete, the LEDs show the device's operational state. The LEDs are available at the device's Ethernet connector inside the enclosure. You can see the LEDs through the Ethernet connector. The LEDs will not be visible if the RJ45 connector is weatherproofed.

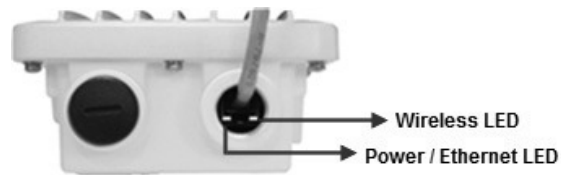

Figure 2-12 View LEDs

The following table describes the status of LEDs:

LED State	Ethernet Interface	
	Power/Ethernet LED	Wireless LED
Off	No Power	Radio is not present or failed to detect
Amber	No Application Image detected (ScanTool mode)	Power is ON and device detects reload signal
Blinking Green	Power is ON and the Ethernet link is DOWN	Radio is detected but wireless link has not been established yet
Solid Green	Power is ON and the Ethernet link is UP	Radio is detected and wireless link has been established



*The 'Wireless LED' on the Ethernet port will glow amber during initialization of the board, if device is powered ON through device serial port using an external 12V power-supply.*

### Step 14: Align the Antenna

Antenna alignment is the process of physically aligning the antenna of the radio receiver and transmitter to have the best possible link established between them. The antenna alignment process is usually performed during installation and after major repairs. If you are installing external antennas, refer to the documentation that accompanies the antenna for installation instructions.

When the link is established, align the antenna using RSSI LEDs. The more LEDs on the scaling mask glow, better is the signal. For better signal strength, try adjusting the position of the device.



*For detailed RSSI LED behavior, refer Tsunami® 800 & 8000 Series Software Management Guide v5.2.*

## 2.2 MP-825-CPE-100/ MP-825-CPE-50 / QB-825-EPR&LNK-50

This section provides the hardware overview and installation method for MP-825-CPE-100, MP-825-CPE-50 and QB-825-EPR-50.

### 2.2.1 Hardware Overview



Figure 2-13 MP-825-CPE-100/ MP-825-CPE-50 / QB-825-EPR-50

The device contains the following features:

Features	Description
Ethernet Port (100 Mbps)	PoE IN and data
RSSI (Received Signal Strength Indicator)	Scaling mask LEDs indicating signal strength
Grounding Point	A provision to ground the device

#### 2.2.1.1 Ethernet Port (PoE IN and Data)

The device comes with auto-sensing 10/100 BASE-T Ethernet port with configurable Tx modes and speed.

The Ethernet port of the device allows the user to connect to LAN by using Cat5/Cat5e or a better cable, and also power ON the device by using Power over Ethernet (PoE) Injector supplied with the product package.

- The device receives 48 VDC via a standard Cat5/Cat5e or better cable connected to the Ethernet port.
- Maximum power supplied to the device is 19.2 Watts. The device typically draws 6 Watts.

Recommended Ethernet Cable Specifications	
Type	Cat5/5e or better, STP, 24 AWG, UL rated, UV-shielded and outdoor-rated
Impedance	100 ohms
Cable Length	330 feet / 100 meters
	 <p>: The total length of cabling between the Personal Computer and the device cannot exceed 100 meters (includes cable from the Personal Computer to the PoE, and the cable from the PoE to the device). Due to DC power requirements, the maximum cable length between the PoE Injector and the device is 75 meters.</p>









: You should use a straight through Ethernet cable between the PoE and the device. When you use a 4-pair cross over Ethernet cable, the reload functionality gets activated and forcibly deletes the operating image.

**2.2.1.2 Grounding Point**

To protect the device against lightning or ESD events, you must ground the device properly. To ensure proper grounding, use the grounding point situated at the bottom corner of the device and the grounding screw (M4 thread size) provided to attach a ground wire of at least 12 AWG stranded to the device.

**2.2.2 Product Package**

Each shipment includes the items listed in the following table. Please verify that you have received all the parts in the shipment prior to the installation.

What's in the Kit	Image
MP-825-CPE-100/ MP-825-CPE-50/ QB-825-EPR-50	
PoE Injector with Country specific Power Cord  <i>WD - US, UK, and EU power cords</i> <i>US - US power cord</i>	
Connector Weather Proofing Kit	
Pole Mounting Kit	
Grounding Kit	
Quick Installation Guide	



: QB-825-LNK-50 contains two sets of all the above accessories.

### 2.2.3 Installation Procedure

This section describes the steps to install and mount the device.



*The device must be installed by a trained professional who is familiar with radio frequency planning and regulatory limits.*

Perform the following steps to install and mount the device.

#### Step 1: Plan for Installation

There are several planning factors to be considered before installing the device. In addition to selecting the installation site, you should do the following:

Calculate:

- Required RSL and fade margin to achieve link availability objectives. For details on how to calculate RSL and fade margin, please refer to the 'Antenna Installation Guide' and 'Proxim Link Calculator' which are available at <http://my.proxim.com>.
- Required path availability
- Anticipated multi-path reflection points

Determine:

- System frequency plan
- Required transmission line types (like cable, waveguides) and lengths

Plan for:

- Continuous power consumption needs of the device
- Lightning protection and system grounding
- Hardware mounting
- Cable installation including egress
- Pre-testing equipment (back-to-back test procedure)

#### Step 2: Choose a Location

To make optimal use of the device, you must find a suitable location to install the hardware. Proxim recommends you do a site survey, observing the following requirements, before mounting the hardware.

- The location must allow easy disconnection of power to the radio, if necessary.
- Ensure free flow of air around the hardware.
- The radio device must be kept away from vibration and excessive heat.
- The installation must conform to local regulations at all times.

#### Step 3: Gather Required Tools

You should have the following tools available before installing the device:

- Cross-tip screwdrivers
- Large blade standard screwdriver
- Spanner 13
- Wire crimpers (if using connectors that are not pre-made)

#### Step 4: Unpack the Product Package

- Unpack the device and its accessories from the shipping box.

- Please make a note of the Ethernet addresses, the MAC addresses and the serial number. These addresses may be used when configuring the device. Note that the serial number helps you to seek support from the Proxim's Customer support team.

### Step 5: Pole Mount the Device

9. To pole-mount the device to a 1 inch diameter pole, place the mounting bracket with its small V-Groove facing the pole (See option (1) in Figure 2).
10. To pole-mount the device to a 2.5 inch diameter pole, place the mounting bracket with its large V-Groove facing the pole (See option (2) in Figure 2).
11. Place the device with its rear side facing the pole, and fasten the M8x80mm long screws along with the spring and plain washers through the mounting bracket into the mounting holes of the device and tighten it to torque of 11 N.m/100 in-lbs.



Figure 2-14 Pole-Mounting

### Step 6: Plug in the Cables



: Unscrew the sealing cap for installation of the cable.

1. Weatherproofing RJ45 Connector:
  - a. Use a straight-through cable (Cat5/Cat5e or better) with one end bare.
  - b. Connect the crimped RJ45 connector end of the cable into the RJ45 Ethernet port inside the enclosure. The cable connector should latch into the Ethernet port.
  - c. Slide the Flat Washer (A) into the Connector Body (B) to make it waterproof and onto the bare end of the cable. Next, fasten the Connector Body into the Ethernet connector hole on the device.
  - d. Slide the tube-shaped Compression Washer (C) into the Compression Ring (D) and onto the cable from the bare end, and insert into the fixed Connector Body.
  - e. Slide the Sealing Nut (E) over the bare end of the cable and fasten it on the fixed Connector Body.
  - f. Crimp the bare end of the cable with RJ45 connector and connect it to the **LAN+DC** port on the PoE Injector.

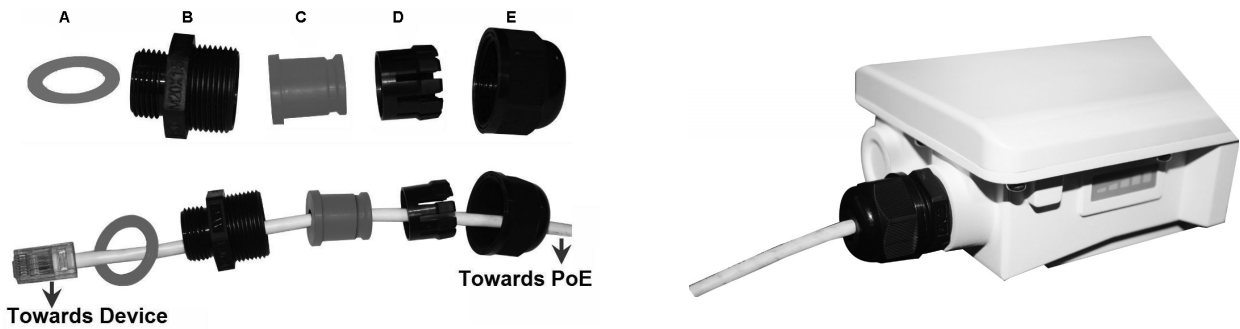

**Figure 2-15 Weatherproofing RJ45 Connector**

2. To connect the device through a hub or a switch to a Personal Computer, connect an *Ethernet cable* between the network interface card in the Personal Computer and the hub/switch, and between the hub/switch and the RJ45 **LAN** port on the PoE Injector.
3. To connect the device directly to a Personal Computer, connect an *Ethernet cable* between the network interface card in the Personal Computer and the RJ45 **LAN** port on the PoE Injector.



- Use only the PoE supplied with the product.
- You should use a straight through Ethernet cable between the PoE and the device. When you use a 4-pair cross over Ethernet cable, the reload functionality gets activated and forcibly deletes the operating image.

The following figure is the pictorial representation of the cabling setup.

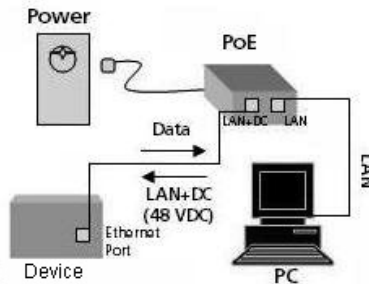

**Figure 2-16 Cabling Setup**

### Additional Weatherproofing Steps

To add an additional layer of protection to the connectors against the environment, see Appendix - Additional Weatherproofing Steps.

### Step 8: Install Surge Protector

Proxim recommends two approved lightning surge protectors to be installed, one near to the device and the other at the building ingress point.



To buy a suitable Surge Protector, place an order separately with your distributor.



Perform the following steps to ensure proper surge protection:

1. Mount the surge protector near the outdoor device and use 10 AWG or larger wire to connect the protector's ground lug to the appropriate mounting ground point. The outdoor device and co-located surge protector should have a common grounding point using the shortest possible grounding cable.
2. Mount a second surge protector near the building ingress and use 10 AWG or larger wire to connect the surge protector's ground lug to earth ground as shown in the following figure.

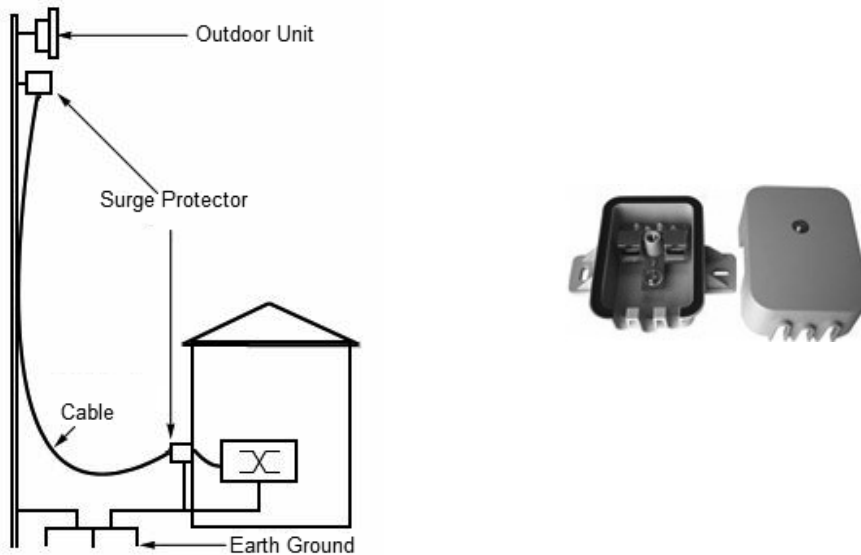

**Figure 2-17 Surge Protector**



*Use Outdoor-rated, UV protected, shielded Cat5/Cat5e or better cable for the following:*

3. Connect an RJ45 terminated cable between the indoor device and to the port on the surge protector at the building ingress.
4. Connect a short RJ45 terminated cable between the outdoor equipment and the port on the co-located surge protector.
5. Connect an RJ45 terminated cable between the two surge protectors on their remaining ports.



**Ensure to loop the cable before entering the premise to prevent water ingress.**



### Step 9: Ground the Device

To ensure proper grounding, use the grounding point situated at the bottom corner of the device and the grounding screw provided to attach a ground wire of at least 12 AWG stranded to the device. It is important that the following grounding guidelines are followed to protect the device against lightning or ESD events:

1. Connect one end of the grounding cable to the device and the other end to the closest earthing system point at the installation.
2. Cut any extra ground wire length when finished connecting it to the single point earth ground.
3. Avoid sharp bends and never loop or coil up the ground wire, always connect it straight to ground.
4. A good earth ground impedance is less than 1.0 ohm.
5. Make sure all connections are fastened securely and are tight.

6. Never install during a storm and always follow your local safety codes.

Connect the grounding wire, which is supplied with the product package, to the grounding lug as shown below:



Figure 2-18 Ground the Device

### Step 10: Power ON the Device

Plug in the power cord into a power outlet after having connected the PoE Injector and the device using Cat5/5e or better cable. There is no ON/OFF switch on the device. To disconnect power, unplug the RJ45 connector from the **LAN+DC** port on the PoE injector.



*When you power ON the device, LEDs on the scaling mask glow. The more LEDs on the scaling mask glow, better is the signal. For better signal strength, try adjusting the position of the device.*



The number of LEDs glowing and their corresponding SNR ranges are as follows:

Number of LEDs Glowing	SNR Ranges
1	1-12
2	13-18
3	19-24
4	25-30
5	SNR > 30

### Step 11: View LEDs

When the device is powered on, it performs startup diagnostics. When startup is complete, the LEDs show the device's operational status. The LEDs are available at the device's Ethernet connector inside the enclosure. You can see the LED through the Ethernet connector. The LEDs will not be visible if the RJ45 connector is weatherproofed.

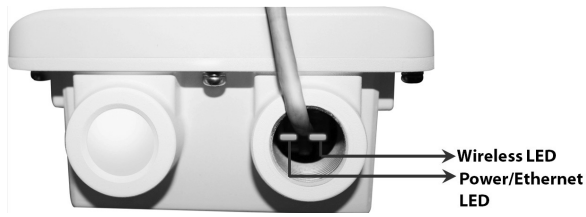

Figure 2-19 LED Indicators

The following table describes the status of LED:

LED State	Ethernet Interface	
	Power/Ethernet LED	Wireless LED
Off	No Power	Radio is not present or failed to detect
Amber	No Application Image detected (ScanTool mode)	Power is ON and device detects Reload signal
Blinking Green	Power is ON and the Ethernet link is DOWN	Radio is detected but wireless link has not been established yet
Solid Green	Power is ON and the Ethernet link is up	Radio is detected and wireless link has been established

## 2.3 MP-826-CPE-50

This section provides the hardware overview and installation procedure for the MP-826-CPE-50

### 2.3.1 Hardware Overview



Figure 2-20 MP-826-CPE-50

The device contains the following features:

Features	Description
Ethernet Port (100 Mbps)	PoE IN and data
RSSI (Received Signal Strength Indicator)	Scaling mask LEDs indicating signal strength
Grounding Point	A provision to ground the device

#### 2.3.1.1 Ethernet Port (PoE IN and Data)

The device comes with auto-sensing 10/100 BASE-T Ethernet port with configurable Tx modes and speed.

The Ethernet port of the device allows the user to connect to LAN by using Cat5/Cat5e or a better cable, and also power ON the device by using Power over Ethernet (PoE) Injector supplied with the product package.

- The device receives 48 VDC via a standard Cat5/Cat5e or better cable connected to the Ethernet port.
- Maximum power supplied to the device is 19.2 Watts. The device typically draws 6 Watts.

Recommended Ethernet Cable Specifications	
Type	Cat5/5e or better, STP, 24 AWG, UL rated, UV-shielded and outdoor-rated
Impedance	100 ohms
Cable Length	330 feet / 100 meters
	 <p>: The total length of cabling between the Personal Computer and the device cannot exceed 100 meters (includes cable from the Personal Computer to the PoE, and the cable from the PoE to the device). Due to DC power requirements, the maximum cable length between the PoE Injector and the device is 75 meters.</p>









: You should use a straight through Ethernet cable between the PoE and the device. When you use a 4-pair cross over Ethernet cable, the reload functionality gets activated and forcibly deletes the operating image.

### 2.3.1.2 Grounding Point

To protect the device against lightning or ESD events, you must ground the device properly. To ensure proper grounding, use the grounding point situated at the bottom corner of the device and the grounding screw (M4 thread size) provided to attach a ground wire of at least 12 AWG stranded to the device.

### 2.3.2 Product Package

Each shipment includes the items listed in the following table. Please verify that you have received all the parts in the shipment prior to the installation.

What's in the Kit	Image
MP-826-CPE-50	
PoE Injector with Country specific Power Cord  <i>WD - US, UK, and EU power cords</i> <i>US - US power cord</i>	
Connector Weather Proofing Kit	
Pole Mounting Kit   <p><i>The mounting kit which is supplied with 8xx / 8xxx series can also be used with this device. Please refer to the Step:6 Assemble Mounting Hardware of the 2.1.3 Installation Procedure for the step-by-step mounting procedure.</i></p>	
Grounding Kit	

What's in the Kit	Image
Quick Installation Guide	

### 2.3.3 Installation Procedure

This section describes the steps to install and mount the device.



*The device must be installed by a trained professional who is familiar with radio frequency planning and regulatory limits.*

Perform the following steps to install and mount the device.

#### Step 1: Plan for Installation

There are several planning factors to be considered before installing the device. In addition to selecting the installation site, you should do the following:

Calculate:

- Required RSL and fade margin to achieve link availability objectives. For details on how to calculate RSL and fade margin, please refer to the 'Antenna Installation Guide' and 'Proxim Link Calculator' which are available at <http://my.proxim.com>.
- Required path availability
- Anticipated multi-path reflection points

Determine:

- System frequency plan
- Required transmission line types (like cable, waveguides) and lengths

Plan for:

- Continuous power consumption needs of the device
- Lightning protection and system grounding
- Hardware mounting
- Cable installation including egress
- Pre-testing equipment (back-to-back test procedure)

#### Step 2: Choose a Location

To make optimal use of the device, you must find a suitable location to install the hardware. Proxim recommends you do a site survey, observing the following requirements, before mounting the hardware.

- The location must allow easy disconnection of power to the radio, if necessary.
- Ensure free flow of air around the hardware.
- The radio device must be kept away from vibration and excessive heat.
- The installation must conform to local regulations at all times.

### Step 3: Gather Required Tools

You should have the following tools available before installing the device:

- Cross-tip screwdrivers
- Large blade standard screwdriver
- Spanner 13
- Wire crimpers (if using connectors that are not pre-made)

### Step 4: Unpack the Product Package

- Unpack the device and its accessories from the shipping box.
- Please make a note of the Ethernet addresses, the MAC addresses and the serial number. These addresses may be used when configuring the device. Note that the serial number helps you to seek support from the Proxim's Customer support team.

### Step 5: Pole Mount the Device

7. To pole-mount the device to a 1 inch diameter pole, place the mounting bracket with its small V-Groove facing the pole (See option (1) in Figure 2).
8. To pole-mount the device to a 2.5 inch diameter pole, place the mounting bracket with its large V-Groove facing the pole (See option (2) in Figure 2).
9. Place the device with its rear side facing the pole, and fasten the M8x80mm long screws along with the spring and plain washers through the mounting bracket into the mounting holes of the device and tighten it to torque of 11 N.m/100 in-lbs.

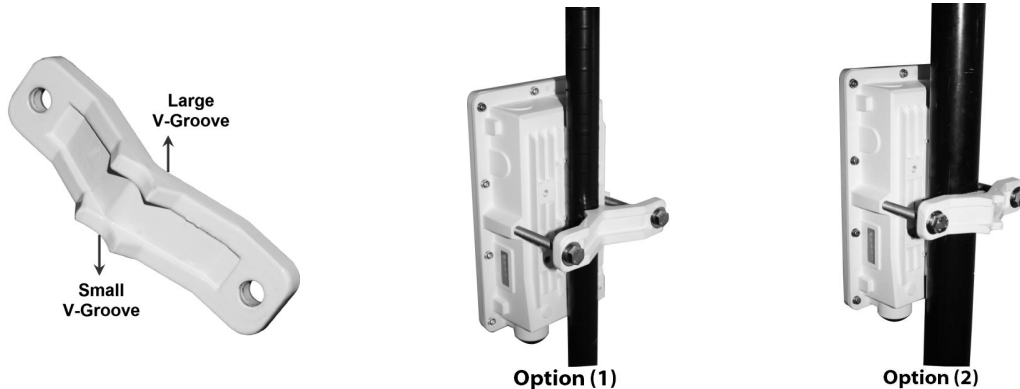

Figure 2-21 Pole-Mounting

### Step 6: Plug in the Cables



: Unscrew the sealing cap for installation of the cable.

1. Weatherproofing RJ45 Connector:
  - a. Use a straight-through cable (Cat5/Cat5e or better) with one end bare.
  - b. Connect the crimped RJ45 connector end of the cable into the RJ45 Ethernet port inside the enclosure. The cable connector should latch into the Ethernet port.
  - c. Slide the Flat Washer (A) into the Connector Body (B) to make it waterproof and onto the bare end of the cable. Next, fasten the Connector Body into the Ethernet connector hole on the device.

- d. Slide the tube-shaped Compression Washer (C) into the Compression Ring (D) and onto the cable from the bare end, and insert into the fixed Connector Body.
- e. Slide the Sealing Nut (E) over the bare end of the cable and fasten it on the fixed Connector Body.
- f. Crimp the bare end of the cable with RJ45 connector and connect it to the **LAN+DC** port on the PoE Injector.

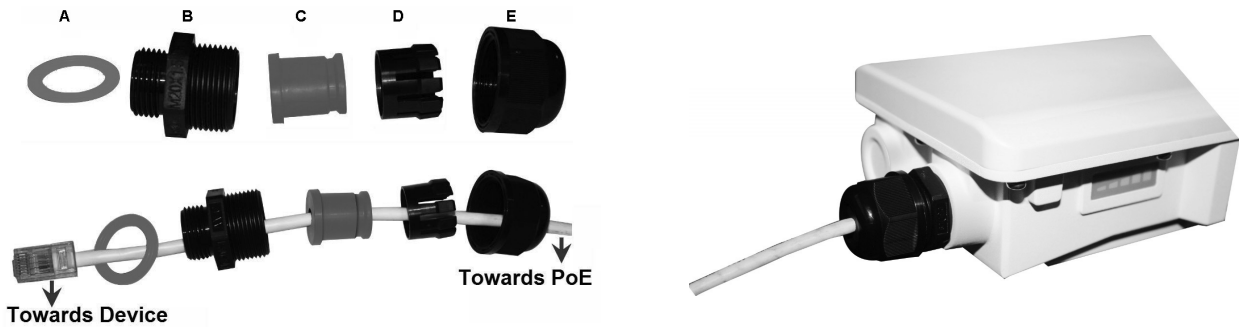

Figure 2-22 Weatherproofing RJ45 Connector

2. To connect the device through a hub or a switch to a Personal Computer, connect an *Ethernet cable* between the network interface card in the Personal Computer and the hub/switch, and between the hub/switch and the RJ45 **LAN** port on the PoE Injector.
3. To connect the device directly to a Personal Computer, connect an *Ethernet cable* between the network interface card in the Personal Computer and the RJ45 **LAN** port on the PoE Injector.



- Use only the PoE supplied with the product.
- You should use a straight through Ethernet cable between the PoE and the device. When you use a 4-pair cross over Ethernet cable, the reload functionality gets activated and forcibly deletes the operating image.

The following figure is the pictorial representation of the cabling setup.

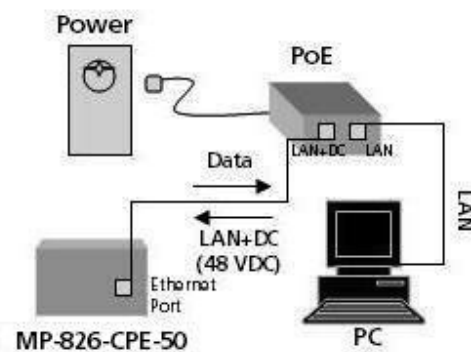

Figure 2-23 Cabling Setup

### Additional Weatherproofing Steps

To add an additional layer of protection to the connectors against the environment, see Appendix - Additional Weatherproofing Steps.



## Step 8: Install Surge Protector

Proxim recommends two approved lightning surge protectors to be installed, one near to the device and the other at the building ingress point.



*To buy a suitable Surge Protector, place an order separately with your distributor.*

Perform the following steps to ensure proper surge protection:

1. Mount the surge protector near the outdoor device and use 10 AWG or larger wire to connect the protector's ground lug to the appropriate mounting ground point. The outdoor device and co-located surge protector should have a common grounding point using the shortest possible grounding cable.
2. Mount a second surge protector near the building ingress and use 10 AWG or larger wire to connect the surge protector's ground lug to earth ground as shown in the following figure.

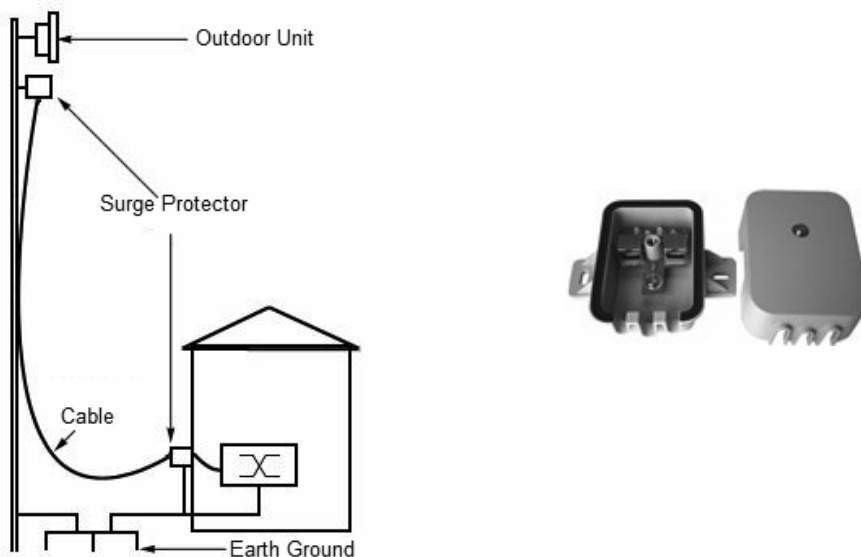

**Figure 2-24 Surge Protector**



*Use Outdoor-rated, UV protected, shielded Cat5/Cat5e or better cable for the following:*

3. Connect an RJ45 terminated cable between the indoor device and to the port on the surge protector at the building ingress.
4. Connect a short RJ45 terminated cable between the outdoor equipment and the port on the co-located surge protector.
5. Connect an RJ45 terminated cable between the two surge protectors on their remaining ports.



**Ensure to loop the cable before entering the premise to prevent water ingress.**



### Step 9: Ground the Device

To ensure proper grounding, use the grounding point situated at the bottom corner of the device and the grounding screw provided to attach a ground wire of atleast 12 AWG stranded to the device. It is important that the following grounding guidelines are followed to protect the device against lightning or ESD events:

1. Connect one end of the grounding cable to the device and the other end to the closest earthing system point at the installation.
2. Cut any extra ground wire length when finished connecting it to the single point earth ground.
3. Avoid sharp bends and never loop or coil up the ground wire, always connect it straight to ground.
4. A good earth ground impedance is less than 1.0 ohm.
5. Make sure all connections are fastened securely and are tight.
6. Never install during a storm and always follow your local safety codes.

Connect the grounding wire, which is supplied with the product package, to the grounding lug as shown below:



Figure 2-25 Ground the Device

### Step 10: Power ON the Device

Plug in the power cord into a power outlet after having connected the PoE Injector and the device using Cat5/5e or better cable. There is no ON/OFF switch on the device. To disconnect power, unplug the RJ45 connector from the **LAN+DC** port on the PoE injector.



*When you power ON the device, LEDs on the scaling mask glow. The more LEDs on the scaling mask glow, better is the signal. For better signal strength, try adjusting the position of the device.*



The number of LEDs glowing and their corresponding SNR ranges are as follows:

Number of LEDs Glowing	SNR Ranges
1	1-12
2	13-18
3	19-24
4	25-30
5	SNR > 30

## Step 11: View LEDs

When the device is powered on, it performs startup diagnostics. When startup is complete, the LEDs show the device's operational status. The LEDs are available at the device's Ethernet connector inside the enclosure. You can see the LED through the Ethernet connector. The LEDs will not be visible if the RJ45 connector is weatherproofed.

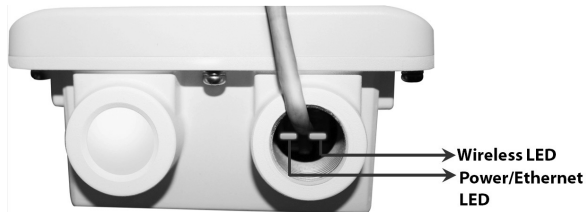

**Figure 2-26 LED Indicators**

The following table describes the status of LED:

LED State	Ethernet Interface	
	Power/Ethernet LED	Wireless LED
Off	No Power	Radio is not present or failed to detect
Amber	No Application Image detected (ScanTool mode)	Power is ON and device detects Reload signal
Blinking Green	Power is ON and the Ethernet link is DOWN	Radio is detected but wireless link has not been established yet
Solid Green	Power is ON and the Ethernet link is up	Radio is detected and wireless link has been established

## 8000 Series - Hardware Overview and Installation

This chapter provides hardware overview, and step-by-step procedure to install and mount the following Tsunami® 8000 series products.

- MP-8100-BSU&SUA / MP-8150-SUR / QB-8100-EPA&LNK / QB-8150- EPR&LNK / QB-8151-EPR&LNK
- MP-8160-BSU / MP-8160-SUA / MP-8160-BS9
- MP-8150-CPE / QB-8150-LNK-12/50
- MP-8160-CPE-A100
- MP-8150-SUR-100 / QB-8150-LNK-100
- MP-8200-BSU / MP-8200-SUA / MP-8250-SUR / QB-8200-EPA&LNK /QB-8250-EPR&LNK / MP-8250-BS9 / MP-8250-BS1

### 3.1 MP-8100-BSU&SUA / MP-8150-SUR / QB-8100-EPA&LNK / QB-8150-EPR&LNK / QB-8151-EPR&LNK

This section provides the hardware overview and installation procedure for the following product(s):

- MP-8100-BSU
- MP-8100-SUA
- MP-8150-SUR
- QB-8100-EPA / LNK
- QB-8150-EPR / LNK
- QB-8151-EPR / LNK

#### 3.1.1 Hardware Overview

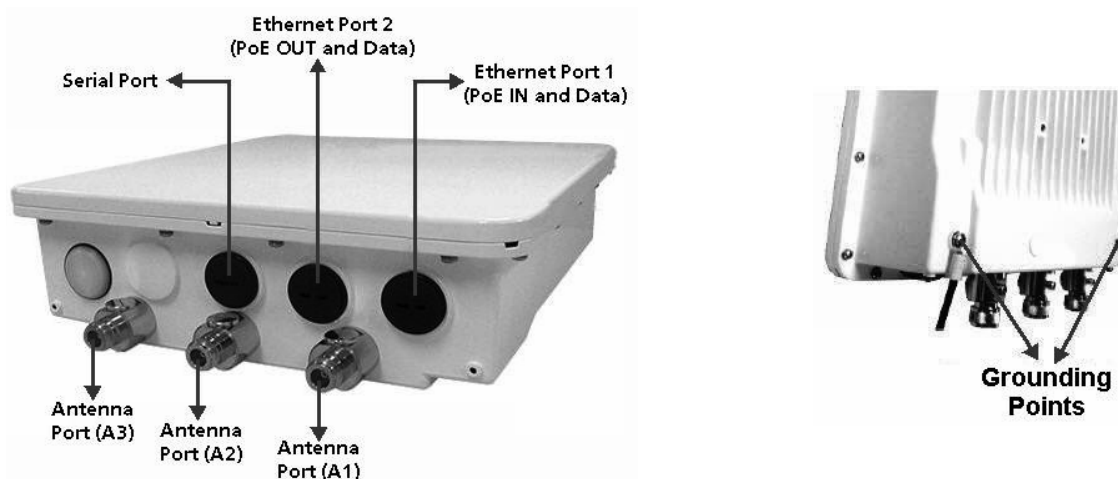

Figure 3-1 MP-8100-BSU /MP-8100-SUA /QB-8100-EPA

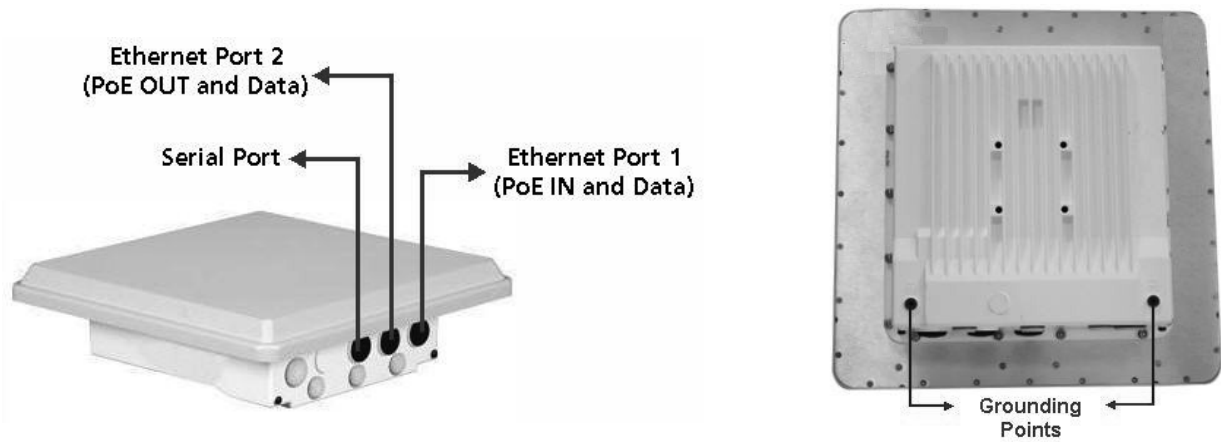

Figure 3-2 MP-8150-SUR / QB-8150-EPR / QB-8151-EPR

A detailed description about the various components of the device are explained in the following sections.

### 3.1.1.1 Gigabit Ethernet Ports

The device comes with two auto-sensing 10/100/1000 BASE-T Ethernet ports with configurable Tx modes and speeds.

#### 3.1.1.1.1 a) Ethernet Port 1

The Gigabit Ethernet port 1 (PoE IN and Data) of the device allows the user to connect to the LAN by using Cat5e/Cat6 Ethernet cable, and also power ON the device by using the Power over Ethernet (PoE) Injector supplied with the product package.

- The device receives 48 VDC via a a standard Cat5e/Cat6 cable connected between the PoE and the device.
- Maximum power supplied to the device is 32 Watts and the device typically draws 6 Watts.

Above 0° Celsius internal temperature, the device need not regulate its temperature, so the power drawn is generally lower in this temperature range. When the internal temperature gets close to the limits, the device starts to heat itself and the power draw increases. Powering the device when it is cold, triggers a special self-heat mode where the device is inoperable until the internal temperature is above -20° Celsius. This is signaled by a solid yellow LED on the Ethernet connector. Once the internal temperature is above -20° Celsius, the device boots normally.

Recommended Ethernet Cable Specifications	
Type	Cat5e/Cat6, STP, 24 AWG, UL rated, UV-shielded and outdoor-rated
Impedance	100 ohms
Cable Length	330 feet / 100 meters
	 : The total length of cabling between the Personal Computer and the device cannot exceed 100 meters (includes cable from the Personal Computer to the PoE, and the cable from the PoE to the device). Due to DC power requirements, the maximum cable length between the PoE Injector and the device is 75 meters.



: Always use a straight cable from PoE to the device. When you use a 4-pair cross over ethernet cable, the reload functionality gets activated and forcibly deletes the operating image.

**3.1.1.1.2 b) Ethernet Port 2**

The Gigabit Ethernet Port 2 is used for PoE OUT and data.

While using this port, the following points should be considered:

- 48 VDC (15 W average) is present on the second Ethernet port. Make sure the connected device can support this voltage.
- If power from the second Ethernet Port is desired, then Proxim recommends you to use 60W PoE (not supplied).
- If a device is connected to the second Ethernet port for data only, then use a PoE Splitter (not supplied).

**3.1.1.2 Serial Port**

The Serial Port is used for debugging and management, and Audible Antenna Alignment through Command Line Interface (CLI).

The serial connection is established with an RJ11 to DB9 connector (also referred to as a “dongle”) by connecting the RJ1 end of the dongle connector to the device and the other end to your Personal Computer.

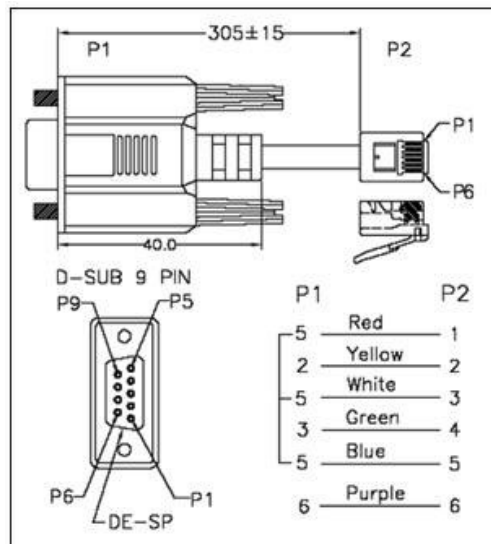

**Figure 3-3 Serial Components**

The pin assignments for DB9 connector are as follows:

D-Shell	RJ11
1	NC
2	2
3	4
4	NC
5	1 + 3 + 5
6	6
7	NC
8	NC
9	NC



*The pin6 on RJ11 connector is used as input for 12V DC IN for diagnostic purpose. Supplying power on this pin, when the device is powered by POE injector, might damage the device.*

**3.1.1.3 Antenna Ports**



: Applicable only to MP-8100-BSU, MP-8100-SUA and QB-8100-EPA/LNK.

The Antenna Ports A1, A2 and A3 are used to connect external antenna (s). These antenna connectors are of N-Type female with built-in surge protection.







: Use antenna port A1 for single polarization antennas, and antenna ports A1 and A3 for dual polarization antennas. By default, A1 and A3 ports are enabled. Enable A2 port, in case you are using 3\*3 antennas.













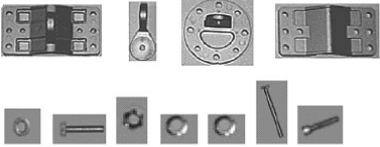











**3.1.1.4 Grounding Points**

To protect the device against lightning or ESD events, you must ground the device properly. To ensure proper grounding, use either of the ground points that are situated at the bottom corner of the device and the grounding screw (#8-32 thread size) provided to attach a ground wire of at least 10 AWG stranded to the device.

**3.1.2 Product Package**

Each shipment includes the items listed in the following table. Please verify that you have received all the parts in this shipment, prior to installation.

What's in the Kit	Image
MP-8100-BSU/ MP-8100-SUA/ MP-8150-SUR/ QB-8100-EPA/ QB-8150-EPR/ QB-8151-EPR	 <p style="text-align: center;"> <b>MP-8100-BSU/SUA</b>  <b>QB-8100-EPA</b> </p> <p style="text-align: center;"> <b>MP-8150-SUR</b>  <b>QB-8150-EPR / QB-8151-EPR</b> </p>
PoE Injector with Country specific Power Cord  <i>WD - US, UK and EU power cords</i> <i>US - US power cord</i> <i>EU - UK and EU power cords</i>	
RJ11 to DB9 Serial Connector	
Connector Weather Proofing Kit (2 sets)	
EMI Toroids	

What's in the Kit	Image																								
PoE Surge Arrestor																									
Grounding Kit																									
Quick Installation Guide																									
Mounting Kit and Hardware	<p>The mounting kit includes the following:</p>  <p>Mounting clamp for wall/pole            Extension arm            Mounting plate to enclosure            Mounting clamp for pole mounting</p> <p>The following table lists the items included with the mounting kit:</p> <table border="1" data-bbox="649 1265 1326 1946"> <thead> <tr> <th>Quantity</th> <th>Description</th> <th>Image</th> </tr> </thead> <tbody> <tr> <td>6 each</td> <td>Plain washer #5/16</td> <td></td> </tr> <tr> <td>2 each</td> <td>Hex Cap Screw NC 5/16-18 x 35</td> <td></td> </tr> <tr> <td>2 each</td> <td>Nut NC 5/16-18</td> <td></td> </tr> <tr> <td>4 each</td> <td>Helical Spring Lock Washer #1/4</td> <td></td> </tr> <tr> <td>4 each</td> <td>Helical Spring Lock Washer #5/16</td> <td></td> </tr> <tr> <td>2 each</td> <td>Hex Cap Screw NC 5/16-18 x 80</td> <td></td> </tr> <tr> <td>4 each</td> <td>68764, Screw, Machine, Pan, Philips, 1/4"-20, 5/8" L</td> <td></td> </tr> </tbody> </table>	Quantity	Description	Image	6 each	Plain washer #5/16		2 each	Hex Cap Screw NC 5/16-18 x 35		2 each	Nut NC 5/16-18		4 each	Helical Spring Lock Washer #1/4		4 each	Helical Spring Lock Washer #5/16		2 each	Hex Cap Screw NC 5/16-18 x 80		4 each	68764, Screw, Machine, Pan, Philips, 1/4"-20, 5/8" L	
Quantity	Description	Image																							
6 each	Plain washer #5/16																								
2 each	Hex Cap Screw NC 5/16-18 x 35																								
2 each	Nut NC 5/16-18																								
4 each	Helical Spring Lock Washer #1/4																								
4 each	Helical Spring Lock Washer #5/16																								
2 each	Hex Cap Screw NC 5/16-18 x 80																								
4 each	68764, Screw, Machine, Pan, Philips, 1/4"-20, 5/8" L																								





: QB-8100-LNK, QB-8150-LNK, and QB-8151-LNK contains two sets of all the above accessories.

### 3.1.3 Installation Procedure

This section describes the steps to install and mount the device(s).



: Please note that we have taken MP-8100-BSU as an example to explain the steps to install and mount the device. Please correlate the same with your device.



: **The device must be installed by a trained professional who is familiar with radio frequency planning and regulatory limits.**

Perform the following steps to install and mount the device.

#### Step 1: Plan for Installation

There are several planning factors to be considered before installing the device. In addition to selecting the installation site, you should do the following:

Calculate:

- Required RSL and fade margin to achieve link availability objectives. For more details on how to calculate RSL and fade margin, please refer to the 'Antenna Installation Guide' and 'Proxim Link Calculator' that are available on the support site at <http://my.proxim.com>.
- Required path availability
- Anticipated multi-path reflection points

Determine:

- System frequency plan
- Required antenna mounting height to obtain proper path clearance
- Required transmission line types (like cable, waveguides) and lengths

Plan for:

- Device's continuous power consumption needs
- Lightning protection and system grounding
- Hardware mounting
- Cable installation including egress
- Pre-testing equipment (back-to-back test procedure)

#### Step 2: Choose a Location

To make optimal use of the device, you must find a suitable location to install the hardware. The range of the radio device largely depends upon the position of the antenna. Proxim recommends you do a site survey, observing the following requirements, before mounting the hardware.

- The location must allow easy disconnection of power to the radio, if necessary.
- Ensure free flow of air around the hardware.
- The radio device must be kept away from vibration and excessive heat.
- The installation must conform to local regulations at all times.

The devices are designed to directly mount to a pole. By using the supplied brackets and hardware, you can mount them to a 1.25 inch to 3-inch pole (outside diameter). Longer bolts (not supplied) are required to mount the device to a larger diameter pole. By using the same pole mounting bracket, you can mount the device to a wall or other flat surface.

### Step 3: Gather Required Tools

You should have the following tools available before installing the device:

- Cross-tip screwdrivers
- Small blade standard screwdriver
- Large blade standard screwdriver
- Wire crimpers (if using connectors that are not pre-made)
- Adjustable 6" wrench
- Weatherproofing material for sealing external connectors (such as butyl tape)
- Straight-through UV-protected STP-rated Cat5e/Cat6 Ethernet cable for connecting to PC, or cable for connecting to a hub or a switch.

### Step 4: Unpack the Product Package

1. Unpack the device and its accessories from the shipping box.
2. Please make a note of the Ethernet addresses, the MAC addresses and the serial number. These addresses may be used when configuring the device. Note that the serial number helps you to seek support from the Proxim's Customer support team.

### Step 5: Weatherproofing RJ45 Connectors

The following steps explain how to weatherproof the RJ45 connectors:

1. Use a straight-through cable (Cat5e/Cat6) with one end bare.
2. Connect the crimped RJ45 connector end of the cable into the RJ45 Ethernet port inside the enclosure. The cable connector should latch into the Ethernet port.
3. Slide the Flat Washer (A) into the Connector Body (B) to make it waterproof and onto the bare end of the cable. Next, fasten the Connector Body into the Ethernet connector hole on the device.
4. Slide the tube-shaped Compression Washer (C) into the Compression Ring (D) and onto the cable from the bare end, and insert into the fixed Connector Body.
5. Slide the Sealing Nut (E) over the bare end of the cable and fasten it on the fixed Connector Body.
6. Crimp the bare end of the cable with RJ45 connector and connect it to the **PWR LAN-OUT** port on the PoE Injector.
7. Open the notch on both sides of the toroid and fix it on Ethernet Cat5e/Cat6 cable. Then, lock the notch of the Toroid by pressing it.



: Please ensure to fix toroids to the Ethernet cables.

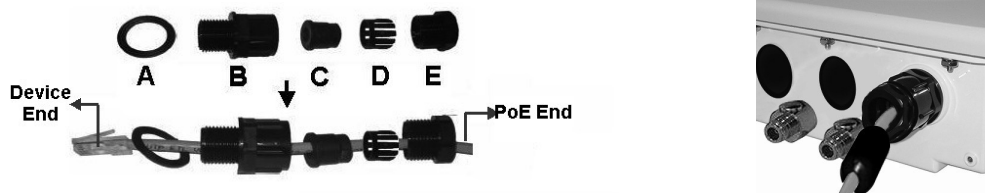

Figure 3-4 Weatherproofing RJ45 Connector

**Additional Weatherproofing Steps**

To add an additional layer of protection to the connectors against the environment, see Appendix - Additional Weatherproofing Steps.

For detailed explanation to weatherproof RF connections, refer to *Antenna Installation Guide*, which is available at <http://my.proxim.com>.

**Step 6: Assemble Mounting Hardware**

1. Fix the Mounting Plate (A) by using the provided screws and washers (Torque 9 N·m/75 in-lbs).

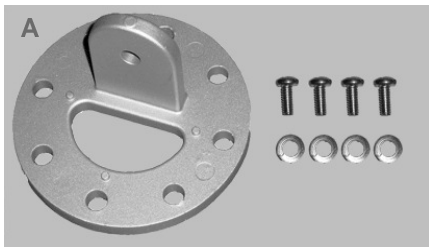

**Mounting Plate**

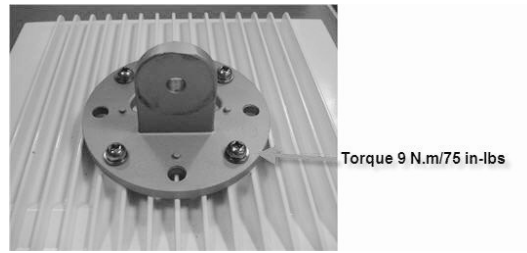

**Mounting Plate fixed to the device**

2. Fix the Extension Arm (B) to the fixed Mounting Plate with the provided screw, nut and washers. The Extension Arm gives the device more possible tilt, letting you adjust for azimuth or elevation over a larger angle.



**Extension Arm**

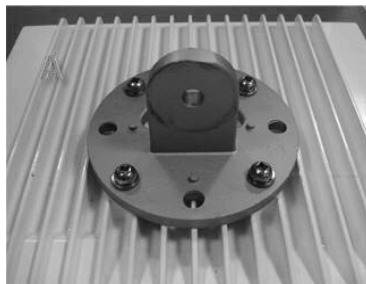

**Mounting Plate fixed to the device**

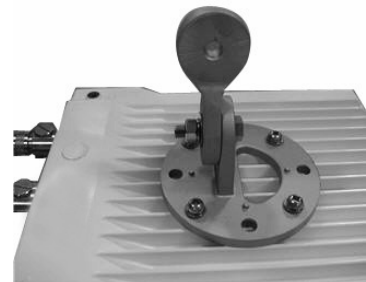

**Extension Arm fixed to Mounting Plate**

3. Fix the Mounting Bracket (C) to fixed Extension Arm with the provided screw, nut and washers.

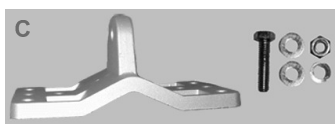

**Mounting Bracket**

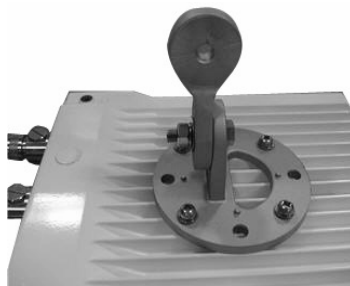

**Extension Arm fixed to Mounting Plate**



**Mounting Bracket fixed to Extension Arm**

4. Tighten the assembled parts (Torque 15 N·m/130 in-lbs).



The following figure shows the fully assembled mounting hardware fixed to the device.

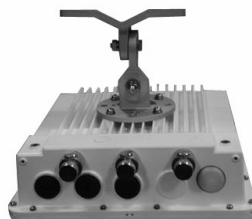

Figure 3-5 Assembled Device

### Step 7: Mount the Device

1. To pole-mount the device, insert the provided screws and washers through bracket (F). Fasten around the pole to bracket (C) and secure (Torque 11 N.m/100 in-lbs).

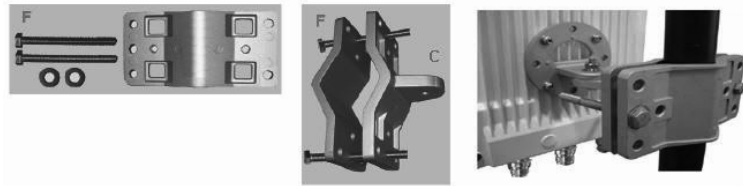

Figure 3-6 Pole Mounting

2. To wall-mount the device, mount the bracket (C) to a wall by using 4 screws (not supplied), as shown:

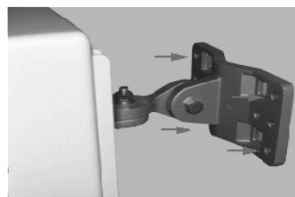

Figure 3-7 Wall Mounting

### Step 8: Plug in the Cables



*Unscrew the sealing cap for installation of the cable.*

1. Plug one end of the straight-through Cat5e/Cat6 cable into the Ethernet Port 1 of the device by following the Weatherproofing steps as explained in Step 5. Connect the other end of the cable into the **PWR LAN-OUT** port on the PoE Injector.



: Always use a straight cable from PoE to the device. When you use a 4-pair cross over ethernet cable, the reload functionality gets activated and forcibly deletes the operating image.



**Figure 3-8 Cable Plugged In**

2. Plugging in the second Cat5e/Cat6 cable into the Ethernet Port 2 interface of the device is optional. While using the second Ethernet Port for PoE OUT and data, the following should be considered:
  - 48 VDC (15 W average) is present on the second Ethernet port. Make sure the connected device can support this voltage.
  - If power from the second Ethernet Port is desired, then Proxim recommends to use 60W PoE (not supplied).
  - If the device is connected to the second Ethernet port for data, then use a PoE Splitter (not supplied)
3. Optionally, connect a RJ11 to DB9 Serial Connector to device's Serial Port for debugging and management, and audible antenna alignment.



**Figure 3-9 PoE Injector**

4. To connect the device through a hub or a switch to a Personal Computer, connect an Ethernet cable between the network interface card in the Personal Computer and the hub, and between the hub and the RJ45 **LAN-IN** port on the PoE injector.
5. To connect the device directly to a Personal Computer, connect an Ethernet cable between the network interface card in the Personal Computer and the RJ45 **LAN-IN** port on the PoE Injector.

### Step 9: Connect the Antenna



: Applicable only to MP-8100-BSU, MP-8100-SUA and QB-8100-EPA/LNK.

Connect the antenna to the device antenna port by connecting the straight N-male end of the cable to the device antenna port and the right angle N-male end of the cable at the antenna.



: Record which port each antenna polarization is associated with to ensure that each side matches and aid in configuration.

### Step 10: Install Surge Protector

Proxim recommends two approved lightning surge protectors to be installed, one near to the device and the other at the building ingress point.



: For an additional Surge Protector, place an order separately with your distributor.

Perform the following steps to ensure proper surge protection:

1. Mount the provided surge protector near the outdoor device and use 10 AWG or a better gauge wire to connect the protector's ground lug to the appropriate mounting ground point. The outdoor device and co-located surge protector should have a common grounding point using the shortest possible grounding cable.
2. Mount a second surge protector near the building ingress and use 10 AWG or a better gauge wire to connect the surge protector's ground lug to earth ground as shown in the figure below.

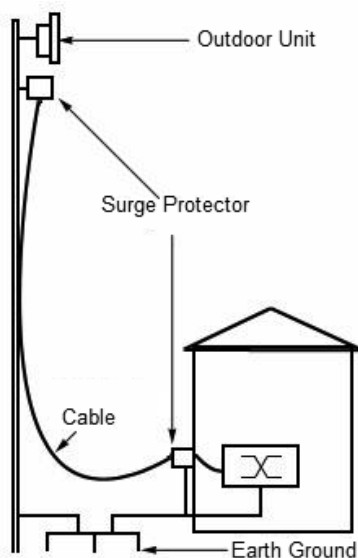

Figure 3-10 Surge Protector



: Use Outdoor-rated, UV protected, shielded Cat5e/Cat6 cable for the following:

3. Connect an RJ45 terminated cable between the indoor device and to the port on the surge protector at the building ingress.
4. Connect a short RJ45 terminated cable between the outdoor device and the port on the co-located surge protector.
5. Connect an RJ45 terminated cable between the two surge protectors on their remaining ports.



: Ensure to loop the cable before entering the premise to prevent water ingress.



### Step 11: Ground the Unit

To ensure proper grounding, use either of the ground points which are situated at the bottom corners of the device and the grounding screw(#8-32 thread size) provided to attach a ground wire of at least 10 AWG stranded to the device. It is

important that the following ground guidelines are followed during installations to protect the device against lightning or ESD events:

1. Connect one end of the grounding cable to the device and the other end to the closest earthing system point at the installation.
2. Cut any extra ground wire length when finished connecting it to the single point earth ground.
3. Avoid sharp bends and never loop or coil up the ground wire, always connect it straight to ground.
4. A good earth ground impedance is less than 1.0 ohm.
5. Measure ground impedance at the point where the protector ground wire is connected and not at the ground rod.
6. Connect the surge protector ground wire and equipment ground (both power ground and telecomm ground) to a single common ground.
7. Make sure all connections are fastened securely and are tight.
8. Never install during a storm and always follow your local safety codes.

Connect the grounding wire, which is supplied with the product package, to the device as shown below:



Figure 3-11 Ground the Device

### Step 12: Power ON the Device

Plug in the power cord into a power outlet after having connected the Power Injector and the radio device by using straight-through Cat5e/Cat6 cable. There is no ON/OFF switch on the device. To disconnect power, unplug the RJ45 connector from the **PWR LAN-OUT** port on the power injector.

### Step 13: View LEDs

When the device is powered on, it performs startup diagnostics. When startup is complete, the LEDs show the device's operational state. The LEDs are available at the device's Ethernet connector inside the enclosure. You can see the LEDs through the ethernet connector. The LEDs will not be visible if the RJ45 connector is weatherproofed.

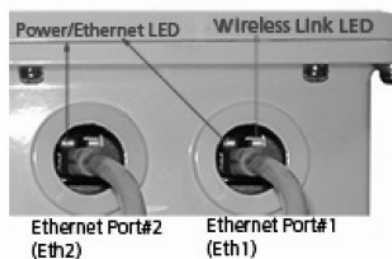

Figure 3-12 View LEDs

The following table states the status of LEDs and the corresponding operational state of the device:

LED State	Ethernet 1	
	Power/Ethernet LED	Wireless LED
Yellow	Device is self heating (Cold Start)	Power is ON and the device detects Reload signal

LED State	Ethernet 1	
	Power/Ethernet LED	Wireless LED
Off	No Power	Radio is not present or failed to detect
Blinking Green-Fast	Power is ON and the Ethernet link on Ethernet 1 is down	Radio is ON and wireless link has not been established yet
Blinking Green (5 times) and turns off	Bootloader detected no image	Not Applicable
Green	Power is ON and the Ethernet link on Ethernet 1 is UP	Wireless link has been established

LED State	Ethernet 2	
	Power/Ethernet LED	Wireless LED
Yellow	Not Applicable	Not Applicable
Off	No Power	Normal Operation
Blinking Green-Fast	Power is ON and the Ethernet link on Ethernet 2 is down	Not Applicable
Blinking Green (5 times) and turns off	Bootloader detected no image	Not Applicable
Green	Power is ON and the Ethernet link on Ethernet 2 is UP	Not Applicable

### Step 14: Align the Antennas

Antenna alignment is the process of physically aligning the antenna of the radio receiver and transmitter to have the best possible link established between them. The antenna alignment process is usually performed during installation and after major repairs. If you are installing external antennas, refer to the documentation that accompanies the antenna for installation instructions.

The device has an audible antenna alignment tool that can be activated by plugging in the supplied RJ11 serial dongle. It is audible upto 30 minutes. The CLI command enables both audible and numerical feedback as the CLI shows the running Signal-to-Noise Ratio (SNR) values twice a second.

The output from the beeper for antenna alignment consists of short beeps with a variable interval. The interval changes with the SNR level to assist in correctly aligning the antenna. An increase in signal level is indicated by a shorter interval between beeps and a reduction in signal level results in beeps longer apart.

The alignment process averages the SNR, which is represented by an average length beep. When a higher SNR is received, the beep period becomes shorter. A lower SNR results in a longer period between beeps.

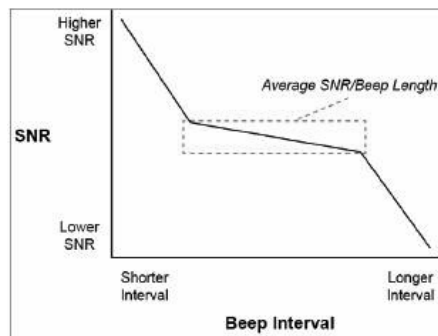

Figure 3-13 Beep Interval

When the antenna is aimed, the beep intuitively represents whether the SNR is rising or falling. The higher the SNR rises, the shorter the period of the beep is heard and the higher the frequency of the beep. When you change the position of the



antenna, SNR averaging settles at the new value and the beeping returns to the average length so the antenna can again be aimed for rising SNR.

Aiming is complete if moving in any direction results in a falling SNR value (which can be heard as longer periods between beeps).



- *The range of the average SNR has been limited to values from 5 to 43; therefore, anything over 43 always results in a short period between beeps and values below 5 always have a long period.*
- *The Antenna Alignment Display (AAD) CLI output is disabled automatically 30 minutes after it is enabled to remove the load of extra messages on the wireless interface. The default telnet time-out is 300 seconds (5 minutes).*

### Antenna Alignment Commands

To enable the antenna alignment display from the CLI prompt, enter the following commands:

- **aad enable local**: Enables display of the local signal, noise and SNR.
- **aad enable remote**: Enables display of the remote signal, noise and SNR.
- **aad enable**: Enables display of local and remote signal, noise and SNR.



*Use a flat blade screw driver to disconnect and pull out the Serial cable from the enclosure after the antenna alignment is done. After withdrawing the cables, seal the serial port carefully to avoid water seepage.*

## 3.2 MP-8160-BSU / MP-8160-SUA / MP-8160-BS9

This section provides the hardware overview and installation procedure for the following products:

- MP-8160-BSU
- MP-8160-BS9
- MP-8160-SUA

### 3.2.1 Hardware Overview

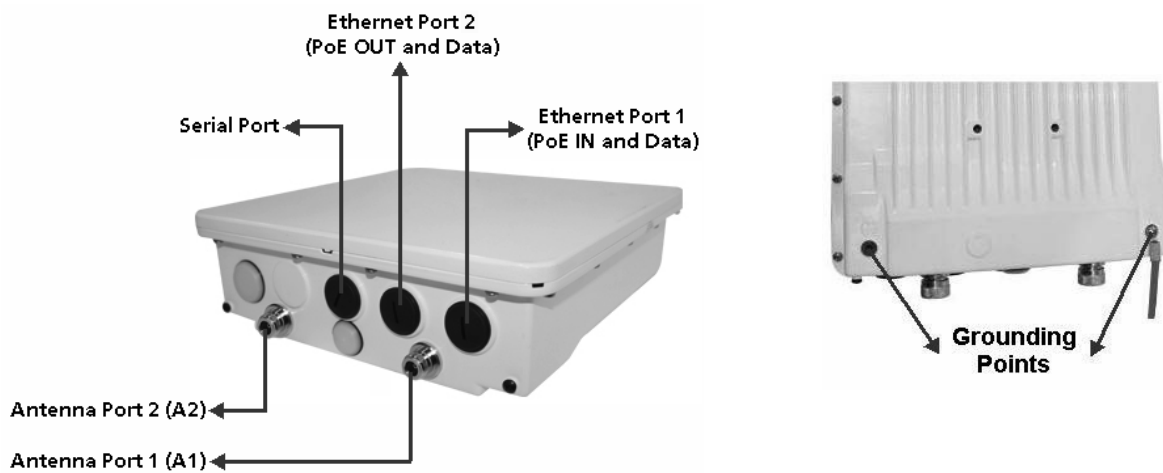

Figure 3-14 MP-8160-BSU / MP-8160-SUA

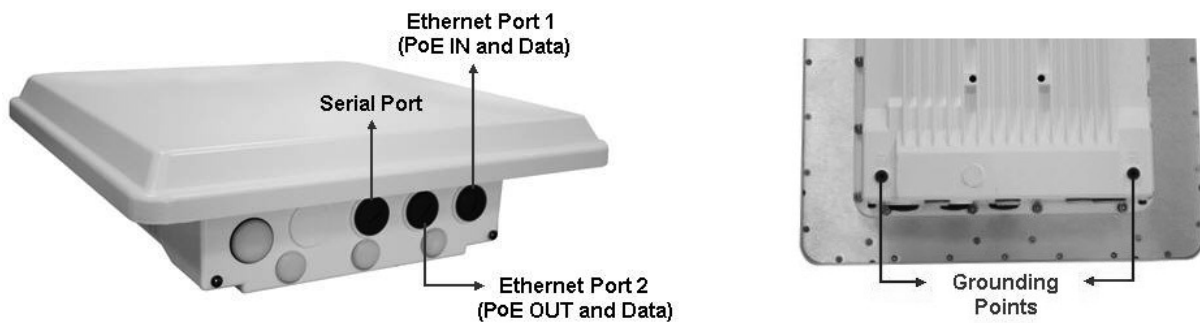

Figure 3-15 MP-8160-BS9

A detailed description about the various components of the device are explained in the following sections.

#### 3.2.1.1 Gigabit Ethernet Ports

The device comes with two auto-sensing 10/100/1000 BASE-T Ethernet ports with configurable Tx modes and speeds.

##### a) Ethernet Port 1 (PoE IN and Data)

The Gigabit Ethernet port 1 (PoE IN and Data) of the device allows the user to connect to the LAN by using Cat5e/Cat6 Ethernet cable, and also power ON the device by using the Power over Ethernet (PoE) Injector supplied with the product package.

- The device receives 48 VDC via a standard Cat5e/Cat6 cable connected between the PoE and the device.

- Maximum power supplied to the device is 32 Watts and the device typically draws 10 Watts.

Above 0° Celsius internal temperature, the device need not regulate its temperature, so the power drawn is generally lower in this temperature range. When the internal temperature gets close to the limits, the device starts to heat itself and the power draw increases. Powering the device when it is cold, triggers a special self-heat mode where the device is inoperable until the internal temperature is above -20° Celsius. This is signaled by a solid yellow LED on the Ethernet connector. Once the internal temperature is above -20° Celsius, the device boots normally.

Recommended Ethernet Cable Specifications	
Type	Cat5e/Cat6, STP, 24 AWG, UL rated, UV-shielded and outdoor-rated
Impedance	100 ohms
Cable Length	330 feet / 100 meters
	 : The total length of cabling between the Personal Computer and the device cannot exceed 100 meters (includes cable from the Personal Computer to the PoE, and the cable from the PoE to the device. Due to DC power requirements, the maximum cable length between the PoE Injector and the device is 75 meters.



: Always use a straight cable from PoE to the device. When you use a 4-pair cross over ethernet cable, the reload functionality gets activated and forcibly deletes the operating image.

### 3.2.1.1.1 b) Ethernet Port 2 (PoE OUT and Data)

The Gigabit Ethernet Port 2 is used for PoE OUT and Data.

While using this port, the following points should be considered:

- 48 VDC (15 W average) is present on the second Ethernet port. Make sure the connected device can support this voltage.
- If power from the second Ethernet Port is desired, then Proxim recommends you to use 60W PoE (not supplied).
- If a device is connected to the second Ethernet port for data only, then use a PoE Splitter (not supplied).

### 3.2.1.2 Serial Port

The Serial Port is used for debugging and management, and Audible Antenna Alignment through Command Line Interface (CLI).

The serial connection is established with an RJ11 to DB9 connector (also referred to as a “dongle”) by connecting the RJ11 end of the dongle connector to the device and the other end to your Personal Computer.

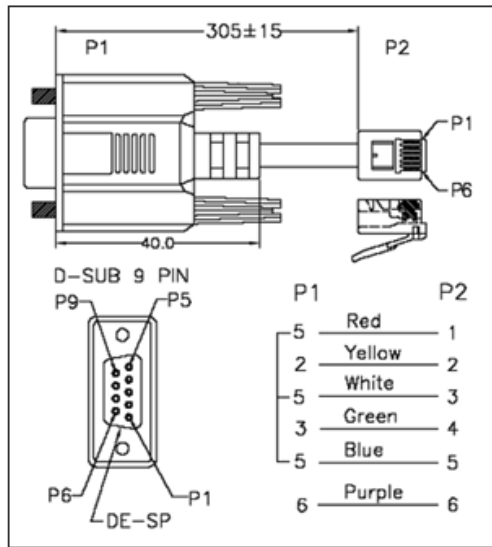

Figure 3-16 Serial Components

The pin assignments for DB9 connector are as follows:

D-Shell	RJ11
1	NC
2	2
3	4
4	NC
5	1 + 3 + 5
6	6
7	NC
8	NC
9	NC



The pin6 on RJ11 connector is used as input for 12V DC IN for diagnostic purpose. Supplying power on this pin, when the device is powered by POE injector, might damage the device.

### 3.2.1.3 Antenna Ports



Applicable only to MP-8160-BSU and MP-8160-SUA.







The Antenna Ports A1 and A2 are used to connect external antenna(s). These antenna connectors are of N-Type female.









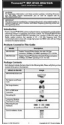

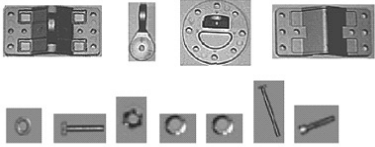











### 3.2.1.4 Grounding Point

To protect the device against lightning or ESD events, you must ground the device properly. To ensure proper grounding, use either of the ground points that are situated at the bottom corner of the device and the grounding screw (#8-32 thread size) provided to attach a ground wire of at least 10 AWG stranded to the device.

**3.2.2 Product Package**

Each shipment includes the items listed in the following table. Please verify that you have received all the parts in this shipment, prior to installation.

What's in the Kit	Image
MP-8160-BSU/ MP-8160-SUA/ MP-8160-BS9	 <p style="text-align: center;"> <b>MP-8160-BSU/ MP-8160-SUA</b> <span style="margin-left: 150px;"><b>MP-8160-BS9</b></span> </p>
Gigabit PoE Injector and Power Cord  <i>WD - US, UK and EU power cords</i>	
RJ11 to DB9 Serial Connector	
Connector Weather Proofing Kit (2 sets)	
Gigabit PoE Surge Arrestor	
Grounding Kit	
Quick Installation Guide	

What's in the Kit	Image																								
Mounting Kit and Hardware	<div style="text-align: center;">  </div> <p>The mounting kit includes the following:</p> <ul style="list-style-type: none"> <li>• Mounting clamp for wall/pole</li> <li>• Extension arm</li> <li>• Mounting plate to enclosure</li> <li>• Mounting clamp for pole mounting</li> </ul> <p>The following table lists and describes some of the items included with the mounting kit:</p> <table border="1" data-bbox="651 922 1324 1603"> <thead> <tr> <th>Quantity</th> <th>Description</th> <th>Image</th> </tr> </thead> <tbody> <tr> <td>6 each</td> <td>Plain washer #5/16</td> <td></td> </tr> <tr> <td>2 each</td> <td>Hex Cap Screw NC 5/16-18 x 35</td> <td></td> </tr> <tr> <td>2 each</td> <td>Nut NC 5/16-18</td> <td></td> </tr> <tr> <td>4 each</td> <td>Helical Spring Lock Washer #1/4</td> <td></td> </tr> <tr> <td>4 each</td> <td>Helical Spring Lock Washer #5/16</td> <td></td> </tr> <tr> <td>2 each</td> <td>Hex Cap Screw NC 5/16-18 x 80</td> <td></td> </tr> <tr> <td>4 each</td> <td>68764, Screw, Machine, Pan, Philips, 1/4"-20, 5/8" L</td> <td></td> </tr> </tbody> </table>	Quantity	Description	Image	6 each	Plain washer #5/16		2 each	Hex Cap Screw NC 5/16-18 x 35		2 each	Nut NC 5/16-18		4 each	Helical Spring Lock Washer #1/4		4 each	Helical Spring Lock Washer #5/16		2 each	Hex Cap Screw NC 5/16-18 x 80		4 each	68764, Screw, Machine, Pan, Philips, 1/4"-20, 5/8" L	
Quantity	Description	Image																							
6 each	Plain washer #5/16																								
2 each	Hex Cap Screw NC 5/16-18 x 35																								
2 each	Nut NC 5/16-18																								
4 each	Helical Spring Lock Washer #1/4																								
4 each	Helical Spring Lock Washer #5/16																								
2 each	Hex Cap Screw NC 5/16-18 x 80																								
4 each	68764, Screw, Machine, Pan, Philips, 1/4"-20, 5/8" L																								

### 3.2.3 Installation Procedure



*Please note that we have taken MP-8160-BSU as an example to explain the steps to install and mount the device. Please correlate the same with your device.*



**The device must be installed by a trained professional who is familiar with radio frequency planning and regulatory limits.**

Perform the following steps to install and mount the device.

### Step 1: Plan for Installation

There are several planning factors to be considered before installing the device. In addition to selecting the installation site, you should do the following:

Calculate:

- Required RSL and fade margin to achieve link availability objectives. For more details on how to calculate RSL and fade margin, please refer to the *'Antenna Installation Guide'* and *'Proxim Link Calculator'* that are available on the support site at <http://my.proxim.com>.
- Required path availability
- Anticipated multi-path reflection points

Determine:

- System frequency plan
- Required antenna mounting height to obtain proper path clearance
- Required transmission line types (like cable, waveguides) and lengths

Plan for:

- Device's continuous power consumption needs
- Lightning protection and system grounding
- Hardware mounting
- Cable installation including egress
- Pre-testing equipment (back-to-back test procedure)

### Step 2: Choose a Location

To make optimal use of the device, you must find a suitable location to install the hardware. The range of the radio device largely depends upon the position of the antenna. Proxim recommends you do a site survey, observing the following requirements, before mounting the hardware.

- The location must allow easy disconnection of power to the radio, if necessary.
- Ensure free flow of air around the hardware.
- The radio device must be kept away from vibration and excessive heat.
- The installation must conform to local regulations at all times.

The devices are designed to directly mount to a pole. By using the supplied brackets and hardware, you can mount them to a 1.25 inch to 3-inch pole (outside diameter). Longer bolts (not supplied) are required to mount the device to a larger diameter pole. By using just one of the pole mounting brackets, you can mount the device to a wall or other flat surface.

### Step 3: Gather Required Tools

You should have the following tools available before installing the device:

- Cross-tip screwdrivers
- Small blade standard screwdriver
- Large blade standard screwdriver
- Wire crimpers (if using connectors that are not pre-made)
- Adjustable 6" wrench
- Weatherproofing material for sealing external connectors (such as butyl tape)
- Straight-through UV-protected STP-rated Cat5e/Cat6 Ethernet cable for connecting to PC, or cable for connecting to a hub or a switch.

## Step 4: Unpack the Product Package

- Unpack the device and its accessories from the shipping box.
- Please make a note of the Ethernet addresses, the MAC addresses and the serial number. These addresses may be used when configuring the device. Note that the serial number helps you to seek support from the Proxim's Customer support team.

## Step 5: Weatherproofing RJ45 Connectors

The following steps explain how to weatherproof the RJ45 connectors:

1. Use a straight-through cable (Cat5e/Cat6) with one end bare.
2. Connect the crimped RJ45 connector end of the cable into the RJ45 Ethernet port inside the enclosure. The cable connector should latch into the Ethernet port.
3. Slide the Flat Washer (A) into the Connector Body (B) to make it waterproof and onto the bare end of the cable. Next, fasten the Connector Body into the Ethernet connector hole on the device.
4. Slide the tube-shaped Compression Washer (C) into the Compression Ring (D) and onto the cable from the bare end, and insert into the fixed Connector Body.
5. Slide the Sealing Nut (E) over the bare end of the cable and fasten it on the fixed Connector Body.
6. Crimp the bare end of the cable with RJ45 connector and connect it to the **PWR LAN-OUT** port on the PoE Injector.

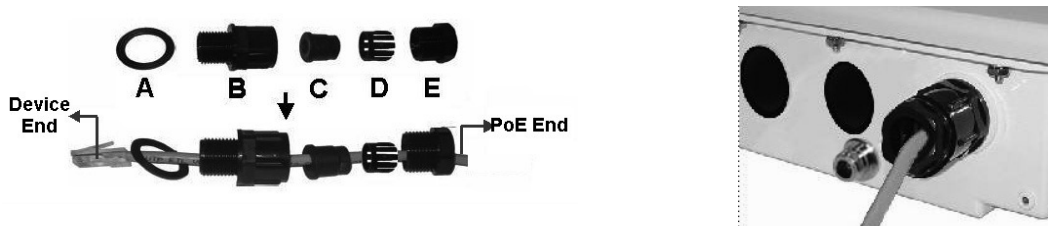

Figure 3-17 Weatherproofing RJ45 Connector

### Additional Weatherproofing Steps

To add an additional layer of protection to the connectors against the environment, see Appendix - Additional Weatherproofing Steps.

For detailed explanation to weatherproof RF connections, refer to *Antenna Installation Guide*, which is available at <http://my.proxim.com>.

## Step 6: Assemble Mounting Hardware

1. Fix the mounting plate (A) by using the provided screws and washers (Torque 9 N.m/75 in-lbs).

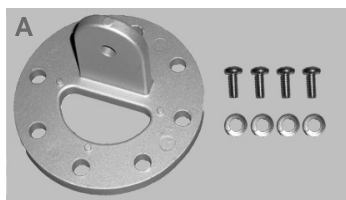

Mounting Plate

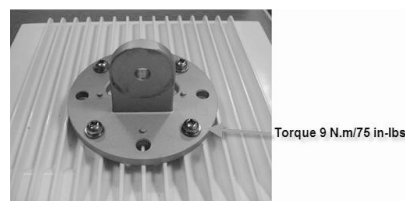

Mounting Plate fixed to the device

2. Fix the extension arm (B) to the fixed mounting plate with the provided screw, nut and washers. The extension arm gives the device more possible tilt, letting you adjust for azimuth or elevation over a larger angle.





**Extension Arm**

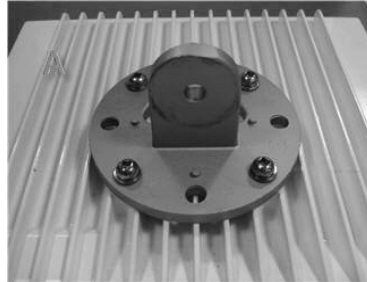

**Mounting Plate fixed to the device**

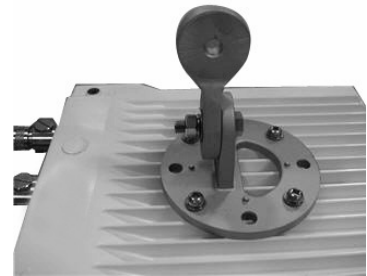

**Extension Arm fixed to Mounting Plate**

3. Fix the mounting bracket (C) to fixed extension arm with the provided screw, nut and washers.

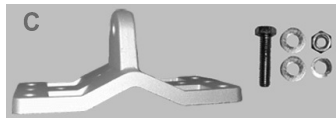

**Mounting Bracket**

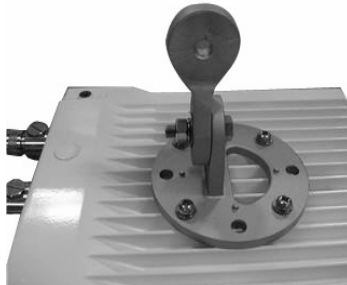

**Extension Arm fixed to Mounting Plate**



**Mounting Bracket fixed to Extension Arm**

4. Tighten the assembled parts (Torque 15 N·m/130 in-lbs).



The following figure shows the full assembled mounting hardware fixed to the device.



**Figure 3-18 Assembled Device**

## Step 7: Mount the Device

1. To pole-mount the device, insert the provided screws and washers through bracket (F). Fasten around the pole to bracket (C) and secure (Torque 11 N.m/100 in-lbs).

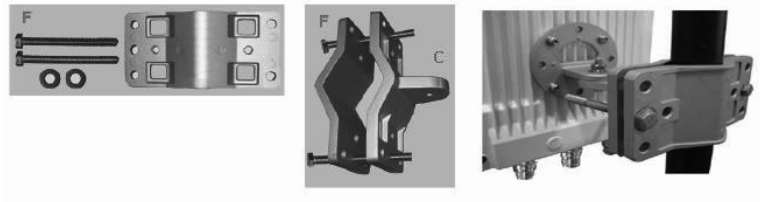

Figure 3-19 Pole Mounting

2. To wall-mount the device, mount the bracket (C) to a wall using 4 screws (not provided), as shown:

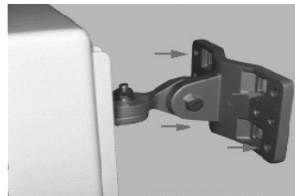

Figure 3-20 Wall Mounting

## Step 8: Plug in the Cables



: Unscrew the sealing cap for installation of the cable.

1. Plug one end of the straight-through Cat5e/Cat6 cable into the Ethernet Port 1 of the device by following the Weatherproofing steps as explained in Step 5. Connect the other end of the cable into the **PWR LAN-OUT** port on the PoE Injector.



: Always use a straight cable from PoE to the device. When you use a 4-pair cross over ethernet cable, the reload functionality gets activated and forcibly deletes the operating image.



Figure 3-21 Cable Plugged In

2. Plugging in the second Cat5e/Cat6 cable into the Ethernet Port 2 interface of the device is optional. While using the second Ethernet Port for PoE OUT and data, the following should be considered:
  - 48 VDC (15 W average) is present on the second Ethernet port. Make sure the connected device can support this voltage.
  - If power from the second Ethernet Port is desired, then Proxim recommends to use 60W PoE (not supplied).
  - If the device is connected to the second Ethernet port for data, then use a PoE Splitter (not supplied).

3. Optionally, connect a RJ11 to DB9 Serial Connector to device's Serial Port for debugging and management, and audible antenna alignment.



**Figure 3-22 PoE Injector**

4. To connect the device through a hub or a switch to a Personal Computer, connect an Ethernet cable between the network interface card in the Personal Computer and the hub, and between the hub and the RJ45 "LAN-IN" port on the PoE Injector.
5. To connect the device directly to a Personal Computer, connect an Ethernet cable between the network interface card in the Personal Computer and the RJ45 "LAN IN" port on the PoE Injector.

### Step 9: Connect the Antenna



*:Applicable only to MP-8160-BSU and MP-8160-SUA.*

Connect the antenna to the device antenna port by connecting the straight N-male end of the cable to the device antenna port and the right angle N-male end of the cable at the antenna.



*: Record which port each antenna polarization is associated with to ensure that each side matches and aid in configuration.*

### Step 10: Install Surge Protector

Proxim recommends two approved lightning surge protectors to be installed, one near to the device and the other at the building ingress point.



*: For an additional Surge Protector, place an order separately with your distributor.*

Perform the following steps to ensure proper surge protection:

1. Mount the provided surge protector near the outdoor device and use 10 AWG or a better gauge wire to connect the protector's ground lug to the appropriate mounting ground point. The outdoor device and co-located surge protector should have a common grounding point by using the shortest possible grounding cable.
2. Mount a second surge protector near the building ingress and use 10 AWG or a better gauge wire to connect the surge protector's ground lug to earth ground as shown in the figure below.

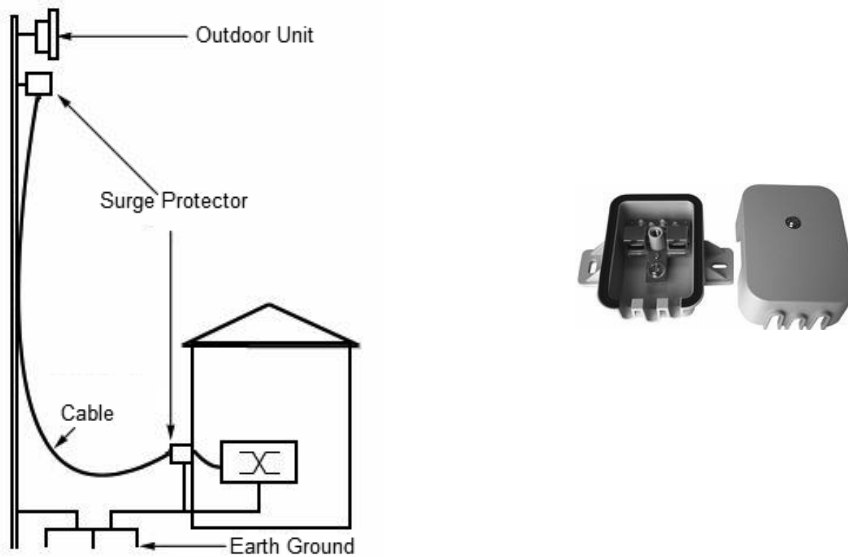

Figure 3-23 Surge Protector



: Use Outdoor-rated, UV protected, shielded Cat5e/Cat6 cable for the following:

3. Connect an RJ45 terminated cable between the indoor device and to the port on the surge protector at the building ingress.
4. Connect a short RJ45 terminated cable between the outdoor device and the port on the co-located surge protector.
5. Connect an RJ45 terminated cable between the two surge protectors on their remaining ports.



: Ensure to loop the cable before entering the premise to prevent water ingress.



### Step 11: Ground the Unit

To ensure proper grounding, use either of the ground points which are situated at the bottom corners of the device and the grounding screw(#8-32 thread size) provided to attach a ground wire of at least 10 AWG stranded to the device. It is important that the following ground guidelines are followed during installations to protect the device against lightning or ESD events:

1. Connect one end of the grounding cable to the device and the other end to the closest earthing system point at the installation.
2. Cut any extra ground wire length when finished connecting it to the single point earth ground.
3. Avoid sharp bends and never loop or coil up the ground wire, always connect it straight to ground.
4. A good earth ground impedance is less than 1.0 ohm.
5. Measure ground impedance at the point where the protector ground wire is connected and not at the ground rod.
6. Connect the surge protector ground wire and equipment ground (both power ground and telecomm ground) to a single common ground.
7. Make sure all connections are fastened securely and are tight.
8. Never install during a storm and always follow your local safety codes.

Connect the grounding wire, which is supplied with the product package, to the device as shown below:



Figure 3-24 Ground the device

### Step 12: Power ON the Device

Plug in the power cord into a power outlet after having connected the PoE Injector and the device using Cat5e/Cat6 cable. There is no ON/OFF switch on the device. To disconnect power, unplug the RJ45 connector from the “PWR LAN-OUT” port on the PoE injector.

### Step 13: View LEDs

When the device is powered on, it performs startup diagnostics. When startup is complete, the LEDs show the device's operational state. The LEDs are available at the device's Ethernet connector inside the enclosure. You can see the LEDs through the ethernet connector. The LEDs will not be visible if the RJ45 connector is weatherproofed.

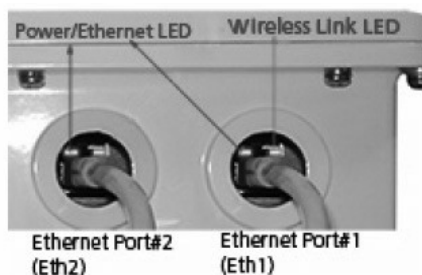

Figure 3-25 View LEDs

The following table describes the status of LEDs:

LED State	Ethernet 1	
	Power/Ethernet LED	Wireless LED
Yellow	Device is self heating (Cold Start)	Power is ON and the device detects Reload signal
Off	No Power	Radio is not present or failed to detect
Blinking Green-Fast	Power is ON and the Ethernet link on Ethernet 1 is DOWN	Radio is ON and wireless link has not been established yet
Blinking Green (5 times) and turns off	Bootloader detected no image	Not Applicable
Green	Power is ON and the Ethernet link on Ethernet 1 is UP	Wireless link has been established

LED State	Ethernet 2	
	Power/Ethernet LED	Wireless LED
Yellow	Not Applicable	Not Applicable
Off	No Power	Normal Operation

Blinking Green-Fast	Power is ON and the Ethernet link on Ethernet 2 is DOWN	Not Applicable
Blinking Green (5 times) and turns off	Bootloader detected no image	Not Applicable
Green	Power is ON and the Ethernet link on Ethernet 2 is UP	Not Applicable

### Step 14: Align the Antenna

Antenna alignment is the process of physically aligning the antenna of the radio receiver and transmitter to have the best possible link established between them. The antenna alignment process is usually performed during installation and after major repairs. If you are installing external antennas, refer to the documentation that accompanies the antenna for installation instructions.

The device has an audible antenna alignment tool that can be activated by plugging in the supplied RJ11 serial dongle. It is audible upto 30 minutes. The CLI command enables both audible and numerical feedback as the CLI shows the running Signal-to-Noise Ratio (SNR) values twice a second.

The output from the beeper for antenna alignment consists of short beeps with a variable interval. The interval changes with the SNR level to assist in correctly aligning the antenna. An increase in signal level is indicated by a shorter interval between beeps and a reduction in signal level results in beeps longer apart.

The alignment process averages the SNR, which is represented by an average length beep. When a higher SNR is received, the beep period becomes shorter, A lower SNR results in a longer period between beeps.

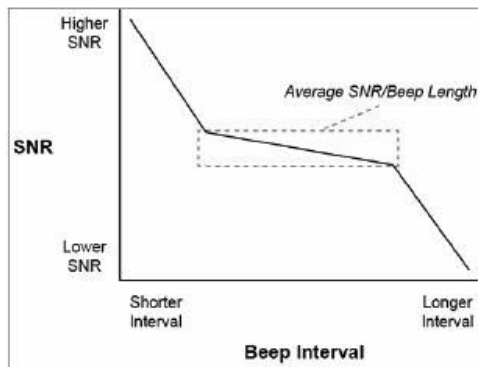

Figure 3-26 Beep Interval

When the antenna is aimed, the beep intuitively represents whether the SNR is rising or falling. The higher the SNR rises, the shorter the period of the beep is heard and the higher the frequency of the beep.

When you change the position of the antenna, SNR averaging settles at the new value and the beeping returns to the average length so the antenna can again be aimed for rising SNR.

Aiming is complete if moving in any direction results in a falling SNR value (which can be heard as longer periods between beeps).



- The range of the average SNR has been limited to values from 5 to 43; therefore, anything over 43 always results in a short period between beeps and values below 5 always have a long period.
- The Antenna Alignment Display (AAD) CLI output is disabled automatically 30 minutes after it is enabled to remove the load of extra messages on the wireless interface. The default telnet time-out is 300 seconds (5 minutes).

### Antenna Alignment Commands

To enable the antenna alignment display from the CLI prompt, enter the following commands:

- **aad enable local**: Enables display of the local signal, noise and SNR.
- **aad enable remote**: Enables display of the remote signal, noise and SNR.
- **aad enable**: Enables display of local and remote signal, noise and SNR.



*Use a flat blade screw driver to disconnect and pull out the Serial cable from the enclosure after the antenna alignment is done. After withdrawing the cables, seal the serial port carefully to avoid water seepage.*

### 3.3 MP-8150-CPE / QB-8150-LNK-12/50

This section provides the hardware overview and installation method for the following products:

- MP-8150-CPE
- QB-8150-LNK-12/50

#### 3.3.1 Hardware Overview

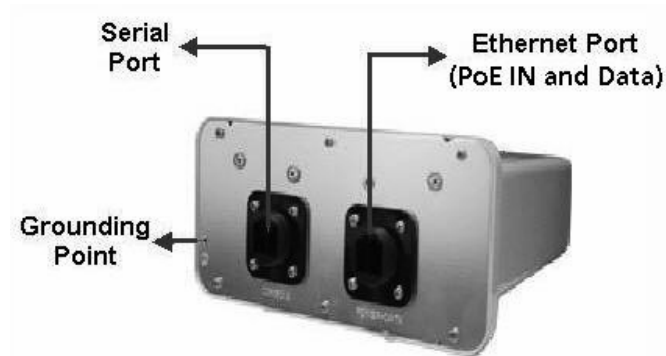

Figure 3-27 MP-8150-CPE / QB-8150-EPR-12 / QB-8150-EPR-50

A detailed description about the various components of the device are explained in the following sections.

##### 3.3.1.1 Ethernet Port (PoE IN and Data)

The device comes with auto-sensing 10/100 BASE-T Ethernet port with configurable Tx modes and speeds.

The Ethernet port of the device allows the user to connect to the LAN by using Cat5/5e or better Ethernet cable, and also power ON the device by using the Power over Ethernet (PoE) Injector supplied with the product package.

- The device receives 48 VDC via a standard Cat5/5e or better cable connected to the Ethernet port.
- Maximum power supplied to the device is 19 Watts. The device typically draws 7 Watts.

Recommended Ethernet Cable Specifications	
Type	Cat5/5e or better cable, STP, 24 AWG, UL rated, UV-shielded and outdoor-rated
Impedance	100 ohms
Cable Length	330 feet / 100 meters
	 : The total length of cabling between the Personal Computer and the device cannot exceed 100 meters (includes cable from the PC to the PoE, and the cable from the PoE to the device). Due to DC power requirements, the maximum cable length between the PoE Injector and the device is 75 meters.



: Always use a straight cable from PoE to the device. When you use a 4-pair cross over ethernet cable, the reload functionality gets activated and forcibly deletes the operating image.

##### 3.3.1.2 Serial Port

The Serial Port is used for debugging and management of the device through Command Line Interface (CLI).



The serial connection is established with an RJ11 to DB9 connector (also referred to as a “dongle”) by connecting the RJ11 end of the dongle connector to the device and the other end to your Personal Computer.

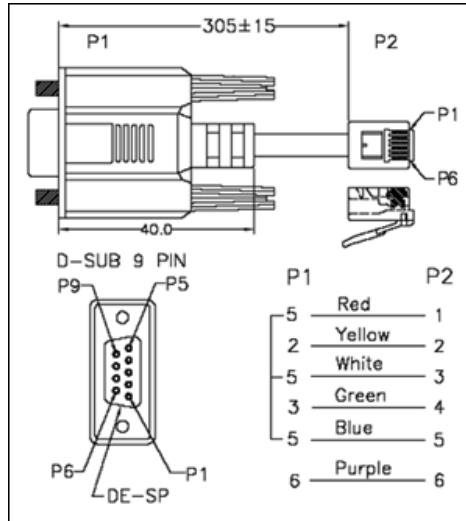

Figure 3-28 Serial Components

The pin assignments for DB9 connector are as follows:

D-Shell	RJ11
1	NC
2	2
3	4
4	NC
5	1 + 3 + 5
6	6
7	NC
8	NC
9	NC























*The pin6 on RJ11 connector is used as input for 12V DC IN for diagnostic purpose. Supplying power on this pin, when the device is powered by POE injector, might damage the device.*

### 3.3.1.3 Grounding Point

To protect the device against lightning or ESD events, you must ground the device properly. To ensure proper grounding, ground a wire of at least 12 AWG stranded to the grounding screw (M3 thread size) which is fixed to the bottom corner of the device.

### 3.3.2 Product Package

Each shipment includes the items listed in the following table. Please verify that you have received all the parts in this shipment, prior to installation.

What's in the Kit	Image																		
MP-8150-CPE/ QB-8150-EPR-12/ QB-8150-EPR-50																			
PoE Injector with Country specific Power Cord  <i>WD - US, UK and EU power cords US - US power cord</i>																			
Connector Weatherproofing Kit																			
Grounding Kit																			
Pole Mounting Kit	<p>The mounting kit includes the following:</p> <table border="1" data-bbox="707 1173 1267 1677"> <thead> <tr> <th>Component Name</th> <th>Image</th> <th>Quantity</th> </tr> </thead> <tbody> <tr> <td>M6-16 Screw</td> <td></td> <td>2</td> </tr> <tr> <td>M6 Spring Washer</td> <td></td> <td>2</td> </tr> <tr> <td>M6 Plain Washer</td> <td></td> <td>2</td> </tr> <tr> <td>Hose Clamp</td> <td></td> <td>2</td> </tr> <tr> <td>Mounting Bracket</td> <td></td> <td>1</td> </tr> </tbody> </table>	Component Name	Image	Quantity	M6-16 Screw		2	M6 Spring Washer		2	M6 Plain Washer		2	Hose Clamp		2	Mounting Bracket		1
Component Name	Image	Quantity																	
M6-16 Screw		2																	
M6 Spring Washer		2																	
M6 Plain Washer		2																	
Hose Clamp		2																	
Mounting Bracket		1																	
Quick Installation Guide																			



: The QuickBridge Links (QB-8150-LNK-12 and QB-8150-LNK-50) contains two sets of all the above listed items.

### 3.3.3 Installation Procedure

This section describes the steps to install and mount the device(s).



*The device must be installed by a trained professional who is familiar with radio frequency planning and regulatory limits.*

Perform the following steps to install and mount the device.

#### Step 1: Plan for Installation

There are several planning factors to be considered before installing the device. In addition to selecting the installation site, you should do the following:

Calculate:

- Required RSL and fade margin to achieve link availability objectives. For more details on how to calculate RSL and fade margin, please refer to the 'Antenna Installation Guide' and 'Proxim Link Calculator' that are available on the support site at <http://my.proxim.com>.
- Required path availability
- Anticipated multi-path reflection points

Determine:

- System frequency plan
- Required transmission line types (like cable, waveguides) and lengths

Plan for:

- Device's continuous power consumption needs
- Lightning protection and system grounding
- Hardware mounting
- Cable installation including egress
- Pre-testing equipment (back-to-back test procedure)

#### Step 2: Choose a Location

To make optimal use of the device, you must find a suitable location to install the hardware. Proxim recommends you do a site survey, observing the following requirements, before mounting the hardware.

- The location must allow easy disconnection of power to the radio, if necessary.
- Ensure free flow of air around the hardware.
- The radio device must be kept away from vibration and excessive heat.
- The installation must conform to local regulations at all times.

#### Step 3: Gather Required Tools

You should have the following tools available before installing the device:

- Cross-tip screwdrivers
- Large blade standard screwdriver
- Spanner 10
- Wire crimpers (if using RJ45 connector that is not pre-made)

### Step 4: Unpack the Product Package

- Unpack the device and its accessories from the shipping box.
- Please make a note of the Ethernet addresses, the MAC addresses and the serial number. These addresses may be used when configuring the device. Note that the serial number helps you to seek support from the Proxim's Customer support team.

### Step 5: Assemble the Cable

To assemble the Ethernet cable and weatherproof the RJ45 connector, do the following

1. Slide the Lock Nut (3) and Sealing Cap (2) over the bare end of an Ethernet cable (1) (Cat5/Cat5e or better) as shown in figure below:



Cat 5/Cat5e cable with bare end



Lock Nut and Sealing Cap



Lock Nut and Sealing Cap onto the Cat 5/Cat5e cable

2. Terminate the cable and crimp it with a standard RJ45 connector (4).



3. Insert the assembled cable into the **POWER + DATA** port of the device. Tighten the sealing cap and lock the nut.



### Additional Weatherproofing Steps

To add an additional layer of protection to the connectors against the environment, see Appendix - Additional Weatherproofing Steps.

### Step 6: Mount the Device

The device is designed to directly mount to a pole. By using the supplied brackets and hardware, you can mount them to a 1.25 inch to 3-inch pole (outside diameter). Longer bolts (not supplied) are required for mounting the device to a larger diameter pole. By using just one of the pole mounting brackets, you can mount the device to a wall or other flat surface. The device must always be mounted with all access ports of the integrated antenna pointed straight down to achieve horizontal and vertical polarization.

To pole mount the device, perform the following steps:

1. Ensure that the pole intended for installation is securely attached to a solid base.
2. Attach the mounting bracket (1) to the device with the provided screws and washers.



: Slide the M6-16 screw through the M6 Spring Washer first and then through M6 Plain Washer. Misplacement of the washers may cause damage to the device.



3. Slide the Hose Clamps (2) through the Mounting Bracket and place the Hose Clamps around the pole.



4. Insert the end of the hose clamps into the fastening clip and tighten the screw.



: Do not over tighten the screws at this stage, as the device may need adjustment to obtain good signal strength.

Proxim also provides an optional universal wall mounting kit bracket (P/N 1087-UMK); this kit is designed to mount the device directly to a flat surface such as a roof, wall, or under an eave.



Figure 3-29 Universal Mounting Bracket

## Step 7: Plug in the Cables

1. Plug one end of the Cat5/Cat5e or better Ethernet cable (5.5 mm/.217 in OD maximum) into the Ethernet (RJ45) jack of the device. Ensure that the cable connector is latched securely. You can hear a click sound when the cable connector latches into the jack, then tighten the sealing nut by hand.



*: Always use a straight cable from PoE to the device. When you use a 4-pair cross over ethernet cable, the reload functionality gets activated and forcibly deletes the operating image.*

2. Connect the other end of the Cat5/Cat5e or better cable to the **LAN+DC** port on the PoE Injector.



**Figure 3-30 PoE Injector**

3. To connect the device directly to a Personal Computer, connect an Ethernet cable between the network interface card in the Personal Computer and the RJ45 **LAN** port on the PoE Injector.
4. To connect the device through a hub or a switch to a Personal Computer, connect an Ethernet cable between the network interface card in the Personal Computer and the hub. Connect another Ethernet cable between the hub and the RJ45 **LAN** port on the PoE Injector.

## Step 8: Install Surge Protector

Proxim recommends two approved lightning surge protectors to be installed, one near to the device and the other at the building ingress point.



*: To buy a suitable Surge Protector, place an order separately with your distributor.*

Perform the following steps to ensure proper surge protection:

1. Mount the provided surge protector near the outdoor device and use 10 AWG or a better gauge wire to connect the protector's ground lug to the appropriate mounting ground point. The outdoor device and co-located surge protector should have a common grounding point by using the shortest possible grounding cable.
2. Mount a second surge protector near the building ingress and use 10 AWG or a better gauge wire to connect the surge protector's ground lug to earth ground as shown in the figure below.

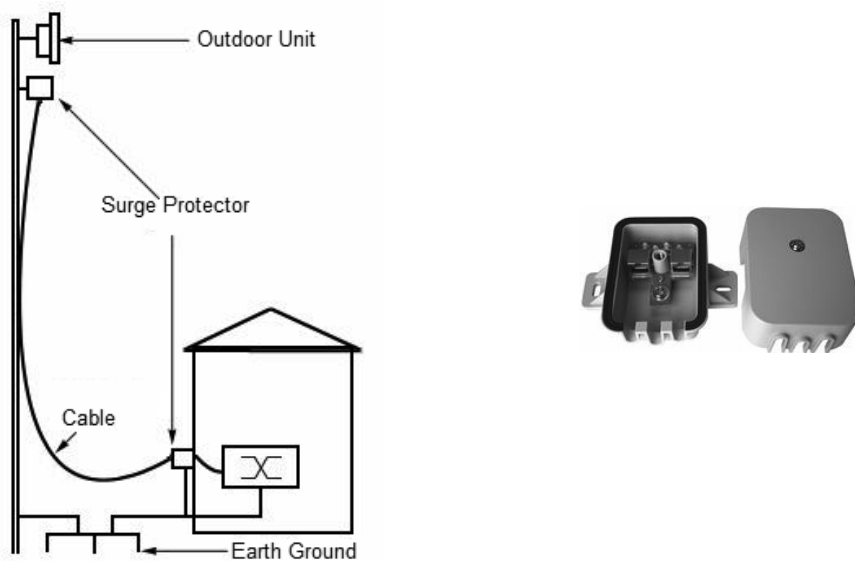

Figure 3-31 Surge Protector



*Use Outdoor-rated, UV protected, shielded Cat5/Cat5e or better cable for the following:*

3. Connect an RJ45 terminated cable between the indoor device and to the port on the surge protector at the building ingress.
4. Connect a short RJ45 terminated cable between the outdoor device and the port on the co-located surge protector.
5. Connect an RJ45 terminated cable between the two surge protectors on their remaining ports.



*Ensure to loop the cable before entering the premise to prevent water ingress.*



### Step 9: Ground the Device

To ensure proper grounding, ground a wire of atleast 12 AWG stranded to the grounding screw (M3 thread size) which is fixed to the bottom corner of the device. It is important to note that the following ground guidelines are followed during installations:

1. Connect one end of the grounding cable to the device and the other end to the closest earthing system point at the installation.
2. Cut any extra ground wire length when finished connecting it to the single point earth ground.
3. Avoid sharp bends and never loop or coil up the ground wire, always connect it straight to ground.
4. A good earth ground impedance is less than 1.0 ohm.
5. Measure ground impedance at the point where the protector ground wire is connected and not at the ground rod.
6. Connect the protector ground wire and equipment ground (both power ground and telecomm ground) to a single common ground.
7. Make sure all connections are fastened securely and are tight.
8. Never install during a storm and always follow your local safety codes.

Connect the grounding wire, which is supplied with the product package, to the grounding lug as shown below:



Figure 3-32 Grounding the Device

**Step 10: Power ON the Device**

Plug in the power cord into a power outlet after connecting the PoE Injector to the device by using Cat5/Cat5e or better cable. There is no ON/OFF switch on the device. To disconnect power, unplug the RJ45 connector from the **LAN+DC** port on the PoE Injector.

**Step 11: View LEDs**

When the device is powered on, it performs startup diagnostics. When startup is complete, the LEDs show the device's operational state. The LEDs are available at the device Ethernet connector inside the enclosure. You can see the LEDs through the ethernet connector. The LEDs will not be visible if the RJ45 connector is weatherproofed.

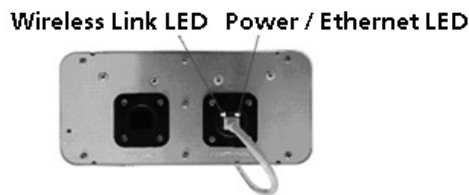

Figure 3-33 LEDs

The following table states the status of LEDs and the corresponding operational state of the device:

LED State	Ethernet interface	
	Power/Ethernet LED	Wireless LED
Off	No Power	Radio is not present or failed to detect
Amber	No Application Image detected (In Bootloader CLI / ScanTool mode)	Power is ON and device detects Reload signal
Blinking Green	Power is ON and the Ethernet link is down	Radio is detected but wireless link has not been established yet
Solid Green	Power is ON and the Ethernet link is up.	Radio is detected and wireless link has been established