

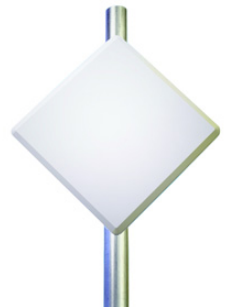

ORiNOCO Series System Recommended Antennas



Copyright

©2008 Proxim Wireless Corporation, San Jose, CA. All rights reserved. Covered by one or more of the following U.S. patents: 5,231,634; 5,875,179; 6,006,090; 5,809,060; 6,075,812; 5,077,753. This manual and the software described herein are copyrighted with all rights reserved. No part of this publication may be reproduced, transmitted, transcribed, stored in a retrieval system, or translated into any language in any form by any means without the written permission of Proxim Wireless Corporation. Trademarks

Trademarks

Tsunami, Proxim, and the Proxim logo are trademarks of Proxim Wireless Corporation. All other trademarks mentioned herein are the property of their respective owners.

Safety and Regulatory Information

See the MeshMAX 5054 Series product CD for important Safety and Regulatory information.

1	Introduction	7
	Who Should Use This Guide	7
	Antenna Types	9
	Omni-Directional Antennas	9
	Flat Panel Directional Antennas	10
	Sector Antennas	10
	Parabolic Dish Antennas	11
	Summary	11
2	Recommended 900 MHz Antennas and Accessories	12
	Omni Antennas	12
	Sector Antennas	12
	Panel Antennas	13
	Cavity Filters	13
3	Recommended 2.4 GHz Antennas	14
	Omni Antennas	14
	5 dBi Omni-Directional Vehicle Antenna (848 515 722)	14
	7 dBi Omni-Directional Base Station Antenna (848 312 591)	16
	10 dBi Omni-Directional Base Station Antenna (848 515 698)	18
	Sector Antennas	20
	12 dBi Directional Wide Angle Antenna (120°) (848 515 706)	20
	14 dBi Sector Antenna (60°) (2400-SA60-14)	22
	Panel Antennas	24
	14 dBi Directional Panel Antenna (1086-PA24-14)	24
	Parabolic Antennas	26
	24 dBi Directional Parabolic Grid Antenna (848 515 714)	26
4	Recommended 4.9 GHz Antennas	28
	Omni Antennas	28
	8 dBi Omni-Directional Antenna (1086-OA49-8)	28
	10 dBi Omni-Directional Antenna (1086-OA49-10)	30
	Panel Antennas	32
	10 dBi Panel Antenna (1086-PA49-10)	32
	21 dBi Panel Antenna (1086-PA49-21)	34
	Sector Antennas	36
	14 dBi Sector Antenna (120°) (5054-SA120-14)	36
	17 dBi Sector Antenna (60°) (5054-SA60-17)	38
5	Recommended 5 GHz Antennas	40
	Omni-Directional Antennas	40
	8 dBi Omni-Directional Antenna (5054-OA-8)	40

10 dBi Omni-Directional Antenna (5054-OA-10)	42
Other Recommended Omni-Antennas	44
Sector Antennas	45
14 dBi Sector Antenna (120°) (5054-SA120-14)	45
17 dBi Sector Antenna (60°) (5054-SA60-17)	47
Other Recommended Sector Antennas	49
Panel Antennas	50
15 dBi Window Antenna (5054-WA-15-STN)	50
18 dBi Panel Antenna (5054-PA-18)	52
23 dBi Panel Antenna (5054-PA50-23)	54
Other Recommended Panel Antennas	56
Parabolic Antennas	57
6 Technical Services and Support	58
Obtaining Technical Services and Support	58
Support Options	59
Proxim eService Web Site Support	59
Telephone Support	59
ServPak Support	59

Introduction

This *Recommended Antennas* guide supplements the *Tsunami MP.11 Antenna Installation Guide*.

The *Antenna Installation Guide* explains how to install and set up an outdoor antenna with the Tsunami MP.11 hardware devices.

This guide does not explain how to erect antenna masts, nor how to install a safety grounding system. These prerequisites must be in place before installing the directional antenna.

See the following sections:

- [Who Should Use This Guide](#)
- [Antenna Types](#)

Who Should Use This Guide

The installation of outdoor wireless links requires technical expertise. At the very least, you should be able to:

- Install and configure the network components, such as the radio hardware.
- Understand, or have a working knowledge of, installation procedures for network operating systems using Microsoft Windows.
- Mount the outdoor antenna and surge arrestor. Antenna installation must be provided by professional installers.

NOTE: *A basic rule for selecting a combination of cables and antennas is that no combination is allowed unless explicitly approved in the Tsunami MP.11 Antenna Installation Guide for your MP.11 model. Therefore, always use Tsunami MP.11 Recommended Antennas in combination with “Chapter 4. Determining Range and Clearance” of the Antenna Installation Guide to select the correct type of antenna equipment and to inform your antenna installer and LAN administrator about the impact of regulatory constraints on their job or activities.*

WARNING: *The outdoor antennas to be used with these products are intended for mounting on an antenna tower, on a roof, or on the side of a building. Installation is not to be attempted by someone not trained or experienced in this type of work. The antenna must be installed by a suitably trained professional installation technician or by a qualified antenna installation service. The site prerequisites must be checked by a person familiar with the national electrical code and with other regulations governing this type of installation.*

IMPORTANT!

Local radio regulations or legislation may impose restrictions on the use of specific combinations of:

- Low-loss antenna cables and outdoor antennas
- Radio channels selected at the radios that are connected to specific outdoor antennas

At all times, it is the customer's responsibility to ensure that an outdoor antenna installation complies with local radio regulations. The customer must verify that:

- The antenna installer is aware of these regulations
- The correct cable type and surge arrestor have been used

Proxim Wireless Corporation and its resellers or distributors are not liable for any damage or violation of government regulations that may arise from failing to comply with these guidelines.

If you are not certain about the regulations that apply in your country, consult your local Proxim Wireless Corporation Sales Office.

Antenna Types

Wireless radios generate signals on a given frequency. Antennas distribute that signal through the air in a particular pattern. Antennas take a given power output and make it reach further by reducing directions along which the signal is radiated. Concentrating the signal on your workspace makes better use of your wireless radio's power output. Stations inside your workspace get stronger coverage and, therefore, higher speed. Directing the signal where you want it also means less signal where you don't want it; stations outside your workspace get little or no coverage.

Directional antennas (omni, sector, parabolic, flat) provide maximum range, but due to their narrow beamwidth, these antennas require precise antenna alignment to achieve optimal performance. The higher the antenna gain, the more precise the alignment should be.

Directional antennas are typically used to connect:

- A Base Station and a Subscriber Station in a point-to-point link
- A Subscriber Station in a point-to-multipoint network

See the following sections:

- [Omni-Directional Antennas](#)
- [Flat Panel Directional Antennas](#)
- [Sector Antennas](#)
- [Parabolic Dish Antennas](#)

Omni-Directional Antennas

Omni antennas radiate the signal 360 degrees horizontally; however, they increase gain by flattening the radiated signal pattern, producing a vertical beam between 80 degrees (modest gain) and 7 degrees (high gain). Gain makes the signal travel further.

These antennas have an omni-directional azimuth pattern that makes them easy to install. There is also a gain-to-beamwidth relation for omni-directional antennas: the higher the gain of the omni-antenna, the narrower the vertical beamwidth. In a hilly terrain, an 8 dBi omni-directional antenna can be a better solution than the 10 dBi omni-directional antenna, because the lower gain antenna has a larger vertical beamwidth. The larger vertical beamwidth allows signal coverage to a greater elevation, which in turn allows coverage higher up hillsides. This effect could be useful when the antenna is located at a low elevation such as a valley floor.

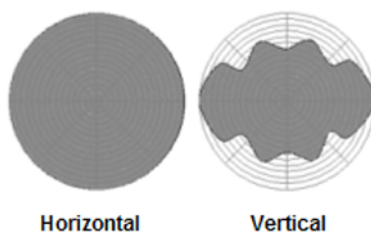

Figure 1-1 Omni-Directional Antenna Coverage

Flat Panel Directional Antennas

Flat panel directional antennas produce hemispherical coverage, spreading away from the mount point at a width of 30 to 180 degrees typically. Concentrating the signal on this smaller area increases system range.

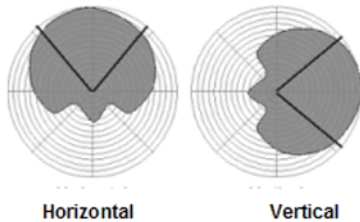
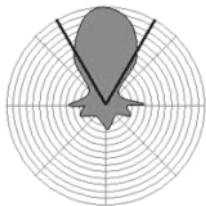

Figure 1-2 Flat Panel Antenna Coverage

Sector Antennas

Sector antennas are high-gain directional antennas. These cylinders contain a boom supporting thin vertical rods. The signal propagates off the front of the boom. Note that some signal (back lobes) fall behind the boom. Sector antennas create higher gain by producing narrower beams (20 – 80 H, 14 – 64 V).

The wide-angle sector antenna is a good Base Station antenna for hilly terrain. It combines a wide opening angle “sector” with relatively high gain. The mounting brackets allow tilting of the antenna. This antenna also is used when the amount of traffic in a cell is too high for a single Base Station with an omni-directional antenna. The wide-angle antenna allows dividing the cell into three sectors that each can be serviced by a Base Station.



Horizontal and Vertical

Figure 1-3 Sector Antenna Coverage

Parabolic Dish Antennas

Parabolic antennas are concave panels or bowls that produce an extremely narrow beam (4 – 25 degrees horizontal / vertical).

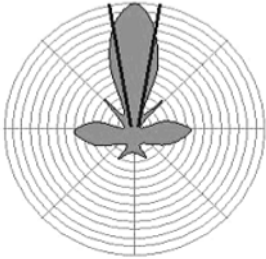

Horizontal and Vertical

Figure 1-4 Parabolic Dish Antenna Coverage

Summary

Omni Directional Antenna

An omni-directional antenna may be used in an outdoor environment to provide coverage to areas where it is not practical to use an antenna system that takes advantage of sectorized coverage. As an example, if an area needing coverage is a hillside and the base station is located on a valley floor, an omni-directional antenna could be a better choice than a more traditional sector antenna such as a panel antenna. The omni-directional antenna would allow valley floor coverage with coverage extending up a hillside. Such coverage is likely not possible with a panel antenna because of the reduced radiation at high elevation angles from the antenna. This is a result of the shape of the antenna beam radiating from the panel antenna design.

Flat Panel Directional Antenna

A flat panel antenna is frequently used for sectorized base station installations where it is desirable to provide coverage in a limited azimuthal direction. This is useful in providing reduced interference from out of coverage areas and increasing throughput by increased signal strength inside in coverage areas. Since a reduced azimuth area is covered, the radio sees fewer subscribers and can provide increased bandwidth to each.

Sector

Sector antennas are better for corridors, hallways, tunnels, long narrow buildings, and point-to-point medium range connections between outdoor bridges (for example, connecting two buildings in an office park or campus). Be wary of back lobes, but the sector's narrow beam will reduce unwanted peripheral exposure in the focal direction.

Parabolic

Parabolic antennas are better for long-range outdoor point-to-point connectors, such as bridges that are miles apart. They require more precise installation to aim signal where you want it, but have the very high gain necessary to reach such distances.

NOTE:

- All Proxim radios require professional installation.
- Antennas with gain less than 8 dBi are not allowed.
- Antennas of other makes can be used with the, but must be of the same type, dimensions, and gain as those listed.

Recommended 900 MHz Antennas and

Accessories

- [Omni Antennas](#)
- [Sector Antennas](#)
- [Panel Antennas](#)

Omni Antennas

The following 900 MHz omni antenna has been certified with the Tsunami 954-R BSU. See the manufacturer's web site for more information.

Manufacturer	Model Number	Maximum Gain
Antel	BCD-87010	12

In addition, following 900 MHz omni antennas are available for use with the Tsunami 954-R BSU. See the manufacturer's web site for more information.

Type	Manufacturer	Model Number	Frequency Range (MHz)	Mid-Band Gain
Vertical polarization omni antenna	Mars	MA-W091-8X	902-928	8
Vertical polarization omni antenna	MTI	MT-262003/NV	902-928	8
Horizon polarization omni antenna	MTI	MT-262012/NH	902-928	10.5
Horizon polarization omni antenna	MTI	MT-243003/NH	902-928	11.5

Sector Antennas

The following 900 MHz sector antenna has been certified with the Tsunami 954-R BSU. See the manufacturer's web site for more information.

Manufacturer	Model Number	Maximum Gain
Antel	RWA-80017	19

In addition, following 900 MHz sector antennas are available for use with the Tsunami 954-R BSU. See the manufacturer's web site for more information.

Type	Manufacturer	Model Number	Frequency Range (MHz)	Mid-Band Gain
Vertical polarization 60° sector antenna	Mars	MA-WC90-5X	902-928	14.5
Horizon polarization 60° sector antenna	Mars	MA-WC91-5H	902-928	14
Vertical polarization 90° sector antenna	Mars	MA-WD90-6X	902-928	13

Recommended 900 MHz Antennas and Accessories ORiNOCO Series System Recommended Antennas
Panel Antennas

Type	Manufacturer	Model Number	Frequency Range (MHz)	Mid-Band Gain
Horizon polarization 90° sector antenna	Mars	MA-WD91-6H	902-928	12
Vertical polarization 120° sector antenna	Mars	MA-WE90-7X	902-928	11.5
Horizon polarization 120° sector antenna	Mars	MA-WE91-7H	902-928	11
Dual polarization 120° sector antenna	Mars	MA-WE91-2D	902-928	11.5
Horizon polarization 90° sector antenna	MTI	MT-264003/NH	902-928	13.5
Horizon polarization 120° sector antenna	MTI	MT-263004/NH	902-928	12.5
Horizon polarization 180° sector antenna	MTI	MT-243015/NH	902-928	10

Panel Antennas

The following 900 MHz panel antenna has been certified with the Tsunami 954-R SU. See the manufacturer's web site for more information.

Manufacturer	Model Number	Maximum Gain
MTI	MT-263006	12.5

In addition, following 900 MHz panel antennas are available for use with the Tsunami 954-R SU. See the manufacturer's web site for more information.

Type	Manufacturer	Model Number	Frequency Range (MHz)	Mid-Band Gain
1-foot panel antenna	ARC wireless	ANT-A-1714	902-928	10
1-foot panel antenna	Mars	MA-IS91	902-928	10
1-foot panel antenna	MTI	MT-262001	902-928	8
1-foot panel antenna	MTI	MT-263003	902-928	10

Cavity Filters

900 MHz outdoor cavity filters provide a high-performance filtering solution by offering low insertion loss and great rejection characteristics; they are capable of blocking out interference at the 900 MHz ISM band edges (902 MHz and 928 MHz). This is especially crucial when colocating 954-R equipment in urban or omni deployments in the presence of strong interferers operating at these frequencies.

The following cavity filters are available for use with the 954-R. See the manufacturer's web site for more information.

Type	Manufacturer	Model Number
912 MHz (Center Frequency) Cavity Filter	Ubiquiti	CF912
917 MHz (Center Frequency) Cavity Filter	Ubiquiti	CF917

Recommended 2.4 GHz Antennas

- [Omni Antennas](#)
- [Sector Antennas](#)
- [Panel Antennas](#)
- [Parabolic Antennas](#)

Omni Antennas

- [5 dBi Omni-Directional Vehicle Antenna \(848 515 722\)](#)
- [7 dBi Omni-Directional Base Station Antenna \(848 312 591\)](#)
- [10 dBi Omni-Directional Base Station Antenna \(848 515 698\)](#)

5 dBi Omni-Directional Vehicle Antenna (848 515 722)



Electrical Specifications

Frequency Range	2400 MHz to 2500 MHz
VSWR	Less than 2:1
Nominal Impedance	50 Ohms
Gain	5 dBi
Polarization	Linear, Vertical
HPBW/Horizontal	360°
HPBW/Vertical	25°
Power Handling	10 W (cw)
Connector Type	N Jack

Environmental and Mechanical Specifications

Temperature Range	-10 to +55 °C
Size	80 x 80 x 250 mm
Cable Color	White

5 dBi Omni-Directional Antenna (848 515 722) (continued)

Antenna Patterns

V-Plane Co-polarization pattern

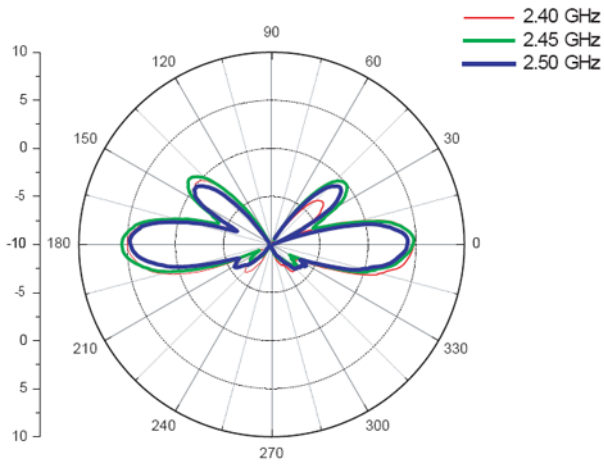

H-Plane Co-polarization pattern

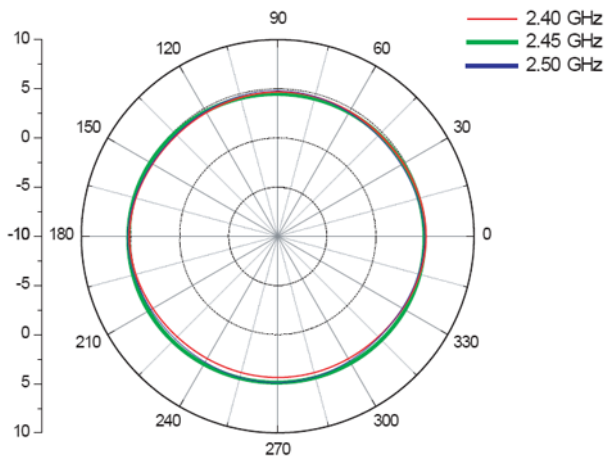

7 dBi Omni-Directional Base Station Antenna (848 312 591)



Electrical Specifications

Frequency Range	2400 MHz –2500 MHz
VSWR	Less than 2:1
Nominal Impedance	50 Ohms
Gain	8 dBi
Polarization	Linear, Vertical
HPBW/Horizontal	360°
HPBW/Vertical	15°
Handling	10 W
Connector Type	Standard N Female

Environmental and Mechanical Specifications

Wind Survival	216 km/hr
Temperature Range	-40 to +80 °C
Humidity	95% @ 25 °C
Size	19 x 19 x 520 mm
Color	Gray-White
Weight	.34 kg

7 dBi Omni-Directional Base Station Antenna (848 312 591) (continued)

Antenna Patterns

V-plane Co-polarization Pattern

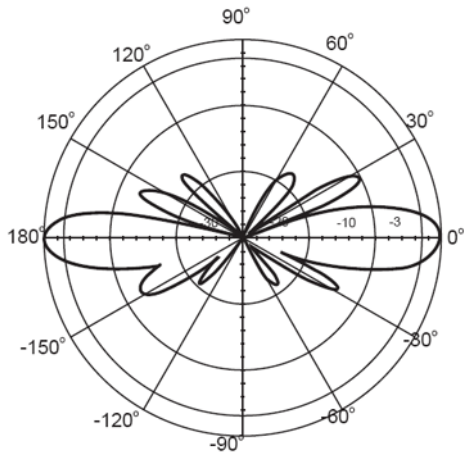

H-plane Co-polarization Pattern

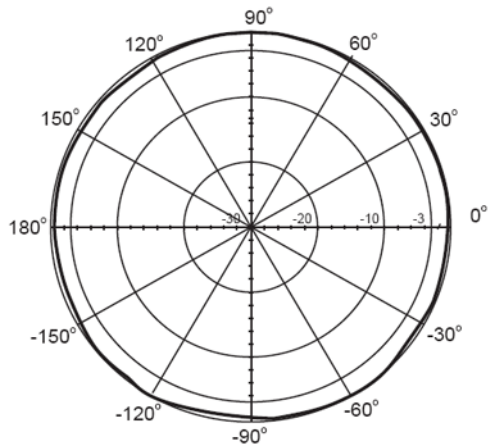

10 dBi Omni-Directional Base Station Antenna (848 515 698)



Electrical Specifications

Frequency Range	2400 - 2500 MHz
VSWR	Less than 2:1 nominal
Nominal Impedance	50 Ohms
Gain	10 dBi
Polarization	Linear, Vertical
Connector Type	Standard N Female
Power Handling	10 W

Environmental and Mechanical Specifications

Wind Survival	At least 240 km/hr with 1.25 cm ice
Temperature Range	-40 to +60 °C
Size	91.4 cm

10 dBi Omni-Directional Base Station Antenna (848 515 698) (continued)

Antenna Patterns

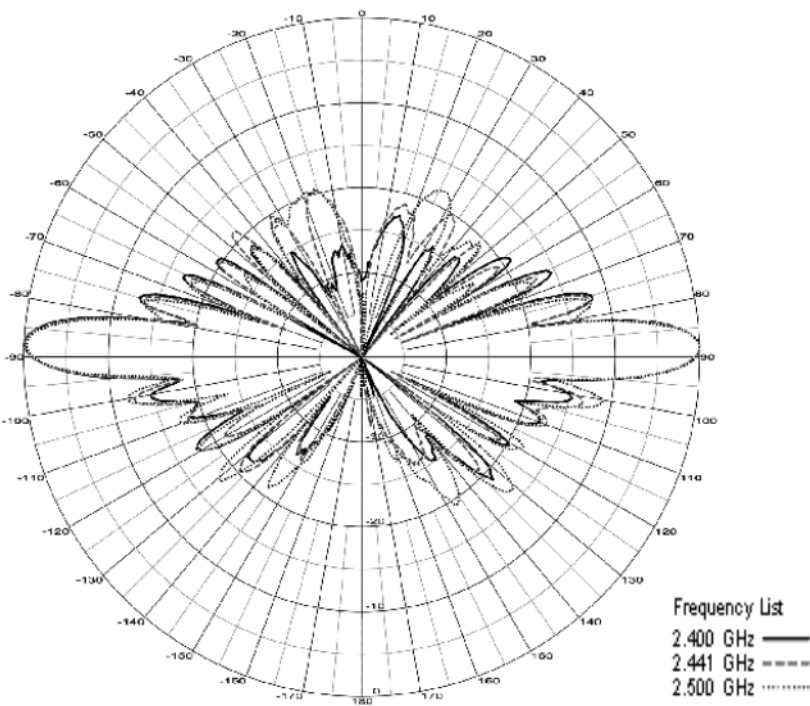
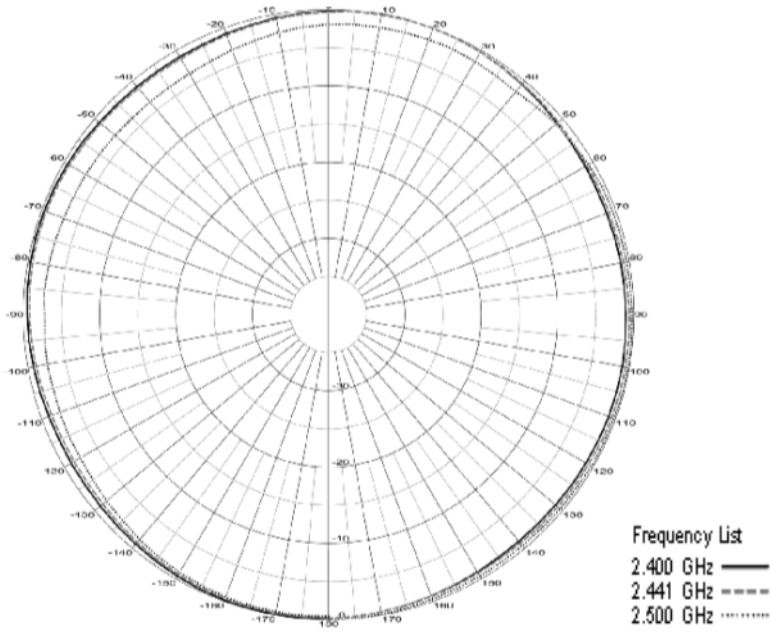

Sector Antennas

- [12 dBi Directional Wide Angle Antenna \(120°\) \(848 515 706\)](#)
- [14 dBi Sector Antenna \(60°\) \(2400-SA60-14\)](#)

12 dBi Directional Wide Angle Antenna (120°) (848 515 706)



Electrical Specifications

Frequency Range	2400 MHz to 2500 MHz
VSWR	Less than 2 : 1 nominal
Nominal Impedance	50 Ohms
Gain	12 dBi
Polarization	Linear, Vertical
Connector Type	Standard N Female
HPBW/Horizontal	125°
HPBW/Vertical	13°
Power Handling	10 W

Environmental and Mechanical Specifications

Wind Survival	200 km/hr
Temperature Range	-40 to +60 °C
Humidity	100% at 25 °C
Size	181 x 537 x76 mm

12 dBi Directional Wide Angle Antenna (120°) (848 515 706) (continued)

Antenna Patterns

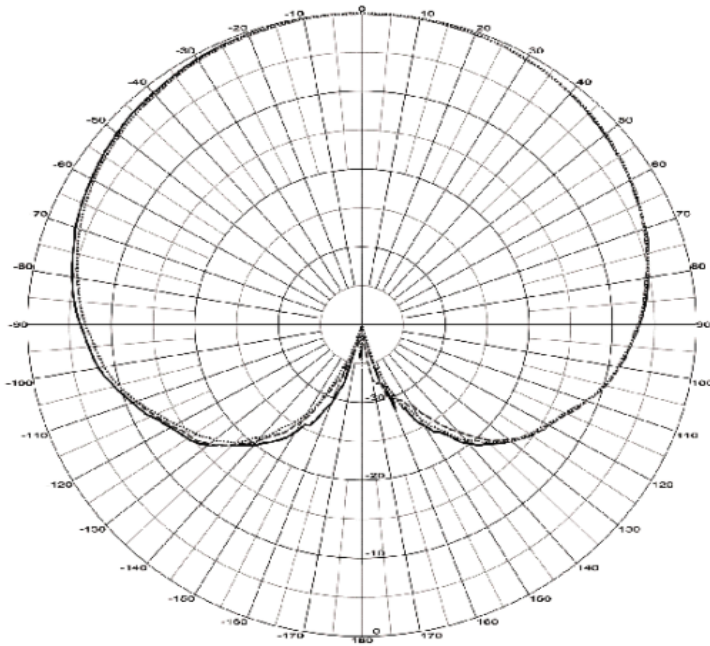

Frequency List
2.400 GHz ———
2.441 GHz - - - -
2.500 GHz ······

Azimuth Plane (Horizontal)

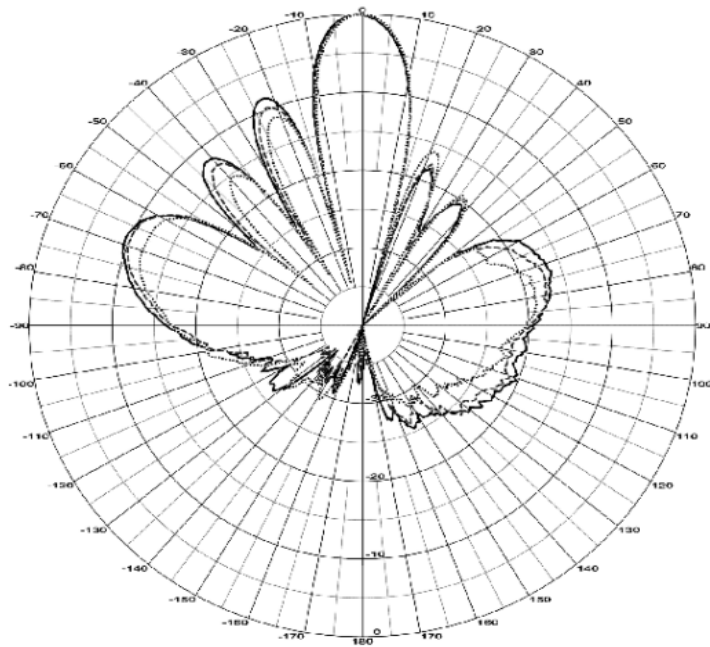

Frequency List
2.400 GHz ———
2.441 GHz - - - -
2.500 GHz ······

Elevation Plane (Vertical)

14 dBi Sector Antenna (60°) (2400-SA60-14)



Electrical Specifications

Frequency Range	2400 MHz to 2500 MHz
VSWR	1.8 : 1 maximum
Nominal Impedance	50 Ohms
Gain	14 dBi
Polarization	Linear, Vertical
Connector Type	N Jack
Power Handling	5 W (cw)
HPBW/Horizontal	65°
HPBW/Vertical	13°
Front to Back Ratio	25 dB
Downtilt	0°

Environmental and Mechanical Specifications

Wind Survival	216 km/hr
Temperature range	-40 to +80 °C
Humidity	100% at 25 °C
Size	620 x 88 x 70 mm
Radome Color	Gray-White
Radome Material	ABS, UV Resistant
Weight	5.55 kg

14 dBi Sector Antenna (60°) (2400-SA60-14) (continued)

Antenna Patterns

H-plane Co-polarization Pattern

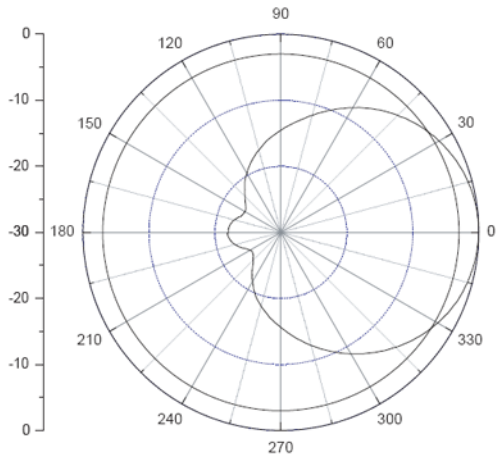

V-plane Co-polarization Pattern

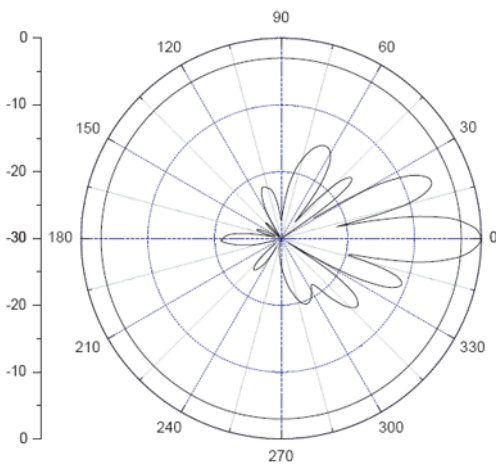

Panel Antennas

- [14 dBi Directional Panel Antenna \(1086-PA24-14\)](#)
- [Parabolic Antennas](#)

14 dBi Directional Panel Antenna (1086-PA24-14)



Electrical Specifications

Frequency Range	2400 MHz - 2500 MHz
VSWR	1.5 : 1 maximum
Nominal Impedance	50 Ohms
Gain	14 dBi
Polarization	Linear, Vertical
Connector Type	Standard N Female
HPBW/Horizontal	30°
HPBW/Vertical	30°
Front to Back Ratio	15 dB
Downtilt	0°
Power Handling	50 W (cw)

Environmental and Mechanical Specifications

Wind Survival	216 km/hr
Temperature Range	-40 to +80 °C
Humidity	95% at 25 °C
Lightning Protection	DC Ground
Radome Color	Gray-White
Radome Material	ABS
Weight	407 g
Size	200 x 200 x 50 mm

14 dBi Directional Panel Antenna (1086-PA24-14) (continued)

Antenna Patterns

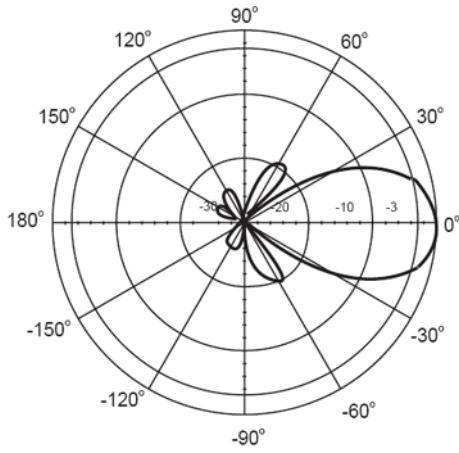

Horizontal

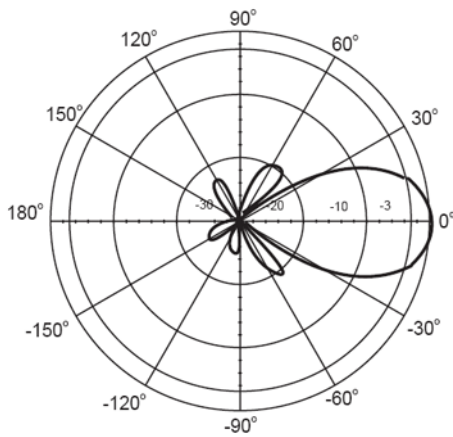

Vertical

Parabolic Antennas

24 dBi Directional Parabolic Grid Antenna (848 515 714)



Electrical Specifications

Frequency Range	2400 MHz - 2484 MHz
VSWR	Less than 2 : 1 nominal
Nominal Impedance	50 Ohms
Gain	24 dBi
Polarization	Linear, vertical for standard mounting Horizontal when mounted differently
HPBW/Horizontal	6.5°
HPBW/Vertical	10°
Connector Type	Standard N, Female
Power Handling	50 W

Environmental and Mechanical Specifications

Wind Survival	At least 200 km/h
Temperature Range	-40 to +60 °C
Color	White
Weight	0.6 kg
Size	610 x 914 x 381 cm

24 dBi Directional Parabolic Grid Antenna (848 515 714) (continued)

Antenna Patterns

Horizontal Plane 24.4 dBi at 2.433 GHz

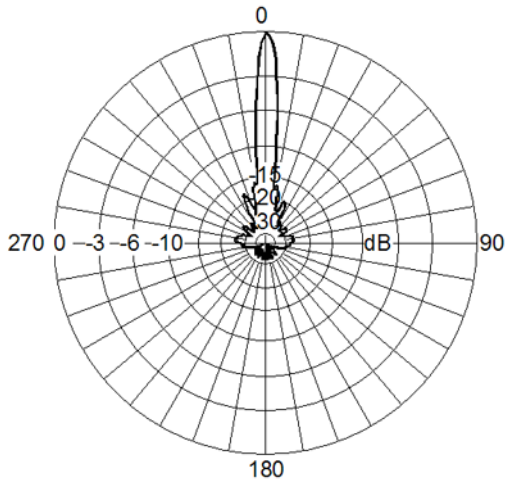

Horizontal Plane 24.29 dBi at 2.466 GHz

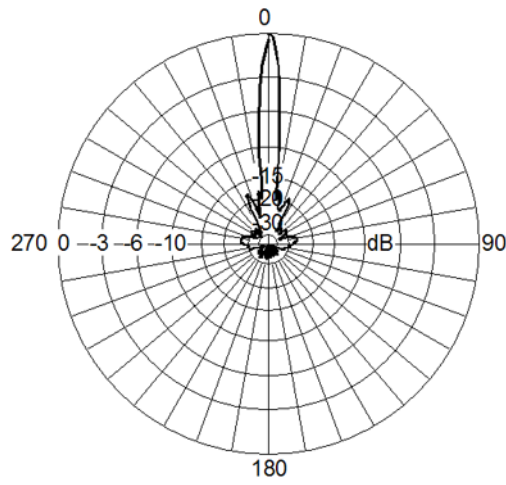

Vertical Plane 24.52 dBi at 2.433 GHz

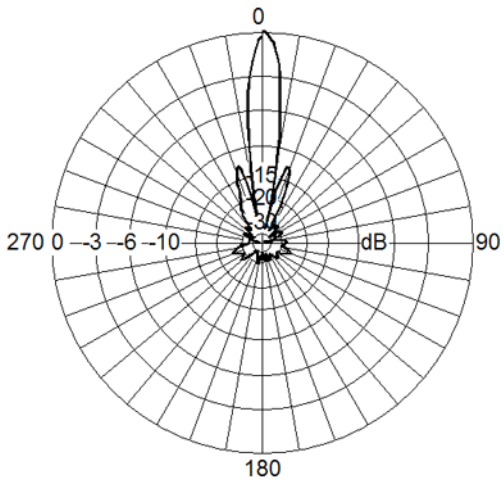

Vertical Plane 24.42 dBi at 2.466 GHz

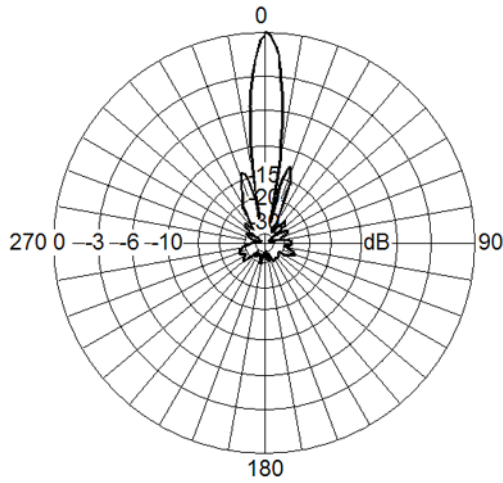

Recommended 4.9 GHz Antennas

- [Omni Antennas](#)
- [Sector Antennas](#)

Omni Antennas

- [8 dBi Omni-Directional Antenna \(1086-OA49-8\)](#)
- [10 dBi Omni-Directional Antenna \(1086-OA49-10\)](#)

8 dBi Omni-Directional Antenna (1086-OA49-8)



Electrical Specifications

Frequency Range	4900 MHz - 5200 MHz
VSWR	2.0 : 1 maximum
Nominal Impedance	50 Ohms
Gain	8 dBi
Polarization	Linear, Vertical
Connector Type	N-type Jack
HPBW/Horizontal	360°
HPBW/Vertical	12°
Downtilt	0°
Power Handling	5 W (cw)

8 dBi Omni-Directional Antenna (1086-OA49-8) (continued)

Environmental and Mechanical Specifications

Wind Survival	216 km/hr
Temperature Range	-40 to +80 °C
Humidity	95% at 25 °C
Size	80 x 78 x 373 mm
Radome Color	Gray-White
Radome Material	Fiber Glass
Weight	227 g

Antenna Patterns

H-plane Co-polarization Pattern

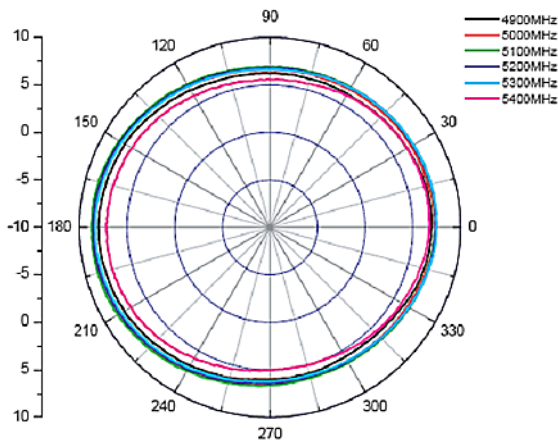

V-plane Co-polarization Pattern

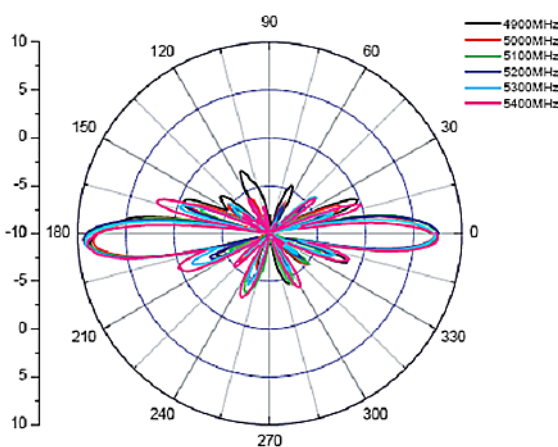

10 dBi Omni-Directional Antenna (1086-OA49-10)



Electrical Specifications

Frequency Range	4900 MHz - 5000 MHz
VSWR	1.7 : 1 maximum
Nominal Impedance	50 Ohms
Gain	10 dBi
Polarization	Linear, Vertical
Connector Type	N-type Jack
HPBW/Horizontal	360°
HPBW/Vertical	7°
Downtilt	2°
Power Handling	5 W (cw)

Environmental and Mechanical Specifications

Wind Survival	216 km/hr
Temperature Range	-40 to +80 °C
Humidity	95% at 25 °C
Size	80 x 78 x 511 mm
Radome Color	Gray-White
Radome Material	Fiber Glass, UV Resistant
Weight	265 g

10 dBi Omni-Directional Antenna (1086-OA49-10) (continued)

Antenna Patterns

H-plane Co-polarization Pattern @ downtilt 2°

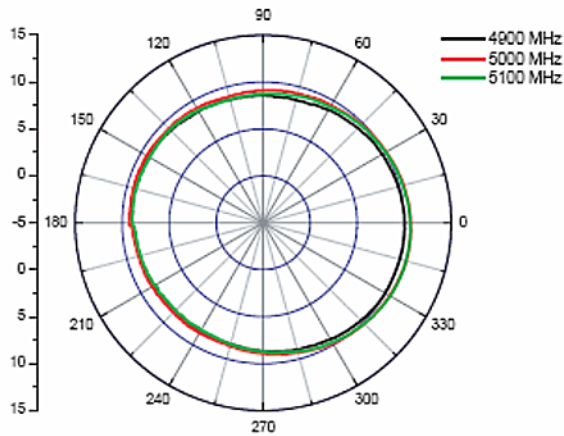

V-plane Co-polarization Pattern

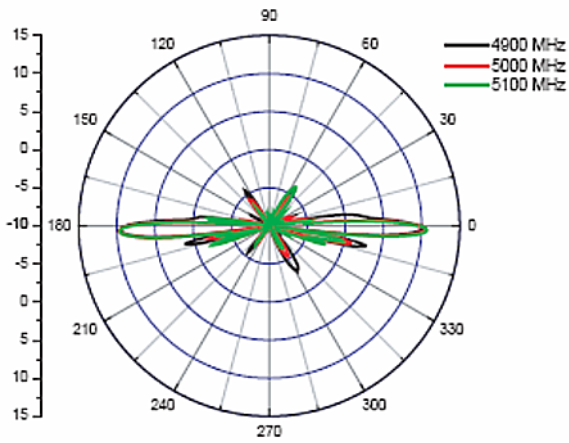

Panel Antennas

10 dBi Panel Antenna (1086-PA49-10)



Electrical Specifications

Frequency Range	4900 MHz - 5800 MHz
VSWR	2.0 : 1 maximum
Nominal Impedance	50 Ohms
Gain	10 dBi
Polarization	Linear, Vertical
Connector Type	N-type Jack
HPBW/Horizontal	45°
HPBW/Vertical	45°
Downtilt	0°
Power Handling	2 W (cw)

Environmental and Mechanical Specifications

Wind Survival	216 km/hr
Temperature Range	-40 to +80 °C
Humidity	95% at 25 °C
Size	114 x 114 x 40 mm
Radome Color	Light Gray
Radome Material	ABS
Weight	107 g

10 dBi Panel Antenna (1086-PA49-10) (continued)

Antenna Patterns

H-plane Co-polarization Pattern

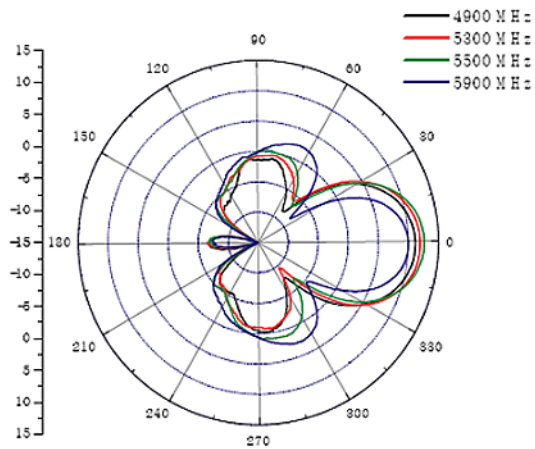

V-plane Co-polarization Pattern

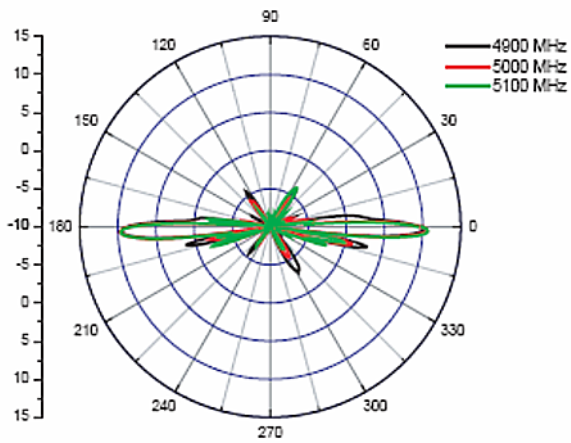

21 dBi Panel Antenna (1086-PA49-21)

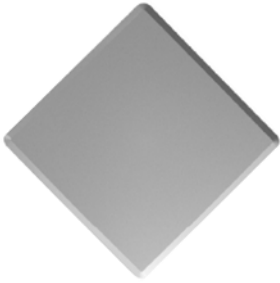

Electrical Specifications

Frequency Range	4900 MHz - 5000 MHz
VSWR	1.7 : 1 maximum
Nominal Impedance	50 Ohms
Gain	21 dBi
Polarization	Linear, Vertical
Connector Type	N-type Jack
HPBW/Horizontal	10°
HPBW/Vertical	12°
Front to Back Ratio	30°
Power Handling	1 W (cw)

Environmental and Mechanical Specifications

Wind Survival	216 km/hr
Temperature Range	-40 to +80 °C
Humidity	95% at 25 °C
Size	320 x 320 x 18 mm
Radome Color	Gray-White
Radome Material	PC, UV Resistant
Weight	1.2 kg

21 dBi Panel Antenna (1086-PA49-21) (continued)

Antenna Patterns

H-Plane Co-polarization Pattern

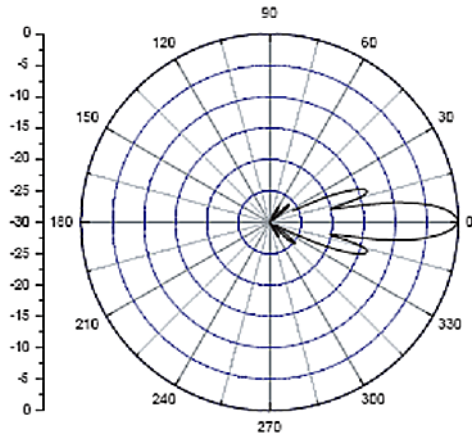

V-Plane Co-polarization Pattern

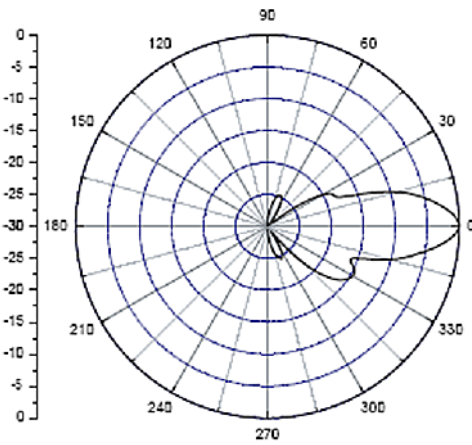

Sector Antennas

14 dBi Sector Antenna (120°) (5054-SA120-14)



Electrical Specifications

Frequency Range	4945 MHz - 5875 MHz
VSWR	2.0 : 1 maximum
Nominal Impedance	50 Ohms
Gain	12.5 dBi (max)
Polarization	Linear, Vertical
Connector Type	N-type Female
HPBW/Horizontal	120°
HPBW/Vertical	6°
Front to Back Ratio	30°
Downtilt	0°

Environmental and Mechanical Specifications

Wind Survival (per EIA-222-F at 100' height)	216 km/hr
Temperature Range	-40 to +80 °C
Humidity	95% at 25 °C
Lightning Protection	DC Ground
Size	620 x 88 x 70 mm
Radome Color	Gray
Radome Material	ABS
Weight	555 g

14 dBi Sector Antenna (120°) (5054-SA120-14) (continued)

Antenna Patterns

V-Plane Co-polarization pattern

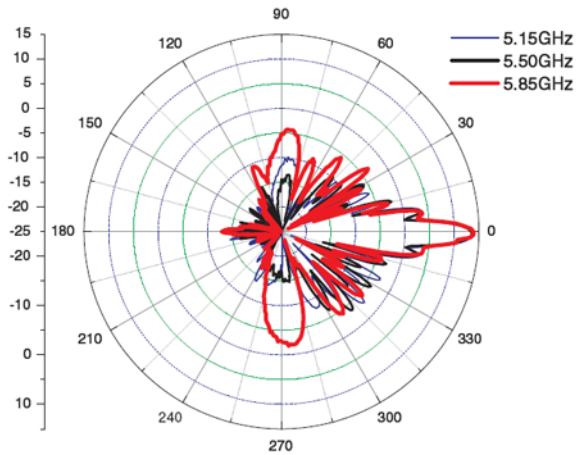

H-Plane Co-polarization pattern

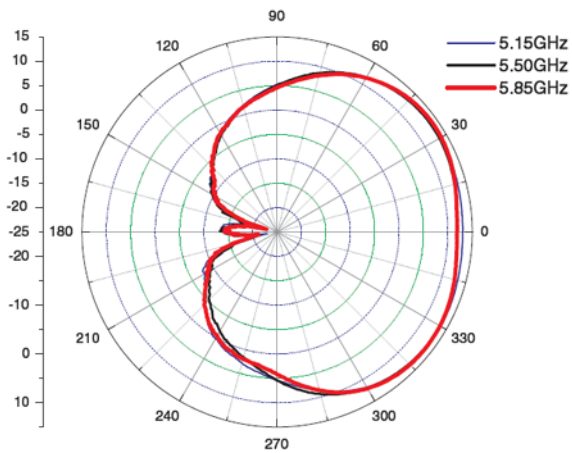

17 dBi Sector Antenna (60°) (5054-SA60-17)



Electrical Specifications

Frequency Range	4945 MHz - 5875 MHz
VSWR	2.0 : 1 maximum
Nominal Impedance	50 Ohms
Gain	16.5 dBi
Polarization	Linear, Vertical
Connector Type	N-type Female
HPBW/Horizontal	60°
HPBW/Vertical	6°
Power Handling	5 W (cw)
Downtilt	0°

Environmental and Mechanical Specifications

Wind Survival (per EIA-222-F at 100' height)	216 km/hr
Temperature Range	-40 to +90 °C
Humidity	95% at 25 °C
Lightning Protection	DC Ground
Size	620 x 88 x 70 mm
Radome Color	Gray
Radome Material	ABS
Weight	565 g

17 dBi Sector Antenna (60°) (5054-SA60-17) (continued)

Antenna Patterns

H-Plane Co-polarization pattern

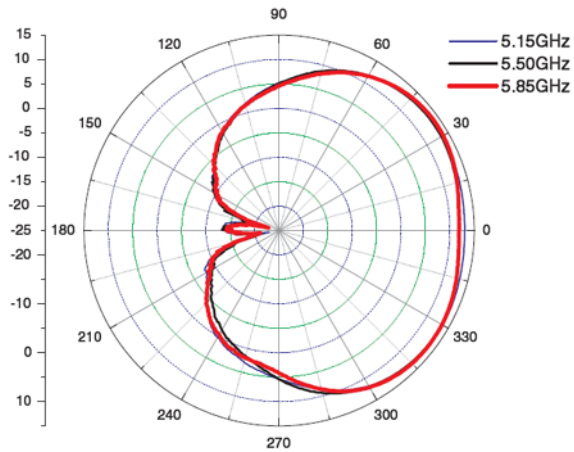

V-Plane Co-polarization pattern

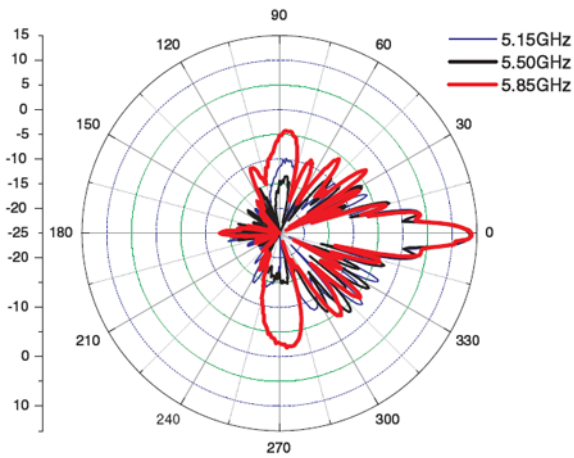

Recommended 5 GHz Antennas

- [Omni-Directional Antennas](#)
- [Sector Antennas](#)
- [Panel Antennas](#)
- [Parabolic Antennas](#)

Omni-Directional Antennas

- [8 dBi Omni-Directional Antenna \(5054-OA-8\)](#)
- [10 dBi Omni-Directional Antenna \(5054-OA-10\)](#)
- [Other Recommended Omni-Antennas](#)

8 dBi Omni-Directional Antenna (5054-OA-8)



Electrical Specifications

Frequency Range	5470 MHz – 5875 MHz
VSWR	2.0 : 1 maximum
Nominal Impedance	50 Ohms
Average/Peak Gain	7.8/9.0 dBi @ 5.5 GHz 8.1/9.4 dBi @ 5.7 GHz
HPBW/Horizontal	360°
HPBW/Vertical	12°
Polarization	Linear, Vertical
Electrical Downtilt	0°
Power Handling	5 W (cw)
Connector Type	Standard N Female

8 dBi Omni-Directional Antenna (5054-OA-8) (continued)

Environmental and Mechanical Specifications

Wind Survival	216 km/hr
Temperature Range	-40 to +90 °C
Humidity	95% @ 25 °C
Lightning Protection	DC ground
Size	78 x 80 x 373 mm
Radome Color	Gray-White
Radome Material	Fiberglass
Weight	245 g

Antenna Patterns

H-plane Co-polarization Pattern

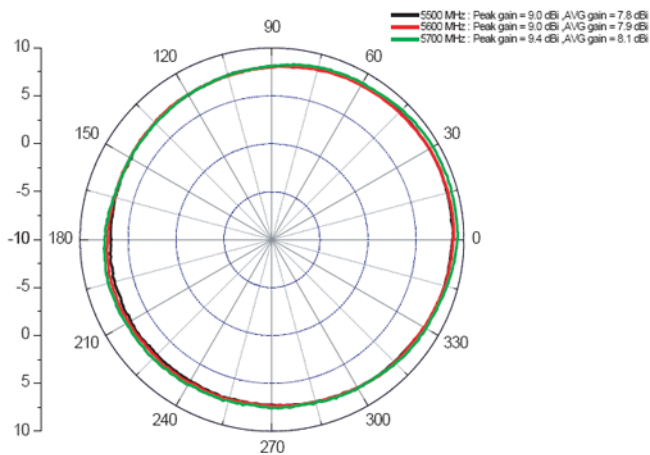

V-plane Co-polarization Pattern

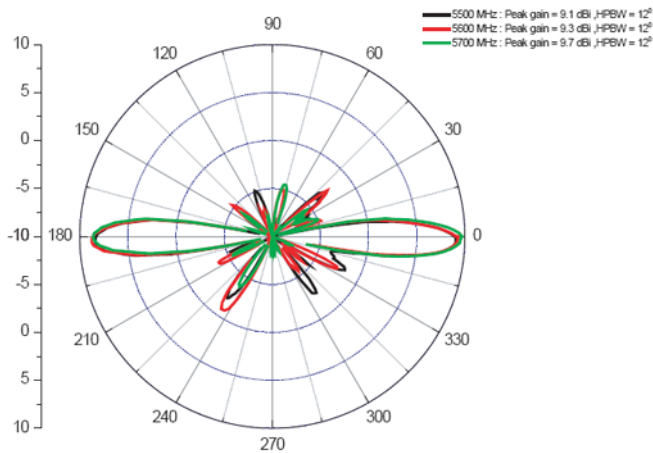

10 dBi Omni-Directional Antenna (5054-OA-10)



Electrical Specifications

Frequency Range	5470 MHz – 5875 MHz
VSWR	2.0 : 1 maximum
Nominal Impedance	50 Ohms
Gain	10 dBi
HPBW/Horizontal	360°
HPBW/Vertical	7°
Polarization	Linear, Vertical
Downtilt	2°
Power Handling	5 W (cw)
Connector Type	Standard N Female

Environmental and Mechanical Specifications

Wind Survival (per EIA-222-F at 100' height)	216 km/hr
Temperature Range	-40 to +80 °C
Humidity	95% @ 25 °C
Lightning Protection	DC ground
Size	78 x 80 x 511 mm
Radome Color	Gray-White
Radome Material	Fiberglass
Weight	265 g

10 dBi Omni-Directional Antenna (5054-OA-10) (continued)

Antenna Patterns

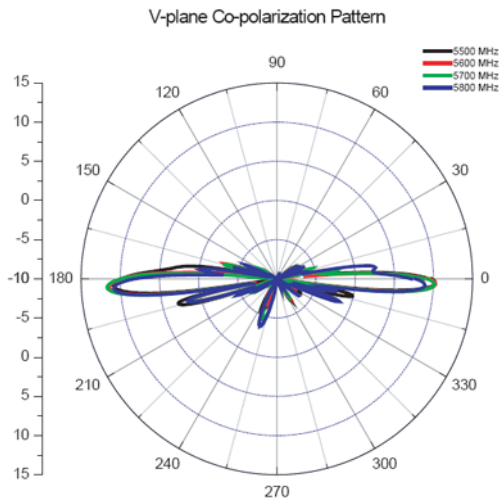
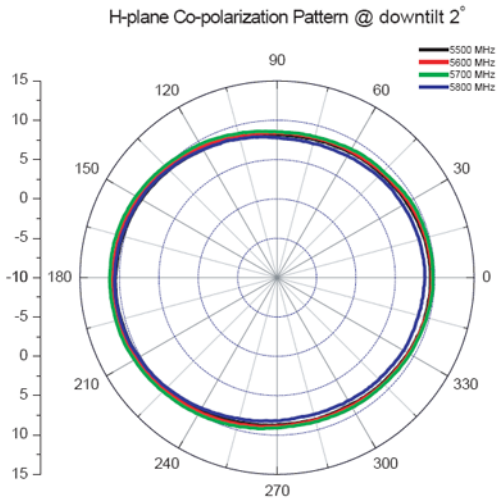

Other Recommended Omni-Antennas

Manufacturer	Model Number	Frequency Range	Mid-Band Gain
Mars	MA-WO58-9X	5.47 – 5.875	9
MTI	MT-482003/N	5.15 – 5.875	9
MTI	MT-482009/N	5.725-5.875	12
MTI	MT-483003/N	5.725-5.875	12
Stella Doradus	52 1360	5.1-5.3	7
Stella Doradus	52 2360	5.1-5.3	10
Stella Doradus	52 3360	5.1-5.3	13
Stella Doradus	58 1360	5.7-5.8	7
Stella Doradus	58 2360	5.7-5.8	10
Stella Doradus	58 3360	5.7-5.8	13
Telex	5830	5.725-5.85	7.5
Radio Waves	OMN-H-5-8	5.725-5.85	8 (hor pol)

Sector Antennas

- [14 dBi Sector Antenna \(120°\) \(5054-SA120-14\)](#)
- [17 dBi Sector Antenna \(60°\) \(5054-SA60-17\)](#)
- [Other Recommended Sector Antennas](#)

14 dBi Sector Antenna (120°) (5054-SA120-14)



Electrical Specifications

Frequency Range	5150 MHz – 5875 MHz
VSWR	2.0 : 1 maximum
Nominal Impedance	50 Ohms
Gain	13.5 dBi
HPBW/Horizontal	120°
HPBW/Vertical	6°
Polarization	Linear, Vertical
Downtilt	0°
Power Handling	5 W (cw)
Connector Type	Standard N Female

Environmental and Mechanical Specifications

Wind Survival	216 km/hr
Temperature Range	-40 to +80 °C
Humidity	95% @ 25 °C
Lightning Protection	DC Ground
Size	620 x 80 x 70 mm
Radome Color	Gray
Radome Material	ABS
Weight	555 g

14 dBi Sector Antenna (120°) (5054-SA120-14) (continued)

Antenna Patterns

V-Plane Co-polarization pattern

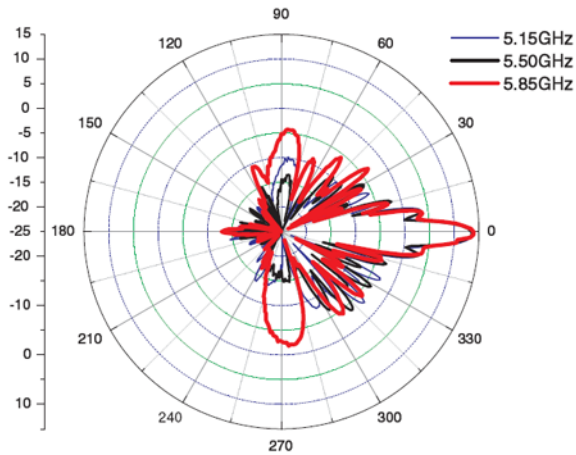

H-Plane Co-polarization pattern

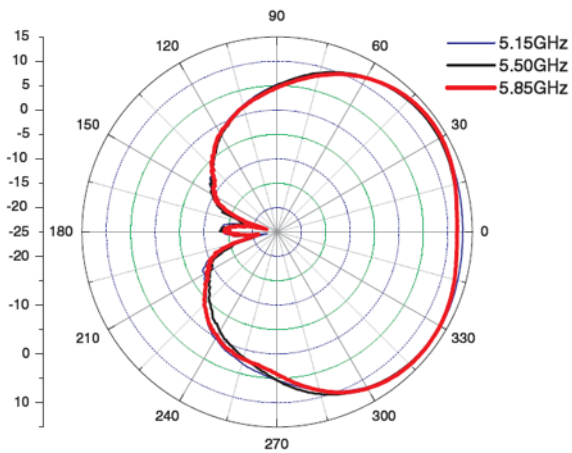

17 dBi Sector Antenna (60°) (5054-SA60-17)



Electrical Specifications

Frequency Range	5150 MHz – 5875 MHz
VSWR	2.0 : 1 maximum
Nominal Impedance	50 Ohms
Gain	16.5 dBi
HPBW/Horizontal	60°
HPBW/Vertical	6°
Polarization	Linear, Vertical
Downtilt	0°
Power Handling	5 W (cw)
Connector Type	N-type Female

Environmental and Mechanical Specifications

Wind Survival (per EIA-222-F at 100' height)	216 km/hr
Temperature Range	-40 to +80 °C
Humidity	95% @ 25 °C
Lightning Protection	DC Ground
Size	620 x 88 x 70 mm
Radome Color	Gray
Radome Material	ABS
Weight	530 g

17 dBi Sector Antenna (60°) (5054-SA60-17) (continued)

Antenna Patterns

V-Plane Co-polarization pattern

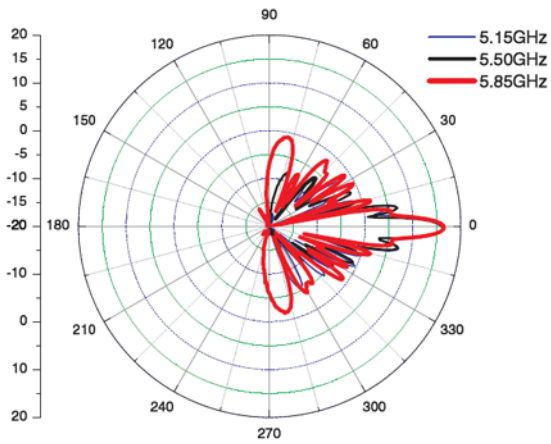

H-Plane Co-polarization pattern

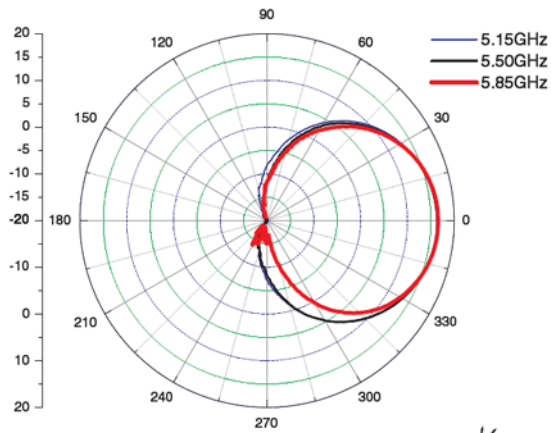

Other Recommended Sector Antennas

Beamwidth	Manufacturer	Model Number	Frequency Range	Mid-Band Gain
60°	Mars	MA-WC50-5X	5.15 – 5.85	17
	MTI	MT-484026/NV	5.15 – 5.875	16 (Null-Fill)
	MTI	MT-484026/NH	5.15 – 5.875	15 (h pol, NF)
	MTI	MT-484033/NV	5.15 – 5.875	16.5
	RadioWaves	SEC-55H-60-17	5.25 – 5.85	17 (hor pol)
	RadioWaves	SEC-55V-60-17	5.25 – 5.85	17
90°	Mars	MA-WD50-6X	5.15 – 5.875	16
	MTI	MT-484027/NV	5.15 – 5.875	14 (Null-Fill)
	MTI	MT-484027/NH	5.15 – 5.875	14 (h pol, NF)
	MTI	MT-484032/NV	5.15 – 5.85	17
	RadioWaves	SEC-55H-90-16	5.25 – 5.85	16 (hor pol)
	RadioWaves	SEC-55V-90-16	5.25 – 5.85	16
	Telex	5801	5.725 – 5.825	12
	Telex	5840	5.725 – 5.825	15
120°	Mars	MA-WE50-7X	5.15 – 5.875	14.5
	MTI	MT-484034/NV	5.15 – 5.875	16.5
	MTI	MT-484034/NH	5.15 – 5.875	16.5 (hor pol)
	RadioWaves	SEC-5V-120-14	5.725 – 5.85	14
	RadioWaves	SEC-5V-120-16	5.725 – 5.85	16

Panel Antennas

- [15 dBi Window Antenna \(5054-WA-15-STN\)](#)
- [18 dBi Panel Antenna \(5054-PA-18\)](#)
- [23 dBi Panel Antenna \(5054-PA50-23\)](#)
- [Other Recommended Panel Antennas](#)

15 dBi Window Antenna (5054-WA-15-STN)



Electrical Specifications

Frequency Range	5150 MHz – 5850 MHz
VSWR	2.0 : 1 maximum
Nominal Impedance	50 Ohms
Gain*	15 dBi
HPBW/Horizontal	45°
HPBW/Vertical	10°
Polarization	Linear, Vertical
Downtilt	0°
Power Handling	20 W (cw)
Connector Type	Standard N Female
Front-to-Back Ratio	18 dB
Impedance	50 Ohms

Environmental and Mechanical Specifications

Wind Survival	180 km/hr
Temperature Range	-40 to +80 °C
Humidity	95% @ 25 °C
Lightning Protection	DC ground
Size	330 x 93 x 21 mm
Radome Color	White
Radome Material	ABS, UV Resistant
Weight	0.6 kgw

15 dBi Window Antenna (5054-WA-15-STN) (continued)

Antenna Patterns

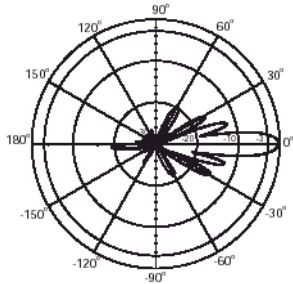

Vertical

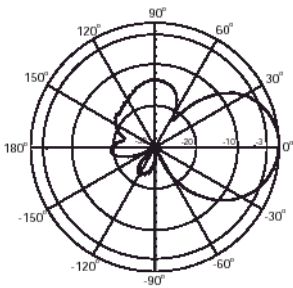

Horizontal

18 dBi Panel Antenna (5054-PA-18)



Electrical Specifications

Frequency Range	5250 MHz – 5785 MHz
VSWR	1.5 : 1 maximum
Nominal Impedance	50 Ohms
Gain	18 dBi
HPBW/Horizontal	18°
HPBW/Vertical	18°
Polarization	Linear, Vertical
Downtilt	0°
Power Handling	10 W (cw)
Connector Type	Standard N Female
Front-to-Back Ratio	30 dB

Environmental and Mechanical Specifications

Wind Survival (per EIA-222-F at 100' height)	216 km/hr
Temperature Range	-40 to +80 °C
Humidity	95% @ 25 °C
Lightning Protection	DC ground
Size	200 x 200 x 50 mm
Radome Color	Light Gray
Radome Material	ABS, UV Resistant
Weight	0.825 kgw

18 dBi Panel Antenna (5054-PA-18) (continued)

Antenna Patterns

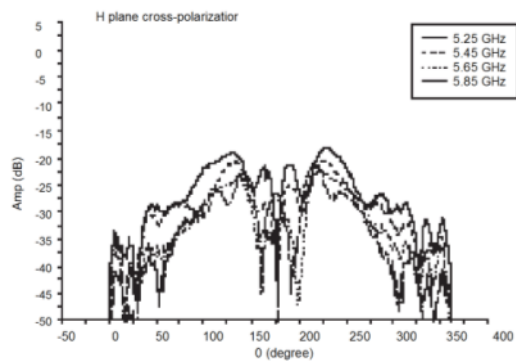
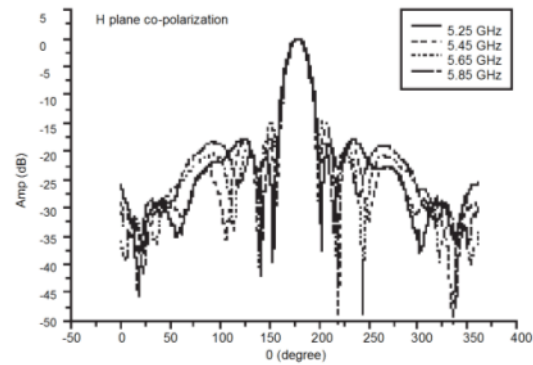
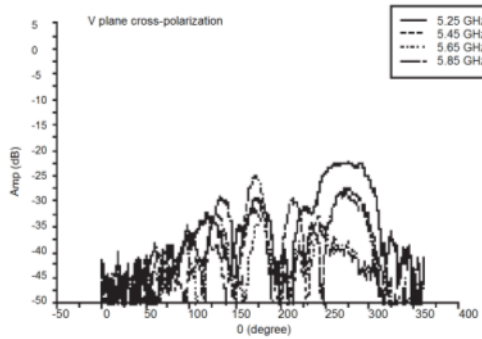
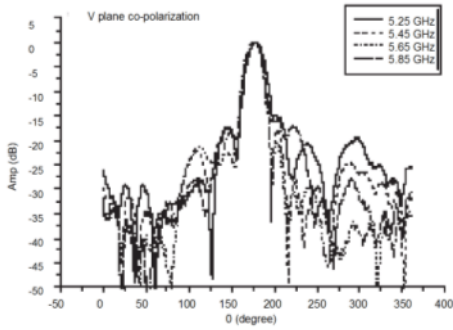

23 dBi Panel Antenna (5054-PA50-23)

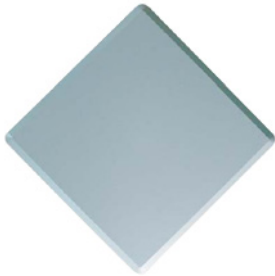

Electrical Specifications

Frequency Range	5150 MHz – 5875 MHz
VSWR	2:0: 1 maximum
Nominal Impedance	50 Ohms
Gain	23 dBi
HPBW/Horizontal	9°
HPBW/Vertical	9°
Polarization	Linear
Power Handling	5 W
Connector Type	N Jack
Front-to-Back Ratio	30 dB

Environmental and Mechanical Specifications

Wind Survival	216 km/hr
Temperature Range	-40 to +80 °C
Humidity	95% @ 55 °C
Lightning Protection	DC Ground
Size	320 x 320 x 18 mm
Radome Color	Gray-White
Radome Material	PC, UV Resistant
Weight	1.2 kg

Antenna Patterns

V-Plane Co-polarization Pattern

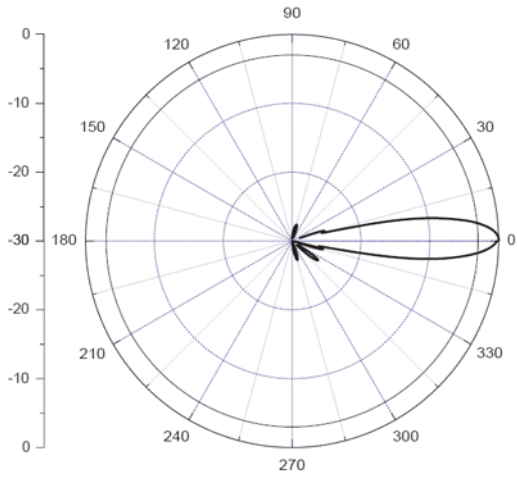

H-Plane Co-polarization Pattern

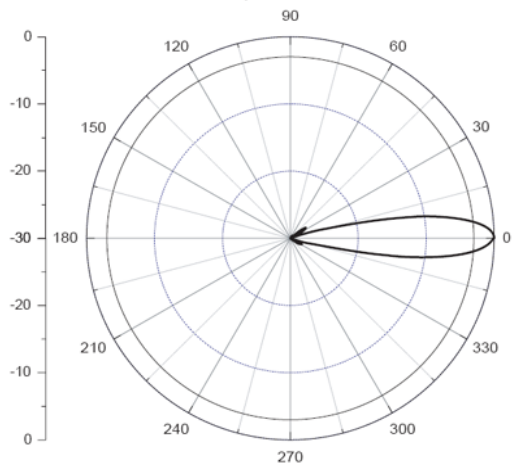

Other Recommended Panel Antennas

Type	Manufacturer	Model Number	Frequency Range	Mid-Band Gain
Panel	SmartAnt	R0320-056	5.15 – 5.875	8
	Gabriel	DFPS.5-52	5.25 – 5.85	18
	MTI	MT-485001/N	5.15 – 5.875	18
	MTI	MT-485028/N	5.15 – 5.875	22
	MTI	MT-486004/N	5.15 – 5.875	26
	Mars	MA-WA57-3X	5.15 – 5.875	17.5
	RadioWaves	FP .5-5-18	5.25 – 5.85	18
1-Foot Flat Panel	Gabriel	DFPD1-52	5.25 – 5.85	23.5
	Andrew	FPA5250D12-N	5.25 – 5.85	23.6
	MTI	485002/N	5.15 – 5.875	23
	Mars	MA-WA58-1X	5.15 – 5.875	23
	RadioWaves	FP1 5-24	5.25 – 5.85	24
2-Foot Flat Panel	MTI	MT-486001/N	5.15 – 5.875	28
	Gabriel	DFPD2-52	5.25 – 5.85	28
	Andrew	FPA5250D24-N	5.25 – 5.85	28.2
	RSI	A57A24-U	5.725 – 5.85	26.5
	RadioWaves	FP2 5-28	5.25 – 5.85	28

Parabolic Antennas

Recommended parabolic antennas for 5 GHz are listed in the following table.

Type	Manufacturer	Model Number	Frequency Range	Mid-Band Gain
2-Foot Parabolic	Gabriel	SSP2-52B	5.25 – 5.85	28.5
	Gabriel	SSD2-52A	5.25 – 5.85	28.4
	Gabriel	HSSP2-52	5.25 – 5.85	28.1
	Radio Waves	SP2-5.2	5.25 – 5.85	28.3
	Radio Waves	SPD2-5.2	5.25 – 5.85	28.1
	Andrew	P2F-52	5.25 – 5.85	29.4
	Andrew	PX2F-52	5.25 – 5.85	29.4
	RSI	P-57C24		29
3-Foot Parabolic	Radio Waves	SP3-5.2	5.25 – 5.85	31.4
	Radio Waves	SPD3-5.2	5.25 – 5.85	31.1
	Andrew	P3F-52	5.25 – 5.85	33.4
	Andrew	PX3F-52	5.25 – 5.85	33.4

Technical Services and Support

Obtaining Technical Services and Support

If you are having trouble utilizing your Proxim product, please review this manual and the additional documentation provided with your product.

If you require additional support and would like to use Proxim's free Technical Service to help resolve your issue, please be ready to provide the following information before you contact Proxim's Technical Services:

- **Product information:**
 - Part number of suspected faulty unit
 - Serial number of suspected faulty unit
- **Trouble/error information:**
 - Trouble/symptom being experienced
 - Activities completed to confirm fault
 - Network information (what kind of network are you using?)
 - Circumstances that preceded or led up to the error
 - Message or alarms viewed
 - Steps taken to reproduce the problem
- **Servpak information (if a Servpak customer):**
 - Servpak account number
- **Registration information:**
 - If the product is not registered, date when you purchased the product
 - If the product is not registered, location where you purchased the product

NOTE: If you would like to register your product now, visit the Proxim eService Web Site at <http://support.proxim.com> and click on **New Product Registration**.

Support Options

Proxim eService Web Site Support

The Proxim eService Web site is available 7x24x365 at <http://support.proxim.com>.

On the Proxim eService Web Site, you can access the following services:

- **New Product Registration:** Register your product for free support.
- **Open a Ticket or RMA:** Open a ticket or RMA and receive an immediate reply.
- **Search Knowledgebase:** Locate white papers, software upgrades, and technical information.
- **ServPak (Service Packages):** Receive Advanced Replacement, Extended Warranty, 7x24x365 Technical Support, Priority Queuing, and On-Site Support.
- **Your Stuff:** Track status of your tickets or RMAs and receive product update notifications.
- **Provide Feedback:** Submit suggestions or other types of feedback.
- **Customer Survey:** Submit an On-Line Customer Survey response.
- **Repair Tune-Up:** Have your existing Proxim equipment inspected, tested, and upgraded to current S/W and H/W revisions, and extend your warranty for another year.

Telephone Support

Contact technical support via telephone as follows:

- **US and Canada:** 408-383-7700, 866-674-6626 (Toll Free)
Hours of Operations: 8AM - 6PM
- **APAC Countries:** +91 40-23115490
Hours of Operations: 9AM - 6PM
- **International:** 408-383-7700
Hours of Operations: 8AM - 6PM

ServPak Support

Proxim understands that service and support requirements vary from customer to customer. It is our mission to offer service and support options that go above-and-beyond normal warranties to allow you the flexibility to provide the quality of service that your networks demand.

In recognition of these varying requirements we have developed a support program called ServPak. ServPak is a program of Enhanced Service Options that can be purchased individually or in combinations to meet your needs.

- **Advanced Replacement:** This service offers customers an advance replacement of refurbished or new hardware. (Available in the U.S., Canada, and select countries. Please inquire with your authorized Proxim distributor for availability in your country.)
- **Extended Warranty:** This service provides unlimited repair of your Proxim hardware for the life of the service contract.
- **7x24x365 Technical Support:** This service provides unlimited, direct access to Proxim's world-class technical support 24 hours a day, 7 days a week, 365 days a year.
- **Priority Queuing:** This service allows your product issue to be routed to the next available Customer Service Engineer.

To purchase ServPak support services, please contact your authorized Proxim distributor. To receive more information or for questions on any of the available ServPak support options, please call Proxim Support at 408-383-7700 or send an email to servpak@proxim.com.