

# Bell & Gossett Automatic Timer Kit Model TC-1 Aquastat Models AQS-1/2, AQS-3/4 Pumps With Plug-In Cords

**INSTALLER:** PLEASE LEAVE THIS MANUAL FOR THE OWNER'S USE.



## SAFETY INSTRUCTIONS

This safety alert symbol will be used in this manual and on the pump Safety Instruction decal to draw attention to safety related instructions. When used, the safety alert symbol means ATTENTION! BECOME ALERT! YOUR SAFETY IS INVOLVED! FAILURE TO FOLLOW THE INSTRUCTIONS MAY RESULT IN A SAFETY HAZARD.

## APPLICATION

To increase the overall efficiency of a hot water recirculation system, the TC-1 timer control kit and the AQS-1/2 and AQS-3/4 aquastat kits can be installed for use on any B&G NRF, NBF or Series PL circulator. The TC-1 timer control is programmable to turn the circulator ON and OFF automatically at preset times. The aquastat kits switch the pump OFF at 120°F (48.9°C) and ON at 100°F (37.8°C). The timer and aquastat kits can be used in combination or they can be used separately. This permits the user to have the pump circulate hot water only during those times when high usage can be expected throughout the day. When the aquastat kit and timer are used together, the pump will only circulate water when the ON time conditions are met and when the water temperature is low enough to cause the aquastat to switch ON.

## OPERATIONAL LIMITS

For use on B&G models NRF/NBF/Series PL, indoor use only

Power supply: 115-120 VAC, 60Hz, 1Ø

Minimum switch interval: 15 minutes

Run Modes: ON (continuous run), OFF (off at all times), TIMER (run at programmed intervals)

Maximum switch current: 16 amps

Aquastat switch modes: OFF (open) at 120°F (48.9°C) and ON (closed) at 100°F (37.8°C)

Aquastat type: Bimetal element, senses surface temperature of outside diameter of pipe

Pipe Size: AQS-1/2 clips onto 1/2" copper pipe or 3/8" steel pipe (OD of pipe 5/8")

AQS-3/4 clips onto 3/4" copper pipe or 1/2" steel pipe (OD of pipe 7/8")

Mounting: May be installed to sense temperature at the suction or discharge pipe of the pump

**NOTE!** Aquastat operation is dependent on ambient environment. In installations with excessive heat gain or loss in the ambient may affect the on/off operating temperatures.

## TIMER INSTALLATION

1. Disconnect the electrical supply to the pump.

**⚠ WARNING: ELECTRICAL SHOCK HAZARD**  
Disconnect and lock out the power before making electrical connections. Failure to follow these instructions could result in serious personal injury or death.

2. Remove the screw that holds the steel conduit box cover to the pump.
3. Remove the conduit box cover. The timer assembly replaces the conduit box cover.
4. Disconnect the black and white motor leads from the power supply.
5. Position the plastic base for the timer assembly onto the steel conduit box with the warning/caution label to the rear of the pump.
6. Secure the plastic timer base to the conduit box with one 8-32 screw provided.
7. Verify that the electrical rating of the timer matches the values shown on the nameplate of the circulator.
8. Make the electrical connections according to the wiring diagram provided. (See Figure 2)

**⚠ WARNING: ELECTRICAL SHOCK HAZARD**  
Electrical connections are to be made by a qualified electrician in accordance with all applicable codes, ordinances and good practices. Failure to follow these instructions could result in serious personal injury, death and/or property damage.

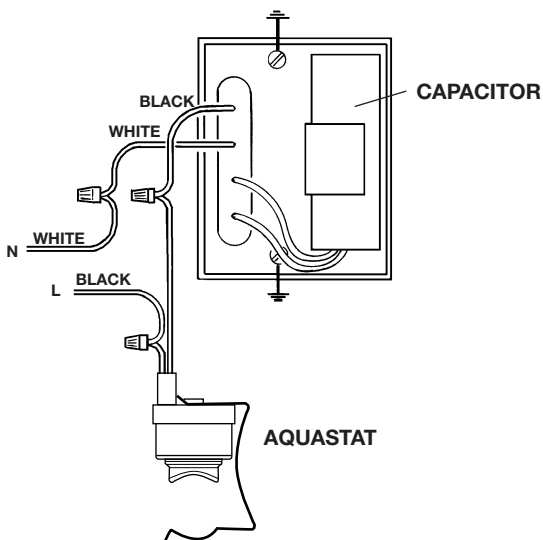

FIGURE 1

9. Position the cover/timer assembly over the base while insuring that all wires are inside the box. Note that the cover/timer assembly can only be assembled in one direction on the base. Line up the screw holes in the cover with the screw holes in the base.
10. Fasten the cover to the base using (2) 8-32 screws provided.

## AQUASTAT INSTALLATION

1. Follow steps 1 and 2 in the timer installation section.
2. Remove the conduit box cover. If the aquastat is installed without the timer, the steel cover is reassembled on the pump after the aquastat installation is complete.
3. Fasten the aquastat clip to the discharge or suction pipe of the pump.
4. Make the electrical connections according to the wiring diagram provided. (See Figure 1)

**⚠ WARNING: ELECTRICAL SHOCK HAZARD**  
Electrical connections are to be made by a qualified electrician in accordance with all applicable codes, ordinances and good practices. Failure to follow these instructions could result in serious personal injury, death and/or property damage.

5. Reassemble the conduit box cover to the conduit box while insuring that all wires are inside the box. Reinstall the 8-32 screw to secure the cover to the conduit box.

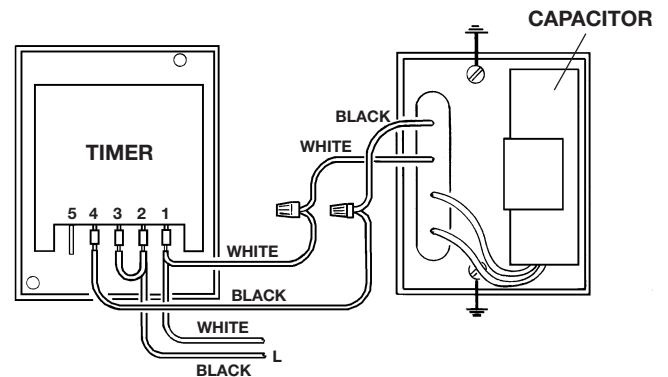

FIGURE 2

## AQUASTAT AND TIMER INSTALLATION

1. Follow the installation steps in both sections and see Figure 3 for wiring connections.

## TIMER PROGRAMMING

1. Adjust the programming ring on the unit by turning it in the direction of the rotation arrow until the timing arrow points to the actual time of day. (This can also be accomplished by rotating the minute hand on the real time clock, (shown in figure 5) clockwise, until both the real time clock and the timing arrow indicate the actual time of day.)
2. Restore power to the circulator and set the switch on the timer dial to the "I" (ON) position.

3. Program the "ON/OFF" times by pushing the programming tabs toward the center of the dial for "OFF" operation and toward the outside of the programming ring for "ON" time periods. A pencil, pen or similar object may be used in making adjustments to the programming tabs.
4. Set the manual switch to the "TIMER" position, which is centered between the "I" and "O" on the timer dial, in order to cycle the pump according to the programming tab settings. The pump will run continuously when the switch is set to the "I" (ON) position. The "O" (OFF) position of the switch will shut the circulator off at all times.
5. In the event of a power outage, the timer must be adjusted for the correct time of day after power is restored.

FIGURE 3

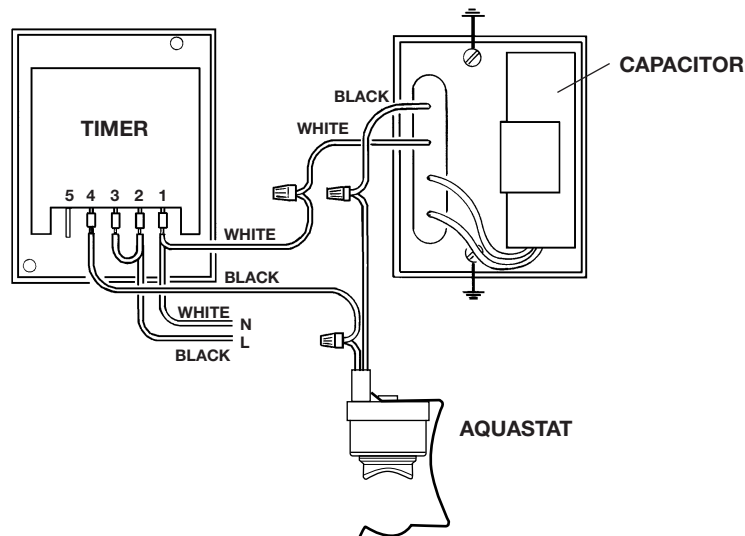

FIGURE 4

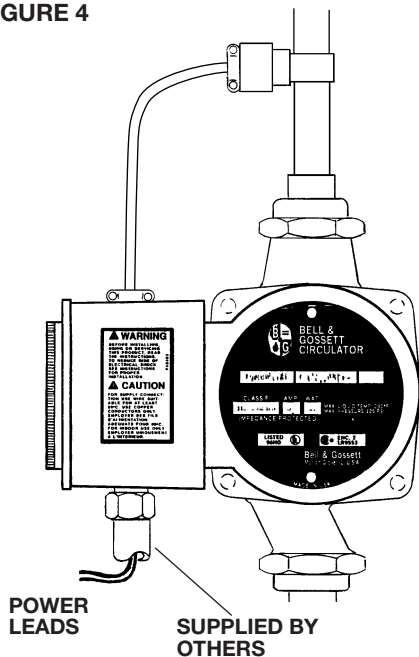
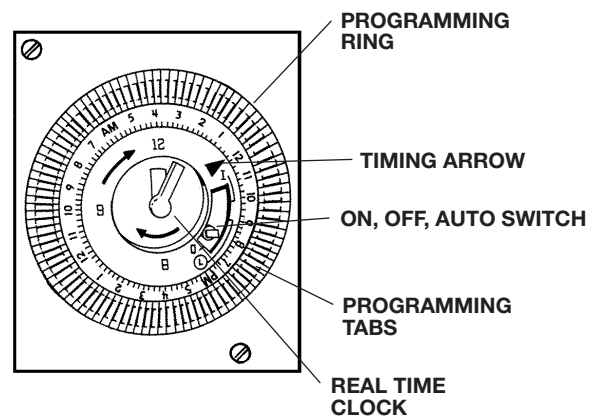

FIGURE 5



## PUMPS WITH FLEXIBLE CORD

1. Refer to instruction Manual P58671 or P48419 for installation of the pump.
2. If your pump is equipped with a flexible cord, insert the 115V plug into a properly grounded 115V outlet. (see Figure 6)



### WARNING: ELECTRICAL SHOCK HAZARD

This pump is supplied with a grounded conductor. To reduce the risk of electric shock, connect only to a properly grounded, grounding-type receptacle. Failure to follow these instructions could result in serious personal injury or death.

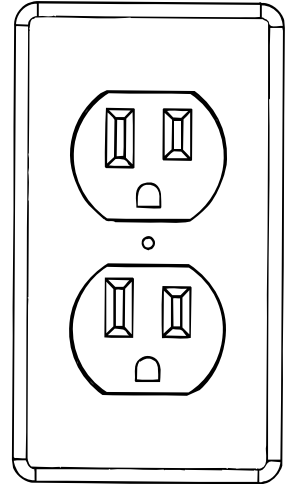
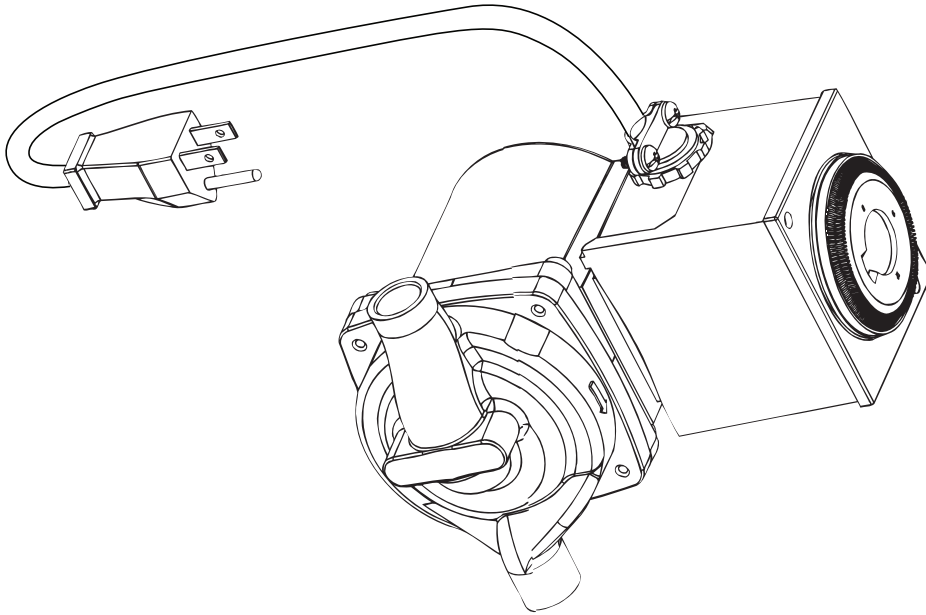

FIGURE 6



Xylem Inc.  
8200 N. Austin Avenue  
Morton Grove, Illinois 60053  
Phone: (847) 966-3700  
Fax: (847) 965-8379  
[www.xylem.com/brands/bellgossett](http://www.xylem.com/brands/bellgossett)

Bell & Gossett is a trademark of Xylem Inc. or one of its subsidiaries.  
© 2012 Xylem Inc. P58749C May 2012