

## INSTALLATION AND OPERATING INSTRUCTIONS

# Astro 2 Series - Hot Water Re-circulation System

### TYPICAL APPLICATIONS

Armstrong Astro 2 hot water re-circulation systems automatically circulate water through domestic hot water distribution pipes. This helps to ensure that everyone in the household has “instant” hot water at the tap when they need it, while also helping to conserve water and save water heating energy costs. All systems are assembled, wired, tested, and then shipped from the factory, ready for installation.



### HOW IT WORKS

In normal operation, the Astro 2 automatically starts re-circulating water throughout the hot water distribution system whenever the timer enables activation. The timer can be set for one or more activation periods per day. An activation period consists of a multiple (up to 96) of 15 minute time intervals. The timer includes manual on and off overrides to normal automatic operation.

Some models are equipped with an Aquastat, intended for use on metallic piping. The Aquastat enables operation only when the sensed water temperature is below 85°F (25°C). Once activated, the circulator operates until either the water temperature reaches 105°F (41°C), or the current timed activation period ends.

### TECHNICAL DATA

| TECHNICAL DATA                            |                                                                         |
|-------------------------------------------|-------------------------------------------------------------------------|
| Power Connection                          | 5.0 ft (1.5 m) power cord, molded duplex plug with ground               |
| Environment                               | Indoor use only                                                         |
| Max. Working Pressure                     | 100 psi (689 kPa)                                                       |
| Ambient Temperature                       | 39°F (4°C) to 104°F (40°C)                                              |
| Max. Water Temperature                    | 140°F (60°C)                                                            |
| Low Temperature Switchpoint <sup>1</sup>  | 85°F (29°C) ±10%                                                        |
| High Temperature Switchpoint <sup>1</sup> | 105°F (40°C) ±10%                                                       |
| Clock/Timer                               | 12-hour analog clock with AM/PM indication                              |
| Timer Settings                            | Individual mechanical toggles for each 15 minute interval over 24 hours |
| Manual Override                           | 3 position slide switch; on/auto/off                                    |

<sup>1</sup>High/low temperature switch points are as measured on pipe surface with the Aquastat (-TA models only).

| MATERIALS OF CONSTRUCTION (Wetted Parts) |                                       |
|------------------------------------------|---------------------------------------|
| Pump Casing                              | Lead Free Bronze* or Stainless Steel* |
| Pump Shaft                               | Polyether Imide (PEI)                 |
| Impeller                                 | Ceramic                               |
| Bearings                                 | Ceramic                               |
| Bearing Seal                             | EPDM                                  |

\*Complies with section 116875 of the California Health and Safety Code and Vermont Act 193 (Lead content of wetted surface is 0.25% or less.)

| Model               | Connection    | Size | Cord | Timer | Aquastat | Electrical Data              | Weight    |
|---------------------|---------------|------|------|-------|----------|------------------------------|-----------|
| Astro 220SSU050S-TA | Sweat         | ½"   | ✓    | ✓     | ✓        | 115 Vac, 60 Hz, 0.36 A, 43w  | 6.3 (2.9) |
| Astro 220SSU075S-TA | Sweat         | ¾"   | ✓    | ✓     | ✓        | 115 Vac, 60 Hz, 0.36 A, 43w  | 6.3 (2.9) |
| Astro 225BS050S-TA  | Sweat         | ½"   | ✓    | ✓     | ✓        | 115 Vac, 60 Hz, 0.64 A, 75w  | 6.3 (2.9) |
| Astro 225BS075S-TA  | Sweat         | ¾"   | ✓    | ✓     | ✓        | 115 Vac, 60 Hz, 0.64 A, 75w  | 6.3 (2.9) |
| Astro 220SSU-TA     | NPSM Union    | 1¼"  | ✓    | ✓     | ✓        | 115 Vac, 60 Hz, 0.36 A, 43w  | 6.8 (3.1) |
| Astro 225SSU-TA     | NPSM Union    | 1¼"  | ✓    | ✓     | ✓        | 115 Vac, 60 Hz, 0.69 A, 83w  | 6.8 (3.1) |
| Astro 230SS-TA      | 2-bolt Flange |      | ✓    | ✓     | ✓        | 115 Vac, 60 Hz, 0.81 A, 97w  | 8.3 (3.8) |
| Astro 250SS-TA      | 2-bolt Flange |      | ✓    | ✓     | ✓        | 115 Vac, 60 Hz, 0.98 A, 117w | 8.3 (3.8) |
| Astro 220SSU050S-T  | Sweat         | ½"   | ✓    | ✓     | ---      | 115 Vac, 60 Hz, 0.36 A, 43w  | 6.3 (2.9) |
| Astro 220SSU075S-T  | Sweat         | ¾"   | ✓    | ✓     | ---      | 115 Vac, 60 Hz, 0.36 A, 43w  | 6.3 (2.9) |
| Astro 225BS050S-T   | Sweat         | ½"   | ✓    | ✓     | ---      | 115 Vac, 60 Hz, 0.64 A, 75w  | 6.3 (2.9) |
| Astro 225BS075S-T   | Sweat         | ¾"   | ✓    | ✓     | ---      | 115 Vac, 60 Hz, 0.64 A, 75w  | 6.3 (2.9) |
| Astro 220SSU-T      | NPSM Union    | 1¼"  | ✓    | ✓     | ---      | 115 Vac, 60 Hz, 0.36 A, 43w  | 6.8 (3.1) |
| Astro 225SSU-T      | NPSM Union    | 1¼"  | ✓    | ✓     | ---      | 115 Vac, 60 Hz, 0.69 A, 83w  | 6.8 (3.1) |
| Astro 230SS-T       | 2-bolt Flange |      | ✓    | ✓     | ---      | 115 Vac, 60 Hz, 0.81 A, 97w  | 8.3 (3.8) |
| Astro 250SS-T       | 2-bolt Flange |      | ✓    | ✓     | ---      | 115 Vac, 60 Hz, 0.98 A, 117w | 8.3 (3.8) |
| Astro 220SSU050S-LC | Sweat         | ½"   | ✓    | ---   | ---      | 115 Vac, 60 Hz, 0.36 A, 43w  | 6.0 (2.7) |
| Astro 220SSU075S-LC | Sweat         | ¾"   | ✓    | ---   | ---      | 115 Vac, 60 Hz, 0.36 A, 43w  | 6.0 (2.7) |
| Astro 225BS050S-LC  | Sweat         | ½"   | ✓    | ---   | ---      | 115 Vac, 60 Hz, 0.64 A, 75w  | 6.0 (2.7) |
| Astro 225BS075S-LC  | Sweat         | ¾"   | ✓    | ---   | ---      | 115 Vac, 60 Hz, 0.64 A, 75w  | 6.0 (2.7) |
| Astro 220SSU-LC     | NPSM Union    | 1¼"  | ✓    | ---   | ---      | 115 Vac, 60 Hz, 0.36 A, 43w  | 6.5 (2.9) |
| Astro 225SSU-LC     | NPSM Union    | 1¼"  | ✓    | ---   | ---      | 115 Vac, 60 Hz, 0.69 A, 83w  | 6.5 (2.9) |
| Astro 230SS-LC      | 2-bolt Flange |      | ✓    | ---   | ---      | 115 Vac, 60 Hz, 0.81 A, 97w  | 8.0 (3.6) |
| Astro 250SS-LC      | 2-bolt Flange |      | ✓    | ---   | ---      | 115 Vac, 60 Hz, 0.98 A, 117w | 8.0 (3.6) |

Note: All weights are in lbs. (kg)

## INSTALLATION

### WARNING:

- Installation should only be completed by qualified personnel, in accordance with all applicable codes, and following generally accepted installation practices.
- Ensure the hot water supply is turned off before installation, to avoid personal injury or damage to property.
- Read and understand these instructions thoroughly before beginning the installation.

**CAUTION:** Prior to installation, flush all piping of any foreign material to prevent pump blockage and prevent damage.

## PROCEDURE

### 1. Timer installation and wiring

**Note:** Numerical component designations included in Steps a through i refer to circulator and timer components shown in Fig. 1.

- Unfasten the mounting screw (4A) and remove the terminal box cover (3).
- Disconnect motor leads from the power supply.
- Unfasten the mounting screw (4B) on the timer box cover (10) and detach it from the base (8).
- Remove the original conductor (7A) from the circulator terminal box (2)
- Fasten the connection adaptor (7B) to the circulator terminal box (2)
- Fasten the threaded fitting (6) to the connection adaptor (7B)
- Fasten the lock nut (5A) on the end of the threaded fitting (6) and insert the timer box (8)
- Fasten the lock nut (5B) onto the end of the threaded fitting (6) so the timer box (8) is in between and securely attached.
- Connect timer lead wires (black, white and green) to the terminal box (See Fig. 2 for 24-Hour Timer wiring diagram. See Fig. 3 for 24-Hour timer and Aquastat Control wiring diagram.)
- Re-attach the timer box cover (10) using the mounting screw (4B). Insure that all lead wires are inside the timer assembly.
- Close the terminal box cover (3) by fastening the mounting screw (4A).

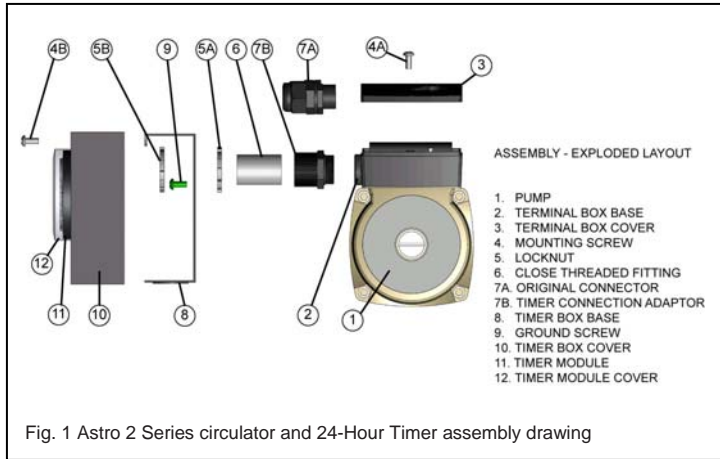

Fig. 1 Astro 2 Series circulator and 24-Hour Timer assembly drawing

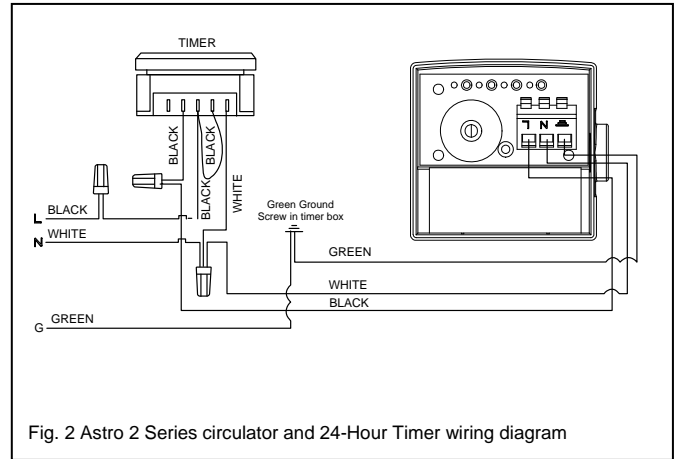

Fig. 2 Astro 2 Series circulator and 24-Hour Timer wiring diagram

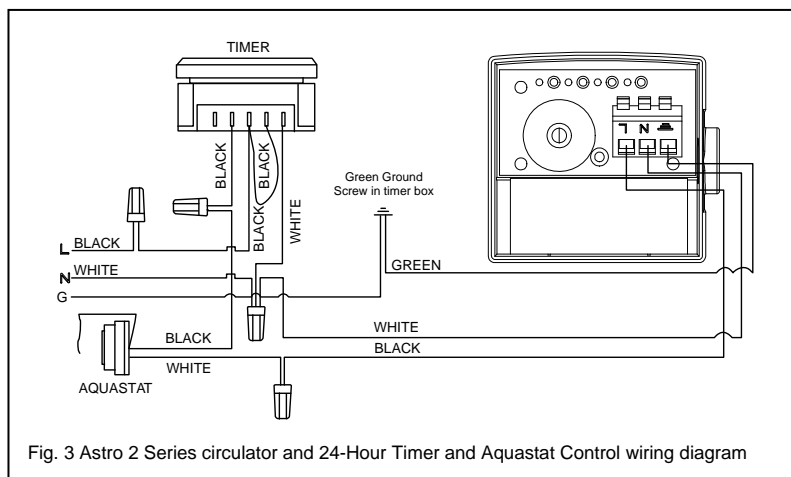
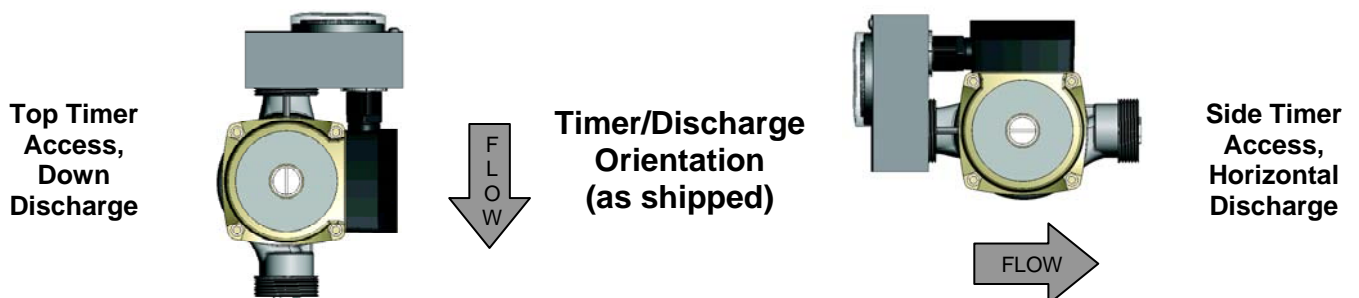
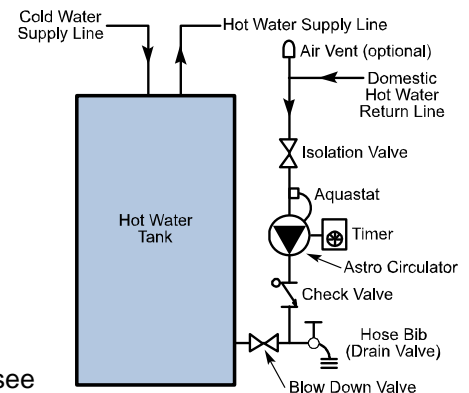

Fig. 3 Astro 2 Series circulator and 24-Hour Timer and Aquastat Control wiring diagram

2. Select a suitable location for system installation. Typically, the Astro system is mounted near the hot water heater. The inlet is connected to a return line from the furthest hot water tap in the system. The discharge is connected into the hot water heater drain line.
3. Ensure the following conditions are met when the system is mounted:
  - i. The circulator shaft is horizontal.
  - ii. The clock/timer face is accessible for viewing and adjustment.
  - iii. The direction of water flow matches the arrow on the circulator casing.
  - iv. The piping is sufficiently rigid to support the system in operation.
  - v. Neither the clock/timer nor black terminal box is under the circulator.
4. The Astro system is shipped fully assembled and tested to suit either down discharge orientation with the clock timer facing up, or horizontal discharge with the clock timer facing the water supply side. For alternate orientation, see **ROTATING THE CIRCULATOR CASING.**



5. Connect the hot water return line to the circulator, verifying proper flow direction.

6. Attach the Aquastat by the integral spring clip, to either the circulator inlet or discharge piping, whichever is most convenient. Ensure the concave sensor face of the Aquastat remains in direct contact with the pipe surface.
7. Supply water to the system and inspect connections and components for leaks.
8. In order to purge the air from the recirculation line:
  - i. Make sure that the system is connected to the cold water line and no fixtures are in use in the building.
  - ii. Close the blow down valve.
  - iii. Open the drain valve. Wait until all the air is purged from the system and the water flow is steady through the drain valve.
  - iv. Close the drain valve.

Vent the circulator to remove trapped air:

- v. Place a one gallon or larger container under the circulator.
  - vi. Loosen the brass plug in the end of the circulator with a slotted screwdriver until water just begins to run out into the container.
  - vii. When the vented water is free of air bubbles, gently retighten the brass plug until sealed.
  - viii. Open the blow down valve.
- The system is purged by air and ready for operation.
9. Verify that the timer's manual override switch is in the "OFF" position.
  10. Plug the power cord into a standard 115 V ac electrical receptacle.
  11. To perform an initial system test for basic operation, see **OPERATION**.

## ROTATING THE CIRCULATOR CASING

Prior to connecting the system to the hot water piping, if alternate orientation of either the circulator discharge or clock timer is required, proceed as follows:

1. Remove the four hex socket head screws that hold the casing to the circulator.
2. Gently pull the casing from the circulator body, taking care not to damage the gasket or impeller.
3. Rotate the casing as required to meet circulator discharge and clock timer orientation requirements.
4. Tighten the four hex socket head screws evenly, ensuring the gasket seals the mating surfaces.
5. To verify the circulator shaft still spins freely:
  - i. Remove the plug from the end of circulator with a slotted screwdriver.
  - ii. Insert the screwdriver in the slot in the end of the shaft.
  - iii. Ensure the shaft turns freely and smoothly in both directions.
  - iv. Replace the plug and gently tighten.

## OPERATION

**CAUTION:** Never operate the system "dry" or permanent damage may occur to the circulator. Never shut off the water supply or restrict flow in any way while the circulator is operating.

1. Verify water is present at the circulator.
2. Verify the power cord is plugged into an appropriate household electrical receptacle.
3. To continuously run the circulator or test for initial operation, set the manual override switch to the "ON" position and verify the circulator operates smoothly and quietly.
4. To prevent circulator operation, such as for extended periods that the residence will be vacated, set the manual over ride switch to the "OFF" position.
5. For normal automatic operation, set the clock/timer as required and move the manual override switch to the "AUTO" position.

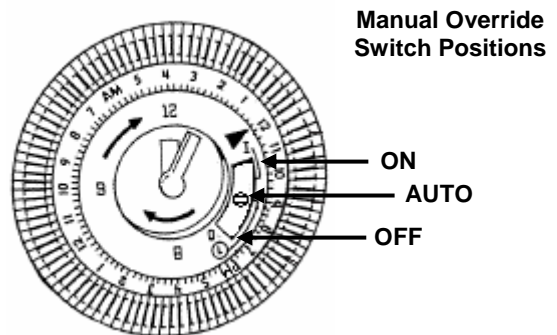

## SETTING THE CLOCK/TIMER

1. Rotate the dial in a clockwise direction until both the time shown, and the appropriate AM or PM indicator, correspond to the current time of day. (This adjustment is required for initial operation, following a power interruption, to adjust for daylight savings time, or for periodic time correction.)
2. Remove the clear plastic cover from the dial.
3. The outer ring of the dial has an adjustable tab for each 15 minute time interval of a 24 hour day. To enable circulator operation for a specific time interval, slide the corresponding interval tab toward the perimeter of the dial. All tabs positioned toward the center of the dial disable circulator operation for those time intervals.
4. Verify the manual override switch is in the "AUTO" position.
5. Replace the clear plastic cover on the dial.

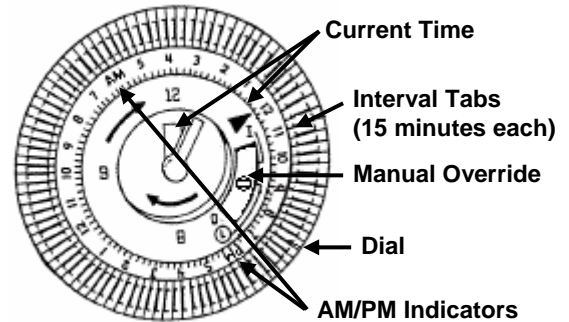

## REPLACEMENT PARTS

| ASTRO MODELS (PUMP ONLY) | ITEM NUMBER |
|--------------------------|-------------|
| Astro 220SSU w/ 1/2" SWT | 110223-301  |
| Astro 220SSU w/ 3/4" SWT | 110223-302  |
| Astro 225BS 1/2" SWT     | 110223-303  |
| Astro 225BS 3/4" SWT     | 110223-304  |
| Astro 230SS              | 110223-306  |
| Astro 250SS              | 110223-308  |
| Astro 220SSU             | 110223-309  |
| Astro 225SSU             | 110223-310  |

| PART DESCRIPTION | ITEM NUMBER |
|------------------|-------------|
| 24-Hour Timer    | 810123-130  |
| Timer Cover      | 110123-031  |
| 1/2" Aquastat    | 110123-120  |
| 3/4" Aquastat    | 110123-121  |

S. A. Armstrong Limited  
 23 Bertrand Avenue  
 Toronto, Ontario  
 Canada, M1L 2P3  
 T: 416-755-2291  
 F: 416-759-9101

Armstrong Pumps Inc.  
 93 East Avenue  
 North Tonawanda, New York  
 U.S.A. 14120-6594  
 T: 716-693-8813  
 F: 716-693-8970

Armstrong Integrated Limited  
 Wenlock Way  
 Manchester  
 United Kingdom, M12 5JL  
 T: +44 (0) 8444 145 145  
 F: +44 (0) 8444 145 146

