

UP Series

Circulator pumps
60 Hz



Contents

Mission	3	UP 15-10 F/FR	32
		UP Comfort System 15-10 SU7P/TLC	33
Cross reference		UP 15-18 B5/B7	34
Quick cross reference for competitive 3-speed pumps	4	UP 15-18 BUC5/BUC7	35
Reference for replacing ALPHA models	5	UP 15-29 SU/SF	36
Reference for replacing Comfort models	5	UP 15-35 SUC	37
Reference for replacing TACO models	6	UPS 15-35 SUC/SFC	38
Reference for replacing Bell & Gossett models	8	UP 15-42 B5/B7	39
Reference for replacing Laing models	9	UP 15-42 BUC5/BUC7	40
Reference for replacing Armstrong models	10	UP 15 MixiMizer 15-42 BUC5/MR and BUC7/MR	41
Discontinued products	11	UP 15-42 F/FR	42
		UPS 15-42 F	43
		UP 15 MixiMizer 15-42 FC/MR	44
		UP 15 Variable Speed 15-42 F/VS	45
Performance ranges		UP 15-55 SUC	46
3-speed	12	UPS 15-55 SFC/SUC	47
3-speed stainless steel	13	ALPHA 15-55 F/FR/SF/LC	48
Comfort Pump	13	UPS 15-58 FC/FRC	50
Closed systems	14	UP 15-100 F	51
Open systems	14	UP 26-64 F	52
Open systems 1/2"	15	UP 26 Variable Speed 26-64 F/VS	53
Open systems 3/4"	15	UP 26-96 F/BF	54
		UP 26 Variable Speed 26-96F/VS	55
Product range		UP 26-99 F/BF	56
Cast iron	16	UPS 26-99 F/BFC	57
Bronze	17	UP 26-116 F/BF	58
Stainless steel	18	UP 26-120 U	59
		UPS 26-150 F/SF	60
		UP 43-44 F/BF	61
		UPS 43-44 FC/BFC	62
Identification		UP 43-70 F	63
Type key	19	UP 43-75 F/BF	64
Nameplate	20	UPS 43-100 F/SF	65
		UP 43-110 F	66
		UPS 50-44 F	67
		UPS 50-60 F/SF	68
		UP 50-75 F	69
Applications		Accessories	
Heating systems	21	UP timer	71
Domestic hot-water systems	21	AquaStat	72
Cooling systems	21	Pump Zone Controls	73
Construction	21	Packaged dielectric isolation valve sets	74
Materials of construction	22	Packaged fitting sets	75
Installation	22	UP-ZV zone valves	76
Pumped liquids	23	Replacement flange gaskets	78
Ambient and liquid temperatures	23		
Maximum system pressure	23	Submittal data	
Minimum inlet pressure	23	Submittal data	79
Performance	23		
ALPHA	24	Further product documentation	
MixiMizer - mixing reset pump	25	WebCAPS	81
Variable-speed pump	26	WinCAPS	82
Comfort System	27		
UP 10 Comfort pump	28		
Technical data			
Comfort Pump UP 10-16 B5/BN5	29		
UP 15-10 B5/B7	30		
UP 15-10 BUC5/7	31		

It is our mission — the basis of our existence — to successfully develop, produce and sell high-quality pumps and pumping systems world-wide, contributing to a better quality of life and a healthy environment



Bjerringbro, Denmark



Fresno, California



Olathe, Kansas



Monterrey, Mexico



Allentown, Pennsylvania



Oakville, Ontario

- World's leading pump company
- World's largest manufacturer of circulator pumps, covering more than 50% of the global market
- World headquarters in Denmark
- North American headquarters in Kansas City - Manufacturing in Fresno, California
- 82 companies in 45 countries
- More than 16 million motors and pumps produced annually worldwide
- North American companies operating in USA, Canada and Mexico
- Continuous reinvestment in growth and development enables the company to **BE** responsible, **THINK** ahead, and **INNOVATE**

Quick cross reference for competitive 3-speed pumps

Model	Speed	Competitor cross-reference		
		TACO*	Bell & Gossett*	Armstrong*
ALPHA 15-55 F/SF UPS 15-58 FC/FRC	High	005F, 007F, 008F, 0010F-IFC, 00R-MSF1-IFC	NRF-22, LR-20WR	Astro 30, Astro 30-(3), Astro 50-3, Astro 230CI
	Med.	005F-(IFC), 007F-(IFC), 008F-(IFC), 0010F-IFC, 00R-IFC, 00R-MSF1-IFC	NRF9F/LW, NRF-25 Sp-1 & 2	Astro 25, Astro 30-3
	Low	005F-(IFC), 006F-(IFC), 00R-MSF1-IFC		Astro 20
UPS 26-99 FC/BFC	High	0013(B)-IFC	NRF-36 Sp-2, NRF-45 Sp-2, H-41(B)	E7(B), Astro 50(B)-(3)
	Med.	0011(B)-(IFC), 0014(B)-(IFC)	Series 100, PL-30, PR, NRF-36, Sp-1, NRF-45 Sp-1	Astro 50(B), H41
	Low	—	LR-15BWR	Astro 30(B)
UPS 26-150 F/SF	High	1400-45(B), 1400-50(B)	PL-55(B)	E15(B)
	Med.	0011(B, SF), 0013(B, SF), 1400-20(B), 1400-30(B), 1400-40(B)	PL-36(B)	E8(B), E9(B), E11(B), E13(B)
	Low	—	NRF(NBF)-36 Sp-2 & 3	E7(B), E10(B)
UPS 43-44 FC/BFC	High	0012(B, SF)-(IFC), 113(B)	HV, H-32(B)	E16(B)
	Med.	0010(B, SF)-(IFC), 111(B)	NRF-33	H32
	Low	0010-MSF1-IFC, 110(B)	—	—
UPS 43-100 F/SF	High	—	H-51(B), H-52(B)	E17(B)
	Med.	1400-20(B), 1400-30(B), 1400-40(B), 1400-45(B)	PL-45(B), PL-50(B), NRF(NBF)-45 Sp-2 & 3, NRF-36 Sp-2 & 3	E11(B), E15(B), E16(B)
	Low	—	—	10(B), E13(B)
UPS 50-60 F/SF	High	1400-65 (B), 131(B)	PL-130(B), E19(B), E29(B), S-35(B)	E19(B), E28(B), E29(B), E30(B)
	Med.	1400-60(B), 121(B), 122(B), 131(B)	PL-50(B), PL-75(B)	—
	Low	120(B)	—	E16(B)
UPS 15-35 SFC	High	005BF2-(IFC), 007(B, SF)-(IFC)	NBF(SSF)-12F/LW	SM-909-BF14, Astro 25B, Astro 30(B) Sp-2
	Med.	—	—	Astro 20(B), Astro 30(B)-3 Sp-1 & 2
	Low	—	—	—
UPS 15-35 SUC	High	—	NBF(SSF)-12U/LW	Astro 25BU, Astro 220, 225SSU
	Med.	006BC4-1, 006B7-IFC	NBF-9U/LW	Astro 25BU, Astro 20, 25(BU)
	Low	003-B4-2-IFC	—	—
UPS 15-35 SUC/TLC	High	—	—	Astro 20, 25BU(LC, T), Astro 25U-T
	Med.	—	—	Astro 25U-T
	Low	—	—	—
UPS 15-55 SFC	High	—	—	Astro 30B-(3), Astro 230SS, Astro 30(B), SM-909-BF14, SM-909-BF18
	Med.	005-(B, SF), 006-BF, 007-(B, SF)-(IFC), 008-(B, SF)-(IFC), 00R-SF-IFC	LR-15B, NBF(SSF)-22, NBF-25	Astro 30(B) Sp-2, Astro 30(B)-3 Sp-1
	Low	—	—	Astro 30(B) Sp-1, Astro 50(B) Sp-1

* Grundfos provides no guarantee as to the accuracy of competitor information listed herein.

Reference for replacing ALPHA models

Competitor cross-reference				
Model	Speed	TACO*	Bell & Gossett*	Armstrong*
ALPHA 15-55 F/SF	High	005F, 007F, 008F, 0010F-IFC, 00R-MSF1-IFC	NRF-22, LR-20WR	Astro 30, Astro 50-3
	Med.	005F-(IFC), 007F-(IFC), 008F-(IFC), 0010F-IFC, 00R-IFC, 00R-MSF1-IFC	NRF9F/LW, NRF-25 Sp-1 & 2	Astro 25, Astro 30-3
	Low	005F-(IFC), 006F-(IFC), 00R-MSF1-IFC		Astro 20

* Grundfos provides no guarantee as to the accuracy of competitor information listed herein.

Reference for replacing Comfort models

Competitor cross-reference				
Comparable Grundfos replacement options (UP Comfort)			TACO pumps*	Laing pumps*
Pump type	Page	Connections	Pump type	Pump type
UP 10-16 B5/LC	29	1/2" sweat/cord	003-BC4-4PNP	SM-303-BS,
UP 10-16 B5/TLC	29	1/2" sweat/cord/timer	003-BC4-PNP, 003-BT4-PNP	SMT-303-BS, SMT-303-BSW
UP 10-16 B5/ATLC	29	1/2" sweat/stat/cord/timer		SM-303-BSR, SM-303-BSW, SM303-BSRW, SMT-303-BSR, SMT-303-BSRW
UP 10-16 BN5/LC	29	1/2" FNPT thread/cord		SM-303-BT, SM-303-BTW,
UP 10-16 BN5/TLC	29	1/2" FNPT thread/cord/timer		SMT-303-BT, SMT-303-BTW,
UP 10-16 BN5/ATLC	29	1/2" FNPT thread/stat/cord/timer	003-BT4-PNP (Plus Star)	SM-303-BTR, SM-303-BTRW, SMT-303-BTR, SMT-303-BTRW

* Grundfos provides no guarantee as to the accuracy of competitor information listed herein.

Reference for replacing TACO models

Competitor cross-reference						
Open systems: Stainless steel and bronze body pumps						
Comparable Grundfos replacement options				Taco pumps*		
Primary model (s)	Page no.	Conn. type	Pump length [inches]	Model	Conn. type	Pump length [inches]
UP 15-10 B5	30	1/2" sweat	5	003-BC4	1/2" sweat	4 13/32
UP 15-10 B5/LC				003-BC4-4PNP	1/2" sweat	4 1/4
UP 15-10 B5/TLC				003-BC4-PNP	1/2" sweat	4 1/4
UP 15-10 BUC5				003-BC4-1IFC	Union	5 15/16
UP 15-10 BUC5/LC				003-BC4-7PNP	1/2" sweat	4 1/4
UP 15-10 BUC5/TLC				003-BC4-3PNP	1/2" sweat	4 1/4
UP 15-10 B7	30	3/4" sweat	6 3/8	003-B4, 003-ST4	3/4" sweat	4 13/32
UP 15-10 B7/LC				003-B4-1PNP		
UP 15-10 B7/TLC				003-B4-PNP		
UP 15-10 BUC7				003-BC4-IFC		
UP 15-10 BUC7/LC				003-BC4-6PNP		
UP 15-10 BUC7/TLC				003-BC4-2PNP		
UP 15-18 B5	34	1/2" sweat	5	006-BC4, 006-ST4	1/2" sweat	4 1/4
UP 15-18 B5/LC				006-BC4-2PNP		
UP 15-18 B5/LC				006-BC4-PNP		
UP 15-18 BUC5				006-BC7-1IFC		
UP 15-18 B7	34	3/4" sweat	6 3/8	006-B4	3/4" sweat	4 13/32
UP 15-18 B7/LC				006-B4-1PNP		
UP 15-18 B7/TLC				006-B4-PNP		
UP 15-18 BUC7				006-BC7-IFC		
UP 15-29 SF	36	Flange	6 1/2	007-SF5	Flange	6 3/8
UP 15-29 SU				006-BC4-1		
UP 15-29 SU/LC				006-BC4-3PNP		
UP 15-29 SUC/TLC				003-BC4-1PNP		
UP 15-42 B7	39	3/4" sweat	6 3/8	008-BC6	3/4" sweat	6 3/8
UP 15-42 BUC7				008-BC6-IFC		
UPS 15-55 SUC	47	1 1/4" U	5 7/8	003-BC-1	Union	6
				005-BF2		
				007-BF5		
UPS 15-55 SFC				005-SF2, 005-SFC-IFC, 007-BF5, 007-BF-IFC, 007-SF5, 007-SF5-IFC, 008-BF-IFC, 008-SF6, 008-SF-IFC		
		008-BF6	Flng-R			
UP 26-99 BF	56	Flange	6 1/2	0011-BF4, 0011-SF4, 0011-SF4--IFC, 0014-BFI, 0014-BF-IFC, 0014-SF1, 0014-SF-IFC	Flange	6 1/2
UPS 26-99 BFC				57		
UP 26-116 BF (230V)	58	Flange	6 1/2	0013-BF3, 0013-BF-IFC, 0013-SF3, 0013-SF-IFC	Flange	6 1/2
UPS 26-150 SF	60					
UP 43-44 BF	61	Flange	8 1/2	0012-BF4	Flange	8 1/2
				0010-BF2, 0010-BF-IFC, 0010-SF3, 0010-SF3-IFC		
UPS 43-44 BFC				62		

Reference for replacing TACO models (continued)

UPS 26-99 BFC	57	Flange	6 1/2	1400-10B	Flange	6 3/8
UPS 26-150 SF	60	Flange	6 1/2	1400-20B, 1400-30B, 1400-40B, 1400-45B, 1400-50B	Flange	6 3/8
UPS 43-100 SF	65	Flange	8 1/2	1400-60B	Flange	8 1/2
UPS 50-60 SF	68	Flange	8 1/2	1400-65B	Flange	8 1/2
UPS 43-44 BFC	62	Flange	8 1/2	110B	Flange	6 5/16
				111B		8 3/4
				113B		8 1/2
UPS 43-100 SF	65	Flange	8 1/2	112B,	Flange	6 3/8
UPS 50-60 SF	68	Flange	8 1/2	120B	Flange	11
				121B, 122B	Flng-R	11 1/8
				131B, 132B		13 5/8
Closed systems: Cast iron body pumps						
UP 15-42 FC/MR	44	Flange	6 1/2	008-VDTF6	Flange	6 3/8
UPS 15-58 FC	50	Flange	6 1/2	005-F2, 005-F2-2IFC	Flange	6 3/8
UP 15-10 FR	32			006-F4		
UPS 15-58 FRC	50	Flng-R	6 1/2	006-F4-IFC	Flng-R	6 3/8
				007-F5-8IFC, 008-F6-1IFC		
UPS 15-58 FC	50	Flange	6 1/2	00R-MSF1-IFC, 007-F5, 008-F6	Flange	6 3/8
UP 15-100 F	51	Flange	6 1/2	009-F5	Flng-R	6 3/8
UP 26-64 F	52			0014-F		
UPS 26-99 FC	57	Flange	6 1/2	0014-F	Flng-R	6 1/2
UP 26-116 F (230 V)	58			0013-F		
UPS 26-150 F	60	Flange	6 1/2	0011-F4, 0011-F4-2IFC, 0013-F3, 0013-F3-1IFC, 0014-F1,0014-F1-IFC	Flng-R	6 1/2
UPS 43-44 FC	62	Flange	8 1/2	0010-F3, 0010-F3-IFC, 0012-F4, 0012-F4-IFC	Flange	6 3/8, 8 1/2
UPS 26-99 FC	57			1400-10		
UPS 26-150 F	60	Flange	6 1/2	1400-20,1400-30, 1400-40, 1400-45, 1400-50	Flange	6 3/8
UPS 43-100 F	65	Flange	8 1/2	1400-60	Flange	8 1/2
UPS 50-60 F	68	Flange	8 1/2	1400-65	Flange	8 1/2
UPS 43-44 FC	62	Flange	8 1/2	110	Flange	6 5/16
				111		8 3/4
				113		8 1/2
UPS 43-100 F	65	Flange	8 1/2	112	Flange	6 3/8
UPS 50-60 F	68	Flange	8 1/2	120	Flange	11
				121, 122	Flng-R	11 1/8
				131, 132		13 5/8

* Grundfos provides no guarantee as to the accuracy of competitor information listed herein.

Reference for replacing Bell & Gossett models

Competitor cross-reference						
Open systems: Stainless steel and bronze body pumps						
Grundfos				Bell & Gossett*		
Primary model(s)	Page	Conn. type	Pump length [inches]	Model	Conn. type	Pump length [inches]
UP 15-10 B5	30	1/2" sweat	5	NBF-8S/LW	1/2" sweat	5
UP 15-29 SU	36	1 1/4" U	5 7/8	NBF-9U/LW	3/4"NPT, 1/2 & 3/4" sweat	6 1/8
UP 15-18 B5	34	1/2" sweat	5	NBF-10S/LW	1/2" sweat	5
UPS 15-35 SUC	38	1 1/4" U	5 7/8	NBF-9U/LW, NBF-12U/LW, SSF-12U/LW	1 1/4" U	6 1/8
UPS 15-35 SUC/TLC	38	1 1/4" U	5 7/8	NBF-9U/TP, SSF-19U/TP	3/4"NPT, 1/2 & 3/4" sweat	6 1/8
UPS 15-35 SFC	38	Flange	6 1/2	NBF-12F/LW, SSF-12F/LW	Fling-R	6 3/8
UP 15-42 B5	39	1/2" sweat	5	NBF-18S	1/2" sweat	5
UPS 15-55 SUC	47	1 1/4" U	5 7/8	NBF-22U, SSF-22U, NBF-18SU	3/4"NPT, 1/2 & 3/4" sweat	6 1/8
UPS 15-55 SFC	47	Flange	6 1/2	NBF-22, NSF-22	Fling-R	6 3/8
				LR-15B, NBF-25	Flange	6 3/8
UP 26-96 BF	54	Flange	6 1/2	Series PR B	Fling-R	8 1/2
				PL-30B	Flange	6 3/8
UPS 26-99 BF	56	Flange	6 1/2	Series PR B	Fling-R	8 1/2
				PL-30B, LR-15BWR, NBF-36 Sp-1 & 2, NBF-45 Sp-1, Series 100	Flange	6 3/8
UP 26-116BF (230 V)	58	Flange	6 1/2	PL-36B	Flange	6 1/2
UPS 26-150SF	60	Flange	6 1/2	PL-36B, PL-55B, NBF-36 Sp-2 & 3, NBF-45	Flange	6 3/8, 8 1/2
UP 43-44 BF	61	Flange	8 1/2	Series HV B	Fling-R	8 1/2
UPS 43-44 BF	62	Flange	8 1/2	LR-15BWR, NBF-33		6 3/8
UPS 43-100 SF	65	Flange	8 1/2	PL-45B, PL-50B, NBF-36 Sp-2 & 3, NRF(NBF)-45 Sp-2 & 3	Flange	8 1/2
UPS 50-60 SF	68	Flange	8 1/2	PL-50B, PL-75B, PL-130B	Flange	8 1/2
Closed systems: Cast iron body pumps						
UP 15-10 FR	32	Fling-R	6 1/2	NRF-9F/LW	Fling-R	6 3/8
UP 15-42 FR	42	Fling-R	6 1/2			
UPS 15-58 FRC	50	Fling-R	6 1/2			
UP 15-42 FR	42	Fling-R	6 1/2	NRF-22	Fling-R	6 3/8
UPS 15-58 FRC	50	Fling-R	6 1/2			
UP 15-42 F	42	Flange	6 1/2	NRF-22, LW020WR, NRF9F/LW NRF-25 Sp-1 & 2	Flange	6 3/8
UPS 15-42 F	43	Flange	6 1/2			
UPS 15-58 FC	50	Flange	6 1/2			
UP 26-64 F	52	Flange	6 1/2	Series PR	Fling-R	8 1/2
UP 26-64 F	52	Flange	6 1/2	PL-30	Flange	6 3/8
UPS 26-99 FC	57	Flange	6 1/2	Series 100, PL-30, PR, NRF-36 Sp-1 & 2, NRF-45 Sp-1 & 2, LR-20WR	Flange	
UP 26-116 F (230 V)	58	Flange	6 1/2	PL-36	Flange	6 3/8
UPS 26-150 F	60	Flange	6 1/2	PL-36, PL-55, NRF-36 Sp-2 & 3, NRF-45	Flange	6 3/8
UP 43-44 F	61	Flange	8 1/2	Series HV, NRF-33	Fling-R	8 1/2
UPS 43-44 FC	62	Flange	8 1/2	LR-20WR, NRF-33, Series HV	Flange	6 3/8
UPS 43-100 F	65	Flange	8 1/2	PL-45, PL-50, NRF-36 Sp-2 & 3, NRF-45 Sp-2 & 3	Flange	8 1/2
UPS 50-44 F	67	2" Fling	8 1/2	2", PL-75	2" Fling-R, Fling	8 1/2
UPS 50-60 F	68	Flange	8 1/2	PL-50, PL-75, PL-130	Flange	8 1/2

* Grundfos provides no guarantee as to the accuracy of competitor information listed herein.

Reference for replacing Laing models

Competitor cross-reference						
Open systems: Stainless steel and bronze body pumps						
Comparable Grundfos replacement options				Laing pumps*		
Model(s)	Page	Conn. type	Pump length [inches]	Model	Conn. type	Pump length [inches]
UP 15-18 B5	34	1/2" sweat	5	SM-909-BS-1/2-14	1/2" sweat	6
UP 15-18 B5/LC				SM-909-BSW-1/2-14		
UP 15-18 B5/TLC				SMT-909-BS-1/2-14, SMT-909-BSW-1/2-14		
UP 15-18 B7	34	3/4" sweat	6 3/8	SM-909-BS 3/4-14	3/4" sweat	6
UP 15-18 B7/LC				SM-909-BSW 3/4-14		
UP 15-18 B7/TLC	34	3/4" sweat	6 3/8	SMT-909-BS 3/4-14, SMT-909-BSW-3/4-14		
UPS 15-35 SFC	38	Flange	6 1/2	SM-909-BF14	Flange	6 1/2
UPS 15-55 SFC	47	Flange	6 1/2	SM-909-BF14, SM-909-BF18	Flange	6 1/2

* Grundfos provides no guarantee as to the accuracy of competitor information listed herein.

Reference for replacing Armstrong models

Competitor cross-reference						
Open systems: Stainless steel and bronze body pumps						
Comparable Grundfos replacement options				Armstrong pumps*		
Primary model(s)	Page	Conn. type	Pump length [inches]	Model	Conn. type	Pump length
UP 15-10 B5	30	1/2" sweat	5	Astro 20B050S	1/2" sweat	5
UP 15-10 B5/LC		1/2" sweat	5	Astro 20B050S-LC	1/2" sweat	5
UP 15-10 B5/TLC		1/2" sweat	5	Astro 20B050S-T	1/2" sweat	5
UP 15-10 B7	30	3/4" sweat	6 3/8	Astro 20B075S	3/4" sweat	5
UP 15-10 B7/LC		3/4" sweat	6 3/8	Astro 20B075S-LC	3/4" sweat	5
UP 15-10 B7/TLC		3/4" sweat	6 3/8	Astro 20B075S-T	3/4" sweat	5
UPS 15-35 SUC	38	Union	5 7/8	Astro 20BU, Astro 25BU, Astro 220SSU, Astro 225SSU	1 1/4" U	6
UPS 15-35 SUC/TLC	38	Union	5 7/8	Astro 20BU, Astro 25BU, Astro 20BU-LC, Astro 20BU-T	1 1/4" U	6
UPS 15-35 SFC	38	Flange	6 1/2	Astro 25BF	Flange	6 3/8
UPS 15-55 SFC	47	Flange	6 1/2	Astro 30B, Astro 30B-3, Astro 230SS	Flange	6 3/8
UP 26-96 BF	54	Flange	6 1/2	E7B	Flange	6 3/8
UPS 26-99 BFC	57	Flange	6 1/2	E7B, Astro 50B, Astro 50B-3	Flange	6 3/8
				H-41B		8 1/2
UPS 26-150 SF	60	Flange	6 1/2	E8B	Flange	6 3/8
				E10B, E11B, E13B, E15B		8 1/2
UPS 43-44 BFC	62	Flange	8 1/2	E16B, H-32B	Flange	8 1/2
				S-25B		6 1/2
UPS 43-100 SF	65	Flange	8 1/2	E17B	Flange	8 1/2
				H-51B, H-52B		11 1/2
UPS 50-60 SF	68	Flange	8 1/2	E19B, E28B, E29B, E30B, S-35B	Flange	8 1/2
Closed systems: Cast iron body pumps						
UP 15-10 F	32	Flange	6 1/2	Astro 20F	Flange	6 3/8
UPS 15-58 FRC	50	Flange	6 1/2	Astro 230CI-R	Flange	6 3/8
UPS 15-58 FC	50	Flange	6 1/2	Astro 30, Astro 30-3, Astro 230CI	Flange	6 3/8
UPS 26-99 FC	57	Flange	6 1/2	E7, Astro 50, Astro 50-3	Flange	6 3/8
				H-41		8 1/2
UPS 26-150 F	60	Flange	6 1/2	E8	Flange	6 3/8
				E10, E11, E13, E15		8 1/2
UPS 43-44 FC	62	Flange	8 1/2	E16, H-32	Flange	8 1/2
				S-25		6 1/2
UPS 43-100 F	65	Flange	8 1/2	E17	Flange	8 1/2
				H-51, H-52		11 1/2
UPS 50-60 F	68	Flange	8 1/2	E19, E28, E29, E30, S-35	Flange	8 1/2

* Armstrong pump information taken from literature on Armstrong website August 2002. Grundfos provides no guarantee as to the accuracy of competitor information listed herein.

Discontinued products

The table shows which new products replace discontinued products.

Stainless steel, flanged 115 V			
Old model	Product number	New model	Product number
UP 15-18SF	59896125	UP 15-29SF	59896771
UP 15-42SF	59896171	UPS 15-35SFC	59896772
UPS 15-42SF	59896247	UPS 15-55SFC	59896773
UP 25-64SF	52722322		
Stainless steel, union 115 V			
UP 15-18SU	59896127	UP 15-29SU	59896775
UP 15-18SU/LC	59896231	UP 15-29SU/LC	59896776
UP 15-18SU/TLC	59896232	UP 15-29SU/TLC	59896777
		UPS 15-35SUC	59896778
UP 15-42SU	59896174	UPS 15-35SUC/LC	59896779
		UPS 15-35SUC/TLC	59896780
		UPS 15-55SUC	59896781
UPS 15-42SU, UP 25-64 SU	59896130, 52722322	UPS 15-55SUC/LC	59896782
		UPS 15-55SUC/TLC	59896783
Stainless steel, union 230 V			
UP 15-18SU	59896130	UP 15-29SU	59896784
UP 15-42SU	59896172	UP 15-35SUC	59896785
UP 25-64SU	52722323	UP 15-55SUC	59896786

3-speed

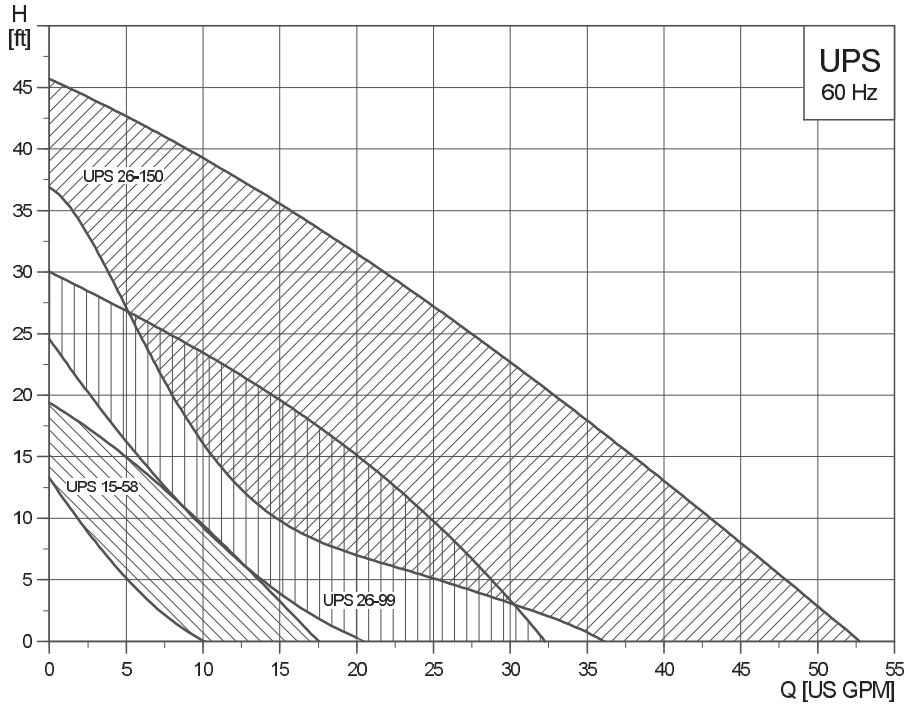

TM04 5461

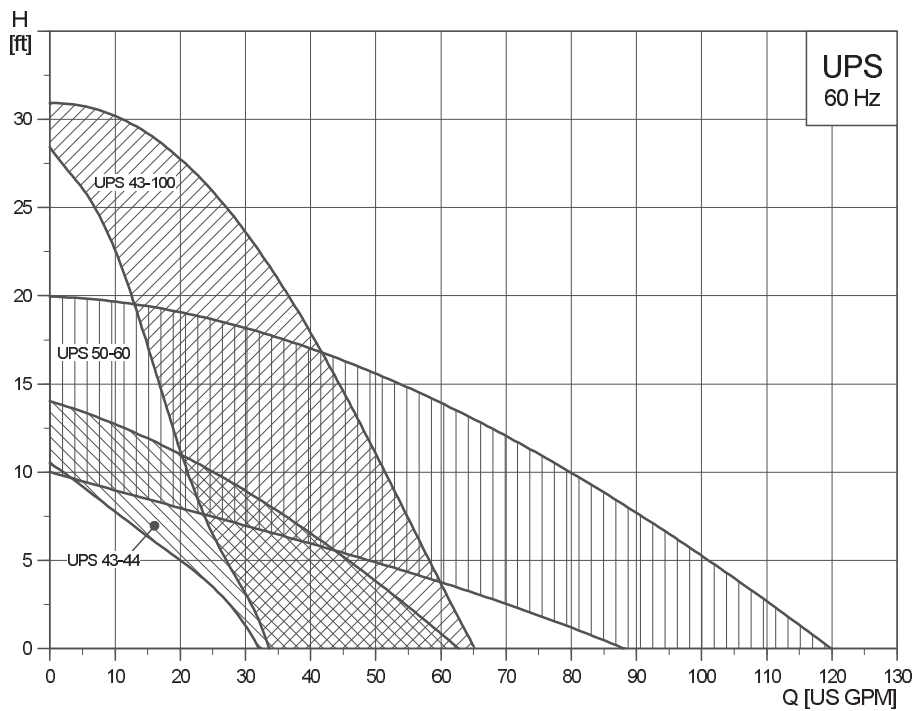

TM04 5460

3-speed stainless steel

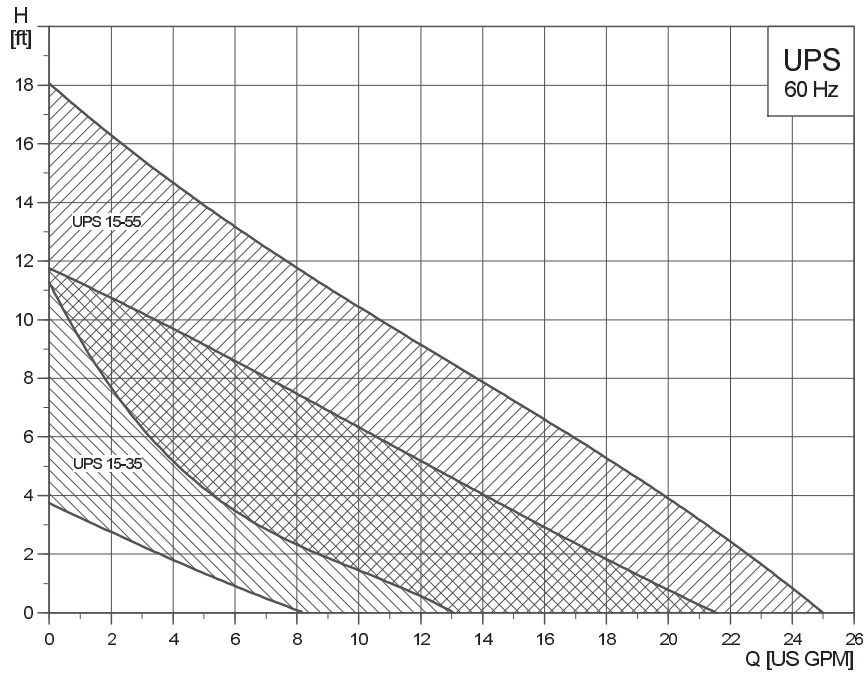

TM04 5462

Comfort Pump

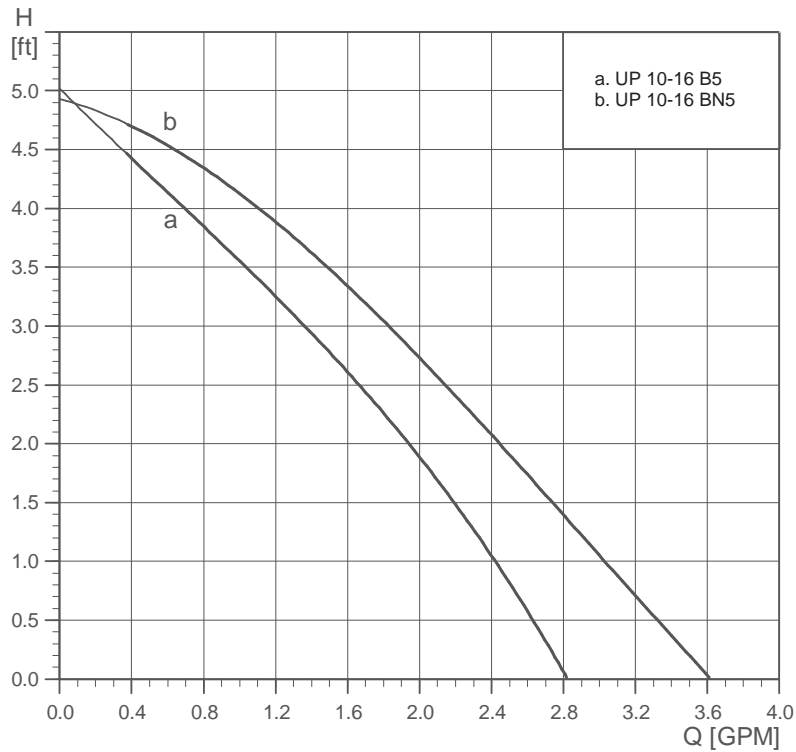

TM03 8851 2807

Note: a. UP 10-16 B5 b. UP 10-16 BN5

Closed systems

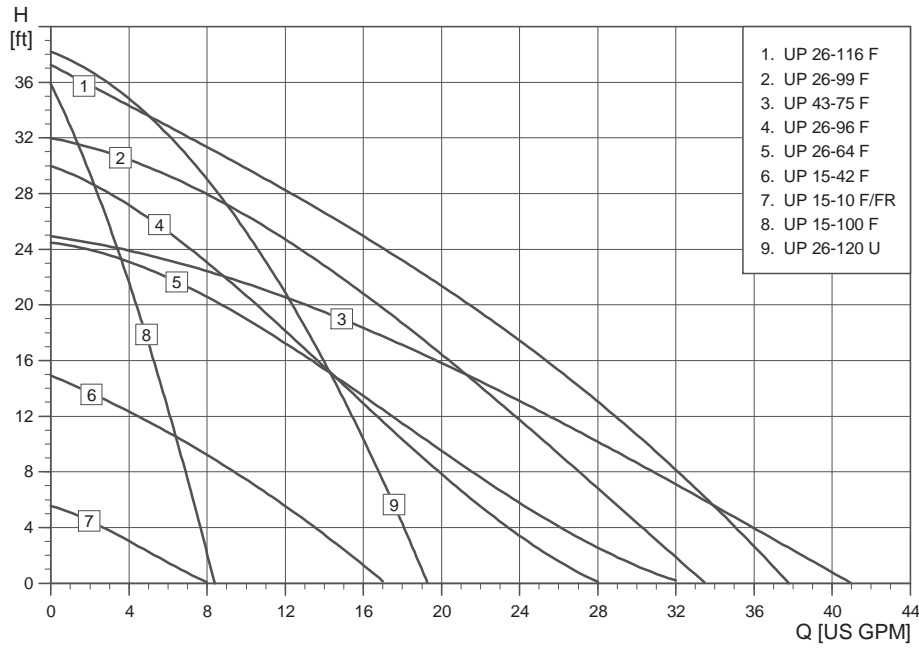

TM03 9128 3407

Open systems

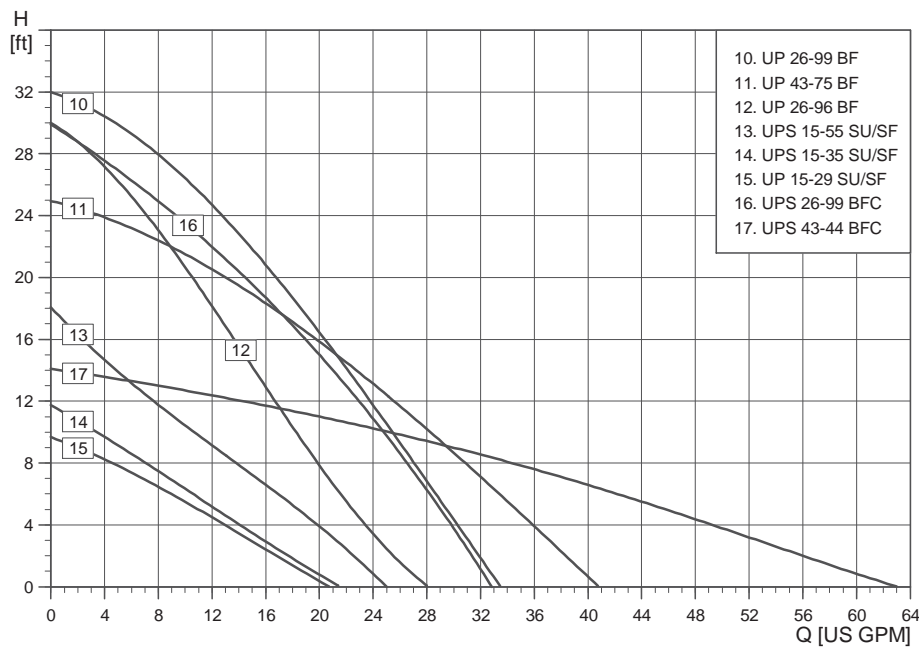

TM03 9129 3507

Open systems 1/2"

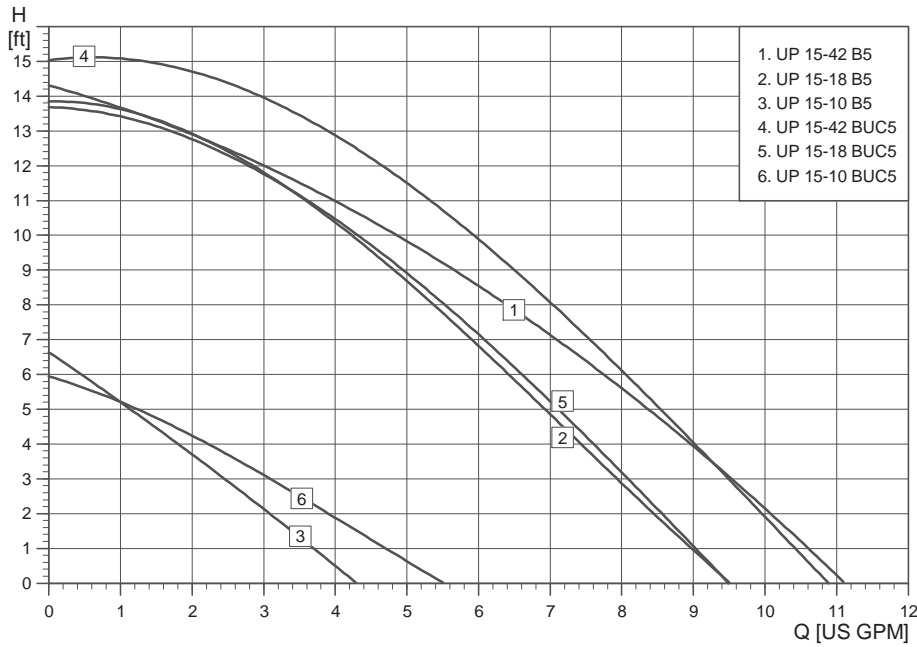

TM03 9131 3507

Open systems 3/4"

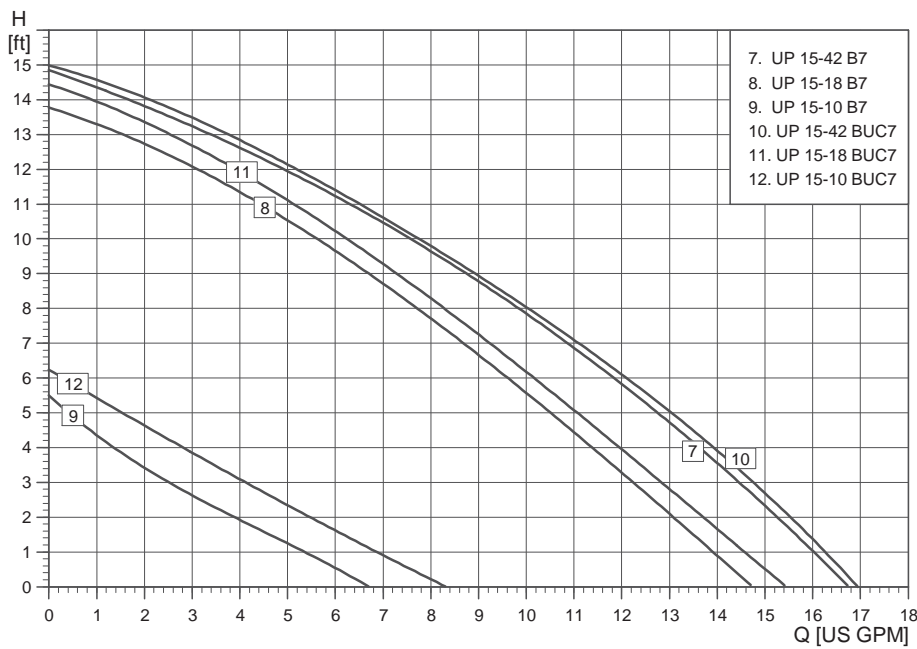

TM03 9132 3507

Cast iron

Closed systems	Product number		Flow [gpm]	Head [ft]	Flanged	Union	NPT	Sweat	Check valve	Page
	115 V	230 V								
UP 15-10 F	59896248	-	0-8	0-5	●					32
UP 15-10 FR	59896249	-	0-8	0-5	●					32
UP 15-42 FC/MR*	59896804	-	0-16	0-14	●				●	44
UP 15-42 F	59896155	59896173	0-17	0-15	●					42
UP 15-42 FR	59896167	59896274	0-17	0-15	●					42
UP 15-42 F/VS*	59896807	-	0-16	0-15	●					45
UPS 15-42 F	-	59896180	0-17	0-16	●					43
UPS 15-58 FC	59896341	-	0-17	0-19	●				●	50
UPS 15-58 FRC	59896343	-	0-17	0-19	●				●	50
UP 15-100 F	59896300	-	0-8.5	0-33	●					51
UP 26-64 F	52722330	52722327	0-32	0-24	●					52
UP 26-64 F/VS*	52722553	-	0-34	0-24	●					53
UP 26-96 F	52722341	52722338	0-27	0-30	●					54
UP 26-96 F/VS*	52722552	-	0-32	0-30	●					55
UP 26-99 F	52722355	52722351	0-34	0-32	●					56
UPS 26-99 FC	52722512	52722513			●				●	57
UP 26-116 F	-	52722377	0-38	0-37	●					58
UP 26-120 U	52722435	52722436	0-19	0-38		●				59
UPS 26-150 F	95906630	95906631	0-51	0-45	●					60
UP 43-44 F	52722437	52722438	0-64	0-13	●					61
UPS 43-44 FC	52722514	52722515			●				●	62
UP 43-70 F	96439644	-	15-85	1-24	●					63
UP 43-75 F	52722373	52722372	0-40	0-26	●					64
UPS 43-100 F	95906636	95906637	0-65	0-31	●					65
UP 43-110 F	96439643	-	0-90	1-37	●					66
UPS 50-44 F	52722557	52722558	0-65	0-14	●					67
UPS 50-60 F	97523134	97523135	0-125	0-21	●					68
UP 50-75 F	52722352	52722353	0-40	0-25	●					69

* Note: VS - variable speed, MR - MixiMizer, SU7P

Bronze

Open systems	Product number		Flow [gpm]	Head [ft]	Flanged	Union	NPT	Sweat	Check valve	Timer	Line cord	Aqua Stat	Page
	115 V	230 V											
UP 10-16 B5/LC	96433894	-	0-3	0-5				●					29
UP 10-16 B5/TLC	96433895	-	0-3	0-5				●		●	●		29
UP 10-16 B5/ATLC	96433896	-	0-3	0-5				●		●	●	●	29
UP 10-16 BN5/LC	96433897	-	0-3	0-5			●				●		29
UP 10-16 BN5/TLC	96433898	-	0-3	0-5			●			●	●		29
UP 10-16 BN5/ATLC	96433899	-	0-3	0-5			●			●	●	●	29
UP 10-16 BU/ATLC	96433902	-	0-3	0-5		●			●	●	●	●	29
UP 15-10 B5	59896213	-	0-9	0-6				●					30
UP 15-10 B5/LC	59896214	-	0-9	0-6				●			●		30
UP 15-10 B5/TLC	59896215	-	0-9	0-6				●		●	●		30
UP 15-10 B7	59896226	-	0-9	0-6				●					30
UP 15-10 B7/LC	59896209	-	0-9	0-6				●			●		30
UP 15-10 B7/TLC	59896210	-	0-9	0-6				●		●	●		30
UP 15-10 BUC5	59896225	-	0-9	0-6		●			●				31
UP 15-10 BUC5/LC	59896237	-	0-9	0-6		●			●		●		31
UP 15-10 BUC5/TLC	59896238	-	0-9	0-6		●			●	●	●		31
UP 15-10 BUC7	59896241	-	0-9	0-6		●			●				31
UP 15-10 BUC7/LC	59896239	-	0-9	0-6		●			●		●		31
UP 15-10 BUC7/TLC	59896240	-	0-9	0-6		●			●	●	●		31
UP 15-18 B5	59896114	59896118	0-15	0-14				●					34
UP 15-18 B5/LC	59896211	-	0-15	0-14				●			●		34
UP 15-18 B5/TLC	59896212	-	0-15	0-14				●		●	●		34
UP 15-18 B7	59896121	59896119	0-15	0-14				●					34
UP 15-18 B7/LC	59896229	-	0-15	0-14				●			●		34
UP 15-18 B7/TLC	59896230	-	0-15	0-14				●		●	●		34
UP 15-18 BUC5	59896123	-	0-12	0-16		●			●				35
UP 15-18 BUC7	59896124	-	0-12	0-16		●			●				35
UP 15-42 B5	59896145	59896142	0-17	0-15				●					39
UP 15-42 B5/LC	59896233	-	0-17	0-15				●			●		39
UP 15-42 B5/TLC	59896234	-	0-17	0-15				●		●	●		39
UP 15-42 B7	59896146	59896149	0-17	0-15				●					39
UP 15-42 B7/LC	59896235	-	0-17	0-15				●			●		39
UP 15-42 B7/TLC	59896236	-	0-17	0-15				●		●	●		39
UP 15-42 BUC5	59896150	-	0-16	0-15		●			●				40
UP 15-42 BUC7	59896151	-	0-16	0-15		●			●				40
UP 15-42 BUC5/MR*	59896805	-	0-8	0-14		●			●				41
UP 15-42 BUC7/MR*	59896806	-	0-14	0-15		●			●				41
UP 26-96 BF	52722336	52722334	0-27	0-30	●								54
UP 26-99 BF	52722347	52722346	0-34	0-32	●								56
UPS 26-99 BFC	52722518	52722519	0-33	0-29	●				●				57
UP 26-116 BF	-	52722393	0-38	0-37	●								58
UP 43-44 BF	52722439	52722440	0-64	0-13	●								61
UPS 43-44 BFC	52722520	52722521	0-63	0-13	●				●				62
UP 43-75 BF	52722370	52722369	0-45	0-26	●								64

* Note: MR - MixiMizer

Stainless steel

Open systems	Product number		Flow [gpm]	Head [ft]	Flanged	Union	NPT	Sweat	Check valve	Timer	Line cord	Page
	115 V	230 V										
UP 15-10 SU7P/TLC*	595916	-	0-3	0-3		●	●			●	●	33
UP 15-29 SF	59896771	-	0-22	0-10	●							36
UP 15-29 SU	59896775	59896784	0-22	0-10		●						36
UP 15-29 SU/LC	59896776	-	0-22	0-10		●					●	36
UP 15-29 SUC/TLC	59896777	-	0-22	0-10		●			●	●	●	36
UP 15-35 SUC	-	59896785	0-22	0-12		●			●			37
UPS 15-35 SFC	59896772	-	0-22	0-12	●				●			38
UPS 15-35 SUC	59896778	-	0-22	0-12		●			●			38
UP 15-35 SUC/TLC	59896780	-	0-22	0-12		●			●	●	●	38
UP 15-55 SUC	-	59896786	0-25	0-18		●			●			46
UPS 15-55 SFC	59896773	-	0-25	0-18	●				●			47
UPS 15-55 SUC	59896781	-	0-25	0-18		●			●			47
UPS 15-55 SUC/TLC	59896783	-	0-25	0-18		●			●	●	●	47
UPS 26-150 SF	95906632	95906633	0-51	0-47	●							60
UPS 43-100 SF	95906638	95906639	0-68	0-33	●							65
UPS 50-60 SF	97523136	97523137	0-125	0-21	●							68

* Note: Comfort system with 3/4" MXF NPT

Type key

Example	UP	S	15	-58	()	F	C	/
Circulator pump								
S: 3 speed								
10: Comfort series								
15: Small stator UP								
25, 26, 43, 50: Large stator UP								
Maximum head [dm]								
Pump housing								
= Cast iron (no letter = cast iron)								
S = Stainless steel								
B = Bronze								
Pipe connection								
F = Flange								
FR = Flange rotated 90°								
U = Union connection								
5 = 1/2" internal sweat								
7 = 3/4" internal sweat								
N = NPT female thread fitting								
7P = 3/4" male x female connection								
Special features								
A = Thermostat (Aquastat)								
C = Check valve (removable)								
/T = Timer								
/LC = Line cord								
/TLC = Timer Line cord								
/VS = Variable speed control								
/MR = Mixing reset control								

Nameplate

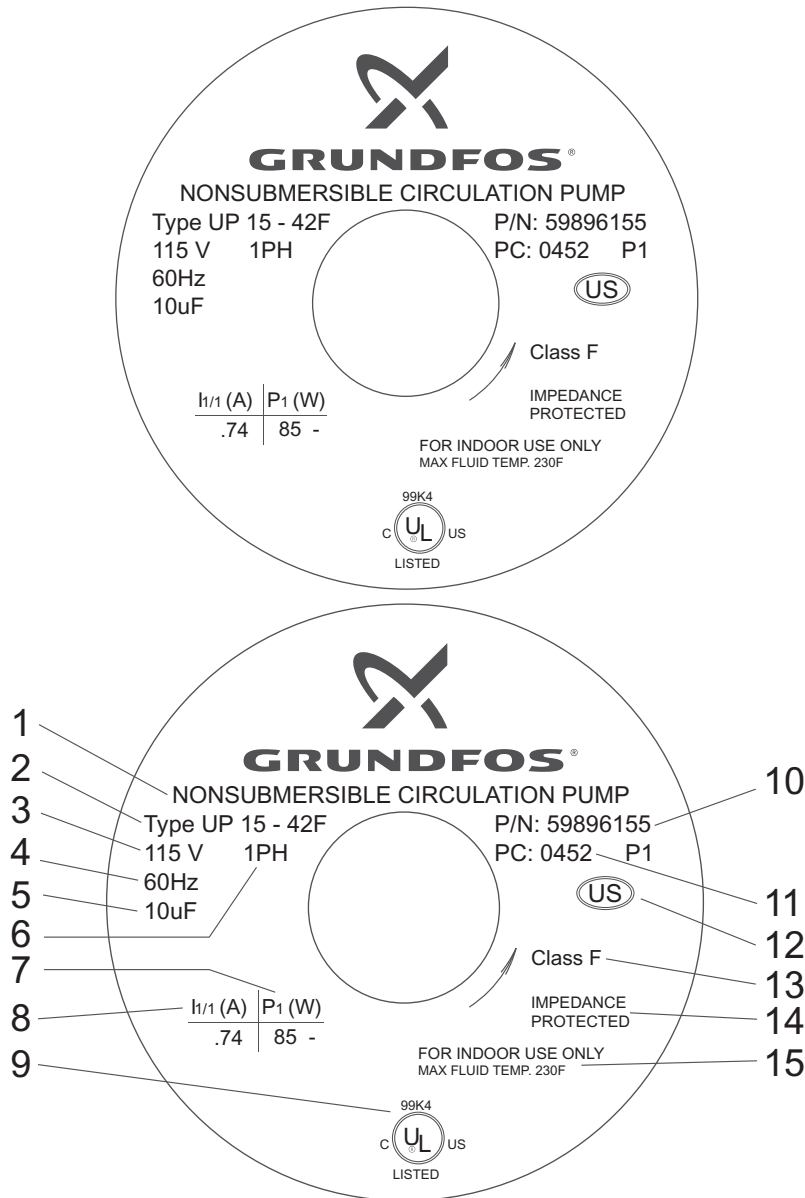

TM03 8595 2007

Fig. 1 Nameplate

Pos.	Description
1	Non-submersible pump
2	Pump type UP 15-42F
3	Voltage 115 V
4	Frequency 60 Hz
5	Capacitor 10 μ F
6	1-phase
7	Power 85 W
8	Current 0.74 A

Pos.	Description
9	Approval
10	Product number 59896155
11	04 = year 2004 / 52 = week
12	Manufactured country
13	Insulation, Class F
14	Impedance-protected
15	Maximum liquid temperature 230° F

The Grundfos circulator pumps, Series UP(S), are specifically designed for heating systems. The pumps are also suitable for circulation of hot domestic water and for circulation of liquid in cooling and air-conditioning systems.

Heating systems

Common uses:

- Boiler/hydronic heating
- Ground-source heat pumps
- Radiant floor heating
- Hydronic and fan-coil heating
- Solar heating
- Heat recovery/heat pumps.

Pump types with cast iron housing are generally used for these applications, considered to be closed systems pumping water or water/glycol mixtures. However, when water conditions exist that are not compatible with cast iron, we recommend the use of bronze or stainless steel.

Optional variable-speed and mixing-reset controls are available to customize heat output vs heat demand for increased comfort.

Domestic hot-water systems

Common uses:

- Solar water heating
- Hot-water recirculation
- Domestic hot-water heating.

Pump types with bronze, brass or stainless steel housing are used for these applications, considered to be open systems pumping potable water.

Optional timer and thermostat controls are available to limit pump operation to periods when hot water is required and to save energy.

Cooling systems

Common uses:

- Chilled-water pumping.

Pump types UP(S) 25, 26, 43, 50 and pump housings compatible with the pumped liquids are recommended for chilled water due to their motor construction, which is suitable for 32 °F (0 °C) water.

Construction

The UP(S) pumps are of the canned rotor type, i.e. pump and motor form an integral unit without shaft seal and with only two gaskets for sealing. The bearings are lubricated by the pumped liquid.

The pumps are characterized by:

- Ceramic shaft and radial bearings
- Carbon thrust bearing
- Stainless steel rotor can and bearing plate
- Impeller in corrosion-resistant material
- Pump housing in cast iron, bronze or stainless steel.

Materials of construction

Description (UP closed systems)	Material
Inlet cone, bearing plate, bearing retainers, rotor can, rotor cladding, shaft retainer	Stainless steel
Stator housing	Aluminium
Shaft, upper and lower radial bearings	Aluminium oxide ceramic
Thrust bearing	Carbon bearing and EPDM retainer
Check valve	ACETAL with 302 stainless steel spring and nitrile rubber seats
Pump housing (volute)	Cast iron
O-ring and gaskets	EPDM (ethylene propylene rubber)
Impeller	PES composite (30 % glass-filled)
Terminal box	Noryl® with EPDM gasket

Description (UP open systems)	Material
Inlet cone, bearing plate, bearing retainers, rotor can, rotor cladding, shaft retainer	Stainless steel
Volute retainer (SU & SF models) and stator housing	Aluminium
Shaft, upper and lower radial bearings	Aluminium oxide ceramic
Thrust bearing	Carbon bearing and EPDM retainer
Pump housing (volute)	Silicon bronze C875 or stainless steel 300 series.
O-ring and gaskets	EPDM (ethylene propylene rubber)
Impeller	PES composite (30 % glass-filled)
Terminal box	Noryl® with EPDM gasket

Description (BUC5 and BUC7)	Material
Inlet cone, bearing plate, bearing retainers, rotor can, rotor cladding, shaft retainer, check valve spring	Stainless steel
Stator housing	Aluminium
Shaft, upper and lower radial bearings	Aluminium oxide ceramic
Thrust bearing	Carbon bearing and EPDM retainer
Pump housing (volute)	Silicon bronze C875 lead free
Tail piece and union nut	Brass (UNS C36000)
O-ring and gaskets	EPDM (ethylene propylene rubber)
Impeller	PES composite (30 % glass-filled)
Terminal box	Noryl® with EPDM gasket
Check valve housing, valve and torpedo	ACETAL with 302 stainless steel, spring and nitrile rubber seat
Union gasket	EPDM

Installation

The pump must always be installed with horizontal motor shaft.

Proper installation of the pump will have the terminal box located to one side of the pump or the other, with the conduit entry down.

UP(S) can be installed in both vertical and horizontal lines.

UP(S) pumps are intended for indoor use only.



TM04 5058 2509

Fig. 1

Motor

The motor is a 2-pole asynchronous squirrel-cage PSC (permanent split capacitor) motor with UL, CUL, ETL and CSA approvals.

UP(S) pumps are available in single-phase 115 V and 230 V versions with one or three speeds.

The terminal box is easily accessible and has functional cable connecting leads or terminals.

Insulation class(es): F, H.

The motor incorporates thermal overload or impedance protection. Therefore, no external motor protection is required.

UP models are single speed.

UPS model pumps are multi-speed, and the speed can be changed by a speed selector switch located on the front of the terminal box.

If the speed of UPS 15-35 or 15-55 TLC models has to be changed, the timer control has to be removed before the speed can be changed.

UP models with VS or MR suffixes are variable speed with integrated control.

Depending on pump model, motor horsepowers range from 1/25 to 1/6 and power consumption from 5 to 385 W.

Pumped liquids

Depending on type, Grundfos circulator pumps are designed for the following liquids:

- Potable water
- Non-potable water
- Water/glycol mixtures
- Chilled water
- Domestic-hot water
- Softened water.

If the circulator pump is used for a glycol mixture with a higher viscosity than that of water, the hydraulic performance of the pump will be reduced.

Example: 50 % glycol at 68 °F (20 °C) means a viscosity of approx. 10 cSt and a reduction of pump performance by approx. 15 %.

When selecting a pump, the viscosity of the pumped liquid must be taken into consideration.

Ambient and liquid temperatures

The maximum allowable water temperature is determined by the ambient or surrounding air temperature as shown in the table below.

Maximum water temperature					
Ambient (°F)	104 (40)	120 (49)	140 (60)	160 (71)	175 (79)
Water, all cast iron (°F)	230 (110)	220 (104)	210 (99)	190 (88)	175 (79)
Water, all bronze and stainl. steel	220 (104)	210 (99)	190 (88)	175 (79)	
*exceptions below					
UP/UPS 15 FC and UP 43 FC (°F)	200 (93)	190 (88)	180 (82)	170 (77)	
UP 15BUC5 and UP 15BUC7 (°F)	200 (93)	190 (88)	180 (82)	170 (77)	
UPS 15-35 (°F)	165 (74)	140 (60)	-	-	-
UP 15-100F (°F)	205 (96)	195 (91)	185 (85)	175 (79)	-
UP 26-120U (°F)	205 (96)	195 (91)	185 (85)	175 (79)	-
UP 26-116 (°F)	150 (66)	140 (60)	-	-	-

Note: This table refers to all standard product without timer/control options or other special features.

- If the UP pump is equipped with a timer, the maximum liquid temperature is 150 °F (66 °C).
- **Temperature requirements for pumps with timer/control or other special features may be found on their technical data page.**

The ambient temperature for standard pumps with a permissible liquid temperature from 36 °F (2 °C) to 230 °F (110 °C) should always be lower than the liquid temperature, as otherwise condensation may form in the stator housing.

Maximum system pressure

145 psi (10 bar).

Minimum inlet pressure

The amount of pressure required at the inlet of a pump is a function of the temperature of the water as shown in the table below.

UP(S) model	Liquid temperature							
	140 °F (60 °C)		165 °F (74 °C)		190 °F (88 °C)		230 °F (110 °C)	
	[psi]	[bar]	[psi]	[bar]	[psi]	[bar]	[psi]	[bar]
UP(S) 15								
UP(S) 26			1.9	0.1	4.0	0.3	15.6	1.1
UP(S) 43	1.3	0.1						
UPS 26-150			1.3	0.09	2.6	0.18	7.8	0.54
UPS 43-100			2.1	0.15	5.6	0.40	11.3	0.80
UPS 50-60	0.5	0.04	1.0	0.07	1.3	0.09	7.0	0.49

Performance

Flow range 0 - 120 gpm, head range 0 - 46 feet

In a pressure system, the required inlet pressure is the allowable system pressure.

In a system open to the atmosphere, the required inlet pressure is the minimum distance the pump must be located below the lowest possible water level of the water source (tank, pool, etc.).

ALPHA

The Grundfos Alpha is the next generation of energy efficient wet-rotor circulators. By incorporating a permanent magnet motor design, power consumption is now reduced by a minimum of 50 %.

By using the AutoADAPT™ feature, Grundfos ALPHA will automatically analyze the system demands and adjust head and or flow requirements to meet changing heating demands.

Standard features

- Permanent magnet motor design
- Easy push button hydraulic selection
- Seven hydraulic selection options
 - Three fixed speeds
 - Three constant pressures
 - AutoADAPT™
- Easy to read LED display
 - Flow indicator (gpm)
 - Power consumption (watts)
 - Hydraulic selection
- Nut capture flange
- Metallurgical options
 - Cast iron (F or FR)
 - Stainless steel (F)
- Line cord or conduit connection options

Additional technical data

Supply voltage:	1x115V +/-10 %, 60Hz
Motor protection:	Pump requires none.
Enclosure class:	Indoor use only, IP42, CSA Enclosure Type 2
Insulation class:	F
Relative air humidity:	Maximum 95 %
Max. discharge press.:	150 psi (10.34 bar)
Sound pressure level:	43 dB (A)
Ambient temp.:	+32 °F (0 °C) to +104 °F (+40 °C)
Liquid temp.:	+36 °F (+2 °C) to +230 °F (+110 °C)
Max. glycol concentrations:	50 % glycol @ 36 °F (2 °C) (Hydraulic performance change can be expected.)
Watt readings:	Accuracy +/-1 Watt
Flow indicator:	Provides a relative indication of flow — should not be used in lieu of a flow meter.
Check valve:	Use of check valve may reduce pump hydraulic performance (up to -10%). Use check valve in parallel pumping applications.

Control display



Position	Description
1	Watt or flow indicator
2	Three fixed speeds
3	Three constant pressure settings
4	AUTOADAPT
5	Push-button for selection of pump settings

Max. operating pressures

Liquid temp.	Min. inlet press.
167 °F (75 °C)	0.75 psi (0.05 bar)
194 °F (90 °C)	4.06 psi (0.28 bar)
230 °F (110 °C)	15.7 psi (1.08 bar)

Max. operating temperatures

Ambient temp.	Liquid temp.	
[°F (°C)]	Min. [°F (°C)]	Max. [°F (°C)]
+32 °F (0 °C)	+36 °F (+2 °C)	+230 °F (+110 °C)
+50 °F (+10 °C)	+50 °F (+10 °C)	+230 °F (+110 °C)
+68 °F (+20 °C)	+68 °F (+20 °C)	+230 °F (+110 °C)
+86 °F (+30 °C)	+86 °F (+30 °C)	+230 °F (+110 °C)
+95 °F (+35 °C)	+95 °F (+35 °C)	+194 °F (+90 °C)
+104 °F (+40 °C)	+104 °F (+40 °C)	+158 °F (+70 °C)

MixiMizer - mixing reset pump

The Grundfos MixiMizer, a fully integrated injection pump and indoor/outdoor controller, is the only pump and controller system of its kind.

Equipped with a weather responsive control, also known as indoor/outdoor control or reset control, the MixiMizer automatically calculates and controls mixed water temperatures according to outdoor temperatures in primary/secondary piping systems. The control also provides pump exercising for 10 seconds every 3 days and a 20 second postpurge when the heat demand is removed.

For maximum design flexibility, the MixiMizer can be integrated into a thermostat or zoning control system through the user-selectable "external call for heat/demand input".

A fully serviceable check valve integrated into the pump housing eliminates ghost flows in primary/secondary injection systems and zone applications.

LEDs located on the terminal box are designed to indicate performance and diagnose faults without tools.

Other standard user-selectable features include boiler protection, system/slab "overtemperature" control and a 5 °F parallel shift of the heating curve.



TM04 9735 5110

Fig. 2 MixiMizer

MixiMizer models includes the following:

- Two water-temperature sensors (system supply and return) prewired, 8 ft (2.4 m) each
- One prewired 6-foot line cord
- One outdoor air-temperature sensor
- Two flange gaskets
- Optional zone control input
- Optional boiler on/off output.

Standard features

- Variable-speed output modulation
- System supply-temperature sensor 140 °F (60 °C) max.
- Boiler return-temperature sensor 135 °F (57 °C) min.
- Heating curve can be adjusted by 5 °F in parallel
- Pump exercising every three days of no operation.

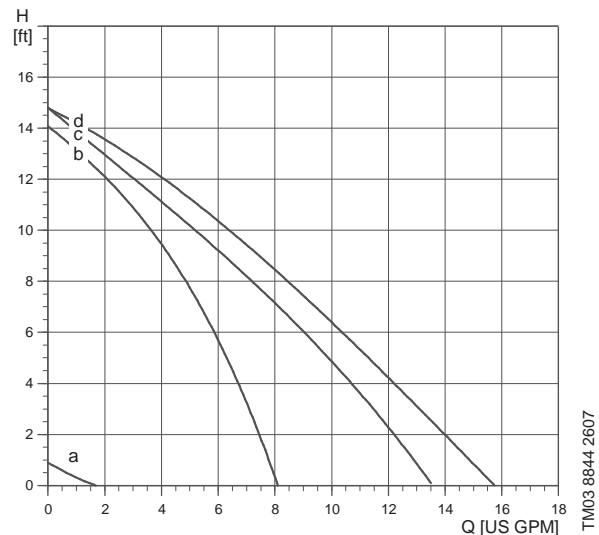

TM03 8644 2607

Fig. 3 Family curves for MixiMizer

Position	Description
a	Min. curve for all models
b	Max. UP 15-42 BUC5
c	Max. UP 15-42 BUC7
d	Max. UP 15-42 FC

Variable-speed pump

The Grundfos variable-speed pump is another product with fully integrated control. The variable-speed controller requires a 0-10/2-10 DC or 0-20/4-20 mA control signal, which is user-selectable.

If desired, the manual-% dial allows the speed of the pump to be manually adjusted and set by the user. The speed of the pump may be manually adjusted anywhere from min. to 100 %, but once set, remains fixed at that speed.

In addition, the pump speed may be set as 0-100 % or 15-100 % by user.

The control also provides pump exercising for 10 seconds every 3 days and a power-up reset, which runs the pump for 3 seconds at full speed, for all modes of operation.

LEDs on the terminal box indicate operation (power is applied) and performance (flashes slower or faster).



TM03 9088 3307

Fig. 4 Variable-speed pump

Variable-speed models include the following

- Pump with integrated variable-speed control
- Line cord, 6-ft (1.8 m) prewired
- Two gaskets.

Variable-speed standard features

- Variable-speed output modulation (external or manual control)
- Offset-dial for fine-tuning of the signal input.

Signal type	Signal range
Voltage	0-10 VDC or 2-10 VDC, 5mA Max
Current	0-20 mA or 4-20 mA, 5 VDC Max

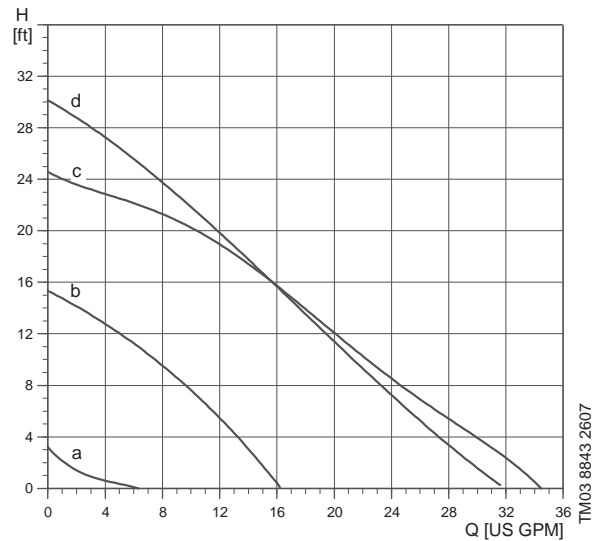

TM03 8843 2607

Fig. 5 Family curves for variable-speed pumps

Position	Description
a	Min. curve for all models
b	Max. UP 15-42 F/VS
c	Max. UP 26-64 F/VS
d	Max. UP 26-96 F/VS

Comfort System

The Comfort System uses a patented Comfort Valve® and pump to provide instant availability of hot water at the point of use.

Operation

The Comfort Valve® is installed at the furthest fixture from the hot-water tank. With a built-in timer, the pump allows hot water to circulate along the loop through the valve using the cold-water side as a return line. As the temperature rises to 100 °F (38 °C), the valve closes directing hot water to the tap, resulting in a constant availability of hot water.

Savings

The Comfort System saves up to 16,000 gallons of water per year and per household (based on average modern household usage) and uses less energy than a 25 W light bulb.

Applications

- Domestic hot-water recirculation systems in single- and two-family houses.

Pumped liquids

- Domestic hot water
- Potable and non-potable water



Fig. 6 Comfort System

Motor

- Insulation class: F.
- Power consumption: 25 W.
- Voltage: 115 V.
- Current 0.23 A.
- Phase: 1.

Description (UP open systems)	Material
Inlet cone, bearing plate, bearing retainers, rotor can, rotor cladding, shaft retainer	Stainless steel
Volute retainer (SU & SF models) and stator housing	Aluminium
Shaft, upper and lower radial bearings	Aluminium oxide ceramic
Thrust bearing	Carbon bearing and EPDM retainer
Pump housing (volute)	Silicon bronze C875 or stainless steel 300 series.
O-ring and gaskets	EPDM (ethylene propylene rubber)
Impeller	PES composite (30 % glass-filled)
Terminal box	Noryl® with EPDM gasket

Ambient and liquid temperatures

Liquid temperature: 36 °F (2 °C) to 150 °F (66 °C).

It is recommended to keep the operating temperature as low as possible (e.g. 140 °F (60 °C)) to avoid calcium precipitation.

The ambient temperature should always be lower than the liquid temperature, as otherwise condensation may form in the stator housing.

Maximum system pressure

145 psi (10 bar).

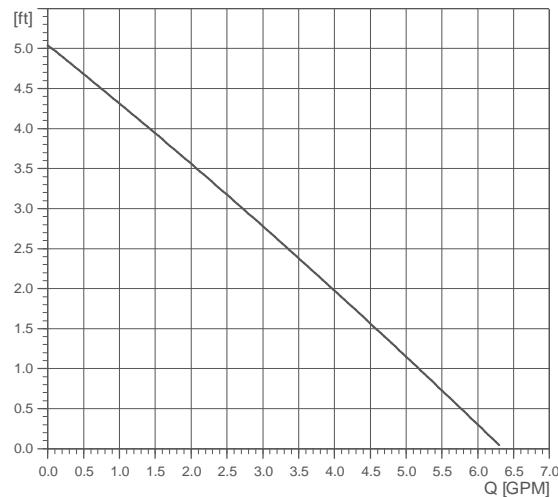

Fig. 7 Performance curve for the Comfort System

UP 10 Comfort pump

The water-conduction part of the pump is hermetically separated from the stator with a stainless steel spherical separator. The motor can be separated from the pump housing, enabling easy maintenance and replacement.

Applications

- Domestic hot-water recirculation systems in single- and two-family houses
- Small heating systems.

Pumped liquids

- Domestic hot water
- Non-potable water
- Softened water.



GrA3803

Fig. 8 Comfort pump



TM04 9805 0111

Fig. 9 Comfort pump

Motor

- Insulation class: F.
- Power consumption: 25 W.
- Voltage: 115 V.
- Phase: 1.

Description	Material
Stator housing	Aluminium
Spherical separator	Stainless steel
Rotor can complete	Stainless steel/tungsten carbide
Rotor, impeller	Stainless steel, EPDM, PPO, PTFE, graphite
Pump housing	Brass MS 58
Isolation valve	PPO
Screw	Stainless steel
Terminal box cover, motor cover	PA66/6
Light	Lexan
Cable, cable relief	PVC
Insulating cover	EPP 55
O-rings	EPDM
Check valve	POM

Ambient and liquid temperatures

Liquid temperature: 36 °F (2 °C) to 203 °F (95 °C).

It is recommended to keep the operating temperature as low as possible (e.g. 140 °F (60 °C)) to avoid calcium precipitation.

The ambient temperature should always be lower than the liquid temperature, as otherwise condensation may form in the stator housing.

Maximum system pressure

145 psi (10 bar).

Inlet pressure

To avoid cavitation noise and damage to the pump bearing at high temperatures, the following minimum pressures are required at the pump suction port.

Liquid temperature	203 °F (95 °C)	185 °F (85 °C)
Inlet pressure	9 ft (2.8 m)	1.6 ft (0.5 m)
	4.0 psi (.3 bar)	0.7 psi (.05 bar)

UP 10 Comfort Pump

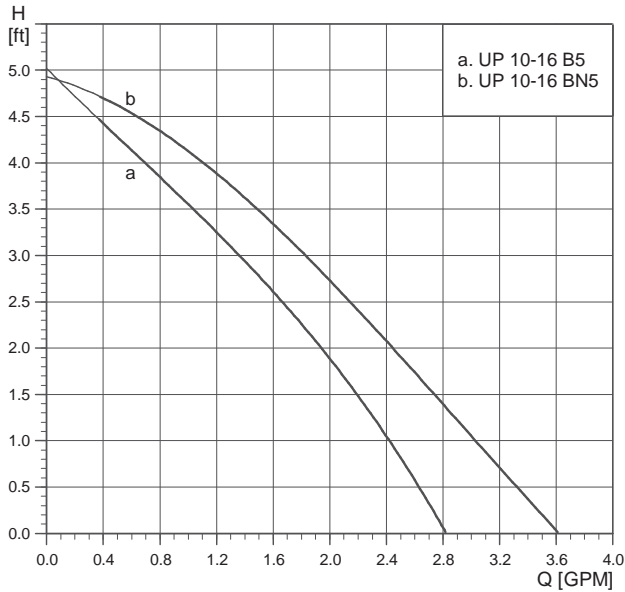

Flow range:	0-3.5 gpm
Head range:	0-5.4 feet
Motors:	Single-phase
Max. liquid temperature:	203 °F (95 °C)
Min. liquid temperature:	36 °F (2 °C)
Max. system pressure:	145 psi (10 bar)

Model	Volts	Amps	Watts	Hp	Capacitor
UP 10-16 B5/BN5	115	0.23	25	-	-

Approvals



TM03 8851 0211

UP 10-16 BU

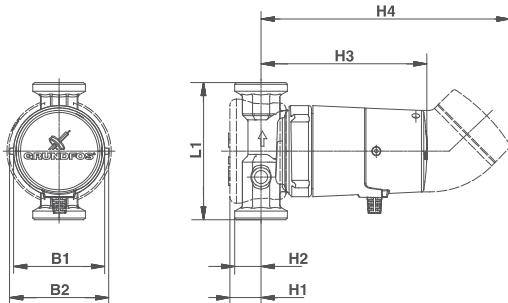

TM03 4353 2006

UP 10-16 B5/BN5

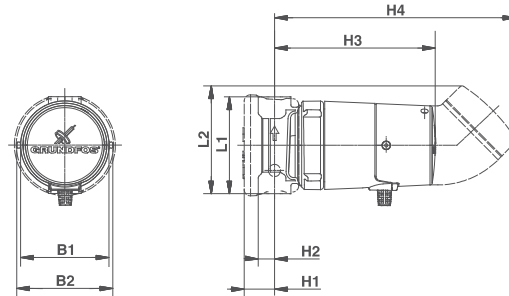

TM03 4354 2006

Model type	Product number	Dimensions [inches]								Connection	Shipping weight lbs
		L1	L2	H1	H2	H3	H4	B1	B2		
UP 10-16 B5/LC	96433894	3 1/8		1	1/2	5 1/4		3	3 1/3	1/2" sweat	2.9
UP 10-16 B5/TLC	96433895	3 1/8	3 1/2	1	1/2		8 1/16	3	3 1/3	1/2" sweat	3.4
UP 10-16 B5/ATLC	96433896	3 1/8	3 1/2	1	1/2		8 1/16	3	3 1/3	1/2" sweat	3.4
UP 10-16 BN5/LC	96433897	3 1/8		1	1/2	5 1/4		3	3 1/3	1/2" F NPT	2.9
UP 10-16 BN5/TLC	96433898	3 1/8	3 1/2	1	1/2		8 1/16	3	3 1/3	1/2" F NPT	3.4
UP 10-16 BN5/ATLC	96433899	3 1/8	3 1/2	1	1/2		8 1/16	3	3 1/3	1/2" F NPT	3.4
UP 10-16 BU/ATLC	96433902	4 1/3		1	7/8		8 1/16	3	3 1/3	GF 125 union - 1 1/4" NPSM	3.8

Note: Dimensions in inches unless otherwise noted.

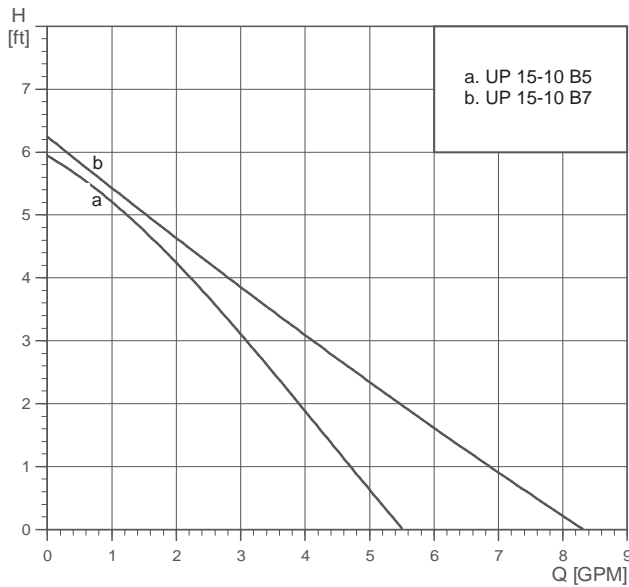

Flow range: 0-8.2 gpm
 Head range: 0-6.2 feet
 Motors: 2-pole, single-phase
 Max. liquid temperature: 220 °F (104 °C)
 Min. liquid temperature: 36 °F (2 °C)
 Max. system pressure: 145 psi (10 bar)

Note: If the UP pump is equipped with a timer, the maximum liquid temperature is 150 °F (66 °C).

Model	Volts	Amps	Watts	Hp	Capacitor
UP 15-10 B5 and B7	115	0.22	25	1/25	2µF/400 V

Approvals



TM03 8424 1507

UP 15-10 B5 and UP 15-10 B5/LC UP 15-10 B7 and UP 15-10 B7/LC

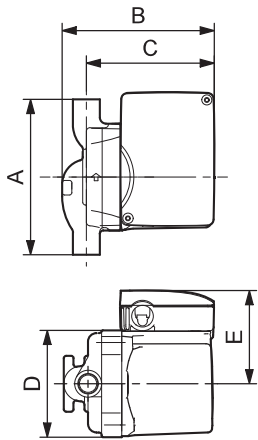

TM03 8545 1907

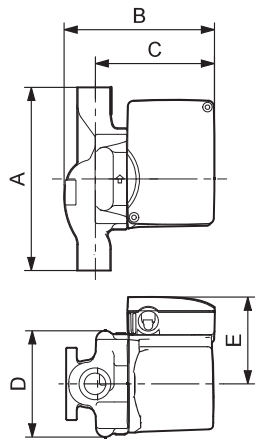

TM03 8547 1907

UP 15-10 B5/TLC

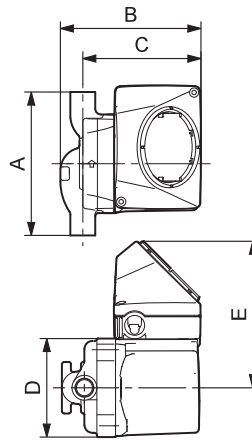

TM03 8546 1907

UP 15-10 B7/TLC

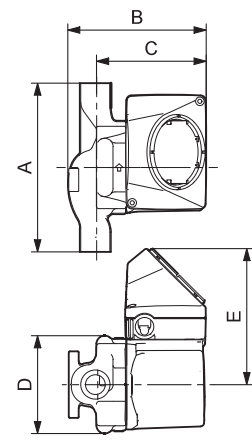

TM03 8548 1907

Model type	Product number	Dimensions [inches]						Connection type and size	Shipping weight [lbs]
		A	B	C	D	E	F		
UP 15-10 B5	59896213	5	4 11/16	4	4	3 1/2	-	1/2" sweat	6
UP 15-10 B5/LC	59896214	5	6 3/16	5 1/2	4	3 1/2	4	1/2" sweat	6.5
UP 15-10 B5/TLC	59896215	5	6 3/16	5 1/2	4	3 1/2	4	1/2" sweat	6.5
UP 15-10 B7	59896226	6 3/8	5 1/8	4	3 13/16	3 1/4	-	3/4" sweat	6.7
UP 15-10 B7/LC	59896209	6 3/8	6 5/8	5 1/2	3 13/16	3 1/4	4	3/4" sweat	7.5
UP 15-10 B7/TLC	59896210	6 3/8	6 5/8	5 1/2	3 13/16	3 1/4	4	3/4" sweat	7.5

Note: LC/TLC models have a 6 ft (1.8 m), 3-prong power cord.
 Dimensions in inches unless otherwise noted.

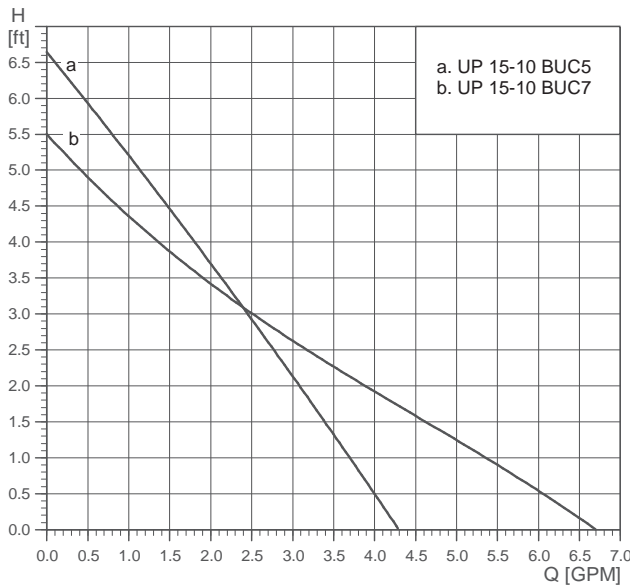

Flow range: 0-6.6 gpm
 Head range: 0-6.6 feet
 Motors: 2-pole, single-phase
 Max. liquid temperature: 230 °F (110 °C)
 Min. liquid temperature: 36 °F (2 °C)
 Max. system pressure: 145 psi (10 bar)

Note: If the UP pump is equipped with a timer, the maximum liquid temperature is 150 °F (66 °C).

Model	Volts	Amps	Watts	Hp	Capacitor
UP 15-10 BUC5/BUC7	115	0.22	25	1/25	2µF/400 V

Approvals



TM03 8425 1507

UP 15-10 BUC5 and
UP 15-10 BUC5/LC

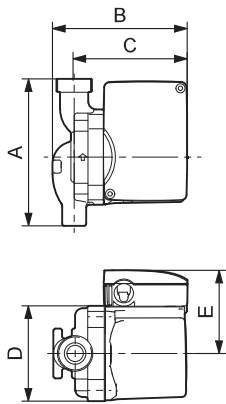

TM03 8549 2407

UP 15-10 BUC7 and
UP 15-10 BUC7/LC

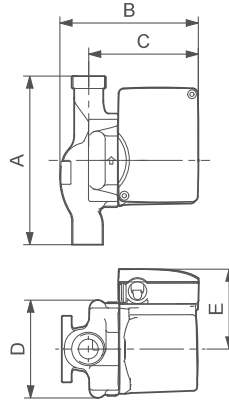

TM03 8553 2407

UP 15-10 BUC5/TLC

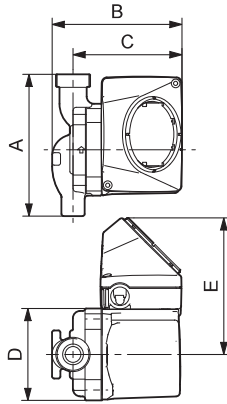

TM03 8550 2407

UP 15-10 BUC7/TLC

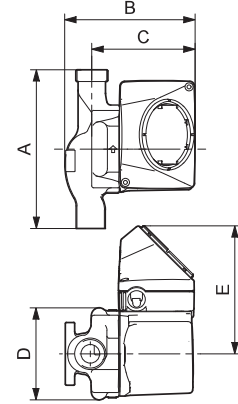

TM03 8554 2407

Model type	Product number	Dimensions [inches]						Connection type and size	Shipping weight [lbs]
		A	B	C	D	E	F		
UP 15-10 BUC5	59896225	6 1/2	5 1/4	4	3 1/5	3 1/4	-	1/2" sweat	7.25 lbs
UP 15-10 BUC5/LC	59896237	6 1/2	6 3/4	5 1/2	3 3/16	3 1/4	4	1/2" sweat	7.7
UP 15-10 BUC5/TLC	59896238	6 1/2	6 3/4	5 1/2	3 3/16	3 1/4	4	1/2" sweat	7.7
UP 15-10 BUC7	59896241	7 3/4	5 1/4	4	3 3/4	3 1/4	-	3/4" sweat	8.0 lbs
UP 15-10 BUC7/LC	59896239	7 3/4	6 3/4	5 1/2	3 3/4	3 1/4	4	3/4" sweat	8.5
UP 15-10 BUC7/TLC	59896240	7 3/4	6 3/4	5 1/2	3 3/4	3 1/4	4	3/4" sweat	8.5

Note: LC/TLC Models have 6 ft(1.8 m), 3-prong power cord.
 Dimensions in inches unless otherwise noted.

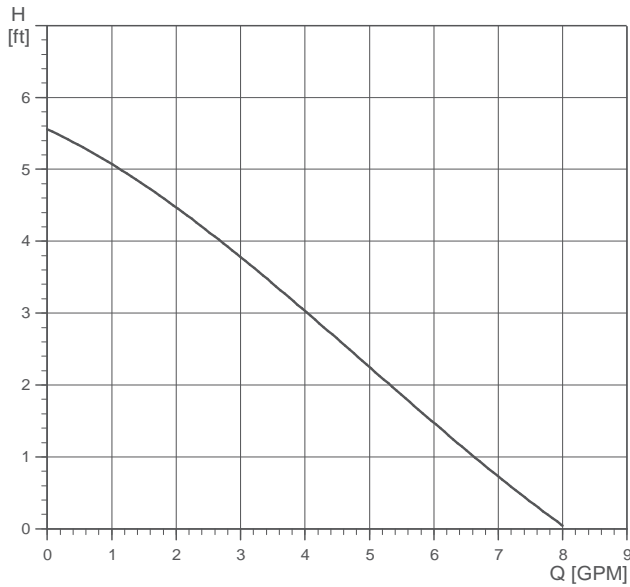

TM03 5532 0907

Flow range: 0-8.0 gpm
 Head range: 0-5.5 feet
 Motors: 2-pole, single-phase
 Max. liquid temperature: 230 °F (110 °C)
 Min. liquid temperature: 36 °F (2 °C)
 Max. system pressure: 145 psi (10 bar)
 Closed system

Model	Volts	Amps	Watts	Hp	Capacitor
UP 15-10 F/FR	115	0.23	25	1/25	2µF/400 V

Approvals



UP 15-10 F

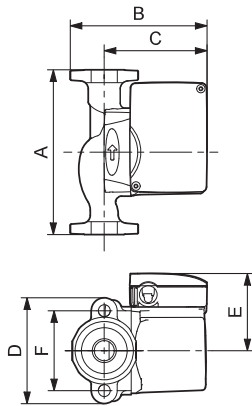

TM03 8526 1907

UP 15-10 FR

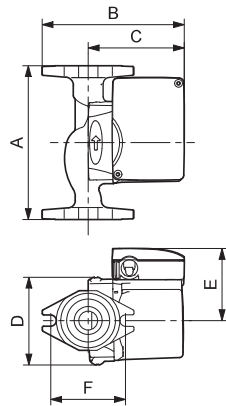

TM03 8527 1907

Model type	Product number	A	B	C	D	E	F	Connection type and size	Shipping weight [lbs]
UP 15-10 F	59896248	6 1/2	5 1/4	4	4 3/16	3 1/4	3 5/32	GF 15/26 flange (2) 1/2" dia. bolt holes	7 1/4
UP 15-10 FR	59896249	6 1/2	5 15/16	4	3 3/4	3 1/4	3 5/32	GF 15/26 flange (2) 1/2" dia. bolt holes	7 1/4

Note: Dimensions in inches unless otherwise noted.

UP Comfort System

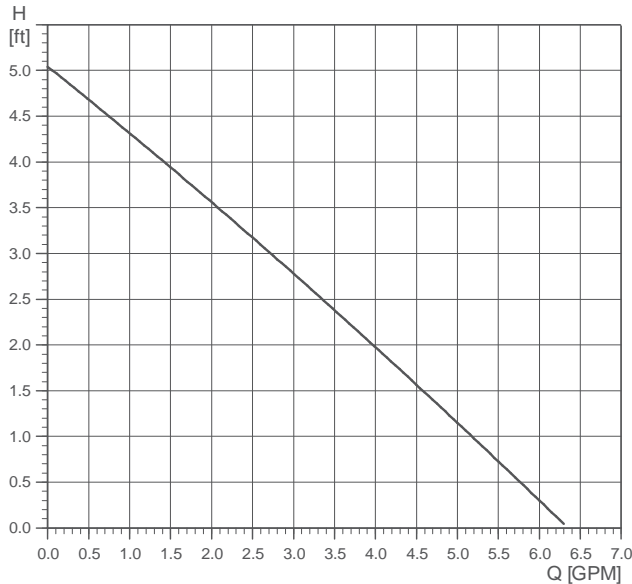

Flow range: 0-6.3 gpm
 Head range: 0-5.1 feet
 Motors: 2-pole, single-phase
 Max. liquid temperature: 150 °F (66 °C)
 Min. liquid temperature: 36 °F (2 °C)
 Max. system pressure: 145 psi (10 bar)
 Open system

Model	Volts	Amps	Watts	Hp	Capacitor
UP 15-10 SU7P/TLC	115	0.23	25	1/25	2μF/400 V

Approvals



TM03 5547 3806

UP 15-10 SU7P/TLC

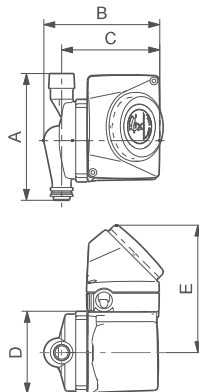

TM03 4362 3507

Comfort Valve®

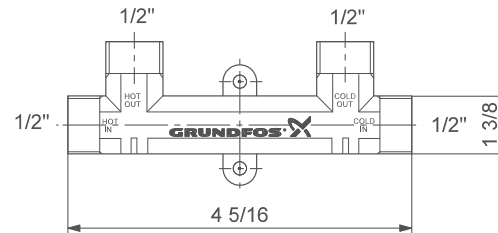

TM03 4363 3507

Model type	Product number	Dimensions [inches]						Connection type and size	Shipping weight [lbs]
		A	B	C	D	E	F		
UP 15-10 SU7P/TLC	595916	5 7/16	6 1/4	5 1/2	3 7/16	3 1/4	4	3/4" M x 3/4" F NPT	5.5
Comfort Valve	595926	-	-	-	-	-	-	1/2" M NPS (1/2" faucet)	2.8
Flex hose kit	599390	-	-	-	-	-	-	(2) 1/2" FNPS X 1/2" FNPS X 12" flex hoses	-

Model type	Product number	Description
Comfort Valves	595926	Box of 15 pieces
Comfort series kit	595916	1 pump and 1 valve, (2) 1/2" FNPS X 1/2" FNPS X 12" flex hoses

Note: All models have a 10 ft (3 m), 3-prong power cord.
 Dimensions in inches unless otherwise noted.

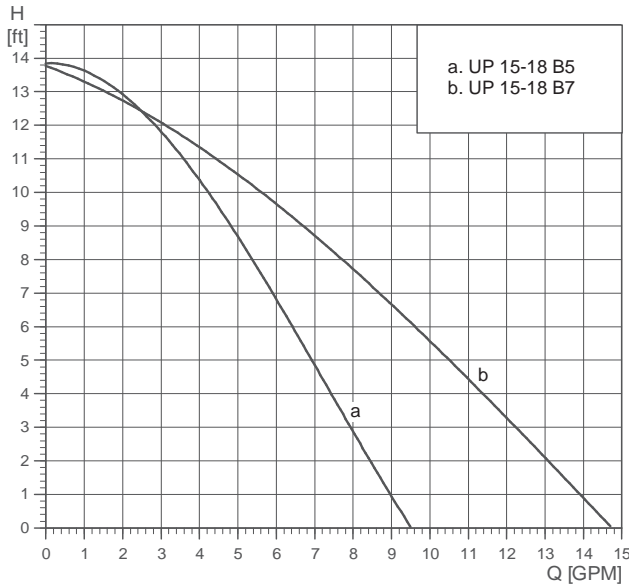

Flow range: 0-14.7 gpm
 Head range: 0-13.9 feet
 Motors: 2-pole, single-phase
 Max. liquid temperature: 230 °F (110 °C)
 Min. liquid temperature: 36 °F (2 °C)
 Max. system pressure: 145 psi (10 bar)

Note: If the UP pump is equipped with a timer, the maximum liquid temperature is 150 °F (66 °C).

Model	Volts	Amps	Watts	Hp	Capacitor
UP 15-18 B5	115	0.74	85	1/25	10µF/180 V
	230	0.4	90	1/25	2µF/400 V
UP 15-18 B7	115	0.74	85	1/25	10µF/180 V
	230	0.4	96	1/25	2µF/400 V

Approvals



TM03 8426 1507

UP 15-18 B5/LC

UP 15-18 B5/TLC

UP 15-18 B7/LC

UP 15-18 B7/TLC

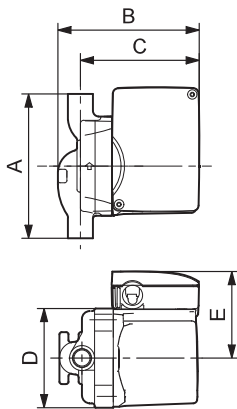

TM03 8545 1907

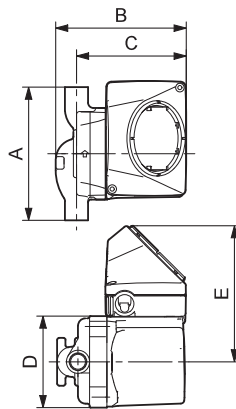

TM03 8546 1907

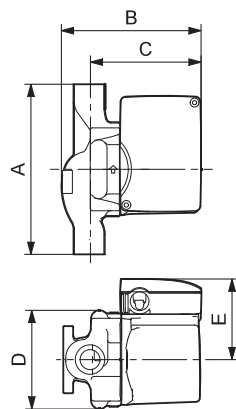

TM03 8547 1907

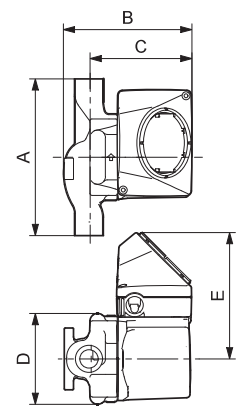

TM03 8548 1907

Model type	Product number		Dimensions [inches]						Connection type and size	Shipping weight [lbs]
	115 V	230 V	A	B	C	D	E	F		
UP 15-18 B5	59896114	59896118	5	4 11/16	4	3 1/2	3 1/4	-	1/2" sweat	6
UP 15-18 B5/LC	59896211	-	5	6 3/16	5 1/2	3 1/2	3 1/4	4	1/2" sweat	6.5
UP 15-18 B5/TLC	59896212	-	5	6 3/16	5 1/2	3 1/2	3 1/4	4	1/2" sweat	6.5
UP 15-18 B7	59896121	59896119	6 3/8	5 1/8	4	3 4/5	3 1/4	-	3/4" sweat	6.7
UP 15-18 B7/LC	59896229	-	6 3/8	6 5/8	5 1/2	3 4/5	3 1/4	4	3/4" sweat	7.2
UP 15-18 B7/TLC	59896230	-	6 3/8	6 5/8	5 1/2	3 4/5	3 1/4	4	3/4" sweat	7.2

Note: LC/TLC Models have 6 ft (1.8 m), 3-prong power cord. Dimensions in inches unless otherwise noted.

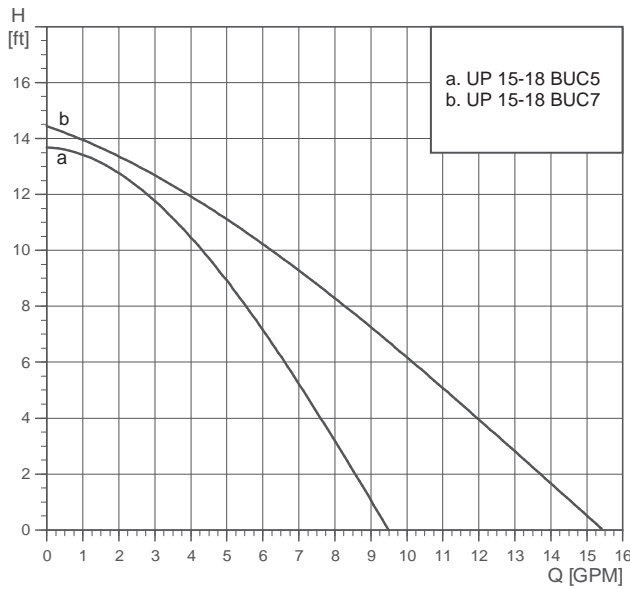

Flow range: 0-14.7 gpm
 Head range: 0-14.5 feet
 Motors: 2-pole, single-phase
 Max. liquid temperature: 230 °F (110 °C)
 Min. liquid temperature: 36 °F (2 °C)
 Max. system pressure: 145 psi (10 bar)

Model	Volts	Amps	Watts	Hp	Capacitor
UP 15-18 BUC5	115	0.55	60	1/25	8µF/180 V
UP 15-18 BUC7	115	0.55	60	1/25	8µF/180 V

Approvals



TM03 8428 1507

UP 15-18 BUC5

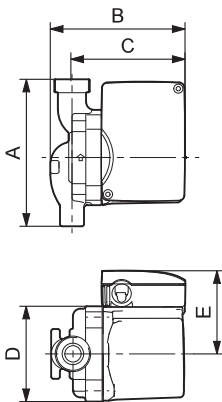

TM03 8549 1907

UP 15-18 BUC7

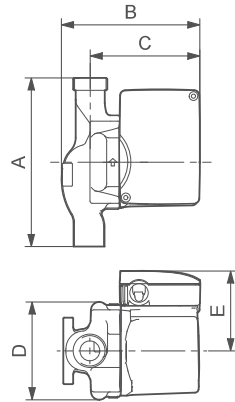

TM03 8553 2407

Model type	Product number	Dimensions [inches]						Connection type and size	Shipping weight [lbs]
		A	B	C	D	E	F		
UP 15-18 BUC5	59896123	6 1/2	5 1/4	4	3 3/16	3 1/4	-	1/2" sweat	7 1/4 lbs
UP 15-18 BUC7	59896124	7 3/4	5 1/4	4	3 3/4	3 1/4	-	3/4" sweat	8 lbs

Note: Dimensions in inches unless otherwise noted.

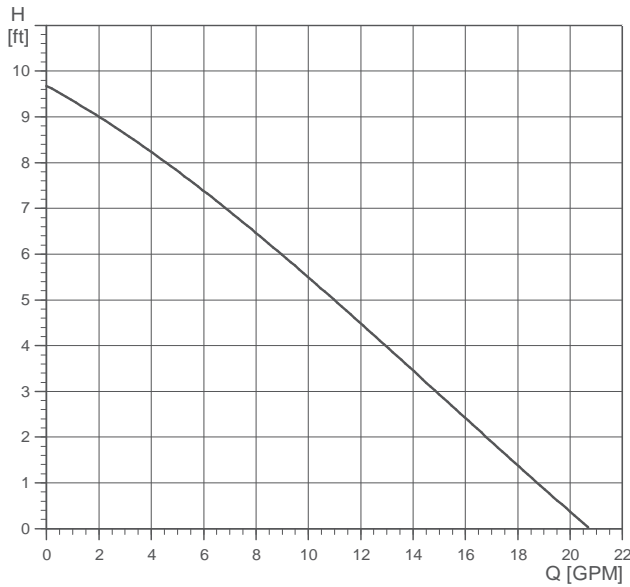

Flow range: 0-20.5 gpm
 Head range: 0-9.7 feet
 Motors: 2-pole, single-phase
 Max. liquid temperature: 230 °F (110 °C) and 150 °F
 Min. liquid temperature: 36 °F (2 °C)
 Max. system pressure: 145 psi (10 bar)
 Open system

Note: If the UP pump is equipped with a timer, the maximum liquid temperature is 150 °F (66 °C).

Model	Volts	Amps	Watts	Hp	Capacitor
UP 15-29 SF	115	0.75	87	0.12	10µF/180 V
UP 15-29 SUC		0.75	87	0.12	
UP 15-29 SU	230	0.42	97	0.15	2µF/400 V

TM03 8847 2607

Approvals



UP 15-29 SF

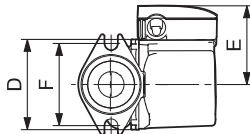
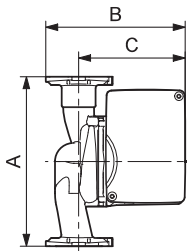

TM03 8776 2507

UP 15-29 SU

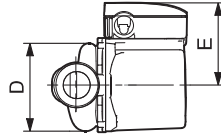
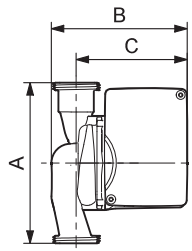

TM03 8777 2507

UP 15-29 SU/LC

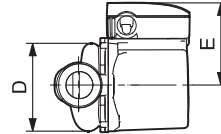
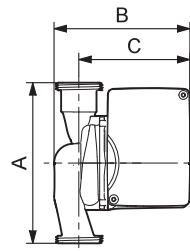

TM03 8777 2507

UP 15-29 SU/TLC

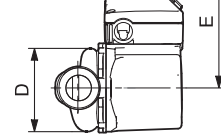
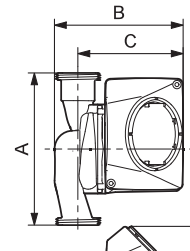

TM03 8778 250

Model type	Product number		Dimensions [inches]						Connection type and size	Shipping weight [lbs]
	115 V	230 V	A	B	C	D	E	F		
UP 15-29 SF	59896771	-	6 1/2	5 1/2	4 1/8	3 14/16	2 15/16	3 1/8	GF15/26	6.0
UP 15-29 SU	59896775	59896784	5 7/8	5 1/2	4 1/8	3 7/16	2 15/16	-	GU125	5.4
UP 15-29 SU/LC	59896776	-	5 7/8	5 1/2	4 1/8	3 7/16	2 15/16	-	GU125	5.7
UP 15-29 SUC/TLC	59896777	-	5 7/8	5 1/2	4 1/8	3 7/16	2 15/16	-	GU125	6.2

Note: LC/TLC Models have 6 ft (1.8 m), 3-prong power cord.
 Dimensions in inches unless otherwise noted.

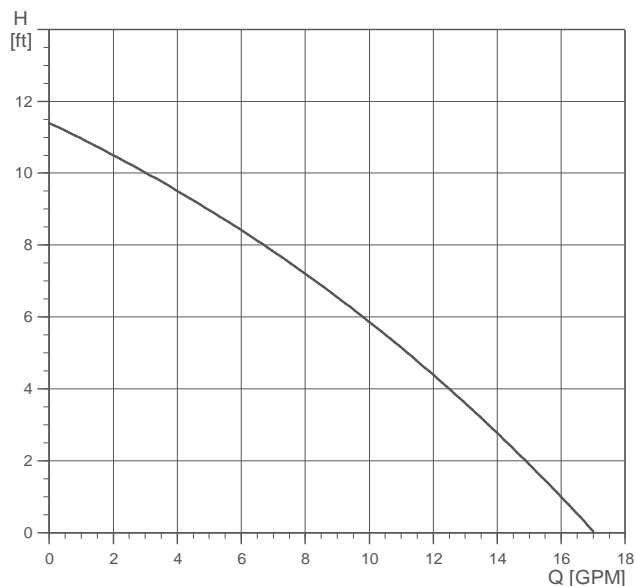

TM03 8846 2607

Flow range: 0-17.5 gpm
 Head range: 0-11.5 feet
 Motors: 2-pole, single-phase
 Max. liquid temperature: 230 °F (110 °C)
 Min. liquid temperature: 36 °F (2 °C)
 Max. system pressure: 145 psi (10 bar)
 Open system

Model	Volts	Amps	Watts	Hp	Capacitor
UP 15-35 SUC	230	0.42	114	0.15	2µF/400 V

Approvals



UP 15-35 SUC

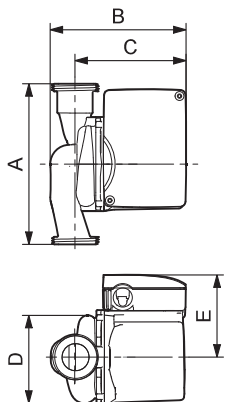

TM03 87777 2507

Model type	Product number	Dimensions [inches]						Connection type and size	Shipping weight [lbs]
		A	B	C	D	E	F		
UP 15-35 SUC	59896785	5 7/8	5 1/16	4 1/8	3 7/16	2 15/16	-	GU125	5.4

Note: Dimensions in inches unless otherwise noted.

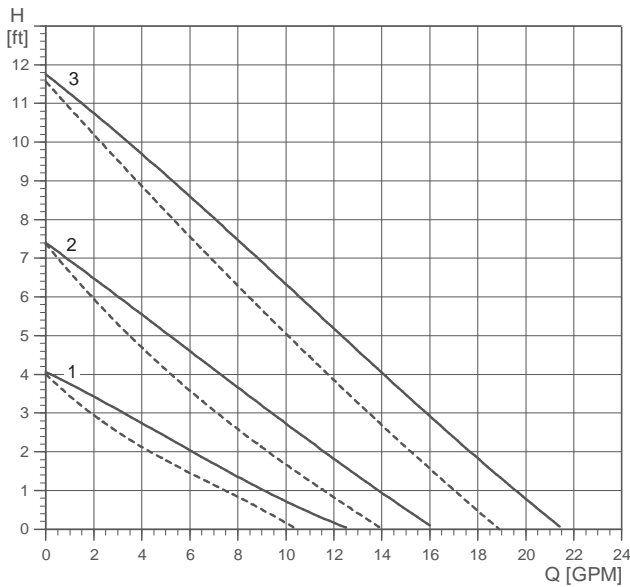

Flow range: 0-21.5 gpm
 Head range: 0-12 feet
 Motors: 2-pole, single-phase
 Max. liquid temperature: 165 °F (74 °C)
 Min. liquid temperature: 36 °F (2 °C)
 Max. system pressure: 145 psi (10 bar)

Note: If the UP pump is equipped with a timer, the maximum liquid temperature is 150 °F (66 °C).

Model	Spd	Volts	Amps	Watts	Hp	Capacitor
UPS 15-35 SUC/SFC	3	115	0.95	110	0.15	10µF/180 V
	2		0.75	84	0.11	
	1		0.55	61	0.08	

— Without check valve
 - - - With check valve

Approvals



UPS 15-35 SFC

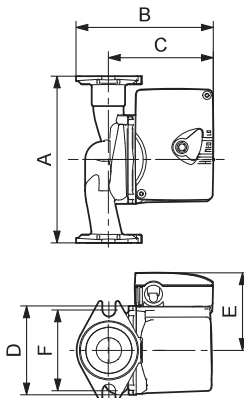

TM03 8779 2507

UPS 15-35 SUC/TLC

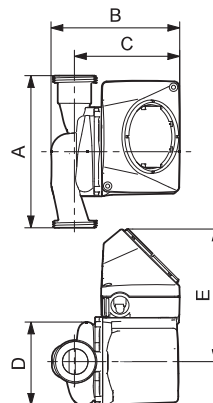

TM03 8778 2507

Model type	Product number	Dimensions [inches]						Connection type and size	Shipping weight [lbs]
		A	B	C	D	E	F		
UPS 15-35 SFC	59896772	6 1/2	5 1/2	4 1/8	3 7/8	2 15/16	3 1/8	GF15/26	6
UPS 15-35 SUC	59896778	5 7/8	5 1/16	4 1/8	3 7/16	2 15/16	-	GU125	5.4
UPS 15-35 SUC/TLC	59896780	5 7/8	5 1/16	4 1/8	3 7/16	2 15/16	-	GU125	6.2

Note: LC/TLC Models have 6 ft (1.8 m), 3-prong power cord. Removable check valve. Dimensions in inches unless otherwise noted.

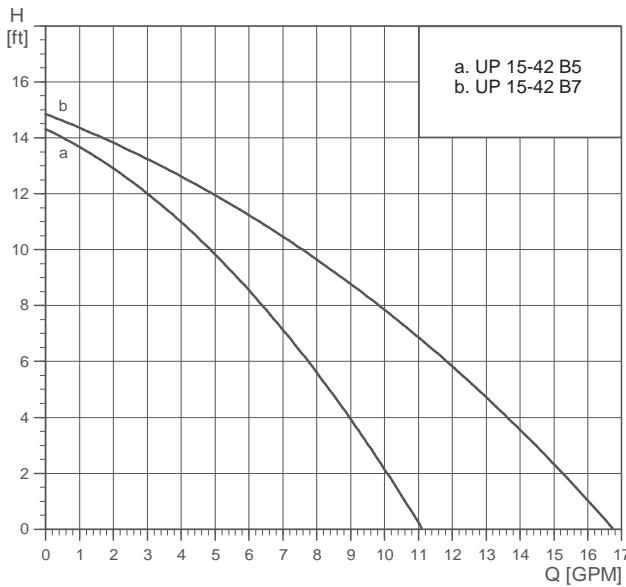

Flow range: 0-17 gpm
 Head range: 0-15 feet
 Motors: 2-pole, single-phase
 Max. liquid temperature: 230 °F (110 °C)
 Min. liquid temperature: 36 °F (2 °C)
 Max. system pressure: 145 psi (10 bar)

Note: If the UP pump is equipped with a timer, the maximum liquid temperature is 150 °F (66 °C).

Model	Volts	Amps	Watts	Hp	Capacitor
UP 15-42 B5	115	0.74	85	1/25	10µF/180 V
	230	0.41	95	1/25	2µF/400 V
UP 15-42 B7	115	0.74	85	1/25	10µF/180 V
	230	0.41	95	1/25	2µF/400 V

TM03 8430 1507

Approvals



UP 15-42 B5/LC and B7

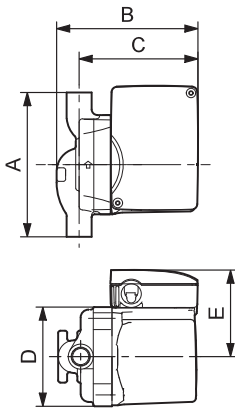

TM03 8545 1907

UP 15-42 B5/TLC

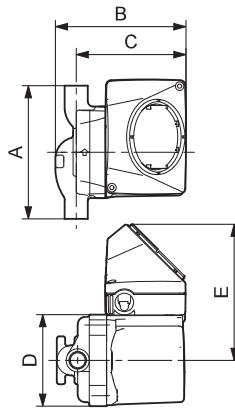

TM03 8546 1907

UP 15-42 B7/LC

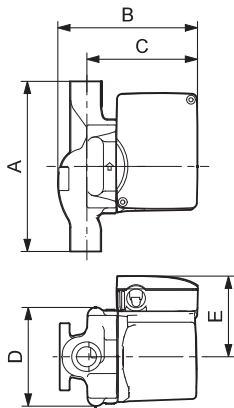

TM03 8547 1907

UP 15-42 B7/TLC

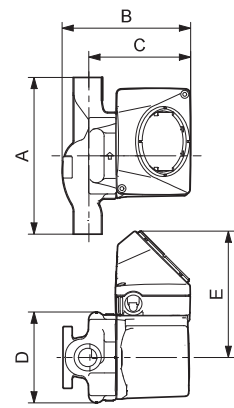

TM03 8548 1907

Model type	Product number		Dimensions [inches]						Connection type and size	Shipping weight [lbs]
	115 V	230 V	A	B	C	D	E	F		
UP 15-42 B5	59896145	59896142	5	4 11/16	4	3 1/2	3 1/4	-	1/2" sweat	6.0
UP 15-42 B5/LC	59896233	-	5	6 3/16	5 1/2	3 1/2	3 1/4	-	1/2" sweat	6.5
UP 15-42 B5/TLC	59896234	-	5	6 3/16	5 1/2	3 1/2	3 1/4	-	1/2" sweat	6.5
UP 15-42 B7	59896146	59896149	6 3/8	5 1/8	4	3 4/5	3 1/4	-	3/4" sweat	6.7
UP 15-42 B7/LC	59896235	-	6 3/8	6 5/8	5 1/2	3 4/5	3 1/4	-	3/4" sweat	7.2
UP 15-42 B7/TLC	59896236	-	6 3/8	6 5/8	5 1/2	3 4/5	3 1/4	-	3/4" sweat	7.2

Note: LC/TLC Models have 6 ft (1.8 m), 3-prong power cord.
 Dimensions in inches unless otherwise noted.

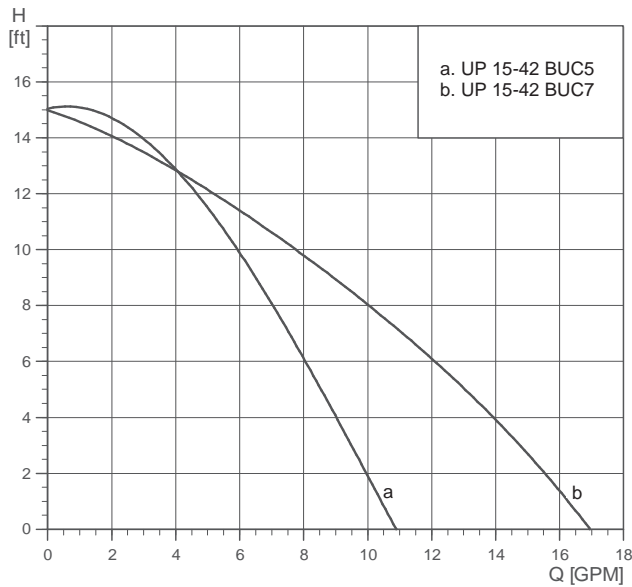

Flow range: 0-17 gpm
 Head range: 0-15 feet
 Motors: 2-pole, single-phase
 Max. liquid temperature: 205 °F (96 °C)
 Min. liquid temperature: 36 °F (2 °C)
 Max. system pressure: 145 psi (10 bar)

Model	Volts	Amps	Watts	Hp	Capacitor
UP 15-42 BUC5	115	0.74	85	1/25	10µF/180 V
UP 15-42 BUC7	115	0.74	85	1/25	10µF/180 V

Approvals



TM03 8431 1507

UP 15-42 BUC5

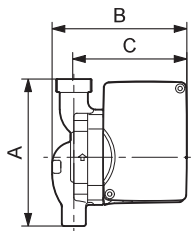

UP 15-42 BUC7

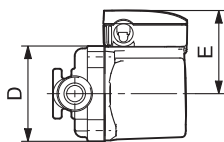
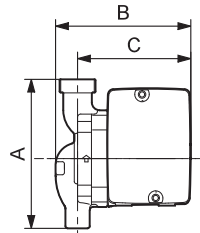

TM03 8549 1907

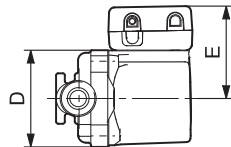

TM03 8753 2407

Model type	Product number	Dimensions [inches]						Connection type and size	Shipping weight [lbs]
		A	B	C	D	E	F		
UP 15-42 BUC5	59896150	6 1/2	5 1/4	4	3 3/16	3 1/4	-	1/2" sweat	6 1/2
UP 15-42 BUC7	59896151	7 3/4	5 1/4	4	3 3/4	3 1/4	-	3/4" sweat	6 3/4

Note: Dimensions in inches unless otherwise noted.

UP 15 MixiMizer

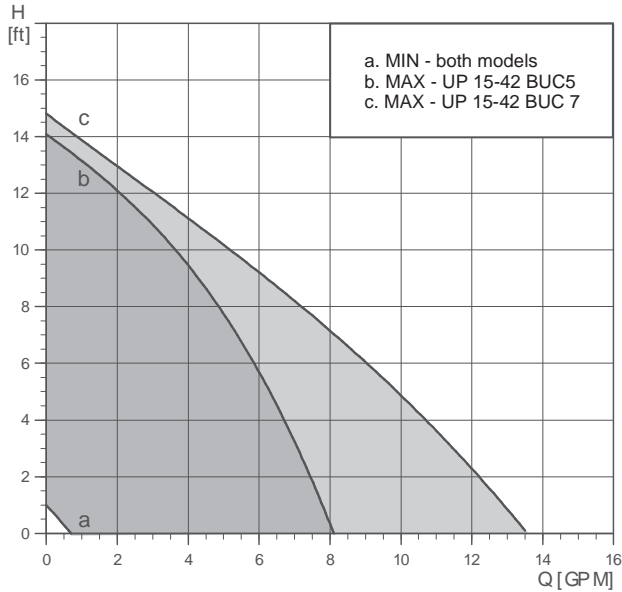

Flow range: 0-13.5 gpm
 Head range: 0-15 feet
 Motors: 2-pole, single-phase
 Max. liquid temperature: 205 °F (96 °C)
 Min. liquid temperature: 36 °F (2 °C)
 Max. system pressure: 145 psi (10 bar)

Model	Volts	Amps	Watts	Hp	Capacitor
UP 15-42 BUC5/MR	115	0.74	85	1/25	10µF/180 V
UP 15-42 BUC7/MR	115	0.74	85	1/25	10µF/180 V

Approvals



TM03 8839 2607

UP 15-42 BUC5/MR

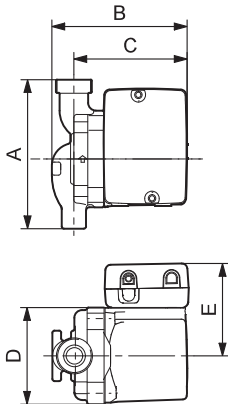

TM03 8755 2407

UP 15-42 BUC7/MR

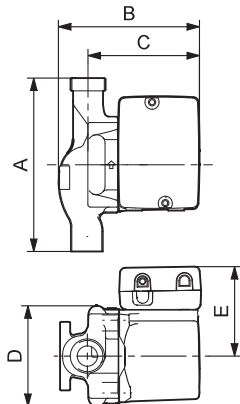

TM03 8756 2407

MixiMizer models include the following features:

- Two water-temperature sensors (system supply and return (prewired, 8 ft (2.4 m) each
- One prewired 6-ft line cord
- one outdoor air-temperature sensor
- Optional zone control input
- Optional boiler on/off output.

Model type	Product number	Dimensions [inches]						Connection type and size	Shipping weight [lbs]
		A	B	C	D	E	F		
UP 15-42 BUC5/MR	59896805	6 1/2	5 1/4	4	3 3/16	3 1/4	-	1/2" sweat	6 1/2
UP 15-42 BUC7/MR	59896806	7 3/4	5 1/4	4	3 3/4	3 1/4	-	3/4" sweat	6 3/4

Note: Dimensions in inches unless otherwise noted.

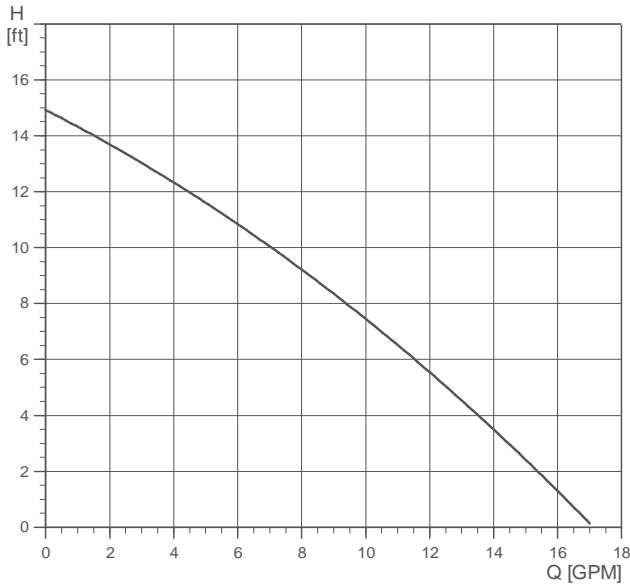

Flow range: 0-17 gpm
 Head range: 0-15 feet
 Motors: 2-pole, single-phase
 Max. liquid temperature: 230 °F (110 °C)
 Min. liquid temperature: 36 °F (2 °C)
 Max. system pressure: 145 psi (10 bar)
 Closed system

Model	Volts	Amps	Watts	Hp	Capacitor
UP 15-42 F/FR	115	0.74	85	1/25	10μF/180 V
	230	0.43	95	1/25	2μF/400 V

Approvals



TM03 5533 0709

UP 15-42 F

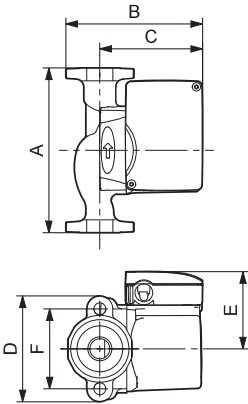

TM03 8526 1907

UP 15-42 FR

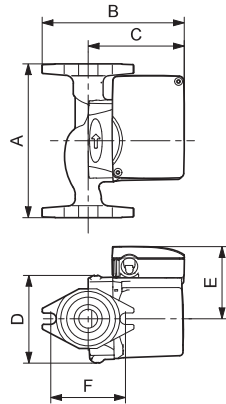

TM03 8527 1907

Model type	Product number		Dimensions [inches]						Connection type and size	Shipping weight [lbs]
	115 V	230 V	A	B	C	D	E	F		
UP 15-42 F	59896155	59896173	6 1/2	5 1/4	4	4 3/16	3 1/4	3 5/32	GF 15/26 flange (2) 1/2" dia. bolt holes	7 1/4
UP 15-42 FR	59896167	59896274		5 15/16		3 3/4				

Note: Dimensions in inches unless otherwise noted.

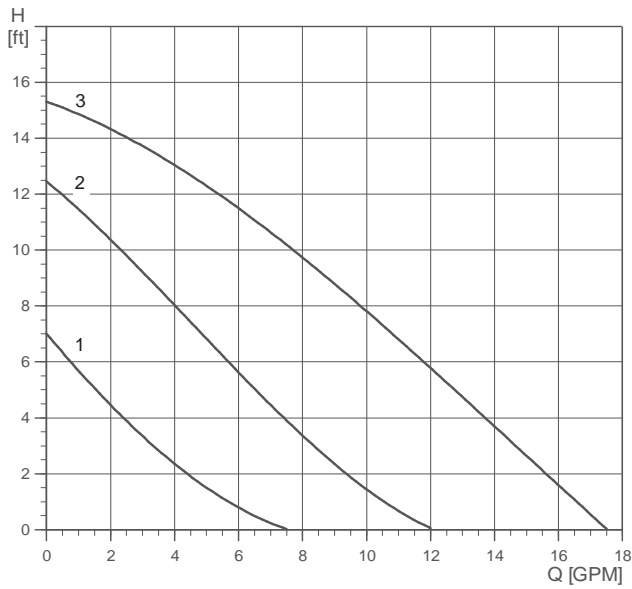

TM03 5574 0907

Flow range: 0-17.5 gpm
 Head range: 0-15.5 feet
 Motors: 2-pole, single-phase
 Max. liquid temperature: 230 °F (110 °C)
 Min. liquid temperature: 36 °F (2 °C)
 Max. system pressure: 145 psi (10 bar)

Model	Spd	Volts	Amps	Watts	Hp	Capacitor
UPS 15-42 F	3		0.41	92		
	2	230	0.19	40	1/25	2µF/400 V
	1		0.14	30		

Approvals



UPS 15-42 F

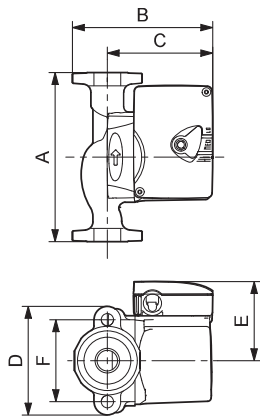

TM03 8757 2407

Model type	Product number		Dimensions [inches]						Connection type and size	Shipping weight [lbs]
	115 V	230 V	A	B	C	D	E	F		
UPS 15-42 F	-	59896180	6 1/2	5 1/4	4	4 3/16	3 1/4	3 5/32	GF 15/26 flange (2) 1/2" dia. bolt holes	7 1/4

Note: Dimensions in inches unless otherwise noted.

UP 15 MixiMizer

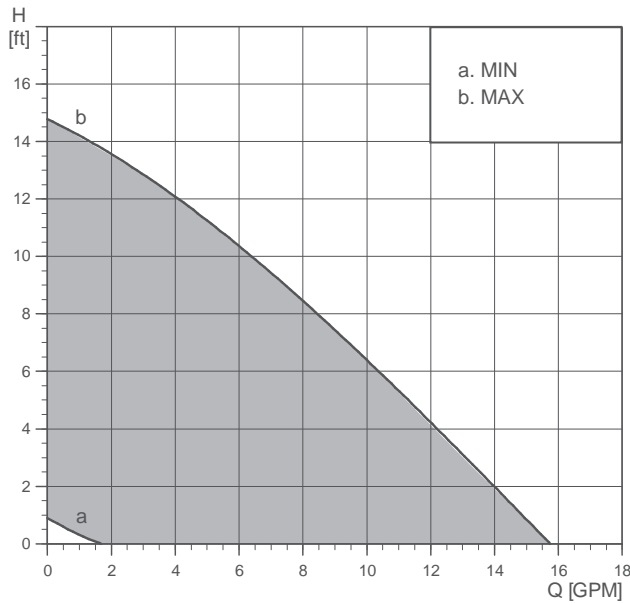

UP 15-42 FC/MR

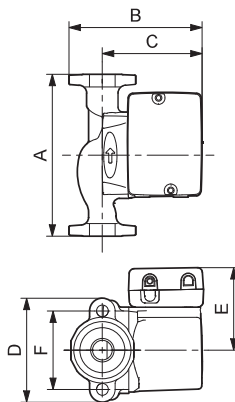

TM03 8838 2607

TM03 8828 1907

Flow range:	0-16 gpm
Head range:	0-15 feet
Motors:	2-pole, single-phase
Max. liquid temperature:	205 °F (96 °C)
Min. liquid temperature:	36 °F (2 °C)
Max. system pressure:	145 psi (10 bar)

Model	Volts	Amps	Watts	Hp	Capacitor
UP 15-42 FC/MR	115	0.74	85	1/25	10µF/180 V

Approvals



MixiMizer models include the following features:

- Two water-temperature sensors (system supply and return (prewired, 8 ft (2.4 m) each
- One prewired 6-ft line cord
- one outdoor air-temperature sensor
- Optional zone control input
- Optional boiler on/off output.

Model type	Product number	Dimensions [inches]						Connection type and size	Shipping weight [lbs]
		A	B	C	D	E	F		
UP 15-42 FC/MR	59896804	6 1/2	5 1/4	4	4 3/16	3 1/4	3 5/32	GF 15/26 flange (2) 1/2" dia. bolt holes	7 1/2

Note: Dimensions in inches unless otherwise noted.

UP 15 Variable Speed

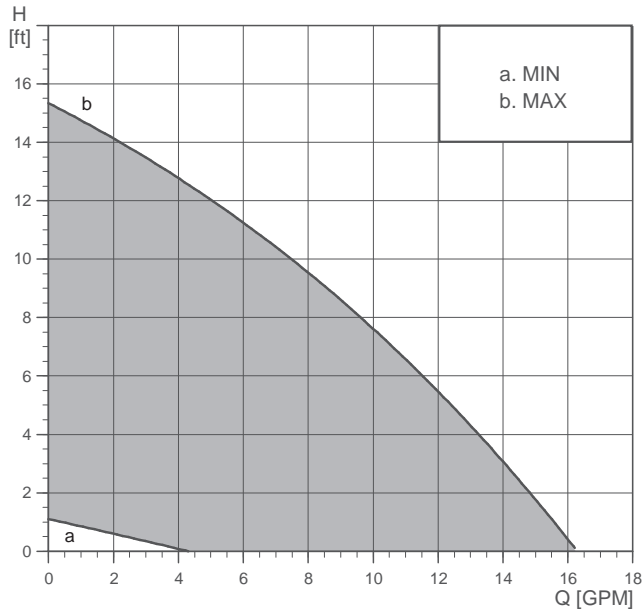

UP 15-42 F/V/S

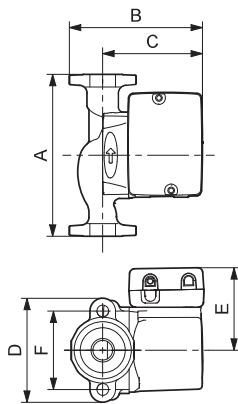

TM03 8840 0907

TM03 8528 1907

Flow range:	0-16 gpm
Head range:	0-15.5 feet
Motors:	2-pole, single-phase
Max. liquid temperature:	205 °F (96 °C)
Min. liquid temperature:	36 °F (2 °C)
Max. system pressure:	145 psi (10 bar)

Model	Volts	Amps	Watts	Hp	Capacitor
UP 15-42 F/V/V	115	0.74	85	1/25	10µF/180 V

Approvals



Variable speed models include the following features:

- Three speed control options:
 - 1) Manual
 - 2) Voltage: 0-10V(DC) or 2-10V(DC)
 - 3) Current: 0-20mA or 4-20 mA
- Dip switch control selection
- Pump exercising
- Manual offset dial
- Performance indicator LED's.

Model type	Product number	Dimensions [inches]						Connection type and size	Shipping weight [lbs]
		A	B	C	D	E	F		
UP 15-42 F/V/S	59896807	6 1/2	5 1/4	4	4 3/16	3 1/4	3 5/32	GF 15/26 flange (2) 1/2" dia. bolt holes	7 1/2

Note: Dimensions in inches unless otherwise noted.

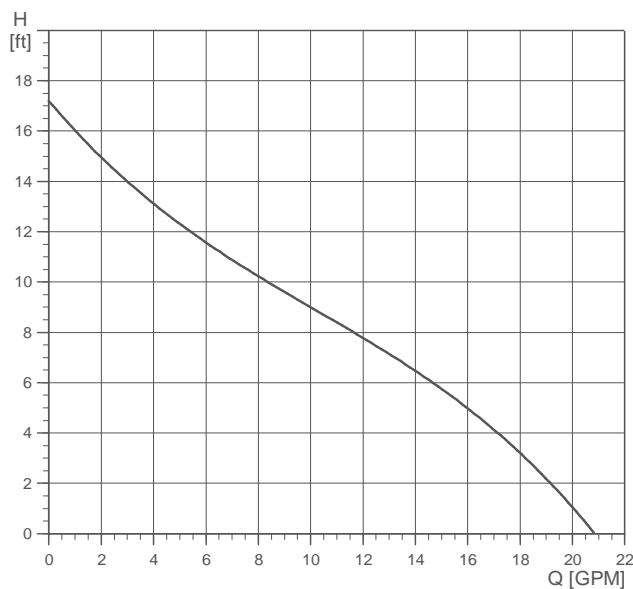

TM03 8845 2607

Flow range: 0-21.5 gpm
 Head range: 0-17 feet
 Motors: 2-pole, single-phase
 Max. liquid temperature: 230 °F (110 °C)
 Min. liquid temperature: 36 °F (2 °C)
 Max. system pressure: 145 psi (10 bar)
 Closed system

Model	Volts	Amps	Watts	Hp	Capacitor
UP 15-55 SUC	230	0.42	97	0.13	2µF/400 V

Approvals



UP 15-55 SUC

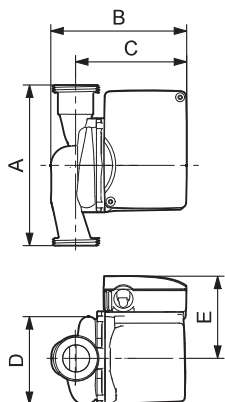

TM03 8777 2507

Model type	Product number		Dimensions [inches]						Connection type and size	Shipping weight [lbs]
	115 V	230 V	A	B	C	D	E	F		
UP 15-55 SUC	-	59896786	5 7/8	5 1/16	4 1/8	3 7/16	2 15/16	-	GU125	5.4

Note: Dimensions in inches unless otherwise noted.

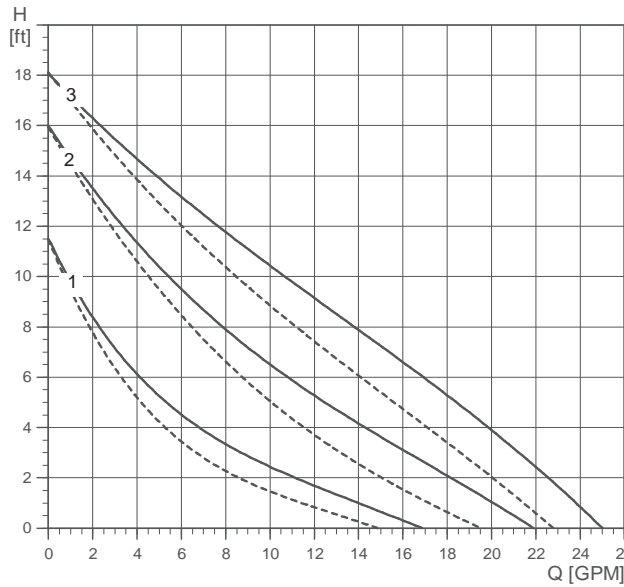

Flow range: 0-25 gpm
 Head range: 0-18 feet
 Motors: 2-pole, single-phase
 Max. liquid temperature: 230 °F (110 °C)
 Min. liquid temperature: 36 °F (2 °C)
 Max. system pressure: 145 psi (10 bar)

Note: If the UP pump is equipped with a timer, the maximum liquid temperature is 150 °F (66 °C).

Model	Spd	Volts	Amps	Watts	Hp	Capacitor
UPS 15-55 SFC	3		0.75	87	0.12	10µF/180 V
	2	115	0.69	77	0.1	
	1		0.53	58	0.08	
UPS 15-55 SUC	3		0.69	87	0.12	
	2	115	0.66	74	0.1	
	1		0.31	56	0.08	

— Without check valve

- - - With check valve

Approvals



UPS 15-55 SFC

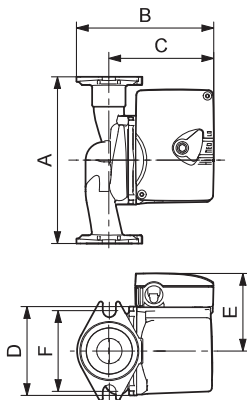

TM03 8779 2507

UPS 15-55 SUC/TLC

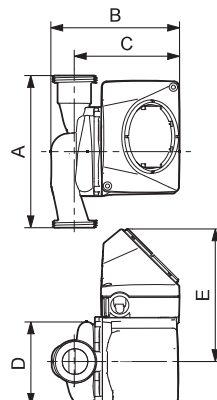

TM03 8778 2507

Model type	Product number	Dimensions [inches]						Connection type and size	Shipping weight [lbs]
		A	B	C	D	E	F		
UPS 15-55 SFC	59896773	6 1/2	5 1/2	4 1/8	3 7/8	2 15/16	3 1/8	GF15/26	6
UPS 15-55 SUC	59896781	5 7/8	5 1/16	4 1/8	3 7/16	2 15/16	-	GU125	5.4
UPS 15-55 SUC/TLC	59896783	5 7/8	5 1/16	4 1/8	3 7/16	2 15/16	-	GU125	6.2

Note: LC/TLC Models have 6 ft (1.8 m), 3-prong power cord. Removable check valve. Dimensions in inches unless otherwise noted.

UP 15 ALPHA

Performance* and operation mode selection

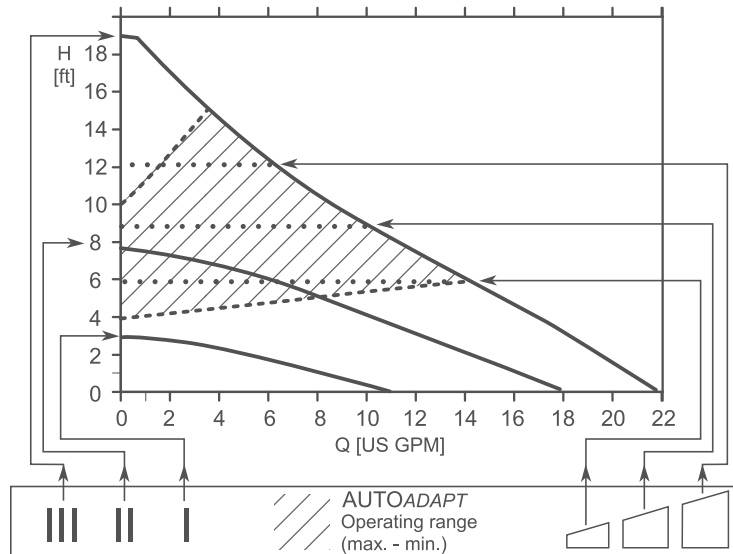

TM04 6025 0611

Pos.	Description
	<ul style="list-style-type: none"> Push-button for selection of pump setting Every time the push-button is pressed, the circulator setting is changed
III	High Fixed Speed <ul style="list-style-type: none"> Runs at a constant speed and consequently on a constant curve. In Speed III, the pump is set on the maximum curve under all operating conditions. Quick Vent of the pump can be obtained by setting the pump to Speed III for a short period.
II	Medium Fixed Speed <ul style="list-style-type: none"> Runs at a constant speed and consequently on a constant curve. In Speed II, the pump is set on the medium curve under all operating conditions.
I	Low Fixed Speed <ul style="list-style-type: none"> Runs at a constant speed and consequently on a constant curve. In Speed I, the pump is set on the minimum curve under all operating conditions.

Pos.	Description
	Constant Pressure I <ul style="list-style-type: none"> The duty point of the pump will move left and right along the lowest constant-pressure curve depending on water demand in the system. The pump head (pressure) is kept constant, irrespective of the water demand.
	Constant Pressure II <ul style="list-style-type: none"> The duty point of the pump will move left and right along the middle constant-pressure curve depending on water demand in the system. The pump head (pressure) is kept constant, irrespective of the water demand.
	Constant Pressure III <ul style="list-style-type: none"> The duty point of the pump will move left and right along the highest constant-pressure curve depending on water demand in the system. The pump head (pressure) is kept constant, irrespective of the water demand.
	AutoAdapt (Factory Setting) <ul style="list-style-type: none"> This function controls the pump performance automatically within the defined performance range. Automatically adjusting the pump performance to system demands over time.

*Hydraulic performance without check valve.

ALPHA 15-55 F Terminal box

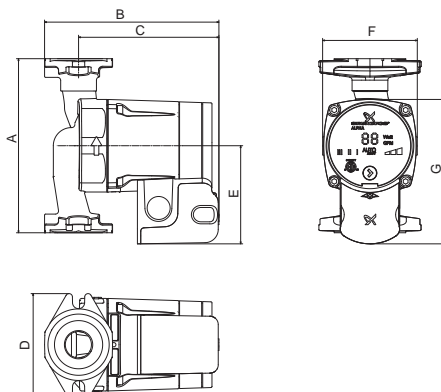

TM04 9773 0111

ALPHA 15-55 FR Terminal box

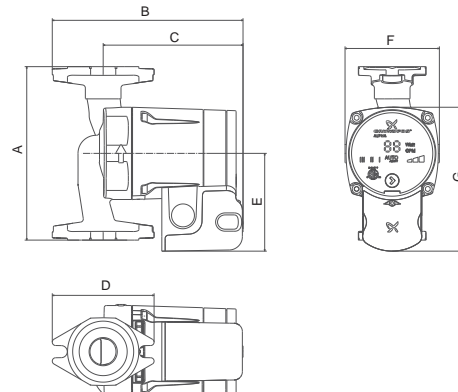

TM04 9774 0111

UP 15 ALPHA

ALPHA 15-55 F Linecord

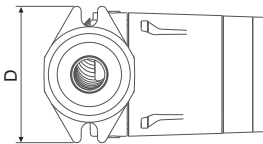
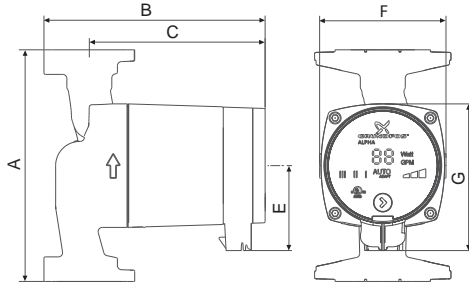

TM04 6012 4709

ALPHA 15-55 FR Linecord

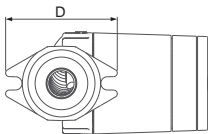
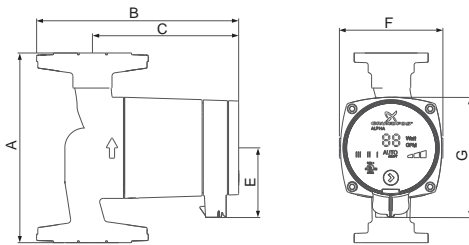

TM04 6013 4709

Flow range: 0-21.5 gpm
 Head range: 0-17 feet
 Motors: 2-pole, single-phase
 Max. liquid temperature: 230 °F (110 °C)
 Min. liquid temperature: 36 °F (2 °C)
 Max. system pressure: 150 psi (10 bar)
 Closed (F, FR) and Open systems (SF)

Model	Volts	Amps	Watts	Hp	Capacitor
ALPHA 15-55	115	0.65	5 to 45	0.06	-

Approximate power usage

Speed setting		Min.	Max.
High fixed speed	III	39W	45W
Medium fixed speed	II	15W	30W
Low fixed speed	I	5W	8W
Constant pressure		8W	45W
Constant pressure		14W	45W
Constant pressure		22W	45W
AutoADAPT		5W	45W

Approvals



Canadian EMC Standard: ICES-003
 This Class B digital apparatus complies with Canadian ICES-003.

Model type	Product number	Dimensions [inches]								Connection type and size	Shipping weight [lbs]
		A	B	C	D	E	F	G			
ALPHA 15-55 F	59896877	6 1/2	6 1/2	5 1/4	3 13/16	3 11/16	3 9/16	5 3/8	GF 15/26 (2) 1/2" dia. bolt holes	7.20	
ALPHA 15-55 FR	59896878	6 1/2	7 3/16	5 1/4	3 13/16	3 11/16	3 9/16	5 3/8		7.10	
ALPHA 15-55 SF	59896879	6 1/2	6 1/2	5 1/4	3 13/16	3 11/16	3 9/16	5 3/8		6.10	
ALPHA 15-55 F/LC	59896832	6 1/2	6 1/2	4 15/16	4	2 1/2	3 7/16	4 1/8	GF 15/26 (2) 1/2" dia. bolt holes	7.50	
ALPHA 15-55 FR/LC	59896833	6 1/2	7	4 15/16	4	2 1/2	3 7/16	4 1/8		7.33	
ALPHA 15-55 SF/LC	59896834	6 1/2	6 1/2	4 15/16	4	2 1/2	3 7/16	4 1/8		6.25	

Note: Dimensions in inches unless otherwise noted.

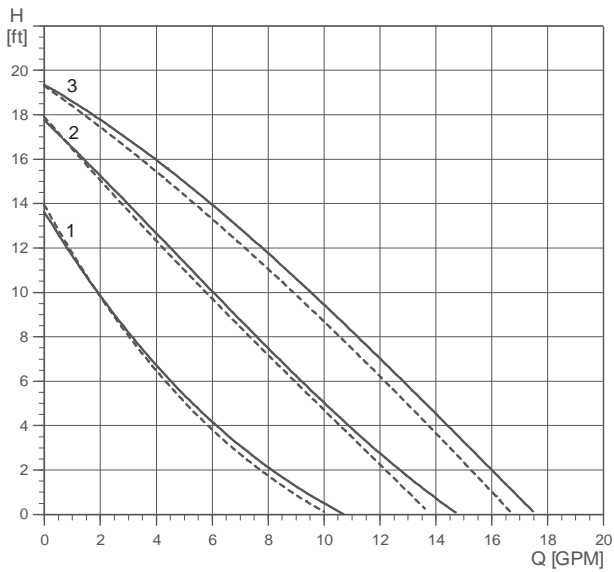

TM03 5535 0907

Flow range: 0-17 gpm
 Head range: 0-19.5 feet
 Motors: 2-pole, single-phase
 Max. liquid temperature: 230 °F (110 °C)
 Min. liquid temperature: 36 °F (2 °C)
 Max. system pressure: 145 psi (10 bar)

Model	Spd	Volts	Amps	Watts	Hp	Capacitor
UPS 15-58 FC/FRC	3	115	0.75	87	1/25	10µF/180 V
	2		0.66	80	1/25	
	1		0.55	60	1/25	

—	Without check valve
- - -	With check valve

UPS 15-58 FC

UPS 15-58 FRC

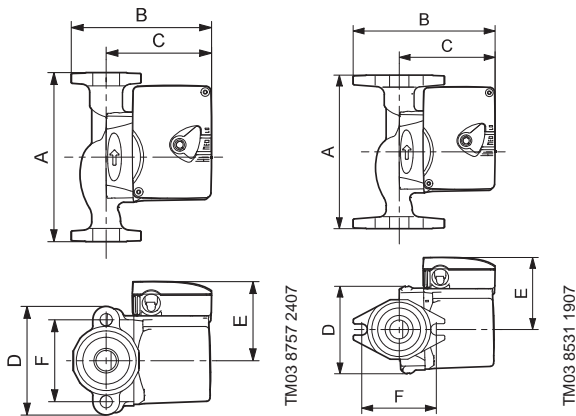

Approvals



Model type	Product number	Dimensions [inches]						Connection type and size	Shipping weight [lbs]
		A	B	C	D	E	F		
UPS 15-58 FC	59896341	6 1/2	5 1/4	4	4 3/16	3	3 5/32	GF 15/26 flange (2) 1/2" dia. bolt holes	7 1/4
UPS 15-58 FRC	59896343	6 1/2	5 1/4	4	4 3/16	3	3 5/32	GF 15/26 flange (2) 1/2" dia. bolt holes	7 1/4

Note: The check valve can be removed.
 Dimensions in inches unless otherwise noted.

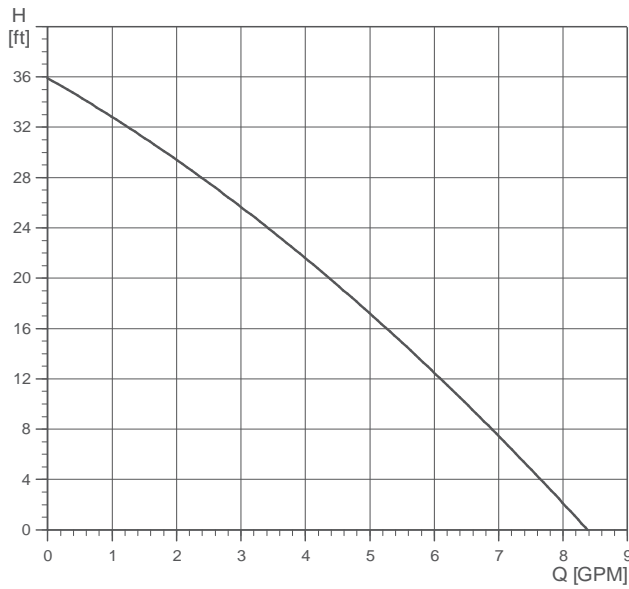

TM03 5534 3806

Flow range: 0-8.4 gpm
 Head range: 0-36 feet
 Motors: 2-pole, single-phase
 Max. liquid temperature: 205 °F (96 °C)
 Min. liquid temperature: 36 °F (2 °C)
 Max. system pressure: 145 psi (10 bar)
 Closed system

Model	Volts	Amps	Watts	Hp	Capacitor
UP 15-100 F	115	1.1	135	1/25	12µF/180 V

Approvals



UP 15-100 F

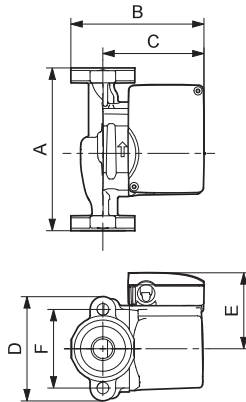

TM03 8530 1907

Model type	Product number	Dimensions [inches]						Connection type and size	Shipping weight [lbs]
		A	B	C	D	E	F		
UP 15-100 F	59896300	6 1/2	5 1/4	4	4 3/16	3 1/4	3 5/32	GF 15/26 flange (2) 1/2" dia. bolt holes	7 1/4

Note: Dimensions in inches unless otherwise noted.

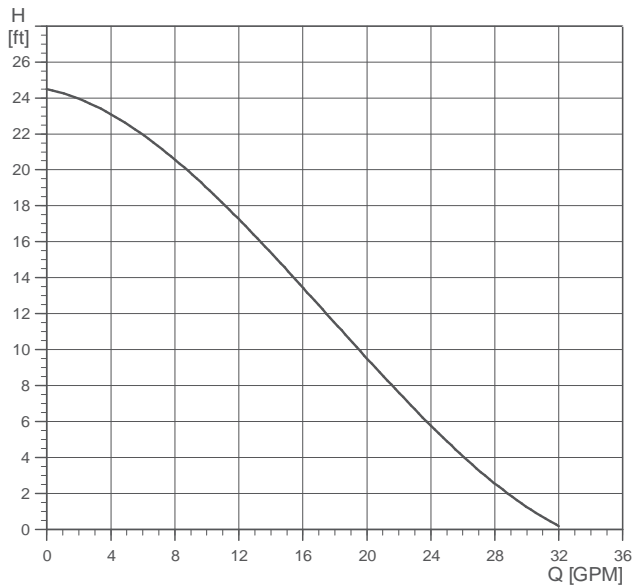

TIM03 5536 0907

Flow range: 0-32 gpm
 Head range: 0-24.5 feet
 Motors: 2-pole, single-phase
 Max. liquid temperature: 230 °F (110 °C)
 Min. liquid temperature: 36 °F (2 °C)
 Max. system pressure: 145 psi (10 bar)
 Closed system

Model	Volts	Amps	Watts	Hp	Capacitor
UP 26-64 F	115	1.7	185	1/12	8µF/180 V
	230	0.8	175	1/12	2.5µF/380 V

Approvals



UP 26-64 F

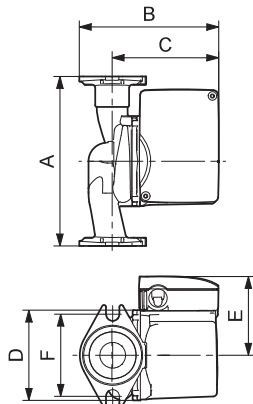

TIM03 8776 2507

Model type	Product number		Dimensions [inches]						Connection type and size	Shipping weight [lbs]
	115 V	230 V	A	B	C	D	E	F		
UP 26-64 F	52722330	52722327	6 1/2	6 3/8	5 1/16	4 1/8	3 1/2	3 5/32	GF 15/26 flange (2) 1/2" dia. bolt holes	11 1/4

Note: Dimensions in inches unless otherwise noted.

UP 26 Variable Speed

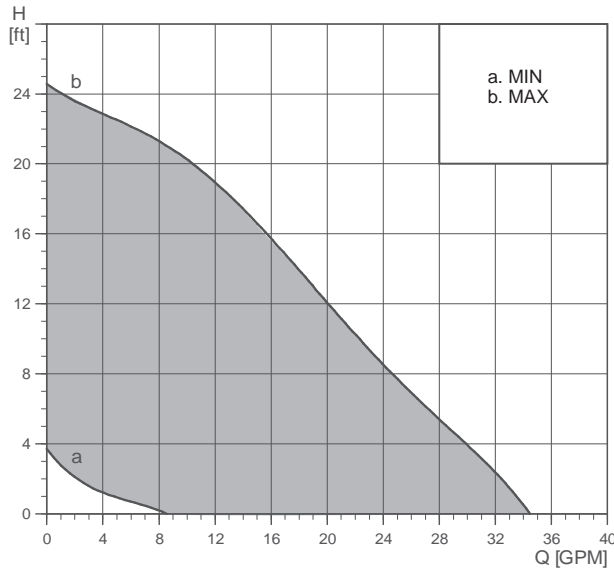

Flow range: 0-34 gpm
 Head range: 0-24.5 feet
 Motors: 2-pole, single-phase
 Max. liquid temperature: 195 °F (91 °C)
 Min. liquid temperature: 36 °F (2 °C)
 Max. system pressure: 145 psi (10 bar)

Model	Volts	Amps	Watts	Hp	Capacitor
UP 26-64 F/VS	115	1.7	185	1/12	8µF/180 V

Approvals



Variable speed models include the following features:

- Three speed control options:
 - 1) Manual
 - 2) Voltage: 0-10V(DC) or 2-10V(DC)
 - 3) Current: 0-20mA or 4-20 mA
- Dip switch control selection
- Pump exercising
- Manual offset dial
- Performance indicator LED's.

UP 26-64 F/VS

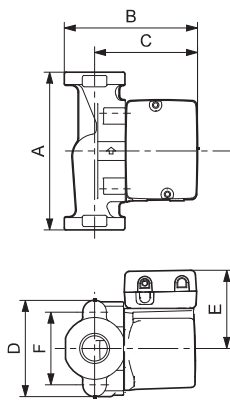

TM03 8841 2607

TM03 8533 1907

Model type	Product number	Dimensions [inches]						Connection type and size	Shipping weight [lbs]
		A	B	C	D	E	F		
UP 26-64 F/VS	52722553	6 1/2	6 3/8	5 1/16	4 1/8	3 1/2	3 5/32	GF 15/26 flange (2) 1/2" dia. bolt holes	11 1/4

Note: Dimensions in inches unless otherwise noted.

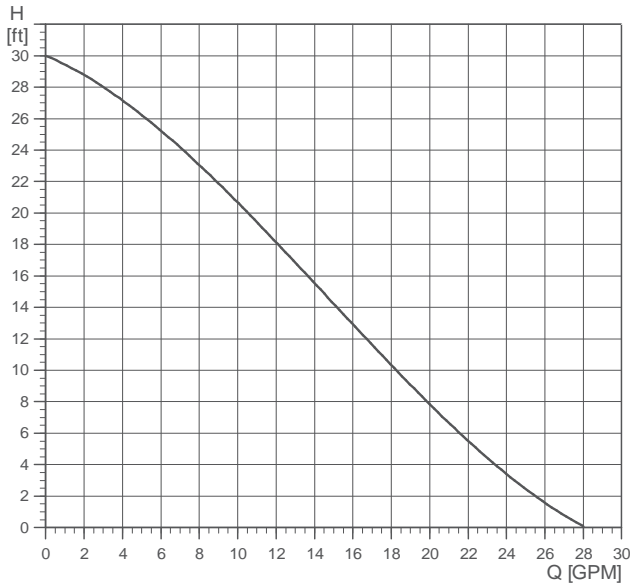

Motors: 2-pole, single-phase
 Max. liquid temperature: 230 °F (110 °C)
 Min. liquid temperature: 36 °F (2 °C)
 Max. system pressure: 145 psi (10 bar)
 Closed system (F) and open system (BF)

Model	Volts	Amps	Watts	Hp	Capacitor
UP 26-96 F/BF	115	1.7	205	1/12	10µF/180 V
	230	0.8	205	1/12	2.5µF/380 V

Approvals

UP 26-96 F/BF



UP 26-96 BF



Flow range: 0-28 gpm
 Head range: 0-30 feet

UP 26-96 F

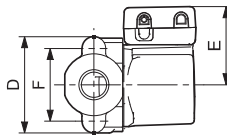
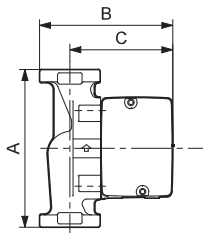

TM03 8533 1907

UP 26-96 BF

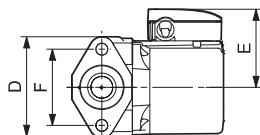
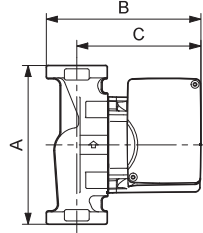

TM03 8543 1907

Model type	Product number		Dimensions [inches]						Connection type and size	Shipping weight [lbs]
	115 V	230 V	A	B	C	D	E	F		
UP 26-96 F	52722341	52722338	6 1/2	6 3/8	5 1/16	4 1/8	3 1/2	3 5/32	GF 15/26 flange (2) 1/2" dia. bolt holes	11 1/4
UP 26-96 BF	52722336	52722334	6 1/2	6 3/8	5 1/16	4 1/8	3 1/2	3 5/32	GF 15/26 flange (2) 1/2" dia. bolt holes	12.5

Note: Dimensions in inches unless otherwise noted.

UP 26 Variable Speed

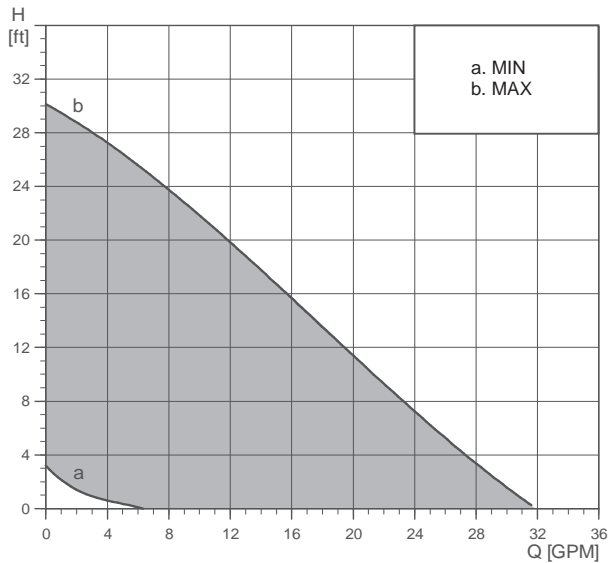

Flow range:	0-28 gpm
Head range:	0-30 feet
Motors:	2-pole, single-phase
Max. liquid temperature:	195 °F (91 °C)
Min. liquid temperature:	36 °F (2 °C)
Max. system pressure:	145 psi (10 bar)

Model	Volts	Amps	Watts	Hp	Capacitor
UP 26-96 F/VS	115	1.7	205	1/12	10 μ F/180 V

Approvals



Variable speed models include the following features:

- Three speed control options:
 - 1) Manual
 - 2) Voltage: 0-10V(DC) or 2-10V(DC)
 - 3) Current: 0-20mA or 4-20 mA
- Dip switch control selection
- Pump exercising
- Manual offset dial
- Performance indicator LED's.

UP 26-96 F/VS

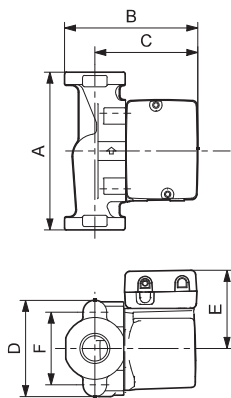

TM03 8842 2607

TM03 8533 1907

Model type	Product number		Dimensions [inches]						Connection type and size	Shipping weight [lbs]
	115 V	230 V	A	B	C	D	E	F		
UP 26-96 F/VS	52722552	-	6 1/2	6 3/8	5 1/16	4 1/8	3 1/2	3 5/32	GF 15/26 flange (2) 1/2" dia. bolt holes	11 1/4

Note: Dimensions in inches unless otherwise noted.

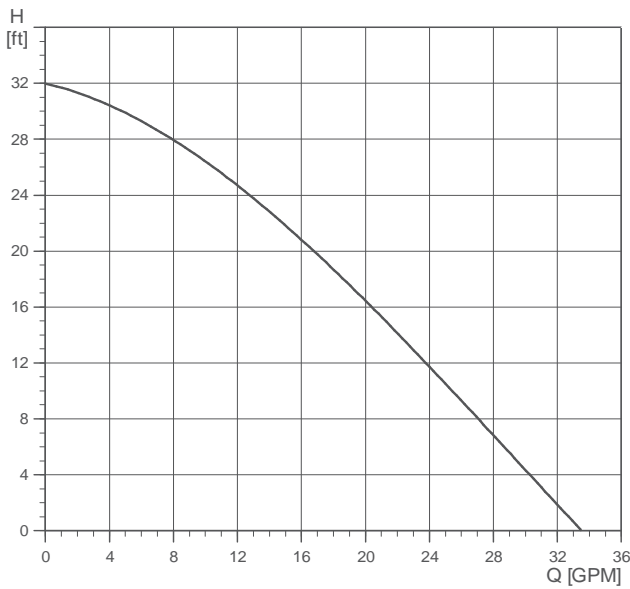

TM03 5557 0907

Flow range: 0-34 gpm
 Head range: 0-32 feet
 Motors: 2-pole, single-phase
 Max. liquid temperature: 230 °F (110 °C)
 Min. liquid temperature: 36 °F (2 °C)
 Max. system pressure: 145 psi (10 bar)
 Closed system (F) and Open system (BF)

Model	Volts	Amps	Watts	Hp	Capacitor
UP 26-99 F/BF	115	2.15	245	1/6	10µF/180 V
	230	1.07	245	1/6	2.5µF/380 V

Approvals

UP 26-99 F/BF



UP 26-99 BF



UP 26-99 F/BF

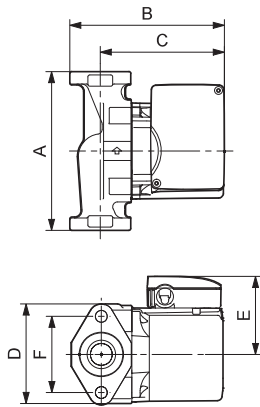

TM03 8532 1907

Model type	Product number		Dimensions [inches]						Connection type and size	Shipping weight [lbs]
	115 V	230 V	A	B	C	D	E	F		
UP 26-99 F	52722355	52722351	6 1/2	6 3/8	5 1/16	4 1/8	3 1/2	3 5/32	GF 15/26 flange (2) 1/2" dia. bolt holes	12 1/2
UP 26-99 BF	52722347	52722346	6 1/2	6 3/8	5 1/16	4 1/8	3 1/2	3 5/32	GF 15/26 flange (2) 1/2" dia. bolt holes	12 1/2

Note: Dimensions in inches unless otherwise noted.

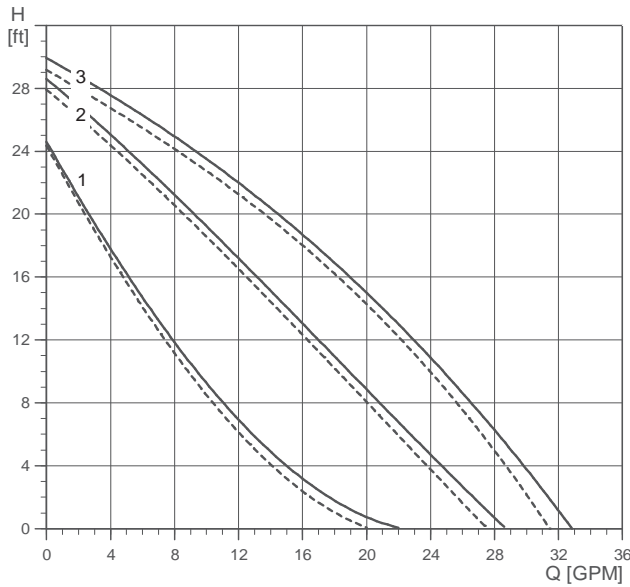

TM03 8195 2006

Flow range: 0-33 gpm
 Head range: 0-29 feet
 Motors: 2-pole, single-phase
 Max. liquid temperature: 230 °F (110 °C)
 Min. liquid temperature: 36 °F (2 °C)
 Max. system pressure: 145 psi (10 bar)

Model	Spd	Volts	Amps	Watts	Hp	Capacitor
UPS 26-99 FC	3	115	1.8	197	1/6	20µF/180 V
	2		1.5	179	1/6	20µF/180 V
	1		1.3	150	1/6	20µF/180 V
UPS 26-99 FC/BFC	3	230	0.9	196	1/6	5µF/400 V
	2		0.8	179	1/6	5µF/400 V
	1		0.7	150	1/6	5µF/400 V

— Without check valve

- - - With check valve

UPS 26-99 FC

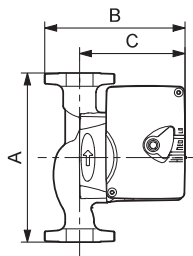

UPS 26-99 BFC

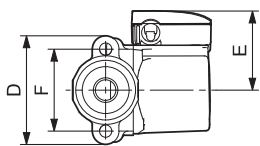
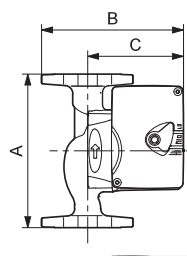

TM03 8757 2407

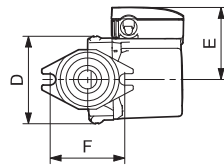

TM03 8531 1907

Approvals

UP 26-99 F/BFC



UP 26-99 BFC



Model type	Product number		Dimensions [inches]						Connection type and size	Shipping weight [lbs]
	115 V	230 V	A	B	C	D	E	F		
UPS 26-99 FC	52722512	52722513	6 1/2	6	4 7/8	3 1/2	3 7/16	3 5/32	GF 15/26 flange (2) 1/2" dia. bolt holes	10.3
UPS 26-99 BFC	52722518	52722519	6 1/2	6	4 7/8	3 1/2	3 7/16	3 5/32	GF 15/26 flange (2) 1/2" dia. bolt holes	10.3

Note: The check valve can be removed.
 Dimensions in inches unless otherwise noted.

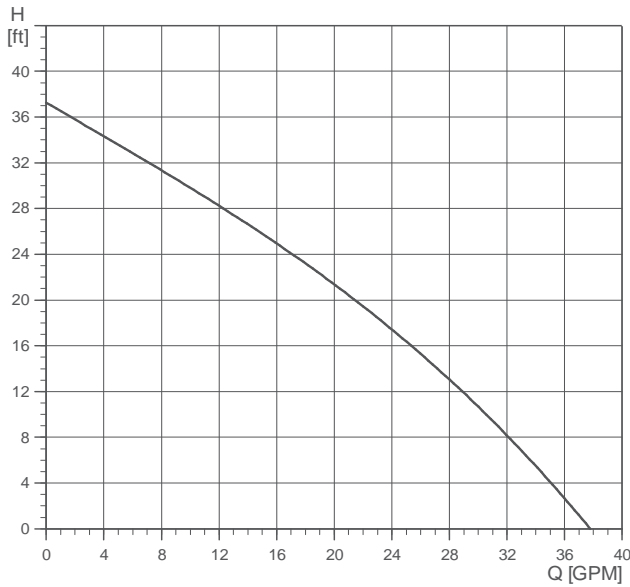

Flow range: 0-37 gpm
 Head range: 0-37 feet
 Motors: 2-pole, single-phase
 Max. liquid temperature: 150 °F (65 °C)
 Min. liquid temperature: 32 °F (0 °C)
 Max. system pressure: 145 psi (10 bar)
 Closed system (F) and Open system (BF)

Model	Volts	Amps	Watts	Hp	Capacitor
UP 26-116 F/BF	230	1.8	385	1/6	2.5µF/380 V

Approvals

UP 26-116 F/BF



UP 26-116 BF



TM03 5577 0907

TM03 8543 1907

UP 26-116 F

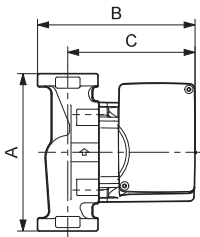

UP 26-116 BF

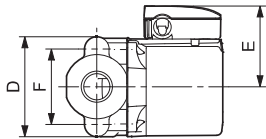
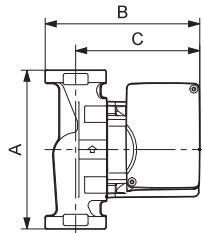

TM03 8758 2407

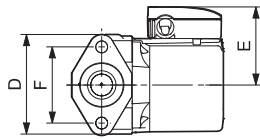

TM03 8543 1907

Model type	Product number	Dimensions [inches]						Connection type and size	Shipping weight [lbs]
		A	B	C	D	E	F		
UP 26-116 F	52722377	6 1/2	6 3/8	5 1/16	4 1/8	3 1/2	3 5/32	GF 15/26 flange (2) 1/2" dia. bolt holes	12 1/2 lbs
UP 26-116 BF	52722393	6 1/2	6 3/8	5 1/16	4 1/8	3 1/2	3 5/32	GF 15/26 flange (2) 1/2" dia. bolt holes	12 1/2 lbs

Note: Dimensions in inches unless otherwise noted.

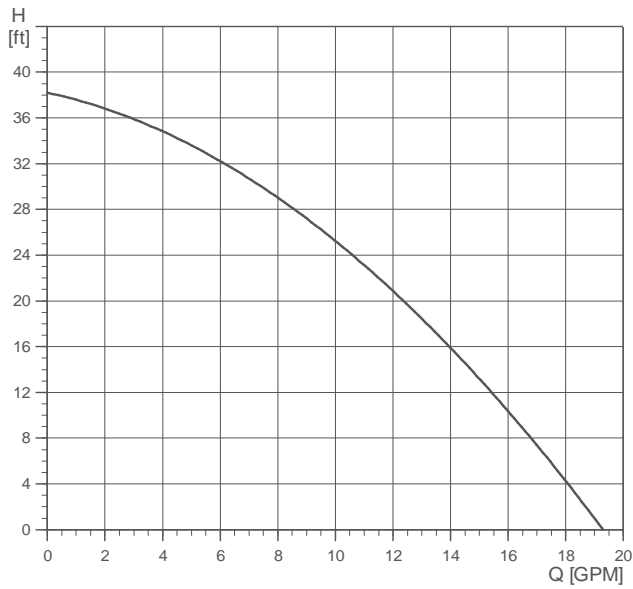

Flow range: 0-19 gpm
 Head range: 0-38 feet
 Motors: 2-pole, single-phase
 Max. liquid temperature: 203 °F (95 °C)
 Min. liquid temperature: 32 °F (0 °C)
 Max. system pressure: 145 psi (10 bar)
 Closed system

Model	Volts	Amps	Watts	Hp	Capacitor
UP 26-120 U	115	2.15	215	1/6	10µF/180 V
	230	1.07	220	1/6	2.5µF/380 V

TM03 5546 3806

Approvals



UP 26-120 U

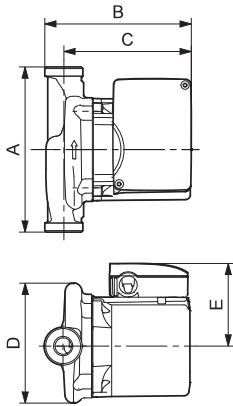

TM03 8761 2407

Model type	Product number		Dimensions [inches]					Connection type and size	Shipping weight [lbs]
	115 V	230 V	A	B	C	D	E		
UP 26-120 U	52722435	52722436	7 1/16	5 7/8	5 1/16	4 7/8	3 1/2	GF 125 union - 1 1/4" NPSM	10 1/2

Note: Dimensions in inches unless otherwise noted.

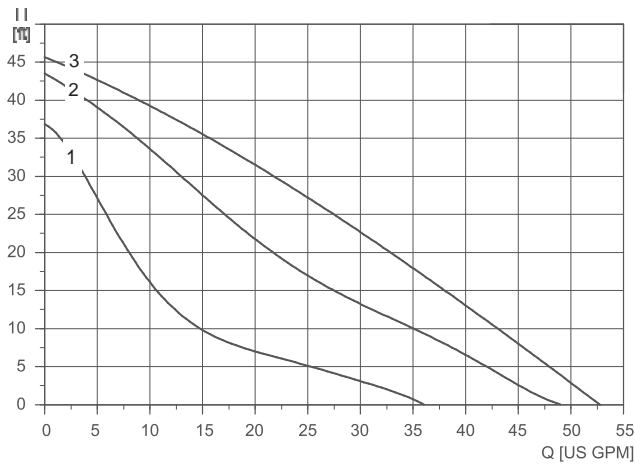

TM04 5463

Flow range: 0-53 gpm
 Head range: 0-46 feet
 Motors: 2-pole, single-phase
 Max. liquid temperature: 230 °F (110 °C)
 Min. liquid temperature: 36 °F (2 °C)
 Max. system pressure: 145 psi (10 bar)

UPS 26-150 F/SF

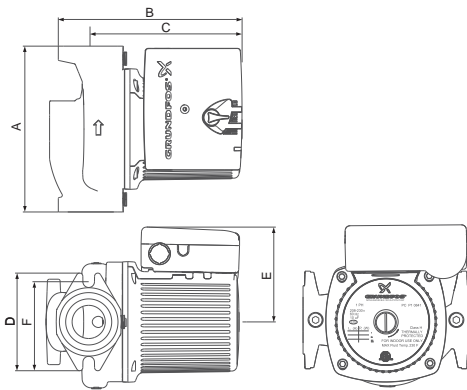

TM04 6014

Model	Spd	Volts	Amps	Watts	Hp	Capacitor
	3		3.5	370	1/6	40µF/ 180V
	2	115	3.1	335	1/6	
	1		2.5	265	1/6	
UPS 26-150 F/SF	3		1.7	350	1/6	10µF/ 400V
	2	208	1.5	310	1/6	
	1		1.2	250	1/6	
	3		1.7	370	1/6	10µF/ 400V
	2	230	1.5	335	1/6	
	1		1.2	265	1/6	

Approvals



Model type	Product number		Dimensions [inches]						Connection type and size	Shipping weight [lbs]
	115 V	208 / 230 V	A	B	C	D	E	F		
UPS 26-150 F	95906630	95906631	6 1/2	7 1/8	5 7/8	3 7/8	3 3/4	3 1/8	GF 15/26 flange (2) 1/2" dia. bolt holes	17.35
UPS 26-150 SF	95906632	95906633	6 1/2	7 1/8	5 7/8	3 7/8	3 3/4	3 1/8	GF 15/26 flange (2) 1/2" dia. bolt holes	17.35

Note: Dimensions in inches unless otherwise noted.

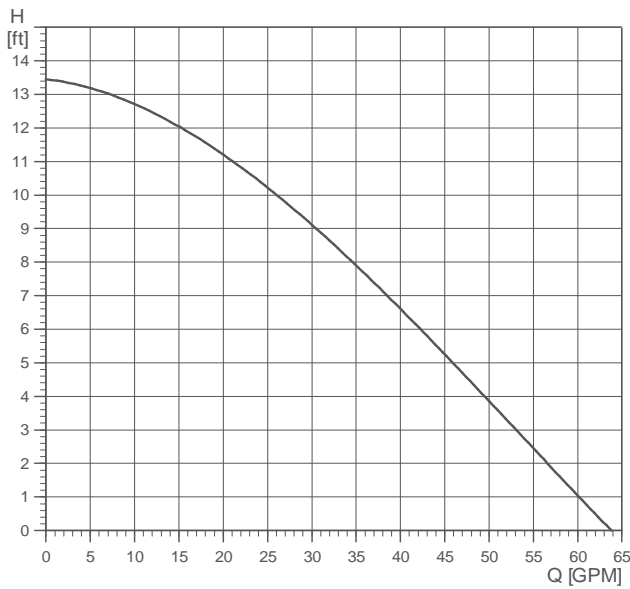

TIM03 5558 3806

Flow range: 0-68 gpm
 Head range: 0-13.5 feet
 Motors: 2-pole, single-phase
 Max. liquid temperature: 230 °F (110 °C)
 Min. liquid temperature: 32 °F (0 °C)
 Max. system pressure: 145 psi (10 bar)
 Closed system (F) and open system (BF)

Model	Volts	Amps	Watts	Hp	Capacitor
UP 43-44 F/BF	115	2.15	215	1/6	10µF/180 V
	230	1.07	220	1/6	2.5µF/380 V

Approvals



UP 43-44 F/BF

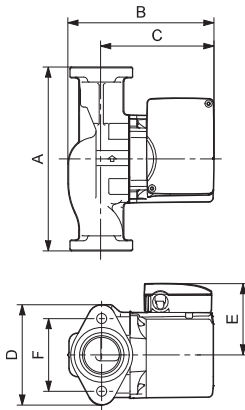

TIM03 8544 1907

Model type	Product number		Dimensions [inches]						Connection type and size	Shipping weight [lbs]
	115 V	230 V	A	B	C	D	E	F		
UP 43-44 F	52722437	52722438	8 1/2	6 11/16	5 3/16	4 3/4	3 1/2	3 7/16	GF 40/43 flange (2) 1/2" dia. bolt holes	13 1/2
UP 43-44 BF	52722439	52722440	8 1/2	6 11/16	5 3/16	4 3/4	3 1/2	3 7/16	GF 40/43 flange (2) 1/2" dia. bolt holes	15

Note: Dimensions in inches unless otherwise noted.

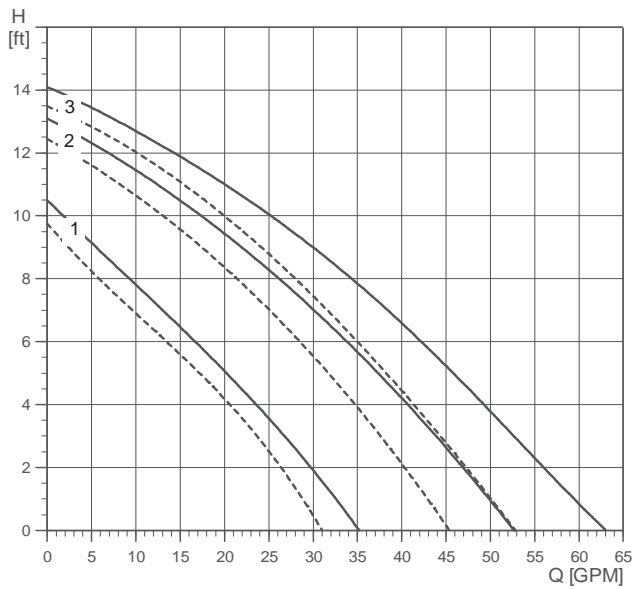

TM03 8196 0807

Flow range: 0-63 gpm
 Head range: 0-14 feet
 Motors: 2-pole, single-phase
 Max. liquid temperature: 230 °F (110 °C)
 Min. liquid temperature: 32 °F (0 °C)
 Max. system pressure: 145 psi (10 bar)

Model	Spd	Volts	Amps	Watts	Hp	Capacitor
UPS 43-44 FC/BFC	3		1.8	203	1/6	20µF/180 V
	2	115	1.7	189	1/6	20µF/180 V
	1		1.4	157	1/6	20µF/180 V
UPS 43-44 FC/BFC	3		0.9	203	1/6	5µF/400 V
	2	230	0.8	190	1/6	5µF/400 V
	1		0.7	157	1/6	5µF/400 V

— Without check valve

- - - With check valve

UPS 43-44 FC/BFC

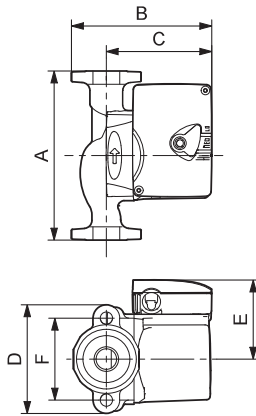

TM03 8757 2407

Approvals



Model type	Product number		Dimensions [inches]						Connection type and size	Shipping weight [lbs]
	115 V	230 V	A	B	C	D	E	F		
UPS 43-44 FC	52722514	52722515	8 1/2	6 11/16	5 1/8	4 3/4	3 3/16	3 7/16	GF 40/43 flange (2) 1/2" dia. bolt bores	13 1/2
UPS 43-44 BFC	52722520	52722521	8 1/2	6 11/16	5 1/8	4 3/4	3 3/16	3 7/16	GF 40/43 flange (2) 1/2" dia. bolt bores	13 1/2

Note: The check valve can be removed.
 Dimensions in inches unless otherwise noted.

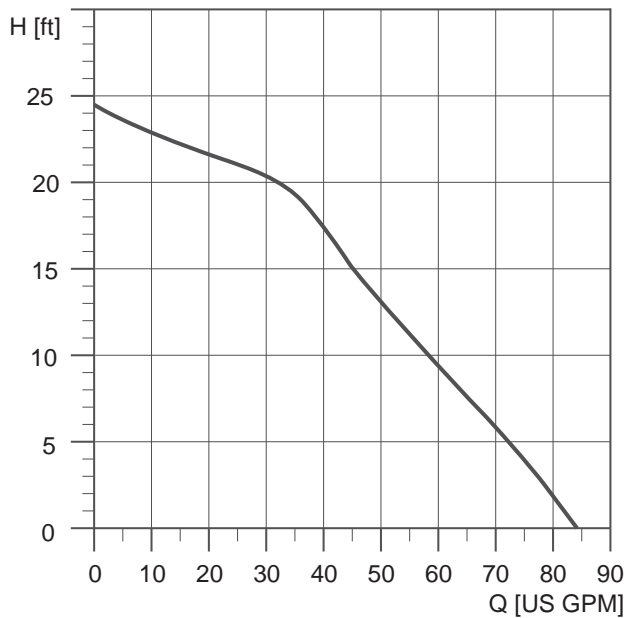

TM04 9904 0211

Flow range: 85 gpm
 Head range: 24.5 feet
 Motors: 2-pole, single-phase
 Max. liquid temperature: 230 °F (110 °C)
 Min. liquid temperature: 14 °F (-10 °C)
 Max. system pressure: 145 psi (10 bar)
 Closed system

Model	Volts	Amps	Watts	Hp	Capacitor
UP 43-70 F	115	3.4	400	1/2	30µF
	230	1.8	400	1/2	30µF

UP 43-70 F

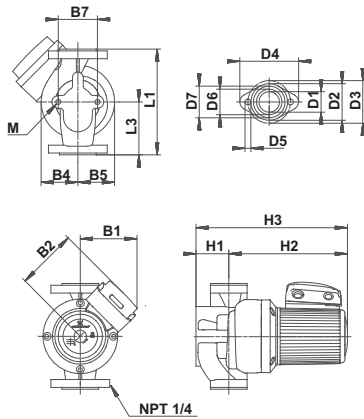

TM02 0210 0211

Model type	Product number	Connection type and size	Shipping weight [lbs]
	115 / 230 V		
UP 43-70 F	96439644	GF 40/30 flange 1 1/2" 2 bolt with (2) 1/2" dia. holes	41

Dimensions [inches]

L1	L3	B1	B2	B4	B5	B7	H1	H2	H3	D1	D2	D3	D4	D6	D7
8 1/2	4 1/4	5 5/16	5 9/16	2 15/16	2 15/16	3 1/8	2 5/8	9 5/8	12 3/16	1 5/8	2 5/16	3 7/16	4 3/4	2	2 1/2

Note: Dimensions in inches unless otherwise noted.

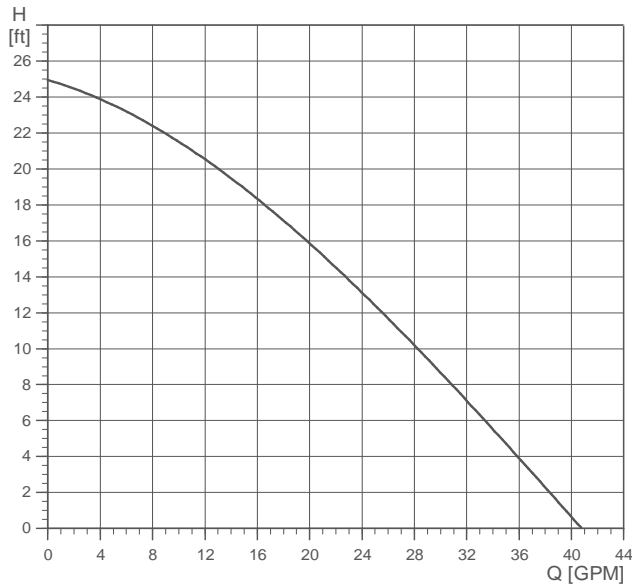

TM03 5560 0907

Flow range: 0-41 gpm
 Head range: 0-25 feet
 Motors: 2-pole, single-phase
 Max. liquid temperature: 230 °F (110 °C)
 Min. liquid temperature: 36 °F (2 °C)
 Max. system pressure: 145 psi (10 bar)
 Open system

Model	Volts	Amps	Watts	Hp	Capacitor
UP 43-75 F/BF	115	2.15	215	1/6	10µF/180 V
	230	1.07	220	1/6	2.5µF/380 V

Approvals



UP 43-75 F/BF

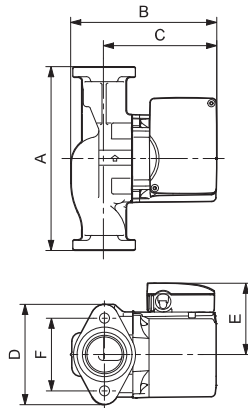

TM03 8544 1907

Model type	Product number		Dimensions [inches]						Connection type and size	Shipping weight [lbs]
	115 V	230 V	A	B	C	D	E	F		
UP 43-75 F	52722373	52722372	8 1/2	6 11/16	5 3/16	4 3/4	3 1/2	3 7/16	GF 40/43 flange (2) 1/2" dia. bolt holes	13 1/2
UP 43-75 BF	52722370	52722369	8 1/2	6 11/16	5 3/16	4 3/4	3 1/2	3 7/16	GF 40/43 flange (2) 1/2" dia. bolt holes	15

Note: Dimensions in inches unless otherwise noted.

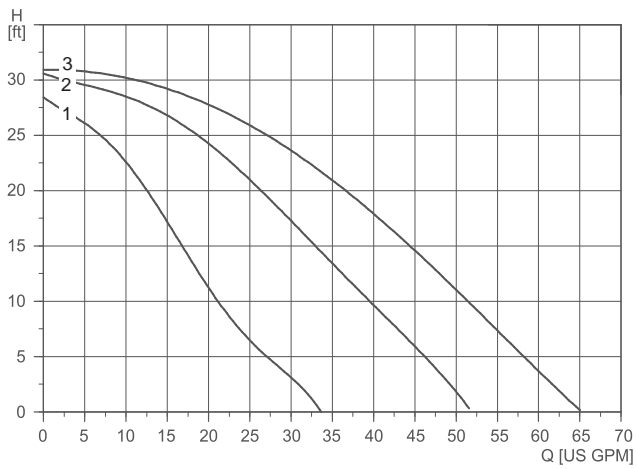

TM04 5464

Flow range: 0-65 gpm
 Head range: 0-31 feet
 Motors: 2-pole, single-phase
 Max. liquid temperature: 230 °F (110 °C)
 Min. liquid temperature: 36 °F (2 °C)
 Max. system pressure: 145 psi (10 bar)

UPS 43-100 F/SF

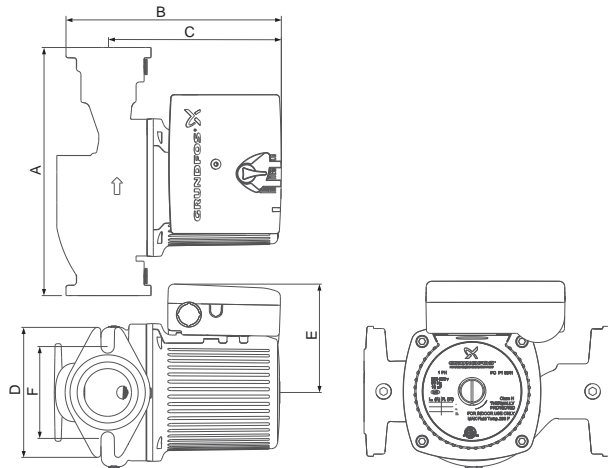

TM04 6015

Model	Spd	Volts	Amps	Watts	Hp	Capacitor
UPS 43-100 F/SF	3	115	3.5	370	1/6	40µF/180 V
	2		3.1	335	1/6	40µF/180 V
	1		2.5	265	1/6	40µF/180 V
UPS 43-100 F/SF	3	208	1.7	350	1/6	10µF/400 V
	2		1.5	310	1/6	10µF/400 V
	1		1.2	250	1/6	10µF/400 V
	3	230	1.7	370	1/6	10µF/400 V
	2		1.5	335	1/6	10µF/400 V
	1		1.2	265	1/6	10µF/400 V

Approvals



Model type	Product number		Dimensions [inches]						Connection type and size	Shipping weight [lbs]
	115 V	208 - 230 V	A	B	C	D	E	F		
UPS 43-100 F	95906636	95906637	8 1/2	7 3/8	5 7/8	4 1/2	3 3/4	3 1/8	GF 40/43 flange (2) 1/2" dia. bolt bores	18.47
UPS 43-100 SF	95906638	95906639								

Note: Dimensions in inches unless otherwise noted.

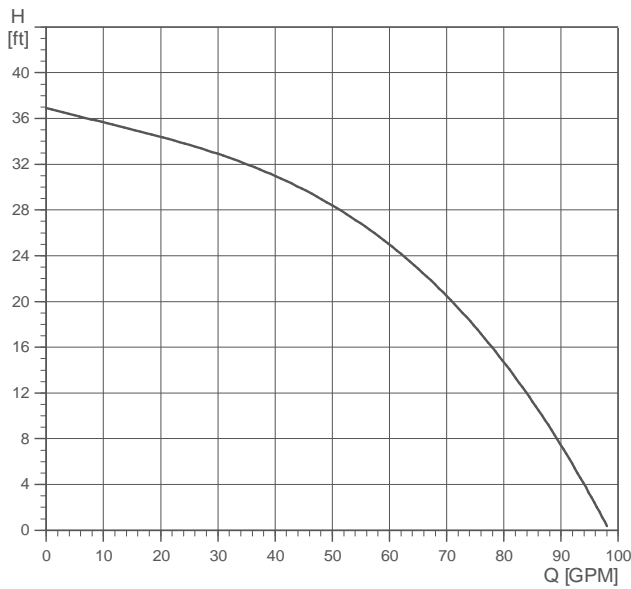

Flow range: 0-98 gpm
 Head range: 0-37 feet
 Motors: 2-pole, single-phase
 Max. liquid temperature: 230 °F (110 °C)
 Min. liquid temperature: 14 °F (-10 °C)
 Max. system pressure: 145 psi (10 bar)
 Closed system

Model	Volts	Amps	Watts	Hp	Capacitor
UP 43-110 F	115	5.1	590	3/4	60µF
	230	2.7	590	3/4	60µF

Approvals



UP 43-110 F

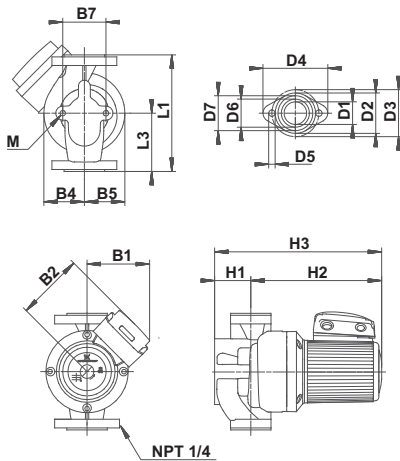

TM03 5951 3806

TM02 0120 4301

Model type	Product number	Connection type and size	Shipping weight [lbs]
	115 V / 230 V		
UP 43-110 F	96439643	GF 40/43 Flange 1 1/2"	41.2

Dimensions [inches]

L1	L3	B1	B2	B4	B5	B7	H1	H2	H3	D1	D2	D3	D4	D6	D7	M
8 1/2	4 1/4	5 1/4	5 9/16	2 15/16	2 15/16	3 1/8	2 5/8	9 5/8	12 3/16	1 5/8	2 15/16	3 7/16	4 3/4	2 1/16	2 1/2	12 mm

Dimensions in inches unless otherwise noted.

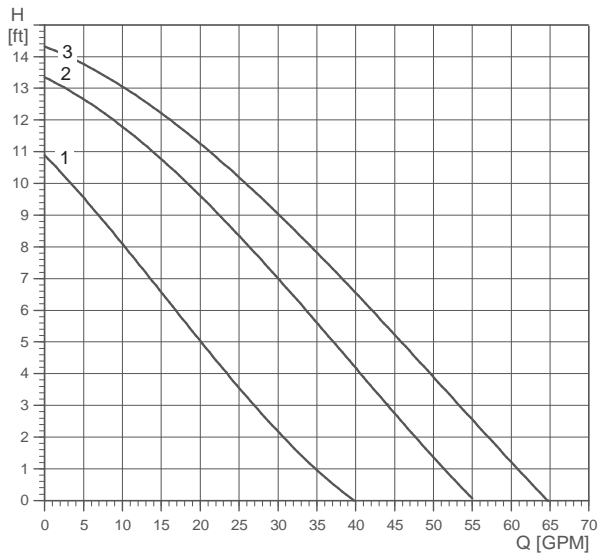

TM03 8837 2607

Flow range: 0-65 gpm
 Head range: 0-14.4 feet
 Motors: 2-pole, single-phase
 Max. liquid temperature: 230 °F (110 °C)
 Min. liquid temperature: 32 °F (0 °C)
 Max. system pressure: 145 psi (10 bar)

Model	Spd	Volts	Amps	Watts	Hp	Capacitor
UPS 50-44 F	3	115	1.7	194	1/6	20µF
	2		1.6	181	1/6	
	1		1.3	147	1/6	
	3	230	0.87	195	1/6	5µF
	2		0.81	182	1/6	
	1		0.74	147	1/6	

Approvals



UPS 50-44 F

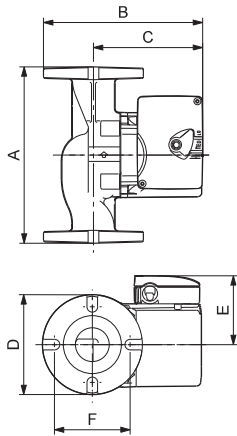

TM04 54713209

Model type	Product number		Dimensions [inches]						Connection type and size	Shipping weight [lbs]
	115 V	230 V	A	B	C	D	E	F		
UPS 50-44 F	52722557	52722558	8 1/2	7 1/2	5 1/16	4 7/8	3 1/2	4 1/6	GF 50 flange (4) 1/2" dia. bolt holes	15 1/2

Note: Dimensions in inches unless otherwise noted.

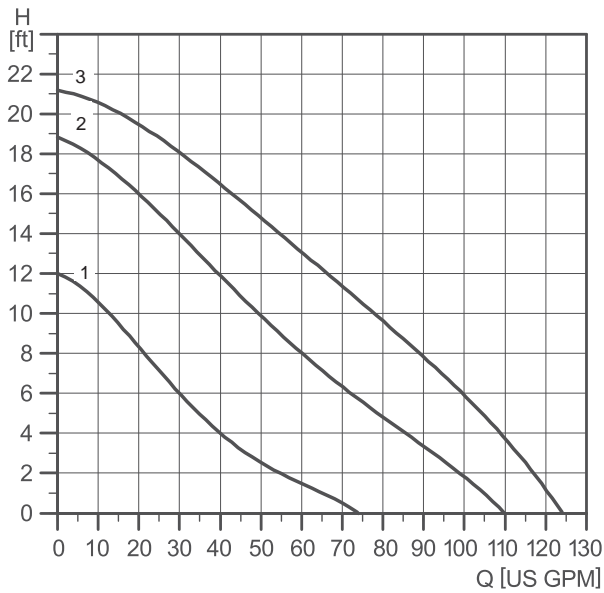

TM04 7918 2410

Flow range: 120 gpm
 Head range: 21 feet
 Motors: 2-pole, single-phase
 Max. liquid temperature: 230 °F (110 °C)
 Min. liquid temperature: 36 °F (10 °C)
 Max. system pressure: 145 psi (10 bar)
 Closed or Open system

Model	Spd	Volts	Amps	Watts	Hp	Capacitor
UPS 50-60 F/SF	3		3.6	395	1/6	40µF/180V
	2	115	3.4	350	1/6	
	1		2.7	260	1/6	
UPS 50-60 F/SF	3		1.9	395	1/6	10µF/400V
	2	208	1.7	350	1/6	
	1		1.4	290	1/6	
	3		1.8	395	1/6	
	2	230	1.7	350	1/6	
	1		1.4	260	1/6	

UPS 50-60 F/SF

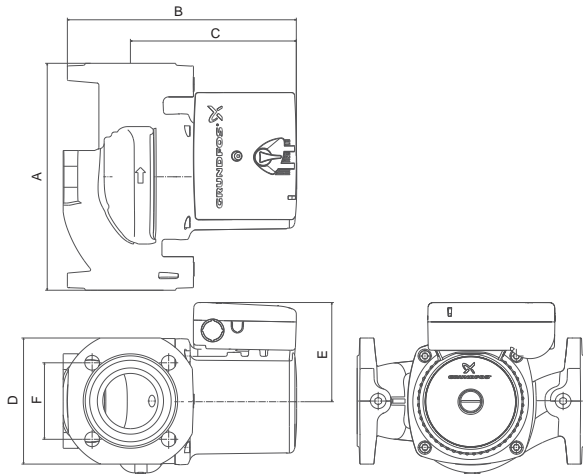

TM04 9775 0111

Approvals



Model type	Product number		Dimensions [inches]						Connection type and size	Shipping weight [lbs]
	115 V	208 - 230 V	A	B	C	D	E	F		
UPS 50-60 F	97523134	—								20
UPS 50-60 F	—	97523135	8 1/2	8 5/8	6 1/4	4 3/4	3 3/4	2 7/8	GF 50	20
UPS 50-60 SF	97523136	—								19.5
UPS 50-60 SF	—	97523137								19.5

Note: Dimensions in inches unless otherwise noted.

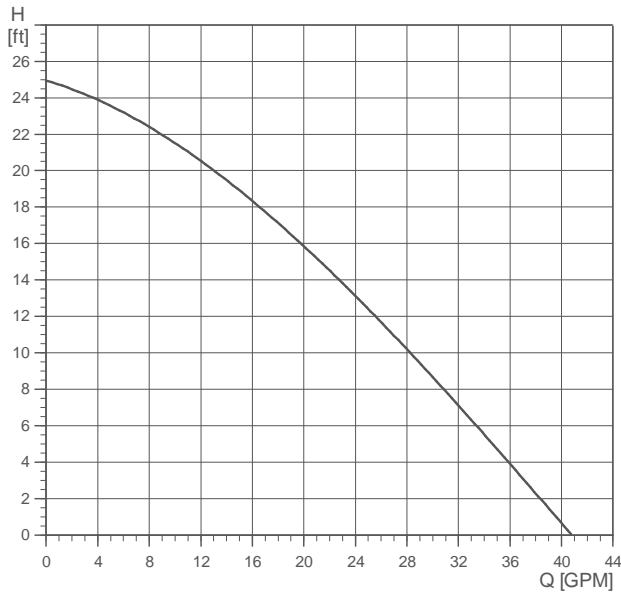

Flow range: 0-41 gpm
 Head range: 0-25 feet
 Motors: 2-pole, single-phase
 Max. liquid temperature: 230 °F (110 °C)
 Min. liquid temperature: 32 °F (0 °C)
 Max. system pressure: 145 psi (10 bar)
 Closed system

Model	Volts	Amps	Watts	Hp	Capacitor
UP 50-75 F	115	2.15	215	1/6	10µF/180 V
	230	1.07	220	1/6	2.5µF/400 V

Approvals



UP 50-75 F

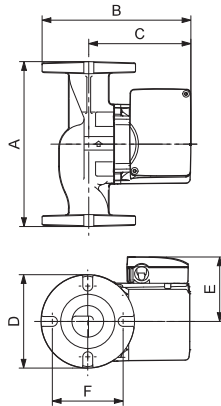

TM03 5545 0907

TM03 8760 2407

Model type	Product number		Dimensions [inches]						Connection type and size	Shipping weight [lbs]
	115 V	230 V	A	B	C	D	E	F		
UP 50-75 F	52722352	52722353	8 1/2	7 1/2	5 1/16	4 7/8	3 1/2	4 1/6	GF 50 flange (4) 1/2" dia. bolt holes	15 1/2

Note: Dimensions in inches unless otherwise noted.

This page intentionally left blank.

UP timer

Specifications (previous/current)

Type: 24 Hr. 3-position On/Timer/Off 15-minute interval

- Size: 3.77 x 2.85 x 1.25"
- Supply voltage: 120 VAC
- Power consumption: 1 VA

Switch rating: SPDT

- Resistive: 21A/6 A
- Tungsten: 1350 W.
- Inductive: 1 HP @ 120 VAC; 2 HP @ 240 VAC

Wiring connections: 1/4" quick-connects.

Installation

Indoor, wired and mounted on the UP terminal box.

Features

- Compact and contemporary design.
- Captive trippers are easy to set, cannot be lost.
- Quartz drive provides 7-day carry-over.
- Synchronous drive for greatest accuracy, lowest cost

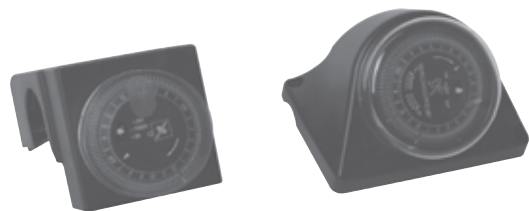

TM03 7883 0307

Previous timer
Date codes 9132-0527

Current timer
Date codes 0528 and after

Fig. 1 UP timers

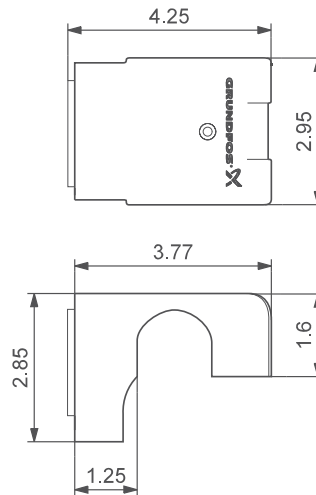
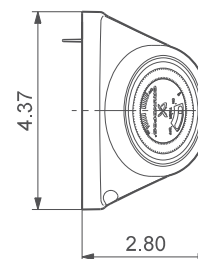
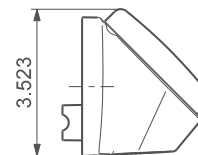

Fig. 2 Timer dimensions, previous version



TM03 4406 3507

TM03 9076 3307

Fig. 3 Timer dimensions, current version

Timer control

Product number	Description	Shipping weight	Length		Height		Width	
		[oz.]	[mm]	[inch]	[mm]	[inch]	[mm]	[inch]
505474	24-hour programmable clock/timer for use with single speed. Series UP (115 V) circulator* for date codes 9132 - 0527	10	62	2 7/16	32	1 17/64	60	2 3/8
599388	24-hour programmable clock/timer for use with single speed. Series UP (115 Vt) circulator* for UP 15 only date code 0528 and after	10	62	2 7/16	32	1 17/64	60	2 3/8

Approvals



AquaStat

Specifications

Description: Thermostatic switch.

Type: Bi-metallic disc, snap acting.

Enclosure: environmentally sealed.

Mounting:

- Clip-on mount for 1/2" I.D. copper tube (5/8" O.D.).
- Clip-on mount for 3/4" I.D. copper tube (7/8" O.D.).

Contact rating:

- 10 A @ 120 VAC, 60 Hz resistive.
- 5 A @ 240 VAC, 60 Hz resistive.

Temperature rating

Low-temp model

- 105±5 °F (40±2 °C) pump switches off.
- 85±6 °F (29±3 °C) pump switches on.

High-temp model

- 115±5 °F (46±2 °C) pump switches off.
- 105±5 °F (40±2 °C) pump switches on.

Leads:

- 2 leads, AWG 18, 14".
- 12", black insulation, silicon or epoxy overmold.
- 1/2" strip length.

Application:

- Clip-on thermostatic control for the UP circulators.

Approvals

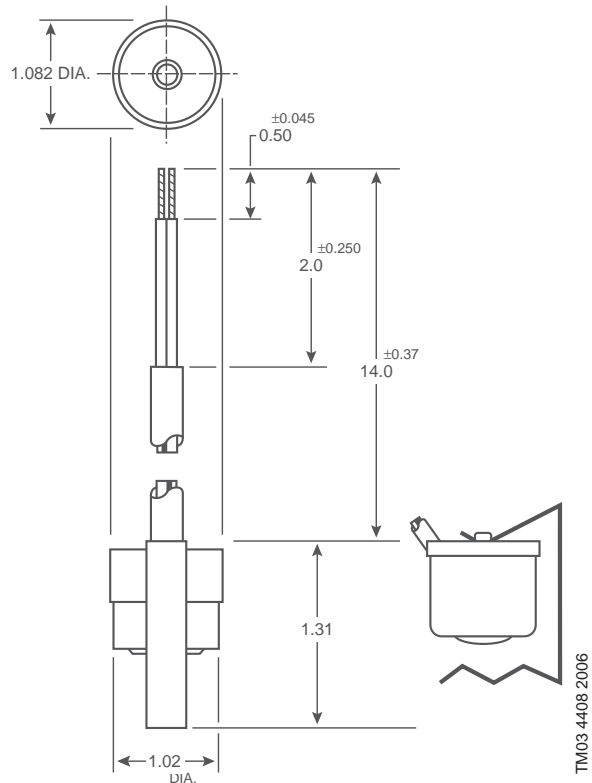

Fig. 4 AquaStat dimensions

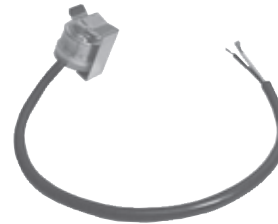

Fig. 5 AquaStat

Thermostatic controls

Product number	Description	Shipping weight [oz.]
595443	Aquastat set, 1/2" clip-on mount for 5/8" O.D. system piping size, 85 °F - 105 °F* (1/2" I.D. copper tubing or 3/8" steel pipe) shielded wire, with PVC jacketed cable	1 lb
595444	Aquastat set, 3/4" clip-on mount for 7/8" O.D. system piping size, 85 °F - 105 °F* (3/4" I.D. copper tubing or 1/2" steel pipe) shielded wire, with PVC jacketed cable	1 lb
595656	Aquastat set, 1/2" clip-on mount for 5/8" O.D. system piping size, 105 °F - 115 °F* (1/2" I.D. copper tubing or 3/8" steel pipe) shielded wire, with PVC jacketed cable	1 lb
595657	Aquastat set, 3/4" clip-on mount for 7/8" O.D. system piping size, 105 °F - 115 °F* (3/4" I.D. copper tubing or 1/2" steel pipe) shielded wire, with PVC jacketed cable	1 lb

Note: Dimensions in inches unless otherwise noted.

Pump Zone Controls

Specifications

Grundfos Zone Controls are non-networked devices intended to be used for circulator and boiler control in hydronic heating systems.

- One, three, and four - expandable to six zones
- Powder coated panel surface
- Multi-panel linking capability
- Selectable priority and freeze protection
- Single service relay for all models
- 2-wire with one 3-wire thermostat capability
- Automatic reset PTC fuse on system 24 VAC
- High capacity 25VA rated transformer
- Multiple knockouts
- Separate X-X & ZC-ZR terminals for “Cold Start” or “Tankless Coil” boilers
- Models UPZC-3 & UPZC-4/6 only:
 - No priority
 - Zone 1 priority
 - Zone 1 priority w/ 1-hour freeze protection

Model	Dimensions [in]		
	L	W	D
UPZC-1	5.2	4.3	2.9
UPZC-3, 4/6	9.8	12.1	2.9

Note: Dimensions in inches unless otherwise noted.

Model	UPZC-1	UPZC-3	UPZC-4/6
Part number	96741787	96741788	96741789
Number of zones	1	3	4 to 6
Priority feature	No	Yes	Yes
Priority timer (min.)	N/A	60	60
Input power 60 hz	120VAC +/- 10%		
Transformer voltage	120VAC, 24V, 15VA, Class 2		
Thermostat output (amps)	0.13A		
Max. single phase motor rating (per zone)	1/3Hp, 10A, GP		
Max. combined load rating: Output @ 120VAC (amps)	10A	30A	
Min./max. ambient temperature range	32 °F (0 °C) / 104 °F (40 °C)		
Max. operating humidity range: % RH	0.95		
Number of knockouts	4	14	
Size of knockouts (in.)	7/8-inch		
UPZC dimensions: W x H x D (in.)	5-3/16 x 4-5/15 x 2-15/16	15 x 11-3/8 x 4-7/8	
Relay type	DPDT Socketed		
Approvals	UL-873, CAN/CSA C22.2 No. 24		

Universal service relay

Part number: 10 ea.	96741790
---------------------	----------

Approvals



TM04 9906 0311 - TM04 9907 0311

Fig. 1 Grundfos Zone Controls (with closeup of circuit board)

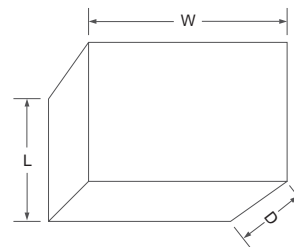

TM04 9908 0311

Packaged dielectric isolation valve sets

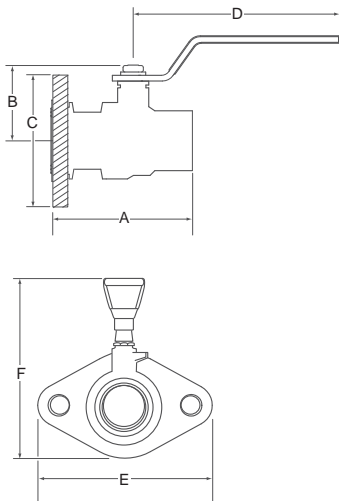

TM04 9909 0311



TM03 7901 0307

Pump connection	Pipe connection type and size		Material number	Approx. shipping weight [lb/oz.] 1 kit	Face to face [A*]	Center of port to top [B*]	Flange diameter [C*]	Center of valve to handle end [D*]
	NPT	Solder			[inch]	[mm / inch]	[inch]	[inch]
GF 15/26 flange	Bronze	1/2"	96806129	2 / 13	2 27/32	51 / 2	4 3/16	3 29/64
		3/4"	96806130	3 / 2	3 3/64	57 / 2 1/4	4 3/16	3 3/4
		1"	96806131	4 / 8	3 35/64	67 / 2 21/32	4 3/16	4 17/32
		1-1/4"	96806132	4 / 13	4 1/32	75 / 2 31/32	4 3/16	4 35/64
		1-1/2"	96806133	4 / 14	4 7/64	75 / 2 31/32	4 3/16	4 5/8
	Steel	1/2"	96806134	2 / 12	2 49/64	51 / 2	4 3/16	3 15/32
		3/4"	96806135	3 / 4	3 1/4	57 / 2 1/4	4 3/16	3 47/64
		1"	96806136	4 / 8	3 55/64	67 / 2 21/32	4 3/16	4 1/2
		1-1/4"	96806137	4 / 13	4 1/2	75 / 2 31/32	4 3/16	4 35/64
		1-1/2"	96806138	4 / 15	4 37/64	75 / 2 31/32	4 3/16	4 9/16

Note: Each set contains
 2 each - rotating flanges, lever-handled full-ported ball valve, EPDM gaskets, dielectric sleeves.
 4 each - 7/16" X 1-3/4" bolts with nuts.
 Dimensions in inches unless otherwise noted.

Materials of construction	
Flange	Chrome plated steel
Valve body	Brass
Valve ball	Chrome plated brass
Valve seat	PTFE
Dielectric sleeve	Composite
Bolt	Chrome plated steel
Nut	Chrome plated steel
Gaskets	EPDM
Maximum temperature	230 °F (110 °C)
Maximum pressure	150 psi

Approvals

IAPMO - #6591

Packaged fitting sets

GF 15/26/40/43

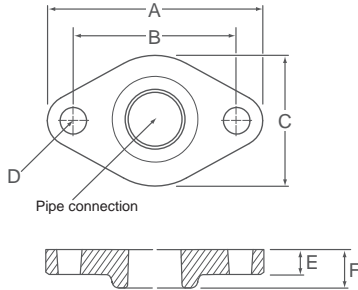

TM04 9808 0111

GF 50

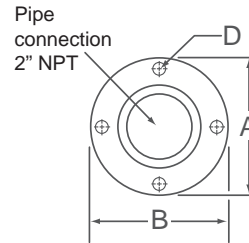

TM04 9810 0111

GU 125 Union

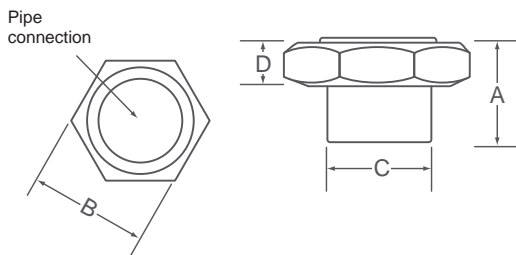

TM04 9809 0111

Isolation Valve GU 125 Union

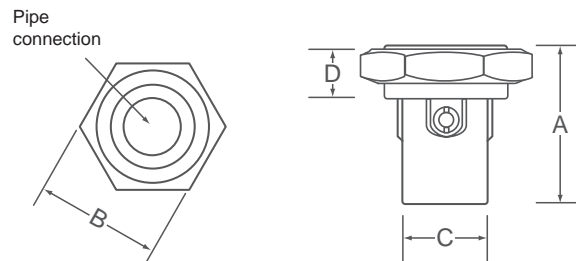

TM04 9811 0111

Material	Pump Connection	Pipe Connection			Material Number	Dimensions (in. / mm)					
		NPT	Solder	Compression		A	B	C	D	E	F
Cast Iron	GF15/26	3/4"			519601						
		1"			519602						
		1-1/4"			519603	4-1/4 / 106	3-1/8 / 80	2-3/4 / 67	1/2 / 13	1/2 / 13	3/4 / 20
		1-1/2"			519604						
		1-1/2"			539605	4-3/4 / 120	3-1/2 / 87	3 / 74	1/2 / 13	1/2 / 13	3/4 / 20
Bronze	GF50 (4-bolt flange)	2"			96409354	5-1/4 / 133	4 / 103	-	1/2 / 14	1/2 / 13	3/4 / 20
		3/4"			519651						
		1"			519652	4-1/4 / 106	3-1/8 / 80	2-3/4 / 67	1/2 / 13	1/2 / 13	3/4 / 20
		1-1/4"			96409356						
		1-1/2"			539615	4-3/4 / 120	3-1/2 / 87	3 / 74	1/2 / 13	1/2 / 13	3/4 / 20
Isolation Valves Bronze	GU 125 Union	2"			96409355	5-1/4 / 133	4 / 103	-	1/2 / 14	1/2 / 13	3/4 / 20
		3/4"			529912	1 / 25	1-7/8 / 46	1-1/4 / 31	5/8 / 16	-	-
		1/2"		1/2"	529913	3/4 / 20	1-7/8 / 46	3/4 / 20	5/8 / 16	-	-
		3/4"		3/4"	529911	3/4 / 20	1-7/8 / 46	1 / 26	5/8 / 16	-	-
		1/2"			519850	2-1/4 / 57	1-7/8 / 46	1 / 25	5/8 / 16	-	-
Isolation Valves Bronze	GU 125 Union	3/4"			519852	2-1/4 / 57	1-7/8 / 46	1-1/4 / 31	5/8 / 16	-	-
		3/4"		3/4"	519851	2 / 51	1-7/8 / 46	1-1/4 / 31	5/8 / 16	-	-

Notes:

GF15/26/40/43 Flange sets to include two flanges, two gaskets, and four nuts and bolts.

GF50 Flange sets to include two flanges, two gaskets, and eight nuts and bolts.

GU 125 Union Union set to include two nuts, gaskets, and adapters.

Dimensions are in inches unless otherwise noted.

Approvals (Bronze sets)

IAPMO - #6591

UP-ZV zone valves

Specifications

Grundfos UP-ZV 24V, 2-way motorized zone valves for hydronic heating or chilled water applications.

Standard features

- In-line removable actuator for ease of installation and service
- manual open/close lever
- sealed end switch
- silent close-of technology
- high gear ratio
- forged brass body
- removable service cap
- high Cv rating.

Approvals



TM04 9803 0111

Technical data

Max. percent glycol:	50 %
Fluid temp. range:	32 to 240 °F (0 to 115 °C)
Ambient temp. range:	32 to 104 ° F (0 to 40 °C)
Max. humidity:	95 % non-condensing
Max. static pressure:	15 psi (1 bar) steam
	300 psi (20 bar)
Stroke time	Open: approx. 45 sec.
	Closed: approx. 10 sec.
Actuator motor	
Actuator motor:	Synchronous hysteresis
Class:	Class A
Voltage:	24-VAC +/- 10 %, Class 2
	5 Watts
	7 VA
Run amps:	300 ma
In-rush:	300 ma
End (auxiliary) switch models	
Type:	Sealed
De-energized position:	Normally closed
Rating:	0.4A (400 mA) @ 24 VAC (AC/DC)
	Class 2
Isolated:	Yes

Valves

Valve operation:	With power: opened
	Without power: closed
	Manually opened: opened

Materials of construction

Valve body:	Brass
Seat:	Brass
Stem:	Stainless steel
Paddle:	EPDM
O-rings:	EPDM

UP-ZV flow characteristics

Connection size	Flow Coefficient	Max. Close-off ΔP
1/2-inch Sweat	3.5 Cv (3.0 Kv)	30 psi (207 kPa)
3/4-inch Sweat	7.5 Cv (6.5 Kv)	20 psi (138 kPa)
1-inch Sweat	7.5 Cv (6.5 Kv)	20 psi (138 kPa)
3/4-inch NPT	3.5 Cv (3.0 Kv)	30 psi (207 kPa)

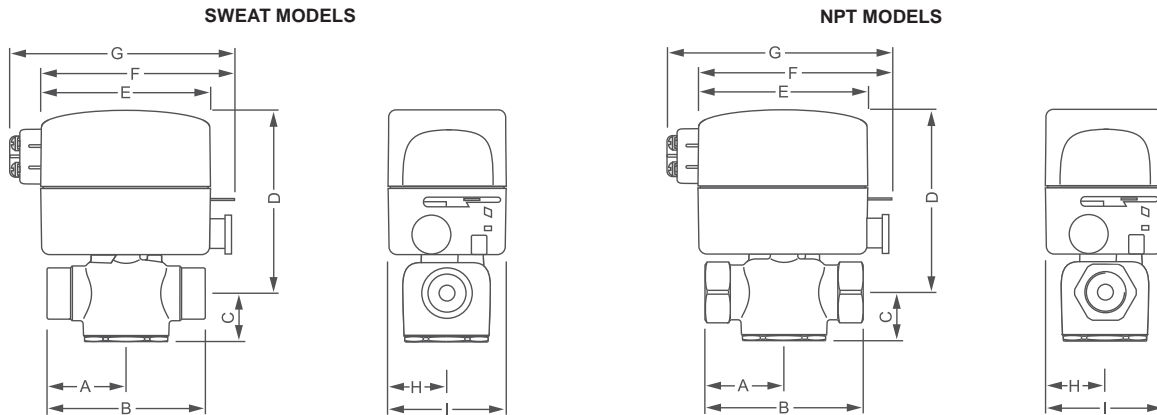

TM04 9804 0111

Connections	Dimensions [inches]								
	A	B	C	D	E	F	G	H	I
1/2-inch Sweat	1 5/16	2 5/8	15/16	4	3 7/16	4	4 17/32	1 3/16	2 3/8
3/4-inch Sweat	1 3/8	2 5/8		4 3/16					
1-inch Sweat	1 11/16	2 5/8							
3/4-inch NPT	1 13/16	2 5/8							

Note: Dimensions for actuators with or without auxiliary switch.

Product number	Description
97627415	1/2-inch Sweat, 2-way Valve Body, Normally Closed, with End Switch
97627416	1/2-inch Sweat, 2-way Valve Body, Normally Closed, without End Switch
97627419	3/4-inch Sweat, 2-way Valve Body, Normally Closed, with End Switch
97627420	3/4-inch Sweat, 2-way Valve Body, Normally Closed, without End Switch
97627421	1-inch Sweat, 2-way Valve Body, Normally Closed, with End Switch
97627422	1-inch Sweat, 2-way Valve Body, Normally Closed, without End Switch
97627417	3/4-inch NPT, 2-way Valve Body, normally Closed, with End Switch
97627418	3/4-inch NPT, 2-way Valve Body, normally Closed, without End Switch

Service

Product number	Description
97627423	Actuator 24-VAC, Normally Closed with End Switch
97627424	Actuator 24-VAC, Normally Closed without End Switch

Replacement flange gaskets

For use with flange set	Material number	Description	Shipping weight [oz.]
GF 15/26	510179	Single gasket for 1-1/4" flange	4
GF 40/43	530244	Single gasket for 1-1/2" flange	4
GF 50	96409353	Single gasket for 2" flange	4
GF 65	550097	Single gasket for 2-1/2" flange	4
GF 80	560185	Single gasket for 3" flange	4
GF 100	570008	Single gasket for 4" flange	4
GU 125	520089	Single gasket for GU 125 union	4

Submittal data

Company name
Prepared by
Phone number (.....).....
Fax number (.....).....
Date:..... Page 1 of:.....
Quote number:.....

Client information	
Project title:.....	Client name:.....
Reference number:.....	Client number:.....
Client contact:.....	Client phone:.....

Location information			
For:.....	Unit:.....		
Site:.....	Service:.....		
Address:.....	City:.....	State:.....	Zip code:.....

Technical data		Motor information	
Flow (GPM):.....		HP:.....	
Head (Ft).....		Phase:.....	
Motor:.....		Voltage:.....	
Max. liquid temp.:.....		Enclosure:.....	
Min. liquid temp.:.....			
Min. required inlet pressure:.....			
Connection type and size:.....			

Pump information	
Model information from type key and codes:.....	Example: UP-S-15-58-FC.....
Quantity required:.....	NPSH required at duty point:.....
Minimum required flow:.....	

Product guide additional information pages	
Materials page number:.....	Performance curve page number:.....
Technical data page number:.....	Motor data page number:.....

Custom-built pump information (optional):
.....

Additional information:
.....

This page intentionally left blank.

WebCAPS

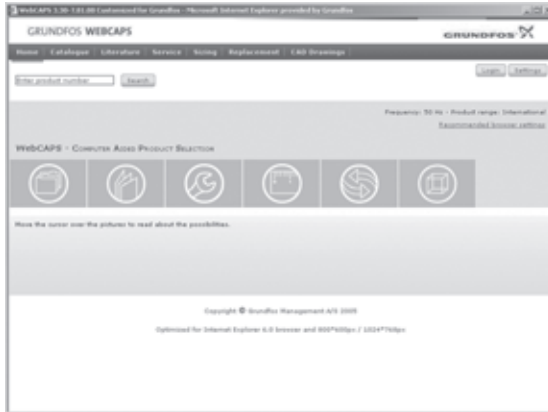

WebCAPS is a **Web-based Computer Aided Product Selection** program available on www.grundfos.com.

WebCAPS contains detailed information on more than 185,000 Grundfos products in more than 20 languages.

In WebCAPS, all information is divided into 6 sections:

- Catalog
- Literature
- Service
- Sizing
- Replacement
- CAD drawings.



Catalog

This section is based on fields of application and pump types, and contains

- technical data
- curves (QH, Eta, P1, P2, etc) which can be adapted to the density and viscosity of the pumped liquid and show the number of pumps in operation
- product photos
- dimensional drawings
- wiring diagrams
- quotation texts, etc.



Literature

In this section you can access all the latest documents of a given pump, such as

- data booklets
- installation and operating instructions
- service documentation, such as Service kit catalog and Service kit instructions
- quick guides
- product brochures, etc.



Service

This section contains an easy-to-use interactive service catalog. Here you can find and identify service parts of both existing and discontinued Grundfos pumps.

Furthermore, this section contains service videos showing you how to replace service parts.

Visit our U.S. website at www.grundfos.us



Sizing

This section is based on different fields of application and installation examples, and gives easy step-by-step instructions in how to

- select the most suitable and efficient pump for your installation
- carry out advanced calculations based on energy consumption, payback periods, load profiles, life cycle costs, etc.
- analyse your selected pump via the built-in life cycle cost tool
- determine the flow velocity in wastewater applications, etc.



Replacement

In this section you find a guide to selecting and comparing replacement data of an installed pump in order to replace the pump with a more efficient Grundfos pump. The section contains replacement data of a wide range of pumps produced by other manufacturers than Grundfos.

Based on an easy step-by-step guide, you can compare Grundfos pumps with the one you have installed on your site. When you have specified the installed pump, the guide will suggest a number of Grundfos pumps which can improve both comfort and efficiency.



CAD drawings

In this section it is possible to download 2-dimensional (2D) and 3-dimensional (3D) CAD drawings of most Grundfos pumps.

These formats are available in WebCAPS:

2-dimensional drawings:

- .dxf, wireframe drawings
- .dwg, wireframe drawings.

3-dimensional drawings:

- .dwg, wireframe drawings (without surfaces)
- .stp, solid drawings (with surfaces)
- .eprt, E-drawings.

WinCAPS



WinCAPS CD-ROM

WinCAPS is a **Windows-based Computer Aided Product Selection** program containing detailed information on more than 185,000 Grundfos products in more than 20 languages.

The program contains the same features and functions as WebCAPS, but is an ideal solution if no Internet connection is available.

WinCAPS is available on CD-ROM and updated once a year.

Visit our U.S. website at www.grundfos.us

Notes

L-UP-PG-001 Rev. 0311

Repl. 1109

US

© 2007, 2009-2010 Grundfos Pumps

The name Grundfos, the Grundfos logo, and the payoff Be-Think-Innovate are registered trademarks owned by Grundfos Management A/S or Grundfos A/S, Denmark. All rights reserved worldwide.

GRUNDFOS Pumps Corporation
17100 West 118th Terrace
Olathe, Kansas 66061
Phone: +1-913-227-3400
Telefax: +1-913-227-3500

GRUNDFOS Canada Inc.
2941 Brighton Road
Oakville, Ontario L6H 6C9 Canada
Phone: +1-905 829 9533
Telefax: +1-905 829 9512

Bombas GRUNDFOS de Mexico S.A. de C.V.
Boulevard TLC No. 15
Parque Industrial Stiva Aeropuerto
Apodaca, N.L. Mexico 66600
Phone: +52-81-8144 4000
Telefax: +52-81-8144 4010

www.grundfos.com

GRUNDFOS 