

Marlow Series Prime Line[®]

SELF-PRIMING CENTRIFUGAL PUMPS TECHNICAL DATA



Prime Line® A Full Range of Product Features

Rugged Construction: Cast iron construction in close coupled and frame mounted design.

Superior Priming: High suction inlet and internal suction check valve keeps more liquid in the casing for faster priming and repriming.

Diffuser Priming: The patented diffuser design allows impeller trim, reduces internal wear and eliminates radial loads.

High Efficiency: Enclosed, trimable impellers provide efficiencies from 60-75% for low energy costs.

Dimensional Interchangeability: Four pump groups allow performance to be changed with replaceable impellers and diffusers.

NOTE:

The various versions of the Prime Line are identified by product code numbers as explained to the right. Note that not all combinations of impeller and motor are possible.

Prime Line® Product Line Numbering System

Example Product Code

M 2P1 A 2 1 B 2 A 0 B C E

Epoxy Coated

CE label energy efficient

Optional Base (close-coupled)

Mechanical Seals

Code	Rotary	Stationary	Elastomers
0	Carbon	Ceramic	BUNA N
1	Carbon	Ceramic	Viton
2	Sil Car	Sil Car	Viton
3	Sil Car	Sil Car	EPR

Impeller Options

	2P1	2P2	2P3	2P4	3P1	3P2	3P3	3P4	4P1	4P2	4E1	6E1	6E2
A	6.88	4.88	5.69	6.88	8.75	5.88	8.06	7	10.63	9	12	11.5	12.5
B	6.5	4.63	5.44	6.63	8.5	5.5	7.69	6.75	10.38	8.75	11.5	11	12
C	6.13	4.38	5.19	6.38	8.25	5.13	7.31	6.5	10.13	8.5	11	10.5	11.5
D	-	4.13	4.94	6.13	8	4.75	6.94	6.25	9.88	8.25	10.5	10	11
E	-	-	-	5.75	7.75	-	-	6	-	-	10	9.5	-

Driver*

- 1 = 1 PH, ODP 6 = 575 V, TEFC
- 2 = 3 PH, ODP 7 = 3 PH, Exp. Proof
- 3 = 575 V, ODP 8 = 575 V, Exp. Proof
- 5 = 3 PH, TEFC 9 = 1 PH, TEFC

Horsepower Rating*

- A = 1½ HP G = 15 HP
- B = 2 HP H = 20 HP
- C = 3 HP J = 25 HP
- D = 5 HP K = 30 HP
- E = 7½ HP M = 40 HP
- F = 10 HP N = 50 HP

Driver: Hertz/RPM*

- 1 = 60 Hz, 3500 RPM 4 = 50 Hz, 2850 RPM
- 2 = 60 Hz, 1750 RPM 5 = 50 Hz, 1450 RPM
- 3 = 60 Hz, 1150 RPM

Shaft Sleeve

- 0 = No Sleeve (E-Series only)
- 2 = 316 Stainless Steel

Impeller Material **

- A = Iron
- S = Stainless Steel (4E1, 6E1)

Pump Size

- 2P1 = 2 x 2-6⅞ 4P1 = 4 x 4-10⅞
- 2P2 = 2 x 2-4⅞ 4P2 = 4 x 4-9
- 2P3 = 2 x 2-5⅛⅙
- 2P4 = 2 x 2-6
- 3P1 = 3 x 3-8¾
- 3P2 = 3 x 3-5⅞
- 3P3 = 3 x 3-8⅛⅙
- 3P4 = 3 x 3-7

Frame Mounted only:

- 4E1 = 4 x 4-12
- 6E1 = 6 x 6-11½
- 6E2 = 6 x 6-12½

Marlow Series

Not used for frame mounted units, use FRM.
FRS for frame mount with 316SS shaft.

* Substitute "FRM" for frame mounted with carbon steel shaft or "FRS" for frame mounted with 316SS shaft (316SS shaft available on frame mounted only).

** Recommended use of "FRS" frame with stainless steel impeller.

Prime Line® Performance Coverage (60 Hz) 2P - 4P

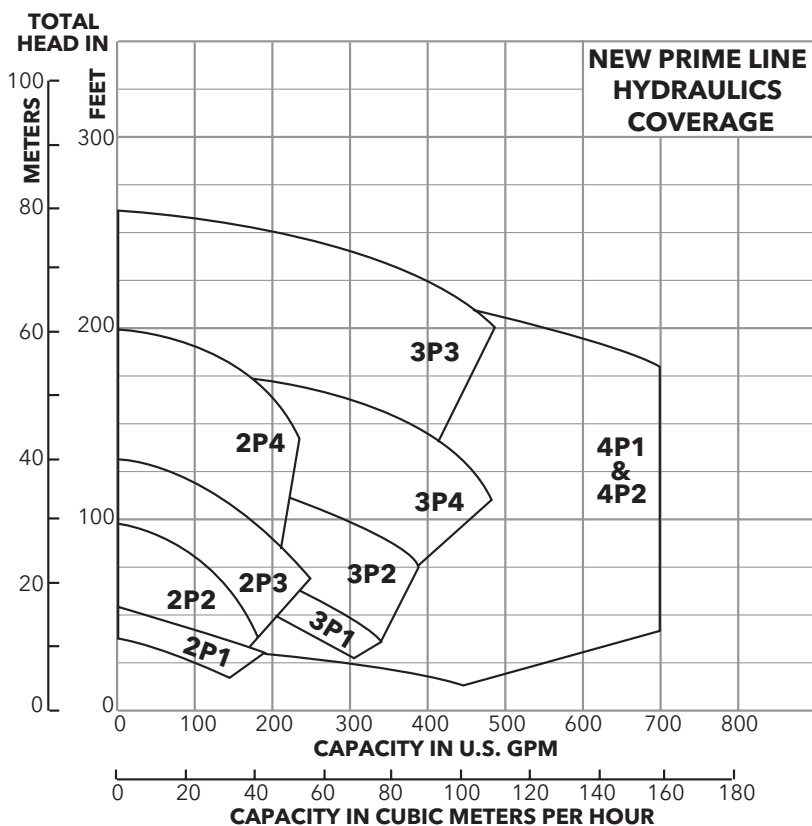

Prime Line® Key Features

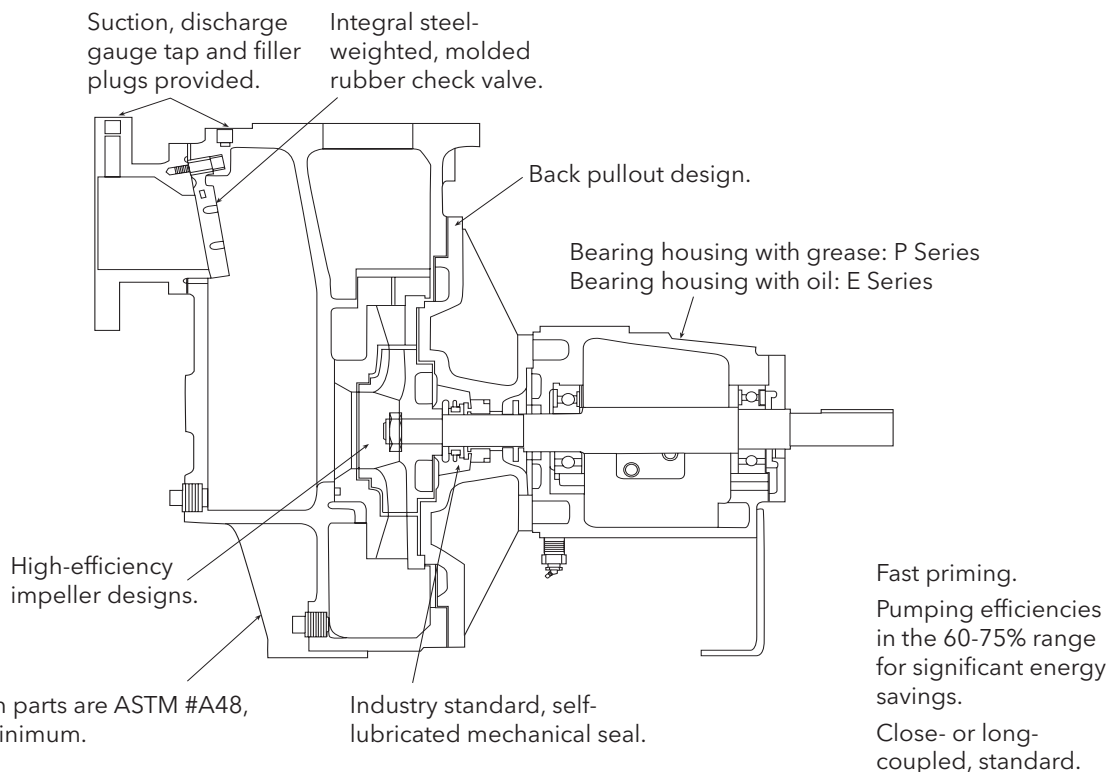

Prime Line® 2P - 4P Close-Coupled Pumps – Materials of Construction

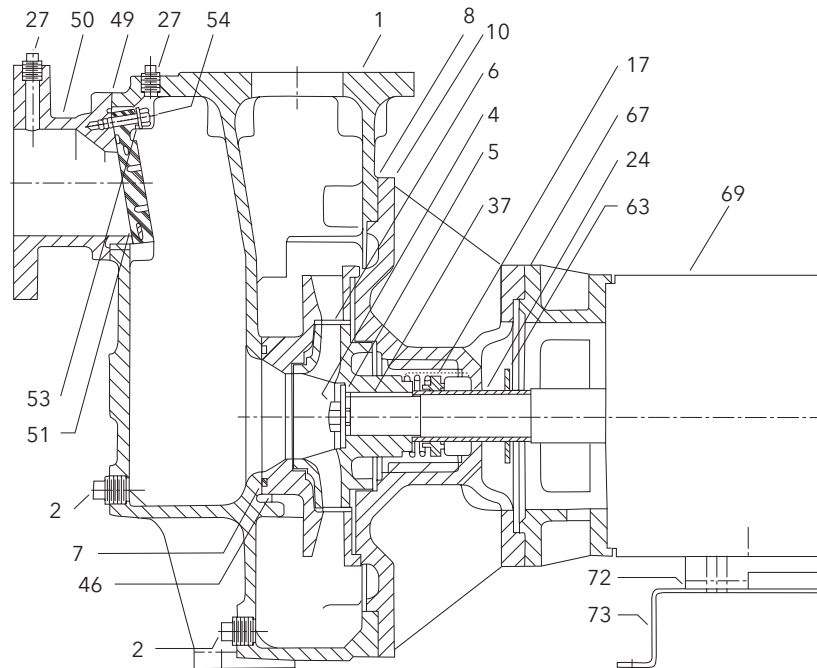

Item No.	Description	Materials
1	Casing	Cast Iron
2	Pipe Plug	Steel
4	Bolt, Impeller	Stainless Steel
5	Washer, Impeller	Stainless Steel
6	Closed Impeller	Cast Iron
7 ^①	O-Ring	BUNA-N
8	Diecut Gasket	Lexide
10	Seal Housing	Cast Iron
17 ^①	Single Mechanical Seal	Miscellaneous
24	Shaft Sleeve	Stainelss Steel
27	Pipe Plug	Steel
37	Impeller Key	Steel

Item No.	Description	Materials
46	Diffuser	Cast Iron
49	Diecut Gasket	Lexide
50	Suction Inlet	Cast Iron
51 ^①	Check Valve	BUNA-N
53	Keeper	Stainless Steel
54	Bolt, Shoulder	Stainless Steel
63	Slinger	Rubber
67	Motor Adapter	Cast Iron
69	Motor (specify)	–
72	Shim	Steel
73	Riser	Steel

① Item Nos. 7, 17 and 51 are available in Viton® as an optional material.

Prime Line® 2P - 4P Frame Mounted Pumps Materials of Construction

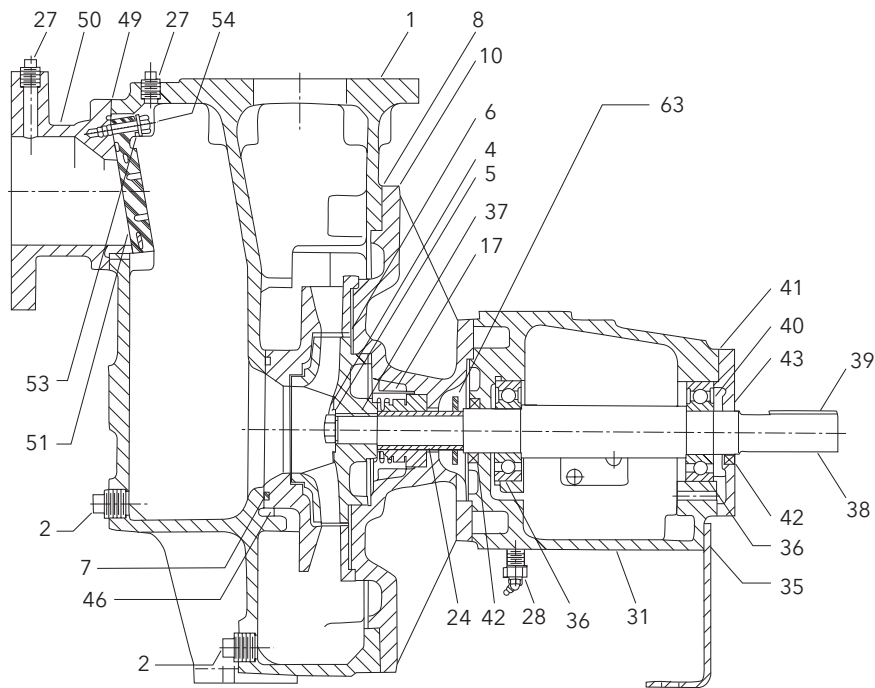

Item No.	Description	Materials
1	Casing	Cast Iron
2	Pipe Plug	Steel
4	Bolt, Impeller	Stainless Steel
5	Washer, Impeller	Stainless Steel
6	Closed Impeller	Cast Iron
7 ^①	O-Ring	BUNA-N
8	Diecut Gasket	Lexide
10	Seal Housing	Cast Iron
17 ^①	Single Mechanical Seal	Miscellaneous
24	Shaft Sleeve	Stainless Steel
28	Grease Fitting	Steel
31	Bearing Housing	Cast Iron
35	Mounting Foot	Steel
36	Bearing	Steel

Item No.	Description	Materials
37	Impeller Key	Steel
38	Shaft	Steel
39	Coupling Key	Steel
40	Bearing Retainer	Steel
41	Diecut Gasket	Steel
42	Lip Seal	BUNA/Steel
43	Bearing Cap	Cast Iron
46	Diffuser	Cast Iron
49	Diecut Gasket	Lexide
50	Inlet Suction	Cast Iron
51 ^①	Check Valve	BUNA-N
53	Keeper	Stainless Steel
54	Bolt, Shoulder	Stainless Steel
63	Slinger	Rubber

^① Item Nos. 7, 17 and 51 are available in Viton as an optional material.

Prime Line® 4E and 6E Pumps – Materials of Construction

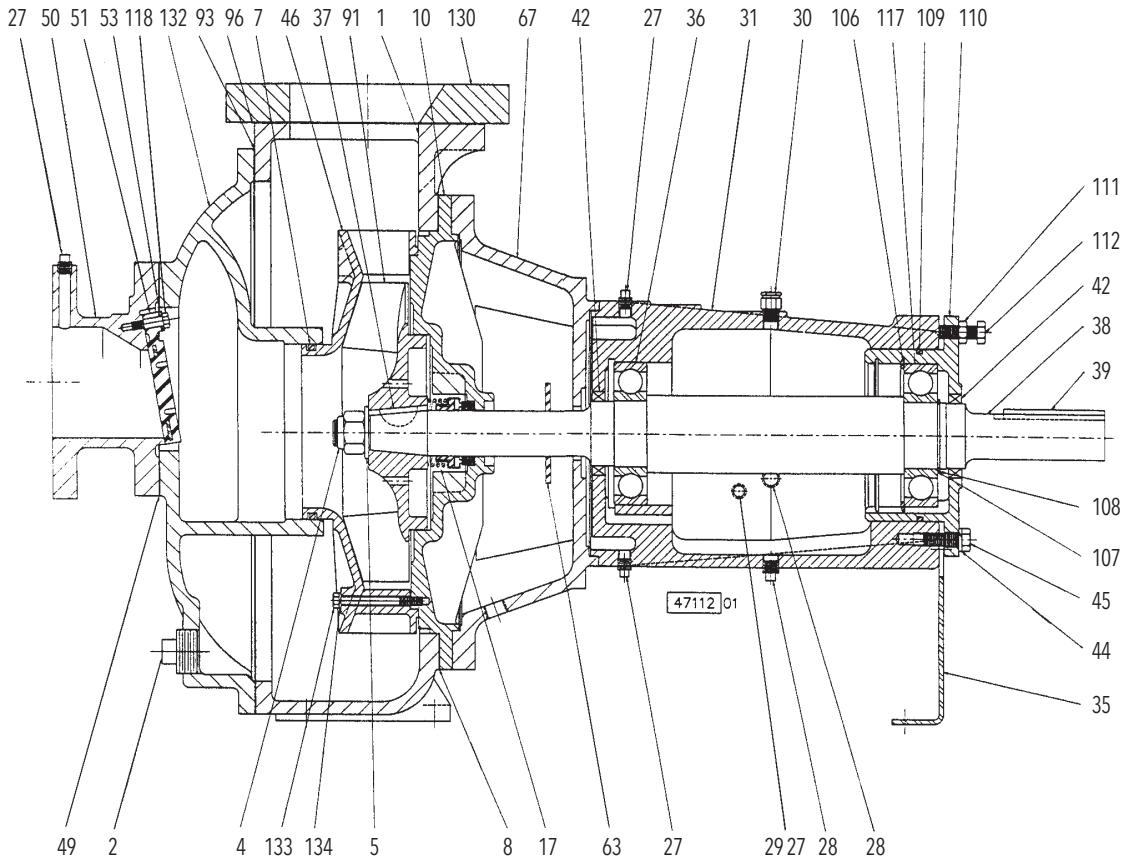

Item No.	Description	Materials
1	Casing	Ductile Iron
2	Pipe Plug	Cast Iron
4	Locknut, Impeller	Steel
5	Washer, Curved	Stainless Steel
7*	O-Ring	Buna-N Rubber
8	Gasket, Diecut	Composite
10	Housing Seal	Cast Iron
17*	Seal, Single Mechanical	Carbon vs. Ceramic
27	Pipe Plug	Steel
28	Pipe Plug	Steel
29	Oiler (optional)	–
30	Vent, Filter	Steel
31	Housing, Bearing	Cast Iron
35	Foot, Mounting	Steel
36	Bearing	#313
37	Key, Impeller	Steel
38	Shaft	Steel
39	Key, Coupling	Steel
42	Retainer	Steel/Rubber
44	Lockwasher	Stainless Steel
45	Capscrew	Stainless Steel

Item No.	Description	Materials
46	Diffuser	Cast Iron
49	Gasket, Diecut	Composite
50	Inlet, Suction	Cast Iron
51*	Valve, Check	Buna-N Rubber
53	Keeper	Stainless Steel
63	Slinger	PVC
67	Bracket	Cast Iron
91	Impeller	Cast Iron
93	Gasket, Diecut	Composite
96	Gasket, Diecut	Composite
106	Ring, Retaining	Steel
107	Shim, Bearing	Steel
108	Ring, Retaining	Steel
109	O-Ring	Buna-N Rubber
110	Carrier, Bearing	Cast Iron
111	Hexnut, Jam	Stainless Steel
118	Bolt, Shouldered	Stainless Steel
130	Adapter, Plate	Cast Iron
132	Cover, Casing	Cast Iron
133	Capscrew	Stainless Steel
134	Lockwasher	Stainless Steel

*Available in Viton® as an option.

Prime Line® Performance Coverage (60 Hz) 4E and 6E

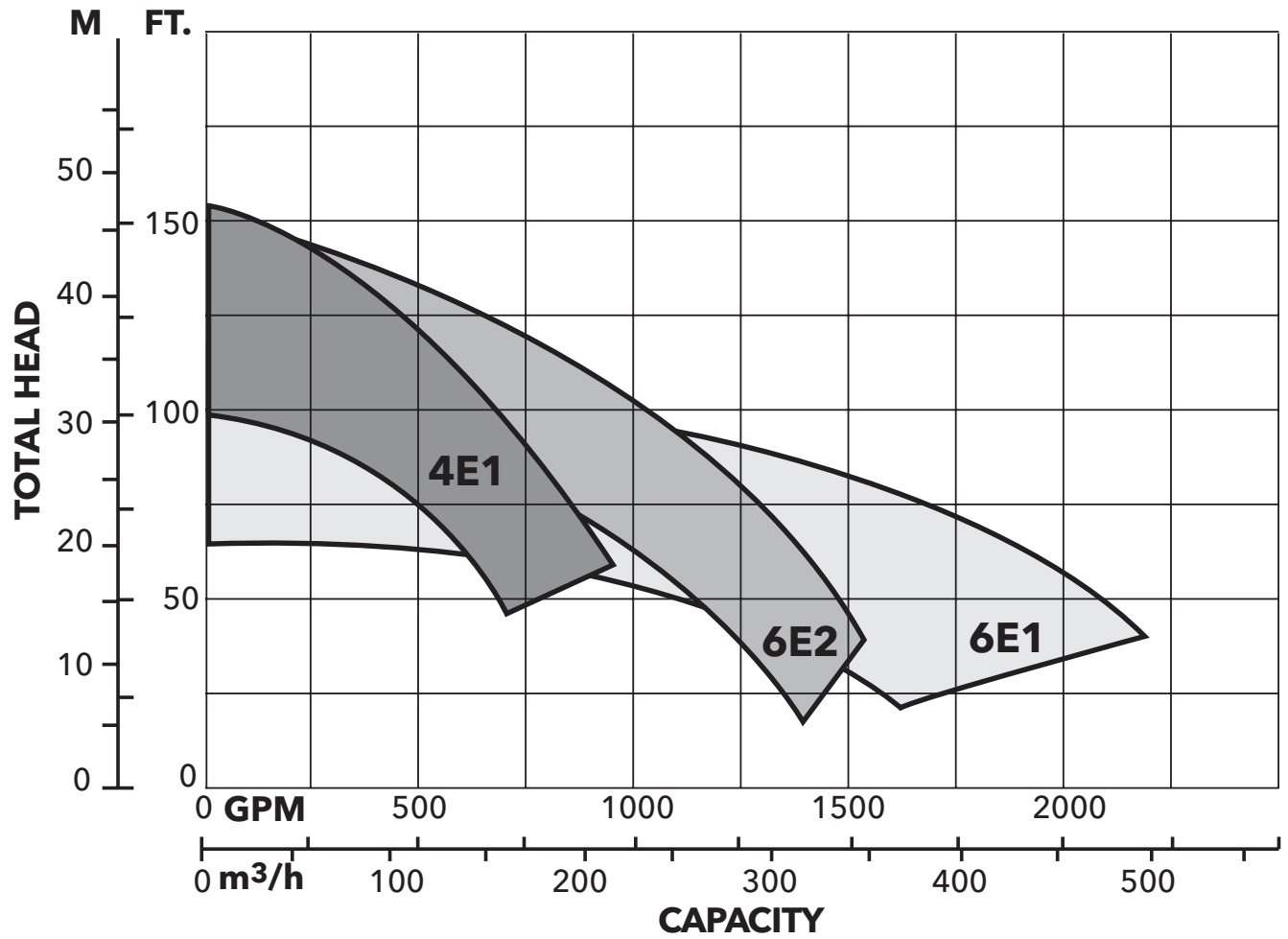

Prime Line® Performance Curves - Size 2P1, 60 Hz

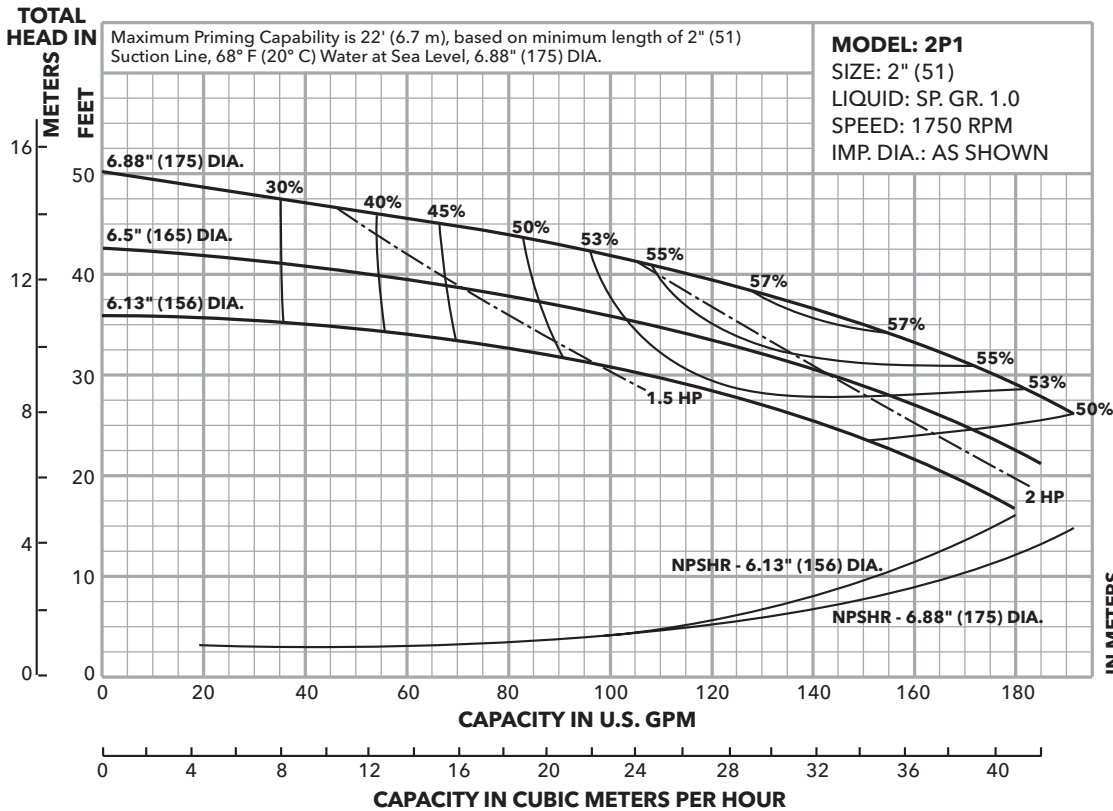

Ordering Code	Standard HP Rating	Imp. Dia. ①
A	3	6.88 (175)
B	2	6.5 (165)
C	1½*	6.13 (156)

* Requires service factor.

① Impeller diameter in inches and millimeters (mm).

Prime Line® Performance Curves - Size 2P1, 50 Hz

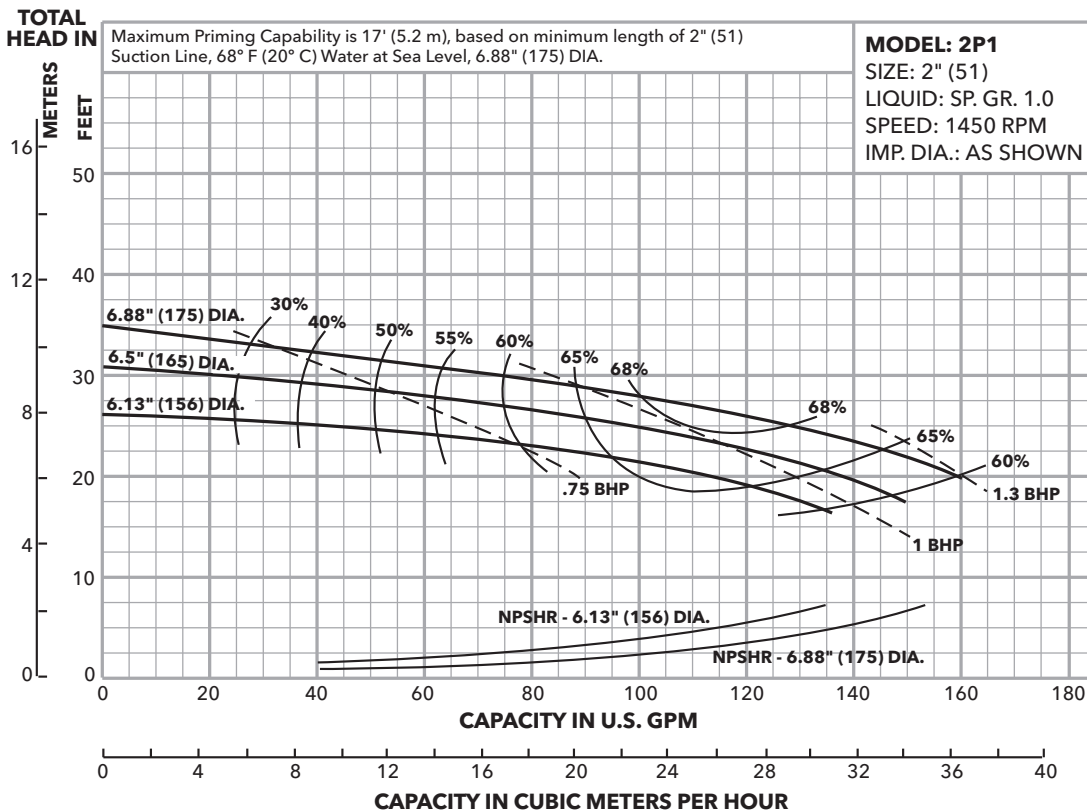

Ordering Code	Standard HP Rating	Imp. Dia. ①
A	1½	6.88 (175)
B	1½	6.5 (165)
C	1	6.13 (156)

① Impeller diameter in inches and millimeters (mm).

Prime Line® Performance Curves - Size 2P2, 60 Hz

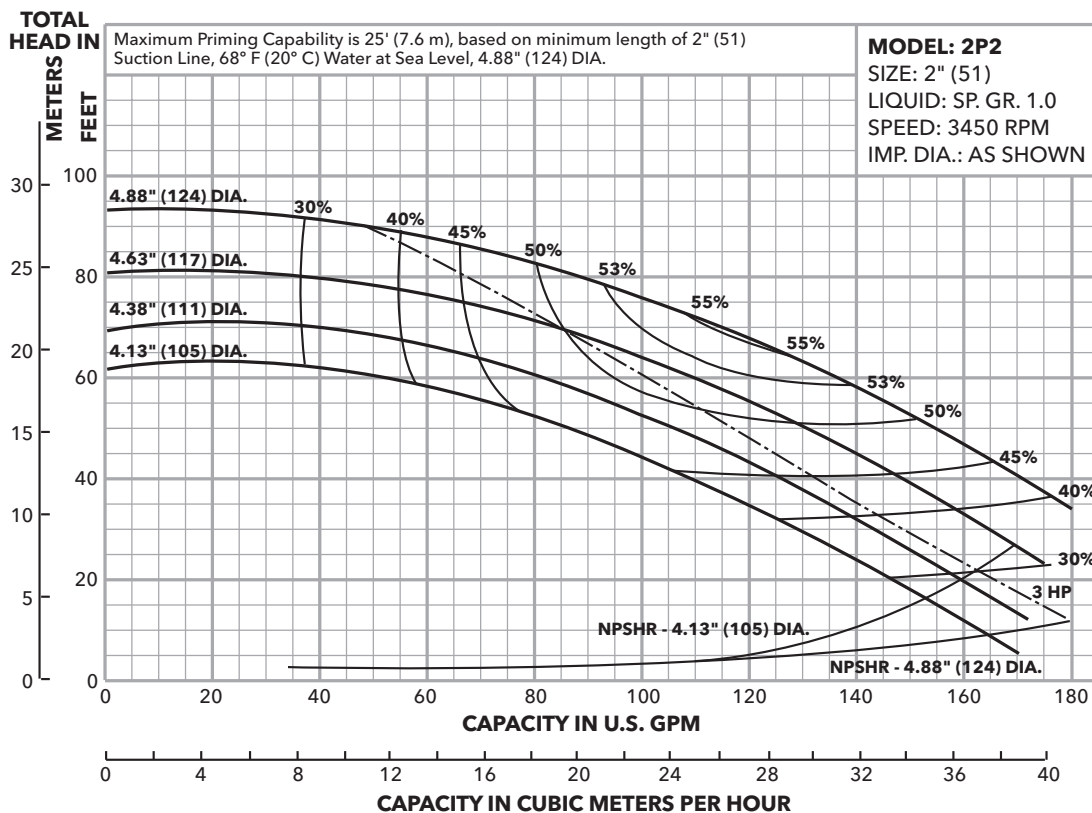

Ordering Code	Standard HP Rating	Imp. Dia. ①
A	5	4.88 (124)
B	3*	4.63 (117)
C	3	4.38 (111)
D	2*	4.13 (105)

* Requires service factor.

① Impeller diameter in inches and millimeters (mm).

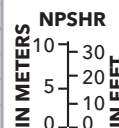

Prime Line® Performance Curves - Size 2P2, 50 Hz

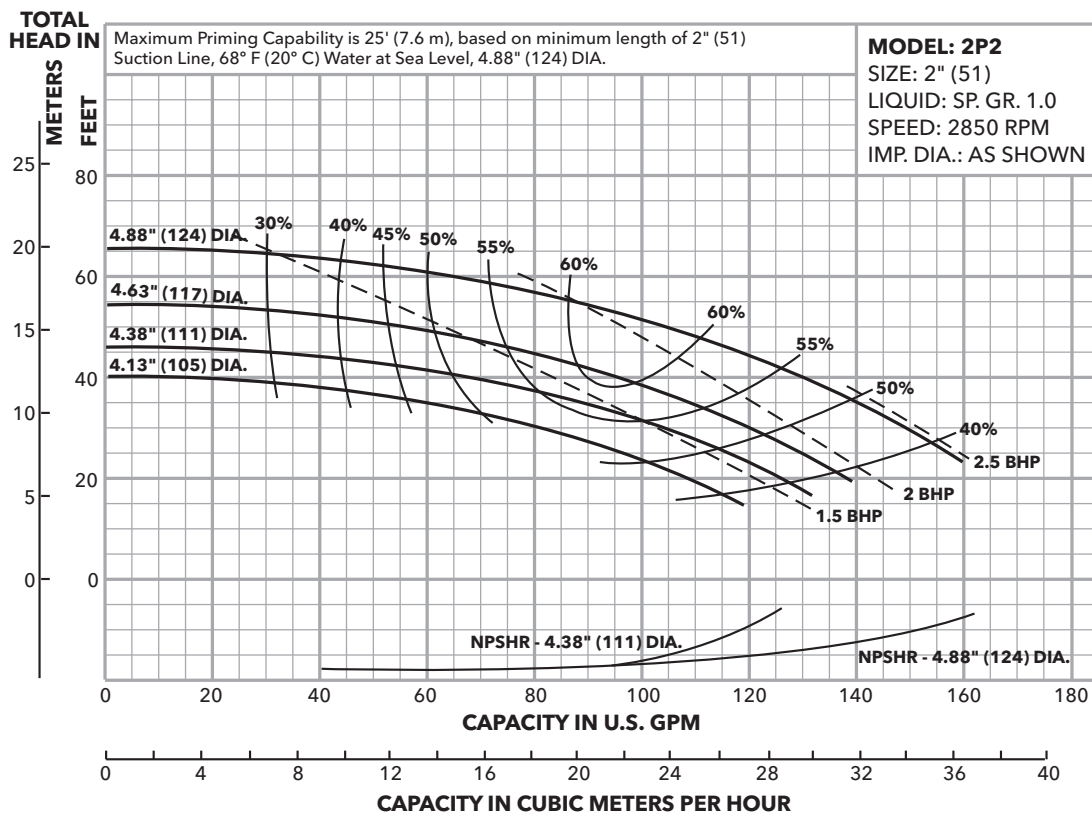

Ordering Code	Standard HP Rating	Imp. Dia. ①
A	3	4.88 (124)
B	2	4.63 (117)
C	1½*	4.38 (111)
D	1½	4.13 (105)

* Requires service factor.

① Impeller diameter in inches and millimeters (mm).

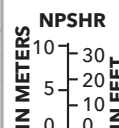

Prime Line® Performance Curves - Size 2P3, 60 Hz

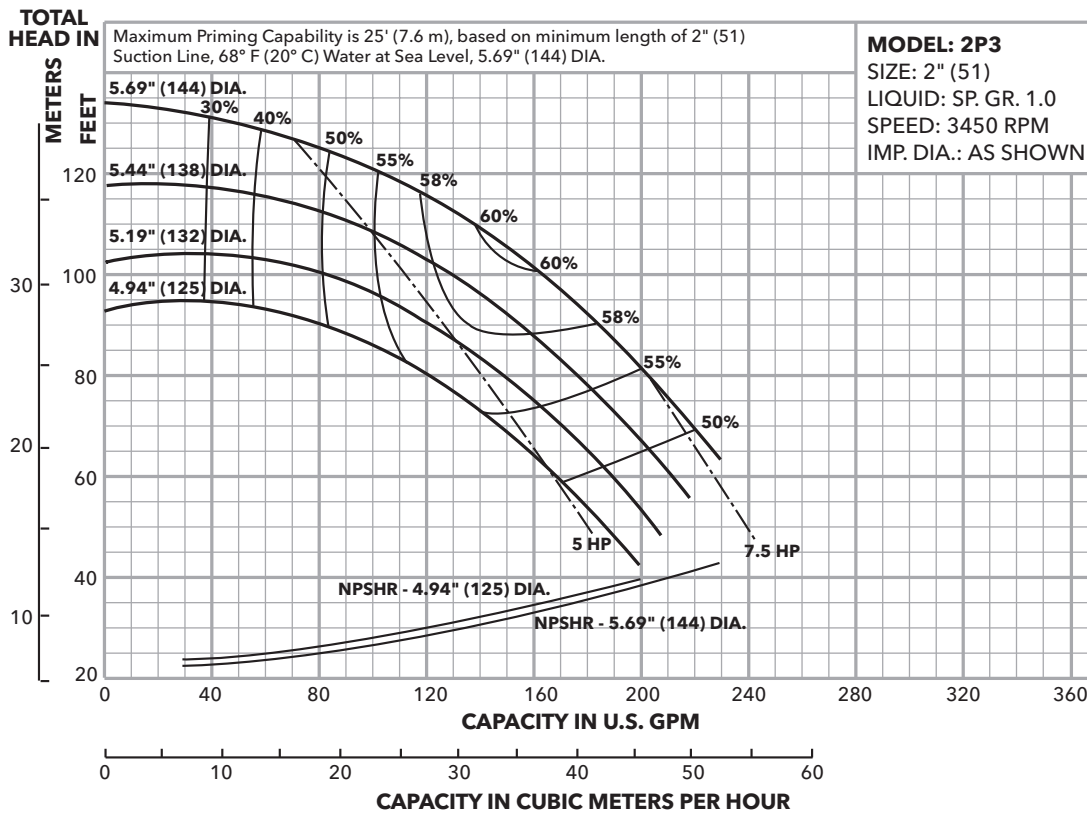

Ordering Code	Standard HP Rating	Imp. Dia. ①
A	7½	5.69 (144)
B	7½	5.44 (138)
C	5*	5.19 (132)
D	5	4.94 (125)

* Requires service factor.
 ① Impeller diameter in inches and millimeters (mm).

Prime Line® Performance Curves - Size 2P3, 50 Hz

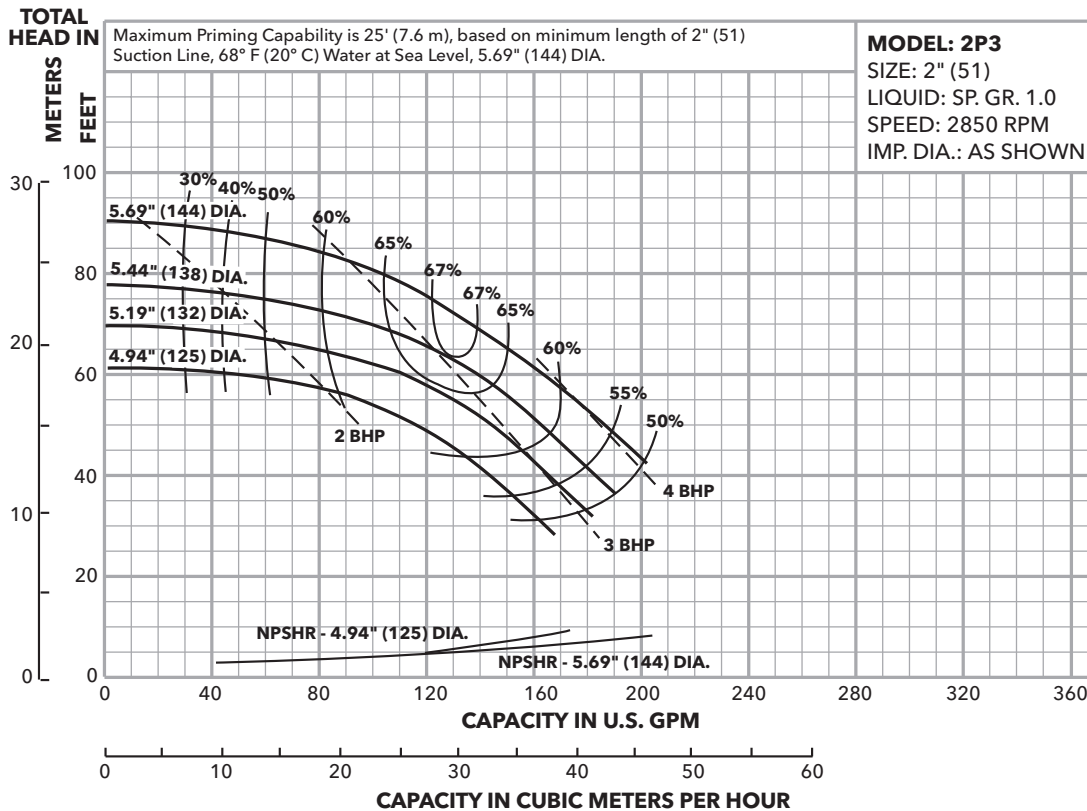

Ordering Code	Standard HP Rating	Imp. Dia. ①
A	5	5.69 (144)
B	5	5.44 (138)
C	3*	5.19 (132)
D	3	4.94 (125)

* Requires service factor.
 ① Impeller diameter in inches and millimeters (mm).

Commercial Water

Prime Line® Performance Curves - Size 2P4, 60 Hz

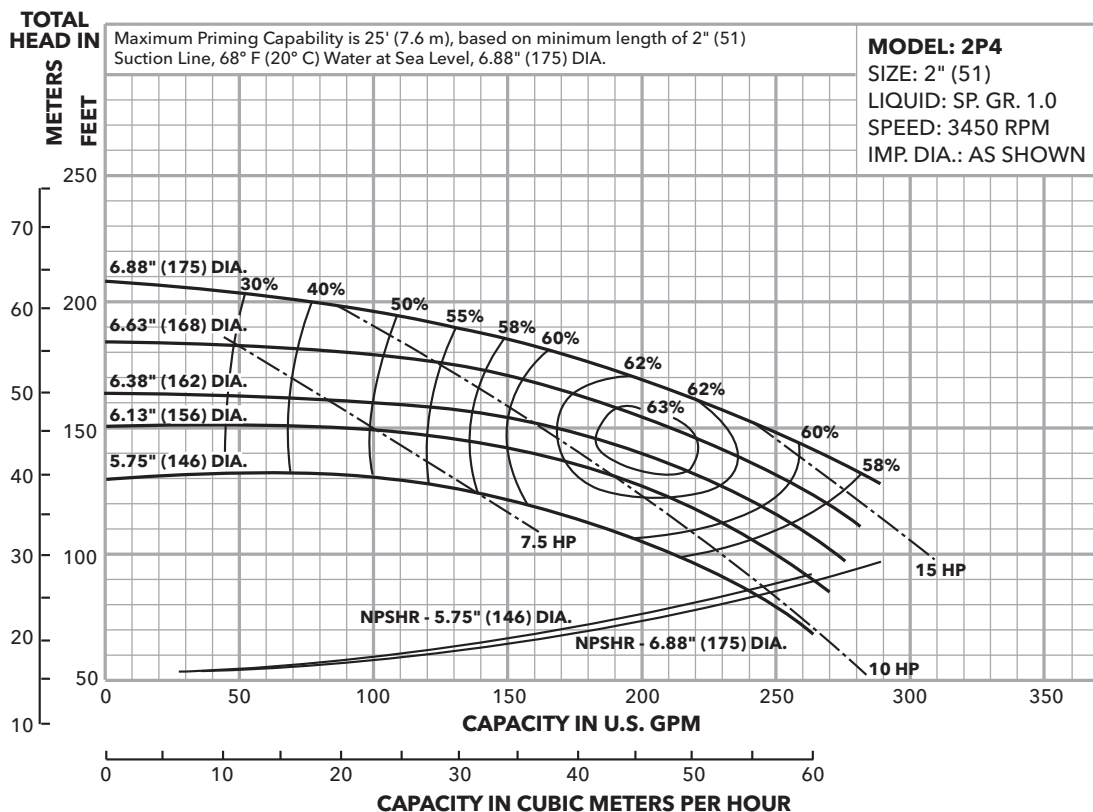

Ordering Code	Standard HP Rating	Imp. Dia. ①
A	15	6.88 (175)
B	15	6.63 (168)
C	10*	6.38 (162)
D	10	6.13 (156)
E	7½*	5.75 (146)

* Requires service factor.

① Impeller diameter in inches and millimeters (mm).

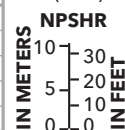

Prime Line® Performance Curves - Size 2P4, 50 Hz

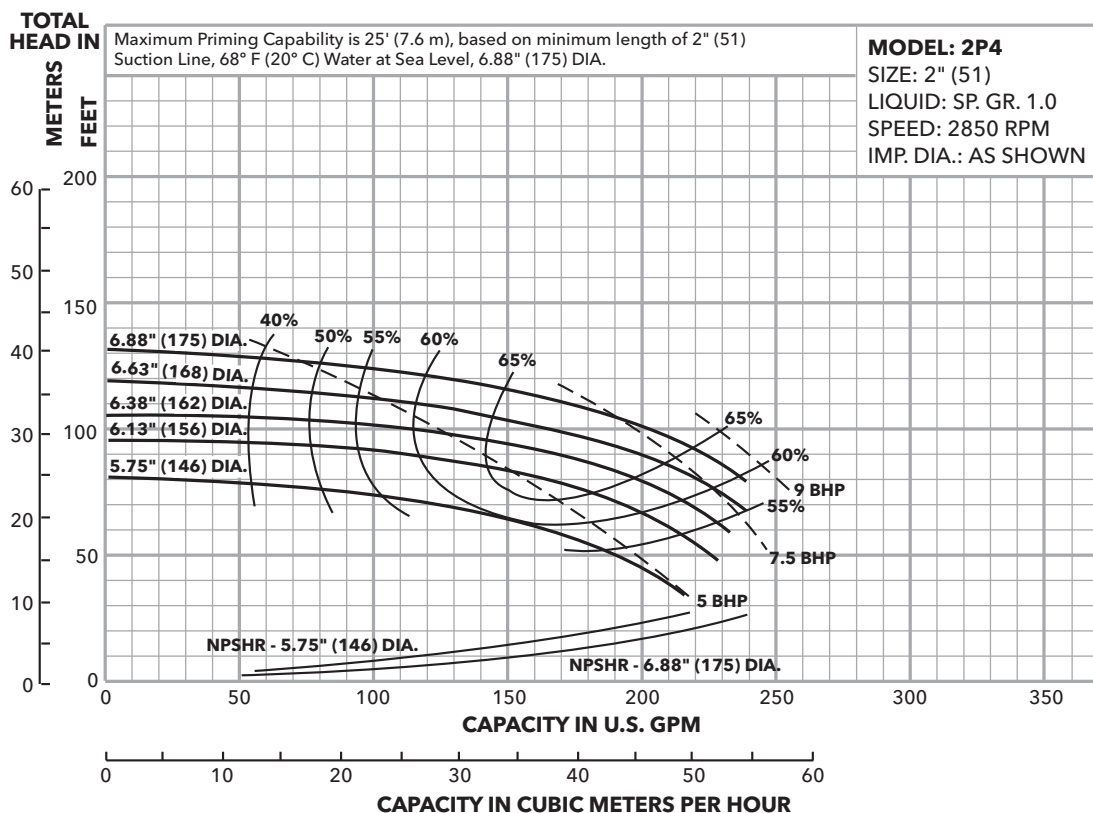

Ordering Code	Standard HP Rating	Imp. Dia. ①
A	10	6.88 (175)
B	7½*	6.63 (168)
C	7½	6.38 (162)
D	7½	6.13 (156)
E	5	5.75 (146)

* Requires service factor.

① Impeller diameter in inches and millimeters (mm).

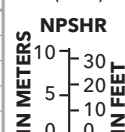

Prime Line® Performance Curves - Size 3P1, 60 Hz

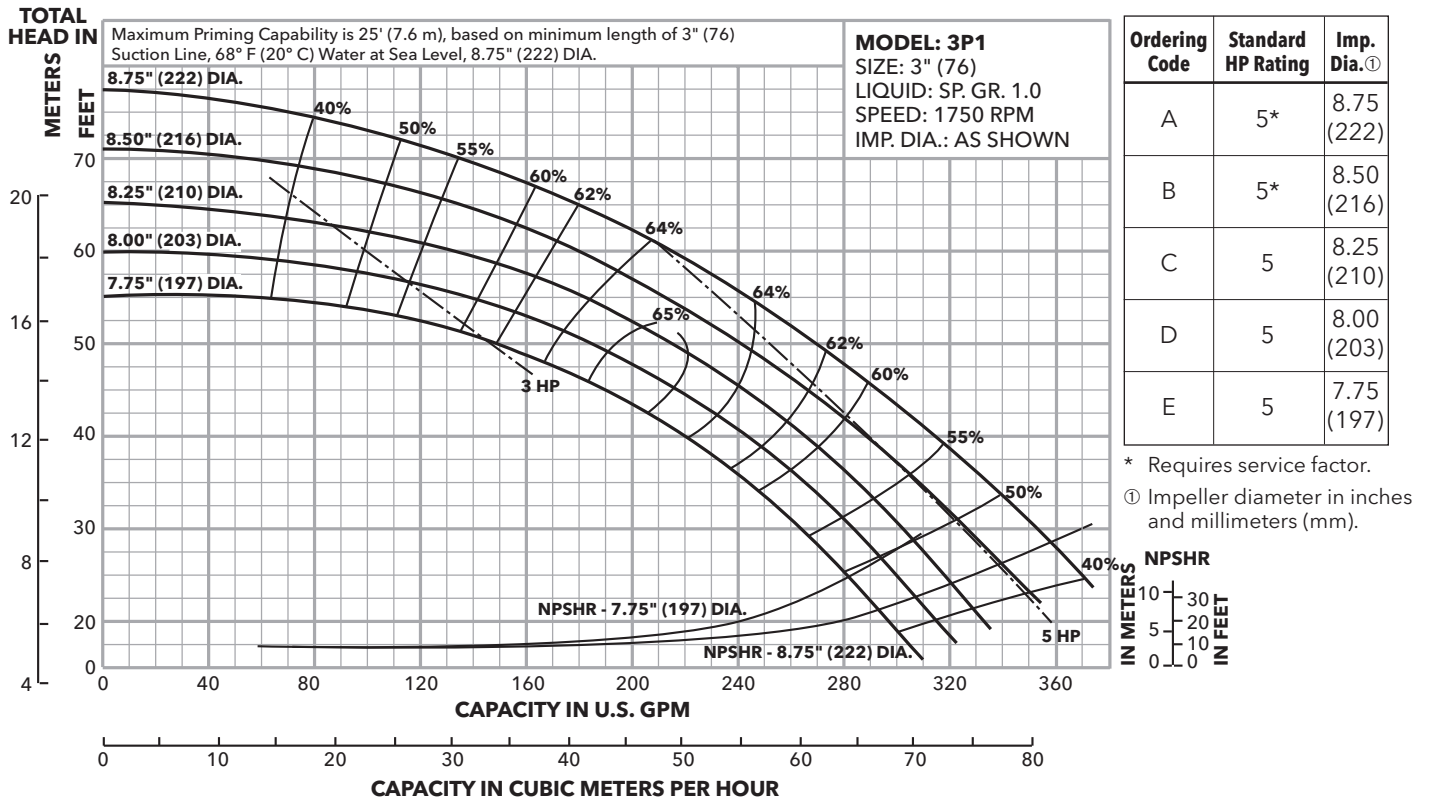

Prime Line® Performance Curves - Size 3P1, 50 Hz

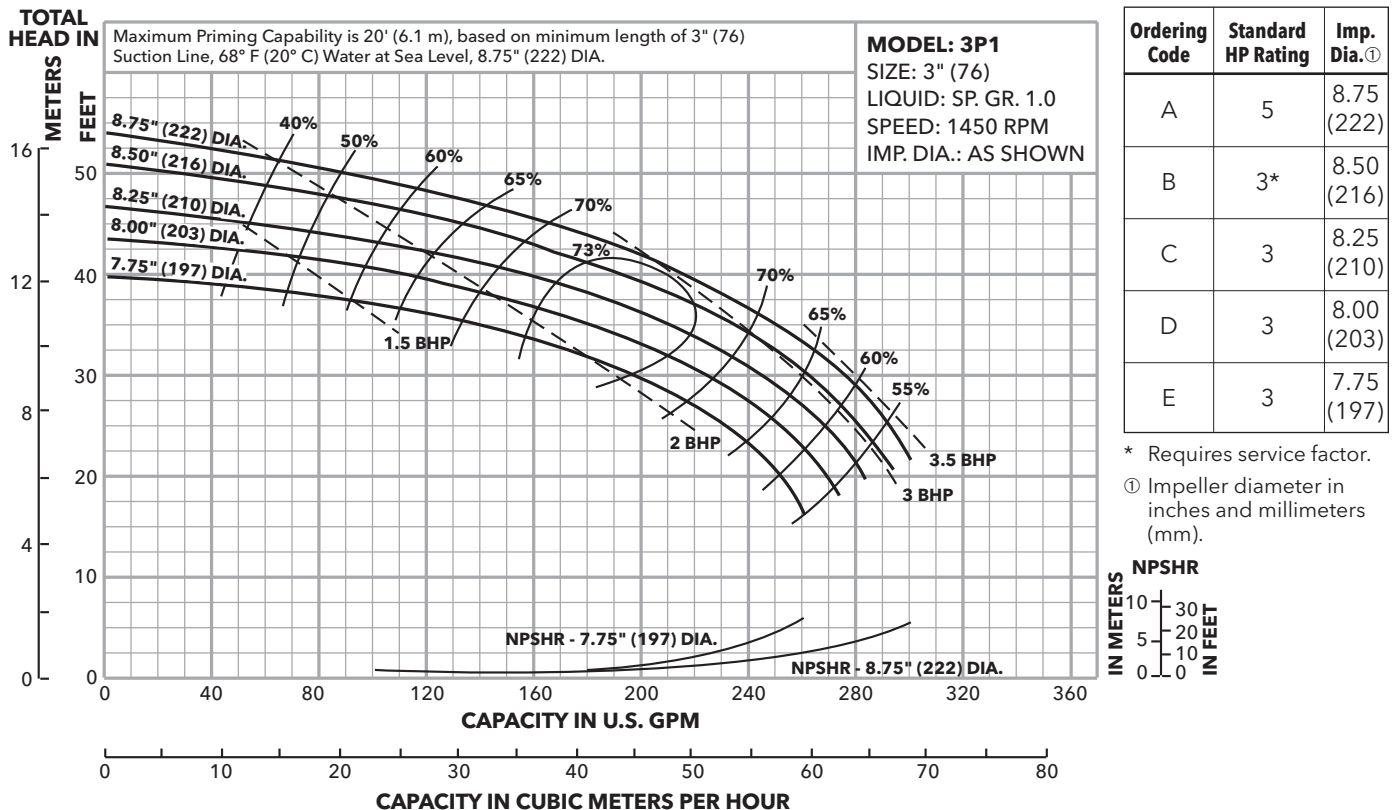

Prime Line® Performance Curves - Size 3P2, 60 Hz

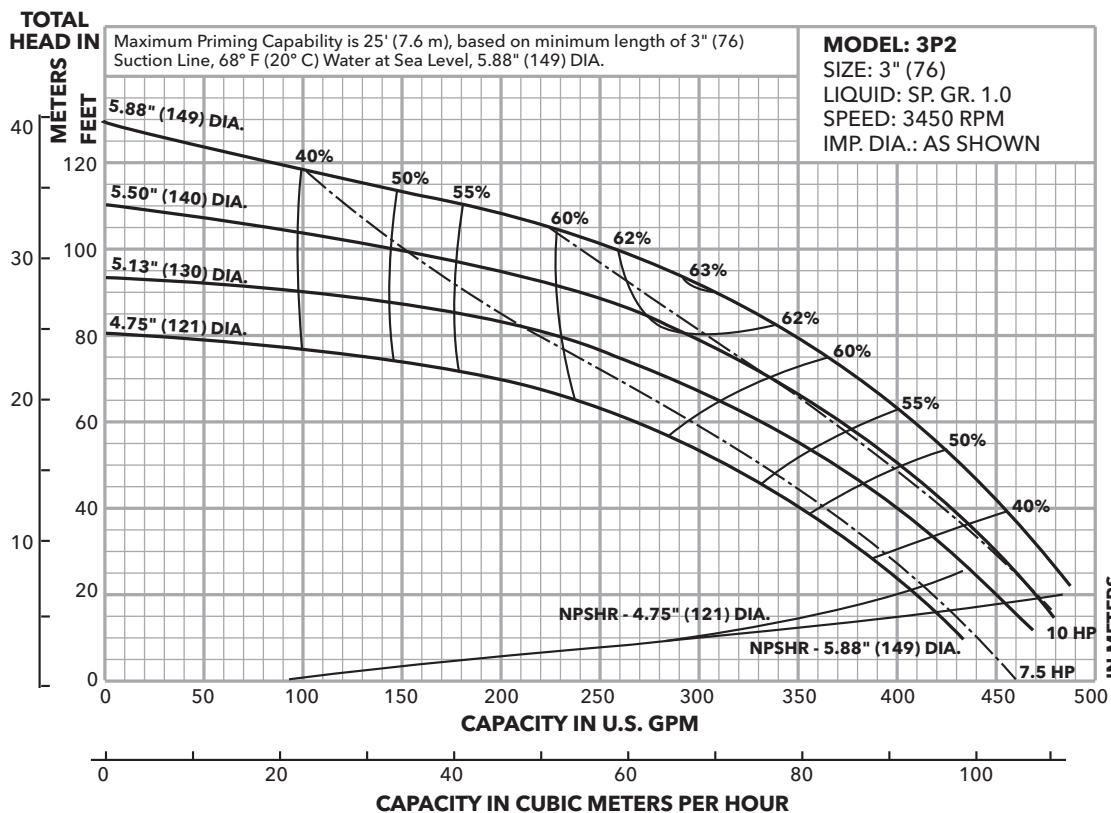

Ordering Code	Standard HP Rating	Imp. Dia. ①
A	10*	5.88 (149)
B	10	5.50 (140)
C	7½	5.13 (130)
D	5*	4.75 (121)

* Requires service factor.
 ① Impeller diameter in inches and millimeters (mm).

Prime Line® Performance Curves - Size 3P2, 50 Hz

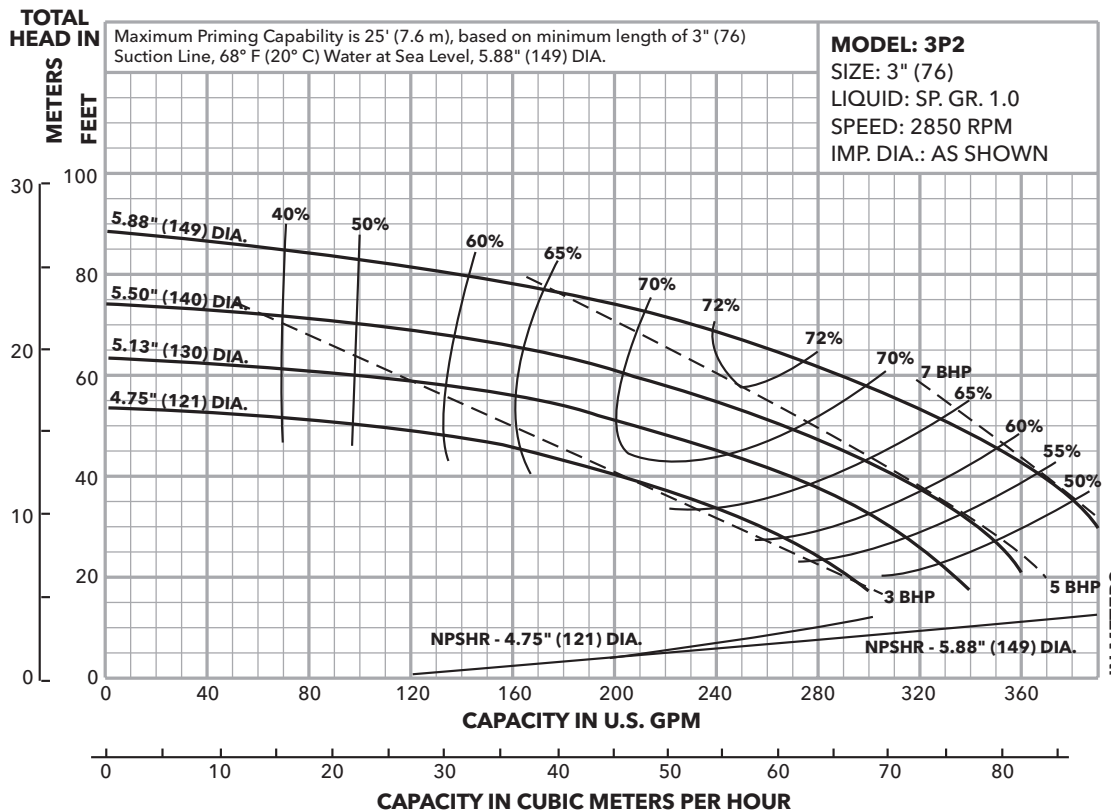

Ordering Code	Standard HP Rating	Imp. Dia. ①
A	7½	5.88 (149)
B	5	5.50 (140)
C	5	5.13 (130)
D	3*	4.75 (121)

* Requires service factor.
 ① Impeller diameter in inches and millimeters (mm).

Prime Line® Performance Curves - Size 3P3, 60 Hz, 3500 RPM

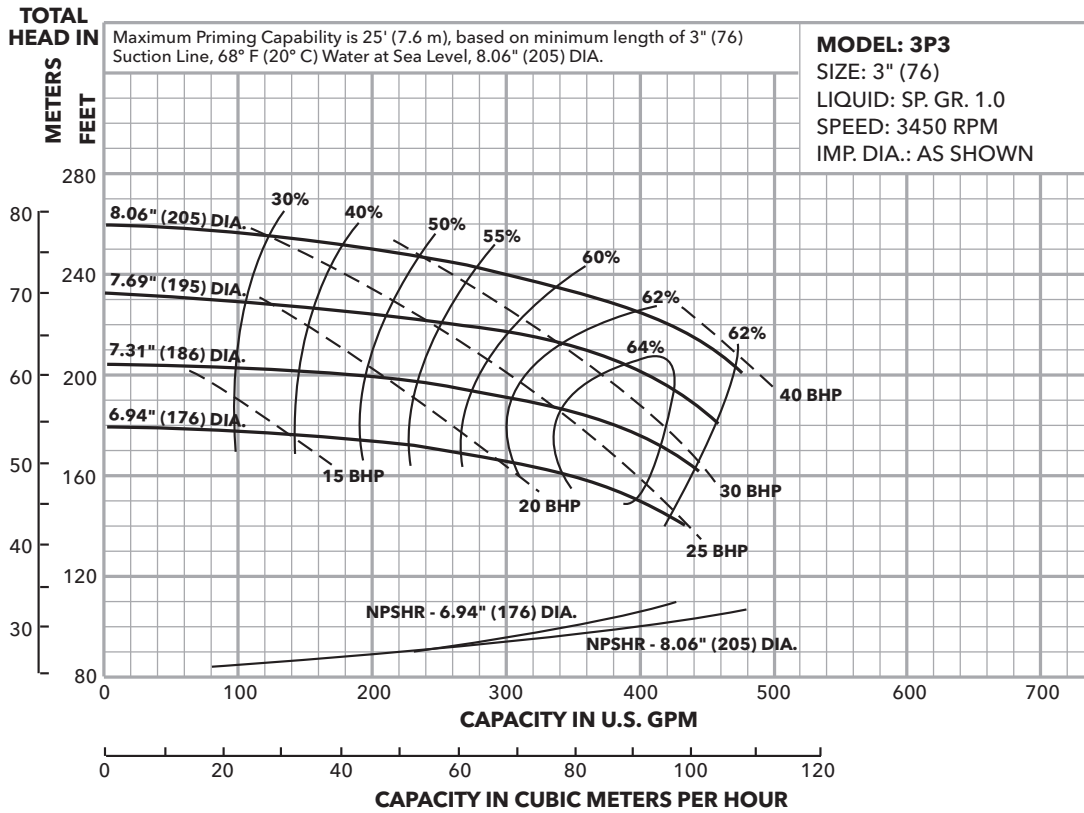

Ordering Code	Standard HP Rating	Imp. Dia.①
A	40	8.06 (205)
B	40	7.69 (195)
C	30	7.31 (186)
D	25	6.94 (176)

① Impeller diameter in inches and millimeters (mm).

Prime Line® Performance Curves - Size 3P3, 50 Hz

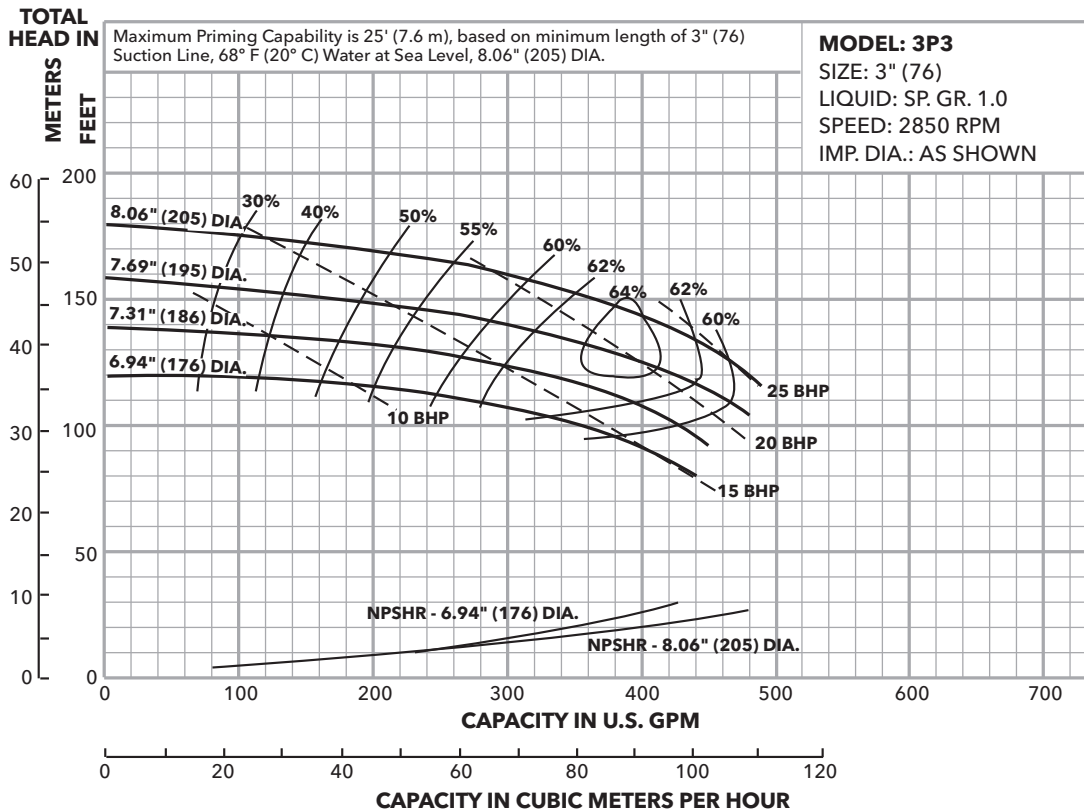

Ordering Code	Standard HP Rating	Imp. Dia.①
A	25	8.06 (205)
B	25	7.69 (195)
C	20	7.31 (186)
D	15	6.94 (176)

① Impeller diameter in inches and millimeters (mm).

Prime Line® Performance Curves - Size 3P3, 60 Hz, 1750 RPM

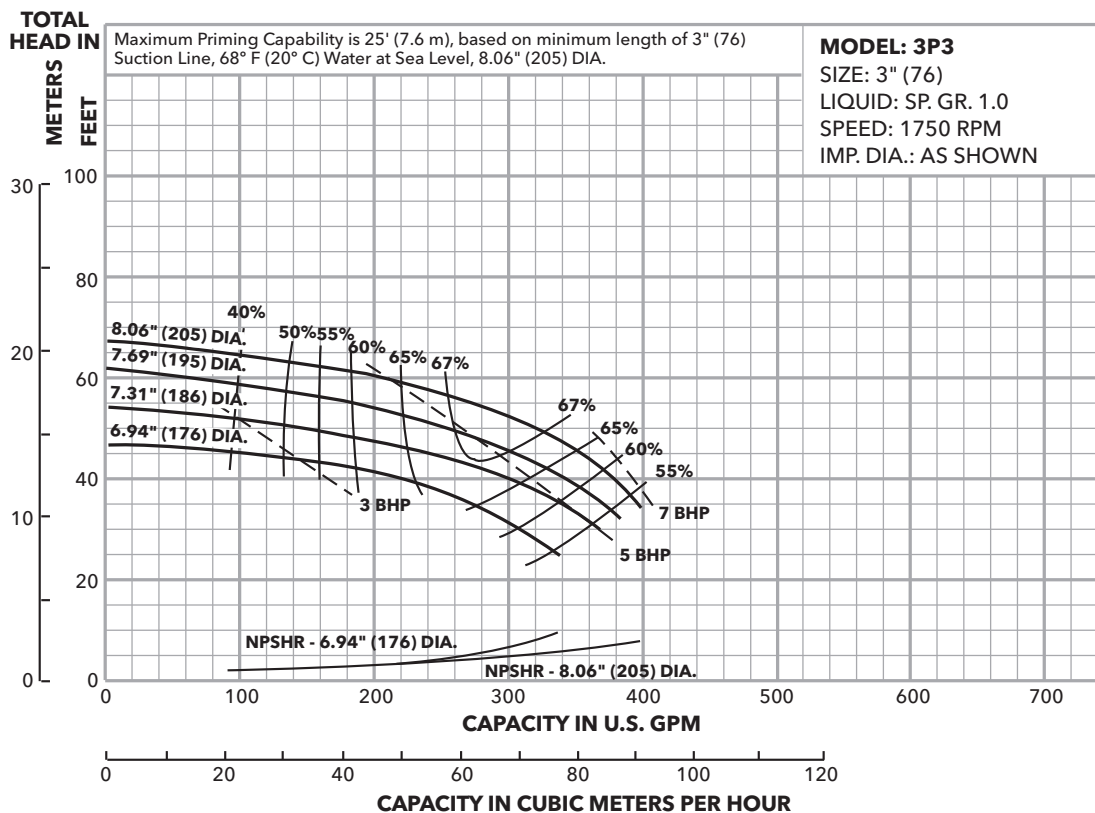

Ordering Code	Standard HP Rating	Imp. Dia. ①
A	7½	8.06 (205)
B	7½	7.69 (195)
C	5	7.31 (186)
D	5	6.94 (176)

① Impeller diameter in inches and millimeters (mm).

Prime Line® Performance Curves - Size 3P4, 60 Hz, 3450 RPM

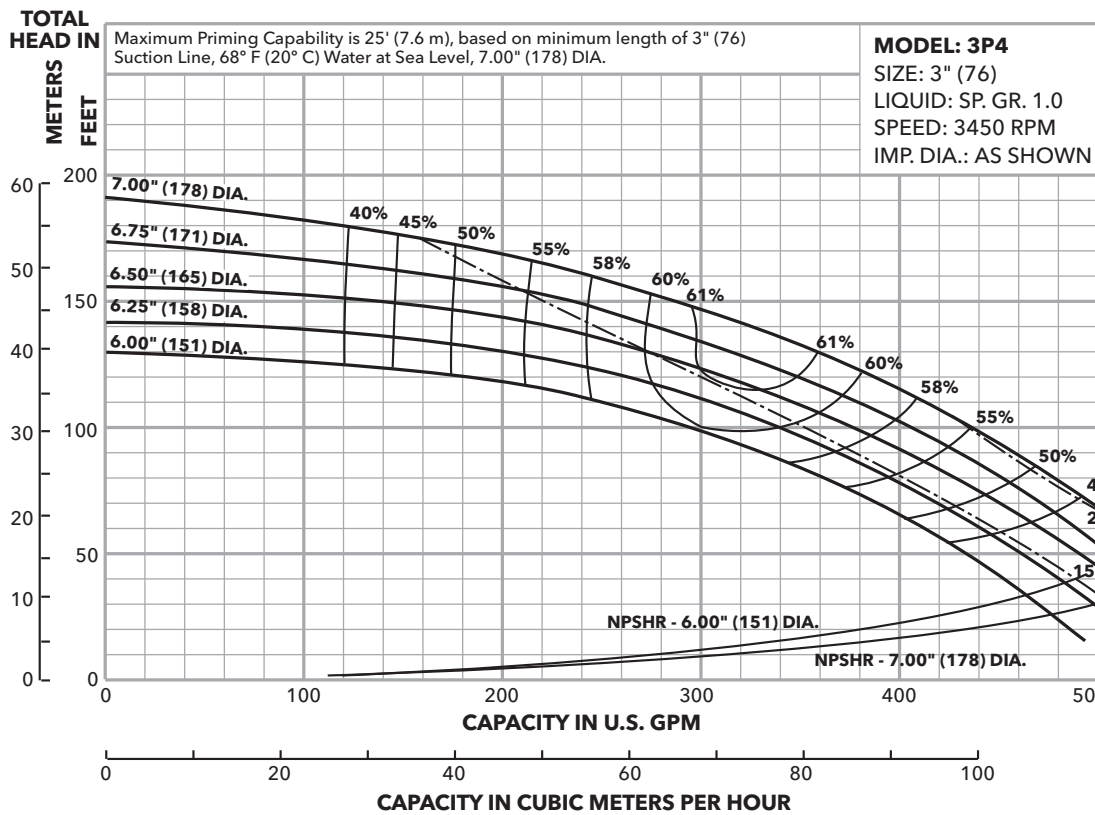

Ordering Code	Standard HP Rating	Imp. Dia. ①
A	25	7.00 (178)
B	20	6.75 (171)
C	20	6.50 (165)
D	15	6.25 (158)
E	15	6.00 (151)

① Impeller diameter in inches and millimeters (mm).

Prime Line® Performance Curves - Size 3P4, 50 Hz, 2850 RPM

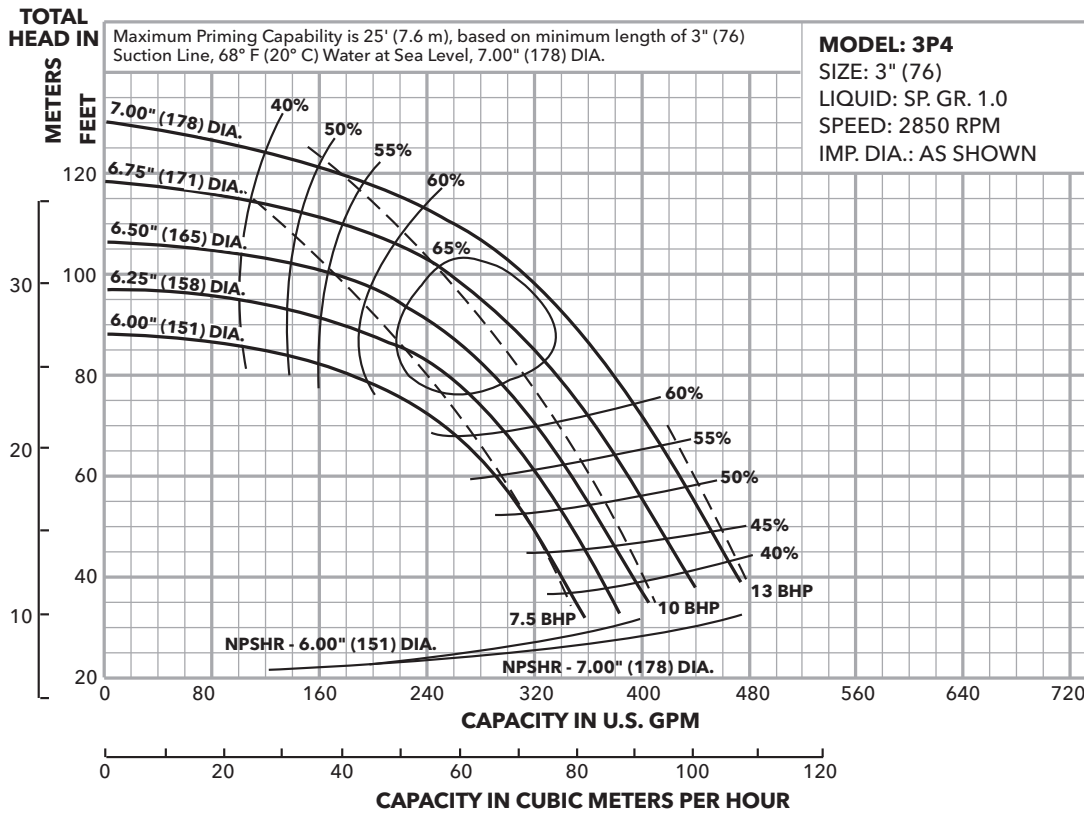

Ordering Code	Standard HP Rating	Imp. Dia. ①
A	15	7.00 (178)
B	15	6.75 (171)
C	10	6.50 (165)
D	10	6.25 (158)
E	7½*	6.00 (151)

* Requires service factor.
 ① Impeller diameter in inches and millimeters (mm).

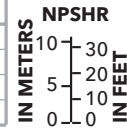

Prime Line® Performance Curves - Size 3P4, 60 Hz, 1750 RPM

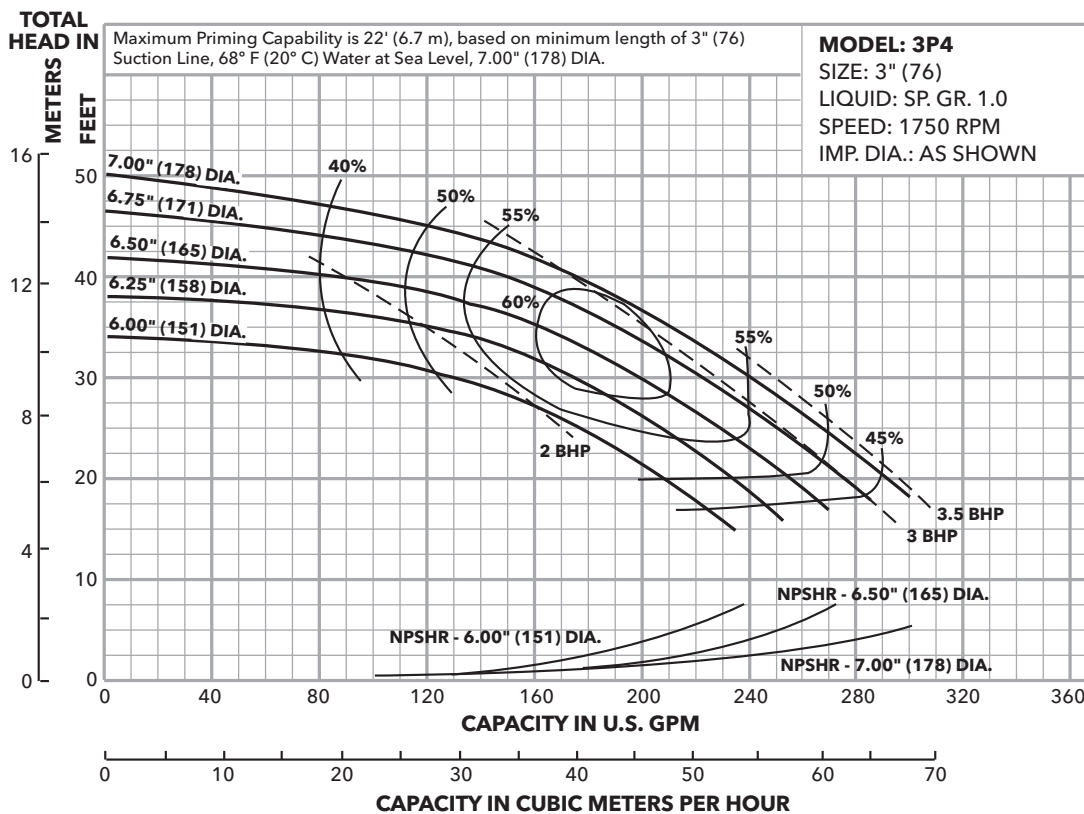

Ordering Code	Standard HP Rating	Imp. Dia. ①
A	5	7.00 (178)
B	3	6.75 (171)
C	3	6.50 (165)
D	3	6.25 (158)
E	2*	6.00 (151)

* Requires service factor.
 ① Impeller diameter in inches and millimeters (mm).

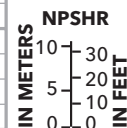

Prime Line® Performance Curves - Size 4P1, 60 Hz, 1750 RPM

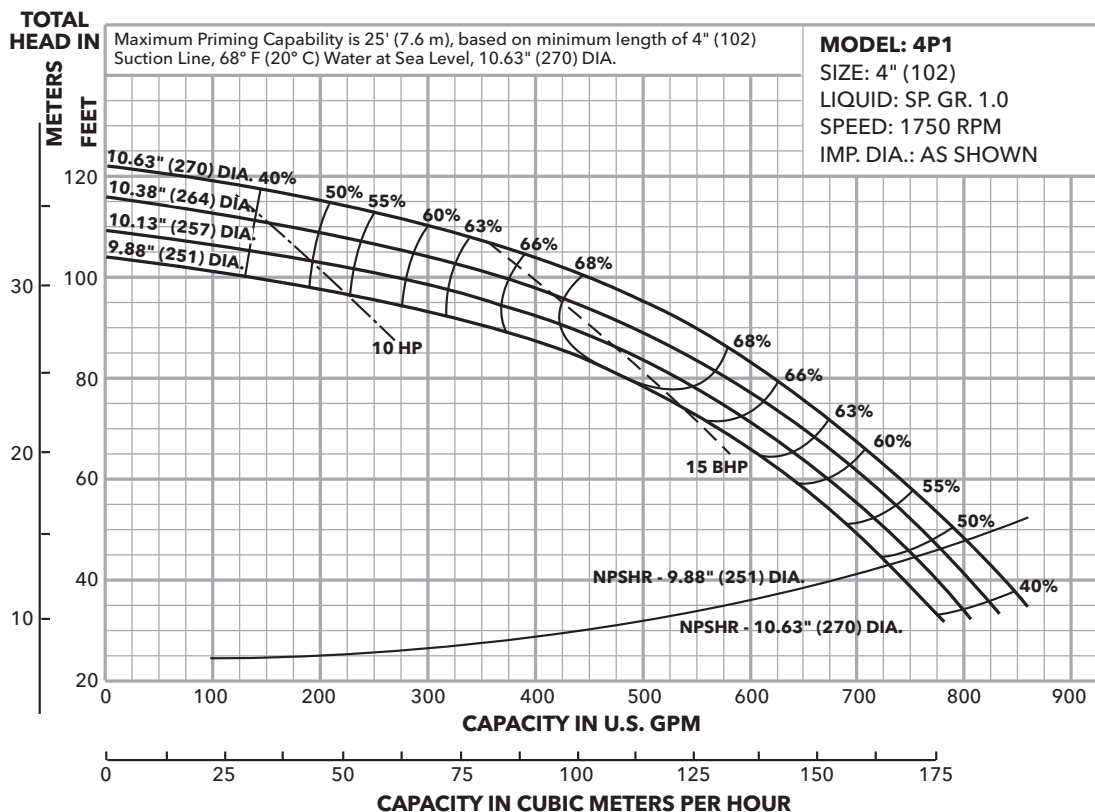

Ordering Code	Standard HP Rating	Imp. Dia. ①
A	20	10.63 (270)
B	20	10.38 (264)
C	20	10.13 (257)
D	15*	9.88 (251)

* Requires service factor.

① Impeller diameter in inches and millimeters (mm).

Prime Line® Performance Curves - Size 4P1, 50 Hz, 1450 RPM

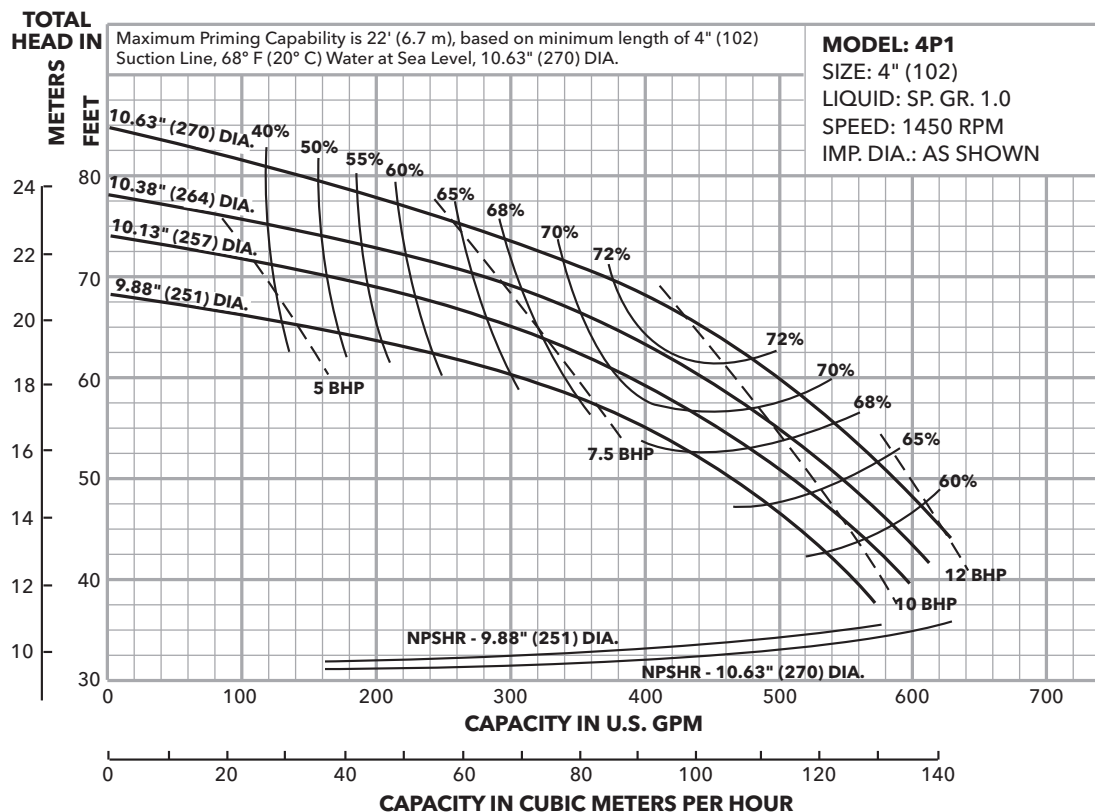

Ordering Code	Standard HP Rating	Imp. Dia. ①
A	15	10.63 (270)
B	15	10.38 (264)
C	10*	10.13 (257)
D	10	9.88 (251)

* Requires service factor.

① Impeller diameter in inches and millimeters (mm).

Prime Line® Performance Curves - Size 4P1, 60 Hz, 1150 RPM

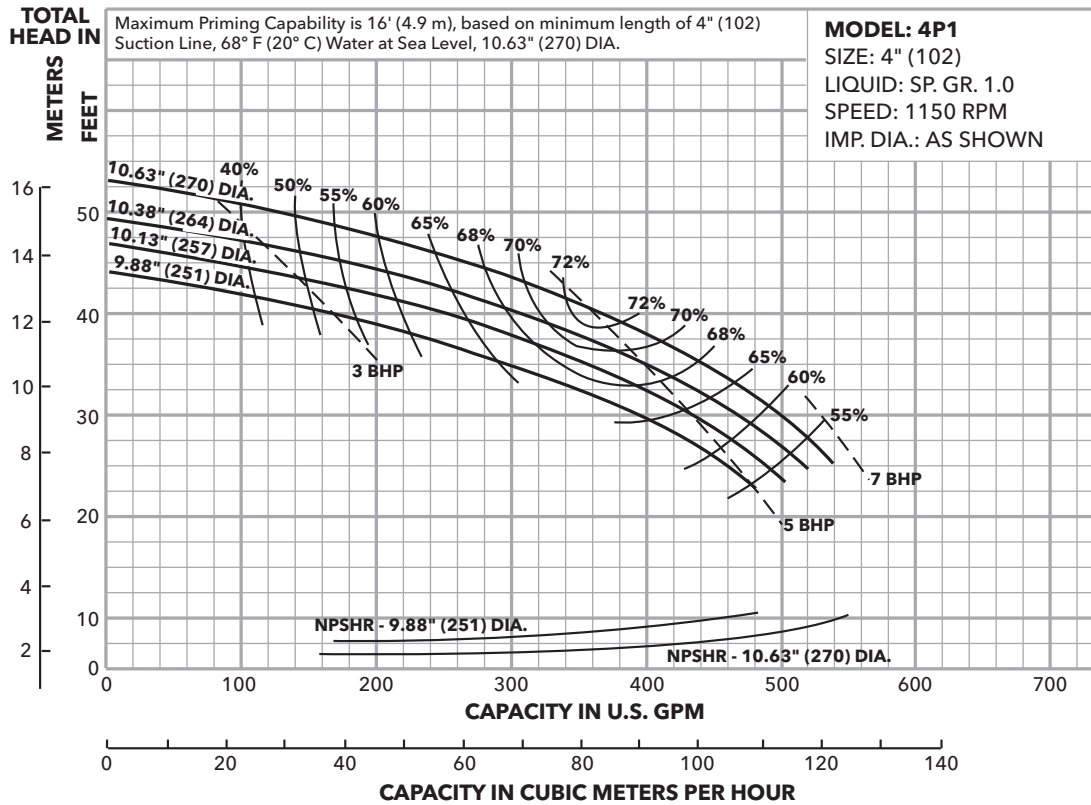

Ordering Code	Standard HP Rating	Imp. Dia. ①
A	7½	10.63 (270)
B	7½	10.38 (264)
C	7½	10.13 (257)
D	5	9.88 (251)

① Impeller diameter in inches and millimeters (mm).

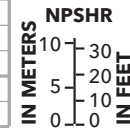

Prime Line® Performance Curves - Size 4P2, 60 Hz, 1750 RPM

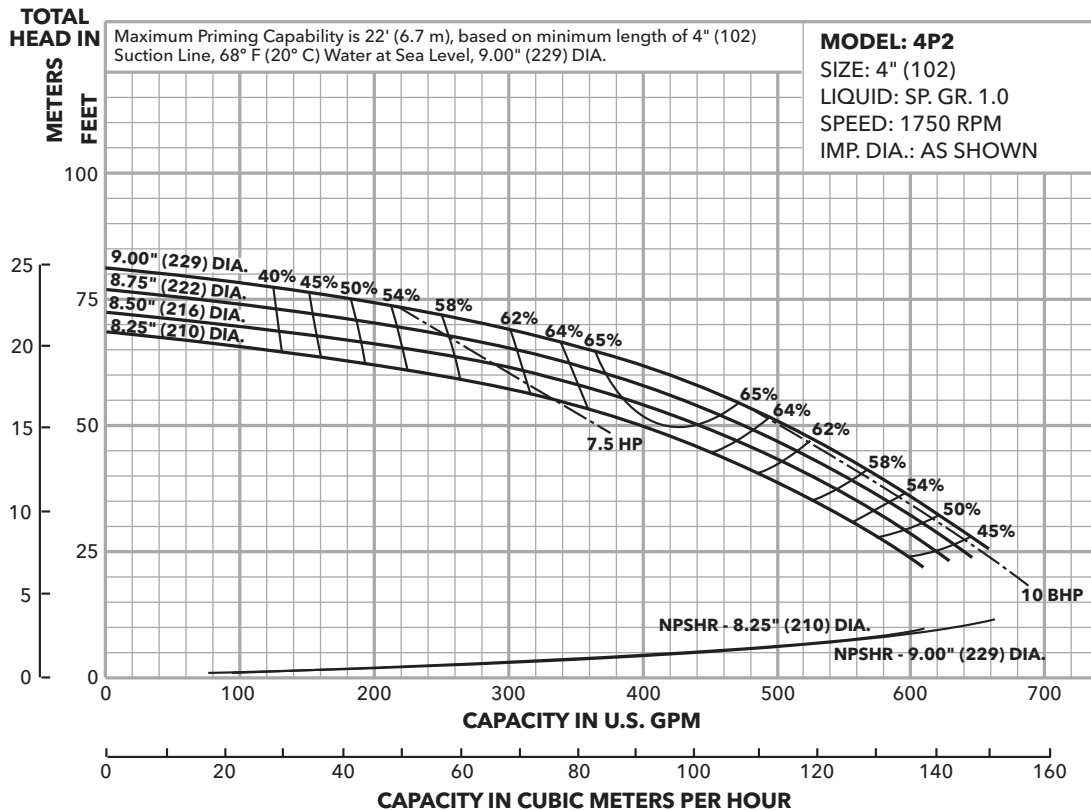

Ordering Code	Standard HP Rating	Imp. Dia. ①
A	10*	9.00 (229)
B	10	8.75 (222)
C	10	8.50 (216)
D	7½*	8.25 (210)

* Requires service factor.

① Impeller diameter in inches and millimeters (mm).

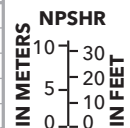

Prime Line® Performance Curves - Size 4P2, 50 Hz, 1450 RPM

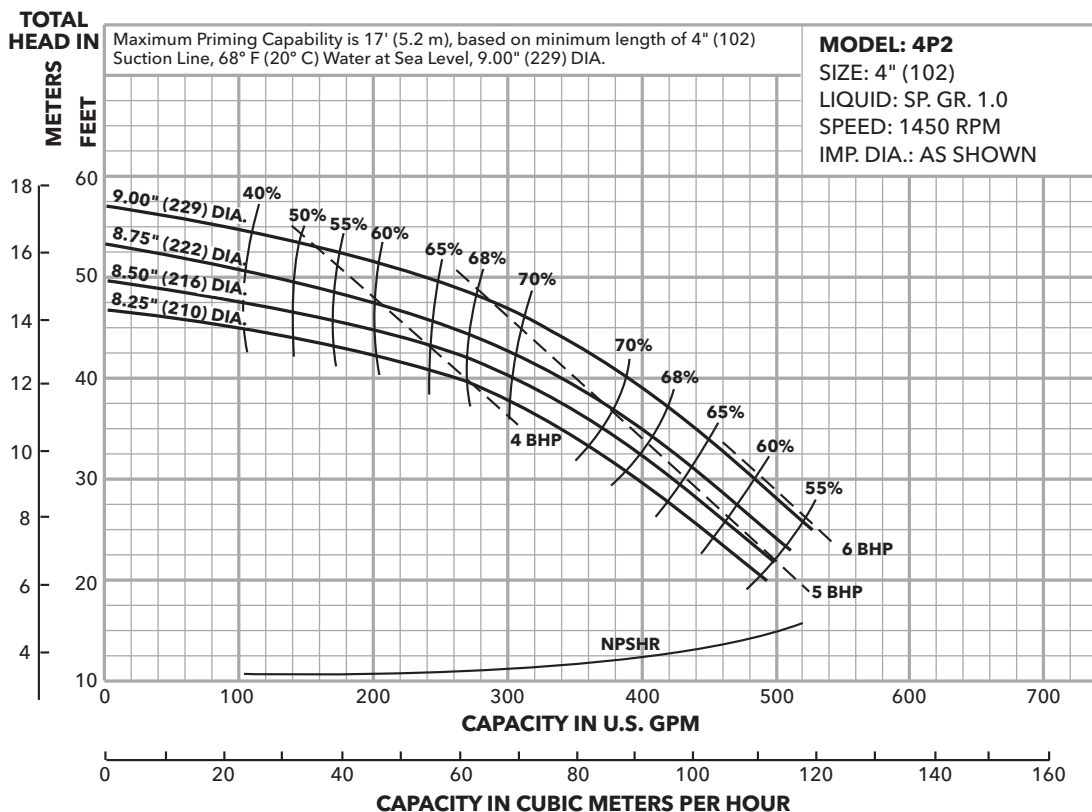

Ordering Code	Standard HP Rating	Imp. Dia.①
A	7½	9.00 (229)
B	7½	8.75 (222)
C	5	8.50 (216)
D	5	8.25 (210)

① Impeller diameter in inches and millimeters (mm).

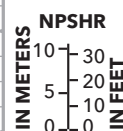

Prime Line® Performance Curves - Size 4P2, 60 Hz, 1150 RPM

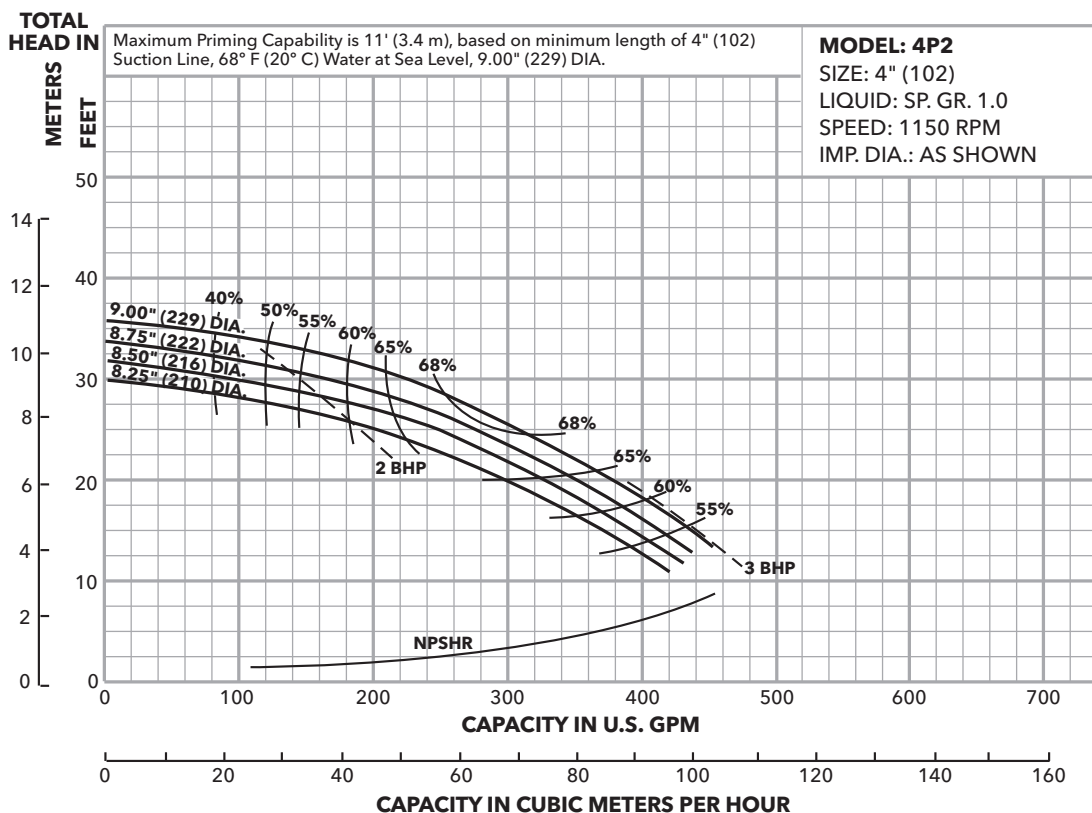

Ordering Code	Standard HP Rating	Imp. Dia.①
A	3	9.00 (229)
B	3	8.75 (222)
C	3	8.50 (216)
D	3	8.25 (210)

① Impeller diameter in inches and millimeters (mm).

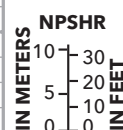

Prime Line® Performance Curves - Size 4E1, 60 Hz, 1750 RPM

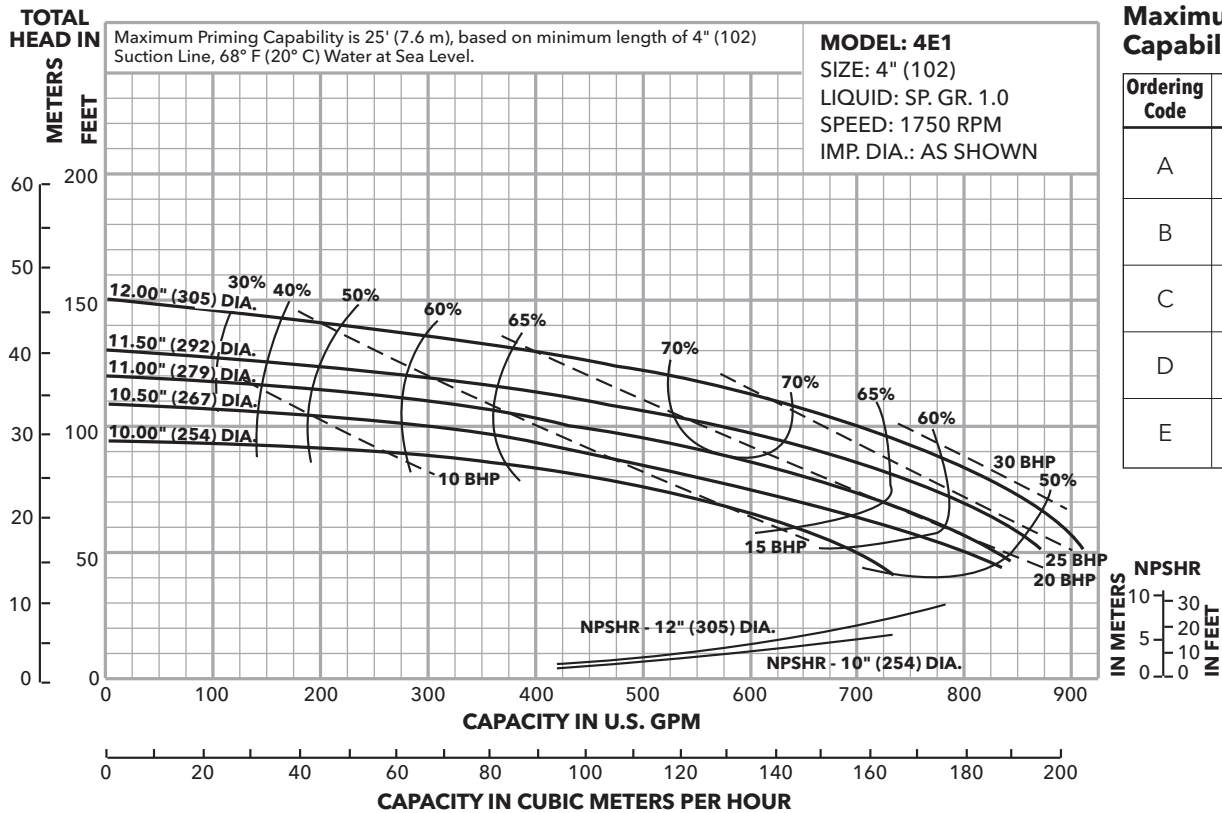

Maximum Priming Capability is:

Ordering Code	Imp. Dia.	Max. Lift
A	12.0" (305)	25' (7.6 m)
B	11.5" (292)	22' (6.7 m)
C	11.0" (279)	19' (5.8 m)
D	10.5" (267)	17' (5.2 m)
E	10.0" (254)	16' (4.9 m)

Prime Line® Performance Curves - Size 4E1, 50 Hz, 1450 RPM

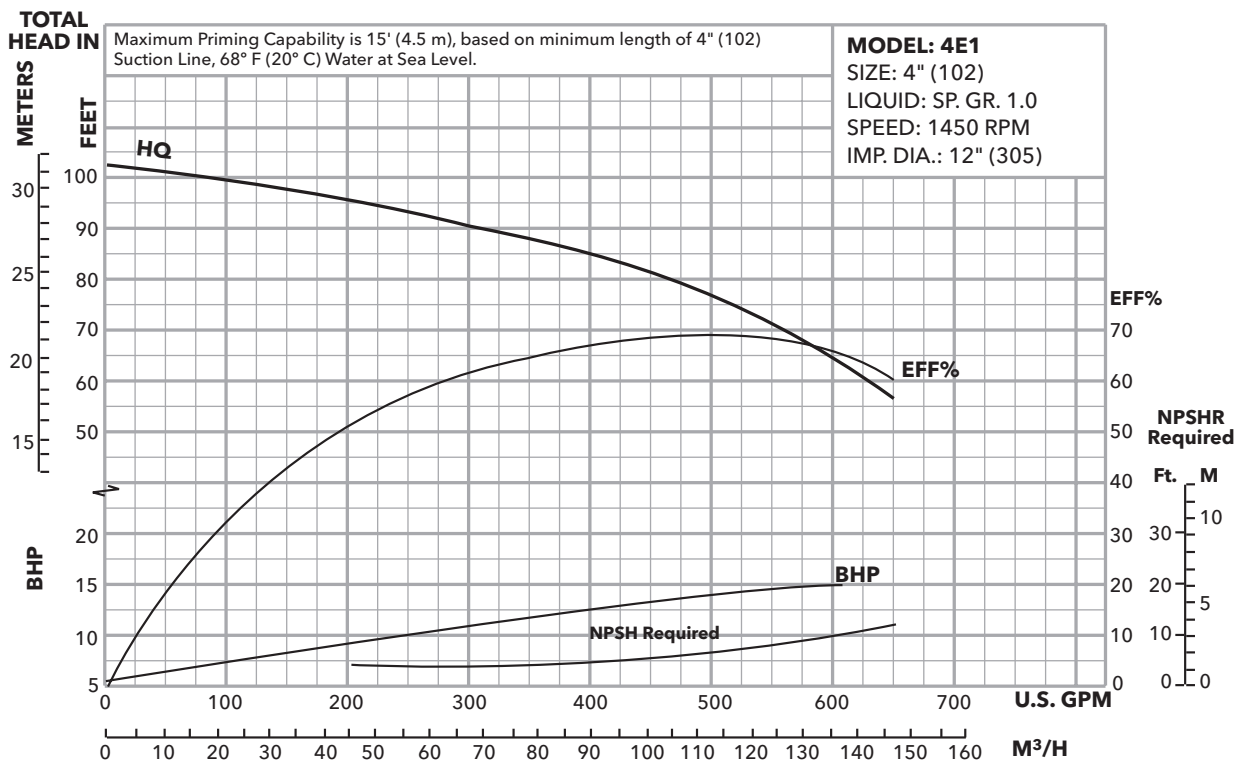

Prime Line® Performance Curves - Size 4E1, 60 Hz, 1150 RPM

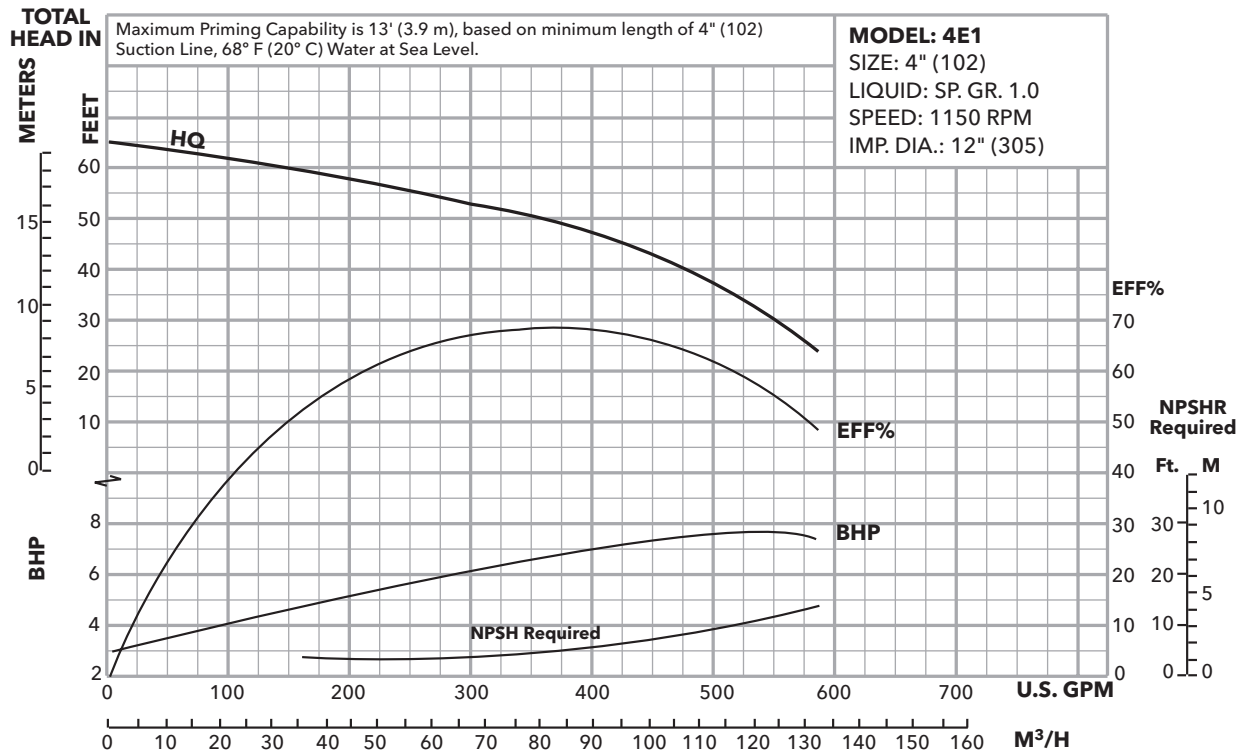

Prime Line® Performance Curves - Size 6E1, 60 Hz, 1750 RPM

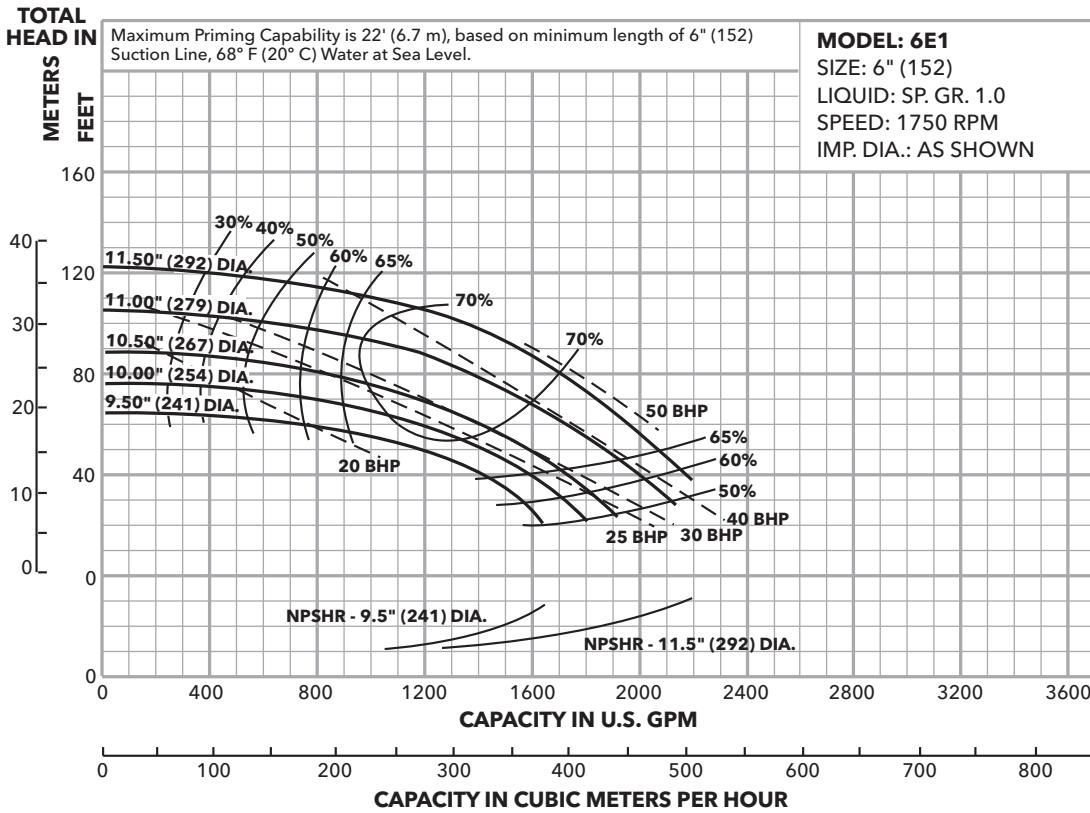

Maximum Priming Capability is:

Ordering Code	Imp. Dia.	Max. Lift
A	11.5" (292)	22' (6.7 m)
B	11.0" (279)	20' (6.1 m)
C	10.5" (267)	16' (4.8 m)
D	10.0" (254)	16' (4.8 m)
E	9.5" (241)	15' (4.5 m)

Prime Line® Performance Curves - Size 6E1, 50 Hz, 1450 RPM

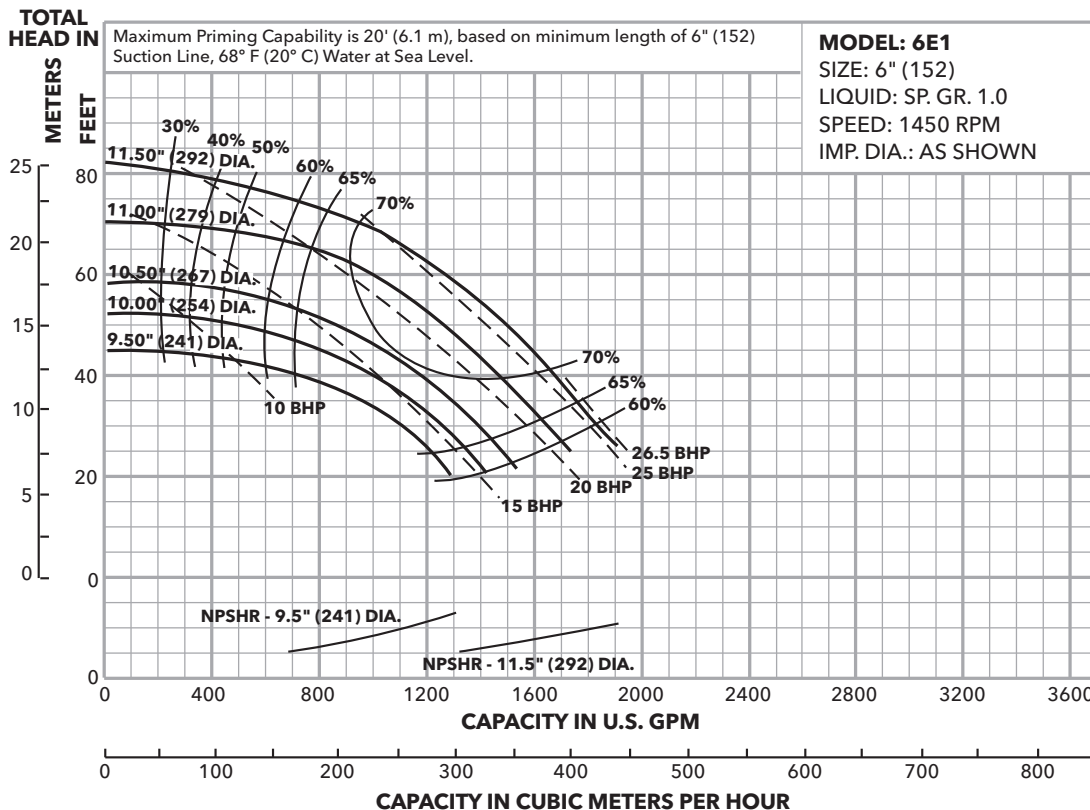

Maximum Priming Capability is:

Ordering Code	Imp. Dia.	Max. Lift
A	11.5" (292)	20' (6.1 m)
B	11.0" (279)	17' (5.2 m)
C	10.5" (267)	14' (4.2 m)
D	10.0" (254)	14' (4.2 m)
E	9.5" (241)	13' (3.9 m)

Prime Line® Performance Curves - Size 6E1, 60 Hz, 1150 RPM

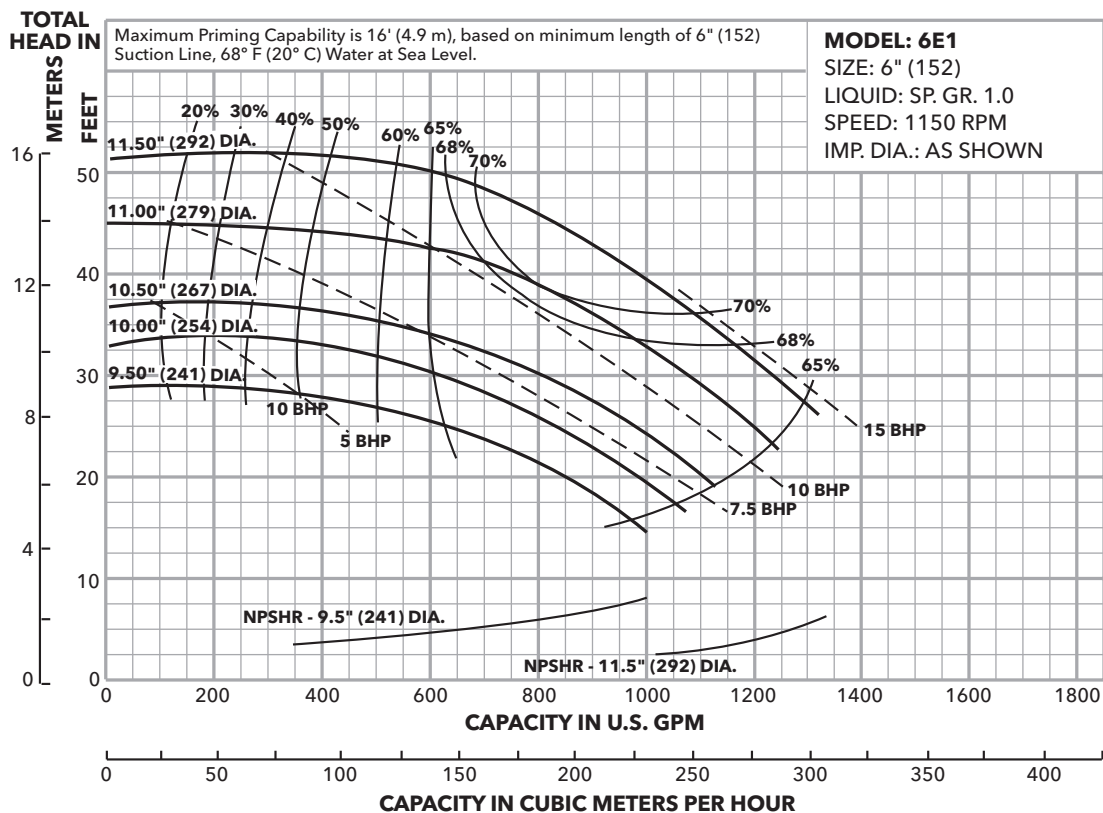

Maximum Priming Capability is:

Ordering Code	Imp. Dia.	Max. Lift
A	11.5" (292)	16' (4.9 m)
B	11.0" (279)	13' (3.9 m)
C	10.5" (267)	11' (3.3 m)
D	10.0" (254)	11' (3.3 m)
E	9.5" (241)	10' (3.0 m)

Prime Line® Performance Curves - Size 6E2, 60 Hz, 1750 RPM

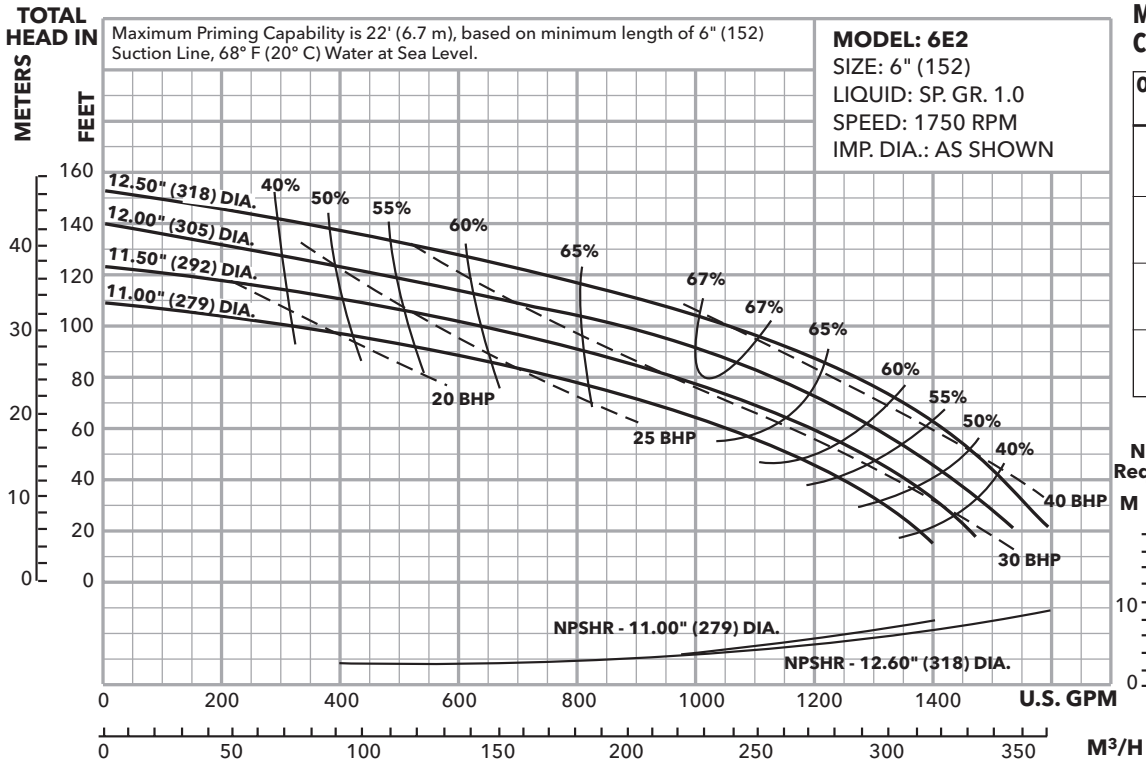

Maximum Priming Capability is:

Ordering Code	Imp. Dia.	Max. Lift
A	12.5" (318)	22' (6.7 m)
B	12.0" (305)	18' (5.5 m)
C	11.5" (292)	14' (4.3 m)
D	11.0" (279)	10' (3.0 m)

Prime Line® Performance Curves - Size 6E2, 50 Hz, 1450 RPM

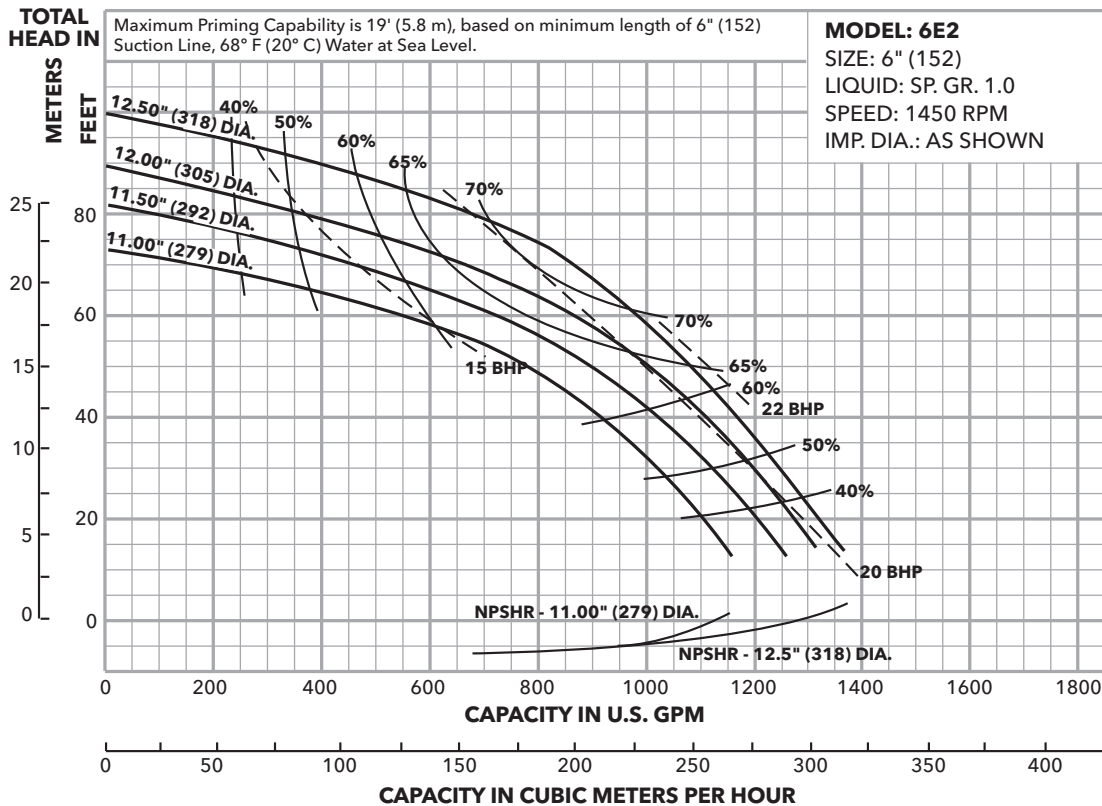

Maximum Priming Capability is:

Ordering Code	Imp. Dia.	Max. Lift
A	12.5" (318)	19' (5.8 m)
B	12.0" (305)	15' (4.5 m)
C	11.5" (292)	12' (3.6 m)
D	11.0" (279)	9' (2.7 m)

Prime Line® Performance Curves - Size 6E2, 60 Hz, 1150 RPM

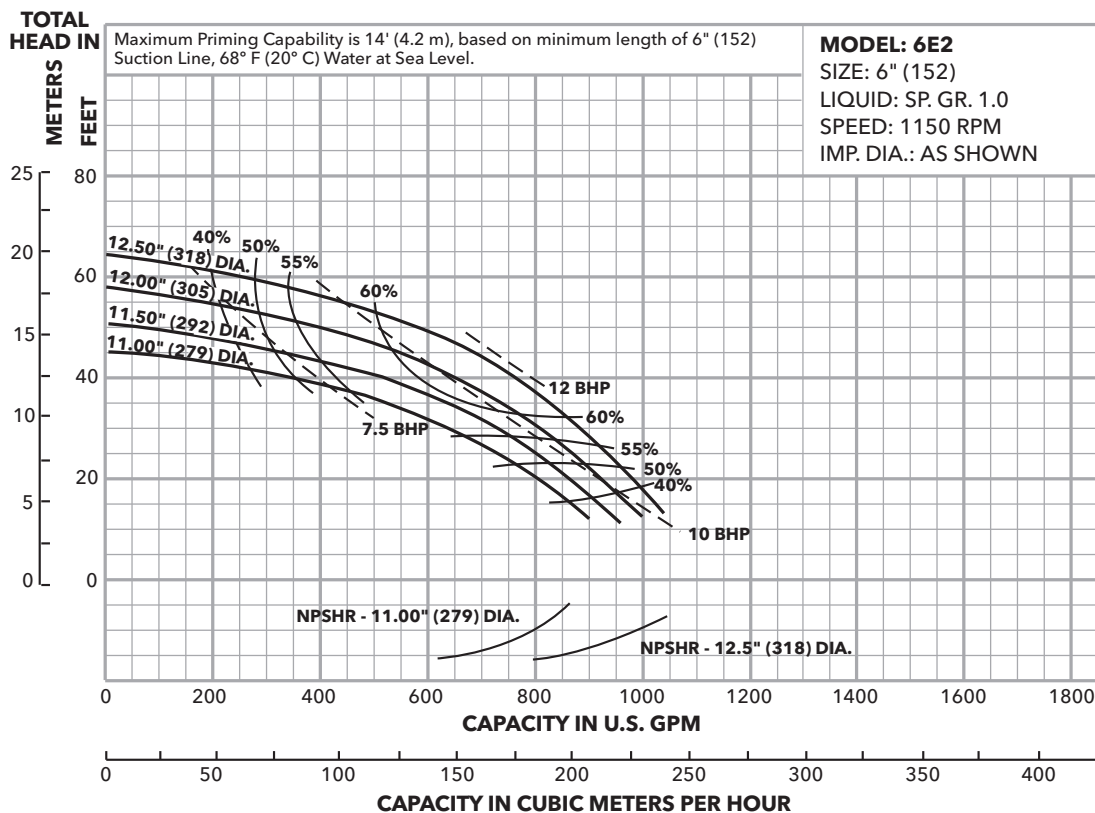

Maximum Priming Capability is:

Ordering Code	Imp. Dia.	Max. Lift
A	12.5" (318)	14' (4.2 m)
B	12.0" (305)	10' (3.0 m)
C	11.5" (292)	9' (2.7 m)
D	11.0" (279)	8' (2.4 m)

Prime Line® Dimensions – 2P - 4P Pump End

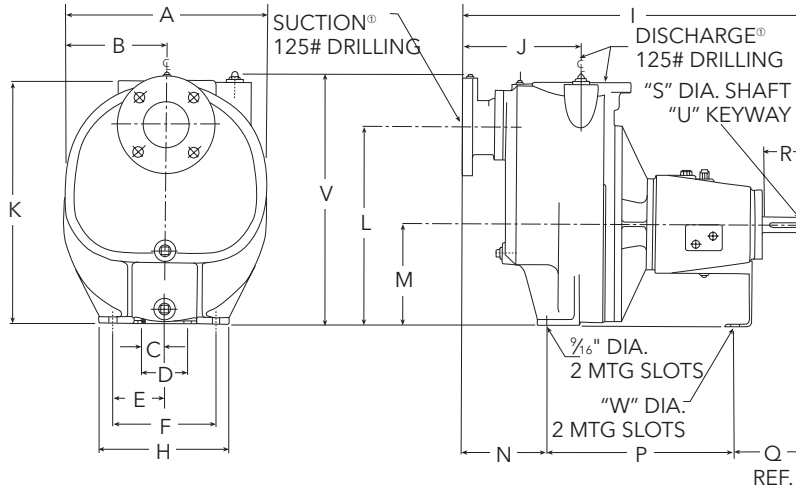

Pump End

Model	Suction®	Discharge®	A	B	C	D	E	F	H	I	J	K	L	M	N	P	Q	R	S	U	V	W
2P1	2" NPT Female (51)	2" NPT Female (51)	12¼ (311)	6⅝ (156)	1	2	4 (102)	8 (203)	10 (254)	23½ (597)	8⅛ (227)	17 (432)	13⅝ (253)	6¼ (159)	5⅝ (143)	11⅞ (292)	6⅝ (165)	3 (76)	1⅝ (29)	¼ x ⅝ (6 x 3)	17⅞ (446)	½
2P2										24¼ (616)	9⅝ (232)	19 (483)	15½ (394)	8 (203)	6⅞ (167)	11⅞ (286)						
2P3										32⅞ (838)	32⅞ (838)	32⅞ (838)	18⅝ (464)	18⅝ (464)	18⅝ (464)	18⅝ (464)						
2P4										32⅞ (838)	32⅞ (838)	32⅞ (838)	18⅝ (464)	18⅝ (464)	18⅝ (464)	18⅝ (464)						
3P1	3" (76)	3" (76)	15½ (391)	7¾ (197)	1	2	6¼ (159)	12½ (318)	15 (381)	35⅝ (902)	11⅞ (294)	23½ (597)	18 (457)	10 (254)	8⅞ (217)	19½ (495)	7⅝ (191)	3⅝ (101)	1⅝ (41)	⅝ x ⅜ (10 x 5)	24⅞ (611)	½
3P2										24¼ (616)	9⅝ (232)	19 (483)	15½ (394)	8 (203)	6⅞ (167)	11⅞ (286)						
3P3										32⅞ (838)	32⅞ (838)	32⅞ (838)	18⅝ (464)	18⅝ (464)	18⅝ (464)	18⅝ (464)						
3P4										32⅞ (838)	32⅞ (838)	32⅞ (838)	18⅝ (464)	18⅝ (464)	18⅝ (464)	18⅝ (464)						
4P1	4" (102)	4" (102)	19¼ (489)	9⅝ (245)	1	2	6¼ (159)	12½ (318)	15 (381)	35⅝ (902)	11⅞ (294)	23½ (597)	18 (457)	10 (254)	8⅞ (217)	19½ (495)	7⅝ (191)	3⅝ (101)	1⅝ (41)	⅝ x ⅜ (10 x 5)	24⅞ (611)	½
4P2																						

① 125# drilling except 2PL series (2" NPT female)

All dimensions are in inches and millimeters (mm). Do not use for construction purposes.

Prime Line® Dimensions – 2P - 4P Frame Mounted

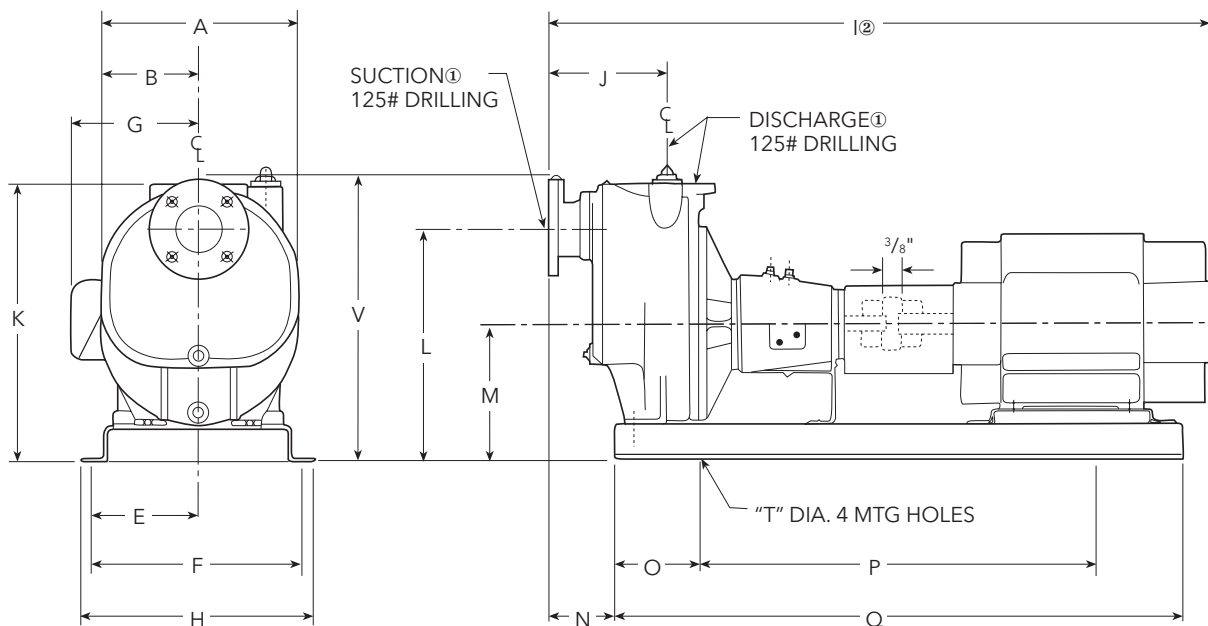

Pump, Base, Coupling and Guard

Model	Frame	Suction ①	Discharge ①	A	B	E	F	Open G	Encl. G	H	I ^②	J	K	L	M	N	O	P	Q	T	V
2P1 2P2 2P3 2P4	143T	2" NPT Female (51)	2" NPT Female (51)	12¼ (311)	6½ (156)	7½ (191)	15 (381)	-	6½ (165)	17 (432)	38¾(972)	8½ (227)	19½ (495)	16¾ (416)	8¾ (222)	4¾ (118)	26 (660)	42 (1067)	1¼ (18)	22¾ (564)	20½ (509)
	145T							6¾(160)	39(991)												
	182T							7¼(195)	42¾(1076)												
	184T							8½(227)	46½(1181)												
	213T							-	6½(165)		38(965)										
	215T							6¾(160)	38¾(987)												
3P1 3P2	145T	3" (76)	3" (76)	15½ (391)	7¾ (197)	9½ (241)	19 (483)	-	6½ (165)	20½ (521)	47¾(1213)	9¾ (232)	21½ (546)	18 (457)	10½ (267)	4¾ (121)	8 (203)	32 (813)	48 (1219)	1¼ (18)	22¾ (564)
	182T							6¾(160)	48¾(1229)												
	184T							7¼(195)	51¾(1315)												
	213T							8½(227)	55(1397)												
	215T							11½(292)	11¾(302)		60¼(1530)										
	254T							13¾(344)	14¼(357)		61¼(1556)										
3P3 3P4	145T	4" (102)	4" (102)	19¼ (489)	9¾ (245)	11½ (292)	13¾ (344)	-	6½ (165)	17 (432)	47¾(1213)	11¾ (294)	26 (660)	20½ (521)	12½ (318)	7½ (191)	32 (813)	48 (1219)	1¼ (18)	22¾ (564)	
	182T							6¾(160)	48¾(1229)												
	184T							7¼(195)	51¾(1315)												
	213T							8½(227)	55(1397)												
	215T							11½(292)	11¾(302)		60¼(1530)										
	254T							13¾(344)	14¼(357)		61¼(1556)										
4P1 4P2	213T	4" (102)	4" (102)	19¼ (489)	9¾ (245)	11½ (292)	13¾ (344)	-	6½ (165)	17 (432)	47¾(1213)	11¾ (294)	26 (660)	20½ (521)	12½ (318)	7½ (191)	32 (813)	48 (1219)	1¼ (18)	22¾ (564)	
	215T							6¾(160)	48¾(1229)												
	254T							7¼(195)	51¾(1315)												
	256T							8½(227)	55(1397)												

① 125# drilling except 2PL series (2" NPT female).

② Actual dimension may vary depending on motor.

All dimensions are in inches and millimeters (mm). Do not use for construction.

Prime Line® Dimensions – 2P - 4P Close Coupled

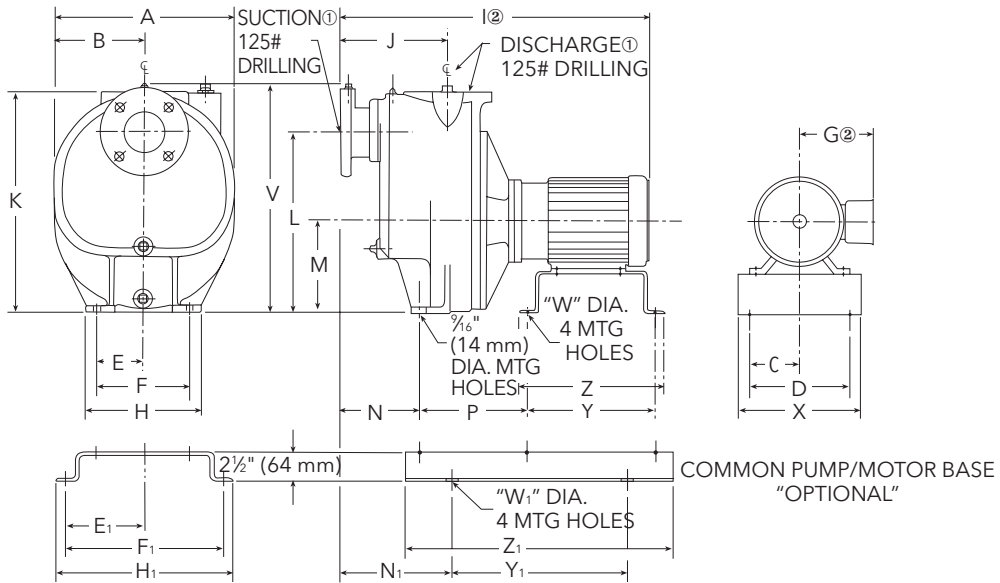

Close Coupled

Model	Frame	Suct. ①	Disch. ①	A	B	C	D	E	F	G	H	I ②	J	K	L	M	N	P	V	W	X	Y	Z	With Pump - Motor Base																									
																								E ₁	F ₁	H ₁	N ₁	W ₁	Y ₁	Z ₁																			
2P1 2P2 2P3 2P4	143JM	2" NPT Female (51)	2" NPT Female (51)	12¼ (311)	6¼ (156)	4⅞ (116)	9 (232)	4	8	6⅞ (176)	10 (254)	23¼ (591)	8⅞ (227)	17 (432)	13⅞ (353)	6¼ (159)	5⅞ (143)	9⅞ (245)	17⅞ (446)	⅞x⅞ (14x22)	10½	11 (279)	12⅞ (314)	6⅞ (168)	13¼ (337)	14¼ (375)	8⅞ (219)	⅞ (14)	15 (381)	23 (584)																			
	145JM					3	6 (152)					6⅞ (176)						27⅞ (694)		9⅞ (236)	⅞x⅞ (11x18)	10½	11⅞ (267)								11⅞ (292)																		
	182JM					3	6 (152)					6⅞ (176)						27⅞ (694)		9⅞ (236)	⅞x⅞ (11x18)	10½	11⅞ (267)								11⅞ (292)																		
	184JM					3	6 (152)					6⅞ (176)						27⅞ (694)		9⅞ (236)	⅞x⅞ (11x18)	10½	11⅞ (267)								11⅞ (292)																		
	213JP					4⅞ (108)	8⅞ (216)					8⅞ (210)						33¼ (845)		5⅞ (143)	16⅞ (422)	⅞ (11)	9⅞ (241)								5½ (140)	7 (187)	7⅞ (194)	15¼ (387)	16¼ (425)	10⅞ (270)	1⅞ (18)	18 (457)	30 (762)										
	215JP					37⅞ (962)	9⅞ (252)					17⅞ (435)						⅞ (13)		11⅞ (289)	7 (178)	8⅞ (226)	8⅞ (226)								10⅞ (270)	10⅞ (270)																	
	254JP					5	10 (254)					9⅞ (252)						37⅞ (962)		17⅞ (435)	⅞ (13)	11⅞ (289)	7 (178)								8⅞ (226)	8⅞ (226)																	
256JP	5	10 (254)	9⅞ (252)	39⅞ (1007)	17⅞ (435)	⅞ (13)	11⅞ (289)	7 (178)	8⅞ (226)	8⅞ (226)																																							
3P1 3P2 3P3 3P4	3" (76)	3" (76)	15½ (391)	7⅞ (197)	4	8	10 (254)	9⅞ (252)	15¼ (387)	16¼ (425)	11⅞ (294)	18 (457)	8	6⅞ (167)	19⅞ (500)	14¼ (362)	17⅞ (443)	17⅞ (443)	19⅞ (500)	⅞x⅞ (14x22)	11¼ (298)	11½ (292)	12⅞ (327)	7⅞ (194)	15¼ (387)	16¼ (425)	11⅞ (294)	18 (457)	30 (762)																				
143JM																														6⅞ (156)	24⅞ (611)	9½ (241)								10½	11	12⅞ (314)	6⅞ (168)	13¼ (337)	14¼ (375)	9⅞ (243)	⅞ (14)	15 (381)	23 (584)
145JM																														6⅞ (156)	24⅞ (611)	9½ (241)								10½	11	12⅞ (314)	6⅞ (168)	13¼ (337)	14¼ (375)	9⅞ (243)	⅞ (14)	15 (381)	23 (584)
182JM																														4⅞ (116)	9 (232)	9¼ (235)	10½	11	12⅞ (314)	6⅞ (168)	13¼ (337)	14¼ (375)	9⅞ (243)	⅞ (14)	15 (381)	23 (584)							
184JM																														4⅞ (116)	9 (232)	9¼ (235)	10½	11	12⅞ (314)	6⅞ (168)	13¼ (337)	14¼ (375)	9⅞ (243)	⅞ (14)	15 (381)	23 (584)							
213JP																														8⅞ (210)	36 (914)	14¼ (365)	⅞x⅞ (14x22)	11¼ (298)	11½ (292)	12⅞ (327)	7⅞ (194)	15¼ (387)	16¼ (425)	11⅞ (294)	18 (457)	30 (762)							
215JP																														36 (914)	39⅞ (994)	14¼ (362)	⅞x⅞ (14x22)	11¼ (298)	11½ (292)	12⅞ (327)	7⅞ (194)	15¼ (387)	16¼ (425)	11⅞ (294)	18 (457)	30 (762)							
254JP	9⅞ (252)	40⅞ (1038)	14¼ (362)	⅞x⅞ (14x22)	11¼ (298)	11½ (292)	12⅞ (327)	7⅞ (194)	15¼ (387)	16¼ (425)	11⅞ (294)	18 (457)	30 (762)																																				
256JP	5½	11 (279)	10⅞ (270)	⅞ (13)	12⅞ (327)	11 (279)	13¼ (349)	9⅞ (243)	12⅞ (314)	13¼ (349)	11⅞ (294)	18 (457)	30 (762)																																				
284JP	41⅞ (1051)	17⅞ (443)	17⅞ (443)	⅞ (13)	12⅞ (327)	11 (279)	13¼ (349)	9⅞ (243)	12⅞ (314)	13¼ (349)	11⅞ (294)	18 (457)	30 (762)																																				
286JP	42⅞ (1089)	17⅞ (443)	17⅞ (443)	⅞ (13)	12⅞ (327)	11 (279)	13¼ (349)	9⅞ (243)	12⅞ (314)	13¼ (349)	11⅞ (294)	18 (457)	30 (762)																																				
324JP	6¼ (159)	12⅞ (318)	14⅞ (357)	17⅞ (443)	⅞ (13)	12⅞ (327)	11 (279)	13¼ (349)	9⅞ (243)	12⅞ (314)	13¼ (349)	18 (457)	30 (762)																																				
4P1 4P2	213JP 215JP 254JP 256JP	4" (102)	4" (102)	19¼ (489)	9⅞ (245)	6⅞ (159)	12½ (318)	15 (381)	12½ (318)	8⅞ (210)	15 (381)	11⅞ (294)	23½ (597)	18 (457)	10 (254)	8⅞ (217)	24⅞ (611)	15¼ (387)	⅞x⅞ (14x22)	11¼ (298)	11½ (292)	12⅞ (327)	9⅞ (238)	18¼ (476)	20¼ (527)	11⅞ (294)	21 (533)	33 (838)																					
213JP																													37⅞ (948)	15¼ (387)	11¼ (298)	11½ (292)	12⅞ (327)																
215JP																													38⅞ (986)	15¼ (387)	11¼ (298)	11½ (292)	12⅞ (327)																
254JP																													41⅞ (1065)	15¼ (387)	11¼ (298)	11½ (292)	12⅞ (327)																
256JP	43⅞ (1110)	15¼ (387)	11¼ (298)	11½ (292)	12⅞ (327)																																												

① 125# drilling except 2PL series (2" NPT female).

All dimensions are in inches and millimeters (mm). Do not use for construction purposes.

② Actual dimension may vary depending on motor.

Prime Line® Dimensions – 4E - 6E

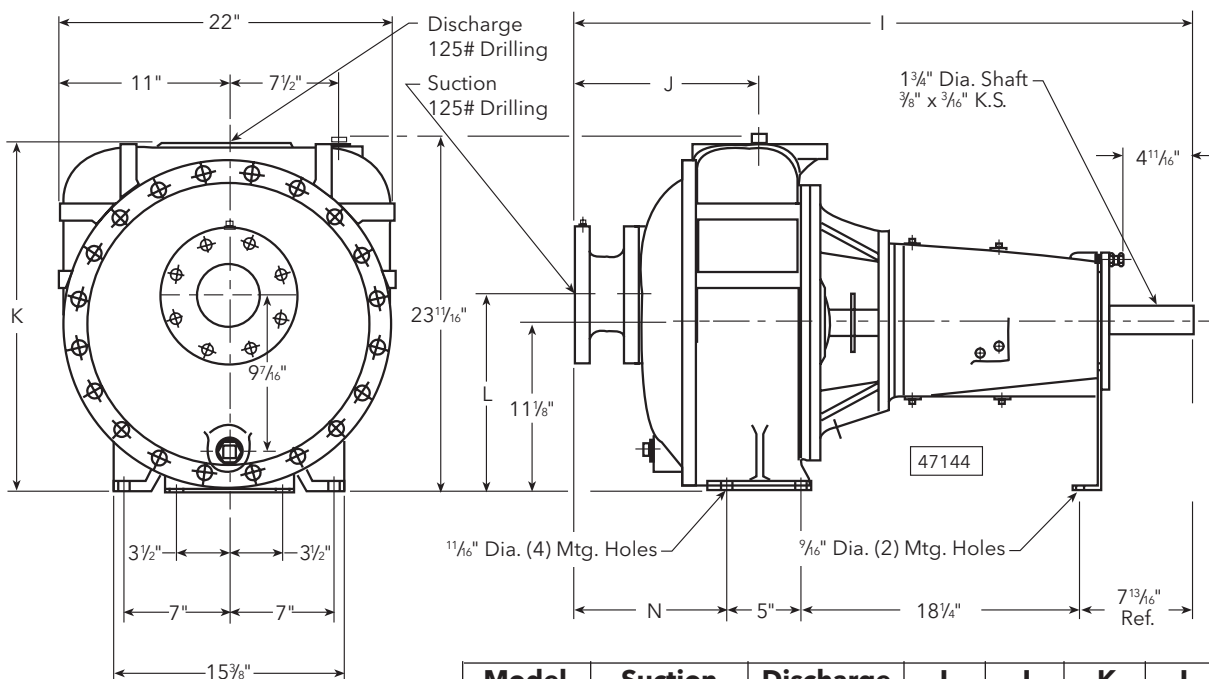

Model	Suction	Discharge	I	J	K	L	N
4E	4	4	40 ⁷ / ₈	12 ⁵ / ₁₆	23	13	9 ¹³ / ₁₆
6E	6	6	44 ⁵ / ₁₆	15 ³ / ₄	24 ¹ / ₂	11 ³ / ₈	13 ¹ / ₄

Pump, Base, Coupling and Motor

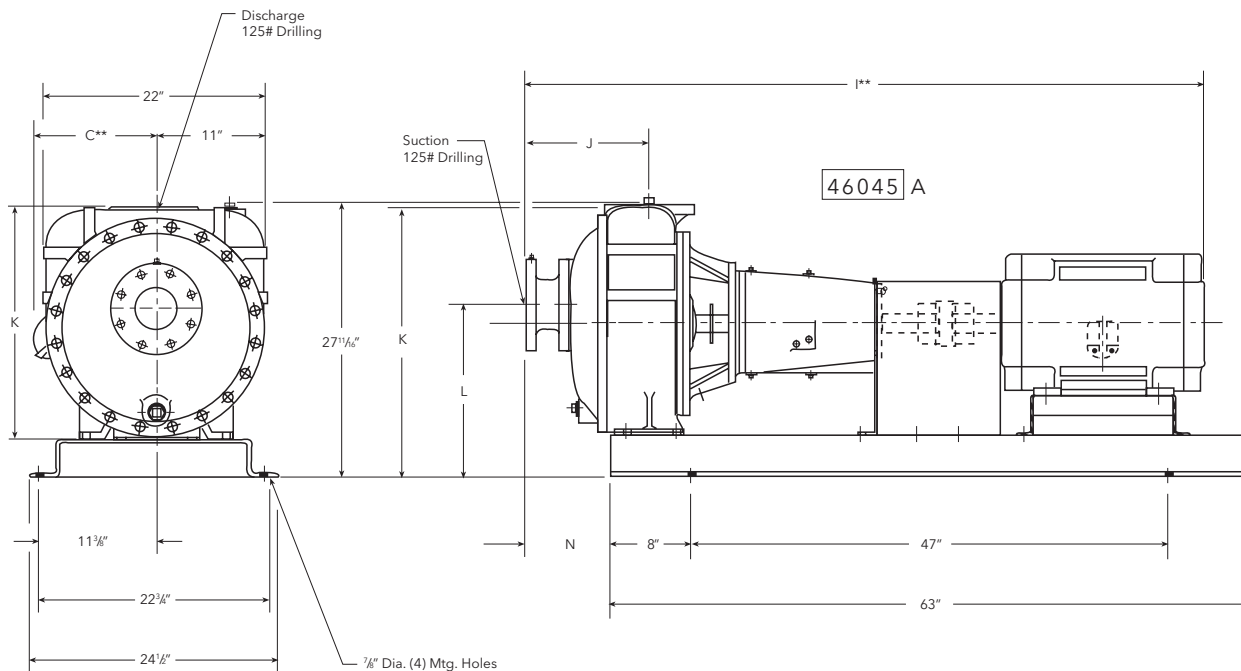

Model	Suction	Discharge	Frame	C**	I**	J	K	L	N
4E	4	4	254T	8 ¹⁵ / ₁₆	63 ³ / ₁₆	12 ⁵ / ₁₆	27	17	8 ⁵ / ₁₆
			256T		63 ¹⁵ / ₁₆				
			284T	11 ¹ / ₂	65 ⁷ / ₁₆				
			286T		66 ¹⁵ / ₁₆				
6E	6	6	256T	8 ¹⁵ / ₁₆	67 ³ / ₈	15 ³ / ₄	28 ¹ / ₂	15 ³ / ₈	11 ³ / ₄
			284T	11 ¹ / ₂	68 ⁷ / ₈				
			286T		70 ³ / ₈				
			324T	13 ⁹ / ₁₆	71 ⁹ / ₁₆				
			326T		73 ¹ / ₁₆				

Prime Line® Specifications – 2P - 4P

Mechanical Data

	2P1	2P2	2P3	2P4	3P1	3P2	3P3	3P4	4P1	4P2
Suction and discharge port sizes, inches (mm)	2 (51) NPT				3 (76) Flanged				4 (102) Flanged	
Flanged, flat face	Female threaded connection				125 PSI (8.79 kg/cm ²)					
Minimum casing thickness, inches (mm)	$\frac{3}{8}$ (10)									
Maximum working pressure	85 PSI				115 PSI				60 PSI	
Maximum hydrostatic test pressure (refer to note #4)	130 PSI				170 PSI				90 PSI	
Maximum diameter solids (spherical), inches (mm)	$\frac{1}{2}$ (13)	$\frac{7}{16}$ (11)	$\frac{7}{16}$ (11)	$\frac{5}{8}$ (8)	$\frac{7}{16}$ (11)	$\frac{9}{16}$ (14)	$\frac{3}{4}$ (16)	$\frac{1}{2}$ (13)	$\frac{9}{16}$ (14)	$\frac{5}{8}$ (14)
Shaft Diameter										
a) At impeller (nominal), inches (mm)	$\frac{7}{8}$ (22)						1 $\frac{1}{4}$ (32)			
b) At mechanical seal, inches (mm)	1 $\frac{1}{4}$ (32)						1 $\frac{5}{8}$ (41)			
c) Between bearings, inches (mm)	1 $\frac{5}{8}$ (41)						2 $\frac{5}{8}$ (59)			
d) At coupling, inches (mm)	1 $\frac{1}{8}$ (29)						1 $\frac{5}{8}$ (41)			
Maximum shaft deflection at shaft seal faces, inches (mm)	Does not exceed .002 (.05)									
Bearing Housing										
a) Front radial bearing	6207						6309			
b) Rear thrust bearing	6307						5310			
c) Bearing centers, inches (mm)	4 $\frac{1}{8}$ (110)						6 $\frac{1}{8}$ (175)			
Minimum distance required to remove bearing housing assembly with impeller, stuffing box/seal plate and bracket (back pull-out) (refer to note #1), inches (mm)	4 (102)								5 (127)	
Maximum temperature of liquid pumped for normal seal operation	200°F (93°C)									
Speed range, RPM	1450 to 2150	2400 to 3450			1450 to 2150	2400 to 3450	1750 to 3450		1150 to 2400	
Static priming lift, with full diameter impeller at maximum allowable operating speed and with suction check valve (refer to note #2)	25 feet (7.6 m)									
Minimum B ₁₀ life hours (refer to note #3)	20,000 hrs +									
Weight, pump end only, lbs. (kg)	176 (80)	169 (76)	176 (80)	176 (80)	250 (113)	235 (106)	294 (133)	294 (133)	410 (186)	400 (182)
Weight, back pull-out section (bearing housing, stuffing box/seal plate impeller, seal assembly, shaft, bearings, etc.), lbs. (kg)	75 (34)	72 (32)	75 (34)	75 (34)	100 (45)	90 (41)	160 (73)	160 (73)	185 (84)	175 (80)
Shipping weight, PEO, lbs. (kg)	190 (86)	185 (84)	190 (86)	190 (86)	275 (125)	260 (118)	310 (141)	310 (141)	425 (193)	415 (188)

NOTES:

1. Distance shown required for removal of complete back pull-out assembly straight out of pump casing.
2. Based on nominal pipe size with 5 feet (1.5 m) horizontal length, zero discharge head and 68°F (20°C) water temperature at sea level.
3. Based on an operating point at 50% of BEP capacity.
4. Without check valve or check valve partially open.

Prime Line® Specifications – 4E1, 6E1, 6E2

Mechanical Data

	4E1	6E1	6E2
Suction and discharge port sizes, inches	4" x 4"	6" x 6"	6" x 6"
Flanged, flat face, PSI	125	125	125
Minimum casing thickness, inches	½	½	½
Maximum working pressure, PSI	125	65	145
Maximum hydrostatic test pressure (refer to note #4)	185	95	215
Type of impeller	Enclosed	Open	Enclosed
Maximum diameter solids (spherical), inches	½	1	1
Shaft Diameter			
a) At impeller (nominal), inches	1¾		
b) At mechanical seal, inches	1¾		
c) Between bearings, inches	3		
d) At coupling, inches	1¾		
Maximum shaft deflection at shaft seal faces, inches	Does not exceed .002		
Bearing Housing			
a) Front radial bearing, single row	#313		
b) Rear thrust bearing, single row	#313		
c) Bearing centers, inches	10.040		
Minimum distance required to remove bearing housing assembly with impeller, stuffing box/seal plate and bracket (back pull-out) (refer to note #1), inches	5½		
Maximum temperature of liquid pumped for normal seal operation	200°F (93°C)		
Speed range, RPM	1150 to 2400	1150 to 2000	1150 to 2600
Static priming lift, with full diameter impeller at maximum allowable operating speed and with suction check valve (refer to note #2)	25 feet	22 feet	22 feet
Oil capacity for oil lube bearings (bearing housing)	Approx. 52 fl. oz.		
Minimum L ₁₀ life, hours (refer to note #3)	24,000		
Weight, pump end only, lbs.	550	610	620
Weight, back pull-out section (bearing housing, stuffing box/seal plate impeller, seal assembly, shaft, bearings, etc.), lbs.	400	460	470
Shipping weight, PEO, lbs.	580	640	650

NOTES:

1. Distance shown required for removal of complete back pull-out assembly straight out of pump casing.
2. Based on nominal pipe size with 5 feet (1.5 m) horizontal length, zero discharge head and 68°F (20°C) water temperature at sea level.
3. Based on an operating point at 50% of BEP capacity.
4. Without check valve or check valve partially open.

Xylem |'zīləm|

- 1) The tissue in plants that brings water upward from the roots;
- 2) a leading global water technology company.

We're a global team unified in a common purpose: creating innovative solutions to meet our world's water needs. Developing new technologies that will improve the way water is used, conserved, and re-used in the future is central to our work. We move, treat, analyze, and return water to the environment, and we help people use water efficiently, in their homes, buildings, factories and farms. In more than 150 countries, we have strong, long-standing relationships with customers who know us for our powerful combination of leading product brands and applications expertise, backed by a legacy of innovation.

For more information on how Xylem can help you, go to www.xylem.com



Xylem Inc.
2881 East Bayard Street Ext., Suite A
Seneca Falls, NY 13148
Phone: (800) 453-6777
Fax: (888) 322-5877
www.gouldswatertechnology.com

Goulds is a registered trademark of Goulds Pumps, Inc. and is used under license.
© 2015 Xylem Inc. BPRIMELINE R1 July 2015