



CRN1 HS

Parts List & Kits

Contents

- Parts List
- Spare Part Kits
- Accessories
- Special Tools
- Standard Tools
- Tools for Torques

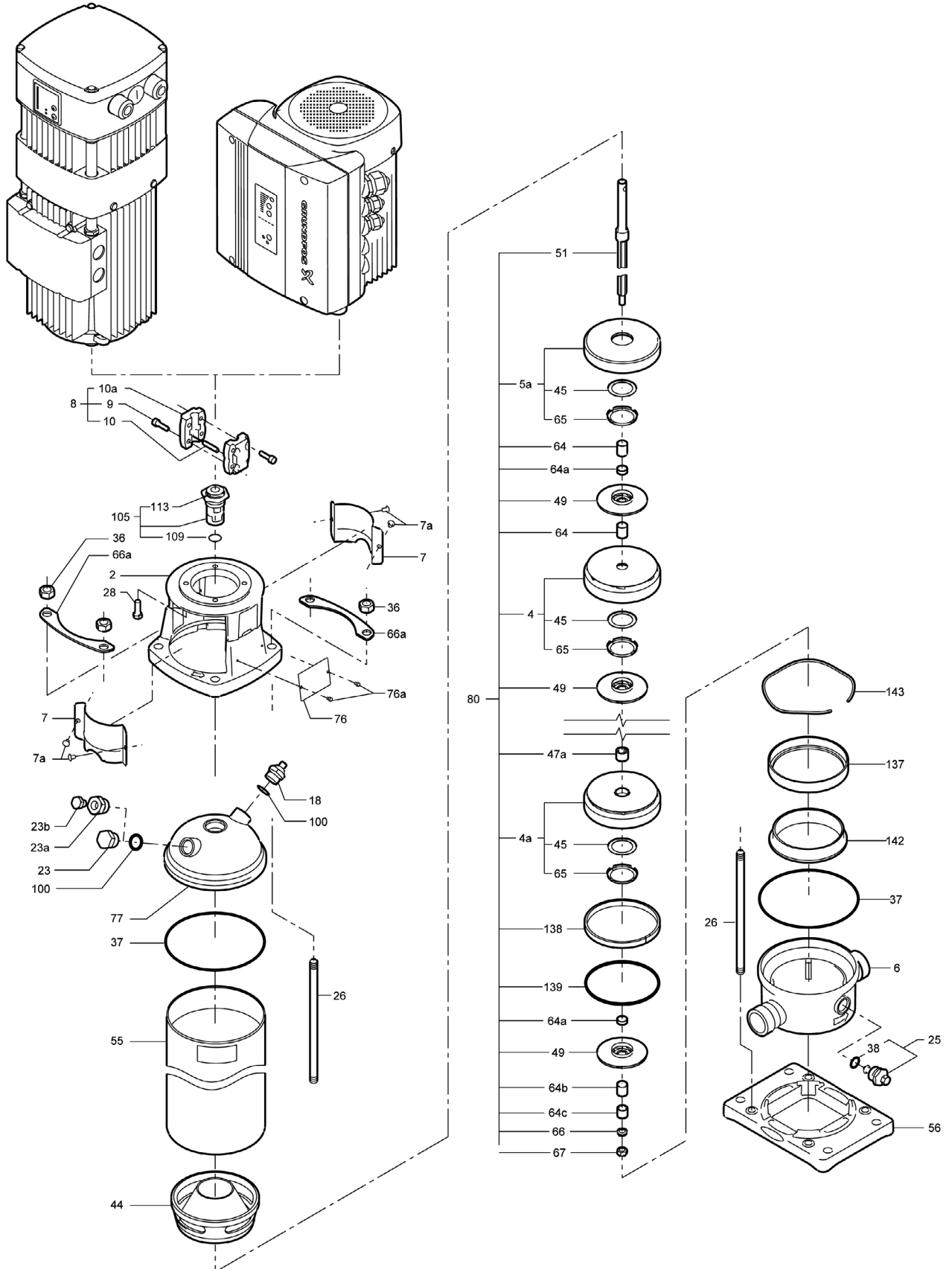

Parts List & Kits CRN1 HS

Pos. No.	Part Description	Model	Stages	No. Used	Comments/Dimensions	B.O.M. Ref. No.	Material No.	Included in kits?
2	Motor Stool		23	1	IEC, F130, MG 100/112, 3.0 - 4.0 kW	96436509		No
4	Reinforced Chamber, Complete with Pos.45 & 65		23	19	PTFE Pos.45	96475578		No
4a	Reinforced Cmb. Cpl. w/Pos.45 & 65 & Bearing		23	3	Silicon Carbide Bearing, PTFE Pos.45	96475577		YES
5a	Reinforced Bottom. Cmb. Cpl. with Pos.45 & 65		23	1	PTFE Pos.45	96475576		No
6	Base		23	1	Victualic (PJE) 1.25", Stainless (Max 362 PSI)	96460189		No
7	Coupling Guard		23	2	NEMA-56C, IEC-F115,130, & 265	96438137		YES
7a	Screw for Coupling Guard		23	4	M4 x 8mm	96488481		YES
9	Allen Screw		23	4	M8 x 25mm, Delta Seal	001D7900		YES
10	Shaft Pin		23	1	ø5 x 26mm	310192		YES
10a	Coupling Half		23	2	IEC, F130, MG100/112, 3-4 kW.ø28/ø12	410047		YES
18	Priming/Vent Plug		23	1	G 1/2A, NV24 with NV9 x M8 stem	405150	96505133	YES
23	Plug (option)		23	1	G 1/2A, Solid no port, NV24	370025	96505133	YES
23a	Plug		23	1	G 1/2A, w/1/4" port, NV24	91120659	96511103	No
23b	Pipe Plug for Pos.23 & 25 with hollow stem		23	1	1/4" NPT,SS SQHD	001D7216		No
25	Drain/Priming Plug Cpl. with O-rings		23	1	G 1/2A, NV24 w/NV9 x M8 stem, EPDM	96440611	96588243	No
	Drain/Priming Plug Cpl. with O-rings (option)		23	1	G 1/2A, NV24 w/NV9 x M8 stem, FKM	96446891		No
	Dr./Pr. Plug Cpl. for gauge, w/O-rings (option)		23	1	G 1/2A, NV24 w/NV9 x M8 stem, FXM	96460009		No
			23	1	G 1/2A, NV24 w/NV9 x M8 stem, FFKM	96475474		No
			23	1	G 1/2A, NV24 w/NV9 x M8 hollow stem, EPDM	96527050		No
			23	1	G 1/2A, NV24 w/NV9 x M8 hollow stem, FKM	96527051		No
			23	1	G 1/2A, NV24 w/NV9 x M8 hollow stem, FXM	96549174		No
			23	1	G 1/2A, NV24 w/NV9 x M8 hollow stem, FFKM	96527052		No
26	Staybolt		23	4	M12 x 551mm	414146		No
28	Motor Bolt		23	4	IEC, F130, MG100/112, 3-4 kW. M8 x 25mm	001D8025		No
36	Staybolt Nut		23	4	19mm x M12, 316SS	001D0876		No
37	Sleeve O-ring		23	2	EPDM, ø137.5 x 3.3mm	96438743		YES
	Sleeve O-ring (option)		23	2	FKM, ø137.5 x 3.3mm	96438744		YES
			23	2	FKM, ø137.5 x 3.3mm	96458109		YES
			23	2	FFKM, ø136.12 x 3.53mm	96466718		YES
38	Drain Plug O-ring		23	1	EPDM, ø16.3 x 2.4mm	001D1288		YES
	Drain Plug O-ring (option)		23	1	FKM, ø16.3 x 2.4mm	001D2231		YES
			23	1	FFKM, ø16.3 x 2.4mm	96428162		YES
			23	1	FKM, ø16.3 x 2.4mm	96442869		YES
44	Inlet crown		23	1	Stainless	96464941		No
45	Neck Ring		23	23	ø41.3 x ø30.6 x .75mm, PTFE (96536194 qty. of 24)	400003	96536194	No
47a	Bearing Ring/Spacer		23	3	SiC 150, ø17.37 x ø13.10 x ø10.9 x 13mm	96437488	96547649	No
49	Impeller		23	23	ø73.6 x ø30.6 x 9.1mm (back-plate .5mm)	96440326		No
			23	23	ø73.6 x ø30.6 x 9.1mm (96547666 qty. of 24)	96440326	96547666	No
51	Shaft, Complete		23	1	ø12 x 556.5mm	96440405	96588237	No
55	Outer Sleeve		23	1	ø138 x 440.6mm	96441543		No
56	Base Plate N (Low) for PJE Pos. 6		23	1	Cast Stainless	96437870	98052563	No
64	Spacing Pipe		23	20	ø15.85 x ø12.85 x 17.525mm	400252		No
64a	Spacing Pipe		23	4	ø15.85 x ø12.85 x 4.5mm	96440292		No
			23	4	ø15.85 x ø12.85 x 4.5mm (96536450 qty. of 24)	96440292	96536450	No
64b	Spacing Pipe		23	1	ø15.85 x ø12.85 x 13.0mm	96443611		No
			23	1	ø15.85 x ø12.85 x 13.0mm (96536452 qty. of 24)	96443611	96536452	No
64c	Clamp, Splined		23	1	ø15 x ø13.10 x ø10.9 x 13.0mm	96439668		No
65	Neck Ring Retainer		23	23	ø43.5 x ø34.0 x 3.6mm	96438746		YES
66	Lock Washer Set for Shaft		23	1	ø13.5 x ø8.2 x 2.6mm	96417297		YES
66a	Reinforcing plate for staybolts		23	2	3.0mm	96461736		No
67	Lock Nut for Shaft		23	1	13mm x M8	001D2061		YES
76	Nameplate		23	1	304SS, 60 x 45mm	96439820		No
76a	Rivet for Nameplate		23	2	304SS, ø3 x 5mm	96022882		No
77	Pump Head Cover for Motor Stool Pos. 2		23	1	Cast Stainless	96436340	96588244	No
100	Priming/Vent Plug O-ring		23	2	EPDM, ø16.3 x 2.4mm	001D1288		YES
	Priming/Vent Plug O-ring (option)		23	2	FKM, ø16.3 x 2.4mm	001D2231		YES
			23	2	FFKM, ø16.3 x 2.4mm	96428162		YES
			23	2	FKM, ø16.3 x 2.4mm	96442869		YES
105	Shaft Seal HUUE		23	1	TC, TC, EPDM	96441875		YES
	Shaft Seal HUUV		23	1	TC, TC, FKM	96441876		YES
	Shaft Seal HUUF (option)		23	1	TC, TC, FXM	96475542		YES
	Shaft Seal HUUK (option)		23	1	TC, TC, FFKM	96467885		YES
109(a)	O-ring for Shaft Seal Pos. 105		23	1	EPDM, ø21.3 x 3.0mm	001D1798		YES
			23	1	FKM, ø21.2 x 3.0mm	001D2339		YES
109(a)	O-ring for Shaft Seal Pos. 105 (option)		23	1	FKM, ø22 x 2.75mm	96458111		YES
			23	1	FFKM, ø23.47 x 2.62mm	96464384		YES
137	Guide Ring		23	1	Stainless, ø114.0 x ø111.5 x 17.0mm	410191		No
138	Retainer for O-ring Pos. 139		23	1	PTFE, 333.0 x 9.0 x 3.0mm	400211		No
139	O-ring for Pos. 137 to 143		23	1	EPDM, ø102.0 x 4.0mm	96467802	96483490	YES
			23	1	FKM, ø102.0 x 4.0mm	96467803	96483491	YES
142	Guide Ring		23	1	Stainless, ø114.0 x ø102.9 x 25.0mm	410192		No
143	Corrugated Spring		23	1	Stainless, ø111.0 x 3.5mm	96463642		No

Due to part changes over time, all position numbers (1-203) may not be used.

This column indicates which model uses the spare part. If blank, the part is used in all models.

B.O.M. Ref. Number is only available if it is not included in a kit or does not have a material number listed. If it is included in a kit (YES), or has a material number, request one of these numbers. If not included in a kit (No), but has a Material Number, use Material Number.

Key to Symbols

KITS (YES) Recommended spare part
 ø Diameter
 ANSI American National Standards Institute
 CPL Complete Assembly – these parts consist of more than one component
 EPDM Ethylene Propylene (also known as EPR and EPT) – an elastic substance similar to rubber
 FFKM Kalrez Elastomer made by DuPont
 FKM Fluoro Elastomer (generic for Viton)
 FXM Fluoraz Elastomer made by Greene Tweed
 M International standard thread size designation (thread diameter in mm)

mm Millimeter
 MG Identifies Grundfos motor type/size
 N Stainless
 NBR Buna - N (also known as Nitrile) – an elastic substance similar to rubber
 NEMA National Electrical Manufacturers Association
 PTFE Teflon
 SiC Silicon Carbide
 TC Tungsten Carbide
 UNC Unified National Coarse – a standard for threads on bolts

Spare Part Kits

Since certain pump parts can be expected to exhibit wear at the same time as related pump parts, they have been grouped into the following kits for your convenience. The numbers indicate the quantity of the part within each kit. Please order these kits using the kit material number at the top of the columns.

STACK KITS	
Model	Material Number
CRN1-23 HS EPDM	96478701
CRN1-23 HS FKM	96478702

GASKET KIT (EPDM)		Kit No.	96455090	
GASKET KIT (FKM)		Kit No.	96455091	
GASKET KIT (FXM)		Kit No.	96463944	
GASKET KIT (FFKM)		Kit No.	96533328	
Pos. No.	Description	Material No.	Qty. Included in each Kit	
37	Sleeve O-ring, EPDM, $\varnothing 137.5 \times 3.3\text{mm}$	96438743	2	
	Sleeve O-ring, FKM, $\varnothing 137.5 \times 3.3\text{mm}$	96438744		2
37b	Sleeve O-ring, FXM, $\varnothing 137.5 \times 3.3\text{mm}$	96458109		2
	Sleeve O-ring, FFKM, $\varnothing 136.12 \times 3.53\text{mm}$	96466718		2
38, 100(a)	Drain Plug O-ring, EPDM, $\varnothing 16.3 \times 2.4\text{mm}$	00ID1288	3	
	Drain Plug O-ring, FKM, $\varnothing 16.3 \times 2.4\text{mm}$	00ID2231		3
38, 100a	Drain Plug O-ring, FXM, $\varnothing 16.3 \times 2.4\text{mm}$	96442869		3
	Drain Plug O-ring, FFKM, $\varnothing 16.3 \times 2.4\text{mm}$	96428162		3
109(a)	O-ring for Pos. 105(b) & 149, EPDM, $\varnothing 21.3 \times 3.0\text{mm}$	00ID1798	1	
	O-ring for Pos. 105(b) & 149, FKM, $\varnothing 21.2 \times 3.0\text{mm}$	00ID2339		1
109b	O-ring for Pos. 105(b) & 149, FXM, $\varnothing 22.0 \times 2.75\text{mm}$	96458111		1
	O-ring for Pos. 105(b) & 149, FFKM, $\varnothing 23.47 \times 2.62\text{mm}$	96464384		1

STANDARD SHAFT SEAL KIT, BALANCED CARTRIDGE		Kit No.	96455084	
(Maximum allowed working PSI is 435)		Kit No.	96455085	
		Kit No.	96533325	
		Kit No.	96533324	
Pos. No.	Description	Material No.	Qty. Included in each Kit	
105	HUUE	96441875	1	
	HUUU	96441876		1
	HUUF	96475542		1
	HUUK	96498108		1
N/A	Grinding Device Tool for Emery Cloth	370711	1	1
N/A	Emery Cloth	370712	1	1

IEC COUPLING KIT		Kit No.	415063	
$\varnothing 28/\varnothing 12$		Kit No.	415063	
Pos. No.	Description	Material No.	Qty. Included in each Kit	
9	Allen Screw, M8 x 25mm, Delta Seal	00ID7900	4	
10	Shaft Pin, $\varnothing 5 \times 26\text{mm}$, Stainless	310192	1	
10a	Coupling Half, F130, MG100/112, 3-4 kW, $\varnothing 28/\varnothing 12$	410047	2	









COUPLING GUARD KIT		Kit No.	96505130	
IEC, F85-F100, .37 to 1.1 kW		Kit No.	96505131	
NEMA 56C, 1/3-2HP; IEC-F115-130 & NEMA 182-215TC, 3-10HP		Kit No.	96505132	
Pos. No.	Description	Material No.	Qty. Included in each Kit	
7	Coupling Guard, W=127mm x H=66mm	96438136	2	
	Coupling Guard, W=127mm x H=90.5mm	96438137		2
	Coupling Guard, W=157mm x H=171mm	96438138		2
7a	Screw comb.slot torx/straight slot 4x8mm	96488481	4	4

Accessories

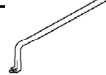
VICTAULIC TYPE COMPANION CONNECTIONS FOR SMALL CRI(N)		EPDM Kit No.	4013010	
		FKM Kit No.	0ID00118	
Pos. No.	Description	Material No.	Qty. Included in each Kit	
N/A	Victaulic Type Coupling, 1-1/4", EPDM	0ID17810	2	
N/A	Victaulic Type Coupling, 1-1/4", 77 FKM	0ID00112		2
N/A	1-1/4" Stainless NPT Nipple	4000011	2	2

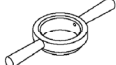
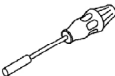



Special Tools

Tools not generally available from normal sources.

Mat. No.	Description and Use	
00SV0040	Shaft Holder for Dismantling/Assembly Used to hold and protect the shaft during dismantling and assembly.	
00SV2007	Tubular Box Spanner for Shaft Seal 36.1 mm Used to install and remove the shaft seal. Fits a 1/2" drive ratchet.	
00SV0239	Puller for Neck Ring Used to remove the Neck Ring from Chamber.	
00SV2014	Circlip Pliers for Flange Lock Ring Used to remove the Lock Ring for the Flange.	
00SV2066	Tool for Outer Sleeve Used to press sleeve into base.	
00SV2011	Bit Holder Used with Bits Kit, 1/4"	
00SV2010	Bits Kit NV 5 mm for M6, 1/4" NV 6 mm for M8, 1/4" NV 8 mm for M10, 1/4"	
00SV2012	Hexagon Socket Bit Used for Shaft Seal NV 2.5 mm for M5, 1/4"	
00SV2085	Tool for Chamber Used for Dismantling and Reassembling Bottom Chamber	
00SV2086	Tool for Guide Ring Used for Dismantling and Reassembling Bottom Chamber	

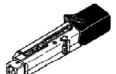
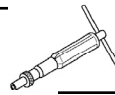
Standard Tools

In addition to being available from Grundfos, comparable tools can be purchased through normal sources.

Mat. No.	Description and Use	
00SV0083 00SV0055 00SV0056 00SV0054 00SV0122	Wrenches Used to tighten various nuts. NV 10 mm for M6 NV 13 mm for M8 NV 17 mm for M10 NV 19 mm for M12 NV 24 mm for M16	
00SV0292 00SV0269 00SV0400	Torque Wrench Used to torque various screws. 4-20 Nm, 9 x 12 20-100 Nm, 9 x 12 40-200 Nm, 14x18	
00SV0438	Torque Screwdriver Used to tighten various nuts. 1-6 Nm, 1/4"	
00SV0295	Ratchet Spanner for all Adapters 9 mm x 12 mm, 1/2"	
00SV0296 00SV0297 00SV0298	Socket Spanner with Inside Hex NV 5 mm for M6, 1/2" x 1/2" NV 6 mm for M8, 1/2" x 1/2" NV 8 mm for M10, 1/2" x 1/2"	
00SV0310 00SV0294 00SV0270 00SV0271 00SV0524	Ring Spanner NV 10 mm for M6 NV 13 mm for M8 NV 17 mm for M10 NV 19 mm for M12 NV 24 mm for M16	
00SV2013	Socket Spanner NV 13 mm for M8, 9 x 12	

L-CR-SM-030 0713

The name Grundfos, the Grundfos logo, and **be think innovate** are registered trademarks owned by Grundfos Holding A/S, Denmark. All rights reserved worldwide. © Copyright Grundfos Holding A/S

GRUNDFOS Pumps Corporation
17100 W. 118th Terrace
Olathe, Kansas 66062
Phone: 913.227.3400
Fax: 913.227.3500

www.grundfos.us

GRUNDFOS Canada, Inc.
2941 Brighton Road
Oakville, Ontario L6H 6C9 Canada
Phone: 905.829.9533
Fax: 905.829.9512

Bombas GRUNDFOS de Mexico S.A. de C.V.
Boulevard TLC No. 15
Parque Industrial Stiva Aeropuerto
Apodaca, N.L. Mexico 66600
Phone: 52.81.8144.4000
Fax: 52.81.8144.4010

GRUNDFOS 