



User's Guide

Converged Network Adapters and Intelligent Ethernet Adapters

8200 and 3200 Series

Information furnished in this manual is believed to be accurate and reliable. However, QLogic Corporation assumes no responsibility for its use, nor for any infringements of patents or other rights of third parties which may result from its use. QLogic Corporation reserves the right to change product specifications at any time without notice. Applications described in this document for any of these products are for illustrative purposes only. QLogic Corporation makes no representation nor warranty that such applications are suitable for the specified use without further testing or modification. QLogic Corporation assumes no responsibility for any errors that may appear in this document.

Document Revision History	
Revision A, March 31, 2011	
Revision B, October 31, 2011	
Changes	Sections Affected
Added "Intelligent Ethernet Adapters" to title.	Title page
Renamed Windows Property Pages to <i>QLogic Device</i> Windows Property Page.	All
Remove references to Release Notes.	"Related Materials" on page xvi, "Supported Operating Systems" on page 1-3, "ESX/ESXi Server" on page 1-11
Added "Intelligent Ethernet Adapters" to first sentence.	"Intended Audience" on page xvi
Removed QLE8xxx nomenclature from agency certification where the requirements apply to both 8200 and 3200 Series adapters.	"EMI and EMC Requirements" on page xix, "CNS 13438: Class A" on page xx
Added "iSCSI" to the first and second sentences.	"What is a Converged Network Adapter?" on page 1-1
Under multi-boot capability, removed unified extensible firmware interface (UEFI).	"Features" on page 1-1
Removed Step 1, Verify Package Contents.	Quick Start
Updated the instructions in "Step 2. Install the Adapter Drivers" on page xxv.	
Updated the instructions in "Step 3. Install QConvergeConsole" on page xxv.	
Add instructions "Step 4. Update the Flash" on page xxvi.	
Added "multi-boot image" to the first bullet.	"Additional Resources" on page xxvi
Changed the first sentence to "A Converged Network Adapter is a multifunction adapter that combines the capabilities of a Fibre Channel adapter, an <i>iSCSI adapter</i> , and an Ethernet NIC.	"What is a Converged Network Adapter?" on page 1-1

<p>Moved PXE parameter from Function parameter to Protocol parameter.</p> <p>Removed PXE note about LOM with PXE parameter.</p> <p>Removed note and embedded LOM with the Protocol parameter.</p> <p>Removed references to iBFT.</p> <p>Changed section title (removed utility name).</p> <p>Removed Function parameter section.</p> <p>Updated Readme file name.</p> <p>Added <i>ESXi</i> to section title.</p> <p>Removed phantomcore Utility section.</p> <p>Corrected values for Priority & VLAN Tag parameter in Table 2-1.</p> <p>Added new section about link aggregation control protocol (LACP).</p> <p>Changed the NPAR instructions.</p> <p>Removed the note stating that external and internal loopback tests are not supported.</p> <p>Corrected the name of the iSCSI VMware readme file.</p> <p>Added the sentence “Use Fast!UTIL to program the QLogic iSCSI adapter to boot from the SAN” to the end of the first paragraph.</p> <p>Changed the iSCSI boot setting instructions.</p> <p>Changed section heading to add IPv4; removed note about IPv6 not being supported.</p>	<p>“Protocol” on page 1-9</p> <p>“Multi-boot Image for 10Gb Converged Network Adapter—CNA Function Configuration Utility” on page 1-5, “Protocol” on page 1-9, Function parameter section (removed)</p> <p>“Adapter Configuration Utility” on page 1-8</p> <p>“Installing NIC in ESX/ESXi” on page 2-1, “Installing iSCSI in Linux” on page 3-1, “Installing iSCSI in ESX” on page 3-2, “Installing FCoE in Linux” on page 4-1</p> <p>“Installing NIC in ESX/ESXi” on page 2-1</p> <p>from “Linux NIC Driver Management Applications” on page 2-6</p> <p>“QLogic Device Windows Property Pages” on page 2-9.</p> <p>“Using LACP on 8200 Series Adapters for Windows” on page 2-35</p> <p>“NIC Partitioning (NPAR)” on page 2-38, and all associated subsections</p> <p>“Linux Diagnostics” on page 2-73, “QLogic Device Windows Property Page Diagnostics” on page 2-76</p> <p>“Installing iSCSI in ESX” on page 3-2</p> <p>“iSCSI Boot Setup Using Fast!UTIL” on page 3-6</p> <p>“Configuring iSCSI Boot Settings” on page 3-7</p> <p>“DHCP Boot Setup for iSCSI Boot (IPv4)” on page 3-8</p>
--	--

Removed iBFT section.	from "Configuring iSCSI" on page 3-1
Removed the "Configuring FCoE Driver Parameters with vCenter Plugin" section.	from "Driver Parameters" on page 4-4
Added index.	"Index" on page Index-1

Table of Contents

Preface

What's in This Guide	xv
Intended Audience	xvi
Related Materials	xvi
Documentation Conventions	xvi
License Agreements	xvii
Technical Support	xvii
Training	xviii
Contact Information	xviii
Knowledge Database	xviii
Legal Notices	xix
Warranty	xix
Laser Safety	xix
FDA Notice	xix
Agency Certification	xix
EMI and EMC Requirements	xix
CNS 13438: Class A	xx
MIC: Class A	xx
Product Safety Compliance	xxi

Quick Start

Installation Instructions	xxiii
Step 1. Install the Adapter Hardware	xxiii
Step 2. Install the Adapter Drivers	xxv
Step 3. Install QConvergeConsole®	xxv
Step 4. Update the Flash	xxvi
Additional Resources	xxvi

1

Product Overview

What is a Converged Network Adapter?	1-1
What is an Intelligent Ethernet Adapter?	1-1

Functionality and Features	1-1
Functional Description	1-1
Features	1-1
Supported Operating Systems	1-3
Adapter Specifications	1-3
Physical Characteristics	1-3
Standards Specifications	1-3
Environmental Specifications	1-4
Converged Network Adapter SuperInstaller Installation	1-5
QLogic Windows SuperInstaller	1-5
QLogic Linux SuperInstaller	1-5
Multi-boot Image for 10Gb Converged Network Adapter—CNA Function Configuration Utility	1-5
Operating System Support	1-5
Multi-boot Package Contents	1-5
Converged Network Adapter Function Configuration Package Contents	1-6
Using QLflash	1-6
Updating the Multi-boot Code	1-6
QLflash Command Line Options	1-7
Adapter Configuration Utility	1-8
Type	1-9
MinBW%	1-9
Protocol	1-9
Restore to Non-NIC Partition Settings	1-9
Exit the CNA Function Configuration Utility	1-9
Installing the QLogic Adapter vCenter Plug-in for ESX/ESXi	1-10
Introduction	1-10
Requirements	1-11
ESX/ESXi Server	1-11
vCenter Server	1-11
Tomcat Web Server	1-11
Installing the QLogic Adapter CIM Provider	1-12
Initial Installation	1-12
Subsequent Update Installation	1-13
Starting the QLogic Adapter CIM Provider	1-13
Removing the QLogic Adapter CIM Provider	1-13
Starting the QLogic Adapter vCenter Plug-in	1-15
Removing the QLogic Adapter vCenter Plug-in	1-15
Installing the Flash Utility	1-15

Updating the Flash	1-16
Using the vCenter Plug-in on a Tomcat Server	1-17
Installing Tomcat on Linux	1-17
Starting and Stopping Tomcat on Linux	1-18
Installing Tomcat on Windows	1-18
Starting and Stopping Tomcat on Windows	1-18
Installing the vCenter Plug-in on Tomcat	1-19
Plug-in Unregistration from a Manual Installation	1-19
Launching the Plug-in from vSphere Client	1-20

2

Configuring NIC

Installing NIC in Linux	2-1
Packaging Content	2-1
Linux OS Support	2-1
Supported Features	2-1
Using the Driver	2-1
Installing NIC in ESX/ESXi	2-1
Packaging Content	2-2
ESX OS Support	2-2
Using the Driver	2-2
Installing NIC in Windows	2-2
Packaging Content	2-2
Windows OS Support	2-2
Using the Driver	2-2
Configuring PXE Boot	2-3
Configuring Driver Software Parameters	2-6
Linux NIC Driver Management Applications	2-6
qaucli Utility	2-7
ethtool Utility	2-7
QLogic Device Windows Property Pages	2-9
Configuring NIC Driver Parameters with QCC GUI	2-13
Configuring NIC Driver Parameters with QCC Interactive CLI	2-14
Configuring NIC Driver Parameters with QCC Non-Interactive CLI	2-14
VLAN Configuration	2-14
VLAN Configuration with QCC GUI	2-14
VLAN Configuration with the QCC Interactive CLI	2-14
VLAN Configuration with the QCC Non-Interactive CLI	2-14

Teaming/Bonding	2-14
Windows Teaming	2-14
Team MAC Address	2-15
Teaming Modes	2-15
Using the CLI for Teaming	2-19
Using the Team Management GUI	2-19
Teaming Configuration	2-20
Creating a Team	2-21
Modifying a Team	2-27
Deleting a Team	2-33
Saving and Restoring Teaming Configuration	2-34
Viewing Teaming Statistics	2-34
Linux Bonding/Failover/Aggregation	2-34
Using LACP on 8200 Series Adapters for Windows	2-35
NIC Partitioning (NPAR)	2-38
Setup Requirements	2-39
NPAR Configuration	2-40
NIC Partitioning Options	2-40
Personality Changes	2-41
Quality of Service	2-42
eSwitch	2-43
Configuration Management Tools	2-44
NPAR Setup and Management Options	2-46
Overview	2-46
QLogic OptionROM at POST	2-47
QConvergeConsole (QCC) GUI	2-51
QConvergeConsole (QCC) CLI	2-55
QLogic Device Windows Properties Page	2-60
NPAR Setup	2-68
Default Settings	2-69
Configuration Options	2-69
NPAR Configuration Parameters and Setup Tools	2-70
Frequently Asked Questions about NPAR	2-71
NIC Partitioning	2-71
Networking	2-73

NIC Troubleshooting/Diagnostics	2-73
NIC Linux Diagnostics	2-73
Linux Diagnostics	2-73
QLogic Device Windows Property Page Diagnostics	2-76
Running Windows User Diagnostics.	2-76
Windows Diagnostic Test Descriptions.	2-81
Windows Diagnostic Test Messages	2-83
NIC Troubleshooting Guidelines	2-87

3

Configuring iSCSI

iSCSI Overview	3-1
Installing iSCSI in Linux	3-1
Packaging Content	3-1
Linux OS Support	3-1
Supported Features.	3-1
Deploying the Driver	3-1
Driver System Parameters	3-1
Installing iSCSI in ESX	3-2
Packaging Content	3-2
ESX OS Support	3-2
Using the Driver.	3-2
Installing the Driver	3-2
Installing iSCSI in Windows	3-2
Packaging Content	3-2
Windows OS Support	3-2
Using the Driver.	3-2
iSCSI Configuration	3-3
iSCSI Configuration with QCC GUI	3-3
iSCSI Configuration with Interactive QCC CLI	3-3
iSCSI Configuration with Non-Interactive CLI	3-3
iSCSI Initiator	3-3
Configuring an iSCSI Initiator in Linux	3-3
Configuring an iSCSI Initiator in Windows.	3-4
Configuring an iSCSI Initiator in VMware	3-6
iSCSI Name Server iSNS.	3-6

iSCSI Boot	3-6
iSCSI Boot Setup Using Fast!UTIL	3-6
Accessing Fast!UTIL	3-7
Configuring iSCSI Boot Settings.	3-7
DHCP Boot Setup for iSCSI Boot (IPv4).....	3-8
iSCSI Boot Setup Using QCC CLI.....	3-8
Configuring iSCSI Boot using the QCC CLI	3-8
Configuring iSCSI DHCP Boot Options using QCC CLI.....	3-8
Configuring iSCSI DHCP Boot Options using Interactive QCC CLI.....	3-8
Configuring iSCSI DHCP Boot Options using Non-interactive QCC CLI.....	3-8
iSCSI Boot Setup Using QCC GUI.....	3-9
iSCSI Troubleshooting.....	3-9
iSCSI Diagnostics	3-9
iSCSI Diagnostics using QCC GUI.....	3-9
iSCSI Diagnostics using Interactive QCC CLI	3-9
iSCSI Troubleshooting Diagram	3-10

4 Configuring FCoE

Installing FCoE.....	4-1
Installing FCoE in Linux	4-1
Packaging Content	4-1
Linux OS Support	4-1
Supported Features	4-1
Deploying the Driver.....	4-1
Driver System Parameters	4-1
Boot From SAN	4-1
Firmware Installation.....	4-2
Installing FCoE in ESX	4-2
Packaging Content	4-2
ESX OS Support.....	4-2
Using the Driver	4-2
Installing FCoE in Windows	4-2
Packaging Content	4-2
Windows OS Support	4-2
Using the Driver	4-2
Driver Parameters	4-2

QLogic Adapter Parameters	4-3
Setting QLogic Adapter Parameters with the QCC GUI	4-3
Setting QLogic Adapter Parameters with the Interactive QCC CLI	4-3
Setting QLogic Adapter Parameters with the Non-Interactive QCC CLI	4-3
Target Persistent Binding	4-3
Configuring Persistent Binding with the QCC GUI	4-3
Configuring Persistent Binding with the Interactive QCC CLI	4-3
Configuring Persistent Binding with the Non-Interactive QCC CLI	4-3
Boot Devices Configuration	4-3
Configuring Boot Devices with the QCC GUI	4-3
Configuring Boot Devices with the Interactive QCC CLI	4-3
Configuring Boot Devices with the Non-Interactive QCC CLI	4-3
Configuring Boot Devices with the BIOS	4-4
Virtual Ports (NPIV)	4-4
Configuring NPIV with the QCC GUI	4-4
Configuring NPIV with the Interactive QCC CLI	4-4
Configuring NPIV with the Non-Interactive QCC CLI	4-4
Driver Parameters	4-4
Configuring FCoE Driver Parameters with the QCC GUI	4-4
Configuring FCoE Driver Parameters with the Interactive QCC CLI	4-4
Configuring FCoE Driver Parameters with the Non-Interactive QCC CLI	4-4
Selective LUNS	4-4
Configuring Selective LUNS with the QCC GUI	4-4
Configuring Selective LUNS with the Interactive QCC CLI	4-4
Configuring Selective LUNS with the Non-Interactive QCC CLI	4-5
Troubleshooting	4-5
FCoE Diagnostics	4-5
FCoE Diagnostics using QCC GUI	4-5
FCoE Diagnostics using Interactive QCC CLI	4-5
FCoE Troubleshooting Diagram	4-6

A Adapter LEDs

Glossary

Index

List of Figures

Figure		Page
i	Illustration of Server Motherboard and Slots	xxiv
1-1	vSphere Client Showing QLogic Adapter Tab	1-10
1-2	vCenter Plug-in Requirements	1-11
2-1	Dell BIOS: Integrated Devices	2-3
2-2	QLogic 8200 CNA Function Configuration	2-4
2-3	BIOS: Boot Settings	2-5
2-4	Embedded NIC 1 QLogic PXE	2-6
2-5	Team Management Property Page	2-20
2-6	Creating a Team	2-21
2-7	Creating a Failsafe Team	2-23
2-8	Creating a Switch-Independent Load Balancing Team	2-24
2-9	Creating an 802.3ad Static Team	2-25
2-10	Creating an 802.3ad Dynamic Team	2-26
2-11	Confirming New Team Creation	2-27
2-12	Adding a Team	2-28
2-13	Modifying Advanced Team Properties	2-29
2-14	Modifying Team Properties	2-31
2-15	Modifying Failsafe Team Properties	2-32
2-16	Modifying the Team Type	2-33
2-17	Enabling LACP	2-35
2-18	LACP Configuration with One vPC	2-36
2-19	LACP Configuration with Two vPCs	2-36
2-20	Invalid LACP Configuration (One vPC Linked to Two Nexus 5x00s)	2-37
2-21	Invalid LACP Configuration (Two vPCs Linked Separately to Two Nexus 5x00s)	2-37
2-22	NPAR Default Function Settings	2-41
2-23	POST Test Screen Prompt to Enter Setup Menu	2-47
2-24	Function Configuration Screen	2-48
2-25	Selecting NIC Function Type to Change	2-49
2-26	Selecting iSCSI Function Type to Change	2-49
2-27	Selecting FCoE Function Type to Change	2-50
2-28	Adjusting the Minimum Bandwidth	2-50
2-29	Saving Configuration Changes	2-51
2-30	NIC Partitioning Configuration Page	2-53
2-31	NIC Partitioning—General Management Page	2-54
2-32	Selecting Option 6 to View NPAR Information Options	2-56
2-33	Selecting Option 2 to View NPAR Port Information	2-56
2-34	NPAR Configuration Selection Screen	2-57
2-35	Selecting NPAR Configuration	2-57
2-36	Selecting to Modify Minimum Bandwidth	2-58
2-37	Setting Bandwidth Changes to Persist	2-59
2-38	Selecting Function Type on Linux System	2-60
2-39	Selecting Properties from the Context Menu	2-61
2-40	Enabling Partition	2-62

2-41	Partition Enabled	2-63
2-42	Selecting Convert to NIC from Context Menu	2-64
2-43	Selecting Configure Function for Function 0	2-65
2-44	Entering New Bandwidth Values	2-66
2-45	NIC Partition Management Property Sheet	2-67
2-46	eSwitch Statistics for Function 0	2-68
2-47	Diagnostics Tests on Windows.	2-77
2-48	NIC Troubleshooting Diagram 1.	2-87
2-49	NIC Troubleshooting Diagram 2.	2-88
3-1	iSCSI Troubleshooting Diagram.	3-10
4-1	FCoE Troubleshooting Diagram.	4-6

List of Tables

Table		Page
1-1	Environmental Specifications	1-4
2-1	Windows Driver Configurable Parameters	2-9
2-2	Windows Teaming Modes	2-15
2-3	NPAR Operating System Requirements	2-39
2-4	NPAR Management Tool and Driver Requirements.	2-39
2-5	NPAR Configuration Options	2-42
2-6	Default Configuration	2-69
2-7	Configuration Options	2-69
2-8	NPAR Configuration Parameters and Setup Tools.	2-70
2-9	NPAR Wake-on-LAN (WOL) and PXE Boot Support.	2-70
2-10	Windows QConvergeConsole CLI—Selecting a Protocol in Menu Mode	2-78
2-11	Windows QConvergeConsole CLI—Selecting a Protocol in Legacy Mode	2-78
2-12	Windows QConvergeConsole CLI—Getting Help	2-79
2-13	Windows QConvergeConsole CLI—Miscellaneous Commands	2-79
2-14	Windows QConvergeConsole CLI—Diagnostic Test Commands	2-79
2-15	Running Windows Diagnostic Tests in the CLI.	2-81
2-16	Windows Diagnostic Test Messages	2-83
A-1	QLE824x and QLE324x LED Scheme.	A-1

Preface

This guide provides detailed instructions on the installation, configuration, and troubleshooting of 8200 and 3200 Series Adapters for Windows®, Linux®, and VMware®. It also provides details on the use of QLogic adapter features to enhance the value of server virtualization using VMware ESX™/ESXi 4.0. Such features include virtual adapter configuration using N_Port ID virtualization (NPIV) and boot-from-SAN configuration.

What's in This Guide

This guide is organized into the following sections and appendices:

- This Preface describes the intended audience, related materials, document conventions used, license agreements, technical support, and legal notices.
- The [Quick Start](#) section provides high-level hardware and software installation instructions for advanced users.
- The [Product Overview](#) provides a product introduction and specifications; information about the multi-boot image (CNA Function Configuration Utility); and detailed installation instructions for the SuperInstaller and vCenter Plug-in for ESX/ESXi.
- The [Configuring NIC](#) section describes installing the NIC driver and agent across operating systems (OSs); configuring the PXE boot; how to use driver parameters, VLANs, and teaming/bonding; and troubleshooting NIC issues.
- The [Configuring iSCSI](#) section describes installing the iSCSI driver and agent across OSs; configuring iSCSI; how to use the iSCSI initiator, iSNS, and iSCSI boot; and troubleshooting iSCSI issues.
- The [Configuring FCoE](#) section describes installing the Fibre Channel over Ethernet (FCoE) driver and agent across OSs; setting HBA parameters; configuring the boot device, N_Port ID virtualization (NPIV), driver parameters, and selective LUNs; and troubleshooting FCoE issues.
- The [Glossary](#) describes many of the terms used in this guide.

Intended Audience

This guide is intended for those responsible for deploying QLogic Fibre Channel, Converged Network, and Intelligent Ethernet Adapters on Windows, Linux, and VMware: users ranging from end users, such as data center managers and system administrators, to the test and development community.

Related Materials

For additional information, refer to the 8200 and 3200 Series Adapters Read Me files, the *QConvergeConsole User's Guide*, and the *QConvergeConsole CLI User's Guide*, available on the QLogic Web site, Downloads page: <http://driverdownloads.qlogic.com>.

Documentation Conventions

This guide uses the following documentation conventions:

- The 8200 and 3200 Series Adapters are also referred to as *QLogic Adapter* and *adapters*.
- **NOTE:** provides additional information.
- ***CAUTION!*** indicates the presence of a hazard that has the potential of causing damage to data or equipment.
- ***WARNING!!*** indicates the presence of a hazard that has the potential of causing personal injury.
- Text in **blue** font indicates a hyperlink (jump) to a figure, table, or section in this guide, and links to Web sites are shown in **underlined blue**. For example:
 - ❑ **Table 9-2** lists problems related to the user interface and remote agent.
 - ❑ See **"Installation Checklist"** on page 3-6.
 - ❑ For more information, visit **www.qlogic.com**.
- Text in **bold** font indicates user interface elements such as a menu items, buttons, check boxes, or column headings. For example:
 - ❑ Click **Start**, point to **Programs**, point to **Accessories**, and then click **Command Prompt**.
 - ❑ Under **Notification Options**, select the **Warning Alarms** check box.

- Text in *Courier* font indicates a file name, directory path, or command line text. For example:
 - ❑ To return to the root directory from anywhere in the file structure:
Type `cd /root` and press ENTER.
 - ❑ Enter the following command: `sh ./install.bin`
- Key names and key strokes are indicated with UPPERCASE:
 - ❑ Press the CTRL+P keys.
 - ❑ Press the UP ARROW key.
- Text in *italics* indicates terms, emphasis, variables, or document titles. For example:
 - ❑ For a complete listing of license agreements, refer to the *QLogic Software End User License Agreement*.
 - ❑ What are *shortcut keys*?
 - ❑ To enter the date type *mm/dd/yyyy* (where *mm* is the month, *dd* is the day, and *yyyy* is the year).
- Topic titles between quotation marks identify related topics either within this manual or in the online help, which is also referred to as *the help system* throughout this document.

License Agreements

Refer to the *QLogic Software End User License Agreement* for a complete listing of all license agreements affecting this product.

Technical Support

Customers should contact their authorized maintenance provider for technical support of their QLogic products. QLogic-direct customers may contact QLogic Technical Support; others will be redirected to their authorized maintenance provider.

Visit the QLogic support Web site listed in [Contact Information](#) for the latest firmware and software updates.

QLogic Technical Support for products under warranty is available during local standard working hours excluding QLogic Observed Holidays. For customers with extended service, consult your plan for available hours.

For details about available service plans, or for information about renewing and extending your service, visit the Service Program web page at <http://www.qlogic.com/services>.

Training

QLogic offers training for technical professionals for all iSCSI, Converged Network, InfiniBand, and Fibre Channel products. From the main QLogic web page at www.qlogic.com, click the **Support** tab at the top, then click **Training and Certification** on the left. The QLogic Global Training Portal offers online courses, certification exams, and scheduling of in-person training.

Technical Certification courses include installation, maintenance and troubleshooting QLogic products. Upon demonstrating knowledge using live equipment, QLogic awards a certificate identifying the student as a certified professional. You can reach the training professionals at QLogic by e-mail at training@qlogic.com.

Contact Information

Support Headquarters	QLogic Corporation 4601 Dean Lakes Blvd. Shakopee, MN 55379 USA
QLogic Web Site	www.qlogic.com
Technical Support Web Site	http://support.qlogic.com
Technical Support E-mail	support@qlogic.com
Technical Training E-mail	training@qlogic.com

For Support phone numbers, see the Contact Support link at support.qlogic.com.

Knowledge Database

The QLogic knowledge database is an extensive collection of QLogic product information that you can search for specific solutions. We are constantly adding to the collection of information in our database to provide answers to your most urgent questions. Access the database from the QLogic Support Center: <http://support.qlogic.com>.

Legal Notices

Warranty

For warranty details, please check the QLogic Web site at <http://www.qlogic.com/Support/Pages/Warranty.aspx>.

Laser Safety

FDA Notice

This product complies with DHHS Rules 21CFR Chapter I, Subchapter J. This product has been designed and manufactured according to IEC60825-1 on the safety label of laser product.

CLASS I LASER

Class 1 Laser Product
Appareil laser de classe 1
Produkt der Laser Klasse 1
Luokan 1 Laserlaite

Caution—Class 1 laser radiation when open
Do not view directly with optical instruments

Attention—Radiation laser de classe 1
Ne pas regarder directement avec des instruments optiques
Vorsicht—Laserstrahlung der Klasse 1 bei geöffneter Abdeckung
Direktes Ansehen mit optischen Instrumenten vermeiden

Varoitus—Luokan 1 lasersäteilyä, kun laite on auki
Älä katso suoraan laitteeseen käyttämällä optisia instrumenttejä

Agency Certification

The following sections contain a summary of EMC/EMI test specifications performed on the QLogic adapters to comply with radiated emission, radiated immunity, and product safety standards.

EMI and EMC Requirements

FCC Part 15 compliance: Class A **FCC compliance information statement:** This device complies with Part 15 of the FCC Rules. Operation is subject to the following two conditions: (1) this device may not cause harmful interference, and (2) this device must accept any interference received, including interference that may cause undesired operation.

ICES-003 compliance: Class A This Class A digital apparatus complies with Canadian ICES-003. Cet appareil numérique de la classe A est conforme à la norme NMB-003 du Canada.

CE Mark 2004/108/EC EMC Directive compliance:

EN55022:2006+A1:2007/CISPR22:2006: Class A

EN55024:1998

EN61000-3-2: Harmonic Current Emission

EN61000-3-3: Voltage Fluctuation and Flicker

Immunity Standards

EN61000-4-2: ESD

EN61000-4-3: RF Electro Magnetic Field

EN61000-4-4: Fast Transient/Burst

EN61000-4-5: Fast Surge Common/ Differential

EN61000-4-6: RF Conducted Susceptibility

EN61000-4-8: Power Frequency Magnetic Field

EN61000-4-11: Voltage Dips and Interrupt

VCCI: 2009-04 Class A

AS/NZS CISPR22: Class A

CNS 13438: Class A

This is a Class A product. In a domestic environment, this product may cause radio interference, in which case, the user may be required to take adequate measures.

警告使用者: 這是甲類的資訊產品，在居住的環境中使用時， 可能會造成射頻干擾，在這種情況下， 使用者會被要求採取某些適當的對策。

MIC: Class A

Korea RRA Class A Certified



Product Name/Model Fibre Channel Adapter
Certification holder—QLogic Corporation
Manufactured date—Refer to date code listed
on product
Manufacturer/Country of origin QLogic
Corporation/USA

A class equipment (Business purpose info/telecommunica- tions equipment)	As this equipment has undergone EMC registration for business purpose, the seller and/or the buyer is asked to beware of this point and in case a wrongful sale or purchase has been made, it is asked that a change to household use be made.
--	--

Korean Language Format— Class A

A급 기기 (업무용 정보통신기기)

이 기기는 업무용으로 전자파적합등록을 한 기기이오니
판매자 또는 사용자는 이 점을 주의하시기 바라며, 만약
잘못판매 또는 구입하였을 때에는 가정용으로 교환하시기
바랍니다.

Product Safety Compliance

UL, cUL product safety: 8200 and 3200 Series Adapters

UL60950-1 (2nd Edition), 2007-03-3-27

UL CSA C22.2 60950-1-07 (2nd Edition)

Use only with listed ITE or equivalent.

Complies with 21 CFR 1040.10 and 1040.11.

2006/95/EC low voltage directive: 8200 and 3200 Series Adapters

TUV:

EN60950-1:2006+A11 2nd Edition

EN60825-1:1994+A1+A2

EN60825-2:2004+A1

IEC60950-1 2nd Edition (2005) CB

CB Certified to IEC 60950-1 2nd Edition

Quick Start

Installation Instructions

This Quick Start section describes how to install and configure your new QLogic converged network adapter in three simple steps:

- [Step 1. Install the Adapter Hardware](#)
- [Step 2. Install the Adapter Drivers](#)
- [Step 3. Install QConvergeConsole®](#)
- [Step 4. Update the Flash](#)

CAUTION!

Keep the adapter in the antistatic bag until installation. The adapter contains parts that can be damaged by electrostatic discharge (ESD). Before handling the adapter, use standard methods to discharge static electricity. Place the adapter on the bag when examining it. Retain the bag for future use.

Step 1. Install the Adapter Hardware

To install the adapter hardware, you need to open the computer and locate the appropriate bus slot. If necessary, consult your computer system manual for instructions on how to remove the computer cover.

Follow these steps to install the adapter hardware:

1. Power off the computer and all attached devices such as monitors, printers, and external components.
2. Disconnect the power cable.
3. Remove the computer cover and find an empty PCIe® x8 (or larger) bus slot.
4. Pull out the slot cover (if any) by removing the screw or releasing the lever.
5. Install the low-profile bracket (if required).

6. Grasp the adapter by the top edge and seat it firmly into the appropriate slot (see [Figure i](#)).

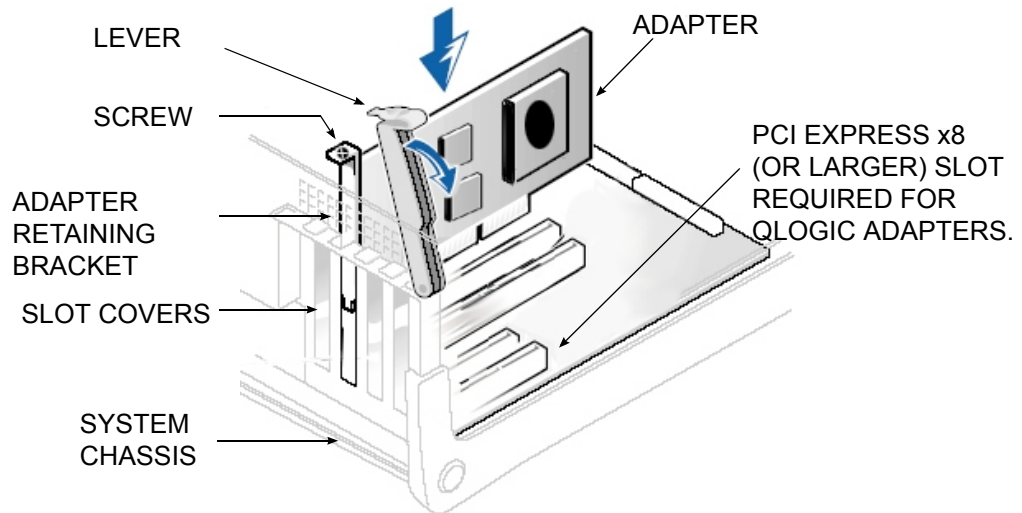

Figure i Illustration of Server Motherboard and Slots

7. Refasten the adapter's retaining bracket using the existing screw or lever.
8. Close the computer cover.
9. Plug the appropriate Ethernet cable (either copper or optical) into the adapter.
 - Optical models ship with optical transceivers already installed. The 8200 and 3200 Series Adapters will only operate with optical transceivers sold by QLogic.
 - For copper connectivity, see the list of approved SFP+ direct-attach copper cables on QLogic's Web site:
http://www.qlogic.com/Resources/Documents/LineCards/Copper_Cables_Support_Matrix_Line_Card.pdf
10. Plug in the power cable and turn on the computer.

Step 2. Install the Adapter Drivers

To install the adapter drivers:

1. Go to the QLogic Driver Downloads/Documentation page at <http://driverdownloads.qlogic.com>.
2. Click **QLogic Products**.
3. Click **Guided Search**.
A window opens prompting you to Enter your search criteria.
4. Provide the information necessary:
 - a. In the **Select a Product Type** menu, select **Adapters**.
 - b. In the **Select by Model or by OS**, select **by Model**.
 - c. In the **Select the Product Technology** menu, select either **Converged Network Adapters** or **Intelligent Ethernet Adapters**, as appropriate.
 - d. In the **Select the Model** menu, select your QLogic Adapter.
 - e. In the **Select the Desired Item** menu, select **Drivers**.
 - f. Click **Search**.
5. Scroll through the options that are shown; select the appropriate driver.
6. Click **Download Now**.
7. Follow the installation instructions included in the Readme file for the downloaded driver.

Step 3. Install QConvergeConsole®

To install QConvergeConsole:

1. Go to the QLogic Driver Downloads/Documentation page at <http://driverdownloads.qlogic.com>.
2. Click **QLogic Products**.
3. Click **Guided Search**.
A window opens prompting you to Enter your search criteria.
4. Provide the information necessary:
 - a. In the **Select a Product Type** menu, select **Adapters**.
 - b. In the **Select by Model or by OS**, select **by Model**.

- c. In the **Select the Product Technology** menu, select either **Converged Network Adapters** or **Intelligent Ethernet Adapters**, as appropriate.
 - d. In the **Select the Model** menu, select your QLogic Adapter.
 - e. In the **Select the Desired Item** menu, select **Management Tools**.
 - f. Click **Search**.
5. Scroll through the list that appears and select the QConvergeConsole version for your operating system.
 6. Click **Download Now**.
 7. Follow the instructions in the QConvergeConsole readme file for installing the downloaded software.

Step 4. Update the Flash

Download and update the QLogic adapter with the latest required version of the Flash Image from <http://driverdownloads.qlogic.com>.

The Flash image package for the 8200 and 3200 Series Adapters includes boot code, firmware, and the Flash update utility. Refer to the Readme file on the QLogic Web site for details on the package contents and update instructions (<http://driverdownloads.qlogic.com>).

Additional Resources

- To obtain the most current drivers, management tools, multi-boot image, user instructions, and documentation, please visit the QLogic Web site at <http://driverdownloads.qlogic.com> and download the latest versions.
- See [What's in This Guide](#) for descriptions of user instructions provided in this document.
- For important product information, including warranty, laser safety, and agency certification, and see the [Legal Notices](#) section.
- For descriptions and procedures related to QConvergeConsole, use the built-in help system.

1 Product Overview

What is a Converged Network Adapter?

A Converged Network Adapter is a multifunction adapter that combines the capabilities of a Fibre Channel adapter, an iSCSI adapter, and an Ethernet NIC. A Converged Network Adapter provides simultaneous Fibre Channel, iSCSI, and Ethernet traffic over a shared 10Gb Ethernet link.

What is an Intelligent Ethernet Adapter?

The Intelligent Ethernet Adapter is a multifunction adapter which, by default, supports one Ethernet function per port and can be expanded to four Ethernet functions per port.

Functionality and Features

This section provides the following information:

- [“Functional Description” on page 1-1](#)
- [“Features” on page 1-1](#)
- [“Supported Operating Systems” on page 1-3](#)

Functional Description

The 8200 Series Adapters are Converged Network Adapters, and the 3200 Series Adapters are Intelligent Ethernet Adapters (IEA). The 8200 Series Adapters support 2×10GbE Enhanced Ethernet, FCoE, and iSCSI. The 3200 Series Adapters support 2×10GbE Enhanced Ethernet ports.

Features

The 8200 and 3200 Series Adapters provide the following features:

- NIC partitioning (NPAR)
- Message signaled interrupts (MSI-X)
- Device management for LAN and SAN

- Multi-boot capability including:
 - ❑ Preboot-eXecution environment (PXE)
 - ❑ iSCSI (8200 Series Adapters only)
 - ❑ Fibre Channel (8200 Series Adapters only)
- PCIe 2.0 ×8
- User diagnostics that can be run from the CLI and the GUI
- Ethernet functions include:
 - ❑ 2×10 GbE
 - ❑ Priority and virtual LAN (VLAN) tagging
 - ❑ Jumbo frames up to 9618 bytes
 - ❑ Advanced teaming
 - ❑ VLAN configuration and management
 - ❑ Preservation of teaming and VLAN configuration information during driver upgrade
- Enhanced Ethernet functions include:
 - ❑ Priority-based flow control (802.1Qbb)
 - ❑ Enhanced transmission selection (802.1Qaz)
 - ❑ Data center bridging exchange protocol (802.1Qaz)
 - ❑ Link aggregation (802.3ad)
- Advanced stateless offload features include:
 - ❑ IP, TCP, and UDP checksums
 - ❑ Large send offload (LSO)
 - ❑ Large receive offload (LRO)
- Stateful offload features (8200 Series Adapters only) include:
 - ❑ iSCSI
 - ❑ FCoE
- Several advanced management features for iSCSI and Fibre Channel adapters, including QConvergeConsole (QCC) (GUI and CLI) and NIC partitioning (NPAR)
- Interrupt management and scalability features including:
 - ❑ Receive side scaling (RSS)
 - ❑ Interrupt moderation

- ❑ Flow control
- ❑ Locally administered address (LAA)
- Enhanced optimization with MSI, MSI-X, and NetQueue

Supported Operating Systems

The 8200 and 3200 Series Adapters support commonly used operating systems (OSs): Windows, Linux, Solaris®, and ESX®.

For a detailed list of the currently supported operating systems, refer to the adapter's Readme files on the QLogic Web site:

<http://driverdownloads.qlogic.com>

Adapter Specifications

Physical Characteristics

The 8200 and 3200 Series Adapters are implemented as low-profile PCIe cards. The adapters ship with a full-height bracket for use in a standard PCIe slot or an optional spare low-profile bracket for use in a low-profile PCIe slot. Low-profile slots are typically found in compact servers.

Standards Specifications

The 8200 and 3200 Series adapters support the following standards specifications:

- IEEE: 802.3ae (10 Gb Ethernet)
- IEEE: 8021q (VLAN)
- IEEE: 802.3ad (Link Aggregation)
- IEEE: 802.1p (Priority Encoding)
- IEEE: 802.3x (Flow Control)
- IEEE: 802.1Qbb (Priority Based Flow Control)
- IEEE: 802.1Qaz (Enhanced Transmission Selection)
- IPv4 Specification (RFC791)
- IPv6 Specification (RFC2460)
- TCP/UDP Specification (RFC793/768)
- ARP Specification (RFC826)
- SCSI-3 Fibre Channel Protocol (SCSI-FCP)
- Fibre Channel Tape (FC-TAPE) Profile
- SCSI Fibre Channel Protocol-2 (FCP-2)
- Second Generation FC Generic Services (FC-GS-2)
- Third Generation FC Generic Services (FC-GS-3)
- iSCSI (RFC3720)

Environmental Specifications

The environmental specifications are listed in [Table 1-1](#).

Table 1-1. Environmental Specifications

Condition	Operating	Non-Operating
Temperature Ranges (for Altitude=900 m or 2952.75 ft)	10°C to 55°C ^a (50°F to 131°F)	-40°C to 65°C (-40°C to 149°F)
Temperature Ranges (for Altitude >900 m or 2952.75 ft)	10°C to n°C ^b (50°F to n°F ^c)	-40°C to 65°C (-40°F to 149°F)
Temperature Gradient Maximum per 60 Min.	10°C	20°C
Humidity Percent Ranges—Non- condensing	20% to 80% (Max. Wet bulb temper- ature= 29°C) ^d	5% to 95% (Max. Wet bulb temper- ature= 38°C) ^d
Humidity Gradient Maximum per 60 Minutes	10%	10%
Altitude Ranges—Low Limits	-15.2m (-50 ft)	-15.2m (-50 ft)
Altitude Ranges—High Limits	3,048m (10,000 ft)	10,668m (35,000 ft)
Airborne Contaminants—ISA-71 Level	G1 ^d	G1 ^d

^a 200LFM is required to operate at this temperature.

^b Use the following formulas to calculate the maximum operating temperature (in °C) for a specific altitude. Use the first formula if the altitude is stated in meters and the second formula if the altitude is stated in feet.

$$35 - \frac{\text{Maximum Altitude(in meters)} - 900}{300} \text{ } ^\circ\text{C} \text{ or } 35 - \frac{\text{Maximum Altitude(in ft)} - 2952.75}{984.25} \text{ } ^\circ\text{C}$$

^c Use the following formulas to calculate the maximum operating temperature (in °F) for a specific altitude. Use the first formula if the altitude is stated in meters and the second formula if the altitude is stated in feet.

$$95 - \left(\frac{(\text{Maximum Altitude(in meters)} - 900) \times 1.8}{300} \right) \text{ } ^\circ\text{F} \text{ or } 95 - \left(\frac{(\text{Maximum Altitude(in ft)} - 2952.75) \times 1.8}{984.25} \right) \text{ } ^\circ\text{F}$$

^d Maximum corrosive contaminant levels measured at =50% relative humidity; see Table 3 in ISA-71.04-1985.

Converged Network Adapter SuperInstaller Installation

QLogic Windows SuperInstaller

Refer to the *QLogic Windows SuperInstaller* Readme file for information.

QLogic Linux SuperInstaller

Refer to the *QLogic Linux SuperInstaller* Readme file for information.

Multi-boot Image for 10Gb Converged Network Adapter—CNA Function Configuration Utility

This section contains the following information:

- “Operating System Support” on page 1-5
- “Multi-boot Package Contents” on page 1-5
- “Converged Network Adapter Function Configuration Package Contents” on page 1-6
- “Using QLflash” on page 1-6
 - “Updating the Multi-boot Code” on page 1-6
 - “QLflash Command Line Options” on page 1-7
- “Adapter Configuration Utility” on page 1-8

Operating System Support

This multi-boot code supports DOS, Windows Server® 2008; Solaris x86; and Linux on IA32, AMD64, and Intel® x64-based systems. Refer to the Readme file for OS information.

Multi-boot Package Contents

The multi-boot package for 8200 and 3200 Series Adapters is a compressed file that contains the 82xx/32xx BIOS, UEFI, PXE, and firmware. This package also includes the QLflash application.

Converged Network Adapter Function Configuration Package Contents

The following files are included for updating the adapter multi-boot code:

- `update.bat`—DOS batch file that calls the executable files to update the adapter multi-boot.
- `QLflash.exe`—Utility to update multi-boot code and firmware.
- `DOS4GW.exe`—This file is required to use the `QLflash.exe`.
- `p3pyyyyyy.bin`—Combined binary file, which includes the binaries for the BIOS, UEFI, PXE, and firmware.

Using QLflash

`QLflash` is a native DOS utility. Refer to the Readme file for more information. To run this utility, boot to a DOS hard drive or USB removable drive.

Utility Version:

`/VER` = Display version of the QLflash utility

Help Options:

`/?` = Help menu

Updating the Multi-boot Code

To write the multi-boot code to Flash memory:

1. Insert the QLogic Adapter in the system.
2. Boot to DOS.
3. Run the update script at the command prompt:

```
C:\>update.bat
```

This script program updates the multi-boot image on the adapter.

4. Reboot the system.

NOTE:

You can also use the QConvergeConsole (QCC) GUI/CLI to flash the multi-boot image. After the multi-boot code is updated, power cycle the server for the new changes to take effect.

QLflash Command Line Options

The executable file `QLflash.exe` is used by the `UPDATE.BAT` file to update your adapter multi-boot code. The application `QLflash.exe` may be used to read, write, or verify either the multi-boot image or the NVRAM on the adapter.

The following paragraphs describe the command line options available with this utility. Use of QLflash will modify the way your adapter operates, and it must be used with extreme caution.

Certain features (that is, the NVRAM options) may require additional data.

Files and passwords are not provided in this file.

QLflash Options

`QLflash.exe <1...N | ALL> [options]`

`/SLT`

SLT: Sets the application to silent mode

Use application return code for success or failure

`/SIL=filename.ext`

SIL: Load multiflash image from file

`/PRV | /VPP | /PRN`

PRV: Print firmware versions

VPP: Print VPD contents

PRN: Print MAC addresses and worldwide port name (WWPN)

`/CFU=filename.ext | /CFS=filename.ext | /CFC=filename.ext`

CFU: Flash board configuration from file

CFS: Save board configuration file (need template file `BRDCFG.DAT`)

CFC: Compare board configuration to a binary file

`/NVU=filename.ext | /NVS=filename.ext | /NVC=filename.ext`

NVU: Flash NVRAM from file

NVS: Save NVRAM to file (need template file `NVRAM.DAT`)

NVC: Compare Flash to NVRAM file

`/UIL=filename.ext | /UIS=filename.ext | /UIC=filename.ext`

UIL: Flash user information data from file

UIS: Save user information data to file

UIC: Compare user information data to a binary file

NOTE:

- If you used an FC RAID target in a cluster environment, you should enable the Enable Target Reset = Enabled (Advanced Adapter Settings).
 - Use the /I option if the update utility, QLflash, does not detect your adapter.
 - QLogic recommends disabling the internal disk before installing the OS or booting to the FCoE disk.
-

Adapter Configuration Utility

NOTE:

The CNA Function Configuration utility does not run on SUN™ SPARC® systems.

This section provides detailed configuration information for advanced users who want to customize the configuration of the 8200 and 3200 Series Adapters and the connected devices. You can configure the adapters using the CNA Function Configuration utility.

To access the CNA Function Configuration utility, press ALT+Q during the adapter initialization (it may take a few seconds for the menu to appear). If you have more than one adapter, the utility will ask you to select the adapter you want to configure. After changing the settings, the utility reboots your system to load the new parameters.

CAUTION!

If the configuration settings are incorrect, your adapter may not function properly.

Upon entering the CNA Function Configuration utility, the following selections are available from the Setup Menu/Function Configuration menu:

- [“Type” on page 1-9](#)
- [“MinBW%” on page 1-9](#)
- [“Protocol” on page 1-9](#)
- [“Restore to Non-NIC Partition Settings” on page 1-9](#)
- [“Exit the CNA Function Configuration Utility” on page 1-9](#)

Type

Enter to set a function to a particular type:

- `NIC`—The function will support NIC protocol.
- `None`—The function will be disabled.
- `iSCSI`—The function will support iSCSI protocol.
- `FCoE`—The function will support FCoE protocol.

NOTE:

Functions 0 through 3 support only `NIC` or `None`. Functions 4 and 5 support `NIC`, `iSCSI`, or `None`. Functions 6 and 7 support `NIC`, `FCoE`, or `None`.

MinBW%

Enter to specify the percentage of bandwidth allocated to the function. The combined MinBW% values for a port's functions cannot exceed 100 percent.

Protocol

The Protocol parameter applies only to only function 0 and function 1.

- `PXE`—PXE will be supported on the NIC.

Adapter Settings

Press the ENTER key on the Function number to access Adapter Settings, and to configure PXE Boot.

PXE. The following settings are available when Protocol is set to PXE:

- `Setup Menu Wait Time (0–15: the default is 5 seconds)`
Specifies the time in seconds the menu will wait.
- `Enable PXE Boot (Enabled/Disabled: Default—Disabled)`
Enter to toggle between `Enabled` and `Disabled`. Use the `Enable PXE Boot` option to attempt a PXE boot on the selected function.

Restore to Non-NIC Partition Settings

Press the ENTER key to restore the NIC partition settings.

Exit the CNA Function Configuration Utility

Press the ENTER key to select from the following:

- `Reboot System`
- `Return to Fast!UTIL`

Installing the QLogic Adapter vCenter Plug-in for ESX/ESXi

This section on installing the QLogic Adapter vCenter Plug-in contains the following:

- “Introduction” on page 1-10
- “Requirements” on page 1-11
- “Installing the QLogic Adapter CIM Provider” on page 1-12
- “Starting the QLogic Adapter CIM Provider” on page 1-13
- “Removing the QLogic Adapter CIM Provider” on page 1-13
- “Starting the QLogic Adapter vCenter Plug-in” on page 1-15
- “Removing the QLogic Adapter vCenter Plug-in” on page 1-15
- “Installing the Flash Utility” on page 1-15
- “Updating the Flash” on page 1-16
- “Using the vCenter Plug-in on a Tomcat Server” on page 1-17
- “Plug-in Unregistration from a Manual Installation” on page 1-19
- “Launching the Plug-in from vSphere Client” on page 1-20

Introduction

The QLogic Adapter vCenter Plug-in is a user-interface extension to the vSphere™ Client that allows you to manage and configure QLogic adapters, including the NIC partitioning feature, on ESX and ESXi servers. When you select an ESX or ESXi host that has QLogic adapters installed, the extension appears in the client as an additional tab named **QLogic Adapter**, as shown in [Figure 1-1](#).

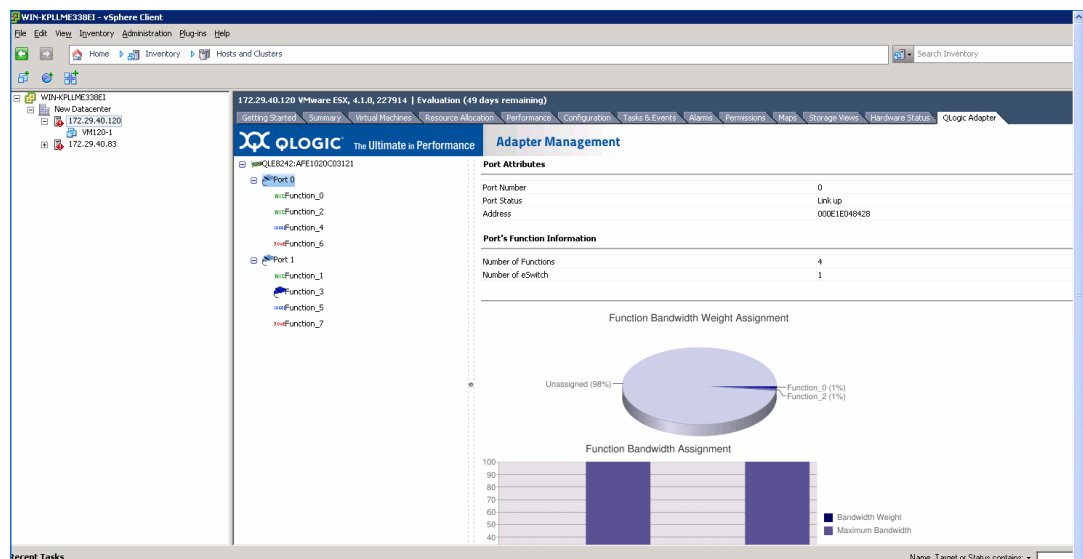

Figure 1-1. vSphere Client Showing QLogic Adapter Tab

Requirements

The QLogic Adapter vCenter Plug-in requires the components in [Figure 1-2](#) to be installed and running.

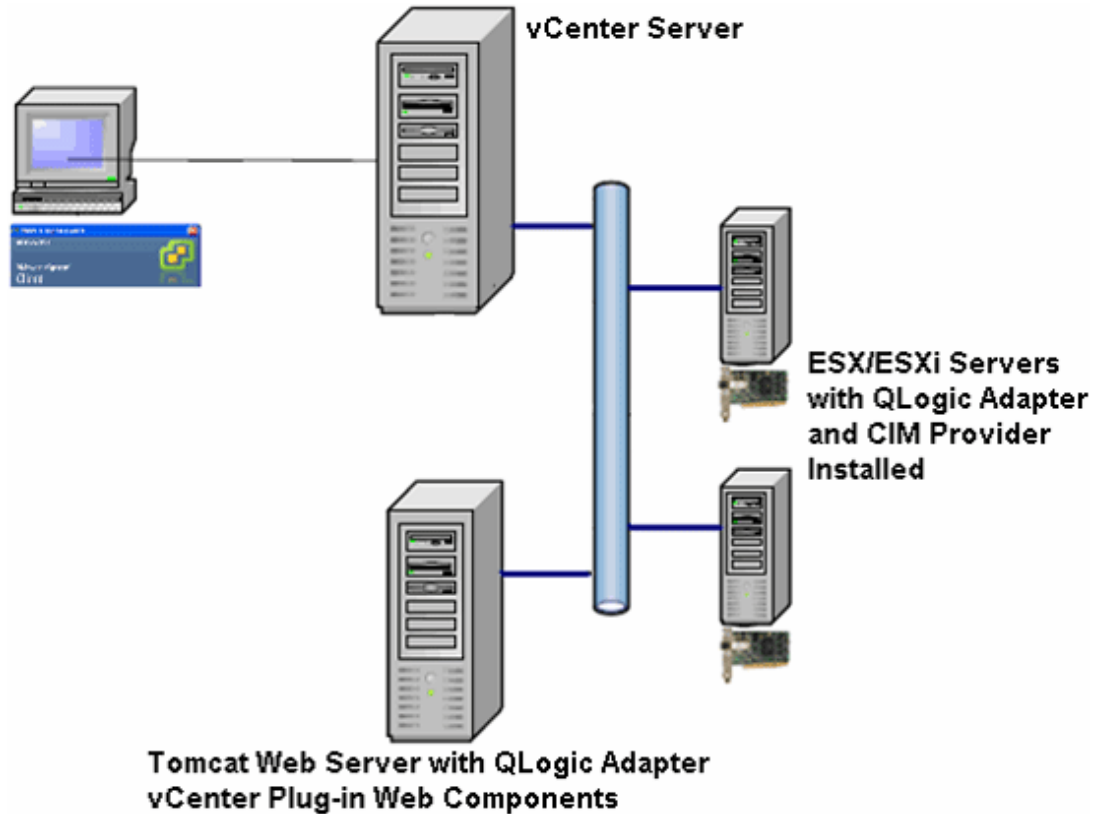

Figure 1-2. vCenter Plug-in Requirements

QLogic provides the following components that must be installed on the ESX or ESXi Server, vCenter Server, and Tomcat Web Server.

ESX/ESXi Server

- QLogic Adapter with firmware and driver
- QLogic Adapter CIM Provider

vCenter Server

- QLogic XML configuration file to register the plug-in to the vCenter Server

Tomcat Web Server

- QLogic Web-based extension to the vSphere Client

Installing the QLogic Adapter CIM Provider

The QLogic Adapter CIM Provider for VMware ESX was generated as a vSphere Installation Bundle (VIB) file. A VIB contains the complete set of files and binaries required to install the provider on VMware ESX/ESXi. The `offline-bundle.zip` file contains the VIB and the necessary metadata to install the provider on VMware ESX/ESXi.

This section provides the following installation procedures for the CIM Provider:

- [Initial Installation](#)
- [Subsequent Update Installation](#)

Initial Installation

To install the QLogic Adapter CIM Provider using the `esxupdate` command (ESX systems only):

1. Copy the `offline-bundle.zip` file into the root directory (`/`) of the ESX system.
2. Issue the `esxupdate` command as follows:

```
# cd /  
# esxupdate --bundle offline-bundle.zip --nodeps -nosigcheck  
--maintenancemode update
```

To install the QLogic Adapter CIM Provider from a remote host using the vSphere CLI `vihostupdate` command (ESXi systems only):

NOTE:

To update the provider from a remote host using the `vihostupdate` command, make sure that the ESXi system is in maintenance mode. To put the ESXi host in maintenance mode using vSphere Client, select **Inventory**, select **Host**, and then select **Enter Maintenance Mode**.

1. Copy the `offline-bundle.zip` file to any location on the host where either the vSphere CLI package is installed or the vSphere Management Assistant (vMA) is hosted.
2. Navigate to the location of the `offline-bundle.zip` file.
3. Issue the `vihostupdate` command to install the offline bundle as follows:

```
# vihostupdate.pl <conn_options> --install --bundle  
offline-bundle.zip --nosigcheck
```

For available options, refer to the `vihostupdate` page.

4. Follow the on-screen instructions to complete the installation. You may need to reboot the ESXi system.

NOTE:

For more details on `vihostupdate`, refer to the documents on the VMware vSphere Command-Line Interface Documentation page, located here:

<http://www.vmware.com/support/developer/vcli/>

Subsequent Update Installation

To update the QLogic Adapter CIM Provider after a prior VIB installation:

1. Follow the instructions in “[Removing the QLogic Adapter CIM Provider](#)” on [page 1-13](#) to remove the existing VIB.
2. Follow the instructions in “[Initial Installation](#)” on [page 1-12](#) to install the new VIB.

Starting the QLogic Adapter CIM Provider

After a system startup, the Small Footprint CIM Broker (SFCB) CIM object manager (CIMOM) in the ESX system should start automatically and load the QLogic Adapter CIM Provider when necessary.

For ESX systems, you can also manually stop, start, or restart the SFCB CIMOM by issuing the following commands.

To stop the SFCB CIMOM and the QLogic Adapter CIM Provider:

```
# /etc/init.d/sfcbd-watchdog stop
```

To start the SFCB CIMOM and the QLogic Adapter CIM Provider:

```
# /etc/init.d/sfcbd-watchdog start
```

To restart the SFCB CIMOM and the QLogic Adapter CIM Provider:

```
# /etc/init.d/sfcbd-watchdog restart
```

After starting the SFCB CIMOM, use a CIM client utility to query the QLogic Adapter CIM Provider for information.

Removing the QLogic Adapter CIM Provider

To remove the QLogic Adapter CIM Provider, use either the `esxupdate` or `vihostupdate` command.

To uninstall the QLogic Adapter CIM Provider using the `esxupdate` command:

1. Query and find the existing VIB you are updating as follows:

```
# esxupdate query --vib-view | grep qlogic
```

For example, the VIB ID may have a format similar to the following:

```
ESX/ESXi 4.0: cross_qlogic-nic-provider_400.x.x.x-000000  
ESX/ESXi 4.1: cross_qlogic-nic-provider_410.x.x.x-000000
```

where `x.x.x` is the version number of the existing provider.

2. Remove the existing VIB as follows:

```
# esxupdate remove -b <vibID>
```

To uninstall from a remote host using the `vihostupdate` command:

NOTE:

To uninstall the provider from a remote host using the `vihostupdate` command, make sure that the ESX/ESXi system is in maintenance mode. To put the ESX/ESXi host in maintenance mode using vSphere Client, select **Inventory**, select **Host**, and then select **Enter Maintenance Mode**.

-
1. From a console on the host where the vSphere CLI package is installed or vMA is hosted, query to find the Bulletin ID of the existing provider:

```
# vihostupdate.pl <conn_options> --query\
```

For example, the Bulletin ID may have a format similar to the following:

```
ESX/ESXi 4.0: QLGC_NIC_PROVIDER-ESX-4.0.0-qlogic-nic-provider-x.x.x  
ESX/ESXi 4.1: QLGC_NIC_PROVIDER-ESX-4.1.0-qlogic-nic-provider-x.x.x
```

where `x.x.x` is the version number of the existing provider.

2. Remove the existing VIB as follows:

```
# vihostupdate.pl <conn_options> --remove --bulletin  
<bulletinID>
```

NOTE:

For more details on `vihostupdate`, refer to the documents on the VMware vSphere Command-Line Interface Documentation page, located here:

<http://www.vmware.com/support/developer/vcli/>

Starting the QLogic Adapter vCenter Plug-in

To start the QLogic Adapter vCenter Plug-in:

1. Start the VMware vSphere Client and connect to the vCenter Server by entering the IP address or name, user name, and password.
2. Click **Login**.
3. If the Security Warning dialog box appears, click **Ignore** to use the current SSL certificate.
 - If you start and connect the vSphere Client directly to an ESX/ESXi server, the vCenter plug-in does not open.
 - If you have not already done so, create a data center and add the ESX server.
4. In the left pane, select the IP address of the VMware server.
5. In the right pane, click the **QLogic Adapter** tab to view the Web page.
The vCenter plug-in retrieves the adapter information from the server.

NOTE:

If the server does not have the QLogic Adapter CIM Provider and adapters installed, or if the vCenter Plug-in installation and registration was not successful, the **QLogic Adapter** tab is not shown.

Removing the QLogic Adapter vCenter Plug-in

To remove the QLogic Adapter vCenter Plug-in:

1. In the Windows Control Panel, select **Add or Remove Programs**.
2. In the Add or Remove Programs dialog box, select the **QLogic Adapter vCenter Plug-in**, and then click **Change/Remove**.
3. Follow the instructions in the QLogic Adapter vCenter Plug-in installer to remove the plug-in.

Installing the Flash Utility

For ESX, before you perform a Flash update on QLogic Adapters using the QLogic Adapter vCenter Plug-in, ensure that the QLflash utility is also installed on the ESX system.

To install the QLflash utility on ESX:

1. Unzip the `esx_qlflash.zip` file, which contains the `qlflash` userworld executable.
2. Copy the QLflash binary file to the `/usr/lib/vmware/bin/` directory.

3. Add executable permission for QLflash by issuing the following command:

```
# chmod +x qlflash
```
4. If it does not already exist, edit and append the `/usr/lib/vmware/bin/qlflash` entry in the `/etc/vmware/UserWorldBinaries.txt` file.

For ESXi, the QLflash utility is not required, so no additional steps are necessary.

Updating the Flash

NOTE:

For ESX systems, before you perform a Flash update on a QLogic Adapter using the vCenter Plug-in, ensure that the QLflash utility is also installed. Follow the instructions in the [Installing the Flash Utility](#) section.

To update the Flash from the QLogic Adapter vCenter Plug-in:

1. Follow the instructions in [“Starting the QLogic Adapter vCenter Plug-in” on page 1-15](#) to start the vCenter plug-in.
2. In the left pane of the **QLogic Adapter** page, select the adapter, and then click the **Update Adapter Flash Image** link.
3. In the **Select Flash File for Update** dialog box, click **Browse**.
4. In the Choose File to Upload dialog box, select the `.bin` Flash file from the extracted Flash kit package that is compatible with your adapter, and then click **Open**.
5. In the **Select Flash File for Update** dialog box, click **Send**.
6. Verify the current Flash version and file version, and then click **OK** to continue the update.
7. When asked “Do you want to reset the adapter to activate the firmware immediately after successful update?,” click **OK** if you want the new firmware to take effect immediately. Or, click **Cancel** to have the new firmware take effect after the next system reboot.
8. Wait for the Flash update process to complete. Processing time depends on the network connection and the system configuration. Do not interrupt the update process.

CAUTION!

The Flash update may take up to 10 minutes to complete. Do not cancel the task or reboot the server during this time. Doing so may corrupt the firmware on the adapter.

9. In the Flash update successful completion message box, click **OK**.
10. If you clicked **OK** in [Step 7](#), you can click **Refresh** to verify the new firmware version. Otherwise, you must reboot the system for the new firmware to take effect.

Using the vCenter Plug-in on a Tomcat Server

VMware requires that all vCenter plug-ins are web-based applications hosted on a Tomcat Server, which can be downloaded and installed on Linux and Windows systems. Here is a link to Tomcat:

<http://tomcat.apache.org/>

The QLogic vCenter Plug-in supports Tomcat 5, 6, and 7. The installer dynamically detects the Tomcat version and installs accordingly.

This section provides the following procedures for using the vCenter Plug-in on a Tomcat Server:

- [“Installing Tomcat on Linux” on page 1-17](#)
- [“Starting and Stopping Tomcat on Linux” on page 1-18](#)
- [“Installing Tomcat on Windows” on page 1-18](#)
- [“Starting and Stopping Tomcat on Windows” on page 1-18](#)

Installing Tomcat on Linux

To install Tomcat on a Linux OS:

1. Go to the following URL:

<http://tomcat.apache.org/download-55.cgi>

2. Locate the following directory and file:

```
Binary Distribution > Core > tar.gz  
(apache-tomcat-5.5.28.tar.gz)
```

3. Unzip the `tar.gz` file by issuing the following command:

```
root # tar zxf file.tar.gz
```

4. Create a symbolic link to a Tomcat directory by issuing the following command:

```
# ln -s apache-tomcat-5.5.28 tomcat
```

where setting variables include the following:

```
export JAVA_HOME=/root/gwt/jdk1.6.0_17/  
export CATALINA_HOME=/root/gwt/tomcat/
```

Starting and Stopping Tomcat on Linux

To start Tomcat, issue the following command:

```
# $CATALINA_HOME/bin/startup.sh
```

To stop Tomcat, issue the following command:

```
# $CATALINA_HOME/bin/shutdown.sh
```

Installing Tomcat on Windows

To install Tomcat on a Windows OS:

1. Go to either of the following URLs:

<http://tomcat.apache.org/download-60.cgi>

<http://tomcat.apache.org/download-70.cgi>

2. Locate the following directory and file:

```
Binary Distribution > Core > 32-bit/64-bit Windows Service  
Installer
```

3. To install the Tomcat service, get the 32-bit/64-bit Windows Service Installer, save it, and run it.

Starting and Stopping Tomcat on Windows

To start and stop Tomcat on a Windows OS:

1. Go to **Computer Management > Services and Application > Services > Apache Tomcat <version number>**.
2. Right-click, and then select **Start /Stop** to initiate Tomcat service, or select **Stop** to halt the Tomcat service.

Installing the vCenter Plug-in on Tomcat

To install the vCenter Plus-in on a Tomcat Server:

1. Download the QLogic Adapter vCenter Plug-in installer EXE; for example, QLogic Adapter VI Plugin 1.0.4.exe.
2. Run the installer by double-clicking the EXE file or by typing the name of the EXE on a command prompt.

The *InstallAnywhere* installer prepares to install the QLogic Adapter vCenter Plug-in.

3. On the Introduction window, click **Next**.
4. On the Please Wait window, wait while the QLogic Adapter vCenter Plug-in is configured for your system.
5. On the Choose Install Folder window, either accept the default installation directory, or click **Choose** to specify a different folder.
6. Click **Install** to install files to the installation directory specified in the previous step.

A progress window shows the status of the installation.

7. On the User Input window, type your vCenter Server IP address, username, and password, as well as the IP address of your local Tomcat Server. Then click **Next** to continue.
8. On the Please Wait window, wait while the QLogic Adapter vCenter Plug-in is configured for your system and registers the plug-in with the vCenter Server.
9. On the Registration Result window, click **Finish** to complete the plug-in installation.

Plug-in Unregistration from a Manual Installation

If you have performed a manual installation of the vCenter plug-in, you must perform a manual uninstall before running the vCenter installation wizard.

VMware provides two type of scripts for vCenter plug-in registration:

For Windows PowerShell® scripting:

<http://communities.vmware.com/docs/DOC-4521>

For Perl:

<http://communities.vmware.com/docs/DOC-4530>

1. Before you can use the script, download the appropriate VI SDK from VMware.

For PowerShell, download **vSphere PowerCLI**:

<http://communities.vmware.com/community/vmtn/vsphere/automationtools/powercli>

For Perl VI SDK, download **vSphere SDK for Perl**:

<http://www.vmware.com/support/developer/viper toolkit/>

2. After you download and install the SDK and the registration script, follow the VMware instructions to register the vCenter Plug-in.

For example, the Perl unregister command is:

```
perl registerPlugin.pl --server="127.0.0.1"  
-username="administrator" --password="password"  
--key="com.qlogic.QLogicAdapterVIPlugIn" --action="remove"
```

3. Replace the username and password with the correct information to log into the vCenter Server.

Launching the Plug-in from vSphere Client

To launch the plug-in from vSphere client:

1. Start the vSphere Client and connect to the vCenter Server. (If you start and connect the vSphere Client directly to an ESX or ESXi server, the vCenter plug-in does not appear.)
2. If you have not already done so, create a data center and add the ESX server.
3. In the left pane, select the server.

A row of tabs appear in the right pane. If the server has QLogic Adapter CIM Provider and adapters installed, and if the vCenter plug-in installation and registration were successful, the **QLogic Adapter** tab appears in the tab row.

4. Click the **QLogic Adapter** tab to view a web page.

2 Configuring NIC

This section describes the driver and QConvergeConsole (QCC) agent installation, configuration, operation, and troubleshooting of the NIC function of the 8200 and 3200 Series Adapters. Refer to the *QCC User's Guide* for information on QCC Agents.

Installing NIC in Linux

Refer to the *Intelligent Ethernet Adapter and Converged Network Adapter Inbox Driver Update* Readme file for information.

Packaging Content

Refer to the *Intelligent Ethernet Adapter and Converged Network Adapter Inbox Driver Update* Readme file for information.

Linux OS Support

Refer to the *Intelligent Ethernet Adapter and Converged Network Adapter Inbox Driver Update* Readme file for information.

Supported Features

Refer to the *Intelligent Ethernet Adapter and Converged Network Adapter Inbox Driver Update* Readme file for information.

Using the Driver

Refer to the *Intelligent Ethernet Adapter and Converged Network Adapter Inbox Driver Update* Readme file for information on installing the driver, removing the driver, and driver system parameters.

Installing NIC in ESX/ESXi

Refer to the *Intelligent Ethernet Adapter and Converged Network Adapter Networking Driver for ESX/ESXi* Readme file for information.

Packaging Content

Refer to the *Intelligent Ethernet Adapter and Converged Network Adapter Networking Driver for ESX/ESXi* Readme file for information.

ESX OS Support

Refer to the *Intelligent Ethernet Adapter and Converged Network Adapter Networking Driver for ESX/ESXi* Readme file for information.

Using the Driver

Refer to the *Intelligent Ethernet Adapter and Converged Network Adapter Networking Driver for ESX/ESXi* Readme file for information on installing and removing the driver.

Installing NIC in Windows

Refer to the *Intelligent Ethernet Adapter and Converged Network Adapter NDIS Miniport Driver for Windows* Readme file for information.

Packaging Content

Refer to the *Intelligent Ethernet Adapter and Converged Network Adapter NDIS Miniport Driver for Windows* Readme file for information.

Windows OS Support

Refer to the *Intelligent Ethernet Adapter and Converged Network Adapter NDIS Miniport Driver for Windows* Readme file for information.

Using the Driver

Refer to the *Intelligent Ethernet Adapter and Converged Network Adapter NDIS Miniport Driver for Windows* Readme file for information on installing and removing the driver.

Configuring PXE Boot

This section provides procedures for configuring the 8200 and 3200 Series Adapters to perform PXE boot. The example uses function 1 and NIC 1.

To configure PXE boot:

1. Enter the system BIOS by pressing the F2 key.
2. On the BIOS window ([Figure 2-1](#)), select **Integrated Devices**, and then press the ENTER key.

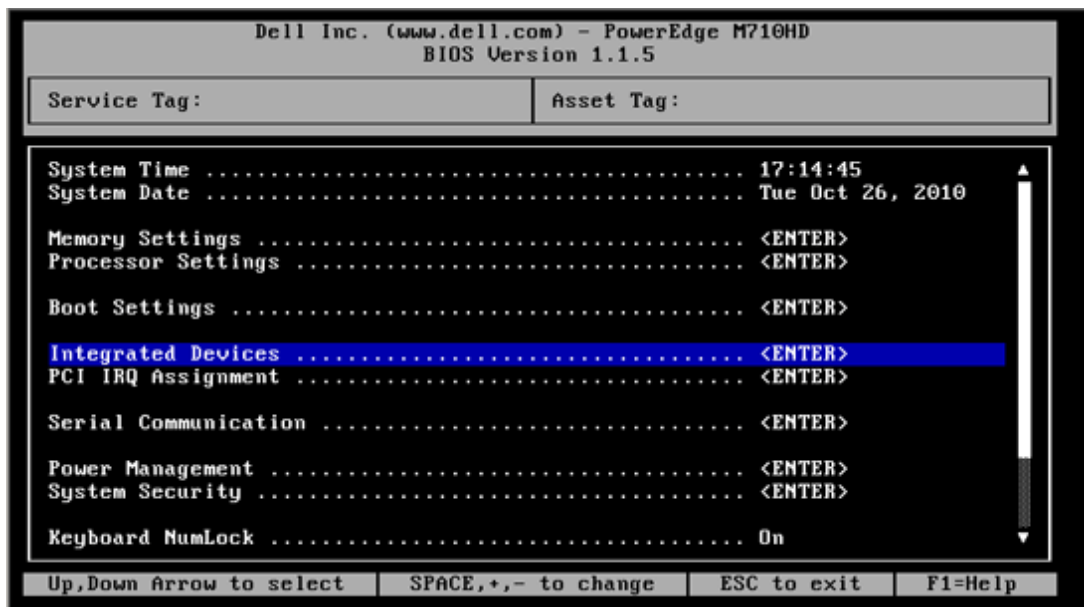

Figure 2-1. Dell BIOS: Integrated Devices

3. Set the **Embedded NIC1 and NIC2** option to **Enabled**.
4. Set the **Embedded NIC1** option to **Enabled with PXE**.
5. Press the ESCAPE key twice, and then select **Save changes and exit**.
The system reboots.
6. (Optional) During POST, press the CTRL+Q keys to enter the **QLogic 8200 Series / 3200 Series CNA Function Configuration** window.

7. On the CNA Function Configuration main window, ensure that **Protocol** is set to **PXE** (Figure 2-2).

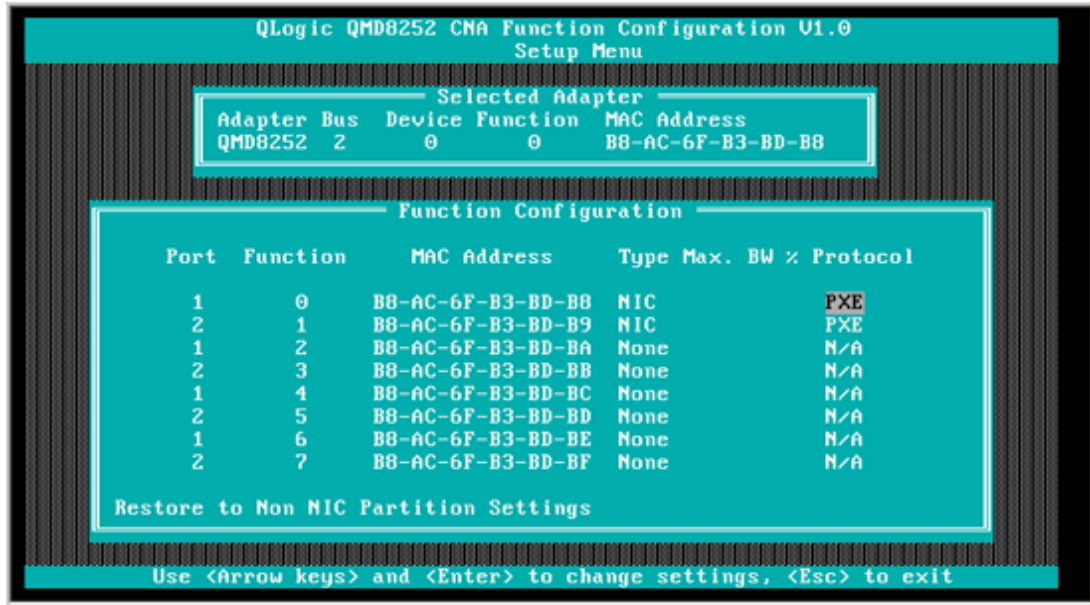

Figure 2-2. QLogic 8200 CNA Function Configuration

8. Press the ESC key to exit.
9. Select **Save changes** to save your edits, exit, and reboot the system.
10. During POST, press the F2 key to enter the BIOS system.

11. Select **Boot Settings**, and then press the ENTER key (Figure 2-3).

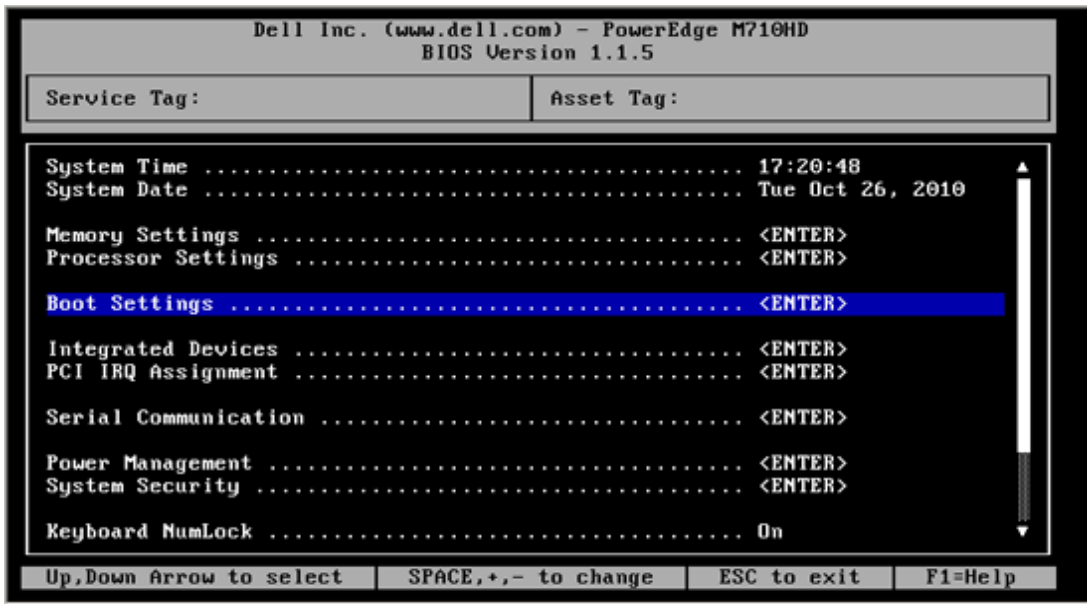

Figure 2-3. BIOS: Boot Settings

12. Select the **Boot Sequence** option, and then press the ENTER key.

13. Select the **Embedded NIC 1 QLogic PXE...** entry, and then press the UP ARROW key to move this entry to the first position (Figure 2-4).

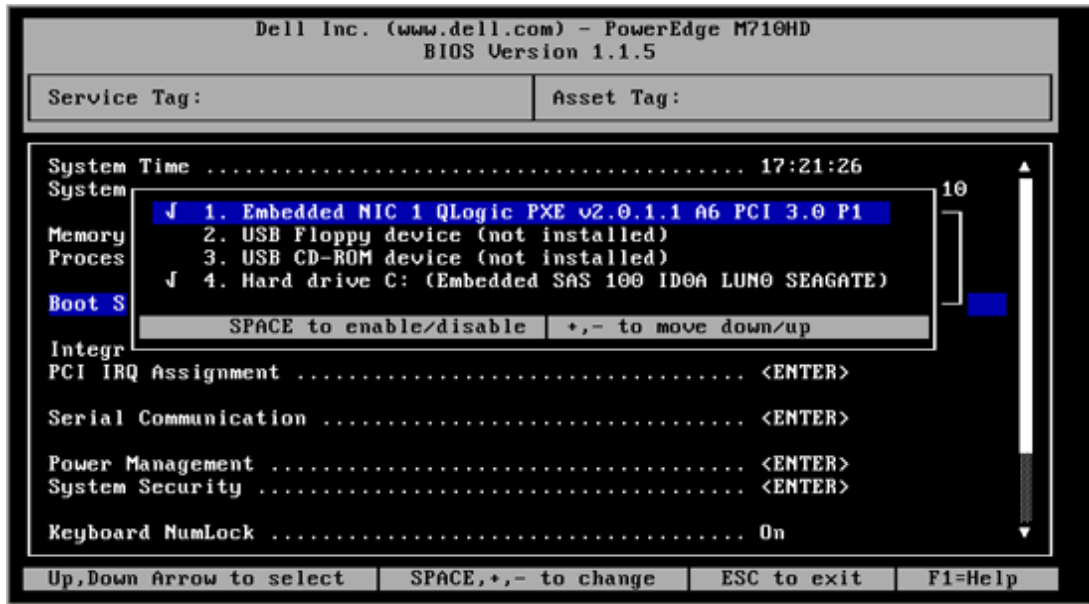

Figure 2-4. Embedded NIC 1 QLogic PXE

14. Press the ESCAPE key, and then select **Save changes and exit**.
The system reboots.
15. After the system reboot, follow the screen prompt for PXE boot server for the installation of OS of your choice.

Configuring Driver Software Parameters

Linux NIC Driver Management Applications

Overview

The following sections describe how to configure and manage the driver and adapter using Linux management utilities.

Viewing and Changing Adapter Properties on Linux

Use the following Linux utilities to view and change adapter properties:

- “[qaucli Utility](#)” on page 2-7
- “[ethtool Utility](#)” on page 2-7

qaucli Utility

Install QConvergeConsole CLI (`qauccli`) from the following packages supplied by QLogic:

- `QConvergeConsoleCLI-<version>_linux_<arch>.install.tar.gz`—Package file
- `QConvergeConsoleCLI-<version>_<arch>.rpm`—RPM installer package file

Example RPM Package Installation

To determine if QCC is installed and to find the full name of the installed QCC RPM package, issue the following command using the partial name `QConvergeConsoleCLI` as an argument to `grep`:

```
rpm -qa | grep QConvergeConsoleCLI
```

1. To check for an older version of the RPM package, issue the following command:

```
rpm -qa QConvergeConsoleCLI
```

2. If an older version is found, erase that version by issuing the following command:

```
rpm -e QConvergeConsoleCLI
```

3. To install the new version, issue the following command:

```
rpm -ihv QConvergeConsoleCLI-1.0.00-04.i386.rpm
```

The utility is installed in the
`/opt/QLogic_Corporation/QConvergeConsoleCLI` directory.

ethtool Utility

Use the `ethtool` utility to view adapter statistics and configure interface options. For additional details, refer to *qlcnic driver man page* and *ethtool man page*.

Examples

To disable transmit segmentation offload, issue the following command, where `[n]` represents a numerical value for a specific instance:

```
ethtool -K eth[n] tso off
```

To list interface statistics, issue the following command, where `[n]` represents a numerical value for a specific instance:

```
ethtool -S eth[n]
```

Sample Output 1

```
ethtool -S eth8
NIC statistics:
xmit_called: 6
xmit_finished: 6
rx_dropped: 0
tx_dropped: 0
csummed: 0
rx_pkts: 0
lro_pkts: 0
rx_bytes: 0
tx_bytes: 468
lrobytes: 0
lso_frames: 0
xmit_on: 0
xmit_off: 0
skb_alloc_failure: 0
null_skb: 0
null_rxbuf: 0
rx_dma_map_error: 0
```

In the following example, `ethtool eth[n]` lists interface settings.

Sample Output 2

```
Ethtool eth8
Settings for eth8:
Supported ports: [ TP FIBRE ]
Supported link modes:
Supports auto-negotiation: No
Advertised link modes: 10000baseT/Full
Advertised auto-negotiation: No
Speed: 10000Mb/s
Duplex: Full
Port: FIBRE
PHYAD: 1
Transceiver: external
Auto-negotiation: off
Supports Wake-on: g
Wake-on: g
Current message level: 0x00000000 (0)
Link detected: yes
```

QLogic Device Windows Property Pages

To access the property pages in Windows:

1. Access the Device Manager as follows:
 - a. On the Windows desktop, click **Start**, **Control Panel**, click **Administrative Tools**, and then click **Computer Management**.
 - b. In the Computer Management dialog box, click **Device Manager**.
2. In the left pane of the Device Manager dialog box, right-click **QLogic 10Gb Ethernet Adapter**, and then click **Properties**.
3. On the adapter properties dialog box, click the **Advanced** tab to bring that page to the front.
4. On the **Advanced** page, configure the parameters specified in the [Table 2-1](#).
5. (Optional) Click other tabs to bring those pages to the front and view or change settings, for example:
 - Click the **Information** tab to view the configuration.
 - Click the **Details** tab to view NIC driver details. On the Details page, click items under **Property** to view the selected item's value.
 - Click the **Driver** tab to update, rollback, disable, or uninstall the NIC driver.
 - Click the **Resource** tab to view resource settings.
 - Click the **Statistics** tab to view the transmit and receive (general and QLogic-customized) statistics gathered while the NIC is operational.
6. When you are through viewing and changing driver properties, click **OK** to close the dialog box, or click **Cancel** to revert to the previous driver configuration.

Table 2-1. Windows Driver Configurable Parameters

Property	Description
Completion Queue Size	<p>Specifies the size for the ring where command completion and incoming receive indication status will be posted.</p> <p>Registry Key: <code>CompletionQueueSize</code></p> <p>Default: 16384</p> <p>Values: 1024, 2048, 4096, 8192, 16384, 32768</p>

Table 2-1. Windows Driver Configurable Parameters (Continued)

Property	Description
Flow Control	Sets the hardware flow control parameters. Registry Key: *FlowControl Default: Rx and Tx Enabled Values: Disabled, Rx Enabled, Tx Enabled, Rx and Tx Enabled
Health Monitoring	Checks health of firmware, monitors normal operation, and ensures recovery of the firmware.
Interrupt Moderation	Allows interrupt coalescing during receive and transmit operation. Registry Key: *InterruptModeration Default: Disabled Values: Enabled, Disabled
IPv4 Checksum Offload	Enables and disables IPv4 checksum offload. Registry Key: *IPChecksumOffloadIPv4 Default: Rx and Tx Enabled. Values: Disabled, Rx and Tx Enabled, Rx Enabled, Tx Enabled
Large Receive Offload	Enables and disables TCP large receive offload. Enables collapsing of multiple MTU size TCP packets into bigger segments before handing these over to the host. Registry Key: LRO Default: Enabled Values: Enabled, Disabled
Large Send Offload V1 IP4	Enables and disables TCP large send offload. Allows host TCP stack to give bigger than maximum segment size (MSS) packets to the driver, and then with the help of hardware, splits the larger segments into MTU size packets before sending them on the wire. Registry Key: *LsoV1IPv4 Default: Enabled. Values: Enabled, Disabled Size of LSO v1: 64K

Table 2-1. Windows Driver Configurable Parameters (Continued)

Property	Description
Large Send Offload V2 IP4	<p>Enables and disables TCP large send offload. Allows the host TCP stack to give bigger than MSS packets to the driver, and then with the help of hardware, splits the larger segments into MTU size packets before sending them on the wire.</p> <p>Registry Key: *LsoV2IPv4 Default: Enabled Values: Enabled, Disabled Size of LSO v2: 128K</p>
Large Send Offload V2 IP6	<p>Enables and disables TCP large send offload. Allows host TCP stack to give bigger than MSS packets to the driver, and then with the help of hardware, splits the larger segments into MTU size packets before sending them on the wire.</p> <p>Registry Key: *LsoV2IPv6 Default: Enabled Values: Enabled, Disabled Size of LSO v2: 128K</p>
Locally Administered Address	<p>Defines the locally administered address (LAA) that users and administrators can set on this interface. This address overrides the permanent address of the QLogic adapter (that may have been Flashed into the hardware).</p> <p>Registry Key: NetworkAddress Format: Hexadecimal Options: Value (a value is required, enter the 12 hex bytes of the MAC address to be used), or not present.</p>
Max Ethernet Frame Size	<p>Specifies the Ethernet frame size for packet transmission and receipt (includes the MAC header).</p> <p>Reg Key: MaxFrameSize Default: 1514 (corresponds to 1514 bytes on the wire + 4 bytes of CRC) Max: 9614 Min: 142 (Windows 2003), 590 (Windows 2008)</p>

Table 2-1. Windows Driver Configurable Parameters (Continued)

Property	Description
Max Jumbo Buffers	<p>Specifies the number of jumbo-sized receive buffers allocated for the jumbo ring (not frame).</p> <p>Reg Key: RxJumboRingSize</p> <p>Default: 4096</p> <p>Values: 1024, 2048, 4096, 8192</p>
Number of Receive Buffers	<p>Specifies the number of buffers allocated for receiving standard MTU size (1514 byte) packets.</p> <p>Registry Key: *ReceiveBuffers</p> <p>Values: 1024, 2048, 4096, 8192, 16384, 32768</p> <p>Default: 16384</p>
Number of Transmit Buffers	<p>Specifies the number of stage buffers used by the driver during transmit.</p> <p>Registry Key: *TransmitBuffers</p> <p>Values: 1024, 2048, 4096</p> <p>Default: 1024</p>
Priority & VLAN Tag	<p>Enables and disables support for 802.1pQ priority tagging. This property must be enabled to set the VLAN ID.</p> <p>Registry Key: PQTagging</p> <p>Default: Priority & VLAN Enabled</p> <p>Values: Priority & VLAN Enabled; Priority & VLAN Disabled; Priority Disabled, VLAN Enabled; Priority Enabled, VLAN Disabled</p>
Receive Side Scaling	<p>Enables and disables the RSS feature.</p> <p>Registry Key: RSS</p> <p>Default: Enabled</p> <p>Values: Enabled, Disabled</p>
Receive Side Scaling Rings	<p>Specifies the number of RSS rings used.</p> <p>Registry Key: MaxStatusRings</p> <p>Default: 2</p> <p>Values: 1-4</p>

Table 2-1. Windows Driver Configurable Parameters (Continued)

Property	Description
TCP Checksum Offload IPv4	<p>Enables and disables the TCP transmit and receive checksum offload.</p> <p>Registry Key: *TCPChecksumOffloadIPv4</p> <p>Default: Rx and Tx Enabled</p> <p>Values: Disabled, Rx Enabled, Tx Enabled, Rx and Tx Enabled</p>
TCP Checksum Offload IPv6	<p>Enables and disables the TCP transmit and receive checksum offload.</p> <p>Registry Key: *TCPChecksumOffloadIPv6</p> <p>Default: Rx and Tx Enabled</p> <p>Values: Disabled, Rx Enabled, Tx Enabled, Rx and Tx Enabled</p>
UDP Checksum Offload IPv4	<p>Enables and the disables the user datagram protocol (UDP) transmit and receive checksum offload.</p> <p>Registry Key: *UDPChecksumOffloadIPv4</p> <p>Default: Rx and Tx Enabled</p> <p>Values: Disabled, Rx Enabled, Tx Enabled, Rx and Tx Enabled</p>
UDP Checksum Offload IPv6	<p>Enables and disables the UDP transmit and receive checksum offload.</p> <p>Registry Key: *UDPChecksumOffloadIPv6</p> <p>Default: Rx and Tx Enabled</p> <p>Values: Disabled, Rx Enabled, Tx Enabled, Rx and Tx Enabled</p>
VLAN ID for Setting	<p>If the Priority and VLAN Tag is enabled, this parameter specifies a VLAN ID for this interface (also exposed through the standard object identifier (OID)).</p> <p>Registry Key: VlanId</p> <p>Default: 0 (no VLAN)</p> <p>Range: 0-4094</p>

Configuring NIC Driver Parameters with QCC GUI

Refer to the *QConvergeConsole Help System: Setting General NIC Port Parameters and Setting Advanced NIC Port Parameters* for information.

Configuring NIC Driver Parameters with QCC Interactive CLI

Refer to the *QConvergeConsole CLI User's Guide*: section 7, “NIC Interactive Commands,” for information.

Configuring NIC Driver Parameters with QCC Non-Interactive CLI

Refer to the *QConvergeConsole CLI User's Guide*, section 4, “NIC Noninteractive commands,” for information.

VLAN Configuration

VLAN Configuration with QCC GUI

Refer to the *QConvergeConsole Help System: Setting Advanced NIC Port Parameters* for information.

VLAN Configuration with the QCC Interactive CLI

Refer to the appropriate section in the *QConvergeConsole CLI User's Guide* for information.

VLAN Configuration with the QCC Non-Interactive CLI

Refer to the appropriate section in the *QConvergeConsole CLI User's Guide* for information.

Teaming/Bonding

Windows Teaming

You can group together multiple network adapters in a server to make a team. Individual adapters that are part of a team operate as a team rather than standalone adapters. A team provides traffic load balancing across the member adapters and fault tolerance when some, but not all, of the members lose connectivity.

To enable teaming functionality, install the teaming driver in addition to the basic NIC.

Team MAC Address

At initialization, the teaming driver selects the team's MAC address to be the MAC of one of the teamed adapters. In general, the first adapter to come up is chosen as the preferred primary adapter. The preferred primary's MAC address is assigned to the MAC address of the team. Alternately, you can choose any valid MAC address as the team's static MAC address, also called the locally administered address (LAA). Make sure any provided LAA is unique for the local Ethernet network. This provision gives the system administrator more flexibility in configuring the MAC address for a team when necessary.

Teaming Modes

Teaming is designed to improve reliability and fault tolerance of networks and to enhance performance by efficient load balancing.

The following NIC teaming modes are provided:

- **Failsafe Mode** ensures that an alternate standby or redundant adapter becomes active if the primary network connection fails.
- **Switch Independent Load-Balancing Mode** ensures distribution of transmit loads across the teamed adapters.
- **Link Aggregation Modes** (802.3ad static, 802.3ad dynamic (active and passive link aggregation control protocol [LACP])) enables the use of multiple adapters together as a single, virtual adapter with the aggregated capacity of its individual adapters.

All team types—failsafe, switch-independent load balancing, and link aggregation—can be heterogeneous as well as homogeneous. Every team must have at least one QLogic Adapter.

Table 2-2 shows that failsafe and transmit load-balancing modes are switch independent, which means they do not require switch configuration. LACP or 802.3ad require switch ports configured for LACP.

Table 2-2. Windows Teaming Modes

Mode	Failover Capability	Switch Dependency	System Fault Tolerance (SFT)	Load Balancing	Number of Ports per Team (Range ^a)
Failsafe	Yes: Layer 2	No	Yes	No	2–16
Transmitload balancing	Yes	No	Yes	Yes: Layers 3 or 4	2–16

Table 2-2. Windows Teaming Modes (Continued)

Mode	Failover Capability	Switch Dependency	System Fault Tolerance (SFT)	Load Balancing	Number of Ports per Team (Range ^a)
Static 802.3ad	Yes	Yes	Yes	Yes	2–16
Dynamic 802.3ad	Yes	Yes	Yes	Yes	2–16

^a 16 × 16 ports can be aggregated per system: 16 ports per team and 16 teams per system.

Failsafe Mode

The failsafe mode provides Layer 2 fault tolerance. Failsafe provides high reliability through redundancy in the event of port failure. When the primary network connection is down, data traffic is automatically transferred to a secondary, standby connection. The preferred primary adapter can be specified either by the system administrator or by the teaming driver (if the *admin* does not select the preferred adapter). When the teaming driver needs to make the selection, it selects the best adapter in terms of bandwidth, health, and capability. The preferred primary must always be a QLogic Adapter.

The administrator can also choose one of the following failback types to specify the behavior when connection to the preferred primary is restored after a period of failure:

- **None**—When the preferred primary becomes operational again, the driver does not automatically switch back the primary to the active adapter.
- **Preferred Primary**—When the preferred primary becomes operational again, the driver automatically switches back the primary as the active adapter. The network traffic resumes to the primary adapter from the standby adapter. The traffic stays with the secondary adapter only as long as the primary adapter is down.
- **Auto Select**—Use this option to enable the teaming driver to automatically select the best adapter based on parameters such as bandwidth, link state, health, and so on.

In failsafe mode, the standby adapter could be dissimilar in the individual features supported and capacity, and may come from a different vendor.

All the adapters in the team share a common team MAC address. This is either a locally administered MAC address or a default MAC address specified by the driver. Only one adapter at a time in the team is active for network traffic. No two same MAC addresses are exposed to the switch at the same time.

Failsafe mode is inherent in all other teaming modes and is switch agnostic.

Switch-Independent Load Balancing Mode

Switch-independent load balancing mode provides a failsafe feature and supports transmit load balancing. For receive load balancing, use the 802.3ad modes.

In this mode, the outbound traffic is efficiently distributed across the member adapters to increase the transmit bandwidth. Traffic load balancing is connection-based to avoid out-of-order packet delivery. The administrator can select one of the following load distribution types:

- **Auto Select** indicates that the load is distributed based on the target IP address (IPv4 or IPv6) and port number. This option ensures a one-to-one correspondence between a traffic flow and a team adapter.
- **MAC address based** indicates that the load is distributed based on the target MAC address.

In switch-independent load balancing, a team receives the traffic on the preferred primary adapter. If the preferred primary adapter fails, the receive load switches to a secondary adapter (failover operation). If the preferred primary adapter becomes operational again, the receive load fails back to the preferred primary adapter (failback operation). Thus, a switch-independent load balancing team also behaves like a failsafe team. Each time the preferred primary changes due to failover or failback, other network elements are notified of the change in the primary adapter through team gratuitous address resolution protocols (ARPs).

Link Aggregation Mode

link aggregation provides increased bandwidth and high reliability by combining several NICs into a single, logical, network interface called a link aggregation group (LAG). The link aggregation is scalable, meaning an adapter can be added or deleted either statically or dynamically from a team.

Traffic from all the team ports that form a LAG have the same MAC address, which is the MAC address of the team. If a new adapter joins the LAG, or an adapter forming the LAG fails, the LAG becomes operational again after a brief exchange of protocols between the switch and the server. QLogic Adapters are rapidly aggregated, with a latency of 1 to 2 seconds.

Two options are available in the link aggregation mode:

- Static link aggregation
- Dynamic link aggregation

NOTE:

The switch must support the IEEE 802.3ad standard for the preceding two link aggregation modes to work.

Static Link Aggregation (SLA)

Static link aggregation (SLA, 802.3ad static protocols with generic trunking) is a switch-assisted teaming mode, where the switch must be 802.3ad compliant. The switch ports must be configured so that the switch perceives adapters from a LAG as a single, virtual adapter.

In SLA, the ports on the switch are active by default. There is no negotiation between the switch and the teaming driver to decide on adapters participating in a LAG.

In SLA mode, the protocol stack responds to ARP requests with a single, advertised MAC address, and an IP address corresponding to the LAG. Each physical adapter in the team uses the same team MAC address during transmission. As the switch (at the other end of link) is aware of the trunking teaming mode, it appropriately modifies the forwarding table to indicate the trunk as a single virtual port. This modification ensures correct traffic routing on the receive side as well. In this mode, the switch also distributes receive traffic across the member adapters.

Dynamic Link Aggregation (DLA)

Dynamic link aggregation (DLA) with LACP is similar to SLA except that LACP allows self configuration of LAG through handshaking between the switch and the intermediate driver. For the team to function, LACP must be enabled at both ends of the link: the server and the switch. LACP (802.3ad dynamic) allows switch ports to dynamically communicate with the teaming driver, allowing controlled addition and removal of ports from the team.

Link aggregation mode has transmit load balancing and fail safety support. If a link connected through a participant port of a link-aggregated team goes down, LACP provides failover and load balancing across the remaining members of the team. In addition, if a new member port is added to the team or is removed from the team, the switch performs load rebalancing for the receive operation and the driver performs load balancing for the transmit operation, to accommodate the change in configuration.

Transmit load distribution in LACP provides the following options:

- **None** indicates no traffic distribution. Only a single “active” adapter is used for transmit. The driver selects the active adapter based on LACP state information.
- **Auto Select** indicates that the load is distributed based on the target IP address and port number. This option ensures a one-to-one correspondence between a traffic flow and a team adapter.
- **MAC address based** indicates that the load is distributed based on the target MAC address.

Using the CLI for Teaming

You can view, create, configure, and delete teams using the QConvergeConsole CLI utility.

To view a list of teams, issue the following command:

```
qaucli -nic -teamlist
```

To view team information, issue the following command:

```
qaucli -nic -teaminfo <team_inst|ALL>
```

To preview available ports before configuring a new team, issue the following command:

```
qaucli -nic -teamnew_portspreview
```

To configure a new team, issue the following command:

```
qaucli -nic -teamnew <team_type> <port_insts|ALL>
```

where `port_insts` are the ports indices separated by commas (for example, 1,2) and `team_type` is either 1=Fail Over or 2=Load Balanced.

To delete a team, issue the following command:

```
qaucli -nic -teamedel <team_inst|ALL>
```

Using the Team Management GUI

Use the **Team Management** property page to manage the following teaming-related activities:

- Viewing network topology
- Creating, modifying, and deleting teams
- Viewing and changing team properties
- Adding and deleting virtual adapters

To open the **Team Management** property page:

1. In Windows, access the Computer Management dialog box, and then click **Device Manager** in the left pane.
2. Under **Network adapters**, right-click the **QLogic 10Gigabit Ethernet** adapter, and then select **Properties**.

3. Click the **Team Management** tab to bring that page to the front (Figure 2-5) and perform teaming-related management.

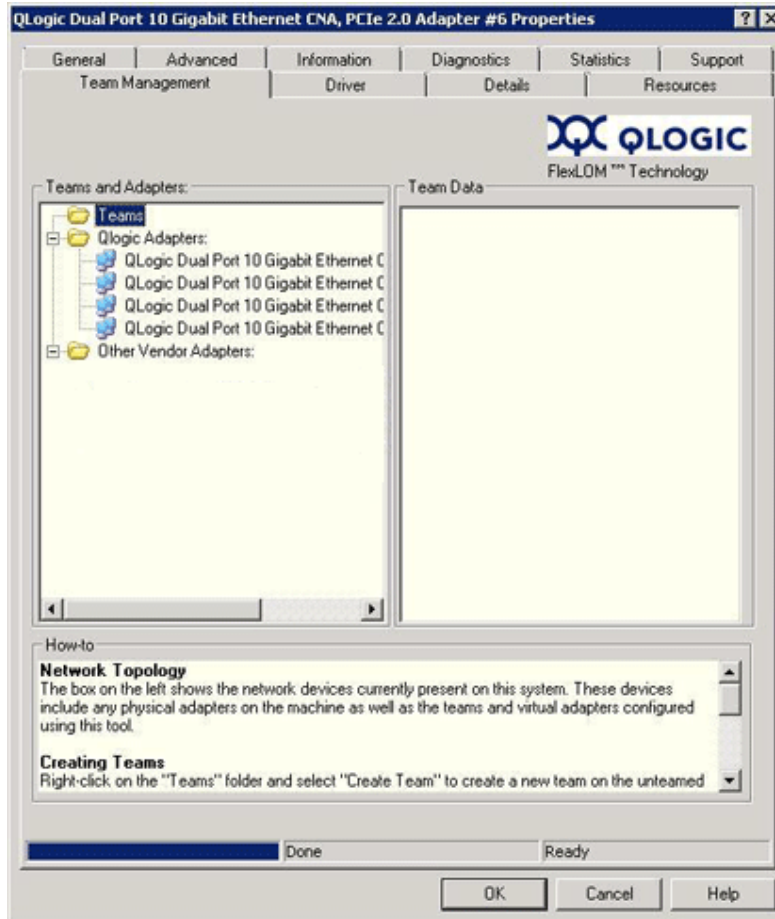

Figure 2-5. Team Management Property Page

On the **Team Management** page, the **Teams and Adapters** pane on the left lists the network devices currently present on this system, including:

- Teams and virtual adapters, as well as their member physical adapters
- QLogic and other vendor adapters

Teaming Configuration

Teaming configuration includes creating, modifying, and deleting teams, and viewing team statistics on the Team Management property page. To launch the Team Management property page, see [“Using the Team Management GUI” on page 2-19](#).

Information on teaming configuration includes the following:

- “Creating a Team” on page 2-21
- “Modifying a Team” on page 2-27
- “Deleting a Team” on page 2-33
- “Saving and Restoring Teaming Configuration” on page 2-34

Creating a Team

To create a team:

1. To create a team, right-click the **Teams** folder icon, and then click **Create Team** (Figure 2-6).

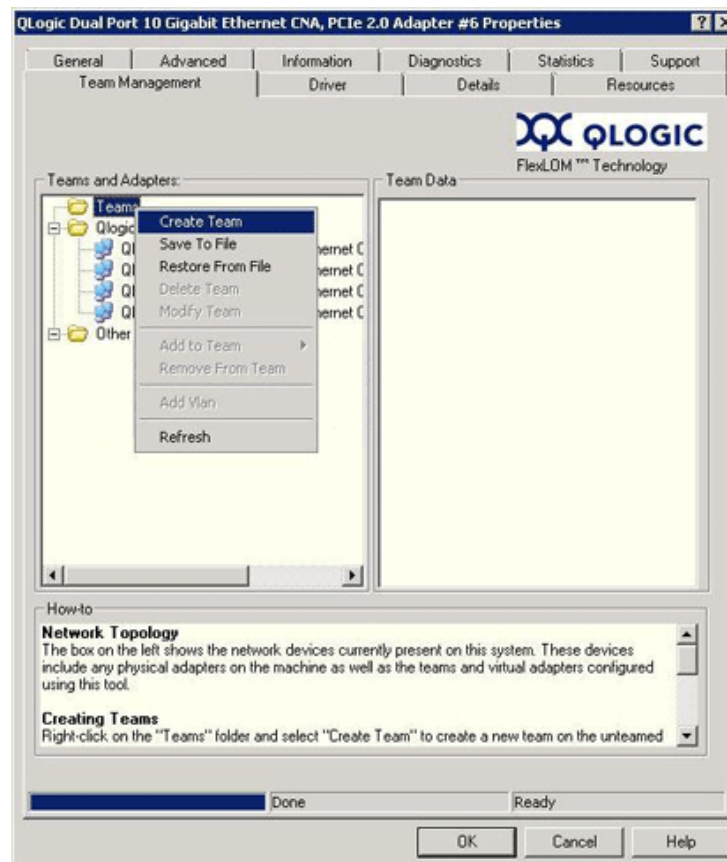

Figure 2-6. Creating a Team

2. The software automatically picks a unique team name, or you can enter your own team name. Team names must be unique on a system.

3. On the **Create Team** dialog box, specify the following (see the message pane at the bottom of the dialog box for more details), and then click **OK** to return to the adapter properties:
 - Name**—Type a name for the new team.
 - Type**—Select the teaming mode by clicking either **Failsafe Team**, **802.3ad Static Team**, **802.3ad Dynamic Team**, or **Switch Independent Load Balancing**. If you select the 802.3ad dynamic option, you must also select one of the following options:
 - **Active LACP**: LACP is a Layer 2 protocol that controls the teaming of physical ports into an aggregated set. LACP discovers if a host's ports are connected to a switch that supports aggregation on the connected ports and configures those ports into an aggregation bundle. For LACP to operate, one side has to be Active LACP. The Active LACP side of the protocol initiates the protocol.
 - **Passive LACP**: The Passive LACP side responds to the active LACP requests.
 - Adapters to Add**—Select the check box next to each adapter that should form the team.
 - Use default MAC Address**—Select this check box to have the driver assign a MAC address, or clear the check box to select a locally-administered MAC address from the list.
 - Select Preferred Primary Adapter**—Choose a preferred primary adapter for the team from the list of teamed adapters, or **None** to allow the driver to assign the preferred primary adapter.
 - Failback Type**—If this is a Failsafe Team, select a failback type of **None**, **Auto Select**, or **Preferred Primary**.
 - Load Balancing Type**—If this is an 802.3ad Static Team or 802.3ad Dynamic Team, select the type of load balancing: **Auto**, **MAC Address Based**, or **None**.
 - Distribution Type**—If this is a Switch Independent Load Balancing team type, select a distribution type of either **Auto Select** or **MAC Address Based**.
 - Advanced**—Click this button to configure QLogic-specific team capabilities such as RSS, MTU, or various offloads. These properties configure the member adapters to avoid any conflict after a team has been created.

Figures 2-7 through 2-10 show the configuration of various teaming modes.

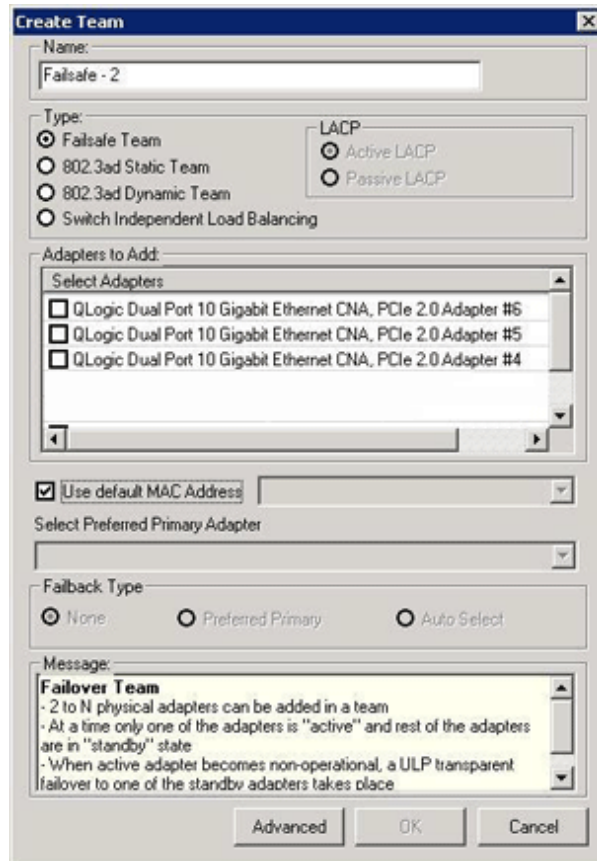

Figure 2-7. Creating a Failsafe Team

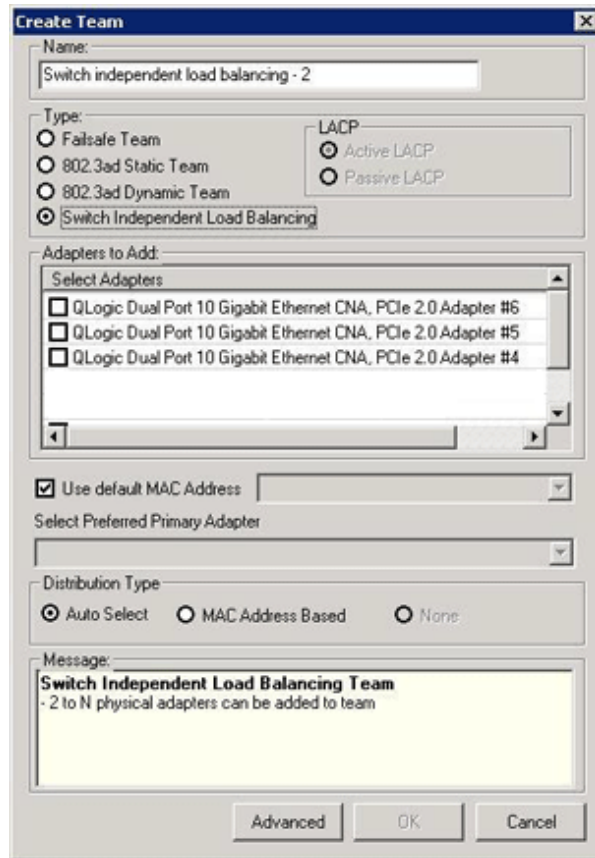

Figure 2-8. Creating a Switch-Independent Load Balancing Team

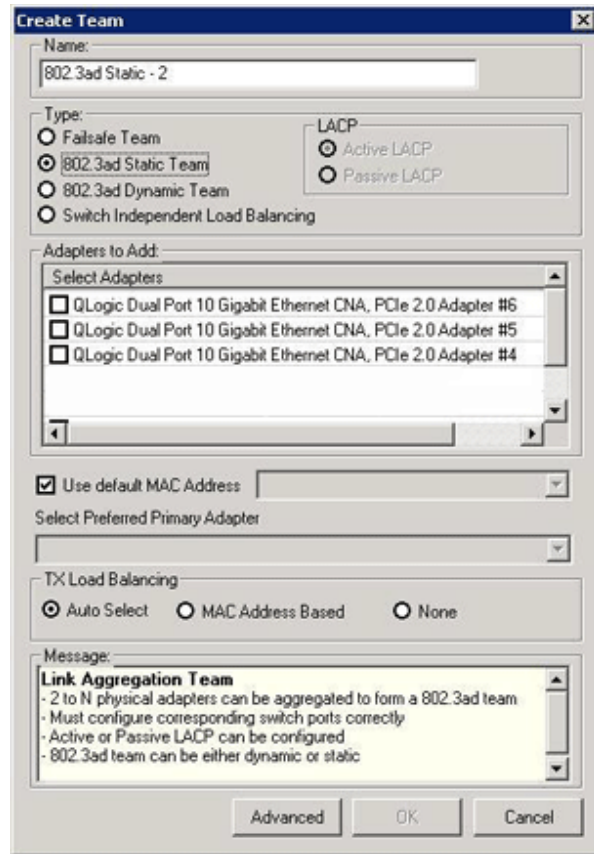

Figure 2-9. Creating an 802.3ad Static Team

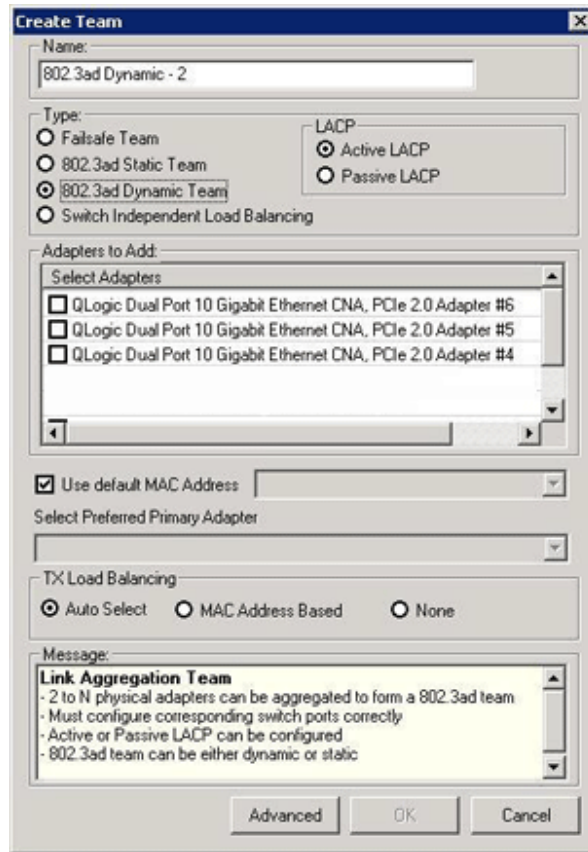

Figure 2-10. Creating an 802.3ad Dynamic Team

To confirm if a team has been successfully created, view the **Team and Adapters** pane on the Team Management page.

Figure 2-11 shows an example of a newly-formed team. The **Team Data** pane on the right shows the properties, information, and status of the team or adapter that is currently selected in the **Teams and Adapters** pane on the left.

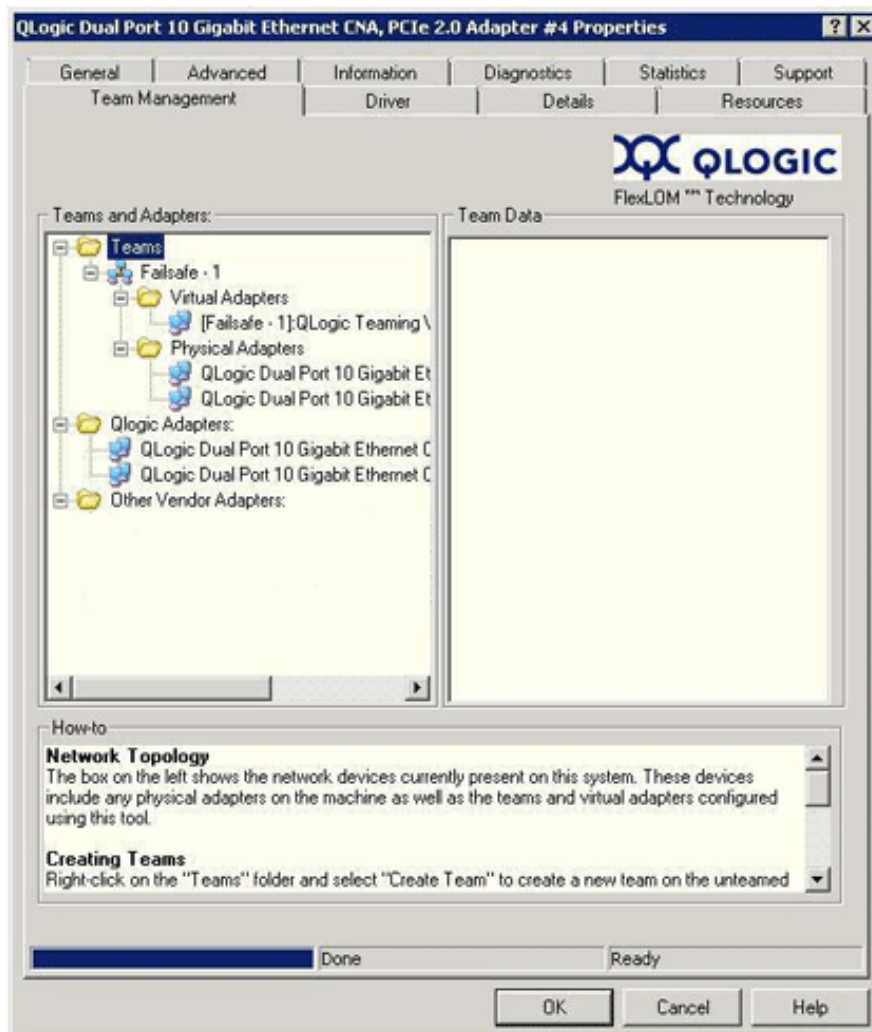

Figure 2-11. Confirming New Team Creation

Modifying a Team

A team can be modified by:

- Adding or removing one or more team members to a team.
- Modifying the team properties.

To add team members:

1. On the **Team Management** property page, right-click the unteamed adapter to add to a team.
2. On the shortcut menu, point to **Add to Team**, and then click the team to which you want to add the adapter ([Figure 2-12](#)).

NOTE:

You cannot add an adapter to a team that is already a member of another team. Teaming of teams is not supported.

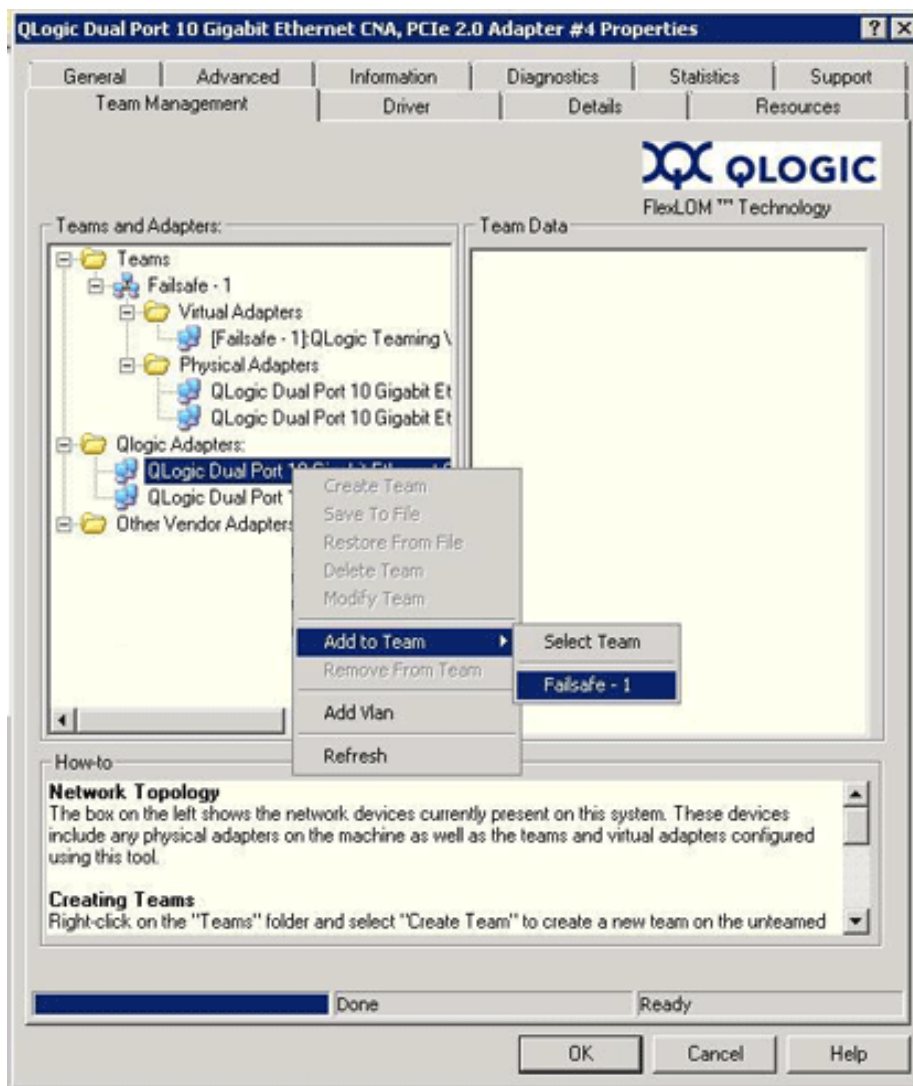

Figure 2-12. Adding a Team

To remove an adapter from a team:

NOTE:

A team must include at least one QLogic Adapter. A QLogic Adapter is allowed to be deleted from a team only if it is not the last QLogic-teamed Adapter.

1. On the **Team Management** property page, right-click the adapter to be removed from the team.
2. On the shortcut menu, click **Remove from Team**.
3. At least two adapters must be present in a team. If an adapter is no longer required to be a member of a team, it can be removed from the team.

To change a team property:

For the VLAN and teaming solution to work correctly, the properties of all teamed adapters and adapters with multiple VLANs must remain synchronized with the team properties. Ensure that you change the properties of a team and an adapter with VLANs only on the Team Management page.

1. On the **Team Management** page, in the right pane under **Team Data**, expand the **Properties** list.
2. Double-click the team property you need to change.
3. In the **Advanced Team Properties** dialog box (Figure 2-13), specify a new property value, and then click **OK**.

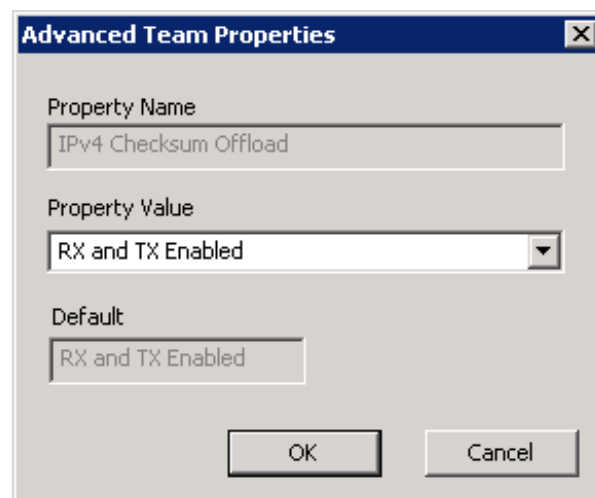

Figure 2-13. Modifying Advanced Team Properties

The team properties change takes effect immediately. Changing team properties causes the driver to reload, which could result in a momentary loss of connectivity.

NOTE:

To ensure that the properties of all teamed adapters and adapters with VLANs remain synchronized with the team properties, do not directly modify the adapter properties on the **Advanced** page. If an adapter property becomes out of sync with its team properties, change either the team or adapter property so that they are the same on each, and then reload the team. To reload a team: On the **Team Management** page, in the left pane under **Teams and Adapters**, right-click the team name, and then click **Reload Team**.

To modify team composition:

1. On the **Team Management** page, in the left pane under **Teams and Adapters**, right-click the team name whose properties are to be changed.
2. On the shortcut menu, click **Modify Team** (Figure 2-14).

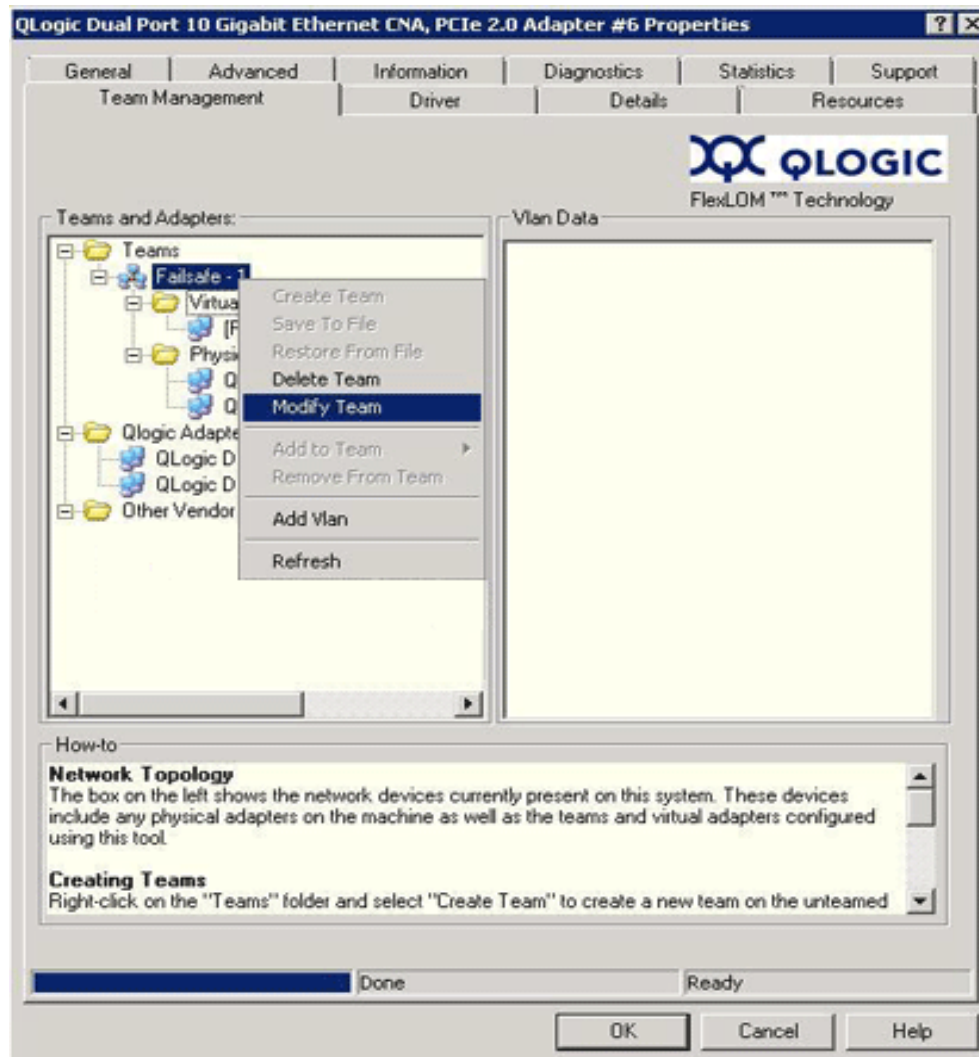

Figure 2-14. Modifying Team Properties

3. In the **Modify Team Properties** dialog box, change the team parameters as needed, and then click **OK**.

Example 1

For a failsafe team, you can change the team name, assigned team static MAC address, preferred primary adapter, and failback type (Figure 2-15).

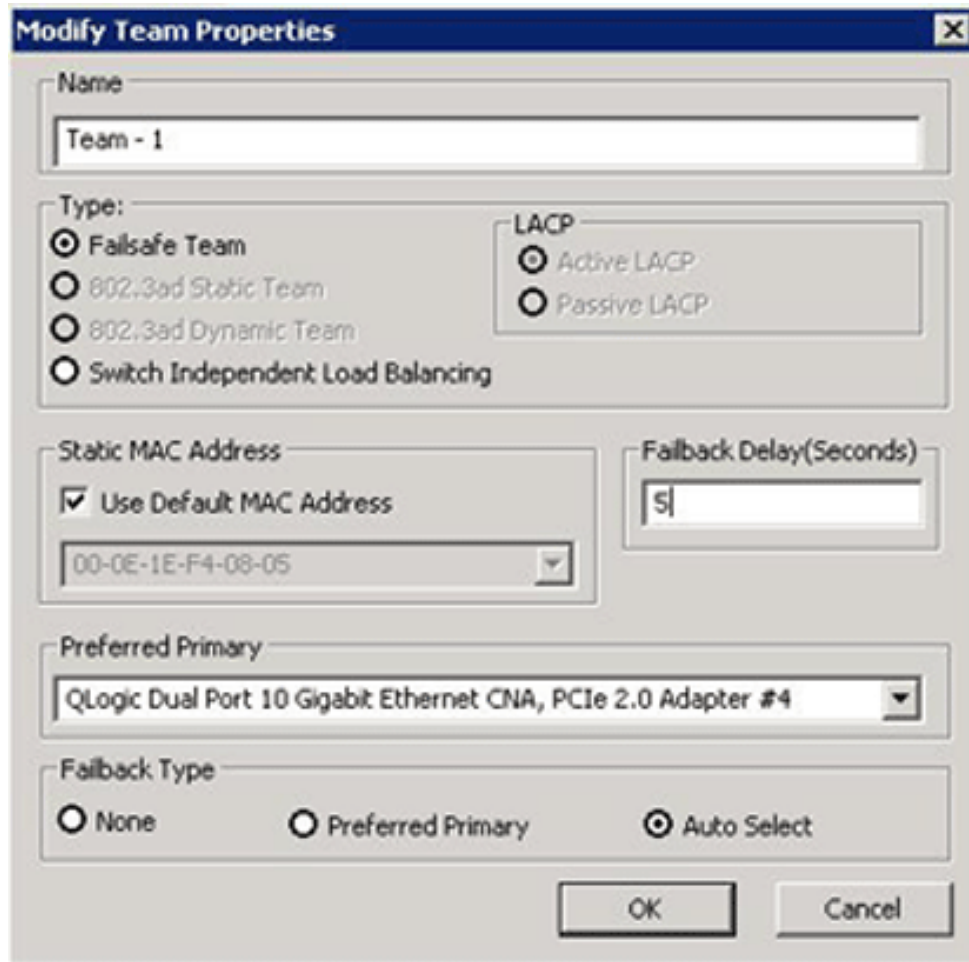

Figure 2-15. Modifying Failsafe Team Properties

Example 2

You can change the team type and the corresponding team attributes. For example, you can change from failsafe to switch-independent load balancing, or from 802.3ad static team to 802.3ad dynamic team. [Figure 2-16](#) shows a failsafe team modification, which shows the new team type and default values for team attributes. You can manually change attribute values.

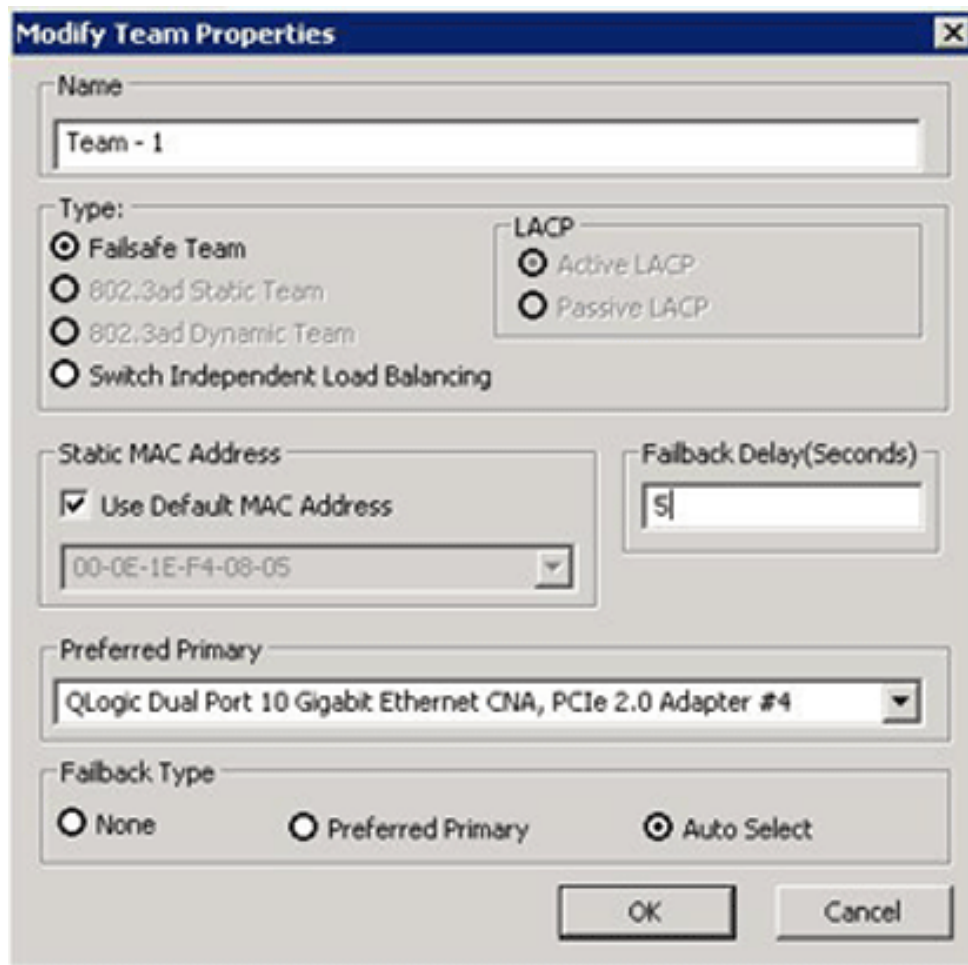

Figure 2-16. Modifying the Team Type

Deleting a Team

To delete a team:

1. On the **Team Management** property page, in the left pane under **Teams and Adapters**, right-click the team name to be deleted.
2. On the shortcut menu, click **Delete team**.

Saving and Restoring Teaming Configuration

QLogic recommends that you periodically save the configuration to prevent any accidental loss of network topology and settings. Current configuration including the teams, VLANs, and properties can be saved to a file. Restoring an earlier configuration results in the destruction of the current configuration.

To save a configuration:

1. On the **Team Management** page under **Teams and Adapters**, right-click the **Teams** folder.
2. On the shortcut menu, click **Save to File**.
3. Enter a location to save the configuration.

To restore a configuration:

1. On the **Team Management** page under **Teams and Adapters**, right-click the **Teams** folder.
2. On the shortcut menu, click **Restore From File**.
3. Select a previously saved configuration file.

Viewing Teaming Statistics

You can view teaming and Ethernet statistics using the QConvergeConsole (QCC) CLI utility.

To view teaming statistics, issue the following command:

```
qaucli -nic -statport
```

To reset the Ethernet statistics counter, issue the following command:

```
qaucli -nic -sreset [cna_port_inst]
```

To display Ethernet port statistics, issue the following command:

```
qaucli -nic -statport [cna_port_inst]
```

To undo the reset of Ethernet statistics counters, issue the following command:

```
qaucli -nic -sunreset [cna_port_inst]
```

Linux Bonding/Failover/Aggregation

The Linux `qlenic` driver supports all the standard bonding modes supported by the Linux bonding driver for bonding, failover, and aggregation. Refer to the Linux bonding driver documentation for additional details on the bonding modes.

Using LACP on 8200 Series Adapters for Windows

NOTE:

This feature is available only on Cisco® systems (Cisco FCoE switch).

By default, link aggregation control protocol (LACP) is disabled on 8200 Series Adapters (it is enabled by default in the 3200 Series Adapters).

Perform the following steps using QLogic Device Windows Properties Page to enable LACP on a 8200 Series Adapter.

1. Log in to the server that contains installed 8200 Series Adapters.
2. Open the Server Manager and select **Diagnostics > Device Manager > Network Adapters**.
3. Right-click the first **QLogic 10 Gigabit Ethernet CNA** device and select **Properties** from the context menu (Figure 2-39).
4. Click the **Team Management** tab.
5. In **Teams and Adapters**, click **Teams**, and then click **Custom Settings**.

The Teaming custom settings dialog box displays (Figure 2-17).

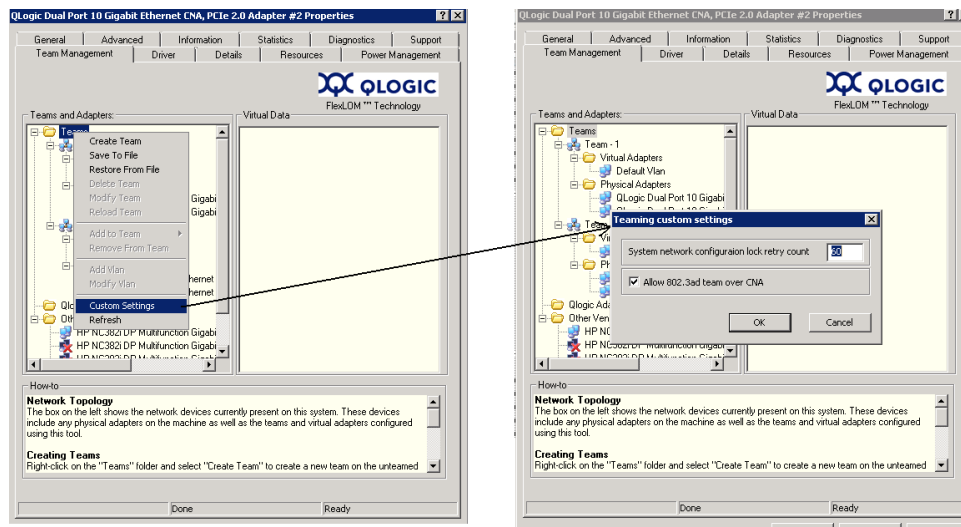

Figure 2-17. Enabling LACP

6. Select the **Allow 802.3as team over CNA** check box, and then click **OK**.

The network must be configured to a Cisco-supported configuration, as described in the following paragraphs. This information is from the Cisco support forum thread, <https://supportforums.cisco.com/thread/2071713>.

A virtual fabric channel (vFC) can be bound inside a virtual port channel (vPC) because the Cisco Nexus® 5x00 (FCF) sees only one link.

Figure 2-18 illustrates a valid configuration with one vPC.

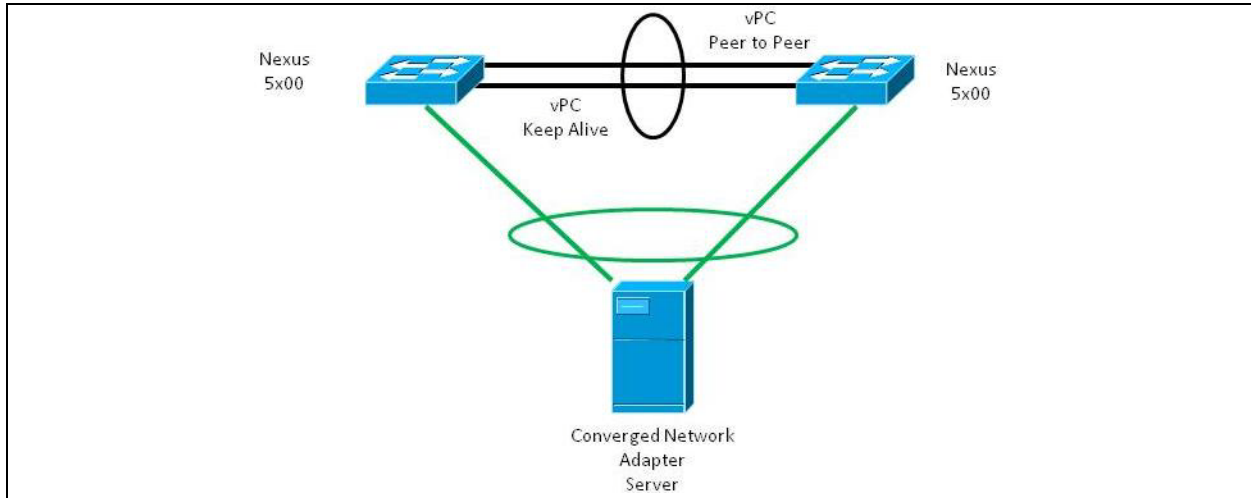

Figure 2-18. LACP Configuration with One vPC

The vFC must be bound by a physical interface in a vPC configuration.

If a server has four Converged Network Adapter ports, then two vPCs can be created, as shown in Figure 2-19.

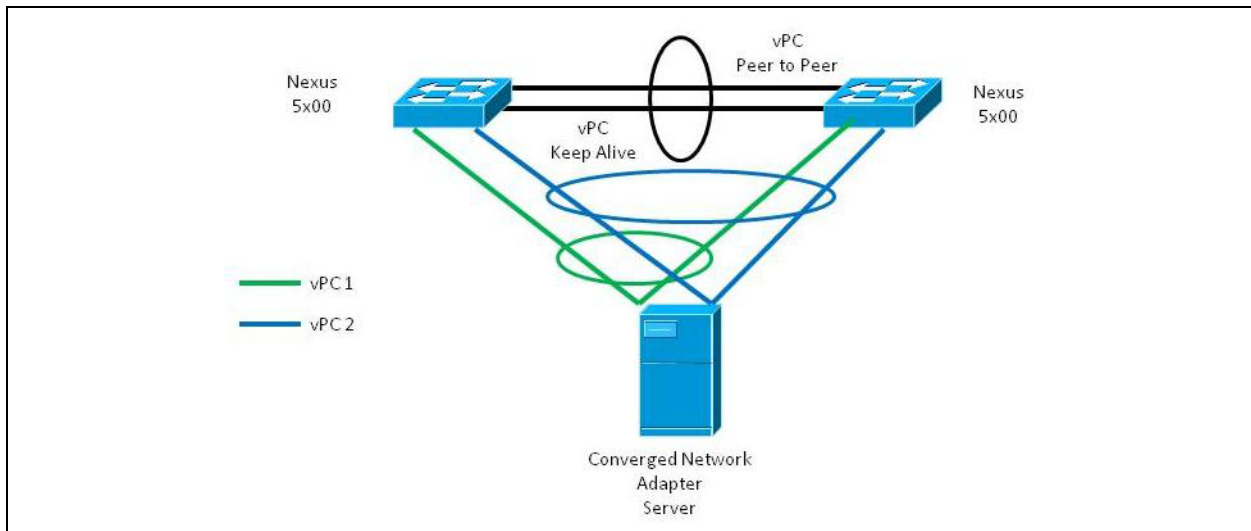

Figure 2-19. LACP Configuration with Two vPCs

An vFC cannot be bound from a server with multiple links in the same Nexus 5x00.

The configurations in [Figure 2-20](#) and [Figure 2-21](#) are unsupported because the vPC can be bound to only one interface.

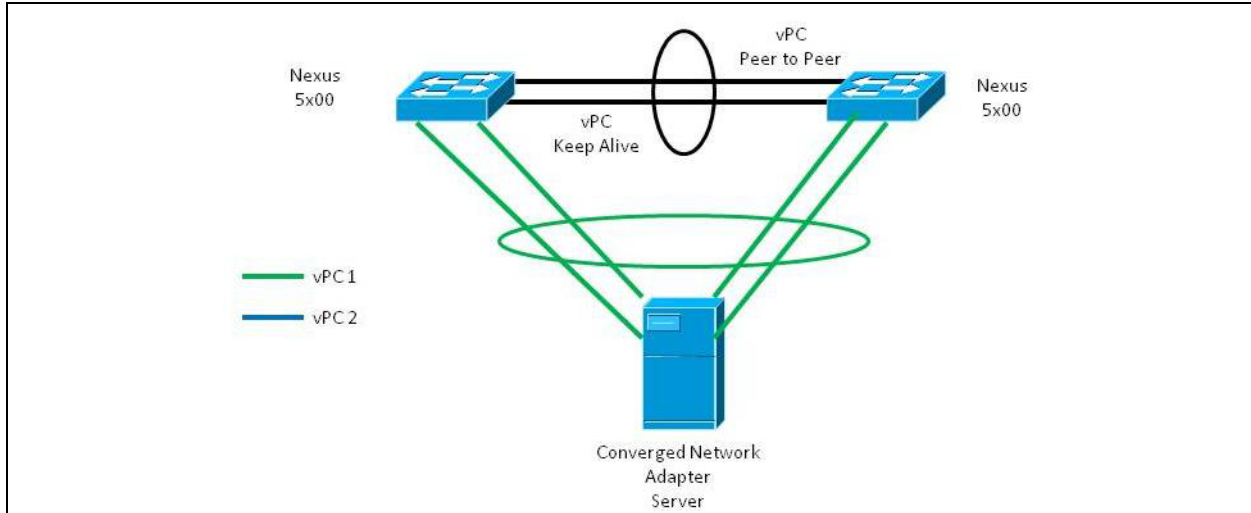

Figure 2-20. Invalid LACP Configuration (One vPC Linked to Two Nexus 5x00s)

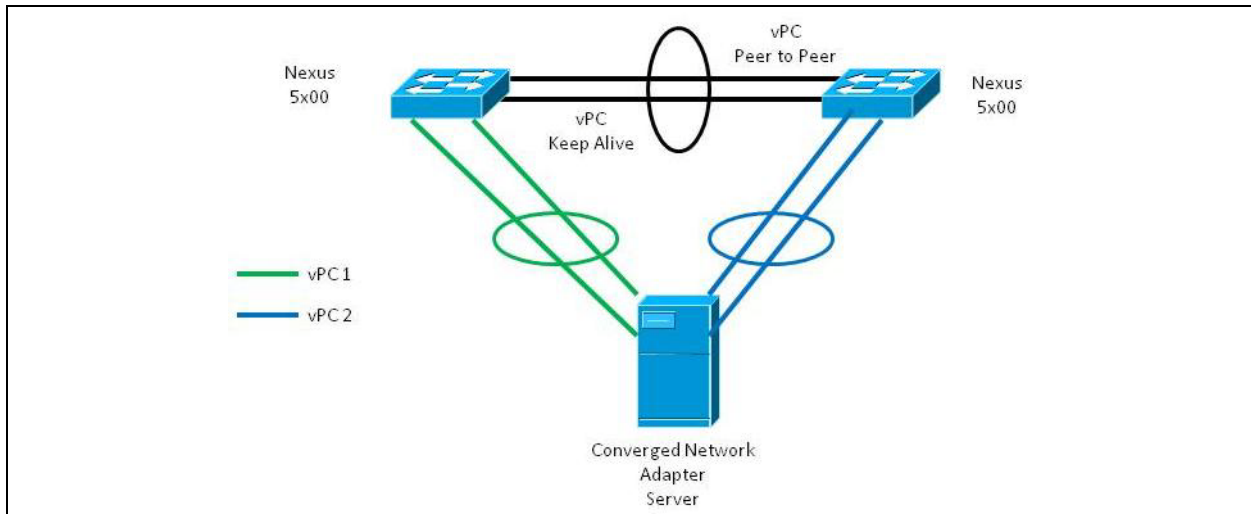

Figure 2-21. Invalid LACP Configuration (Two vPCs Linked Separately to Two Nexus 5x00s)

For information on configuring Cisco Nexus switches for vPCs, see to the following:

- *Cisco Nexus 5000 Series Configuring vPCs* at:
 - http://www.cisco.com/en/US/docs/switches/datacenter/sw/4_2/nx-os/interfaces/configuration/guide/if_vPC.pdf
 - http://www.cisco.com/en/US/prod/collateral/switches/ps9441/ps9670/configuration_guide_c07-543563.html
- *Cisco Nexus 5000 Series FCoE Configuration Guide* at:
http://www.cisco.com/en/US/docs/switches/datacenter/nexus5000/sw/fcoe/502_n1_1/Cisco_n5k_fcoe_config_gd_re_502_n1_1.pdf
- *Cisco Nexus 5000 Series CLI Reference Manual*

NIC Partitioning (NPAR)

NIC Partitioning (NPAR) provides the ability to create multiple physical functions on the PCIe bus that share a single physical port. Each physical function is a PCI endpoint (PCIe) that can have a device driver attached to it.

The NPAR feature in 8200 and 3200 Series Adapters allows you to partition a single 10GbE NIC port into up to four individual partitions with user-configurable bandwidth and interface type (*personality*). The partitioning options are not limited to NIC as the name *NPAR* indicates; it extends to converged fabric partitioning by enabling you to assign iSCSI or FCoE protocols to certain partitions.

For example, each partition can be either native Ethernet NIC, or configured to support iSCSI or FCoE storage devices with different PCIe endpoint device class code. Both iSCSI and FCoE operate in full hardware offload mode.

The QLogic NPAR solution is OS and switch agnostic, which means NPAR does not require a proprietary switch to operate; however, the adapter does require the OS-specific QLogic adapter driver for each supported protocol (NIC, iSCSI, and FCoE). It also means NPAR bandwidth allocation can regulate only transmit traffic (not receive traffic).

After you have configured the NIC partitions as desired on the 8200 and 3200 Series Adapters' ports, you must reboot the server for the personality changes to take effect.

You can modify the minimum and maximum bandwidth for each NPAR. The changes take effect immediately without rebooting the server. The minimum and maximum bandwidths are specified as percentages of the link bandwidth, where:

- Minimum bandwidth is the minimum bandwidth guaranteed to a partition.
- Maximum bandwidth is the maximum value that a partition is permitted to use.

Setup Requirements

Table 2-3 and Table 2-4 provide the requirements for applying NPAR functionality to 8200 and 3200 Series Adapters installed in host servers within SANs.

Table 2-3. NPAR Operating System Requirements

Operating Systems	Platforms
Linux	<ul style="list-style-type: none"> ■ RHEL5.6 and later, x86 and x64 ■ RHEL6.0 and later, x64 only ■ SLES10 SP4 and later, x64 only ■ SLES11 SP1 and later, x64 only
Citrix®	<ul style="list-style-type: none"> ■ XenServer® 6.0 and later
Windows	<ul style="list-style-type: none"> ■ Windows Server 2008 SP2, Windows Server 2008 R2 SP1 <input type="checkbox"/> Hyper-V® ^a

For the latest list of operating systems that support NPAR for QLogic Adapters, please check <http://driverdownloads.qlogic.com>.

^a If a partitioned NIC is configured for use in a Hyper-V network virtualization stack, virtual message queue (VMQ) must be enabled. To enable VMQ on a management OS with physical network adapters less than 10Gbps, enter the following command in a command prompt window: `reg add HKEY_LOCAL_MACHINE\SYSTEM\CurrentControlSet\services\VMSMP\Parameters /v BelowTenGigVmqEnabled /t REG_DWORD /d 1 /f`

Table 2-4. NPAR Management Tool and Driver Requirements

SW Components	Description
Management Tools	
QLogic OptionROM	Flash image containing firmware and boot code
QLogic QConvergeConsole GUI/CLI	Management tools that can be utilized for NPAR configuration and management
QLogic Device Windows Properties Page	Can be used for NPAR configuration and management in Windows
Drivers	
Adapter drivers	NIC, FCoE, and iSCSI drivers

Management tools and drivers are located on the QLogic Web site <http://driverdownloads.qlogic.com>.

NPAR Configuration

This section defines NPAR configuration, options, and management tools you can use to set up NPAR on the 8200 and 3200 Series Adapters.

In addition to defining NPAR, this section describes:

- [“NIC Partitioning Options” on page 2-40](#)
- [“Personality Changes” on page 2-41](#)
- [“Quality of Service” on page 2-42](#)
- [“eSwitch” on page 2-43](#)
- [“Configuration Management Tools” on page 2-44](#)

NIC Partitioning Options

The NPAR feature in 8200 and 3200 Series Adapters provides the ability to create multiple PCIe physical functions for each physical 10 GbE port on the adapter. Each PCIe function appears as an independent interface to the host operating system or hypervisor.

When the 8200 and 3200 Series Adapters are configured as Ethernet-only, each adapter contains eight Ethernet functions.

By default, NPAR functionality is disabled on the adapters, having only two Ethernet functions enabled. Depending on the feature personality mapping supported on the adapter, you can enable additional Ethernet or storage functions.

The PCI function number assignment is as follows:

- Functions 0 and 1 are always NIC, function 0 for port 0 and function 1 for port 1; any of the other functions can be individually enabled or disabled.
- NIC, iSCSI, and FCoE have fixed function numbers.
- Functions 2 and 3 can only be NIC personalities.
- Functions 4 and 5 can be iSCSI or NIC personalities.
- Functions 6 and 7 can be FCoE or NIC personalities.
- You can configure only one iSCSI and one FCoE personality for each physical port.

The 8200 and 3200 Series Adapters support a maximum of 64 Layer-2 MAC address filters across all partitions, which limits the number of virtual network adapters that can be created on a partitioned NIC. The NIC driver evenly distributes the number of filters across all NIC partitions.

For example, if the NIC adapter has four NIC partitions, two NIC partitions per physical port, then each NIC partition gets 16 filters ($64/4 = 16$). In this case, do not create more than 16 virtual network adapters on any NIC function that is configured to be used by a Hyper-V network virtualization stack.

The VLAN and teaming solutions on partitioned NIC functions have the following restrictions:

- A failsafe team cannot be created using NIC functions that belong to the same physical port. For example, physical function 2 (PF2) cannot be a backup for PF0 because both functions are partitions of the same physical port.
- 802.3ad link aggregation teams are not allowed on partitioned NIC functions.

Figure 2-22 shows the default NPAR function settings.

Up to 4 physical functions on each physical port

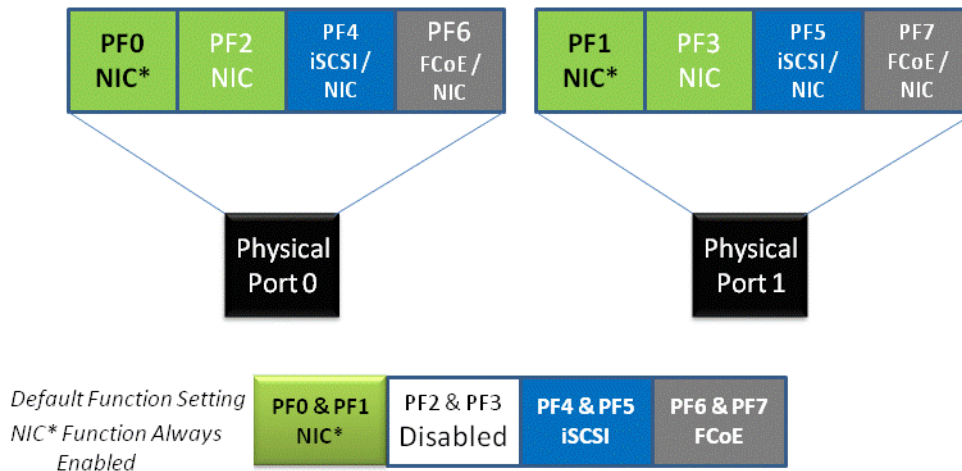

Figure 2-22. NPAR Default Function Settings

Personality Changes

Based on your operating environment, you can use your preferred management tool to change or disable PCI functions on either physical port. Using this feature lets you divide each physical port into up to four partitions, configured to support one of the following PCI function types: NIC, FCoE, or iSCSI.

NOTE:

Throughout this section, the terms *personality* and *function type* are used interchangeably.

Table 2-5 shows the port identifications and the possible NPAR configurations.

Table 2-5. NPAR Configuration Options

Function Number	Function Type	Physical Port Number	Notes
0	NIC	0	Always present. Always NIC. Cannot be disabled.
1	NIC	1	
2	NIC	0	NIC or disabled
3	NIC	1	
4	iSCSI/NIC	0	iSCSI, NIC, or disabled
5	iSCSI/NIC	1	
6	FCoE/NIC	0	FCoE, NIC, or disabled
7	FCoE/NIC	1	

Only one iSCSI and/or FCoE function per physical port. NIC, iSCSI, and FCoE have fixed function numbers. Functions 2–7 can be independently disabled.

Quality of Service

Quality of service (QoS) refers to the *bandwidth allocation* assigned to each partition used to send and receive data between the adapter port and connected devices.

Each physical port on the 8200 and 3200 Series Adapters can send and receive data at up to 10Gbps in both directions at the same time. When the physical port is partitioned into four partitions, the port bandwidth is divided between each port partition according to traffic demands.

You can set QoS for each port partition by setting minimum and maximum percentages of the physical port's bandwidth for each partition. This feature helps guarantee a transmission rate for each partition that requires a particular bandwidth to run critical applications using port partitions. The setting for a given QoS can resolve bottlenecks that exist when virtual machines (VMs) contend for port bandwidth.

Enhanced transition selection (ETS) controls the actual bandwidth allocation at the network port. The bandwidth allocation under ETS is typically 50 percent for FCoE traffic and 50 percent for Non-FCoE traffic (NIC and iSCSI). Therefore, NPAR QoS allocations among the NIC partitions for a given port allocate a percentage of the Non-FCoE portion of the bandwidth.

NPAR QoS allows NIC partitions to each allocate a minimum guaranteed portion of the available bandwidth. QoS bandwidth only applies only to NIC partitions. iSCSI partitions are not supported by the QoS bandwidth allocation. This brings up the possibility that, if the total minimum allocated bandwidth across the NIC partitions equals 100 percent, then the iSCSI partition will be limited to 1 percent of the NIC bandwidth portion in high-utilization conditions.

To ensure that iSCSI has more than 1 percent of bandwidth available in high-utilization conditions, set the total NPAR QoS minimum bandwidth settings so that they equal less than 100 percent.

Example

- An NPAR enabled port has two NIC partitions, one iSCSI partition, and one FCoE partition.
- ETS allocates 50 percent of the network bandwidth to FCoE traffic and 50 percent to non-FCoE traffic.
- The NPAR QoS minimum bandwidth setting for each NIC partition is 50 percent.

This setting means that each NIC partition is guaranteed 50 percent of 50 percent of 10Gb, or 2.5Gb each.

- If at any time the FCoE partition is using 5Gb of bandwidth and each NIC partition is using 2.5Gb, then the iSCSI partition is left with only 50Mb of bandwidth.
- If, however, the NIC partitions each allocated 45 percent of the non-FCoE traffic, then the total allocated bandwidth would be 90 percent.
 - The remaining 10 percent (or 500 Mb) would then be effectively reserved for the iSCSI partition.

eSwitch

The 8200 and 3200 Series Adapters support embedded switch (eSwitch) functionality, which provides a basic VLAN-aware Layer-2 switch for Ethernet frames. Each physical port has one instance of an eSwitch, which supports all NPARs on that physical port.

The eSwitch operation is transparent and the administrator does not need to perform any specific configuration. The ability to view eSwitch statistics depends on your operating environment and management tool.

The QLogic drivers download the VM MAC addresses to the firmware, which enables the firmware and hardware to switch the packets destined for VMs on the host.

For traffic to flow from one eSwitch to another, it must first pass through an external switch or have been forwarded by a VM that has a path through both eSwitches.

Configuration Management Tools

Depending on your operating environment and preferred system management techniques, you can use any of the following tools to set up NIC partitions (NPARs) on 8200 and 3200 Series Adapters' ports to meet your system's networking requirements:

- [“QLogic OptionROM at POST” on page 2-44](#)
- [“QConvergeConsole \(QCC\) GUI” on page 2-44](#)
- [“QConvergeConsole \(QCC\) CLI” on page 2-45](#)
- [“QLogic Device Windows Properties Page” on page 2-46](#)

QLogic OptionROM at POST

The QLogic OptionROM is flashed on the 8200 and 3200 Series Adapters at the factory. When you first start the server that contains 8200 and 3200 Series Adapters, the power-on self test (POST) starts. Running the POST test gives you access to the OptionROM utility.

For procedures on setting up NPAR and eSwitch parameters using the OptionROM while powering up the host server, see [“QLogic OptionROM at POST” on page 3-10](#).

QConvergeConsole (QCC) GUI

The QConvergeConsole unified adapter Web management interface is a web-based client/server application that allows for centralized management and configuration of QLogic adapters within the entire network (LAN and SAN).

On the server side, the QConvergeConsole runs as an Apache Tomcat Server web application. After the application is launched on the web server, you can connect to the QConvergeConsole's GUI through a browser, either locally on the server or remotely from another computer. Your browser window becomes the client used to connect to servers that host the 8200 and 3200 Series Adapters and connected storage devices within the network.

In addition to the configuration and management tools available through the QConvergeConsole GUI, the QCC enables you to partition and configure NIC ports and eSwitch parameters on 8200 and 3200 Series Adapters.

Follow the procedures in the *QConvergeConsole User's Guide* to install the application on a Windows or Linux server. Before using the QCC GUI to configure NPAR on your 8200 and 3200 Series Adapters, you must also install the drivers on the server where the 8200 and 3200 Series Adapters reside.

Before configuring NPAR, do the following:

- Use the QLogic SuperInstaller for your host server's operating system (Windows or Linux) to install the Fibre Channel/FCoE, NIC, and iSCSI drivers on the server where the adapters reside. To download the installers and drivers, go to <http://driverdownloads.qlogic.com>.
- Make sure the remote agents are running on the Tomcat Server where the QCC GUI application resides:
 - Fibre Channel/FCoE (qlremote)
 - NIC (netqlremote)
 - iSCSI (iqlremote)

For help using the QCC GUI, use the help system, available through the QCC GUI browser-based menu option **Help > Browse Contents**.

For procedures on setting up NPAR and eSwitch parameters using the QCC GUI, see ["QConvergeConsole \(QCC\) CLI" on page 3-21](#).

QConvergeConsole (QCC) CLI

QConvergeConsole (QCC) CLI is a management utility that centralizes management and configuration of QLogic adapters within the entire network (LAN and SAN).

QCC manages iSCSI, Ethernet, and FCoE functions on 8200 and 3200 Series Adapters installed in a Linux or Windows environment.

In addition to the configuration and management capabilities available through the QConvergeConsole CLI, the QCC CLI enables you to partition and configure NIC ports and eSwitch parameters on 8200 and 3200 Series Adapters.

Follow the procedures for your operating system in the *QConvergeConsole CLI User's Guide* to install the application on the host server.

For command references needed while using QCC CLI, refer to the *QConvergeConsole CLI User's Guide*.

Before using QCC CLI to configure NPAR on your 8200 and 3200 Series Adapters, you must install the OS-specific drivers on the server where the 8200 and 3200 Series Adapters reside. You can use the QLogic SuperInstaller for your host server's operating system (Windows or Linux) to install the Fibre Channel/FCoE, NIC, and iSCSI drivers. To download the drivers, go to <http://driverdownloads.qlogic.com>.

For procedures on setting up NPAR and eSwitch parameters using the QCC CLI, see ["QConvergeConsole \(QCC\) CLI" on page 3-21](#).

QLogic Device Windows Properties Page

Servers that run on supported Windows operating systems have the Windows-based tools available for configuring QLogic adapters. These tools enable you to use the QLogic Device Windows Properties Page to set up and manage NIC partitions.

For system requirements, see [“Setup Requirements” on page 2-39](#).

For procedures on using this native server management tool on a Windows Server to configure NPAR on the 8200 and 3200 Series Adapters’ NIC ports, see [“Windows Device Manager” on page 3-27](#).

NPAR Setup and Management Options

This section describes how to configure NIC partitions (NPARs) on 8200 and 3200 Series Adapters installed in a host server within a SAN. Procedures for establishing quality of service (QoS) for each partition and viewing the eSwitch parameters and statistics are included.

This section provides setup procedures using the following management tools:

- [“QLogic OptionROM at POST” on page 2-47](#)
- [“QConvergeConsole \(QCC\) GUI” on page 2-51](#)
- [“QConvergeConsole \(QCC\) CLI” on page 2-55](#)
- [“QLogic Device Windows Properties Page” on page 2-60](#)

NOTE:

These procedures assume you have either local or remote access to a host server with at least one installed 8200 and 3200 Series Adapter, as well as the necessary drivers and management tools.

Overview

Depending on your operating environment and preferred system management techniques, you can use any of the tools described in this section to set up NIC partitions (NPARs) on 8200 and 3200 Series Adapters’ ports to meet your system’s networking requirements.

When you first start the server that contains the 8200 and 3200 Series Adapters, the power-on self test (POST) starts. Running POST gives you access to one of the configuration tools you can use to set up NIC partitions on 8200 and 3200 Series Adapters’ ports: QLogic OptionROM.

The QConvergeConsole GUI and CLI tools work on both Linux and Windows Servers. If you prefer using a browser-based GUI interface, you can use the QConvergeConsole GUI to partition Ethernet ports into NIC, FCoE, or iSCSI partitions and establish quality of service (QoS) by adjusting the bandwidth settings. As an alternative, you can use QConvergeConsole CLI to set up partitions using a command line interface in either interactive or non-interactive mode.

On Windows host servers, you can use the QLogic Device Windows Properties Page to set up and manage NIC partitions (for more information, see [“QLogic Device Windows Properties Page”](#) on page 2-60).

QLogic OptionROM at POST

When you first start the host server that contains 8200 and 3200 Series Adapters, the power-on self test (POST) starts. Running the POST test gives you access to the OptionROM utility.

To set up NPAR using OptionROM:

1. When the screen prompts you to enter the setup menu ([Figure 2-23](#)) during the POST test, press Ctrl+Q to enter the OptionROM setup.

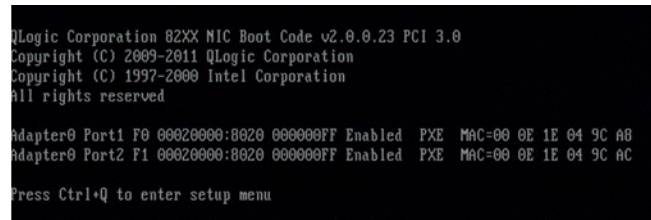

```
QLogic Corporation 82XX NIC Boot Code v2.0.0.23 PCI 3.0
Copyright (C) 2009-2011 QLogic Corporation
Copyright (C) 1997-2000 Intel Corporation
All rights reserved

Adapter0 Port1 F0 00020000:8020 000000FF Enabled PXE MAC=00 0E 1E 04 9C AB
Adapter0 Port2 F1 00020000:8020 000000FF Enabled PXE MAC=00 0E 1E 04 9C AC

Press Ctrl+Q to enter setup menu
```

Figure 2-23. POST Test Screen Prompt to Enter Setup Menu

2. Select the adapter you want to manage on the QLogic CNA Function Configuration screen.

The screen displays a list of functions available to the selected adapter (Figure 2-24).

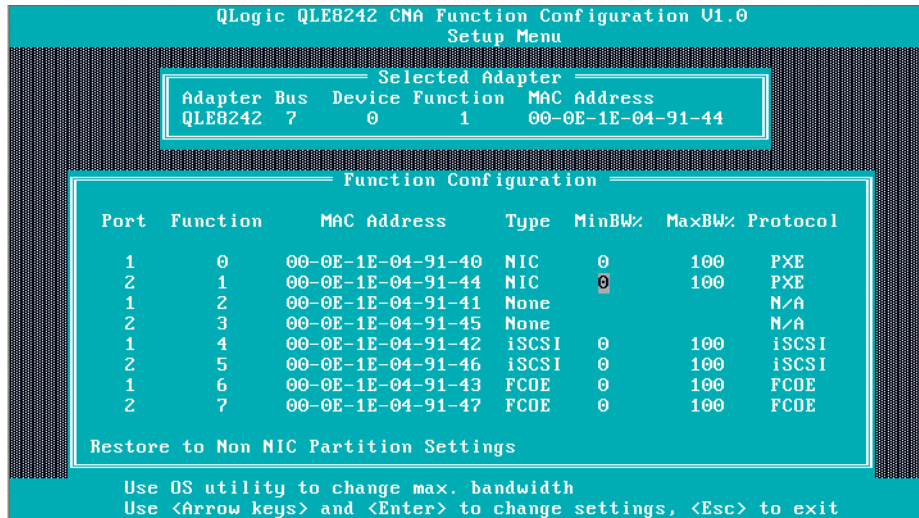

Figure 2-24. Function Configuration Screen

NOTE:

For a list of NPAR configuration options, see “NPAR Setup” on page 2-68.

3. Move your cursor to the **Type** column for any function type you want to change (Figures 2-25 through 2-27).

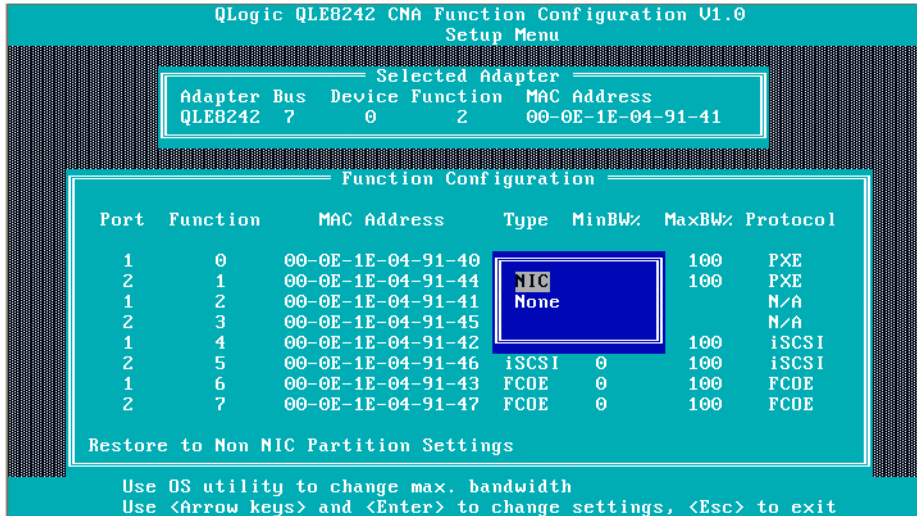

Figure 2-25. Selecting NIC Function Type to Change

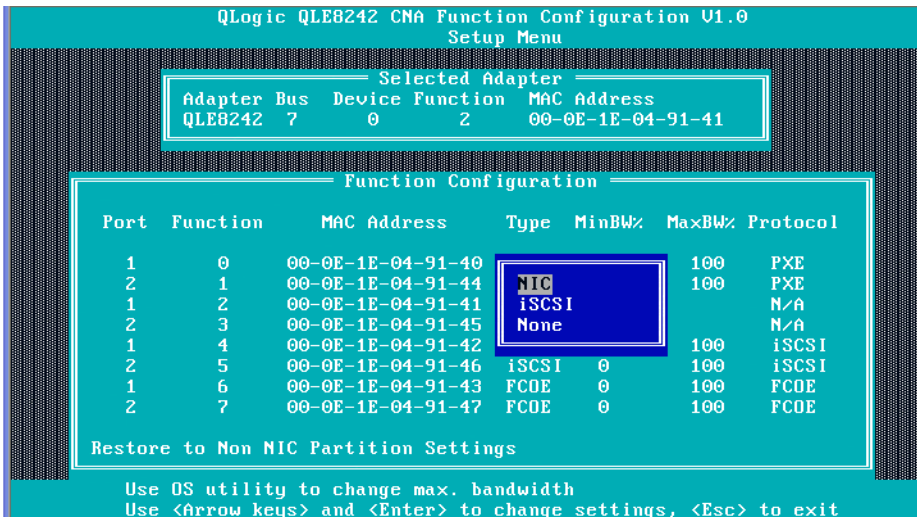

Figure 2-26. Selecting iSCSI Function Type to Change

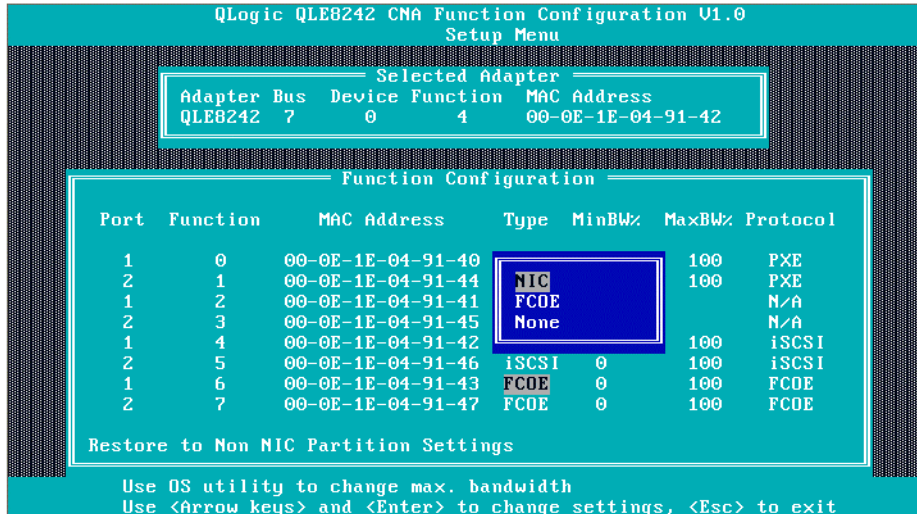

Figure 2-27. Selecting FCoE Function Type to Change

4. Move your cursor to the **MinBW%** column to adjust the minimum bandwidth (Figure 2-28) on each partition (between 0-100%).

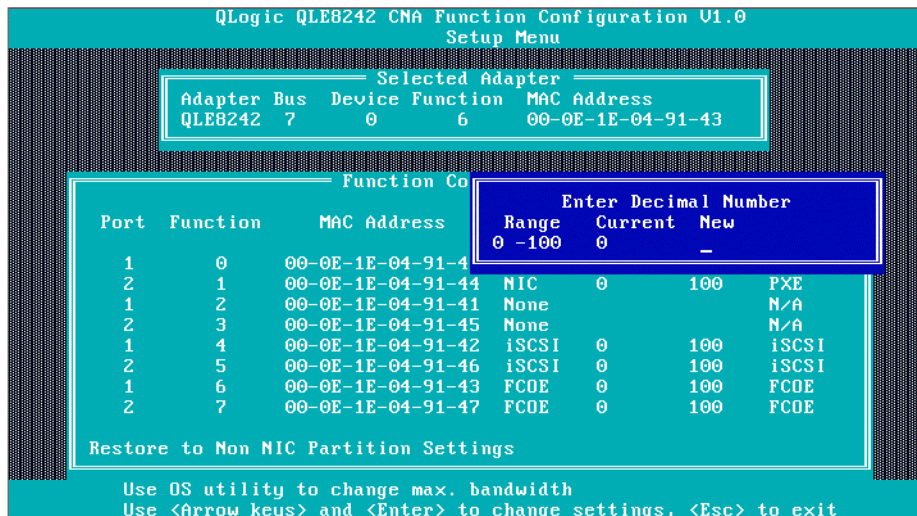

Figure 2-28. Adjusting the Minimum Bandwidth

NOTE:

Do not set any bandwidth percentages for the FCoE function. The adapter uses the enhanced transmission selection (ETS) settings for determining FCoE bandwidth. The NIC bandwidth settings configured in the [Figure 2-28](#) are not a percentage of the line rate (10Gb): they are a percentage of the NIC bandwidth allocated to this NIC port through ETS on the switch.

5. Save your changes ([Figure 2-29](#)).

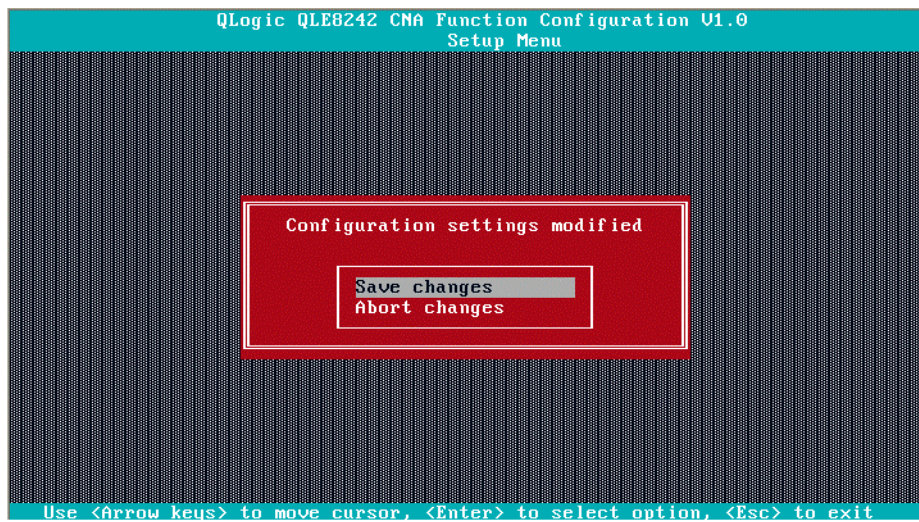

Figure 2-29. Saving Configuration Changes

6. Reboot the host server after completing NPAR configuration.

QConvergeConsole (QCC) GUI

The QConvergeConsole is a web-based client/server application that allows for centralized management and configuration of QLogic adapters within the entire network (LAN and SAN). On the server side, QConvergeConsole runs as an Apache Tomcat Server web application. After the application is launched on the web server, you can connect to QConvergeConsole's GUI through a browser, either locally on the server or remotely from another computer. Your browser window becomes the client used to connect to servers that host the 8200 and 3200 Series Adapters and connected storage devices within the network.

You can use QCC GUI to configure and manage 8200 and 3200 Series Adapters installed on either Linux or Windows host servers.

For procedures on installing and starting this management tool, refer to the *QConvergeConsole User's Guide*. For help configuring and managing the 8200 and 3200 Series Adapters using this management tool, refer to the QConvergeConsole online help system.

To set up NIC partitions using the QCC GUI:

1. [Configure NIC Partitions](#)
2. [Set Up Quality of Service \(QoS\)](#)

Configure NIC Partitions

You can use QCC to configure and manage NPAR functions for both physical ports through the NIC Partitioning tab, available only on Port 1. You can enable or disable NPAR functions on either physical port and must reboot the operating system to apply the changes. When the NPAR function is enabled, each physical port divides its bandwidth function between four physical functions or physical PCIe functions, configured to support one of the following function types: NIC, FCoE, or iSCSI. QCC represents each function type as a *personality*.

For tables that show the default NPAR function settings, as well as the possible configurations, see [“NPAR Setup” on page 2-68](#).

[Table 2-5](#) shows the port identifications and the possible NPAR configurations.

To configure the NIC partitions and change personalities:

1. Expand a 8200 and 3200 Series Adapters node in the QConvergeConsole system tree.
2. Expand the physical Port 1 node and select the NIC port. The content pane displays two additional tabs that are not available on NIC ports for physical Port 2.

3. Select the **NIC Partitioning** tab. The NIC Partitioning Configuration page displays configuration details that apply to the selected NPAR configuration and personality options (Figure 2-30).



Figure 2-30. NIC Partitioning Configuration Page

4. Select the physical port you want to configure from the **Physical Port** drop-down list.
5. If you want to change its function type, select the NIC partition and select the desired protocol from the **Function Type** drop-down list.
6. Click **Save** to save any changes. The Security Check dialog box may appear. In the **Enter Password** box, type the password, and then click **OK**.
7. Reboot the operating system to apply the changes.
8. Verify that the configured ports have the most current drivers installed.
9. If necessary, update the driver for the port protocol.

Set Up Quality of Service (QoS)

QConvergeConsole lets you set quality of service (QoS) for each partition by setting minimum and maximum percentages of the physical port's bandwidth for each partition.

NOTE:

The NIC Partitioning page applies to NIC ports only for NPAR-enabled 8200 and 3200 Series Adapters.

To set the QoS:

1. Expand a 8200 and 3200 Series Adapters node in the QConvergeConsole system tree.
2. Expand the physical Port 1 node and select the NIC port. The content pane displays two additional tabs that are not available on NIC ports for physical Port 2.
3. Select the **NIC Partitioning** tab, and then click the **Management** sub-tab. The NIC Partitioning Management General page displays configuration details that apply to the selected NPAR (Figure 2-31).

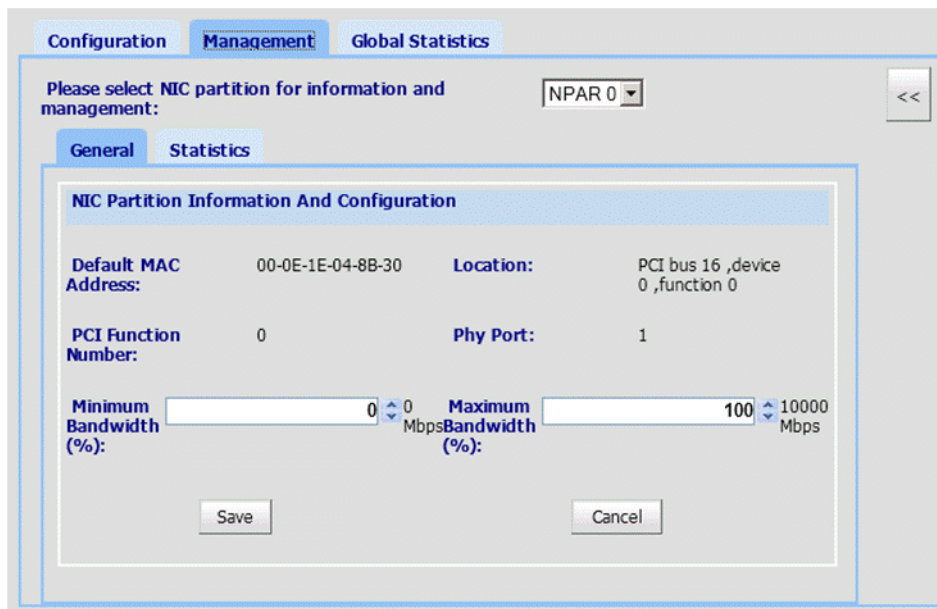

Figure 2-31. NIC Partitioning—General Management Page

4. Click the down arrow and select the NIC partition (**NPAR0**, **NPAR1**, **NPAR2**, or **NPAR3**) from the drop-down list.

Information and configuration fields related to the selected NIC partition include:

- Default MAC Address.** The MAC address set at the manufacturer.
- Location.** The logical location in the system: PCI bus number, device number, and function number.

- ❑ **NPAR PCI Function Number.** The function number (**0, 1, 2, 3, 4, 5, 6,** or **7**) of the eight PCIe function numbers claimed by the adapter.
 - ❑ **NPAR Function Type.** This field correlates to the personality of the selected NPAR (PCIe) function: **NIC, iSCSI,** or **FCoE.**
 - ❑ **Minimum Bandwidth (%) .** Use the UP ARROW and DOWN ARROW keys to scroll between **0%** to **100%** to set the bandwidth you want to guarantee for data sent over the selected partition. Each additional percent increments the bandwidth by 100Mbps. For example, setting the minimum bandwidth to 5 percent guarantees sending and receiving data over the selected port at 500Mbps.
 - ❑ **Maximum Bandwidth (%).** The maximum allowed bandwidth is specified as a percentage of the link speed. Use UP ARROW and DOWN ARROW keys to scroll between **0%** to **100%** to set the maximum bandwidth for data sent over the selected partition. Each additional percent increments the bandwidth by 100Mbps. For example, setting the maximum bandwidth to 100 percent allows for sending and receiving data over the selected partition at up to 10,000Mbps.
5. Repeat the previous step to configure the minimum and maximum bandwidth on the other partitions.
 6. When you are finished making changes, click **Save** to save any changes to the advanced parameters of the adapter. The Security Check dialog box may appear. In the **Enter Password** box, type the password, and then click **OK.**

NOTE:

The settings are persistent across reboots.

QConvergeConsole (QCC) CLI

QConvergeConsole Command Line Interface (CLI) is a management utility that centralizes management and configuration of QLogic adapters within the entire network (LAN and SAN).

You can use the QCC CLI tool in either interactive or non-interactive mode to configure and manage 8200 and 3200 Series Adapters installed on either Linux or Windows host servers.

This section outlines the steps for setting up NIC partitions using QCC CLI in interactive mode. The displayed commands apply to both Linux and Windows operating systems.

For procedures on installing and starting this management tool, refer to the *QConvergeConsole CLI User's Guide*.

To set up NIC partitions using QCC CLI:

1. Start the QCC CLI interface and select option 6: **NIC Partitioning <NPAR> Information** (Figure 2-32).

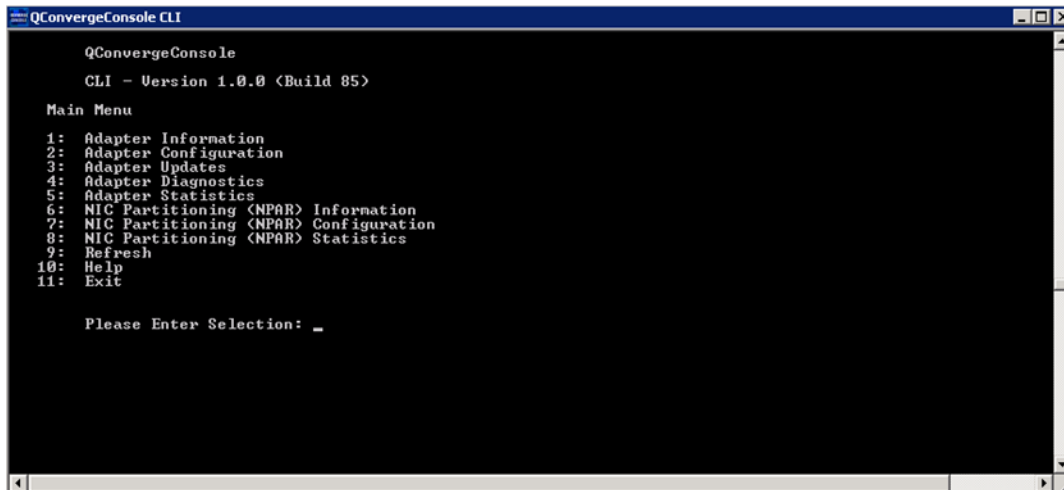

```
QConvergeConsole CLI
QConvergeConsole
CLI - Version 1.0.0 <Build 85>

Main Menu
1: Adapter Information
2: Adapter Configuration
3: Adapter Updates
4: Adapter Diagnostics
5: Adapter Statistics
6: NIC Partitioning <NPAR> Information
7: NIC Partitioning <NPAR> Configuration
8: NIC Partitioning <NPAR> Statistics
9: Refresh
10: Help
11: Exit

Please Enter Selection: _
```

Figure 2-32. Selecting Option 6 to View NPAR Information Options

2. Enter option 2: **NPAR Port Information** (Figure 2-33).

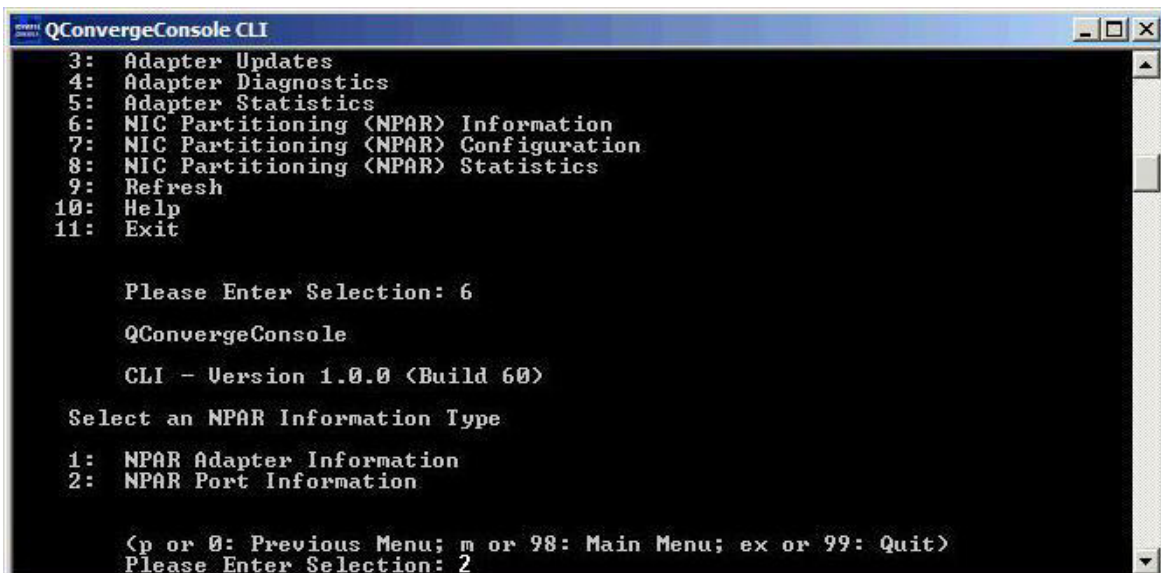

```
QConvergeConsole CLI
3: Adapter Updates
4: Adapter Diagnostics
5: Adapter Statistics
6: NIC Partitioning <NPAR> Information
7: NIC Partitioning <NPAR> Configuration
8: NIC Partitioning <NPAR> Statistics
9: Refresh
10: Help
11: Exit

Please Enter Selection: 6
QConvergeConsole
CLI - Version 1.0.0 <Build 60>

Select an NPAR Information Type
1: NPAR Adapter Information
2: NPAR Port Information

<p or 0: Previous Menu; m or 98: Main Menu; ex or 99: Quit>
Please Enter Selection: 2
```

Figure 2-33. Selecting Option 2 to View NPAR Port Information

The NPAR Configuration Selection Page displays the current configuration (Figure 2-34).

```

QConvergeConsole CLI
CLI - Version 1.0.0 <Build 85>
Select an NPAR Information Type
1: NPAR Adapter Information
2: NPAR Port Information

<p or 0: Previous Menu; m or 98: Main Menu; ex or 99: Quit>
Please Enter Selection: 2

QConvergeConsole
CLI - Version 1.0.0 <Build 85>
Select a port to view NPAR port information
CNA Model QLE8242 SN: AFE1020C03084
1. Port 2
  Function 1 [Type: NIC 1] MAC Address: 00:0E:1E:04:8B:341 Link Up
  Function 3 [Type: NIC 1] MAC Address: 00:0E:1E:04:8B:351 Link Up
  Function 5 [Type: NIC 1] MAC Address: 00:0E:1E:04:8B:361 Link Up
  Function 7 [Type: NIC 1] MAC Address: 00:0E:1E:04:8B:371 Link Up
2. Port 1
  Function 0 [Type: NIC 1] MAC Address: 00:0E:1E:04:8B:301 Link Down
  Function 2 [Type: NIC 1] MAC Address: 00:0E:1E:04:8B:311 Link Down

<p or 0: Previous Menu; m or 98: Main Menu; ex or 99: Quit>
Please Enter Selection:
  
```

Figure 2-34. NPAR Configuration Selection Screen

- Return to the main menu after viewing the NPAR information and select option 7: NIC Partitioning <NPAR> Configuration (Figure 2-35).

```

QConvergeConsole CLI
2: Adapter Configuration
3: Adapter Updates
4: Adapter Diagnostics
5: Adapter Statistics
6: NIC Partitioning <NPAR> Information
7: NIC Partitioning <NPAR> Configuration
8: NIC Partitioning <NPAR> Statistics
9: Refresh
10: Help
11: Exit

Please Enter Selection: 7

QConvergeConsole
CLI - Version 1.0.0 <Build 60>
NIC Partitioning <NPAR> Configuration Selection
1: NPAR Configuration

<p or 0: Previous Menu; m or 98: Main Menu; ex or 99: Quit>
Please Enter Selection:
  
```

Figure 2-35. Selecting NPAR Configuration

4. Select option 1: **NPAR Configuration** to display the NPAR Configuration menu, which provides the following options:
 - 1: Bandwidth Configuration
 - 2: Change PCI Function Personality
5. Configure the bandwidth settings to meet your system requirements. For example, to change the bandwidth of the function 1 NIC partition:
 - a. Select option 1: **Bandwidth Configuration**.
 - b. Select option 1: **Function:1**.
 - c. Select option 1: **Modify Minimum Bandwidth** (Figure 2-36).

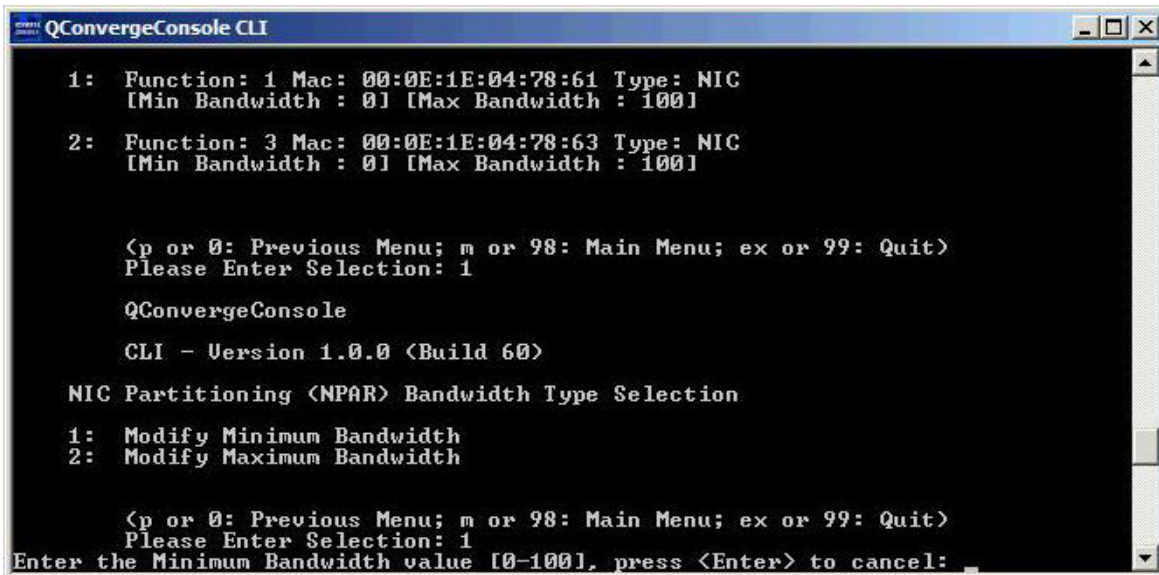

```
QConvergeConsole CLI
1: Function: 1 Mac: 00:0E:1E:04:78:61 Type: NIC
  [Min Bandwidth : 0] [Max Bandwidth : 100]
2: Function: 3 Mac: 00:0E:1E:04:78:63 Type: NIC
  [Min Bandwidth : 0] [Max Bandwidth : 100]

<p or 0: Previous Menu; m or 98: Main Menu; ex or 99: Quit>
Please Enter Selection: 1

QConvergeConsole
CLI - Version 1.0.0 <Build 60>

NIC Partitioning <NPAR> Bandwidth Type Selection
1: Modify Minimum Bandwidth
2: Modify Maximum Bandwidth

<p or 0: Previous Menu; m or 98: Main Menu; ex or 99: Quit>
Please Enter Selection: 1
Enter the Minimum Bandwidth value [0-100], press <Enter> to cancel: _
```

Figure 2-36. Selecting to Modify Minimum Bandwidth

- d. At the prompt, enter the percent value of bandwidth you want committed to the selected function.
- e. Enter the percent value of bandwidth you want to limit the selected function to.

- f. Specify whether you want the bandwidth settings to persist across reboots (Figure 2-37).

```

QConvergeConsole CLI

NIC Partitioning <NPAR> Bandwidth Type Selection

1: Modify Minimum Bandwidth
2: Modify Maximum Bandwidth

<p or 0: Previous Menu; m or 98: Main Menu; ex or 99: Quit>
Please Enter Selection: 1
Enter the Minimum Bandwidth value [0-100], press <Enter> to cancel:

QConvergeConsole
CLI - Version 1.0.0 <Build 60>

NIC Partitioning <NPAR> Bandwidth Type Selection

1: Modify Minimum Bandwidth
2: Modify Maximum Bandwidth

<p or 0: Previous Menu; m or 98: Main Menu; ex or 99: Quit>
Please Enter Selection: 2
Enter the Maximum Bandwidth value [0-100], press <Enter> to cancel: 90
Do you want to persist the bandwidth settings across reboots? <y/n>: y
  
```

Figure 2-37. Setting Bandwidth Changes to Persist

6. Return to the NIC Partitioning <NPAR> Configuration Selection screen.
7. Change the personalities of each function to meet your system requirements. For example:
 - a. Select option 2: **Change PCI Function Personality**.
 - b. Select the port number, 1 or 2.
 - c. Select the function number. The command line displays a list of options with choices that apply to the selected function number. This mode prevents you from assigning a function type that does not apply to a given function number.
 - d. Set the personality type by selecting the option number that identifies the desired function type. Depending on the function number and current state, this could be **Disabled**, **NIC**, **FCoE**, or **iSCSI**.

NOTE:

For a list of NPAR configuration options, see [“NPAR Setup” on page 2-68](#).

Figure 2-38 shows the CLI commands leading to the option for changing a function type on a Linux system.

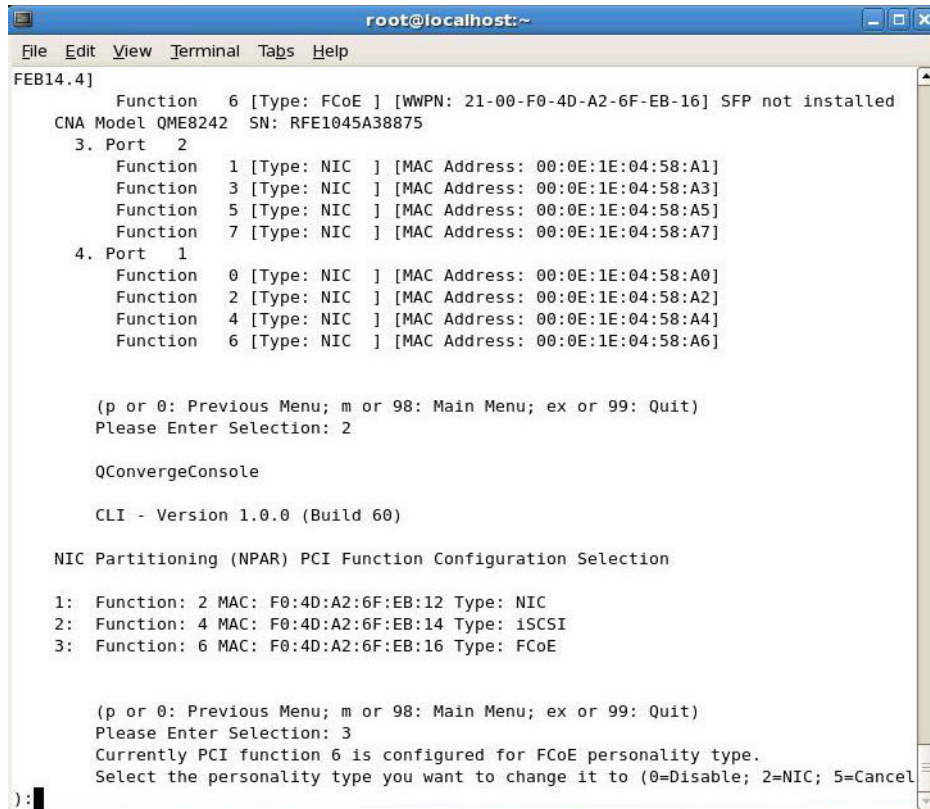

```
root@localhost:~  
File Edit View Terminal Tabs Help  
FEB14.4]  
Function 6 [Type: FCoE ] [WWPN: 21-00-F0-4D-A2-6F-EB-16] SFP not installed  
CNA Model QME8242 SN: RFE1045A38875  
3. Port 2  
Function 1 [Type: NIC ] [MAC Address: 00:0E:1E:04:58:A1]  
Function 3 [Type: NIC ] [MAC Address: 00:0E:1E:04:58:A3]  
Function 5 [Type: NIC ] [MAC Address: 00:0E:1E:04:58:A5]  
Function 7 [Type: NIC ] [MAC Address: 00:0E:1E:04:58:A7]  
4. Port 1  
Function 0 [Type: NIC ] [MAC Address: 00:0E:1E:04:58:A0]  
Function 2 [Type: NIC ] [MAC Address: 00:0E:1E:04:58:A2]  
Function 4 [Type: NIC ] [MAC Address: 00:0E:1E:04:58:A4]  
Function 6 [Type: NIC ] [MAC Address: 00:0E:1E:04:58:A6]  
  
(p or 0: Previous Menu; m or 98: Main Menu; ex or 99: Quit)  
Please Enter Selection: 2  
  
QConvergeConsole  
  
CLI - Version 1.0.0 (Build 60)  
  
NIC Partitioning (NPAR) PCI Function Configuration Selection  
  
1: Function: 2 MAC: F0:4D:A2:6F:EB:12 Type: NIC  
2: Function: 4 MAC: F0:4D:A2:6F:EB:14 Type: iSCSI  
3: Function: 6 MAC: F0:4D:A2:6F:EB:16 Type: FCoE  
  
(p or 0: Previous Menu; m or 98: Main Menu; ex or 99: Quit)  
Please Enter Selection: 3  
Currently PCI function 6 is configured for FCoE personality type.  
Select the personality type you want to change it to (0=Disable; 2=NIC; 5=Cancel  
):
```

Figure 2-38. Selecting Function Type on Linux System

8. Return to the main menu and select option 8: **NIC Partitioning <NPAR> statistics** to view the Statistics. Navigate through the menu selections to view eSwitch statistics.
9. After you have finished setting the NIC partitions as desired, reboot the host server for the changes to take effect.

QLogic Device Windows Properties Page

On a Windows Server that hosts 8200 and 3200 Series Adapters, you can use the QLogic Device Windows Properties Page to set up NIC partitions (NPAR). You can also use it to view eSwitch statistics.

To set up NPAR using the QLogic Device Windows Properties Page:

1. [Configure NPAR](#)
2. [Change Personalities](#)
3. [Manage Bandwidth](#)
4. [View eSwitch Statistics](#)

Configure NPAR

You can use the **NIC Partition Management** tab in the device properties page to enable NPAR and configure the 10GbE physical port into a multi-function storage and networking port.

To set up NPAR on an 8200 and 3200 Series Adapters' port:

1. Log in to the server that contains installed 8200 and 3200 Series Adapters.
2. Open the Server Manager and select **Diagnostics > Device Manager > Network Adapters**.
3. Right-click the first **QLogic 10 Gigabit Ethernet CNA** device and select **Properties** from the context menu (Figure 2-39).

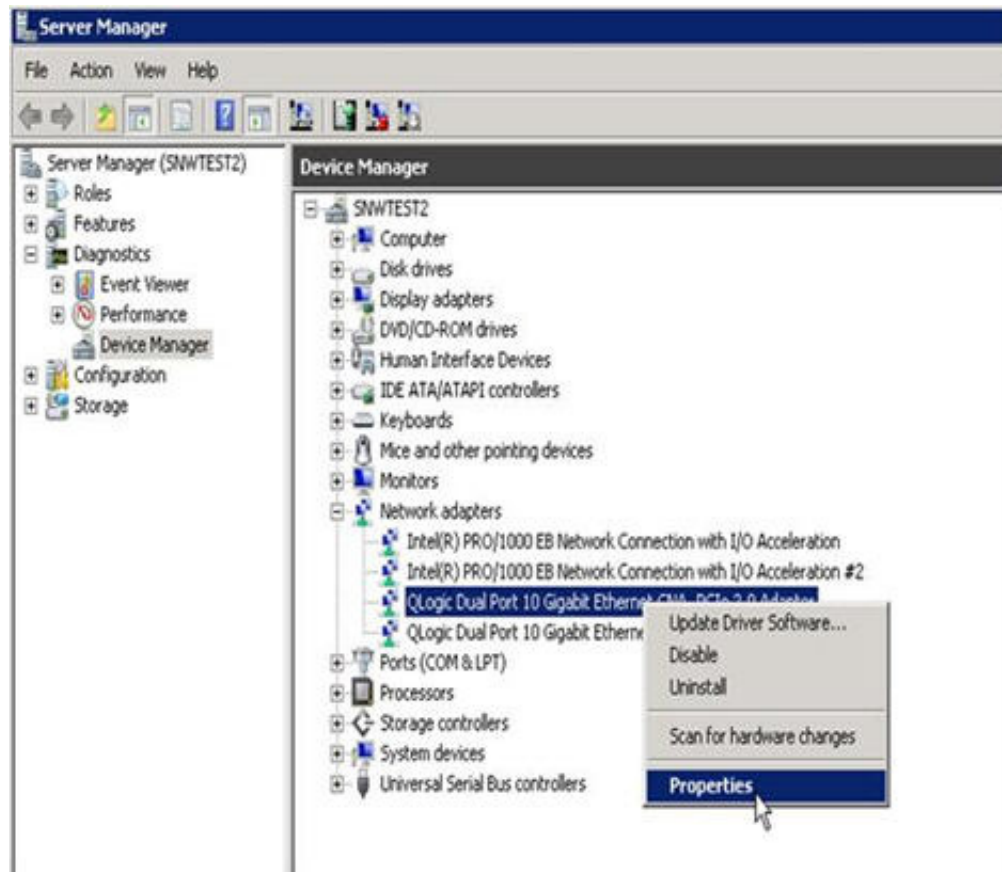

Figure 2-39. Selecting Properties from the Context Menu

4. From the Adapter Properties page, do the following:
 - a. Select the **NIC Partition Management** tab.
 - b. Right-click the function number you want to enable.

- c. Select **Enable Partition** (Figure 2-40).

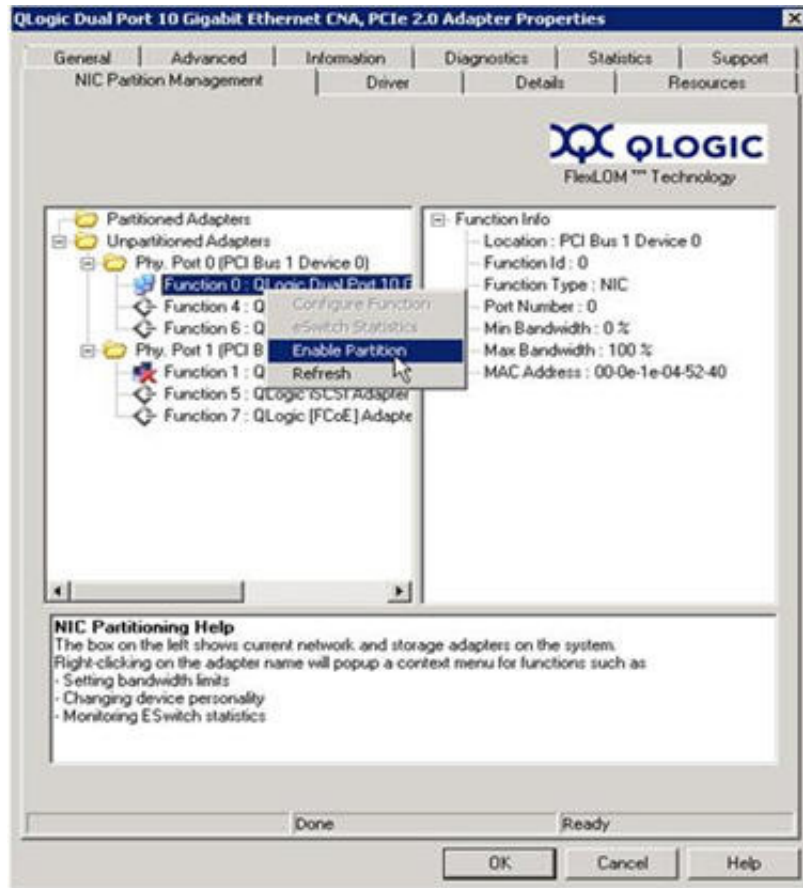

Figure 2-40. Enabling Partition

When partitioning is enabled, the Adapter Properties page appears as shown in [Figure 2-41](#).

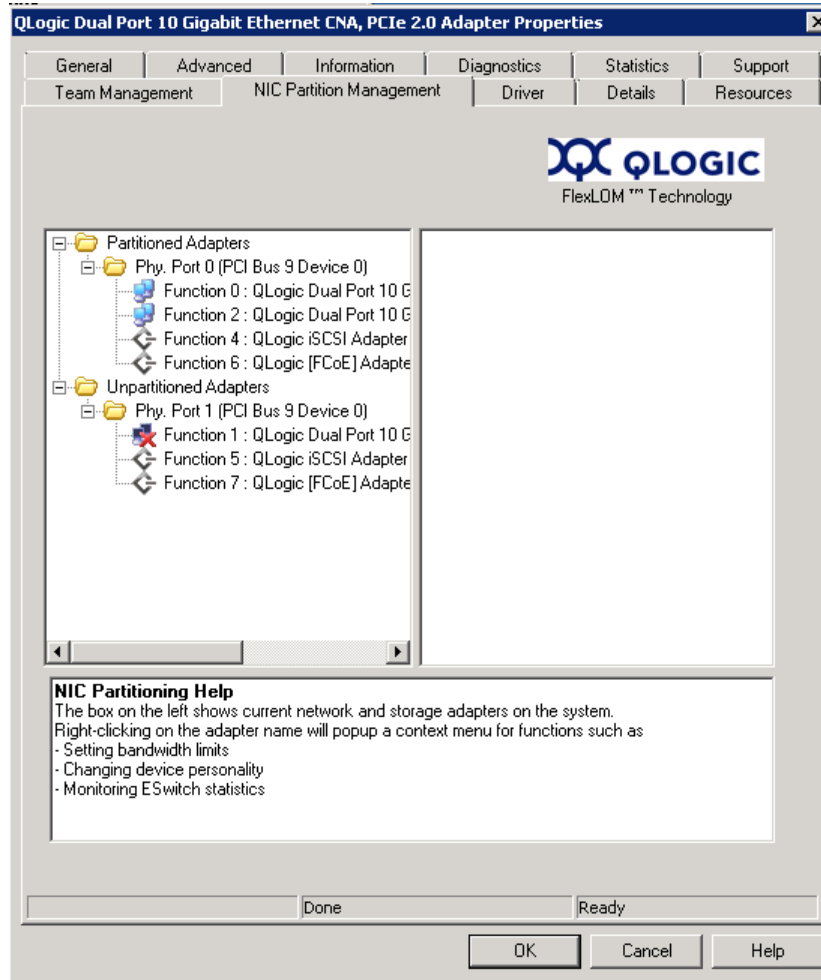

Figure 2-41. Partition Enabled

5. Click **OK** to close the message box that displays the following information:
This change requires a reboot. Proceed?
6. Click **OK** to close the message box that displays the following information:
Please reboot the system now
7. Reboot the host server to make the changes take effect.

Change Personalities

To change function types (*personalities*) as needed for your network:

1. From the Server Manager, select **Diagnostics > Device Manager > Network Adapters**.
2. Right-click the desired **QLogic 10 Gigabit Ethernet CNA** device to change the function type and select **Properties** from the context menu.
3. On the **NIC Partition Management** tab, right-click one of the enabled functions and select **Convert to <Protocol>** from the context menu (Figure 2-42).

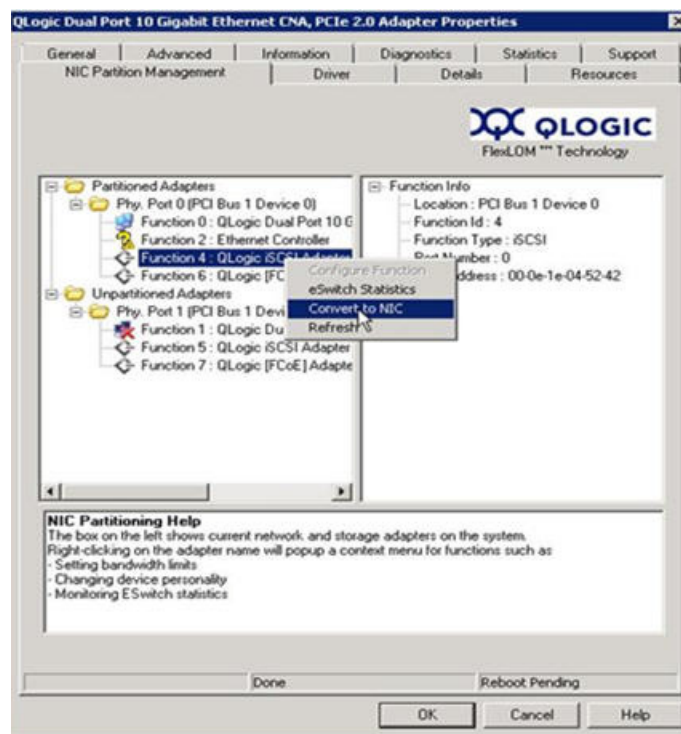

Figure 2-42. Selecting Convert to NIC from Context Menu

4. Repeat these procedures to change the function types as desired.

Manage Bandwidth

Using the **NIC Partition Management** tab in the Windows device properties page, you can allocate minimum and maximum bandwidth for each NIC function.

1. From the 8200 and 3200 Series Adapters Adapter Properties page, select the **NIC Partition Management** tab.
2. Right-click the function number for the port you want to configure and select **Configure Function** from the context menu (Figure 2-43).

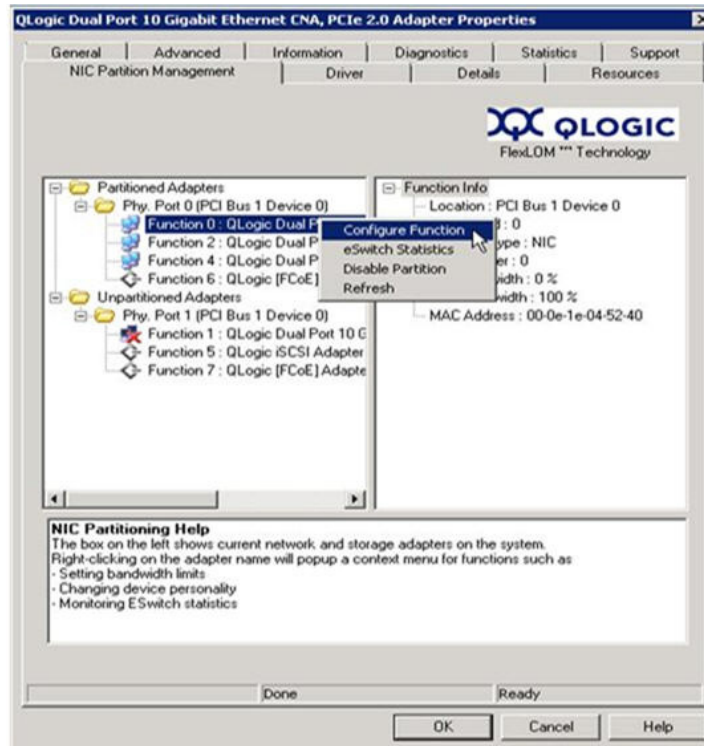

Figure 2-43. Selecting Configure Function for Function 0

3. Use the Configure Function dialog box to set the minimum and maximum bandwidth percentages, **New Minimum BW (%)** and **New Maximum BW (%)** (Figure 2-44).

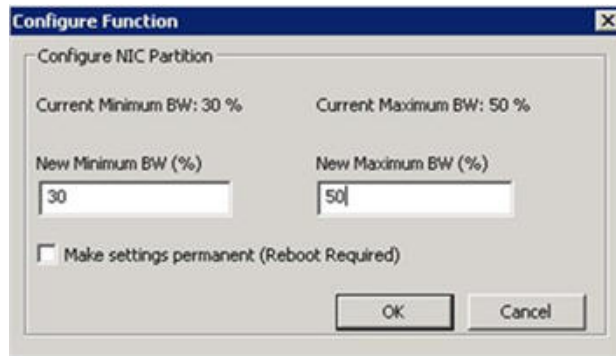

Figure 2-44. Entering New Bandwidth Values

NOTE:

Enhanced transmission service (ETS) only specifies the division of bandwidth between FCoE and non-FCoE traffic. It does not specify the bandwidth allocated to the NIC or iSCSI partitions. When the switch sets ETS values, the ETS bandwidth parameters take precedence. The FCoE partition is allocated the bandwidth specified for FCoE in the ETS parameters. The non-FCoE bandwidth is divided between the NIC and iSCSI partitions in the proportion specified by the NPAR management UI. In other words, when ETS is in effect, the NIC and iSCSI bandwidth values specified by the NPAR management UI are no longer a percentage of the total bandwidth. Instead, they are a percentage of the non-FCoE bandwidth.

4. If desired, select the **Make settings permanent** check box to retain the new settings.

NOTE:

If you do not select this option, the bandwidth values will revert to the default settings after you reboot the host server.

5. Click **OK** to save your changes.

The new bandwidth values appear in the right pane of the NIC Partition Management property sheet (Figure 2-45).

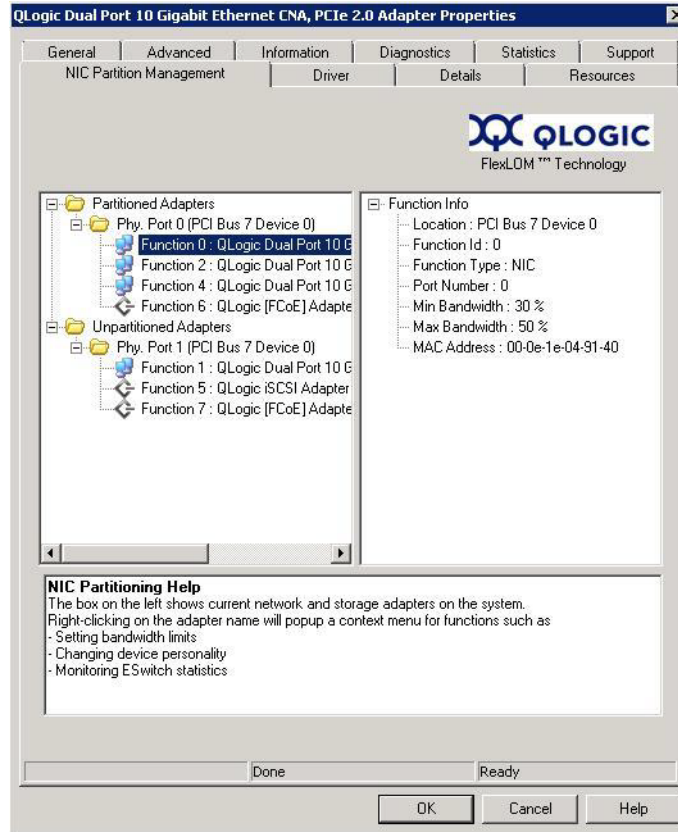

Figure 2-45. NIC Partition Management Property Sheet

6. Click **OK** at the bottom of the Properties page to close it.

View eSwitch Statistics

You can use the Window Device Manager's NIC Partition Management window to view eSwitch statistics for enabled partitions.

To display eSwitch statistics:

1. From the 8200 and 3200 Series Adapters Adapter Properties page, select the **NIC Partition Management** tab.
2. Right-click the function number for the port you want to review and select **eSwitch Statistics** from the context menu.

A window opens that displays the statistics (Figure 2-46).

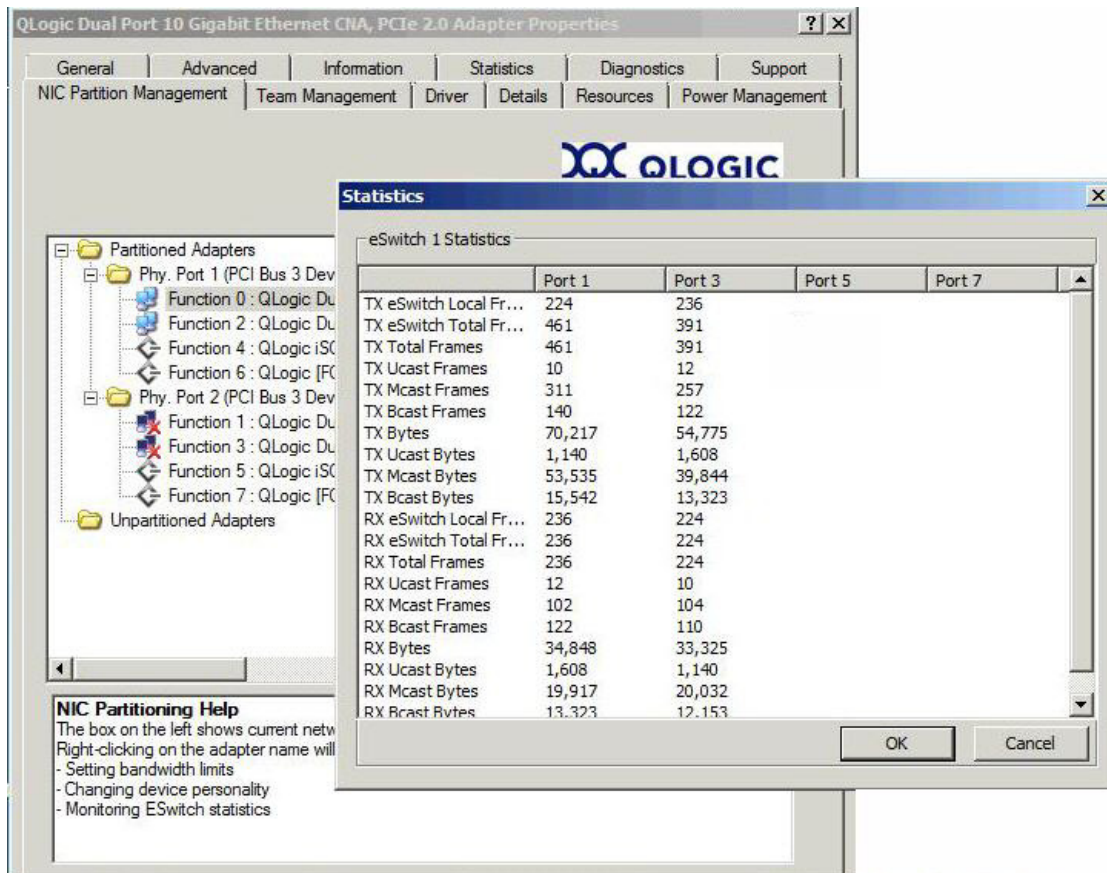

Figure 2-46. eSwitch Statistics for Function 0

3. After reviewing the statistics, click **OK** or **Cancel** to close the pop-up window.

NPAR Setup

This section provides NPAR reference tables you can use when configuring NIC partitions using the various tools available.

Default Settings

Before configuring NIC partitions, the 8200 and 3200 Series Adapters appear as a simple dual-port 10GbE adapter with the NPAR settings shown in [Table 2-6](#).

Table 2-6. Default Configuration

Function Number	Function Type	Physical Port Number	Minimum Bandwidth (%)	Maximum Bandwidth (%)	Default Function Type
0	NIC	0	0	100	Enabled as NIC
1	NIC	1	0	100	Enabled as NIC

Configuration Options

Depending on your system requirements and operating environment, you may set up the 8200 and 3200 Series Adapters' port partitions to support different function types. [Table 2-7](#) shows the available function types and configurable parameters.

Table 2-7. Configuration Options

Function Number	Function Type	Physical Port Number	Minimum Bandwidth ^a (%)	Maximum Bandwidth ^b (%)	Default Function Type
0	NIC	0	0	100	NIC
1	NIC	1	0	100	NIC
2	Disabled/NIC	0	0	100	NIC
3	Disabled/NIC	1	0	100	NIC
4	iSCSI/NIC/Disabled	0	0	100	iSCSI
5	iSCSI/NIC/Disabled	1	0	100	iSCSI
6	FCoE/NIC/Disabled	0	0	100	FCoE
7	FCoE/NIC/Disabled	1	0	100	FCoE

^a Minimum Bandwidth: Minimum guaranteed bandwidth, specified as a percentage of the link speed. The total across all partitions will add up to less than the maximum link bandwidth. The queue's rate will be allowed to exceed the specified value up to max-rate, if excess bandwidth is available on the physical port link.

^b Maximum bandwidth: Maximum allowed bandwidth, specified as a percentage of the link speed. The queue's rate will not be allowed to exceed the specified value, even if excess bandwidth is available on the physical port link. The total across all partitions may not be greater than the maximum link bandwidth.

NPAR Configuration Parameters and Setup Tools

Table 2-8 identifies which parameters you can configure using each of the available management tools.

Table 2-8. NPAR Configuration Parameters and Setup Tools

Tools/Configurable NPAR Parameters	Function Type ^a	Minimum Bandwidth ^b (range 0-100%)	Maximum Bandwidth ^b (range 0-100%)
QLogic NIC OptionROM (Press CTRL+Q during POST)	Yes	Yes, configurable	Not configurable, read-only
QLogic QConvergeConsole GUI/CLI for supported Windows and Linux operating systems	Yes	Yes, configurable but only for NIC partitions, not for storage (iSCSI/FCoE) partitions	Yes, configurable but only for NIC partitions, not for storage (iSCSI/FCoE) partitions
QLogic Windows Device Manager—NIC Property Page	Yes	Yes, configurable but only for NIC partitions, not for storage (iSCSI/FCoE) partitions	Yes, configurable but only for NIC partitions, not for storage (iSCSI/FCoE) partitions

^a These changes require a system reboot to take effect. Refer to Table 2-7 for the available function type options of each partition.

^b For FCoE, DCBX/ETS negotiated bandwidth will overwrite manually configured bandwidth.

Table 2-9. NPAR Wake-on-LAN (WOL) and PXE Boot Support

NPAR Partition	WOL	PXE Boot
Function 0	Yes	Yes
Function 1	Yes	Yes
Function 2	No	No
Function 3	No	No
Function 4	No	No
Function 5	No	No
Function 6	No	No
Function 7	No	No

Frequently Asked Questions about NPAR

NIC Partitioning

Q: What is NIC Partitioning (NPAR)?

NIC Partitioning (NPAR) is a method of dividing each QLogic Adapter Ethernet port into a maximum of four partitions or virtual ports (eight virtual ports per adapter). These virtual ports can be assigned NIC, FCoE, or iSCSI personalities, and users can apply QoS settings by flexibly allocating minimum guaranteed bandwidth to each virtual port.

Q: How is NPAR different from SR-IOV?

Single root I/O virtualization (SR-IOV) is an industry-developed specification that identifies how a single PCI device can be partitioned and shared natively with multiple OSs on the same physical host. NPAR is similar to SR-IOV in that both allow partitioning a physical port into multiple partitions. With NPAR, the physical port is partitioned into multiple physical PCIe functions. However, in the case of SR-IOV, the physical port is partitioned into multiple virtual PCIe functions. This difference in partitioning allows NPAR to be deployed in both bare metal (non-virtualized) OSs and virtualized OSs. In contrast, SR-IOV is primarily targeted towards virtualized platforms.

To deploy SR-IOV today, you will need to ensure a minimum level of infrastructure (server hardware and OS) support for SR-IOV. Whereas NPAR is available today with the 8200 and 3200 Series Adapters and supported with all major OSs, including Windows and Linux, without any specific minimum server hardware or OS support requirements, SR-IOV is not currently supported on Windows.

Q: How does NPAR allow me to use fewer adapters?

With NPAR, users can create up to eight virtual ports per QLogic Adapter. Each virtual port can be a NIC, FCoE, or iSCSI port with minimum guaranteed bandwidth. This means a single adapter can now replace multiple 1GbE NICs, Fibre Channel Host Bus Adapters, and iSCSI Host Bus Adapters.

Q: How many MAC addresses are supported by my adapter?

Eight MAC addresses are supported in total—one for each physical function.

Q: What does “switch-agnostic” mean? What are the benefits?

Switch-agnostic means that the NPAR feature works when the 8200 and 3200 Series Adapters are connected to a 10GbE switch. This implementation gives you broad interoperability in your environment and more freedom when choosing your 10GbE switch.

Q: What’s the difference between a physical function and a virtual function?

Physical functions are full-featured PCIe functions that operate like normal PCI physical devices in terms of discovery, configuration, and management. Virtual functions are “lightweight” (minimized functionality support) PCIe functions that are derived from the physical PCIe functions.

Q: Is NPAR included when I purchase my adapter?

Yes. Full NPAR functionality comes with your purchase. There are no additional licensing fees incurred.

Q: What protocols are supported with NPAR?

The function types supported on the virtual ports are TCP/IP (NIC), iSCSI, and FCoE.

Q: How is the QoS set? How does the bandwidth allocation work? What tools are used to set bandwidth?

The QoS parameter setting is supported from a minimum bandwidth of 100Mbps to 10Gbps. The settings can be allocated in blocks of 100Mbps increments (as a percentage of the total bandwidth).

There are three tools that users can employ to configure NPAR functionality:

- Pre-boot utility
- QLogic’s QConvergeConsole management tool (GUI and CLI)
- Microsoft Windows® properties pages

Q: Is one virtual port’s unused bandwidth available for use by other active virtual ports?

Yes. The minimum settings are bandwidth guarantees, specified as a percentage of the link speed. If one or more virtual ports are not consuming their full allotment, that bandwidth can be temporarily consumed by other virtual ports if they need more than their guaranteed allotment.

Q: What OSs are supported with NPAR?

Currently, the following OS support is available: Microsoft Windows Server™ 2003 R2/SP2, 2008/2008 SP2/2008 R2; Red Hat Linux® 5.5, 6.0; Novell® SLES 10 SP3, SLES 11 SP1. For the latest list of supported operating systems, please check the QLogic Web site.

Networking

Q: Why use teaming?

Teaming allows for high link availability (fault tolerance). If one of the underlying physical NICs is broken or its cable has been unplugged, the OS will detect the fault condition and automatically move traffic to another NIC in the bond. This capability eliminates a single point of failure for any one physical NIC and makes the overall network connection fault tolerant.

In addition, teaming helps with load balancing. Outgoing traffic is automatically load balanced based on the destination address between the available physical NICs. Load balancing of incoming traffic can be achieved with a suitable network switch.

Q: What advantages does teaming provide?

Teaming can improve availability and capacity.

Q: How does teaming work?

Users create, modify, and delete teams (or bonds) using tools that are available from their OSs. Creating a team involves picking which available physical ports belong to the team, and then choosing which type of team to create. The type of teams that are available depends on the OS that is deployed.

Q: What are its limitations?

Switch-dependent teaming is not currently supported whenever iSCSI or FCoE is enabled on the partition.

Q: Is WoL supported?

No, WoL is not supported on the 8200 and 3200 Series Adapters.

NIC Troubleshooting/Diagnostics

NIC Linux Diagnostics

Linux Diagnostics

This section covers the following information for user diagnostics for Linux NIC driver management applications:

- [“Running Linux User Diagnostics” on page 2-74](#)
- [“Linux Diagnostic Test Descriptions” on page 2-75](#)
- [“Linux Diagnostic Test Messages” on page 2-76](#)

Running Linux User Diagnostics

Linux user diagnostics include QConvergeConsole diagnostics and ethtool diagnostics.

QConvergeConsole Diagnostics

NOTE:

Information on installing and starting the GUI version of QLogic's QConvergeConsole utility is provided in the *QConvergeConsole User's Guide*. All procedural information for that utility is covered in the *QConvergeConsole Help System*.

QConvergeConsole CLI-based diagnostics include the following commands:

- To enable or disable the port beacon, issue the following command:

```
qaucli -pr nic -beacon [cna_port_inst] <on|off>
```

- To run an internal loopback test, issue the following command:

```
qaucli -pr nic -intloopback <cna_port_inst> <tests_num>  
<on_error>
```

where `tests_num` is the number of tests (1–65535) and `on_error` is either 0=Ignore or 1=Abort

- To perform a Flash test, issue the following command:

```
qaucli -pr nic testflash [cna_port_inst]
```

- To perform a hardware test, issue the following command:

```
qaucli -pr nic -testhw [cna_port_inst]
```

- To perform an interrupt test, issue the following command:

```
qaucli -pr nic -testinterrupt [cna_port_inst]
```

- To perform a link test, issue the following command:

```
qaucli -pr nic -testlink [cna_port_inst]
```

- To perform a register test, issue the following command:

```
qaucli -pr nic -testregister [cna_port_inst]
```

- To display transceiver DMI data, issue the following command:

```
gauccli -pr nic -trans [cna_port_inst]
```

Ethtool Diagnostics

To perform an adapter self-test using ethtool-based diagnostics, issue the following command:

```
# ethtool -t eth<x> offline
```

The self-test includes the following:

- Loopback test
- Interrupt test
- Link test
- Register test

Examples

```
# ethtool -t eth8 offline
```

```
The test result is PASS
```

```
The test extra info:
```

```
Register_Test_on_offline      0
Link_Test_on_offline          0
Interrupt_Test_offline        0
Loopback_Test_offline         0
```

```
# ethtool -t eth4
```

```
The test result is PASS
```

```
The test extra info:
```

```
Register_Test_on_offline      0
Link_Test_on_offline          0
Interrupt_Test_offline        0
Loopback_Test_offline         0
```

Linux Diagnostic Test Descriptions

- **Internal Loopback Test** performs internal packet loopback.
- **Flash Test** verifies the Flash read and write.
- **Hardware Test** verifies that the hardware is running.
- **Interrupt Test** enables and disables the interrupt and functional verification tests.

- **Link Test** verifies that the port is linked, meaning that the port has a good cable attached to the port and that other end of the cable is connected to an operational Ethernet port, either another NIC port or a network device, such as a switch.
- **Register Test** verifies the NIC register read and write.

Linux Diagnostic Test Messages

Test information and PASS or FAIL messages are displayed for each of the tests listed in [“Linux Diagnostic Test Descriptions” on page 2-75](#).

QLogic Device Windows Property Page Diagnostics

This section covers the following information for user diagnostics for Windows NIC driver management applications:

- [“Running Windows User Diagnostics” on page 2-76](#)
- [“Windows Diagnostic Test Descriptions” on page 2-81](#)
- [“Windows Diagnostic Test Messages” on page 2-83](#)

Running Windows User Diagnostics

You can run user diagnostics using either the QConvergeConsole GUI or the CLI.

NOTE:

Information on installing and starting the GUI version of QLogic's QConvergeConsole utility is provided in the *QConvergeConsole User's Guide*. All procedural information for that utility is covered in the *QConvergeConsole Help System*.

To run user diagnostics in the GUI:

1. Access the Windows **Control Panel**, and then open the **Device Manager**.
2. In the Device Manager, right-click the **QLogic 10Gb Ethernet adapter**, and then on the shortcut menu, click **Properties**.

3. On the adapter properties page, click the **Diagnostics** tab. [Figure 2-47](#) shows the **Diagnostics** page.

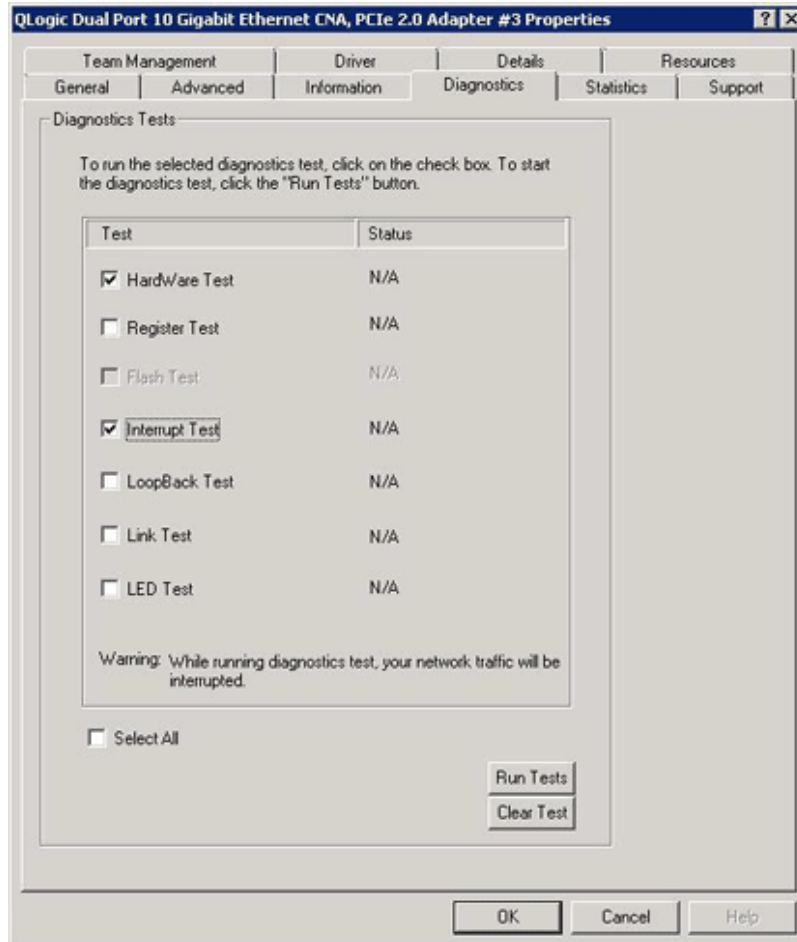

Figure 2-47. Diagnostics Tests on Windows

4. Under **Diagnostic Tests**, select one or more check boxes indicating the tests you want to run: **Hardware Test**, **Register Test**, **Interrupt Test**, **Loopback Test**, and **Link Test**. (“[Windows Diagnostic Test Descriptions](#)” on [page 2-81](#) describes each test type.)
5. Click **Run Tests**.

NOTE:

Only one test can run at a time. Multiple tests can run sequentially.

To run user diagnostics in the CLI:

Use QConvergeConsole CLI (`qaucli`), a unified command line utility, to manage all QLogic adapter models, including running user diagnostics. The overall option (`-pr <protocol>`) allows you to start the utility with a specific protocol type: NIC, iSCSI, or Fibre Channel. If you do not specify a protocol, all protocols are enabled by default. [Table 2-10](#) and [Table 2-11](#) list the QConvergeConsole commands for selecting a protocol.

Table 2-10. Windows QConvergeConsole CLI—Selecting a Protocol in Menu Mode

Command	Description
<code>qaucli</code>	Start QConvergeConsole CLI in interactive mode
<code>qaucli -pr nic [options]</code>	Issue NIC command line options
<code>qaucli -pr iscsi [options]</code>	Issue iSCSI command line options
<code>qaucli -pr fc [options]</code>	Issue Fibre Channel and FCoE command line options
<code>qaucli -npar [options]</code>	Issue NPAR command line options

Table 2-11. Windows QConvergeConsole CLI—Selecting a Protocol in Legacy Mode

Command	Description
<code>qaucli -nic [options]</code>	Use NIC legacy command line
<code>netscli [options]</code>	Use NIC legacy command line
<code>qaucli iscsi [options]</code>	Use iSCSI legacy command line
<code>iscli [options]</code>	Use iSCSI legacy command line
<code>qaucli -fc [options]</code>	Use Fibre Channel legacy command line
<code>scli [options]</code>	Use Fibre Channel legacy command line

Diagnostic help commands, and command options available for each specific protocol, are available by specifying -h to the protocol, as shown in [Table 2-12](#).

Table 2-12. Windows QConvergeConsole CLI—Getting Help

Command	Description
-h	Print usage of a specific adapter type, and then exit
qaucli -pr nic -h	Print NIC protocol usage, and then exit
qaucli -pr fc -h	Print Fibre Channel and FCoE protocol usage, and then exit
qaucli -pr iscsi -h	Print iSCSI protocol usage, and then exit
qaucli -npar -h	Print NPAR commands usage, and then exit

[Table 2-13](#) lists miscellaneous Windows diagnostics commands.

Table 2-13. Windows QConvergeConsole CLI—Miscellaneous Commands

Command	Description
qaucli -v	Print version number, and then exit
qaucli -h	Print usage, and then exit

[Table 2-14](#) lists the Windows CLI diagnostic test commands. Note that while running these tests, network traffic is interrupted.

Table 2-14. Windows QConvergeConsole CLI—Diagnostic Test Commands

Command	Description
-i --interface	Specifies the interface type (NX_NIC, NX_NIC1, and so on)
-a --all	Perform all tests, regardless of default
-D --default	Perform only the default test
-R --CRegs	Test all control registers (default)

Table 2-14. Windows QConvergeConsole CLI—Diagnostic Test Commands (Continued)

Command	Description
-I --IRQS	Test interrupt mechanism (default)
-L --IntLB	Internal loopback test (default)
-H --Hw	Hardware test (default)
-S --LinkST	Link status test (default)
-nR --noCRegs	No control registers test (combine -D or -a)
-nI --noIRQS	No interrupt test (combine -D or -a)
-nL --noIntLP	No internal loopback test (combine -D or -a)
-nH --noHw	No hardware test (combine -D or -a)
-nS --noLinkSt	No link status test (combine -D or -a)
-h --help	View help text

For every test performed, the diagnostic utility shows the following data:

- Total number of attempts
- Number of successful completions
- Number of failures

You can either perform all tests in succession, or perform only specific tests specified by the preceding command-line parameters.

You can run additional diagnostics in the CLI as listed in the following table. To determine the `cna_port_inst`, issue the `qaucli -nic -i` command as shown in [Table 2-15](#).

Table 2-15. Running Windows Diagnostic Tests in the CLI

Test Type	Command
External Loopback	<pre>qaucli -nic -extloopback <cna_port_inst> <tests_num> <on_error></pre> <p>Where <code><tests_num></code> specifies the number of tests, 1–65535, and <code><on_error></code> is either 0=Ignore or 1=Abort.</p> <p>NOTE: This test requires a pass-through module to be configured for both ports. Test runs between two ports. Single port loopback is not supported.</p>
Flash	<pre>qaucli -nic -testflash [cna_port_inst]</pre>
Hardware	<pre>qaucli -nic -testhw [cna_port_inst]</pre>
Internal Loopback	<pre>qaucli -nic -intloopback <cna_port_inst> <tests_num> <on_error></pre> <p>Where <code><tests_num></code> specifies the number of tests, 1–65535, and <code><on_error></code> is either 0=Ignore or 1=Abort</p>
Interrupt	<pre>qaucli -nic -testinterrupt [cna_port_inst]</pre>
Link	<pre>qaucli -nic -testlink [cna_port_inst]</pre>
Ping (IPv4)	<pre>qaucli -nic -ping <cna_port_inst> <hostname_or_IPv4> [<count> <pocket_size> <timeout_ms> <TTL>]</pre> <p>Where the default values are <code>count=5</code>, <code>pocket_size=525</code>, <code>timeout_ms=1000</code>, and <code>TTL=30</code></p>
Register	<pre>qaucli -nic -testregister [cna_port_inst]</pre>
Transceiver DMI Data	<pre>qaucli -nic -trans [cna_port_inst]</pre>

Windows Diagnostic Test Descriptions

This section provides descriptions of the following Windows diagnostic tests:

- “Hardware Test” on page 2-82
- “Register Test” on page 2-82
- “Interrupt Test” on page 2-82
- “Loopback Test” on page 2-82
- “Link Test” on page 2-82

Hardware Test

The hardware test checks the status of various hardware blocks, including DMA engines, receive engine, and on-board processor meta cores.

Register Test

The register test performs device register read/write accesses.

Interrupt Test

The interrupt test checks the ability of the hardware to create an interrupt and the ability of the driver to process the interrupt by forcing the generation of a predetermined number of interrupts. The test succeeds if the device generates the interrupts and the driver processes all interrupts expected.

Loopback Test

The loopback test is a diagnostic tool that routes transmit data through a loopback connector back to the same adapter.

Link Test

The link test inspects the link status (up or down) by checking the physical communication channel between the host and the firmware.

Windows Diagnostic Test Messages

If a test fails, an appropriate error code is generated and displayed, as shown in [Table 2-16](#). Note that this table does not list error messages for the interrupt and link tests.

Table 2-16. Windows Diagnostic Test Messages

Test	Error Message	Description
Loopback	LB_TEST_OK	Loopback test has passed
	LB_SEND_WAIT_QUEUE_ERR	Send queue blocked
	LB_NORCV_ERR	Receive packet not received
	LB_NOMEM_ERR	No memory error
	LB_TX_QUEUE_ERR	Transmit queue error
	LB_SHORT_DATA_ERR	Looped data short error
	LB_SEQUENCE_ERR	Looped data out of sequence
	LB_DATA_ERR	Looped data corrupted
	LB_ERR_CNT	Looped error count
Register	CR_TEST_OK	Control register test passed
	CR_NIU_MODE	Network interface unit (NIU) error
	CR_PHY	Physical layer (PHY) error
	CR_ERRCNT	Control register error count
Hardware	HW_TEST_OK	Hardware test has passed
	HW_DMA_BZ_0	DMA channel 0 is busy
	HW_DMA_BZ_1	DMA channel 1 is busy
	HW_DMA_BZ_2	DMA channel 2 is busy
	HW_DMA_BZ_3	DMA channel 3 is busy

Table 2-16. Windows Diagnostic Test Messages (Continued)

Test	Error Message	Description
Hardware (Continued)	HW_SRE_PBI_HALT	Segmentation and reassembly engine currently halted
	HW_SRE_L1IPQ	Segmentation and reassembly engine currently paused due to L1 IPQ discard failure
	HW_SRE_L2IPQ	Segmentation and reassembly engine currently paused due to L2 IPQ discard failure
	HW_SRE_FREEBUF	Segmentation and reassembly engine free buffer list is currently empty
	HW_IPQ	IPQ is currently not empty
	HW_PQ_W_PAUSE	PQ write pause previously detected
	HW_PQ_W_FULL	PQ write full previously detected
	HW_IFQ_W_PAUSE	IFQ write pause previously detected
	HW_IFQ_W_FULL	IFQ write full previously detected
	HW_MEN_BP_TOUT	Memory backpressure timeout previously detected
	HW_DOWN_BP_TOUT	Downstream backpressure timeout previously detected
	HW_FBUFF_POOL_WM	Free buffer pool low watermark previously detected
	HW_PBUF_ERR	Packet buffer error previously detected
	HW_PBUF_ERR	Packet buffer error previously detected
	HW_FM_MSG_HDR	FM message header error previously detected
	HW_FM_MSG	FM message error previously detected
	HW_EPG_CTRL_Q	Egress packet generator (EPG) control queue is backed up
HW_EPG_MSG_BUF	EPG message buffer error	

Table 2-16. Windows Diagnostic Test Messages (Continued)

Test	Error Message	Description
Hardware (Continued)	HW_EPG_QREAD_TOUT	EPG read queue timeout
	HW_EPG_QWRITE_TOUT	EPG write queue timeout
	HW_EPG_CQ_W_FULL	EPG completion queue write full
	HW_EPG_MSG_CHKSM	Egress packet generator (EPG) message checksum error
	HW_EPG_MTLQ_TOUT	EPG MTL queue fetch timeout
	HW_PEG0	PEG 0 is not used
	HW_PEG1	PEG 1 is not used
	HW_PEG2	PEG 2 is not used
	HW_PEG3	PEG 3 is not used
	HW_ERRCNT	Hardware error count

For example:

```

gauccli -nic -testlink
=== Link Test for 1. CNA Port Index ===
Function is not supported by this hardware/driver/api stack
=== Link Test for 2. CNA Port Index ===
Function is not supported by this hardware/driver/api stack
=== Link Test for 3. CNA Port Index ===
Function is not supported by this hardware/driver/api stack
=== Link Test for 4. CNA Port Index ===
Function is not supported by this hardware/driver/api stack
=== Link Test for 5. CNA Port Index ===
Link Test Starts...
Test Status: Passed (Passed=1, Failed=0, ErrorCode=0)
Register Test Results:
    Status=Passed
    Passed=1, Failed=0, ErrorCode=0
=== Link Test for 6. CNA Port Index ===
Link Test Starts...
Test Status: Passed (Passed=1, Failed=0, ErrorCode=0)
Register Test Results:
    Status=Passed
    Passed=1, Failed=0, ErrorCode=0

```

QCC GUI Diagnostics

Refer to the *QConvergeConsole Help System: Performing NIC Port Diagnostics* for information.

QCC CLI Diagnostics QCC Interactive CLI

Refer to the *QConvergeConsole User's Guide* for information.

QCC CLI Diagnostics QCC Non-Interactive CLI

Refer to the *QConvergeConsole User's Guide*, section 4, "NIC Noninteractive Commands," for information.

NIC Troubleshooting Guidelines

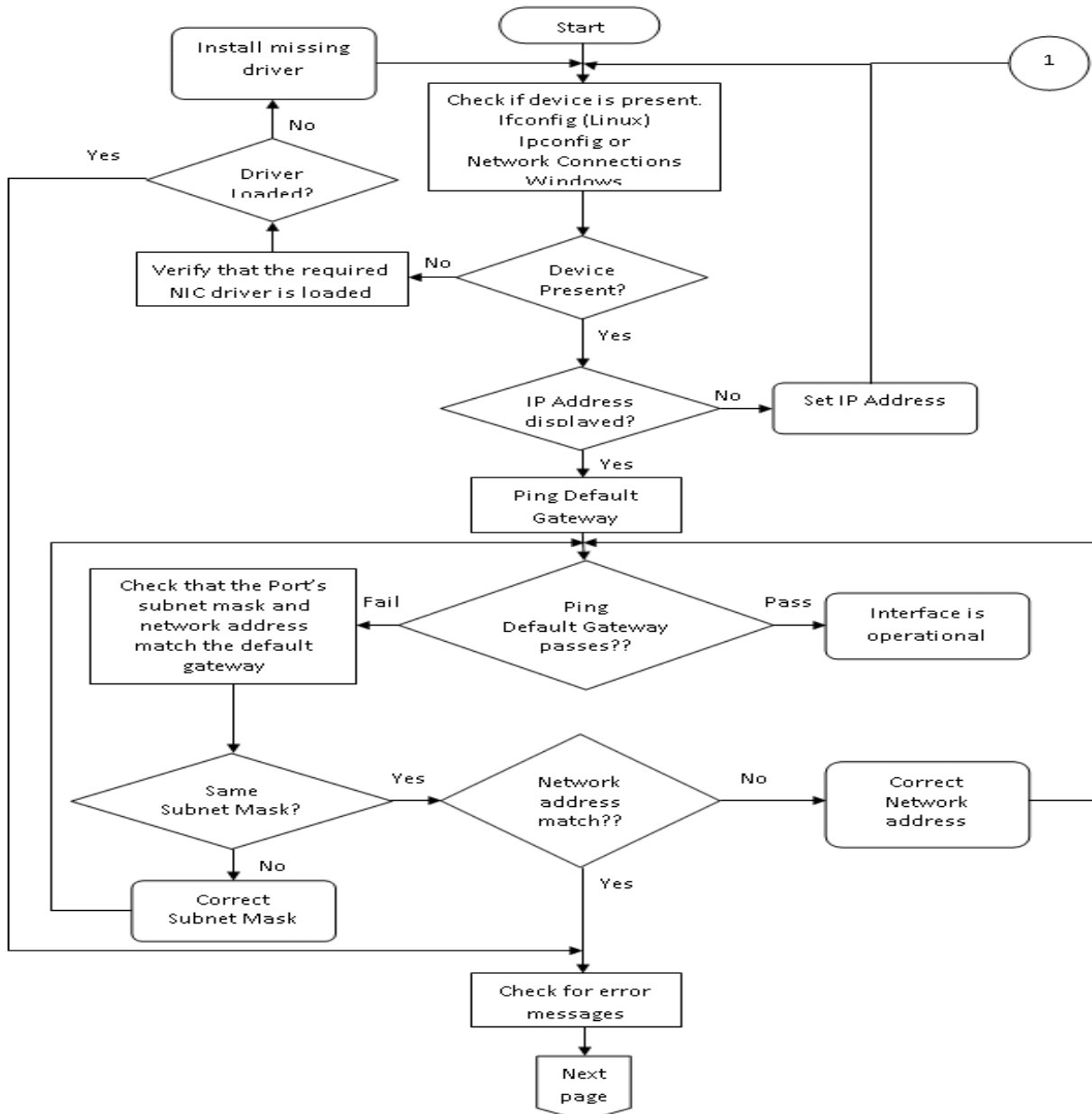

Figure 2-48. NIC Troubleshooting Diagram 1

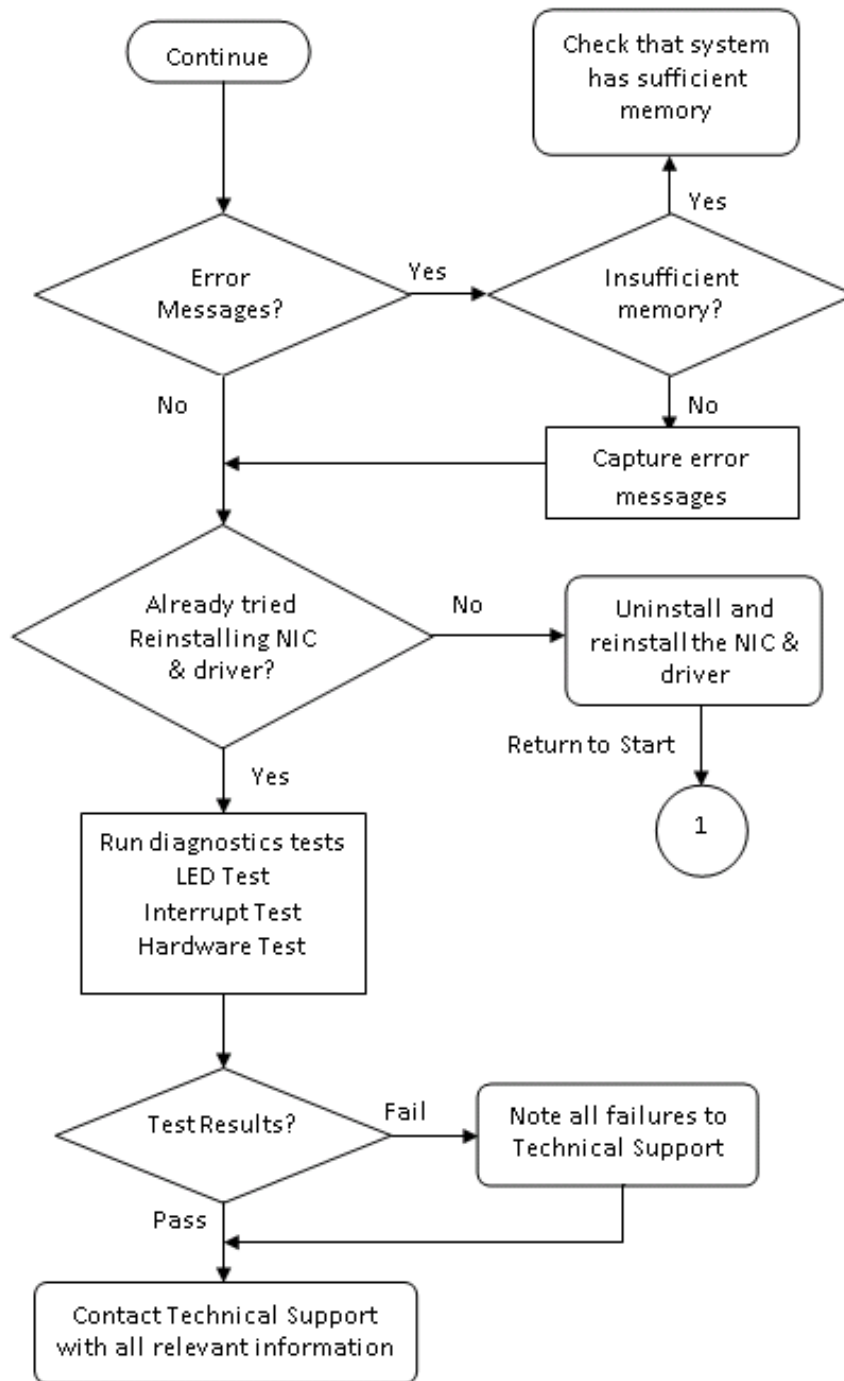

Figure 2-49. NIC Troubleshooting Diagram 2

3 Configuring iSCSI

iSCSI Overview

This section describes the driver and agent installation, configuration, operation, and troubleshooting of the iSCSI function of the 8200 Series Converged Network Adapter.

Installing iSCSI in Linux

Refer to the *iSCSI Adapter Inbox Driver Update* Readme file for information.

Packaging Content

Refer to the *iSCSI Adapter Inbox Driver Update* Readme file for information.

Linux OS Support

Refer to the *iSCSI Adapter Inbox Driver Update* Readme file for information.

Supported Features

Refer to the *iSCSI Adapter Inbox Driver Update* Readme file for information.

Deploying the Driver

Refer to the *iSCSI Adapter Inbox Driver Update* Readme file for information.

Driver System Parameters

Refer to the *iSCSI Adapter Inbox Driver Update* Readme file for information.

Installing iSCSI in ESX

Refer to the *iSCSI Adapter Driver and IMA Plug-in for VMware ESX/ESXi 4.1.x* Readme file for information.

Packaging Content

Refer to the *iSCSI Adapter Driver and IMA Plug-in for VMware ESX/ESXi 4.1.x* Readme file for information.

ESX OS Support

Refer to the *iSCSI Adapter Driver and IMA Plug-in for VMware ESX/ESXi 4.1* Readme file for information.

Using the Driver

Refer to the *iSCSI Adapter Driver and IMA Plug-in for VMware ESX/ESXi 4.1.x* Readme file for information.

Installing the Driver

Refer to the *iSCSI Adapter Driver and IMA Plug-in for VMware ESX/ESXi 4.1.x* Readme file for information.

Installing iSCSI in Windows

Refer to the *iSCSI Adapter STOR Miniport Driver for Windows* Readme file for information.

Packaging Content

Refer to the *iSCSI Adapter STOR Miniport Driver for Windows* Readme file for information.

Windows OS Support

Refer to the *iSCSI Adapter STOR Miniport Driver for Windows* Readme file for information.

Using the Driver

Refer to the *iSCSI Adapter STOR Miniport Driver for Windows* Readme file for information on how to create the driver disk, install the driver, and remove the driver.

iSCSI Configuration

iSCSI Configuration with QCC GUI

Refer to the *QConvergeConsole Help System* for information.

iSCSI Configuration with Interactive QCC CLI

Refer to the *QConvergeConsole CLI User's Guide* for information.

iSCSI Configuration with Non-Interactive CLI

Refer to the *QConvergeConsole CLI User's Guide*, “iSCSI Noninteractive Commands” section for information.

iSCSI Initiator

Configuring an iSCSI Initiator in Linux

Use QConvergeConsole CLI to configure the iSCSI initiator for Linux.

To configure a Linux iSCSI initiator:

1. Access the QConvergeConsole CLI by entering `qauccli` in a terminal window.
2. On the QConvergeConsole CLI Main Menu, select **2, Adapter Configuration**.
3. On the Adapter Type Configuration Selection menu, select **1, CNA Configuration**.
4. On the Converged Network Adapter (CNA) Protocol Type Selection menu, select **1, CNA iSCSI Configuration**.
5. On the Converged Network Adapter (CNA) iSCSI Configuration menu, select **3, Port IP Settings**.
6. Select the Converged Network Port you want to configure.
7. Select **2, Configure IP Settings**.
8. Complete the interactive list of settings as follows:
 - a. `Enable IPv4 [on]`: Press the ENTER key to accept the default.
 - b. `DHCP to obtain IPv4 Network Information: [off]`: Press the ENTER key to accept the default.
 - c. `IP_Address []`: Type the IP address of the initiator system, and then press the ENTER key.
 - d. `IP_Subnet_Mask [255.255.255.0]`: Type the appropriate subnet mask, and then press the ENTER key.

- e. `IP_Gateway [0.0.0.0]` : Press the ENTER key to accept the default.
 - f. `Enable IPv6 [off]` : Press the ENTER key to accept the default.
 9. On the options menu that opens, select **3, Save changes and reset HBA (if necessary)**.
 10. At the prompt for both ports, type **Yes**.
 11. To return to the Converged Network Adapter (CNA) iSCSI Configuration menu, type **p** and press the ENTER key, and then type **p** and press the ENTER key again.
 12. On the Converged Network Adapter (CNA) iSCSI Configuration menu, select **4, Target Configuration**.
 13. Select the same Converged Network Port you selected in [Step 6](#).
 14. Select **6, Add a Target**.
 15. Complete the interactive list of settings as follows:
 - a. `IPv6 Target? [off]` : Press the ENTER key to accept the default.
 - b. `TGT_iSCSI_Name []` : Type the iSCSI qualified name (IQN) of the iSCSI target to connect to, and then press the ENTER key.
 - c. `TGT_Port [3260]` : Press the ENTER key to accept the default.
 - d. `TGT_TargetIPAddress [0.0.0.0]` : Type the IP address of the target, and then press the ENTER key.
 16. On the options menu that opens, select **12, Save Target/CHAP Changes**.
- The iSCSI initiator is now configured to connect to the iSCSI target.

Configuring an iSCSI Initiator in Windows

Use QConvergeConsole CLI to configure the iSCSI initiator for Windows.

To configure a Windows iSCSI initiator:

1. Access the QConvergeConsole CLI either by double-clicking the **QCC CLI** desktop icon or by entering `qaucLi` in the CMD window.
2. On the QConvergeConsole CLI Main Menu, select **2, Adapter Configuration**.
3. On the Adapter Type Configuration Selection menu, select **1, CNA Configuration**.
4. On the Converged Network Adapter (CNA) Protocol Type Selection menu, select **1, CNA iSCSI Configuration**.
5. On the Converged Network Adapter (CNA) iSCSI Configuration menu, select **3, Port IP Settings**.

6. Select the Converged Network Port you want to configure.
7. Select **2, Configure IP Settings**.
8. Complete the interactive list of settings as follows:
 - a. `Enable IPv4 [on]`: Press the ENTER key to accept the default.
 - b. `DHCP to obtain IPv4 Network Information: [off]`: Press the ENTER key to accept the default.
 - c. `IP_Address []`: Type the IP address of the initiator system, and then press the ENTER key.
 - d. `IP_Subnet_Mask [255.255.255.0]`: Type the appropriate subnet mask, and then press the ENTER key.
 - e. `IP_Gateway [0.0.0.0]`: Press the ENTER key to accept the default.
 - f. `Enable IPv6 [off]`: Press the ENTER key to accept the default.
9. On the options menu that opens, select **3, Save changes and reset HBA (if necessary)**.
10. At the prompt for both ports, type `yes`.
11. To return to the Converged Network Adapter (CNA) iSCSI Configuration menu, type `p` and press the ENTER key, and then type `p` and press the ENTER key again.
12. On the Converged Network Adapter (CNA) iSCSI Configuration menu, select **4, Target Configuration**.
13. Select the same Converged Network Port you selected in [Step 6](#).
14. Select **6, Add a Target**.
15. Complete the interactive list of settings as follows:
 - a. `IPv6 Target? [off]`: Press the ENTER key to accept the default.
 - b. `TGT_iSCSI_Name []`: Type the iSCSI qualified name (IQN) of the iSCSI target to connect to, and then press the ENTER key.
 - c. `TGT_Port [3260]`: Press the ENTER key to accept the default.
 - d. `TGT_TargetIPAddress [0.0.0.0]`: Type the IP address of the target, and then press the ENTER key.
16. On the options menu that appears, select **12, Save Target/CHAP Changes**.
The iSCSI initiator is now configured to connect to the iSCSI target.

Configuring an iSCSI Initiator in VMware

The software iSCSI initiator must be enabled for ESX/ESXi to be able to use it for accessing iSCSI storage.

To configure an ESX/ESXi initiator:

1. Log in to the vSphere Client.
2. In the inventory panel, select a server to which to connect.
3. Click the **Configuration** tab.
4. In the Hardware panel, click **Storage Adapters**.
5. From the list of available storage adapters, select the iSCSI initiator you want to configure, and then click **Properties**.
6. Click **Configure**.

The General Properties dialog box shows the initiator's status, default name, and alias.

7. To enable the initiator, click **Enabled**.
8. (Optional) To change the default iSCSI name for your initiator, type a new name. The name you enter must be worldwide unique and properly formatted so that all storage devices can recognize the software iSCSI initiator.
9. To save your changes, click **OK**.

NOTE:

If you change the iSCSI name, it is used for new iSCSI sessions. Existing sessions do not use new settings until you log out and log in again.

iSCSI Name Server iSNS

Refer to the *Configuring iSNS to Automatically Discover Targets* section in the *QConvergeConsole Help System* for information.

iSCSI Boot

iSCSI Boot Setup Using Fast!UTIL

Fast!UTIL is the QLogic iSCSI BIOS Configuration utility that configures the iSCSI TCP/IP offload engine (TOE). Use Fast!UTIL to program the QLogic iSCSI adapter to boot from the SAN.

Accessing Fast!UTIL

To access Fast!UTIL for PXE, iSCSI, and FCoE, respectively, press the CTRL+Q keys during the QLogic 8200 and 3200 Series Adapters BIOS initialization when the PXE, iSCSI, or FCoE QLogic banner displays.

It may take a few seconds for the Fast!UTIL menu to appear. The Fast!UTIL Options menu for iSCSI contains the following selections:

- Configuration Settings
- Scan iSCSI Devices
- iSCSI Disk Utility
- Ping Utility
- Loopback Test
- Reinit Adapter
- Select Host Adapter
- Exit Fast!UTIL

Fast!UTIL prompts you to select the adapter you want to configure. After changing the settings, exit and reboot your system to load the new Fast!UTIL parameters.

Configuring iSCSI Boot Settings

Perform the following steps to configure the iSCSI boot settings.

Find the QLogic Adapter iSCSI name and IP address:

1. From the Fast!UTIL Options menu for iSCSI, select **Configuration Settings**.
2. Select **Host Adapter Settings**.
3. Write down the iSCSI name and IP address.

Configure the QLogic Adapter to boot from the SAN:

1. Have the QLogic Adapter directly connected, or through a switch, to the storage device. Be sure the storage device and the switch (if used) are both powered up and completely initialized before proceeding. Be sure all devices are visible to all other devices on the switch. If VLANs are enabled, the QLogic Adapter and storage device must be on the same VLAN. Refer to the switch vendor documentation on switch configuration.
2. Ensure that the storage device allows access to the QLogic Adapter. Refer to the vendor-specific documentation to determine how to enable this access.
3. If you have not already done so, download and install the BIOS on the QLogic Adapter.

The latest BIOS is available on the QLogic Web site,
<http://driverdownloads.qlogic.com>.

4. Start the system; press Ctrl+Q when the BIOS screen for the QLogic Adapter opens.
The Fast!UTIL Options menu opens.
5. Select **Configuration Settings**.
6. Select **Host Adapter Settings**.
7. Enable the **Host Adapter BIOS**.
8. Press ESC to exit the Host Adapter Settings window.
9. Select **iSCSI Boot Settings**.
10. Enable **iSCSI Boot**.

DHCP Boot Setup for iSCSI Boot (IPv4)

DHCP boot provides a method for the iSCSI initiator to acquire target parameters from a DHCP server. To configure the DHCP server to support iSCSI boot, first ensure that your DHCP server is set up.

iSCSI Boot Setup Using QCC CLI

Refer to the *QConvergeConsole CLI User's Guide* for information.

Configuring iSCSI Boot using the QCC CLI

Refer to the *QConvergeConsole CLI User's Guide* for information.

Configuring iSCSI Boot using Interactive QCC CLI

Refer to the *QConvergeConsole CLI User's Guide* for information.

Configuring iSCSI Boot using Non-interactive QCC CLI

Refer to the *QConvergeConsole CLI User's Guide*, “iSCSI Noninteractive Commands” section for information.

Configuring iSCSI DHCP Boot Options using QCC CLI

Refer to the *QConvergeConsole CLI User's Guide*, “iSCSI Noninteractive Commands” section for information.

Configuring iSCSI DHCP Boot Options using Interactive QCC CLI

Refer to the *QConvergeConsole CLI User's Guide* for information.

Configuring iSCSI DHCP Boot Options using Non-interactive QCC CLI

Refer to the *QConvergeConsole CLI User's Guide*, “iSCSI Noninteractive Commands” section for information.

iSCSI Boot Setup Using QCC GUI

Refer to the *Configuring Boot Settings* section in the *QConvergeConsole Help System* for information.

Configuring iSCSI Boot using the QCC GUI

Refer to the *Configuring Boot Settings* section in the *QConvergeConsole Help System* for information.

Configuring iSCSI DHCP Boot Options

Refer to the *Configuring Boot Settings* section in the *QConvergeConsole Help System* for information.

iSCSI Troubleshooting

iSCSI Diagnostics

iSCSI Diagnostics using QCC GUI

Refer to *QConvergeConsole Help System: Pinging an iSCSI Port Target* for information.

iSCSI Diagnostics using Interactive QCC CLI

Refer to the *QConvergeConsole CLI User's Guide* for information.

iSCSI Troubleshooting Diagram

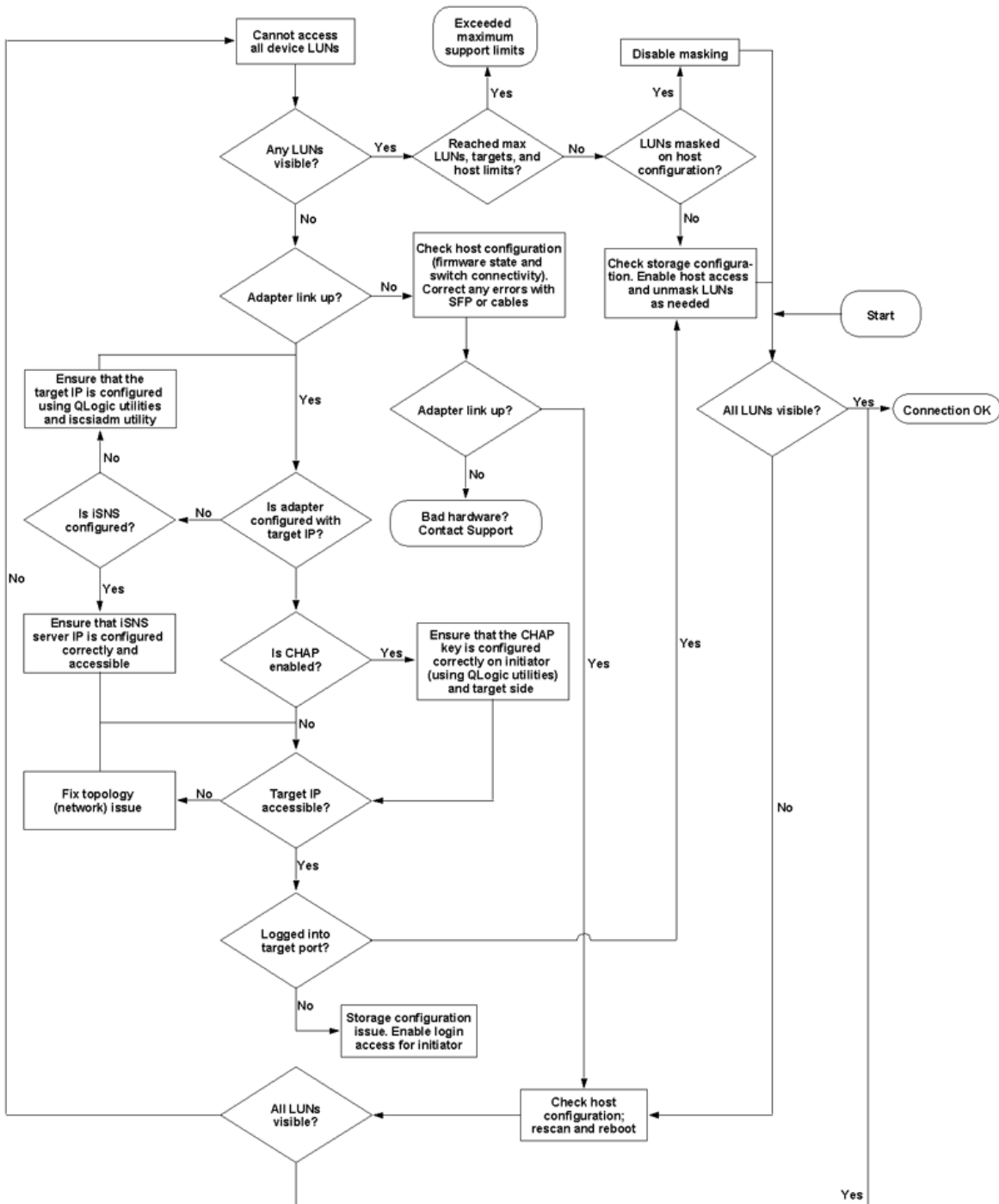

Figure 3-1. iSCSI Troubleshooting Diagram

4 Configuring FCoE

This section describes the driver and agent installation, configuration, operation, and troubleshooting of the FCoE function of the 8200 Series Converged Network Adapters.

Installing FCoE

Installing FCoE in Linux

Refer to the *Linux Fibre Channel Adapter and Converged Network Adapter Inbox Driver Update* Readme file for information.

Packaging Content

Refer to the *Linux Fibre Channel Adapter and Converged Network Adapter Inbox Driver Update* Readme file for information.

Linux OS Support

Refer to the *Linux Fibre Channel Adapter and Converged Network Adapter Inbox Driver Update* Readme file for information.

Supported Features

Refer to the *Linux Fibre Channel Adapter and Converged Network Adapter Inbox Driver Update* Readme file for information.

Deploying the Driver

Refer to the *Linux Fibre Channel Adapter and Converged Network Adapter Inbox Driver Update* Readme file for information.

Driver System Parameters

Refer to the *Linux Fibre Channel Adapter and Converged Network Adapter Inbox Driver Update* Readme file for information.

Boot From SAN

Refer to the *Linux Fibre Channel Adapter and Converged Network Adapter Inbox Driver Update* Readme file for information.

Firmware Installation

Refer to the *Linux Fibre Channel Adapter and Converged Network Adapter Inbox Driver Update* Readme file for information.

Installing FCoE in ESX

Refer to the *Fibre Channel and Fibre Channel over Ethernet (FCoE) Driver for VMware ESX/ESXi 4.0.x and 4.1* Readme file for information.

Packaging Content

Refer to the *Fibre Channel and Fibre Channel over Ethernet (FCoE) Driver for VMware ESX/ESXi 4.0.x and 4.1* Readme file for information.

ESX OS Support

Refer to the *Fibre Channel and Fibre Channel over Ethernet (FCoE) Driver for VMware ESX/ESXi 4.0.x and 4.1* Readme file for information.

Using the Driver

Refer to the *Fibre Channel and Fibre Channel over Ethernet (FCoE) Driver for VMware ESX/ESXi 4.0.x and 4.1* Readme file for information on how to create the driver disk, install the driver, and remove the driver.

Installing FCoE in Windows

Refer to the *Converged Network Adapter FCoE STOR Miniport Driver for Windows* Readme file for information.

Packaging Content

Refer to the *Converged Network Adapter FCoE STOR Miniport Driver for Windows* Readme file for information.

Windows OS Support

Refer to the *Converged Network Adapter FCoE STOR Miniport Driver for Windows* Readme file for information.

Using the Driver

Refer to the *Converged Network Adapter FCoE STOR Miniport Driver for Windows* Readme file for information on how to create the driver disk, install the driver, and remove the driver.

Driver Parameters

Refer to the *Converged Network Adapter FCoE STOR Miniport Driver for Windows* Readme file for information about Storport and driver registry parameters.

QLogic Adapter Parameters

Setting QLogic Adapter Parameters with the QCC GUI

Refer to the *QConvergeConsole Help System: Managing Fibre Channel and FCoE Adapters and Ports* for information.

Setting QLogic Adapter Parameters with the Interactive QCC CLI

Refer to the *QConvergeConsole CLI User's Guide* for information.

Setting QLogic Adapter Parameters with the Non-Interactive QCC CLI

Refer to the *QConvergeConsole CLI User's Guide*, “Fibre Channel Noninteractive Commands” section for information.

Target Persistent Binding

Configuring Persistent Binding with the QCC GUI

Refer to *QConvergeConsole Help System* for information.

Configuring Persistent Binding with the Interactive QCC CLI

Refer to the *QConvergeConsole CLI User's Guide* for information.

Configuring Persistent Binding with the Non-Interactive QCC CLI

Refer to *QConvergeConsole CLI User's Guide*, “Fibre Channel Noninteractive Commands” section for information.

Boot Devices Configuration

Configuring Boot Devices with the QCC GUI

Refer to *QConvergeConsole Help System: HBA Parameters-Viewing or Modifying Port Parameters - Boot Device Selection* for information.

Configuring Boot Devices with the Interactive QCC CLI

Refer to the *QConvergeConsole CLI User's Guide* for information.

Configuring Boot Devices with the Non-Interactive QCC CLI

Refer to the *QConvergeConsole CLI User's Guide*, “Fibre Channel Noninteractive Commands” section for information.

Configuring Boot Devices with the BIOS

Refer to “Using QLflash” on page 1-6 for information.

Virtual Ports (NPIV)

Configuring NPIV with the QCC GUI

Refer to the *QConvergeConsole Help System: Using Virtualization (NPIV)* for information.

Configuring NPIV with the Interactive QCC CLI

Refer to the *QConvergeConsole CLI User's Guide* for information.

Configuring NPIV with the Non-Interactive QCC CLI

Refer to the *QConvergeConsole CLI User's Guide*, “Fibre Channel Noninteractive Commands” section for information.

Driver Parameters

Configuring FCoE Driver Parameters with the QCC GUI

Refer to the *QConvergeConsole Help System: HBA Parameters-Viewing or Modifying Port Parameters* for information.

Configuring FCoE Driver Parameters with the Interactive QCC CLI

Refer to the *QConvergeConsole CLI User's Guide* for information.

Configuring FCoE Driver Parameters with the Non-Interactive QCC CLI

Refer to the *QConvergeConsole CLI User's Guide*, “Fibre Channel Noninteractive Commands” section for information.

Selective LUNS

Configuring Selective LUNS with the QCC GUI

Refer to the *QConvergeConsole Help System* for information.

Configuring Selective LUNS with the Interactive QCC CLI

Refer to the *QConvergeConsole CLI User's Guide* for information.

Configuring Selective LUNS with the Non-Interactive QCC CLI

Refer to the *QConvergeConsole CLI User's Guide*, “Fibre Channel Noninteractive Commands” section for information.

Troubleshooting

FCoE Diagnostics

FCoE Diagnostics using QCC GUI

Refer to the *QConvergeConsole Help System: Performing Diagnostics* section for information.

FCoE Diagnostics using Interactive QCC CLI

Refer to the *QConvergeConsole CLI User's Guide* for information.

FCoE Troubleshooting Diagram

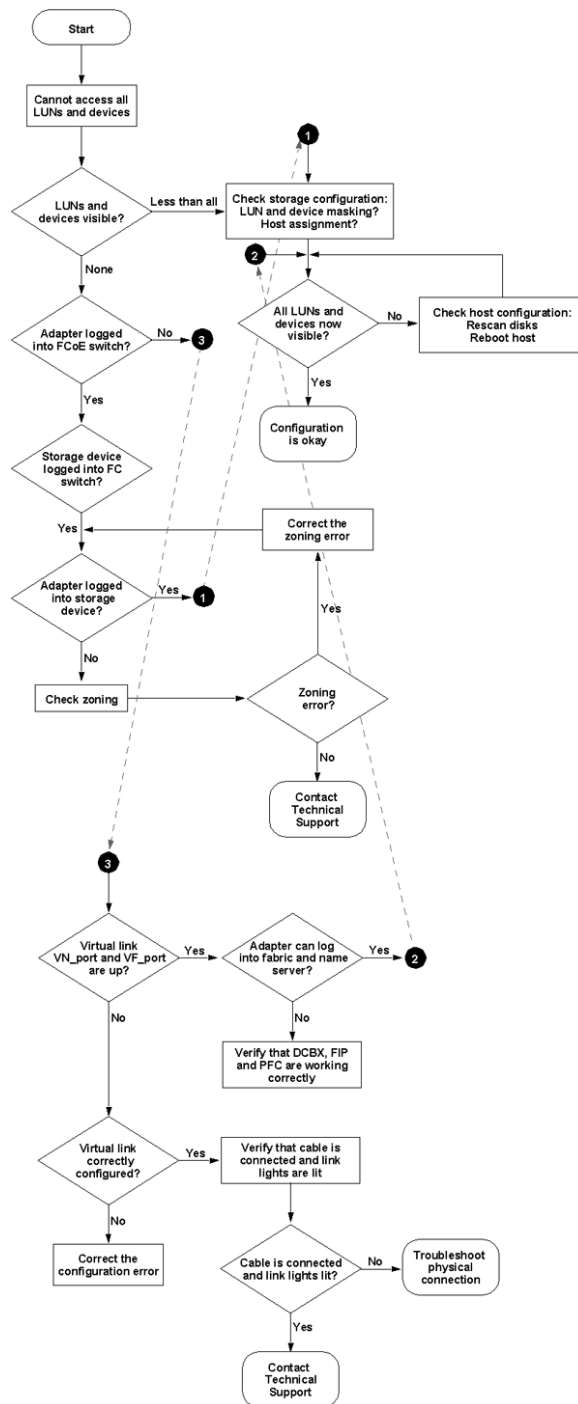

Figure 4-1. FCoE Troubleshooting Diagram

A Adapter LEDs

The LED behavior for the 8200 and 3200 Series Adapters is defined in [Table A-1](#).

Table A-1. QLE824x and QLE324x LED Scheme

Link LED	Activity LED	Activity
Off	Off	Power off
Off	Off	Power on (no link)
On	On	Power on/link established, no activity
On	Flashing	Power on/link established, LAN and/or SAN activity



Glossary

adapter

The board that interfaces between the host system and the target devices. Adapter is synonymous with host bus adapter, host channel adapter (HCA), host adapter, and adapter board.

adapter port

A port on the adapter board.

adapter port beacon

An LED on the adapter. Flashing it enables you to locate the adapter.

alias

A user-defined name for an adapter, adapter port, logical disk, or subsystem.

Basic input output system (BIOS)

The program (or utility) that serves as an interface between the hardware and the operating system and allows booting from the adapter at startup.

boot device

The device, usually a the hard disk, that contains the operating system the BIOS uses to boot from when the computer is started.

boot from SAN

The ability for each server on a network to boot their operating system from a Fibre Channel RAID unit located on the SAN, rather than from a local disk or direct-attached storage (DAS). This enables easier SAN management because you can replace a server and boot it from the Fibre Channel RAID unit.

challenge-handshake authentication protocol (CHAP)

CHAP is used for remote logon, usually between a client and server or a Web browser and Web server. A challenge/response is a security mechanism for verifying the identity of a person or process without revealing a secret password that is shared by the two entities. Also referred to as a "three-way handshake."

Converged Network Adapter

QLogic Converged Network Adapters support both data networking (TCP/IP) and storage networking (Fibre Channel) traffic on a single I/O adapter using two new technologies: Enhanced Ethernet and Fibre Channel over Ethernet.

cyclic redundancy check (CRC)

A type of check value designed to catch most transmission errors.

device

A computer subsystem, such as an adapter card, which mediates data in a computer network. The term “device” is used interchangeably with “target” and “target device.”

driver

The software that interfaces between the file system and a physical data storage device or network media.

dynamic host configuration protocol (DCHP)

Enables computers on an IP network to extract their configuration from servers that have information about the computer only after it is requested.

Enhanced Ethernet

Also called *data center Ethernet* or *converged enhanced Ethernet*. Refers to new enhancements to the existing Ethernet standard that eliminate Ethernet's inherent lossy nature and make 10Gb Ethernet a viable storage networking transport.

Ethernet

The most widely used LAN technology that transmits information between computers, typically at speeds of 10 and 100 million bits per second (Mbps).

failover path

Software feature that ensures data availability and system reliability by assigning alternate path and automatic adapter failover for device resources.

Fast!UTIL

QLogic *Fast!UTIL*™ Fibre Channel Adapter BIOS utility.

Fibre Channel

High-speed serial interface technology that supports other higher layer protocols such as SCSI and IP, and is primarily used in SANs. Standardized under ANSI in 1994.

Fibre Channel over Ethernet (FCoE)

Fibre Channel over Ethernet. A new technology defined by the T11 standards body that allows traditional Fibre Channel storage networking traffic to travel over an Ethernet link by encapsulating Fibre Channel frames inside Layer 2 Ethernet frames. For more information, visit www.fcoe.com.

Flash

Nonvolatile memory where the boot code is saved. At times, Flash and boot code are used interchangeably.

Internet protocol (IP)

A method by which data is sent from one computer to another over the Internet. IP specifies the format of packets, also called datagrams, and the addressing scheme.

Internet small computer system interface (iSCSI)

Protocol that encapsulates data into IP packets to send over Ethernet connections. An alternative to FCIP.

load balancing

A software feature that improves system performance by balancing device access between multiple ports or adapters for maximum resource efficiency.

local area network (LAN)

Network typically with transmissions less than 5km.

logical unit number (LUN)

A subdivision of a SCSI target. It is the small integer handle that differentiates an individual disk drive or partition (volume) within a common SCSI target device such as a disk array.

Technically, a LUN can be a single physical disk drive, multiple physical disk drives, or a portion (volume) of a single physical disk drive. However, LUNs are typically not entire disk drives but rather virtual partitions (volumes) of a RAID set.

Using LUNs, the Fibre Channel host can address multiple peripheral devices that may share a common controller.

loopback

Diagnostic tool that routes transmit data through a loopback connector back to the same adapter.

message signaled interrupts (MSI/MSI-X)

One of two PCI-defined extensions to support message signaled interrupts (MSI), in PCI 2.2 and later and PCIe. MSIs are an alternative way of generating an interrupt through special messages that allow emulation of a pin assertion or deassertion.

MSI-X (defined in PCI 3.0) allows a device to allocate any number of interrupts between 1 and 2048 and gives each interrupt separate data and address registers. Optional features in MSI (64-bit addressing and interrupt masking) are mandatory with MSI-X.

network interface controller/card (NIC)

A computer circuit board or card that is installed in a computer so that it can be connected to a network.

node port (N_Port)

Node port. A port that connects by a point-to-point link to either a single N_Port or a single G_Port. N_Ports handle creation, detection, and flow of message units to and from the connected systems. N_Ports are end ports in virtual point-to-point links through a fabric, for example N_Port to F_Port to F_Port to N_Port using a single Fibre Channel fabric switch.

N_Port ID virtualization (NPIV)

The ability for a single physical Fibre Channel end point (N_Port) to support multiple, uniquely addressable, logical end points. With NPIV, a host Fibre Channel adapter is shared in such a way that each virtual adapter is assigned to a virtual server and is separately identifiable within the fabric. Connectivity and access privileges within the fabric are controlled by identification of each virtual adapter and, hence, the virtual server using each virtual adapter.

Nonvolatile random access memory (NVRAM)

A type of memory that retains data (configuration settings) even when power is removed. You can manually configure NVRAM settings or restore them from a file.

path

A path to a device is a combination of an adapter port instance and a target port as distinct from internal paths in the fabric network. A fabric network appears to the operating system as an opaque network between the adapter (initiator) and the target.

path (continued)

Because a path is a combination of an adapter and a target port, it is distinct from another path if it is accessed through a different adapter or it is accessing a different target port. Consequently, when switching from one path to another, the driver might be selecting a different adapter (initiator), a different target port, or both.

This is important to the driver when selecting the proper method of failover notification. It can make a difference to the target device, which might have to take different actions when receiving retries of the request from another initiator or on a different port.

PCIe (PCI Express)

A third-generation input/output (I/O) standard that allows enhanced Ethernet network performance beyond that of the older peripheral component interconnect (PCI) and PCI extended (PCI-x) desktop and server slots.

port

Access points in a device where a link attaches. The most common port types are:

- N_Port is a Fibre Channel device port that supports point-to-point topology.
- NL_Port is a Fibre Channel device port that supports loop topology.
- F_Port is a port in a fabric where an N_Port can attach.
- FL_Port is a port in a fabric where an NL_Port can attach.

port instance

The number of the port in the system. Each adapter may have one or multiple ports, identified with regard to the adapter as port 0, port 1 and so forth. To avoid confusion when dealing with a system containing numerous ports, each port is assigned a port instance number when the system boots up. So port 0 on an adapter might have a port instance number of 8 if it is the eighth port discovered by the system.

quality of service (QoS)

Methods used to prevent bottlenecks and ensure business continuity when transmitting data over virtual ports by setting priorities and allocating bandwidth.

redundant array of independent/inexpensive disks (RAID)

Fault-tolerant disks that look like either single or multiple volumes to the server.

small computer systems interface (SCSI)

The original SCSI specification was a hardware bus specification and a packet-oriented protocol specification for communicating on that bus. SCSI over Fibre Channel uses the packet-oriented protocol to communicate with storage devices on the Fibre Channel.

storage area network (SAN)

Multiple storage units (disk drives) and servers connected by networking topology.

target

The storage-device endpoint of a SCSI session. Initiators request data from targets (usually disk-drives, tape-drives, or other media devices). Typically, a SCSI peripheral device is the target but an adapter may, in some cases, be a target. A target can contain many LUNs.

A target is a device that responds to a request by an initiator (the host system). Peripherals are targets, but for some commands (for example, a SCSI COPY command), the peripheral may act as an initiator.

transmission control protocol/Internet protocol (TCP/IP)

Basic communication language of the Internet.

UEFI

A specification detailing an interface that helps hand off control of the system for the pre-boot environment (that is, after the system is powered on, but before the operating system starts) to an operating system, such as Windows or Linux. UEFI provides a clean interface between operating systems and platform firmware at boot time, and supports an architecture-independent mechanism for initializing add-in cards.

worldwide port name (WWPN)

Unique 64-bit address assigned to each port on a device. One WWNN may contain multiple WWPN addresses.

Index

`-pr <protocol>` command [2-78](#)

A

adapter
 definition of [Glossary-1](#)
 port beacon, definition of [Glossary-1](#)
 port, definition of [Glossary-1](#)
adding team members [2-28](#)
advanced stateless offload features [1-2](#)
Agency certification, QLogic Adapters [xix](#)
agents, remote [2-45](#)
airborne contaminants [1-4](#)
alias, definition of [Glossary-1](#)
altitude ranges [1-4](#)
audience for this guide [xvi](#)

B

bandwidth
 adjusting [2-47](#)
 allocation [2-42](#)
 maximum [2-38](#), [2-55](#)
 minimum [2-38](#), [2-55](#)
 QCC CLI option [2-58](#)
 QCC GUI, setting with [2-53](#)
 user-configurable [2-38](#)
 Windows Device Manager, modifying in [2-65](#)
Basic input output system, [See](#) BIOS
BIOS, boot devices, configuring in [4-4](#)
BIOS, definition of [Glossary-1](#)

boot
 devices, BIOS, configuring with [4-4](#)
 devices, configuring with QCC CLI [4-3](#)
 devices, configuring with QCC GUI [4-3](#)
 devices, definition of [Glossary-1](#)
 from SAN, definition of [Glossary-1](#)
 iSCSI boot setup [3-6](#)

C

challenge-handshake authentication protocol,
 [See](#) CHAP
CHAP, definition of [Glossary-1](#)
Citrix, NPAR supported platforms for [2-39](#)
CNA Function Configuration Utility [1-5](#), [1-8](#)
command line options for QLflash [1-7](#)
Completion Queue Size parameter [2-9](#)
configuration, management tools for [2-44](#)
configuration, NPAR options [2-42](#), [2-69](#)
configuring
 driver software parameters [2-6](#)
 iSCSI function [3-3](#)
 NPAR [2-40](#)
 NPAR with QCC CLI [2-55](#)
 PXE boot [2-3](#)
Converged Network Adapter [1-1](#), [Glossary-1](#)
copper cables [xxiv](#)
CRC, definition of [Glossary-1](#)
creating a team [2-21](#)
cyclic redundancy check, [See](#) CRC

D

DCHP, configuring to support iSCSI boot [3-8](#)
DCHP, definition of [Glossary-2](#)

- defaults, NPAR [2-69](#)
- defaults, NPAR configuration [2-41](#)
- Device Manager [2-9](#)
- device, definition of [Glossary-2](#)
- diagnostics
 - ethtool [2-75](#)
 - FCoE function [4-5](#)
 - iSCSI function [3-9](#)
 - Linux text messages [2-76](#)
 - NIC, running in Linux [2-74](#)
 - QCC CLI [2-86](#)
 - QCC GUI [2-86](#)
 - QLogic Device Windows Property Page [2-76](#)
 - Windows QCC CLI diagnostic test commands [2-79](#)
 - Windows test messages [2-83](#)
- DLA [2-18](#)
- documentation, related [xvi](#)
- downloading QLogic drivers, management tools, multi-boot image, instructions, documentation [xxvi](#)
- driver
 - definition of [Glossary-2](#)
 - NPAR, used with [2-39](#)
 - parameters, configuring with QCC CLI [4-4](#)
 - parameters, configuring with QCC GUI [4-4](#)
 - QLogic Adapter, installing [xxv](#)
 - software parameters, configuring [2-6](#)
- dynamic
 - host configuration protocol, *See* DHCP
 - link aggregation mode [2-18](#)
 - link aggregation, *See* DLA

E

- EMC [xix](#)
- EMI [xix](#)
- Enhanced
 - Ethernet functions [1-2](#)
 - Ethernet, definition of [Glossary-2](#)
 - transition selection, *See* ETS
- environmental specifications [1-4](#)
- ESD rules [xxiii](#)

- eSwitch, definition of [2-43](#)
- eSwitch, statistics in Windows Device Manager [2-67](#)
- ESX/ESXi server [1-11](#)
- ESX/ESXi, installing NIC function on [2-1](#)
- esxupdate command [1-12](#), [1-13](#)
- Ethernet
 - definition of [Glossary-2](#)
 - frames [2-43](#)
 - functions [1-2](#)
- ethtool diagnostics [2-75](#)
- ethtool utility, described [2-7](#)
- ETS [2-42](#), [2-66](#)
- external loopback test [2-81](#)

F

- failover path, definition of [Glossary-2](#)
- failsafe mode [2-16](#)
- failsafe team [2-32](#)
- Fast!UTIL, definition of [Glossary-2](#)
- Fast!UTIL, iSCSI boot setup, configuring with [3-6](#)
- FCoE
 - definition of [Glossary-2](#)
 - diagnostics [4-5](#)
 - Linux, installing in [4-1](#)
 - troubleshooting [4-6](#)
 - VMware, installing in [4-2](#)
 - Windows, installing in [4-2](#)
- FDA notice [xix](#)
- features
 - interrupt management [1-2](#)
 - QLogic Adapters [1-1](#)
 - scalability [1-2](#)
- Fibre Channel over Ethernet, *See* FCoE
- Fibre Channel, definition of [Glossary-2](#)
- Flash
 - definition of [Glossary-2](#)
 - test [2-75](#), [2-81](#)
 - updating [1-16](#)
- Flow Control parameter [2-10](#)

function numbers [2-40](#)
function, NPAR PCI function number [2-55](#)

H

hardware test [2-75](#), [2-81](#), [2-82](#), [2-83](#)
Health Monitoring parameter [2-10](#)
help commands for NIC diagnostics in QCC CLI [2-79](#)
host server [2-51](#), [2-55](#)
humidity specifications [1-4](#)

I

installing
 drivers for QLogic Adapters [xxv](#)
 NIC in VMware ESX [2-1](#)
 QCC CLI [xxv](#)
 QCC GUI [xxv](#)
 QLflash [1-15](#)
 QLogic Adapter CIM Provider [1-12](#)
 QLogic Adapter vCenter Plug-in on Tomcat Server [1-19](#)
 QLogic Adapters [xxiii](#)
 Tomcat on Linux [1-17](#)
 Tomcat on Windows [1-18](#)
Intelligent Ethernet Adapter [1-1](#)
internal loopback test [2-75](#), [2-81](#)
Internet protocol, *See* IP
internet small computer system interface, *See* iSCSI
Interrupt
 management features [1-2](#)
 Moderation parameter [2-10](#)
 test [2-75](#), [2-81](#), [2-82](#)
IP, definition of [Glossary-2](#)
IPv4 Checksum Offload parameter [2-10](#)
iSCSI
 definition of [Glossary-2](#)
 DHCP boot options, configuring with QCC CLI [3-8](#)
 name server iSNS [3-6](#)
 troubleshooting [3-9](#), [3-10](#)

iSCSI boot
 settings, configuring [3-7](#)
 setup using QCC CLI [3-8](#)
 setup using QCC GUI [3-9](#)
iSCSI function
 boot from SAN, configuring to [3-6](#)
 configuring [3-3](#)
 diagnostics [3-9](#)
 Linux, installing in [3-1](#)
 QCC CLI, configuring with [3-3](#)
 QCC GUI, configuring with [3-3](#)
 VMware, installing in [3-2](#)
 Windows, installing in [3-2](#)
iSCSI initiator
 Linux, configuring in [3-3](#)
 VMware, configuring in [3-6](#)
 Windows, configuring in [3-4](#)

K

knowledge database [xviii](#)

L

LACP
 8200 Series Adapters, enabling on [2-35](#)
 configurations (invalid) [2-37](#)
 configurations (valid) [2-36](#)
LAN, definition of [Glossary-2](#)
Large
 Receive Offload parameter [2-10](#)
 Send Offload V1 IP4 parameter [2-10](#)
 Send Offload V2 IP4 parameter [2-11](#)
 Send Offload V2 IP6 parameter [2-11](#)
LEDs [A-1](#)
license agreements [xvii](#)
link
 aggregation control protocol, *See* LACP
 aggregation mode [2-17](#)
 test [2-76](#), [2-81](#), [2-82](#)

Linux

- bonding driver [2-34](#)
- bonding, failover, aggregation [2-34](#)
- diagnostic test descriptions [2-75](#)
- diagnostic test messages [2-76](#)
- FCoE, installing in [4-1](#)
- function type, changing using QCC CLI [2-60](#)
- iSCSI function, installing in [3-1](#)
- iSCSI initiator, configuring in [3-3](#)
- NIC diagnostics, running [2-74](#)
- NIC function, installing in [2-1](#)
- NPAR, supported platforms for [2-39](#)
- load balancing, definition of [Glossary-2](#)
- local area network, *See* LAN
- Locally Administered Address parameter [2-11](#)
- logical unit number, *See* LUNs
- loopback
 - definition of [Glossary-3](#)
 - external loopback test [2-81](#)
 - internal loopback test [2-81](#)
 - test [2-75](#), [2-82](#), [2-83](#)

LUNs

- definition of [Glossary-3](#)
- QCC CLI, configuring in [4-4](#)
- QCC GUI, configuring in [4-4](#)

M

- MAC address [2-15](#), [2-54](#)
- management configuration tools [2-44](#)
- management options for NPAR [2-46](#)
- materials, related [xvi](#)
- Max Ethernet Frame Size parameter [2-11](#)
- Max Jumbo Buffers parameter [2-12](#)
- maximum bandwidth [2-38](#), [2-55](#)
- message signaled interrupts, *See* MSI/MSI-X
- messages, Windows diagnostic test [2-83](#)
- MIC [xx](#)
- MinBW% [1-9](#)
- minimum bandwidth [2-38](#), [2-55](#)
- minimum bandwidth percentage parameter [1-9](#)

modes

- dynamic link aggregation [2-18](#)
- failsafe [2-16](#)
- link aggregation [2-17](#)
- SLA [2-18](#)
- teaming [2-15](#)
- modifying a team [2-31](#), [2-33](#)
- MSI/MSI-X, definition of [Glossary-3](#)
- multi-boot
 - code, updating [1-6](#)
 - features [1-2](#)
 - image [1-5](#)
 - image contents [1-6](#)
 - image for 10Gb CNA—CNA Function Configuration Utility [1-5](#)

N

- N_Port ID virtualization, *See* NPIV
- N_Port, definition of [Glossary-3](#)
- netqlremote [2-45](#)
- network interface controller/card, *See* NIC
- NIC
 - definition of [Glossary-3](#)
 - driver parameters, configuring with QCC GUI and QCC CLI [2-13](#)
 - Linux, installing on [2-1](#)
 - partitioning, *See* NPAR
 - troubleshooting and diagnostics [2-73](#)
 - troubleshooting guidelines [2-87](#)
 - VMware ESX/ESXi, installing on [2-1](#)
 - Windows, installing on [2-2](#)
- node port, *See* N_Port
- nonvolatile random access memory, *See* NVRAM

NPAR

- changing personalities [2-41](#)
 - configuration options [2-42](#), [2-69](#)
 - configuration parameters [2-70](#)
 - configuring [2-40](#)
 - default configurations [2-41](#)
 - default settings [2-69](#)
 - definition of [2-38](#)
 - drivers used with [2-39](#)
 - management options [2-46](#)
 - OptionROM, configuring with [2-47](#)
 - options [2-40](#)
 - overview [2-46](#)
 - parameters [2-54](#)
 - PCI function number [2-55](#)
 - PCI function type [2-55](#)
 - QCC CLI, configuring with [2-55](#)
 - QCC GUI, configuring with [2-52](#)
 - QLogic Device Windows Property Page, configuring with [2-60](#)
 - questions about [2-71](#)
 - setup [2-46](#)
 - setup requirements [2-39](#)
 - setup tools for [2-70](#)
 - teaming restrictions [2-41](#)
 - VLAN restrictions [2-41](#)
- ## NPIV
- definition of [Glossary-3](#)
 - QCC CLI, configuring with [4-4](#)
 - QCC GUI, configuring with [4-4](#)
- Number of Receive Buffers parameter [2-12](#)
- Number of Transmit Buffers parameter [2-12](#)
- NVRAM, definition of [Glossary-3](#)

O

- offline-bundle.zip file [1-12](#)
- operating systems supported [1-3](#)
- OptionROM
 - configuring NPAR with [2-47](#)
 - definition of [2-44](#)
 - NPAR, used with [2-39](#)
- options, NPAR [2-40](#)

overview

- iSCSI [3-1](#)
- NPAR setup [2-46](#)
- QCC CLI [2-45](#)
- QCC GUI [2-44](#)

P

- parameters, NPAR [2-54](#)
- path, definition of [Glossary-3](#)
- PCI
 - Express, definition of [Glossary-4](#)
 - function number [2-40](#)
 - function personality, QCC CLI [2-59](#)
 - function types [2-41](#)
 - NPAR PCI function number [2-55](#)
 - NPAR PCI function type [2-55](#)
- PCIe, definition of [Glossary-4](#)
- personalities
 - changing in NPAR [2-41](#)
 - changing with Windows Device Manager [2-64](#)
 - definition of [2-38](#)
 - function type [2-52](#)
- physical characteristics [1-3](#)
- ping test [2-81](#)
- port instance, definition of [Glossary-4](#)
- port, definition of [Glossary-4](#)
- POST [2-47](#)
- power-on self test, *see* POST
- Priority & VLAN Tag parameter [2-12](#)
- product safety compliance [xxi](#)
- property pages, QLogic Device Windows [2-9](#)
- Protocol parameter [1-9](#)
- PXE parameter [1-9](#)
- PXE, configuring PXE boot [2-3](#)

Q

qaucli utility [2-7](#)

QCC CLI

- boot devices, configuring with [4-3](#)
- configuring NPAR with [2-55](#)
- diagnostics [2-86](#)
- driver parameters, configuring with [4-4](#)
- FCoE diagnostics in [4-5](#)
- function type, changing on Linux [2-60](#)
- help commands for NIC diagnostics [2-79](#)
- installing [xxv](#)
- iSCSI boot options configuration [3-8](#)
- iSCSI boot setup [3-8](#)
- iSCSI diagnostics with [3-9](#)
- iSCSI function, configuring with [3-3](#)
- iSCSI initiator in Linux, configuring [3-3](#)
- LUNs, configuring in [4-4](#)
- NIC diagnostics [2-74](#)
- NIC driver parameters, configuring with [2-14](#)
- NPAR, used with [2-39](#)
- NPIV, configuring with [4-4](#)
- overview [2-45](#)
- PCI function personality [2-59](#)
- qaucli utility [2-7](#)
- QLogic Adapter parameters, setting with [4-3](#)
- target persistent binding, configuring with [4-3](#)
- teaming, using for [2-19](#)
- user diagnostics in Windows, running [2-78](#)
- VLAN, configuring with [2-14](#)
- Windows diagnostic test commands [2-79](#)

QCC GUI

- bandwidth, setting with [2-53](#)
 - boot devices, configuring with [4-3](#)
 - diagnostics [2-86](#)
 - driver parameters, configuring with [4-4](#)
 - FCoE diagnostics in [4-5](#)
 - installing [xxv](#)
 - iSCSI boot setup with [3-9](#)
 - iSCSI diagnostics with [3-9](#)
 - iSCSI function, configuring with [3-3](#)
 - LUNs, configuring with [4-4](#)
 - NIC driver parameters, configuring with [2-13](#)
 - NPAR, configuring with [2-52](#)
 - NPAR, used with [2-39](#), [2-52](#)
 - NPIV, configuring with [4-4](#)
 - overview [2-44](#)
 - QLogic Adapter parameters, setting with [4-3](#)
 - QoS setup with [2-53](#)
 - target persistent binding, configuring with [4-3](#)
 - user diagnostics, running in Windows [2-76](#)
 - VLAN, configuring with [2-14](#)
- QConvergeConsole See QCC CLI and QCC GUI
- qlcnic driver [2-34](#)
 - QLflash
 - command line options [1-7](#)
 - description of [1-6](#)
 - installing [1-15](#)
 - QLogic
 - Device Windows Properties Page, definition of [2-46](#)
 - Device Windows Property Page, diagnostics [2-76](#)
 - Device Windows Property Page, NPAR [2-60](#)
 - driver downloads [xxv](#)
 - OptionROM [2-44](#)
 - QLogic Adapter CIM Provider
 - installing [1-12](#)
 - removing [1-13](#)
 - starting and stopping [1-13](#)
 - updating after a prior VIB installation [1-13](#)

QLogic Adapter vCenter Plug-in
 components needed for installation [1-11](#)
 description of [1-10](#)
 removing [1-15](#)
 starting [1-15](#)
 Tomcat Server, installing on [1-19](#)
 Tomcat Server, using on [1-17](#)
 unregistration from a manual installation
 [1-19](#)
 vSphere Client, launching from [1-20](#)

QLogic Adapters
 definition of [1-1](#)
 features [1-1](#)
 installing [xxiii](#)
 LEDs [A-1](#)
 physical characteristics [1-3](#)

qlremote [2-45](#)

QoS
 definition of [2-42](#), [Glossary-4](#)
 overview [2-47](#)
 QCC GUI, setup with [2-53](#)

quality of service, *See* QoS

R

RAID, definition of [Glossary-4](#)

Receive Side Scaling parameter [2-12](#)

Receive Side Scaling Rings parameter [2-12](#)

redundant array of independent/inexpensive disks, *See* RAID

register test [2-76](#), [2-81](#), [2-82](#), [2-83](#)

related materials [xvi](#)

remote agents [2-45](#)

removing
 members from a team [2-29](#)
 QLogic Adapter CIM Provider [1-13](#)
 QLogic Adapter vCenter Plug-in [1-15](#)

resources [xxvi](#)

RPM package, installing [2-7](#)

S

SAN, definition of [Glossary-4](#)

scalability features [1-2](#)

SCSI, definition of [Glossary-4](#)

server, host [2-51](#), [2-55](#)

Sever, Tomcat, definition of [2-44](#)

SFCB CIMON, starting and stopping [1-13](#)

SLA [2-18](#)

small computer systems interface, *See* SCSI

standards supported [1-3](#)

starting
 QLogic Adapter CIM Provider [1-13](#)
 QLogic Adapter vCenter Plug-in [1-15](#)
 SFCB CIMON [1-13](#)
 Tomcat Server on Linux [1-18](#)
 Tomcat Server on Windows [1-18](#)

stateful offload features [1-2](#)

stateless, advanced stateless offload features
 [1-2](#)

static link aggregation, *See* SLA

statistics for teaming [2-34](#)

stopping
 QLogic Adapter CIM Provider [1-13](#)
 SFCB CIMON [1-13](#)
 Tomcat Server on Linux [1-18](#)
 Tomcat Server on Windows [1-18](#)

storage area network, *See* SAN

SuperInstaller [1-5](#)

supported operating systems [1-3](#)

T

target
 definition of [Glossary-5](#)
 persistent binding, configuring with QCC CLI
 [4-3](#)
 persistent binding, configuring with QCC
 GUI [4-3](#)

TCP
 Checksum Offload IPv4 parameter [2-13](#)
 Checksum Offload IPv6 parameter [2-13](#)
 IP, definition of [Glossary-5](#)

Team Management property page [2-19](#)

teaming

- configuration, saving [2-34](#)
- creating a team [2-21](#)
- deleting a team [2-33](#)
- failsafe team [2-32](#)
- MAC address [2-15](#)
- members, adding [2-28](#)
- members, removing [2-29](#)
- modes [2-15](#)
- modifying a team [2-31](#), [2-33](#)
- NPAR restrictions [2-41](#)
- QCC CLI, using for [2-19](#)
- statistics [2-34](#)
- Windows [2-14](#)

technical support [xvii](#)

temperature ranges [1-4](#)

terminology [xvi](#)

tests

- external loopback [2-81](#)
- Flash [2-75](#), [2-81](#)
- hardware [2-75](#), [2-81](#), [2-82](#), [2-83](#)
- internal loopback [2-75](#), [2-81](#)
- interrupt [2-75](#), [2-81](#), [2-82](#)
- link [2-76](#), [2-81](#), [2-82](#)
- Linux diagnostics test messages [2-76](#)
- loopback [2-82](#), [2-83](#)
- ping [2-81](#)
- register [2-76](#), [2-81](#), [2-82](#), [2-83](#)
- transceiver DMI data [2-81](#)
- Windows QCC CLI diagnostic test commands [2-79](#)

Tomcat Server

- definition of [2-44](#)
- Linux, installing on [1-17](#)
- Linux, stopping and starting on [1-18](#)
- QLogic Adapter vCenter Plug-in, using on [1-17](#)
- requirement for QLogic Adapter vCenter Plug-in [1-11](#)
- Windows, installing on [1-18](#)
- Windows, stopping and starting on [1-18](#)

training [xviii](#)

transceiver DMI data test [2-81](#)

transmission control protocol/internet protocol,
See TCP/IP

troubleshooting

- FCoE [4-6](#)
- iSCSI function [3-9](#), [3-10](#)
- NIC [2-73](#), [2-87](#)

U

UDP Checksum Offload IPv4 parameter [2-13](#)

UDP Checksum Offload IPv6 parameter [2-13](#)

UEFI, definition of [Glossary-5](#)

updating Flash [1-16](#)

updating multi-boot code [1-6](#)

V

vCenter Server [1-11](#)

VIB file [1-12](#)

vhostupdate command [1-12](#), [1-13](#)

VLAN

- ID for Setting parameter [2-13](#)
- NPAR restrictions [2-41](#)
- QCC GUI and QCC CLI, configuring with [2-14](#)

VMware

- FCoE installation in [4-2](#)
- iSCSI initiator, configuring in [3-6](#)
- iSCSi, installing in [3-2](#)

vSphere client [1-10](#)

vSphere client, QLogic Adapter vCenter
Plug-in, launching from [1-20](#)

W

Warranty and safety [A-1](#)

Windows [2-46](#)

- diagnostic test descriptions [2-81](#)
- diagnostic test messages [2-83](#)
- diagnostics, running in QCC CLI [2-78](#)
- diagnostics, running in QCC GUI [2-76](#)
- FCoE, installing in [4-2](#)
- iSCSI initiator, configuring in [3-4](#)
- iSCSI, installing in [3-2](#)
- NIC, installing on [2-2](#)
- NPAR, supported platforms for [2-39](#)
- NPAR, using with [2-39](#)
- QLogic Device Windows property pages [2-9](#)
- teaming [2-14](#)

Windows Device Manager

- bandwidth, modifying in [2-65](#)
 - eSwitch statistics, viewing in [2-67](#)
 - personalities, changing [2-64](#)
- worldwide port name, See WWPN
- WWPN, definition of [Glossary-5](#)



Corporate Headquarters QLogic Corporation 26650 Aliso Viejo Parkway Aliso Viejo, CA 92656 949.389.6000 www.qlogic.com

International Offices UK | Ireland | Germany | France | India | Japan | China | Hong Kong | Singapore | Taiwan

© 2011 QLogic Corporation. Specifications are subject to change without notice. All rights reserved worldwide. QLogic, QLogic logo, Fast!UTIL, and QConvergeConsole are trademarks or registered trademarks of QLogic Corporation. Citrix and XenServer are registered trademarks of Citrix Systems, Inc. Cisco and Cisco Nexus are trademarks or registered trademarks of Cisco Systems, Inc. Intel is a registered trademark of Intel Corporation. Linux is a registered trademark of Linus Torvalds. Novell is a registered trademark of Novell, Inc. PCIe is a registered trademark of PCI-SIG Corporation. Red Hat is a registered trademark of Red Hat, Inc. Solaris is a registered trademark of Sun Microsystems, Inc. SPARC is a registered trademark of SPARC International, Inc. in the USA and other countries. Sun is a trademark of Sun Microsystems, Inc. VMware, vSphere, and ESX are trademarks or registered trademarks of VMware, Inc. Windows, Windows Server, Hyper-V, and PowerShell are registered trademarks of Microsoft Corporation. All other brand and product names are trademarks or registered trademarks of their respective owners. Information supplied by QLogic Corporation is believed to be accurate and reliable. QLogic Corporation assumes no responsibility for any errors in this brochure. QLogic Corporation reserves the right, without notice, to make changes in product design or specifications