

INSTRUCTION MANUAL

TWO WAY RADIO

Model name:3208plus

Frequency:400-480MHz

FCC ID:T4K3208PLUS

The transceiver will provide you with reliable, clear and efficient communication service. The

THANK YOU!

performance transceiver, It boasts power (5W), long distance, loud and clear timbre, capacity

transceiver introduces innovative DSP digital signal processing technology, high level integration, it is including kinds of professional function, best stability and great reliability as well as exterior smooth lines, novel, fashionable, let it meet the instant communication technology and become a high

battery (7.4V 1500mAh), It is best suit for property, building, shopping mall, outdoor work place with noisy surroundings. For your full comprehension of the various excellent functions and maintenance, please read the user manual before use.

NOTE:

When programming the transceiver, read the factory initial data first, then rewrite the frequency and signaling etc., otherwise errors may occur because of different frequency band etc.

User Manual Applied to: 3208plus

SAFETY INFORMATION FOR USER

the transceiver is excellently designed with advanced technology. Please observe the following precautions to perform your obligation, prevent personal injury and ensure the safety of transceiver usage.

1. Keep the transceiver and accessories away from children.
2. Please do not try to open or modify the transceiver without permission, non-professionals process may also cause damage.
3. Please use assorted battery and charger to avoid damage.
4. Please use assorted antenna to ensure the communication distance.
5. Please do not expose the transceiver to long period of direct sunlight, nor place it close to heat appliances.
6. Please do not put the transceiver in excessively dusty or humid areas.
7. Do not use harsh chemicals, cleaning solvents to clean the transceiver.
8. Do not transmit without antenna.
9. When using this transceiver, we recommend transmitting for 1 minute then receiving for 4 minutes. Continuous transmitting for long time or working in high power will heat the back of the transceiver. Do not place the transceiver's hot back close to any surface of plastic.
10. If any abnormal odor or smoke detected coming from the transceiver, turn off the power and take off the battery pack and its case. Then contact local dealers.

ATTENTION:

All tips above apply to accessories of your transceiver. If any device can not work normally, please contact local dealers.

If you use any accessories made by other companies, our Company does not guarantee the operability and safety of the transceiver.

UNPACKING	1
Supplied Accessories	1
STANDARD ACCESSORIES/OPTIONAL ACCESSORIES	2
Standard Accessories	2
BATTERY INFORMATION	3
How to Charge	3
PREPARATION	4
Installing / Removing the Battery	4
Installing / Removing the Antenna	5
Installing / Removing the Belt Clip	5
Installing the Additional Speaker/ Microphone (Optional)	6
GETTING ACQUAINTED	7
Indicator Status and Beep	9
[PF1] & [PF2] Key Default	9
Auxiliary Functions	10
BASIC OPERATIONS	11
Switch on / off Transceiver	11
Battery Capacity Enquiry	11
Adjusting Volume	11
Channel Selection	12
Receiving	12
Monitor	12

• CONTENTS

Transmitting	13
Power Switch	13
ON/OFF VOX	13
Battery Save Setup.....	14
CTCSS / DCS Encode and Decode	14
Time-out Timer.....	14
Resume Factory Default.....	15
Maintaining and Cleaning.....	15
TECHNICAL SPECIFICATIONS	16
TROUBLE SHOOTING GUIDE.....	17

• UNPACKING

We only do best radio!

Carefully unpack the transceiver. We recommend you to identify the items listed in the following table before discarding the packing material. If any items are missing or have been damaged during shipment, please contact dealers immediately.

Supplied Accessories

Item	Number	Quantity
Antenna	QA01U(400-480MHz)	1
Li-ion Battery Pack	QB-40L	1
Battery Charger	QBC-40L	1
AC Adaptor	QPS-07	1
Belt Clip	BC09	1
Instruction Manual		1

• STANDARD ACCESSORIES/OPTIONAL ACCESSORIES

(((Standard Accessories

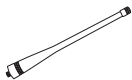

Antenna*1
QA01U (400-480MHz)

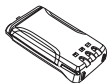

Li-ion Battery Pack
QB-40L



Charger
QBC-40L



AC Adaptor
QPS-07



Belt Clip
BC09



Instruction
Manual

How to Charge

1. Plug the AC adaptor into the AC outlet, and then plug the cable of the AC adaptor into the DC jack located on the back of the Charger. The Backlight lights orange (1s) and then goes out, lights green----waits to charge.
2. Plug the battery or transceiver into the charger. Make sure that the battery terminals are in contact with charging terminals well. The Backlight turns into twinkling red-----Pre-charging begins.
3. After pre-charging for about 5 minutes, the indicator will stop twinkling----charging begins.
4. It takes approximately 4.5 hours to fully charge the battery. When the lamp lights green, the charging is finished. Remove the battery or the transceiver is finished. Remove the battery or the transceiver equipped with battery from socket.

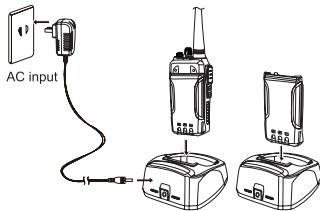

NOTE: When charging a power-on transceiver equipped with battery, the indicating lamp will not turn into green to show the fully charged status. Only when the transceiver is switched off, can the lamp indicate normally. The transceiver consumes energy when it is power-on, and the charger can not detect the voltage when the battery has been fully charged. So the charger will charge battery in constant voltage and fail to indicate correctly whether the battery has been charged fully.

• PREPARATION

(((Installing / Removing the Battery

■ Installing the Battery

1. Lay the battery to face the back of the radio.
2. Press the button of battery , the latch in button of transceiver locks will release . After hearing a "click" sounds ,the battery has been locked.

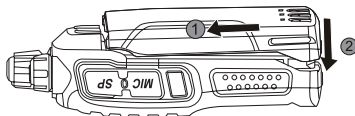

■ Removing the Battery

According to “▼” to push the battery lock to removing the battery.

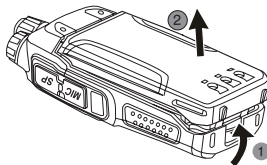

《《 Installing / Removing the Antenna

■ Installing the Antenna:

Screw the antenna into the connector on the top of the transceiver by holding the antenna at its base and turning it clockwise until secure.

■ Removing the Antenna:

Turn the antenna anticlockwise to remove it.

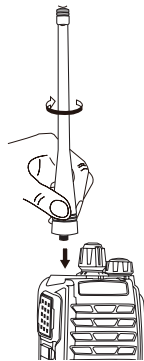

《《 Installing / Removing the Belt Clip

■ Installing the Belt Clip:

Place the belt clip to the grooves on the back of the transceiver, and then clockwise screw it in.

■ Removing the Belt Clip:

Anticlockwise turn the screws to remove the belt clip.

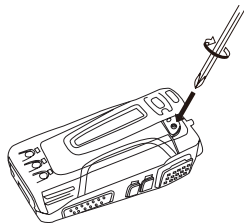

• PREPARATION

(((Installing the Additional Speaker/ Microphone (Optional)

Unveil the MIC-SP jack cover and then insert the Speaker/Microphone plug into MIC-SP jack.

Note:

The transceiver is not completely waterproof while using the Speaker/Microphone.

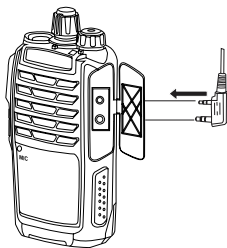

• GETTING ACQUAINTED

We only do best radio!

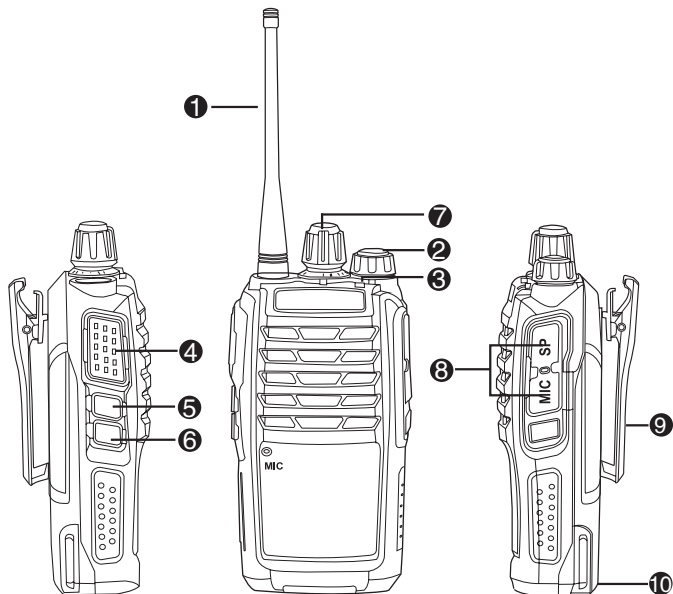

• GETTING ACQUAINTED

① Antenna

② POWER / VOLUME Switch:

Turn clockwise to switch on the transceiver, and turn anticlockwise till hearing “Click” to switch off the transceiver. After switching on the transceiver, turn clockwise to increase the volume and anticlockwise to decrease the volume.

③ Indicator light

④ PTT Key

When you are making a call, please press and hold this key to speak into the microphone. Release the key to receive.

⑤ PF1 Key

It can realize different functions by programming.

⑥ PF2 Key

It can realize different functions by programming.

⑦ Channel Selector Knob

Turn the selector knob to select desired channel. Turn clockwise to increase channel, anticlockwise to decrease channel.

⑧ Additional Microphone / Speaker Jack、 Reading / Writing frequency Jack

⑨ Belt Clip

⑩ Battery Lock

Indicator Status and Beep

Warning on low voltage	The red light twinkles.
Transmitting	Lighten the red light.
Receiving	Lighten the green light.
Reading/Writing Frequency	Reading Frequency: Red light twinkles Writing Frequency: Green light twinkles
Key Operation	Voices "DU" into any function, "DU DU" to exit any function.

[PF1] & [PF2] Key Default

Press [PF1]	Battery Capacity Enquiry
Press [PF2]	Squelch off
Press [PF1] 1 second	Monitor
Press [PF2] 1 second	Switch H/L Power
Press [PF1] 3 seconds	On/Off VOX Function

(((AUXILIARY FUNCTIONS

Users can setup the key [PF1] and [PF2] to be one of the optional functions as bellows :

- Squelch off
- Monitor
- Current Channel Power Enquiry
- Frequency Reverse
- Talk Around
- Battery Capacity Enquiry
- TX Power Switch
- Emergency Alarm

(((Switch on / off Transceiver

Switch on Transceiver: Under power-off state, turn POWER / VOLUME clockwise till hearing "Click" to switch on the transceiver. The transceiver will announce "**Power on**" when power-on and announce the current channel.

Switch off Transceiver: Under power-off state, turn POWER / VOLUME anticlockwise till hearing "Click" to switch off the transceiver.

(((Battery Capacity Enquiry

Under the standby conditions, press the programmed key of "Battery Capacity Enquiry" [PF1]/[PF2], transceiver announce current battery capacity. There are 10 grades in total. Grade 10th means full battery capacity.

When the battery state is grade 1th (6.29V), the LED lights red. The transceiver will voice prompt users each 30 seconds to charge timely and also enter automatically the state of no transmission.

(((Adjusting Volume

Under power-on state, turn POWER / VOLUME switch to adjust the volume. Turn clockwise to increase the volume, and anticlockwise to decrease the volume.

NOTE: You can press the programmed key of squelch off [PF1] / [PF2] to monitor the background noise and meanwhile turn POWER / VOLUME to adjust the volume. Under the communicating state, you can adjust volume as per your need more accurately.

• BASIC OPERATIONS

(((Channels Selection

Under the standby conditions, turn channel selector knob to choose the desired channel, and the transceiver will announce the adjusted channel. Turn clockwise to increase the channel, anticlockwise to decrease the channel.

NOTE: The transceiver will emit a voice prompt when current channel is blank and the red light will flash.

(((Receiving

You can hear the transmitting party's calling when the channel you are operating is called and the LED light turns green.

NOTE:

You may not receive the calling if you set a high squelch off level of the transceiver.

If current channel has been programmed with signaling, you can only hear the call from a same signaling, other calls can not be heard.

(((Monitor

Pressing the programmed key of Monitor [PF1]/[PF2], the transceiver emits "DU" beep and then comes into the monitor state. Under these conditions, transceiver will ignore CTCSS/DCS decode and monitor signal of the other party as long as receiving the matched carrier wave. Press this key again, transceiver emits "Du Du" beep and exits the monitor state.

(((Transmitting

Before transmitting, make sure that the channel you want to use is not in busy state through monitoring for a while by pressing the programmed Squelch off [PF1] / [PF2] key. Under these conditions, press the [PTT] key and speak into microphone. Please keep around 2.5-5cm distance between microphone and your lip. And please speak in normal tone to make the receiver obtain best tone quality.

Note: Press [PTT] Red LED lighting means transmitting. Release [PTT] to receive signal.

(((Power Switch

Under the standby conditions, press the programmed key of "Power Switch" [PF1]/[PF2], transceiver change the current channel power and announces.

(((ON/OFF VOX

When turn on this function, it's not necessary to press the [PTT], through the appropriate voice can start emission.

In standby, put HS03 earphone into MIC-SPK, press and hold [PF1] more than 3 seconds, the transceiver will send a prompt voice and turn on VOX function. Repeat the above operation or restart will be closed the VOX function.

NOTE: It needs to program the VOX in valid status firstly if you want to turn on this function, otherwise, the above operation is invalid.

• BASIC OPERATIONS

(((Battery Save Setup

When this function is enabled, the transceiver can efficiently reduce battery consumption. The transceiver will automatically switch on Battery Save Function when not receiving a signal or making any operations. But when the transceiver receives a matching signal or make operation it will automatically exits this function.

(((Time-out Timer

The purpose of the Time-out Timer is to prevent any caller from using a channel for an extender period of time. If you continuously transmit for a period of time that exceeds the programmed time set in advance, the transceiver will stop transmitting with voice prompt. Users can set TOT timer by programming software.

(((Resume Factory Default

Once transceiver works abnormally for wrong operations or wrong programming, users can start this function to resume all functions and channels as Factory Default.

Under standby conditions press [PTT] and [PF1] key synchronously to switch on transceiver. Holding the two keys until hear transceiver announces "DI" beep then release the keys, the transceiver will factory default.

NOTE: Via programming software can set whether allow to use this function in transceiver, please reference to the Reset Allowed option in programming software.

(((Maintaining and Cleaning

Cover the jack with its opercula when the transceiver is not in use. After long-time use of the transceiver, keys, control buttons and housing would become dirty. Then, neutral detergent (no corrosive chemical agent) and wet cloth can be used to clean them.

• TECHNICAL SPECIFICATIONS

General	
Frequency Range	UHF: 400~480MHz
Channel Capacity	16 channels
Channel Spacing	12.5KHz
Phase-locked Step	2.5KHz, 5KHz, 6.25KHz
Operating Voltage	7.4V DC
Battery Life	More than 12 Hours (1500mAh), by 5-5-90 work cycle
Frequency Stability	±2.5ppm
Operating Temperature	-20°C~ +55°C
Size	127×60×35mm (with battery pack)
Weight	219 g (with battery pack, antenna)

Receiving Part		
Sensitivity(12dB SINAD)	≤0.25μV	≤0.35μV

Adjacent Channel Selectivity	≥60dB
Intermodulation	≥55dB
Spurious Rejection	≥80dB
Audio Response	6dB/per interval
Hum & Noise	≥40dB
Audio Distortion	≤5%
Audio Power Output	500mW/10%

Transmitting Part	
Power Output	5W
Modulation	11KΦF3E
Adjacent Channel Power	≥65B
Hum & Noise	≥40dB
Spurious Emission	≤-36dB
Audio Response	6dB/per interval
Audio Distortion	≤5%

• TROUBLE SHOOTING GUIDE

We only do best radio!

Problem	Corrective Action
No Power	A. The battery pack may be exhausting. Recharge or replace the battery pack. B. The battery pack may not be installed correctly. Remove the battery pack and install it again. C. The power switch is broken; send it to local dealers to repair. D. Battery touch is broken; send it to local dealers to repair.
Battery power dies shortly after correctly charging.	The battery pack life is finished. Replace the battery pack with a new one.
No sound after using microphone for a while	Earphone jack is broken. (Please contact with local dealers to repair it.)
Cannot talk to or hear other members in your group	A. Different frequency or channel, please change it. B. Different CTCSS / DCS please reset it. C. Out of communication range.
Unstable communication with loud background noise	Out of communication range or obstruct by tall buildings or in basement and so on.

SAFETY TRAINING INFORMATION



Your Qixiang Electron Science & Technology Co., Ltd radio generates RF electromagnetic energy during transmit mode. This radio is designed for and classified as “Occupational Use Only”, meaning it must be used only during the course of employment by individuals aware of the hazards, and the ways to minimize such hazards. This radio is NOT intended for use by the “General Population” in an uncontrolled environment.

This radio has been tested and complies with the FCC RF exposure limits for “Occupational Use Only”. In addition, your Qixiang Electron Science & Technology Co., Ltd radio complies with the following Standards and Guidelines with regard to RF energy and electromagnetic energy levels and evaluation of such levels for exposure to humans:

- ▮ FCC OET Bulletin 65 Edition 97-01 Supplement C, Evaluating Compliance with FCC Guidelines for Human Exposure to Radio Frequency Electromagnetic Fields.
- ▮ American National Standards Institute (C95.1-1992), IEEE Standard for Safety Levels with Respect to Human Exposure to Radio Frequency Electromagnetic Fields, 3 kHz to 300 GHz.
- ▮ American National Standards Institute (C95.3-1992), IEEE Recommended Practice for the Measurement of Potentially Hazardous Electromagnetic Fields– RF and Microwave.



The information listed above provides the user with the information needed to make him or her aware of RF exposure, and what to do to assure that this radio operates with the FCC RF exposure limits of this radio.

Electromagnetic Interference/Compatibility

During transmissions, your Qixiang Electron Science & Technology Co., Ltd radio generates RF energy that can possibly cause interference with other devices or systems. To avoid such interference, turn off the radio in areas where signs are posted to do so. **DO NOT** operate the transmitter in areas that are sensitive to electromagnetic radiation such as hospitals, aircraft, and blasting sites.

Occupational/Controlled Use

The radio transmitter is used in situations in which persons are exposed as consequence of their employment provided those persons are fully aware of the potential for exposure and can exercise control over their exposure.

Attention:

This radio complies with IEEE and ICNIRP exposure limits for occupational/controlled RF exposure environment at operating duty factors of up to 50% and is authorized by the FCC for occupational use only. An appropriate warning label is affixed to all units. In order to comply with RF exposure requirements, a minimum distance of 2.5cm must be maintained when held-to-face, and body-worn operations are restricted to the approved original accessories (belt clip).

Do not use this device when antenna shows obvious damages