

CE0678  RoHS

# SoonTone®

## ST-5188 VEHICLE RADIO

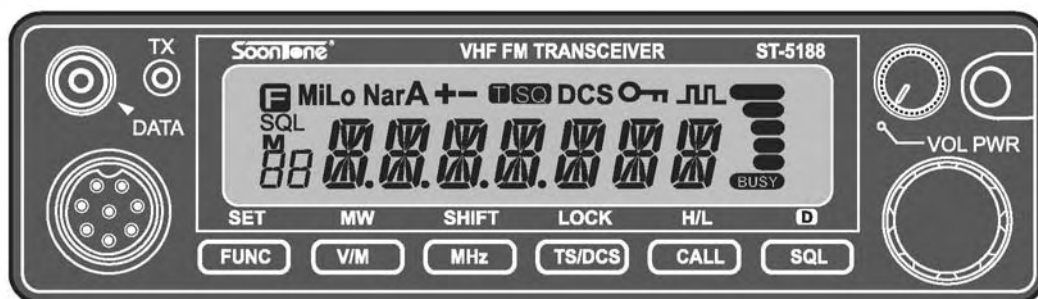

# USER'S MANUAL

## SAFETY TRAINING INFORMATION



Your **ST-5188** radio generates RF electromagnetic energy during transmit mode. This radio is designed for and classified as "Occupational Use Only", meaning it must be used only during the course of employment by individuals aware of the hazards, and the ways to minimize such hazards. This radio is NOT intended for use by the "General Population" in an uncontrolled environment.

This radio has been tested and complies with the FCC RF exposure limits for "Occupational Use Only". In addition, your **ST-5188** radio complies with the following Standards and Guidelines with regard to RF energy and electromagnetic energy levels and evaluation of such levels for exposure to humans:

- FCC OET Bulletin 65 Edition 97-01 Supplement C, Evaluating Compliance with FCC Guidelines for Human Exposure to Radio Frequency Electromagnetic Fields.
- American National Standards Institute (C95.1-1992), IEEE Standard for Safety Levels with Respect to Human Exposure to Radio Frequency Electromagnetic Fields, 3 kHz to 300 GHz.
- American National Standards Institute (C95.3-1992), IEEE Recommended Practice for the Measurement of Potentially Hazardous Electromagnetic Fields— RF and Microwave.
- The following accessories are authorized for use with this product. Use of accessories other than those (listed in the instruction) specified may result in RF exposure levels exceeding the FCC requirements for wireless RF exposure.



To ensure that your exposure to RF electromagnetic energy is within the FCC allowable limits for occupational use, always adhere to the following guidelines:

- **DO NOT** operate the radio without a proper antenna attached, as this may damage the radio and may also cause you to exceed FCC RF exposure limits. A proper antenna is the antenna supplied with this radio by the manufacturer or antenna specifically authorized by the manufacturer for use with this radio.
- **DO NOT** transmit for more than 50% of total radio use time ("50% duty cycle"). Transmitting more than 50% of the time can cause FCC RF exposure compliance requirements to be exceeded. The radio is transmitting when the "TX indicator" lights red. You can cause the radio to transmit by pressing the "PTT" switch.
- **ALWAYS** keep the antenna at least **60 cm** away from the body when transmitting

The information listed above provides the user with the information needed to make him or her aware of RF exposure, and what to do to assure that this radio operates within the FCC RF exposure limits of this radio.

### Electromagnetic Interference/Compatibility

During transmissions, your **ST-5188** radio generates RF energy that can possibly cause interference with other devices or systems. To avoid such interference, turn off the radio in areas where signs are posted to do so. **DO NOT** operate the transmitter in areas that are sensitive to electromagnetic radiation such as hospitals, aircraft, and blasting sites.

### Occupational/Controlled Use

The radio transmitter is used in situations in which persons are exposed as a consequence of their employment provided those persons are fully aware of the potential for exposure and can exercise control over their exposure.

## IMPORTANT

READ ALL INSTRUCTIONS carefully and completely before using the transceiver

SAVE THIS INSTRUCTION MANUAL- This instruction manual contains important operating instructions for the Two-Way Radio

## EXPLICIT DEFINITIONS

WORD	DEFINITION
WARNING	Personal injury, fire hazard or electric shock may occur.
CAUTION	Equipment damage may occur.
NOTE	If disregarded, inconvenience only. No risk of personal injury, fire or electric shock.

## OPERATING NOTES

- When transmitting, Please Keep the antenna at least 60 cm from your head and body.

## PRECAUTIONS

**WARNING! NEVER** hold the transceiver so that the antenna is very close to, or touching exposed parts of the body, especially the face or eyes, while transmitting. The transceiver will perform best if the microphone is 60 cm away from the antenna.

**WARNING! NEVER** operate the transceiver with a headset or other audio accessories at high volume levels.

**DO NOT** Push the PTT when not actually desiring to transmit.

**AVOID** using or placing the transceiver in direct sunlight or in areas with temperatures below  $-30^{\circ}\text{C}$  ( $-22^{\circ}\text{F}$ ) or above  $+60^{\circ}\text{C}$  ( $+140^{\circ}\text{F}$ ).

**DO NOT** Modify the transceiver for any reason.

### FCC CAUTION:

Changes or modifications to this device, not expressly approved by Qixiang, could void your authority to operate this transceiver under FCC regulations.

---



---

---

Thank you very much for purchasing this excellent transceiver. We adopt the advanced technology, it has been tested carefully at our factory for your long term use.

Please read this manual completely to learn all functions. We made efforts to write this manual to be as comprehensive and easy to understand as possible. Please note that some of the operations may be explained in previous chapters. So if you read just one part of the manual, you may not understand the complete explanation of the function.

## Precautions

---

Please observe the following precautions to prevent fire, personal injury, and/or transceiver damage:

- ⚠ Do not attempt to use your transceiver while driving; it is simply too dangerous.
- ⚠ This transceiver is designed for a 13.8 V power source.  
Never use a 24 V battery to power the transceiver.
- ⚠ Do not place the transceiver in excessively dusty, humid or wet areas, nor on unstable surfaces.
- ⚠ Please make it away from interferential devices (such as TV, generator etc.) when interfering by external.
- ⚠ Do not expose the transceiver to long periods of direct sunlight nor place it close to heating appliances.
- ⚠ If an abnormal odor or smoke is detected coming from the transceiver, turn OFF the power immediately. Ensure the transceiver is safe, then send it to service station for examination.
- ⚠ Do not transmit with high output power for extended periods; the transceiver may overheat.

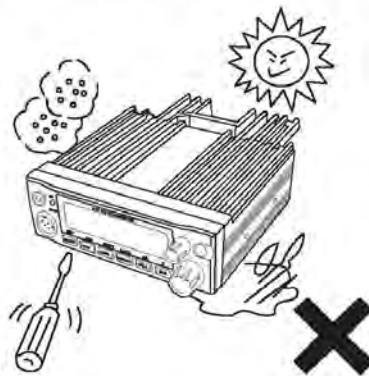

---

Please contact the local authorized dealer if you have any questions. We are not responsible for any typographical errors that may be in this manual. Standard accessories may change without notice, getting your understanding for any inconveniences.



*Your need  
is our service purpose!*

<b>1. Function And Feature</b> .....	1
<b>2. Accessories</b> .....	2
Supplied Accessories .....	2
Optional Accessories .....	2
<b>3. Initial Installing</b> .....	3~7
Mobile Installation .....	3
DC Power Cable Connection .....	4
Mobile Operation .....	4
Fixed Station Operation .....	5
Replacing Fuses .....	6
Power Supply Voltage Display .....	6
Antenna Connection .....	6
Accessory Connections .....	7
External speaker .....	7
Microphone .....	7
<b>4. Getting Acquainted</b> .....	8~11
Front Panel .....	8
Rear Panel .....	9
Screen .....	10
Microphone .....	11
<b>5. Operating Basics</b> .....	12~19
Switching The Power ON/OFF .....	12
Adjusting The Volume .....	12
Adjusting The Squelch .....	12
VFO Mode .....	12
Change Frequency By Channel Stepping .....	13
Change Frequency By 1MHz Stepping .....	13
Change Channel Stepping .....	13
Operating Through Repeaters .....	14
Offset Programming Flow .....	14
Setting Offset Direction And Offset Frequency .....	14
CTCSS/DCS/2-TONE/5-TONE Setting .....	15
2-TONE/5-TONE(Optional) .....	16
DTMF .....	16
Memory Channels .....	16
Memory Channels Programming .....	17
Programmable data in memory channels .....	17
Call Mode .....	18
Receiving Signals .....	18
Transmitting Signals .....	18
<b>6. Parameter Setting</b> .....	19~22
Parameter Setting Mode .....	19

## Contents

---

Details Of The Features In Menu-----	19
Channel Step Setting -----	20
Scanning Type -----	20
Beep Sound -----	20
Time-Out Timer -----	20
TOT Resuming Time-----	21
APO-Auto Power OFF -----	21
Tone-Burst Frequency -----	21
Busy Channel Lockout -----	21
Burglar Alarm -----	21
Alphanumeric Tag-----	22
Dimmer-----	22
<b>7. Advanced Operations-----</b>	<b>23~29</b>
Scan-----	23
VFO Scan -----	23
Memory Scan-----	23
Program Scan -----	23
CTCSS Scan-----	24
DCS Scan-----	24
Key-Locked Function-----	25
Tone burst -----	25
Wide/Narrow Band-----	25
Compander Function-----	25
Scrambler (Optioanl)-----	25
ANI Function -----	25
Auto-Dialer -----	26
Burglar Alarm-----	26
Cable Clone -----	28
Programming Data By PC-----	29
<b>8. Microphone Operation -----</b>	<b>30~31</b>
Keys' Instruction -----	30
Functions Chart-----	30
Inputting Frequencies-----	31
<b>9. Maintenance -----</b>	<b>32</b>
Reset -----	32
How To Reset-----	32
Default Setting After Resetting-----	32
Trouble Shooting-----	32
<b>10. Specifcation -----</b>	<b>33</b>

# **1. Function And Feature**

---

This new transceiver has many world advanced and reliable functions; it represents the innovation and practically principle of **QIXIANG** Company. Functions as follows:

- Display on a large LCD with adjustable brightness, convenient for nighttime use. Three different displaying modes are available, including Frequency Mode, Frequency +Channel Mode and Channel Mode.
- Distribute buttons reasonably, convenient for operation. Adopt superior quality material, better technology and high quality radiator to ensure stable and durable operation.
- 100 programmable memorized channels + 1 called channel, identified by letters and numbers.
- CTCSS/DCS encode/decode per channel (can be different encode/decode tones), rejecting extra calling from other radios.
- Various scan functions, including CTCSS/DCS scan function.
- With 2-Tone, 5-Tone and DTMF encoding/decoding function, use 5-Tone to have Send Message, Emergency, Call all, ANI, Stun, Waken, etc.
- Automatic Numbering Identification function by DTMF/ANI or 5-Tone/ANI.
- scramble function ( Optional ).
- Can set compander ON/OFF.
- Can set different band width; wide band: 25K, narrow band 12.5K.
- Burglar alarm providing extra safety.

## 2. Supplied And Optional Accessories

### Supplied Accessories

After carefully unpacking the transceiver, identify the items listed as below. We recommend you keep the box and packing.

- ST-5188 Transceiver [QX-01B]
- Microphone QMP-01 (with DTMF keypad)
- Mobile installing bracket [QMB-01]

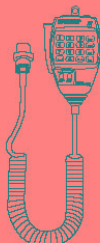
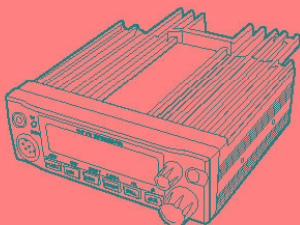

- DC power cable with fuse holder [QPL-01]
- Alarm cable A (with wire) [QL-01(A)]
- Alarm cable B (extension use) [QL-01(B)]

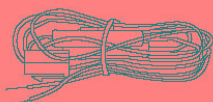

#### Hardware kits for bracket

Black screws (M4\*8mm)  
4 pcs. (QSS-01A)



Tapping Screws (M5\*20mm)  
4 pcs. (QSS-01)



Screws (M5\*20mm)  
4 pcs. (QSS-01C)



Washer S-washer  
(QSS-01D)



Hexagonal nut (M5)  
4 pcs. (QSS-01E)



Spare fuses (a pair)  
2 pcs. (QF-01)



Small wrench (spanner)  
(QW-01)



#### User's Manual

The standard accessories may vary slightly depending on the version you have purchased. Please contact the local authorized **QIXIANG** dealer should you have any questions. **QIXIANG** and authorized dealer are not responsible for any typographical errors there may be in this manual. Standard accessories may change without notice.

### Optional Accessories

- Wired copy cable (QXPL-01)

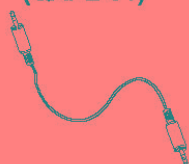

- Cigar lighter (QCC-01)



- Regulated power supply (QRP-01)

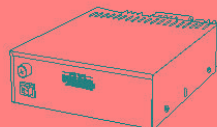

- Car antenna (QCA-01)

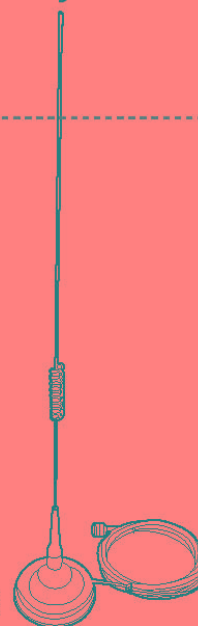



# 3. Initial Installing

## Mobile Installation

To install the transceiver, select a safe, convenient location inside your vehicle that minimizes danger to your passengers and yourself while the vehicle is in motion. Consider installing the unit at an appropriate position so that knees or legs will not strike it during sudden braking of your vehicle. Try to pick a well ventilated location that is shielded from direct sunlight.

1. Install the mounting bracket in the vehicle using the supplied self-tapping screws (4 pcs), flat washers (4 pcs).

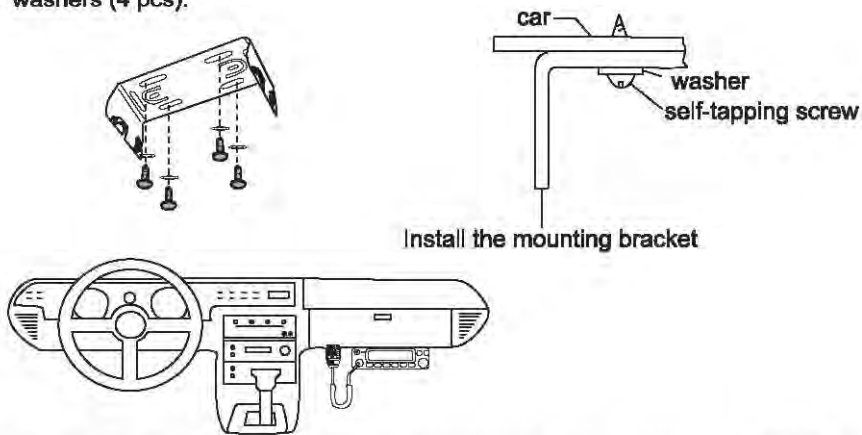

2. Position the transceiver, then insert and tighten the supplied hexagon SEMS screws (4) and flat washers (4).

- Double check that all hardware is tightened to prevent vehicle vibration from loosening the bracket or transceiver.

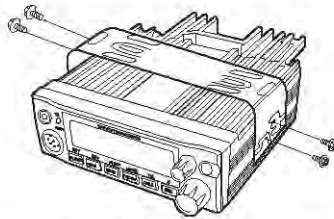

- Determine the appropriate angle of the transceiver, using the 3 screw hole positions on the side of the mounting bracket.

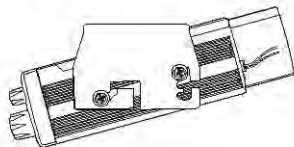
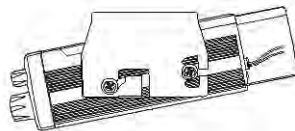
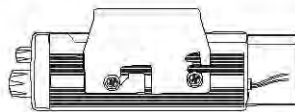

## 3. Initial Installing

### DC Power Cable Connection

**NOTE:** Locate the power input connector as close to the transceiver as possible.

#### **【Mobile Operation】**

The vehicle battery must have a nominal rating of 12 V. Never connect the transceiver to a 24 V battery. Be sure to use a 12 V vehicle battery that has sufficient current capacity. If the current to the transceiver is insufficient, the display may darken during transmission, or transmit output power may drop excessively.

1. Route the DC power cable supplied with the transceiver directly to the vehicle's battery terminals using the shortest path from the transceiver.
  - If using a noise filter, it should be installed with an insulator to prevent it from touching metal on the vehicle.
  - We recommend you do not use the cigarette lighter socket as some cigarette lighter sockets introduce an unacceptable voltage drop.
  - The entire length of the cable must be dressed so it is isolated from heat, moisture, and the engine secondary (high voltage) ignition system/ cables.
2. After the cable is in place, wrap heat-resistant tape around the fuse holder to protect it from moisture and tie down the full run of cable.
3. To prevent the risk of short circuits, disconnect other wiring from the negative (-) battery terminal before connecting the transceiver.
4. Confirm the correct polarity of the connections, then attach the power cable to the battery terminals; red connects to the positive (+) terminal and black connects to the negative (-) terminal.
  - Use the full length of the cable without cutting off excess even if the cable is longer than required. In particular, never remove the fuse holders from the cable.

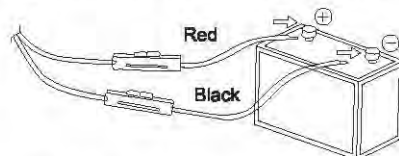

5. Reconnect any wiring removed from the negative terminal.
6. Connect the DC power cable to the transceiver's power supply connector.
  - Press the connectors firmly together until the locking tab clicks.

