

3. Initial Installing

If set the ignition-key ON/OFF (optional feature), use the optional QCC-01 (For direct connection to the circuit on the vehicle or for a cigar plug connection) cable. Connect one of the cables between the ACC terminal or a cigar plug that operates with the vehicle ignition or ACC switch on the vehicle power jack on the rear side of the unit. (**NOTE: In many cars, the cigar-lighter plug is always powered. In this case, you cannot use it for the Ignition-key ON/OFF function.**) If set this function on, the unit can be turned ON/OFF either manually or automatically in accordance with the ignition-key position.

1. When the ignition-key turns to ACC (speed up) or ON(start) and the radio is power off, the power switch lights on. It turns off when the ignition key is turned to be off. To turn on the unit, press the power switch while it is on.(while ignition key is at ACC or ON)
2. When the ignition-key turns to ACC (speed up) or ON (start) and the radio is power on,the unit turns on automatically and the power switch light on. Turn the ignition-key to OFF or manually turn the power switch off to shut down the radio.

The power consumption when using the additional cable is 5 mA.

For operation without this function, use the power switch to turn the unit ON/OFF.

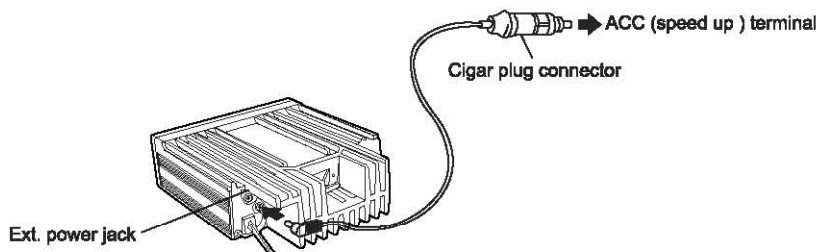

【Fixed Station Operation】

In order to use this transceiver for fixed station operation, you will need a separate 13.8 V DC power supply (not included). **QIXIANG** Co. offers excellent communication power supply as optional accessory[QRP-01], please contact the local authorized **QIXIANG** distributor.

The recommended current capacity of your power supply is 12 A.

1. Connect the DC power cable to the regulated DC power supply and ensure that the polarities are correct (Red: positive, Black: negative).
 - Do not directly connect the transceiver to an AC outlet.
 - Use the supplied DC power cable to connect the transceiver to a regulated power supply.
 - Do not substitute a cable with smaller gauge wires.

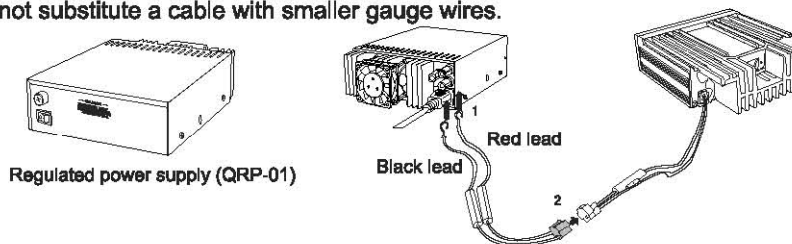

2. Connect the transceiver's DC power connector to the connector on the DC power cable.
 - Press the connectors firmly together until the locking tab clicks.

NOTE:

- ◆ Before connecting the DC power supply to the transceiver, be sure to switch the transceiver and the DC power supply OFF.
- ◆ Do not plug the DC power supply into an AC outlet until you make all connections.

3. Initial Installing

[Replacing Fuse]

If the fuse blows, determine the cause, then correct the problem. After the problem is resolved, replace the fuse. If newly installed fuse continues to blow, disconnect the power cable and contact your authorized **SoonTone**® dealer or an authorized **SoonTone**® service center for assistance.

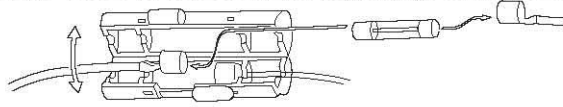

Fuse Location	Fuse Current Rating
Transceiver	15A
Supplied Accessory DC power cable	20A

Only use fuse of the specified type and rating; otherwise the transceiver could be damaged.

NOTE: If you use the transceiver for a long period when the vehicle battery is not fully charged, or when the engine is OFF, the battery may become discharged, and will not have sufficient reserves to start the vehicle. Avoid using the transceiver under these conditions.

Power Supply Voltage Display

After connecting the transceiver to the power supply, the supply voltage can be confirmed by pressing SQL and FUNC at the same time. The supply voltage displays on the screen. The transceiver will return to normal operation when the power is OFF. The display immediately changes as the voltage supply changes. It also displays voltage during transmission.



[IMPORTANT] The range of the displayed voltage is only from 7V-16V. Because of the displayed value is estimated, please use a voltmeter when a more precise reading is desired.

Antenna Connection

Before operating, install an efficient, well-tuned antenna. The success of your installation will depend largely on the type of antenna and its correct installation. The transceiver can give excellent results if the antenna system and its installation are given careful attention.

Use a 50Ω impedance antenna and low-loss coaxial feed line that has a characteristic impedance of 50Ω, to match the transceiver input impedance. Coupling the antenna to the transceiver via feed lines having an impedance other than 50Ω reduces the efficiency of the antenna system and can cause interference to nearby broadcast television receivers, radio receivers, and other electronic equipment.

NOTE:

- ◆ *Transmitting without first connecting an antenna or other matched load may damage the transceiver. Always connect the antenna to the transceiver before transmitting.*
- ◆ *All fixed stations should be equipped with a lightning arrester to reduce the risk of fire, electric shock, and transceiver damage.*

There are many possible antenna locations on a car. Four of the most popular are shown and discussed on the following:

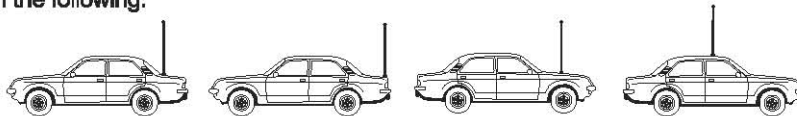

3. Initial Installing

Accessory Connection

【External speaker】

If you plan to use an external speaker, choose a speaker with an impedance of 8Ω . The external speaker jack accepts a 3.5 mm (1/8") mono (2-conductor) plug.

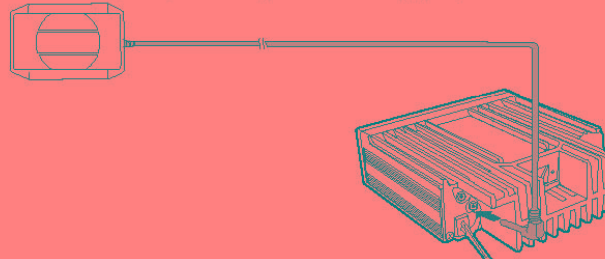

NOTE: External speaker adopt BTL double ports as output, please care about the connecting way. The speaker can not connect with the ground, otherwise the speaker will be fault. The wrong connecting way as the following picture:

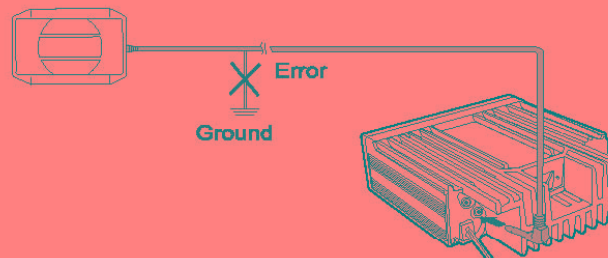

【Microphone】

For voice communications, connect a microphone equipped with an 8-pin modular plug into the modular socket on the front of the main unit. Press firmly on the plug until the locking tab clicks.

Attach the supplied microphone hanger in an appropriate location using the screws included in the screw set.

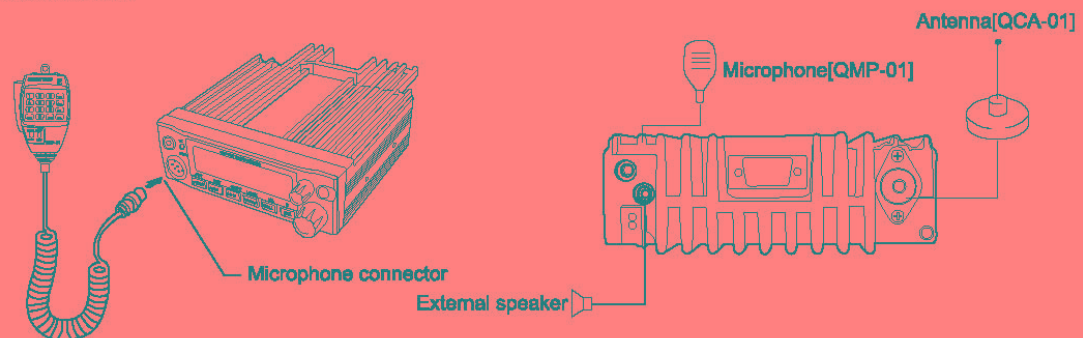

4. Getting Acquainted

Front Panel

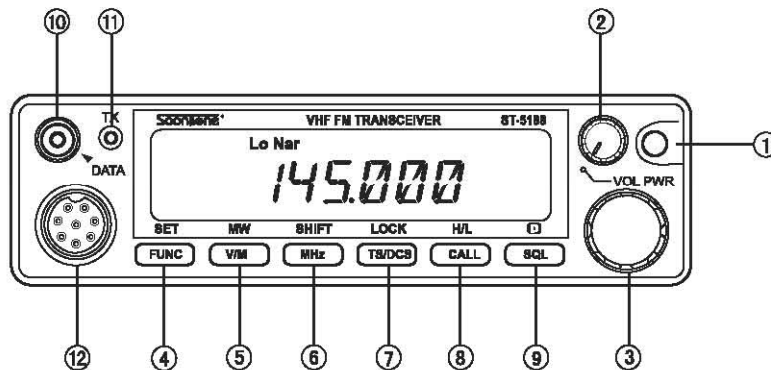

• Primary Function

No.	Key	Function
1	PWR (Power)	Power ON/OFF
2	VOL(Volume switch)	Adjust volume key
3	Main Dial	Change frequency, memorized channel and scan direction etc.
4	FUNC•SET	Function key
5	V/M • MW	Switches between VFO mode and memory mode
6	MHZ • SHIFT	Step key (step: 1 MHz)
7	TS/DCS • LOCK	Set CTCSS and DCS value
8	CALL • H/L	Call key
9	SQL •	Squelch adjusting key
10	Data Terminal	Data reading/writing, clone and burglar alarm functions
11	TX	Indicates when transmitting
12	Mic. Connector	Connection port for supplied microphone

• Press FUNC, the functions can be activated while appears.

No.	Key	Function
4	FUNC•SET	Confirm to choose function and exit the functions
5	V/M • MW	Store data to memory channels
6	MHZ • SHIFT	Set direction and frequency of offset frequency
7	TS/DCS • LOCK	Set key lock function
8	CALL • H/L	Switch between HI, MID and LOW power transmission
9	SQL •	Enter into the compander communication mode

4. Getting Acquainted

- Set function by pressing FUNC and one of the following keys at the same time

No.	Key	Function
1	PWR	Reset to default setting
5	V/M • MW	Delete the channel memory
6	MHZ • SHIFT	Switch between wide/narrow band
7	TS/DCS • LOCK	Set the auto dialer
8	CALL • H/L	Enter clone data function mode
9	SQL • D	Enter the power supply voltage indication mode

- Set functions by pressing the keys continuously

No.	Key	Function
4	FUNC • SET	Press and hold for 2 seconds to enter the setting mode
9	SQL • D	Press and hold for more than 1 second to monitor function

Rear Panel

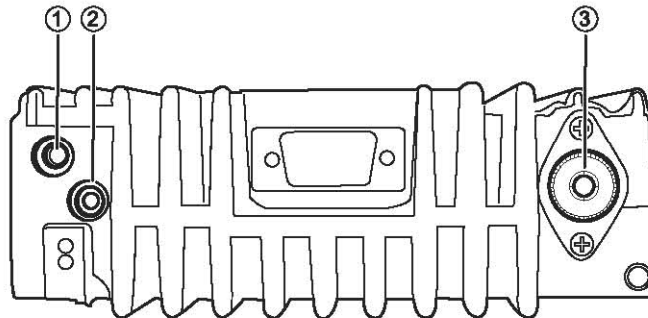

No.	Key	Function
1	Ext. Speaker Terminal	Terminal for optional external speaker
2	Ext. Power Jack	Terminal for connecting optional cable for use with ignition key on/off function
3	Antenna Connector	Use for connecting the 50 ohm coaxial cable with antenna

4. Getting Acquainted

Screen

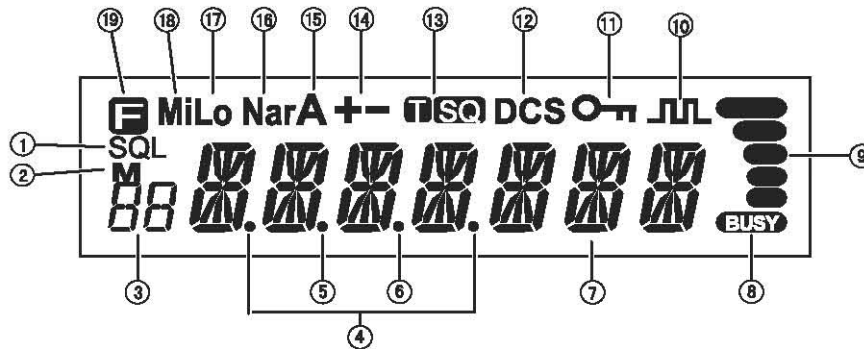

No.	Icon	Function
1	SQL	Appears when setting the squelch level
2	M	Appears when in memory mode
3	88	Indicates the memory channel number in memory mode
4	.Decimal point	Appears when setting the burglar alarm function
5	.Decimal point	Appears when setting the skip level
6	.Decimal point	Indicates the dicimal point of frequency and the scanning function
7	8888888	Indicates the frequency or memory name
8	BUSY	Appears when a signal is being received and monitor function is ON
9	S-meter	Indicates the relative signal strength of transmtting and receiving
10	JLL	Appears when in compander mode
11	Key lock	Appears when setting the key lock function
12	DCS	Appears when setting the DCS function
13	CTCSS	Appears when setting CTCSS
14	+ -	Appears when setting direction of offset frequency
15	A	Indicates scramble
16	Nar	Indicates narrow band
17	Lo	Indicates low power
18	ML	Indicates medium power
19	FUNC Key	Appears when pressing FUNC Key

4. Getting Acquainted

Microphone

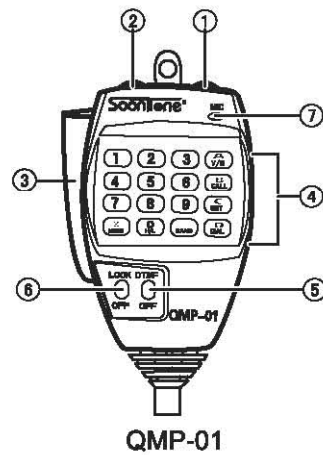

No.	Key	Function
1	Up	Increase frequency value, memory channel serial number, or setting value
2	Down	Decrease frequency value, memory channel serial number, or setting value
3	PTT	Push-To-Talk, get into transmitting state
4	DTMF	Set functions, input VFO frequency or dial DTMF, etc.
5	DTMF OFF	Switch between dual-tone frequency dialing and function operating
6	LOCK OFF	Key lock (Lightening turns off when locking)
7	MIC	Speak here during transmitting

Mic. Connector Diagram (While looking in the front view of the connector)

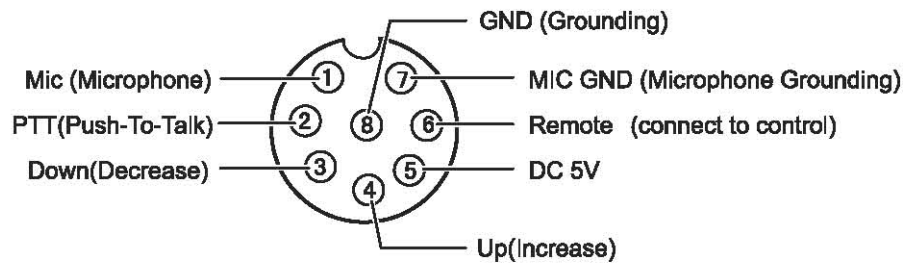

5. Operating Basics

Switching The Power ON/OFF

Press the power switch or turn the ignition key to ACC (speedup) or ON (startup) according to the selected mode when installed to power ON. Press again the power switch or turn the ignition key to OFF to power OFF.

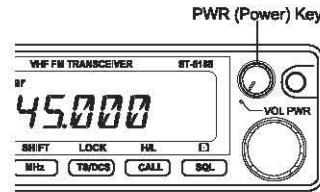

Adjusting The Volume

Turn the VOL control clockwise to increase the audio output level and counterclockwise to decrease the output level. Set it at the desired level.

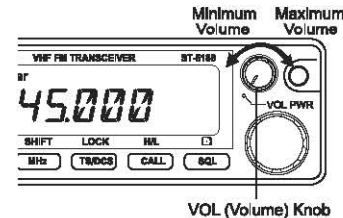

Adjusting The Squelch

The purpose of Squelch is to mute the speaker when no signals are present. With the squelch level correctly set, you will hear sound only while actually receiving signals. The higher the selected squelch level, the stronger the signals must be received. The appropriate squelch level depends on the ambient RF noise conditions.

1. Press **SQL** Key. SQL icon displays on the screen and the squelch level will be shown where the memory number is displayed. 21 levels total (from 0 to 20) "0" is the lowest setting value.

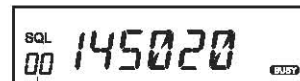

Squelch Level

2. Adjust desired squelch level by turning the main dial or by using the **UP/DOWN** keys on the microphone. To return to normal use mode, press **PTT** or any key on the front panel, or if there are no operations within five seconds, the unit will store the setting and will return to its original status.

The new squelch level will be stored in the CPU until another adjustment is done.

VFO Mode

VFO tuning is set as a default mode at the factory. VFO (Variable Frequency Oscillator) allows you to change the frequency in accordance with the selected channel step as you rotate the main dial or by using the **UP/DOWN** keys on the microphone. VFO mode is also used to program the data to be stored in the memory channels.

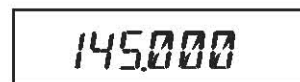

VFO Mode

1. Identify the current mode by checking the screen. If "M" or "C" icon is NOT displayed on it, the unit is already in the VFO mode.

2. Otherwise press **V/M** key until those icons are gone.

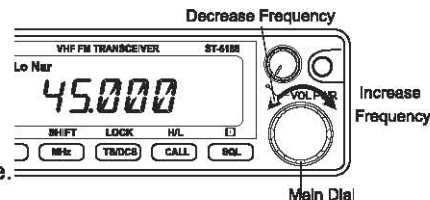

5. Operating Basics

【Change Frequency By Channel Stepping】

Turn the main dial clockwise to increase the frequency value, counterclockwise to decrease. The UP/DOWN keys on the microphone act in the same way.

【Change Frequency By 1MHz Stepping】

This will enable a quick change of frequency in 1 MHz steps:

1. Press MHz key. The digits after 100KHz will disappear on the screen.

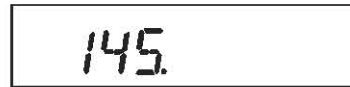

2. Turn the main dial or press UP/DOWN key on Mic.

Change Channel Stepping

1. Be sure the unit is in VFO mode. Refer to page 23 to enter the SET mode.

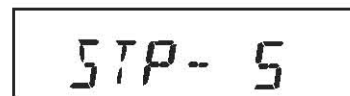

Displaying channel stepping

2. Select the channel step parameter setting by using the tuning knob. The current channel step will be displayed as below.

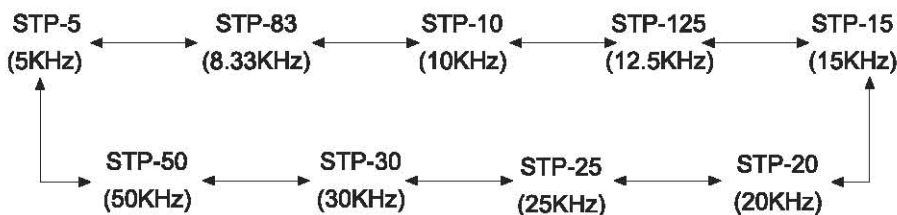

3. Press PTT or any key except SQL on the front panel to enter the desired step into memory. The screen will then return to the original status.

NOTE: Settings below 10KHz may be automatically corrected according to the selected step.

Operating Through Repeaters

Repeaters, which are often installed and maintained by radio clubs, are usually located on mountain tops or other elevated locations. They generally operate at higher ERP (Effective Radiated Power) than a typical station. This combination of elevation and high ERP allows communications over much greater distances than communicating without using repeaters.

Most repeaters use a receive and transmit frequency pair with a standard or non-standard offset (odd-split). In addition, some repeaters must receive a tone from the transceiver to be accessed. For details, consult your local repeater reference.

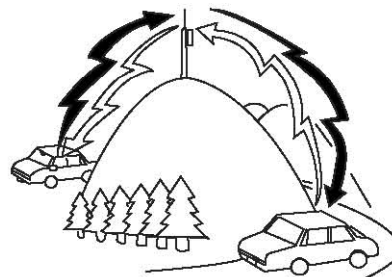

TX: 144.725MHz
TX Tone: 88.5Hz
RX: 145.325MHz

TX: 144.725MHz
TX Tone: 88.5Hz
RX: 145.325MHz

5. Operating Basics

【Offset Programming Flow】

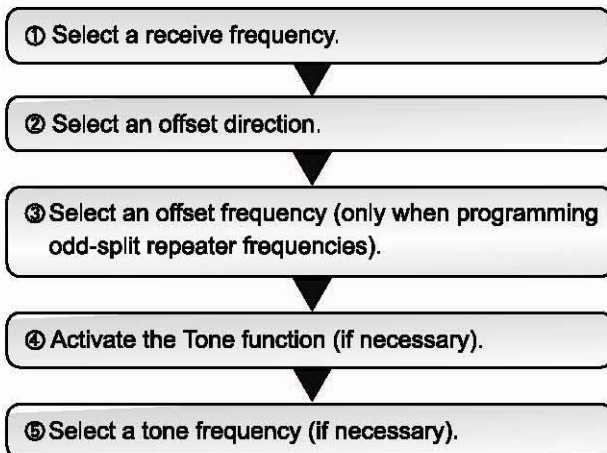

If you store all the above data in a Memory Channel, you will not need to reprogram the parameters every time. Refer to "MEMORY CHANNELS".

【Setting Offset Direction And Offset Frequency】

Repeater receives a signal (UP-LINK) on the frequency and re-transmits on another (DOWN-LINK). The difference between these two frequencies is called the offset frequency. The default offset frequency on VHF band is 600 kHz; the default offset frequency on UHF band is 5.0 MHz. If the UP-LINK frequency is higher than the DOWN-LINK frequency, the shift direction is positive, and if it is lower, the shift direction is negative. The offset is variable between 0 to 99.995MHz on this unit.

Press the **FUNC** key. While the screen displays "  " icon, press **MHz** key. Screen shows the current status of offset direction and offset frequency. The default value is 0.60 MHz (600KHz) in the negative direction. Press **MHz** key until the desired offset direction is set. If **SIMPLEX** mode (without changing transmit and receive frequency) is desired, select the position where both - and + icons disappears.

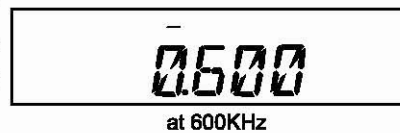

1. Turn the dial or use **UP/DOWN** keys on the microphone to change the offset frequency. It changes in accordance with the channel step setting value.
2. In this mode, if press the **FUNC** key again, the offset frequency can be changed in 1 MHz steps for faster setting.
3. Press any other key except **FUNC** or **MHz** to return to the original status.

