

## 5. Operating Basics

### CTCSS/DCS/2-TONE/5-TONE Setting

Many repeaters have CTCSS(Continuous Tone Code Squelch System) or DCS(Digital Coded Squelch) as a "key" to access the system, so-called "selective call". The audio can be heard ONLY when the matching CTCSS tone/DCS code signal is received. The combination of CTCSS squelch and DCS function is not available, only one or the other may be used for a given memory channel. But 5-TONE/2-TONE can combine with CTCSS/DCS to use, DTMF/ANI, 5-Tone/ANI function can show the calling code of the opposite party.

1. Press **TS/DCS** key. The current setting will display with T/SQ/DCS icons and relative frequency/code. Press the same key to select T/SQ/DCS setting.
2. The numbers (such as 88.5) represent the CTCSS frequency in Hz. When it is displayed with "T" only, the unit transmits CTCSS (encode) infrasonic frequency tone when pressing PTT (encode) and the repeater access is enabled (assuming the repeater is using 88.5)
3. Press the same key again so that "SQ" shows on the screen. This is the CTCSS decode frequency. This enables CTCSS squelch (or tone squelch, TSQ)
4. Press it again so that "DCS" icon, normal code and inverted code of DCS are displayed. Normal code icon is 023N; inverted code icon is 023I. They enable DCS encoding and decoding.

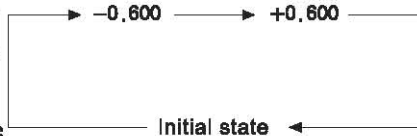

For item 2-4, turn the main dial or press the **UP/DOWN** keys to change CTCSS or DCS normal and inverted codes. Press any key (except **TS/DCS, UP/DPWN** keys) to confirm to enter the setting and return to original status. The TS/SQ/DCS icon will remain on the screen to show the current status. To exit, simply press the **TS/DCS** key until the relative status icon T/TQ/DCS disappears.

The CTCSS encoding and decoding frequencies may be set differently. The encode setting frequency automatically relates to the decode setting, but decode setting does not affect encode. The standard set of 50 different CTCSS tones are available as shown on the chart below. DCS encode/decode cannot be separated and are selectable from 104 codes as shown below.

67.0	69.3	71.9	74.4	77.0	79.7
82.5	85.4	88.5	91.5	94.8	97.4
100.0	103.5	107.2	110.9	114.8	118.8
123.0	127.3	131.8	136.5	141.3	146.2
151.4	156.7	159.8	162.2	165.5	167.9
171.3	173.8	177.3	179.9	183.5	186.2
189.9	192.8	196.6	199.5	203.5	206.5
210.7	218.1	225.7	229.1	233.6	241.8
250.3	254.1				

CTCSS Tone Frequency (Hz)

023	025	026	031	032	036	043	047	051	053	054
065	071	072	073	074	114	115	116	122	125	131
132	134	143	145	152	155	156	162	165	172	174
205	212	223	225	226	243	244	245	246	251	252
255	261	263	265	266	271	274	306	311	315	325
331	332	343	346	351	356	364	365	371	411	412
413	423	431	432	445	446	452	454	455	462	464
465	466	503	506	516	523	526	532	546	565	606
612	624	627	631	632	654	662	664	703	712	723
731	732	734	743	754						

DCS Code

## 5. Operating Basics

### 2-TONE/5-TONE (Optional)

2-Tone, 5-Tone code is similar to the function of CTCSS/DCS, as a "key" to access the system, so-called "selective call". And 5-Tone code also has special call function, including Send Message, Emergency, Call all, ANI, Stun, Waken, etc.

- When a certain channel has set 2-Tone, only when suited 2-tone has been received, the function can be performed, and open squelch.
- When a certain channel has set 5-Tone, only when suited 5-tone has been received, the function can be performed, and open squelch.
- When a certain channel has set 2-Tone and CTCSS or DCS, only when suited 2-tone and CTCSS or DCS have been received, the function can be performed as the two conditions met together, and open squelch.
- When a certain channel has set 5-Tone and CTCSS or DCS, only when suited 5-tone and CTCSS or DCS have been received, the function can be performed as the two conditions met together, and open squelch.

### DTMF

This transceiver provides you 8 SPR storage, C0 is DTMF number of transceiver. C1-C6 can be DTMF number, combined number or number of the opposite party. CP is the last received opposite code, which is a temporarily station, and can't be changed. The default value: 000

#### NOTE:

1. In long distance, when signal is weak, the incoming DCS coded-signal may have deviation, and then your transceiver may not turn on DCS squelch. If it occurs, please press **TS/DCS** key to get into setting mode and press **CALL** key, a decimal point appears on the 10 MHz order, at this moment, if DCS squelch has been turned on once, even if the DCS code deviation is large or signal is weak transmitted by opposite party, DCS squelch will always be ON state. When DCS code value has been changed, DCS squelch will be OFF. To exit this setting please press **CALL** key again, decimal point disappearing on the 10 MHz order indicates to exit, and press again any keys except **CALL** key to back to original state. This setting can also be stored in a certain memory channel.

2. DTMF/ANI/2-Tone/5-Tone only can be preset by programming software, to invoke or switch them please consult microphone operation(P34).

### Memory Channels

In Memory Channels, you can store frequencies and related data that you frequently use so that you do not need to reprogram that data every time. You can quickly recall a programmed channel through simple operation.

The memory mode on this transceiver provides up to 100 channels (0-99), 1 call (quick recall channel) and a pair of program-scan "edge memory" channels for quick, easy access to the pre-programmed frequencies with different parameter settings.

1. Press **V/M** key. "**M**" appears on the screen to indicate that the unit is in the memory mode. Repeat to switch the mode between VFO and memory.
2. In memory mode, turn the main dial or press **UP/DOWN** keys to change the memory channel number.
3. If change the number by units of 10, press **FUNC** and rotate the main dial or press **UP/DOWN** keys while "**M**" displays on the screen.



## 5. Operating Basics

---

### **【Memory Channels Programming】**

1. Return to VFO mode by pressing **V/M** key. In this mode, program the desired frequencies and relative data. About CTCSS frequency and DCS code please refer to the settings on forenamed list.



Channel has entered

2. When all the settings are complete, press **FUNC** key. "M" and "M" appears and a memory channel number will be indicated on the screen.



Channel has not entered(empty)

3. Turn the main dial or press the **UP/DOWN** keys to select the desired memory channel number into which the current VFO settings will be stored. An empty channel is shown with a flashing "M". It may be a good practice to allocate memory channels in order, such as 0-9 for local repeaters, 10-19 local simplex, 20-49 repeaters within the area, 50-79 for reserve, 80-98 simplex reserve. It makes references easier for the operation and future modifications of the memory channels.
4. While "M" displays on the screen press **V/M** key. The VFO settings are stored to the memory channel and a beep will sound. The memory channel can be over-written if a previously programmed channel is selected (the memory channels shown with stab M).
5. To program the CALL channel (quick recall) select the channel shown with C icon on the screen. Save CH-99 to store the setting used for the Alarm operation, which will be explained later. Use PL and PH for Program scan setting, which will be explained in the Advanced Operations chapter.
6. To delete a programmed channel, select it in memory mode, press **FUNC** key then press the **V/M** key while "M" is on. The memory is deleted and a beep sounds. The "M" starts flashing showing that this channel is now empty.
7. To cancel "Delete", repeat 6. However, the cancel function becomes impossible once the channel or the mode is changed.

### **【Programmable data in memory channels】**

Some features will be explained later, so please read this instruction manual thoroughly prior to programming memories. Memory channels (including 0-99 and CALL) can store following.

- Frequency
- Offset Frequency
- Offset Direction
- CTCSS Tone both Encode and Decode
- DCS Code (Encode and Decode)
- Scan Skip Channel
- Busy Channel Locked Setting
- Prior Monitoring Frequency (PC programming required)
- Normal/Narrow FM Width
- 2-Tone/5-Tone code

---

#### **NOTE:**

1. In the programmed memory channels, you only can temporarily modify or delete some certain parameter values.
  2. Only the frequency can be stored in PH and PL channels to determine the edges of the program scan range.
-

## 5. Operating Basics

### Call Mode

This is a memory mode that allows the ST-5188 Transceiver to quickly recall the assigned memory channel by simply pressing the **CALL** key, regardless of the current status of the unit.

Default CALL frequency: 145.00MHz

1. Press **CALL** key. The C icon appears on the screen and the transceiver enters the CALL mode. In this mode, the main dial or the **UP/DOWN** keys cannot change the frequency or memory channels.
2. Press **CALL** key again or press **V/M** key to exit CALL mode.
3. No scan functions are available in CALL mode.



To store a desired setting in the CALL channel, follow the memory mode programming instructions and assign your selected settings to memory channel C. The call channel can be modified but cannot be eliminated or hidden.

### Receiving Signals

1. Be sure to have connected the unit with the appropriate antenna, powered on, set the audio volume and squelch level properly.
2. Select the desired receiving frequency or scanning different frequencies to monitor ongoing communications. The S-meter shows relative signal strength between BUSY and FULL when the transceiver detects an incoming signal.
3. If the S-meter indicates an incoming signal but nothing is heard from the speaker, check audio level, squelch level, and CTCSS/DCS decoding status, which are explained elsewhere in this manual.
4. The Monitor function is available to receive weaker signals. Press and hold **SQL** key for more than 1 second. Regardless of the squelch, it will be opened and "**BUSY**" displays on the screen. Press any key on the front panel to exit.

### Transmitting Signal

1. Select the desired frequency. Be sure that you are authorized to operate on the selected frequency. Check the system and monitor the frequency to make sure that you are not going to disturb any ongoing communication.
2. Select the output power. Press **FUNC** key and then press **CALL** key while "**Lo**" displays on the screen. As the **CALL** key is pressed, the output power changes among 3 levels. The "**Lo**" stands for **LOW** power setting, "**Mi**" for **MEDIUM** power. When the transceiver is set at **HIGH** power, no icon will display. The output power level cannot be changed during transmission.
3. Default setting is High power. Press the **PTT** key on the microphone to transmit, release it to receive. During transmission, the relative power output is shown on the S-meter as:

**LOW power = 2 segments**

**MID power = 3 segments**

**HIGH power = 5 segments**

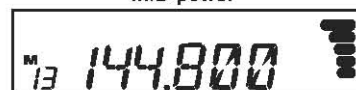
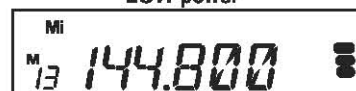

# 6. Parameter Setting

**[IMPORTANT]** Please read the following content thoroughly before changing any parameters.

By entering the Parameter Setting mode, some of the transceiver's operating parameters can be changed to suit your application. The following is the Selectable Parameters' Menu.

**NOTE:**

- 1. The Alphanumeric Channel Tag setting will not appear in the menu until memories have been programmed first !
- 2. Only in VFO mode, the setting value of channel spacing step will appear in MENU.

## Parameter Setting Mode

1. Press **FUNC** key for more than 2 seconds to enter the Parameter Setting. Use **SQL** key or **UP/DOWN** keys to select menu.



Default setting

2. Rotate the main dial to select the desired settings.
3. Press **SQL** or **UP/DOWN** keys again to enter the selected setting into the radio's memory. The transceiver is now ready for additional Parameter adjustment.
4. Press any other key except **SQL/UP/DOWN** to exit the Parameter mode. The only exception is the Channel Tag setting which accepts only **PTT, FUNC, MHz** and **TS/DCS** keys to exit.

## Detail Of The Feature In Menu

Please refer to "Parameter Setting" for setting operations. The operation procedures of some features are explained later in detail.

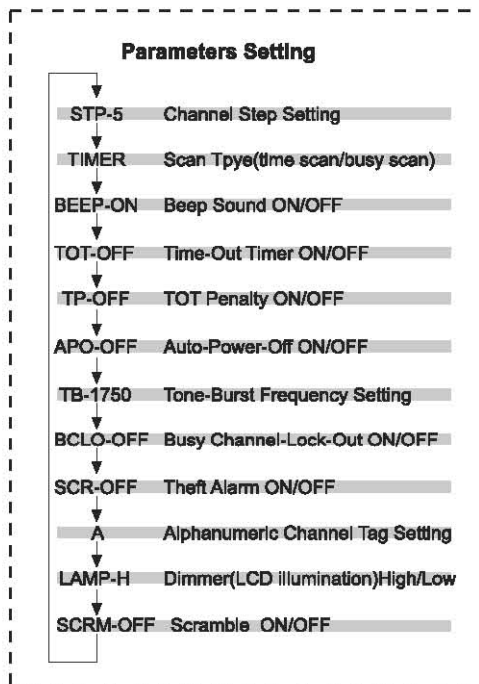

## 6. Parameter Setting

### Channel Step Setting

This is to select the channel step to be used in the VFO (Variable Frequency Oscillator) mode. Refer to the chart below for the relation of the actual step frequency and how it is displayed.

STP-5

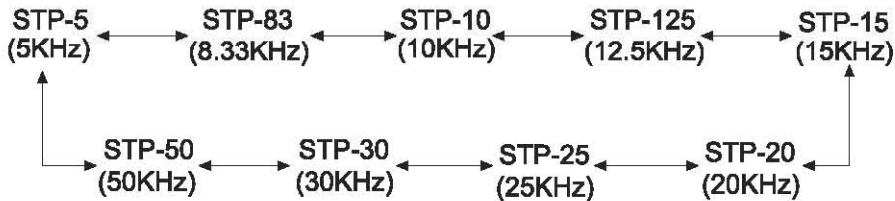

### Scanning Type

This is to select the scan resume condition. TIMER (calculagraph) setting allows the radio to resume scanning after 5 seconds, regardless of the signal receiving status, BUSY setting resumes scanning when the received signal has gone. The scan mode will be explained later.

TIMER

### Beep Sound

BEEP-ON setting enables a beep that sounds after some keys are touched and/or setting is done. BEEP-OFF shows that the beep function is off.

BEEP-ON

### Time-Out Timer

The TOT feature is popular in repeater systems. It prohibits the users from transmitting after a certain period of time. By setting this function and activating it according to the repeaters' requirement, the radio alerts the user by a beep 5 seconds before stop transmitting. When the time is expired, transmitting stops and the transceiver automatically returns to receiving mode. This avoids the repeater going into its TOT mode. Until the PTT is pressed once again, the transceiver will not transmit.

1. In this Menu the default screen shows TOT-OFF.
2. Turn the main dial to select time-out timer. Screen should change as shown. The number followed by TOT is the time-out timer in seconds.
3. The TOT feature is selectable up to 450 seconds (7.5 minutes).

TOT-OFF

TOT-60

during the setting time of 60 seconds

## 6. Parameter Setting

### TOT Resuming Time

When the transmission is shut down in the TOT mode, this function prohibits another transmission for a selected time period.

1. During the TOT resuming period, the beep sounds when the PTT is pressed but the radio does not transmit.
2. Default setting is TP-OFF (TOT resume stop). Rotate the main dial to select the resuming time, up to 15 seconds.

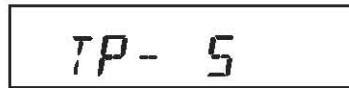

during the setting time of 5 seconds

### APO—Auto Power OFF

This feature will automatically turn off the transceiver. It is useful for mobile operation to avoid draining the car battery. If there is no activity or use of the radio, it will turn off automatically after 30 minutes. In one minute before turning off, transceiver will sound beep for seconds.

1. Default is APO-OFF (automatic turn off function disable).
2. Turn dial to select APO-ON to activate the function.



during the ON setting

### Tone—Burst Frequency

This is to access Tone-Burst repeater which require a certain pitch of audible tone to activate "sleeping" repeater. Usually, a repeater system does not require the tone once the repeater is activated.

1. The default is TB-1750, which is 1750Hz tone.
2. It is selectable from 1000, 1450, 1750, 2100Hz.

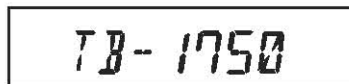

during the 1750Hz frequency

### Busy Channel Lockout

This function prohibits transmission as there is a signal indication icon on the receiving frequency position. The default is BCLO-OF, which means the function is OFF. To set this function ON, the radio transmits only when:

1. No signal is received on the receiving frequency.
2. Matching CTCSS tone or DCS code is received.

Otherwise, when press PTT, a beep sounds, but the unit does not transmit.



during the ON setting

### Burglar Alarm

Default is SCR-OFF. Select ON or DLY (delay) to activate the function. When the SCR-ON is selected, 100MHz and 100KHz order decimal points will appear on the screen. Operation way of the ST-5188 will be show later.

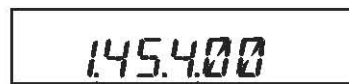

lights up lights up

## 6. Parameter Setting

---

### Alphanumeric Tag

---

The memory channels stored in the memory-mode can be displayed with an alphanumeric tag instead of the default frequency display. Program the memory channel first. There are 67 characters available including A-Z, 0-9.

1. Enter the set mode while the units is in memory mode.

2. Select alphanumeric tag setting by rotating the main dial or pressing the **UP/DOWN** keys. **A** flashes on the screen.



3. Turn the main dial to select a character. Press the **V/M** key. The character stops flashing and is entered.



4. The same flashing character appears next to it, ready for entering the next character. Repeat the same sequence, up to seven characters.

5. To delete all characters during programming press **CALL**.

6. To exit after setting is done, press **PTT**, **FUNC**, or **TS/DCS**.

After programming, the alphanumeric tag will be displayed on the designated channels, instead of the frequency, when in memory mode. The memory channel number and other icons will also be displayed. If you wish to see the programmed frequency, press **FUNC** and it will be displayed for 5 seconds. To return to the alphanumeric display, wait 5 seconds or in succession press **FUNC** to return to normal operation.

---

**[IMPORTANT] This function cannot be enabled without preprogramming the memory channels.**

---

### Dimmer

---

The screen illumination can be dimmed.

1. "LAMP-H" is displayed as default.



2. Turn the dial to choose brighter (H) or darker (L).



# 7. Advanced Operation

Your transceiver offers different features for advanced operations.

## Scan

Use this function to automatically search for signals. 6 different scan types are available in the unit. In parameter setting mode, choose Timer mode or Busy mode to determine the desired re-summing condition. If the CTCSS (TSQ) squelch or DCS squelch is set, the audio can be heard only when the CTCSS tone/DCS code matches the incoming signal. Otherwise, scanning stops but no audio will be heard. The direction of scan, upward or downward, can be changed during the scan by rotating the main dial or pressing **UP/DOWN** keys in the desired direction.

### 【VFO Scan】

Scans all VFO channels in regard to the preset tuning step.

1. Enter VFO mode.
2. Press **UP** (to go upward) or **DOWN** (to go downward) key for more than 1 second.
3. The scan starts. It stops at the frequency where the incoming signal is detected, and resumes the scan according to the resume setting.
4. Press any key (other than **UP/DOWN** keys) to exit.



### 【Memory Scan】

Scans all memory channels unless Memory skip feature is selected for a given memory.

1. Enter Memory mode.
2. Sequence is the same as in VFO scan. Use **UP/DOWN** keys for commands.

### NOTE: Memory Skip Feature

This feature allows determined memory channels to be skipped during the scan.

1. In memory mode, select the channel to be skipped. Press **FUNC** key. While "**■**" is visible on the display, press **V/M** key. Repeat the sequence to delete the setting.
2. When the memory channel is set to skip, the 10 MHz order decimal point will be displayed.
3. CALL, PL and PH are always skipped during Memory scan.
4. The 99th channel is the burglar warning channel, which can not be set to skip.

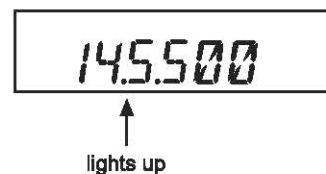

### 【Program Scan】

This is a type of VFO scan, but by setting the frequency range of the VFO into PH and PL channels, it only scans between those frequencies. With setting the PH and PL properly, up to 3 program scan ranges will be available.

1. Enter the VFO mode and set the desired scanning frequencies into the designated PL and PH memory channels. Refer to Memory Channel Setting for the proper sequence.
2. Return to VFO mode by pressing **V/M** key. Set the VFO to the frequency within the range to be program-scanned.

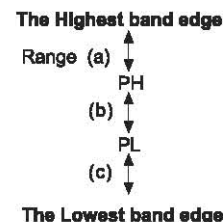

## 7. Advanced Operation

---

3. Press **MHz** key for more than 1 second to start scanning. During this scan mode, "P" flashes after memory channel display.
4. Use main dial or **UP/DOWN** keys to change the direction. Press any key (other than the **UP/DOWN** keys) to exit.



### **[CTCSS Scan]**

This function automatically searches for the CTCSS tone an incoming signal might carry. This feature is useful to search the encoding tone of a repeater, or to communicate with a station operation in TSQ (CTCSS squelch) mode.

1. Press **TS/DCS** key to enter CTCSS decode setting mode.
2. Press **UP/DOWN** key for more than 1 second but less than 2 seconds to start scanning. It scans 50 tones in order.
3. The decimal point on the tone frequency will flash, and it stops when the matching tone is detected.
4. The scan won't resume until the operation is repeated.
5. Press any key (other than **UP/DOWN** keys) to exit.



### **[DCS Scan]**

Same as previous, but for DCS normal and inverted code search.

1. Press **TS/DCS** key to enter DCS setting mode.
2. Press **UP/DOWN** key for more than 1 second but less than 2 seconds to start. It searches the 104 DCS normal and inverted codes in order. Normal code shows 023N; inverted code shows 023I.
3. The 1 MHz order decimal point will flash.
4. The scan stops when the matching code is detected.
5. The scan won't resume until the operation is repeated.
6. Press any key (other than **UP/DOWN** keys) to exit.

