

Land mobile radio

User manual

Brand name: AnyTone

Model name: 588

FCC ID: T4K588

588 USER'S MANUAL



MOBILE RADIO

Nice Housing, Stoutness & Stability, Advanced and Reliable functions, Perfect & Valuable.  Approval. 588 mobile radio especially designs for drivers and it pursues company philosophy of innovation and practicality.



NOTE

When programming the transceiver, read the factory initial data firstly, then rewrite the frequency and signaling etc., otherwise errors may occur because of different frequency band etc..

588 Mobile Radio Applicable Software: QPS588

Models Apply To This Manual: 588 Mobile radio



MOBILE RADIO

Thank you for choosing this vehicle transceiver, 588 always provides high quality products, And this transceiver is no exception. As you learn how to use this transceiver, you will find that 588 is pursuing "user friendliness". For example, each time you change the menu no. in Menu mode, you will see a text message on the display that lets you know what you are configuring.

Though friendly design for user, this transceiver is technically complicated and some features may be new to you. Consider this manual to be a personal tutorial from the designers, allow the manual to guide you through the learning process now, then act as a reference in the coming years.

Precautions

Please observe the following precautions to prevent fire, personal injury, or transceiver damage:

- ⚠ Do not attempt to configure your transceiver while driving, it is dangerous.
- ⚠ This transceiver is designed for a 13.8V DC power supply. Don't use a 24V battery to power on the transceiver.
- ⚠ Do not place the transceiver in excessively dusty, humid or wet areas, nor unstable surfaces.
- ⚠ Please keep it away from interferential devices (such as TV, generator etc.)
- ⚠ Do not expose the transceiver to long periods of direct sunlight nor place it close to heating appliances.
- ⚠ If an abnormal odor or smoke is detected coming from the transceiver, turn OFF the power immediately. Contact an Anytone service station or your dealer.
- ⚠ Do not transmit with high output power for extended periods; the transceiver may overheat.

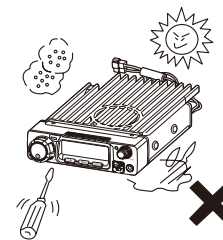

CONTENTS

New and Innovative Features	1	Transmitting Optional Signaling	13
Supplied Accessories/Optional Accessories	2	Channel Edit	13
Supplied Accessories.....	2	Channel Delete	13
Optional Accessories	2	Shortcut Operations	14
Initial Installation	3	Squelch Off/Squelch Off Momentary.....	14
Mobile Installation	3	Squelch Level Setup	14
DC Power Cable Connection	4	Frequency/Channel Scan	14
Power Supply Voltage Display	6	Channel Scan	14
Antenna Connection	6	CTCSS/DCS Encode and Decode Setup	14
Accessories Connections.....	7	CTCSS Scan.....	15
Getting Acquainted	8	DCS Scan	15
Front panel.....	8	Power	15
Rear panel	9	Compander (Decrease the background noise and enhance audio clarity	15
Display	9	Offset Direction and Offset Frequency Setup	16
Microphone	10	Keypad Lockout	16
Working Mode(Amateur Transceiver or Professional Transceiver)	11	Current Voltage Enquiry.....	16
Basic Operations	12	Auto-Dialer Setup.....	16
Switching the Power On/Off	12	Transmitting Edited DTMF Tones in the Auto-dialer Memory.....	17
Adjusting the Volume	12	General Setting	18
Switch between VFO and Channel mode	12	Frequency Channel Step Setup.....	18
Adjusting Frequency/Channel Through Selector Knob.....	12	DTMF, DTMF ANI, 2Tone or 5Tone Signaling.....	18
Receiving	12	Sending 2-Tone Call.....	19
Transmitting	12	Sending 5-Tone Call.....	19
Transmitting Tone-Pulse	13	Sending DTMF call	19
		Signaling Combination Setup.....	19



CONTENTS

Power	20	Optional Signaling	27
TX OFF Setup.....	20	Scan Skip	28
Busy Channel Lockout.....	21	Frequency/Channel Scan	28
Editing Channel Name.....	21	Busy Channel Lockout.....	28
Reverse TX/RX	21	Reverse TX/RX.....	28
Talk Around	22	TOT (Time-out timer).....	29
Voice Comander	22	CTCSS/DCS Encode and Decode.....	29
Scrambler Setup (Encryption).....	22	Talk Around	29
Radio's DTMF SELF ID ENQUIRY	22	Voice Prompt.....	29
Radio's 5TONE SELF ID ENQUIRY	23	LCD Backlight	20
Voice Prompt.....	23	Long-distance Anti-theft Alarm	29
TOT (Time-out timer)	23	Cable Clone	31
APO (Auto power off).....	23	Maintenance.....	32
DTMF Transmitting Time.....	24	Default Setting after Resetting(VHF)	32
Squelch Level Setup	24	Trouble Shooting.....	32
Scan Dwell Time Setup.....	24	Specifications	33
LCD Backlight	24	Attached Chart.....	34
Pilot Frequency	25	50 groups CTCSS Tone Frequency(Hz)	34
Display Mode Setup.....	25	1024 groups DCS Code.....	34
PIN Setup	25		
Address List	26		
Factory Default.....	26		
Microphone Operation	27		
Function Setup By Microphone Keypad.....	27		
Squelch Level	27		

New and Innovative Features

1

588 Mobile Radio has nice housing, stoutness & stability, advanced and reliable functions, perfect & valuable. This amateur mobile radio especially designs for drivers and it pursues company philosophy of innovation and practicality. More functions as follows:

- ▼ Display on a large LCD with adjustable brightness, convenient for nighttime use. There are Amateur operation mode and Professional operation mode for option.
- ▼ Distribute buttons reasonably, convenient for operation. Adopt superior quality material, better technology and high quality radiator to ensure stable and durable operation.
- ▼ 200 programmable memorized channels, identified by editing name.
- ▼ Programming different CTCSS, DCS, 2Tone, 5Tone in per channel, rejecting extra calling from other radios.
- ▼ Various scan functions including CTCSS/DCS Scan function.
- ▼ Using 5Tone to send Message, Emergency alarm, Call all, ANI, Remotely kill, Remotely Waken, etc.
- ▼ Automatic calling Identification function by DTMF--ANI or 5Tone--ANI .
- ▼ Scramble function (Optional).
- ▼ Comander function for decrease the background noise and enhance audio clarity, it can set compander ON/OFF per channel.
- ▼ Theft alarm provides extra safety.

2

Supplied Accessories/Optional Accessories

SUPPLIED ACCESSORIES

After carefully unpacking the transceiver, identify the items listed in the table below. We suggest you keep the box and packaging.

- Transceiver

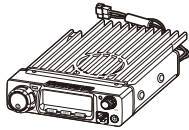

- Microphone (QHM-03)
(with DTMF keyboard)



- Mobile Mounting
Bracket (QMB-01)

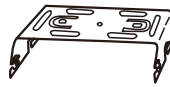

- DC Power Cable with
Fuse Holder(QPL-01)



- Hardware Kit for Bracket

Black screws (M4X8mm)
4PCS (QSS-01A) Tapping screws (M5X8mm)
4PCS (QSS-01B) S-Washer (QSS-01D)



- Spare Fuses (one pair)
[QF-01]



- User Manual

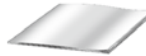

OPTIONAL ACCESSORIES

- Cloning Cable (CP50)



- USB Programming
Cable (PC50)



- Cigar-Plug Connection
Line (QCC-01)



- Programming Software
(QPS-588)

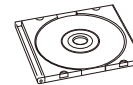

- Regulated Power
Supply (QRP-01)

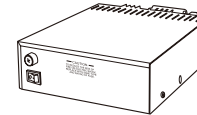

- External Speaker
(SP-01)

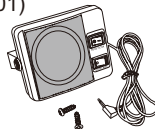

- Desktop
Microphone
(QDM-01)

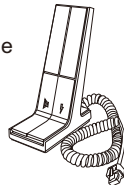

- Alarm Cable A
[QL-01(A)]



- Alarm Cable B (Extension line)
[QL-01(B)]



- Car Antenna
(QCA-01)



Initial Installation

3

MOBILE INSTALLATION

To install the transceiver, select a safe, convenient location inside your vehicle that minimizes danger to your passengers and yourself while the vehicle is in motion. Consider installing the unit at an appropriate position so that knees or legs will not strike it during sudden braking of your vehicle. Try to pick a well ventilated location that is shielded from direct sunlight.

1. Install the mounting bracket in the vehicle using the supplied self-tapping screws (4pcs) and flat washers (4pcs).

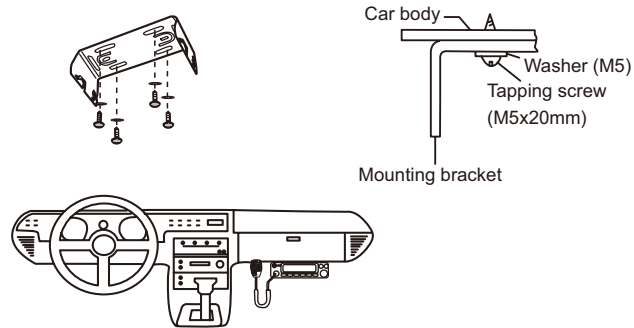

2. Position the transceiver, then insert and tighten the supplied hexagon SEMS screws.

- ▼ Double check that all screws are tightened to prevent vehicle vibration from loosening the bracket or transceiver.

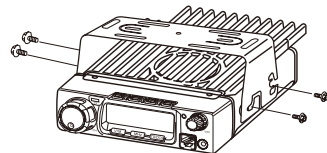

- ▼ Determine the appropriate angle of the transceiver, using the 3 screw hole positions on the side of the mounting bracket.

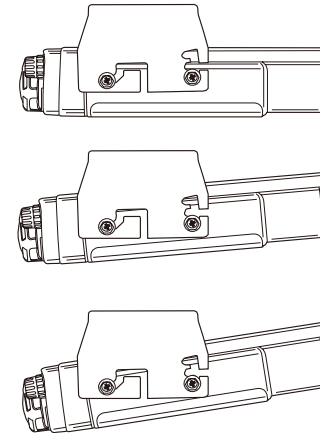

3

3

Initial Installation

DC POWER CABLE CONNECTION

 **NOTE** Locate the power input connector as close to the transceiver as possible.

MOBILE OPERATION

The vehicle battery must have a nominal rating of 12V. Never connect the transceiver to a 24V battery. Be sure to use a 12V vehicle battery that has sufficient current capacity. If the current to the transceiver is insufficient, the display may darken during transmission, or transmitting output power may drop excessively.

1. Route the DC power cable supplied with the transceiver directly to the vehicle's battery terminals using the shortest path from the transceiver.
 - ▼ We recommend you do not use the cigarette lighter socket as some cigarette lighter sockets introduce an unacceptable voltage drop.
 - ▼ The entire length of the cable must be dressed so it is isolated from heat, moisture, and the engine secondary (high voltage) ignition system/ cables.
2. After installing cable, in order to avoid the risk of damp, please use heat-resistant tap to tie together with fuse box. Don't forget to reinforce whole cable.
3. In order to avoid the risk of short circuit, please cut down connection with negative (-) of battery, then connect with radio.
4. Confirm the correct polarity of the connections, then attach the power cable to the battery terminals; red connects to the positive (+) terminal and black connects to the negative (-) terminal.
 - ▼ Use the full length of the cable without cutting off excess even if the cable is longer than required. In particular, never remove the fuse holders from the cable.
5. Reconnect any wiring removed from the negative terminal.

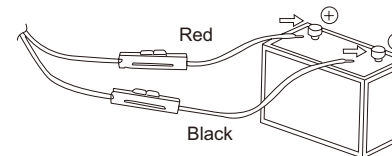

6. Connect the DC power cable to the transceiver's power supply connector.

▼ Press the connectors firmly together until the locking tab clicks.

If the ignition-key on/off feature is desired(optional feature),use the

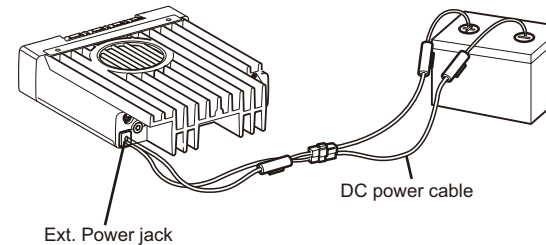

optional QCC-01(For Cigar-Plug connection) cable. Connect one of the cables between the ACC terminal or a Cigar-Plug that operates with the vehicle ignition or ACC switch on the vehicle and EXT POWER jack on the rear side of the unit.

 **NOTE** In many cars,the cigar-lighter plug is always powered. If this is the case, you cannot use it for the ignition key on/off function.

7. When the ignition key is turned to ACC or ON(Start) position with the radio turned off, the power switch illuminates. The illumination will be turned off when the ignition key is turned to the off position.

Initial Installation

3

To turn on the unit, press the power switch manually while it is illuminated. (While ignition key is at ACC or ON position)

8. When the ignition key is turned to ACC or ON position with the radio's power switch on, the unit turns on automatically and the power switch will be lit. Turn the ignition key to OFF position or manually turn the power switch off to shut down the radio.

9. Using extra cable, power consumption: 5MAH.

10. Without this function, user can turn on/off radio by Power knob.

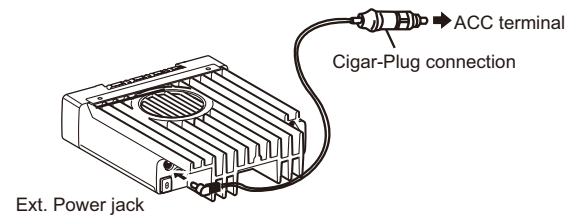

✕ FIXED STATION OPERATION

In order to use this transceiver for fixed station operation, you will need a separate 13.8V DC power supply (not included), power supply (QRP-01) as optional accessories. Please contact local dealer to require.

The recommended current capacity of your power supply is 12A.

1. Connect the DC power cable to the regulated DC power supply and ensure that the polarities are correct. (Red: positive, Black: negative).

▼ Do not directly connect the transceiver to an AC outlet.

▼ Use the supplied DC power cable to connect the transceiver to a regulated power supply.

▼ Do not substitute a cable with smaller gauge wires.

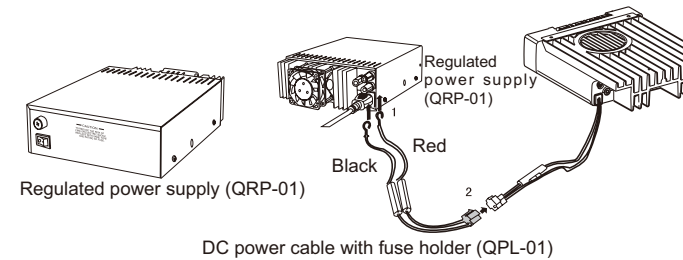

2. Connect the transceiver's DC power connector to the connector on the DC power cable.

▼ Press the connectors firmly together until the locking tab clicks.



NOTE

▼ Before connecting the DC power to the transceiver, be sure to switch the transceiver and the DC power supply OFF.

▼ Do not plug the DC power supply into an AC outlet until you make all connections.

5

3

Initial Installation

✕ REPLACING FUSES

If the fuse blows, determine the cause, then correct the problem. After the problem is resolved, replace the fuse. If newly installed fuses continue to blow, disconnect the power cable and contact your authorized dealer or an authorized servi-cecenter for assistance.

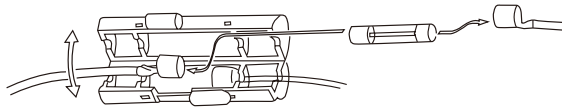

Fuse Location	Fuse Current Rating
Transceiver	15A
Supplied Accessory DC power cable	20A

Only use fuses of the specified type and rating, otherwise the transceiver could be damaged.



NOTE

If you use the transceiver for a long period when the vehicle battery is not fully charged, or when the engine is OFF, the battery may become discharged, and will not have sufficient reserves to start the vehicle. Avoid using the transceiver in these conditions.

■ POWER SUPPLY VOLTAGE DISPLAY

After connecting the transceiver to the power supply, the supply voltage can be displayed on LCD by pressing the **[FUN]** key together with the **[SQL]** key.

The display immediately changes as the voltage supply changes. It also displays voltage during transmission.

The transceiver will return to its normal operation when the power is switched ON or repeat above operation.



Important

The range of displayed voltage is only from 7V to 16V DC, because the displayed value is estimated, please use a voltmeter when a more precise reading is desired.

■ ANTENNA CONNECTION

Before operating, install an efficient, well-tuned antenna. The success of your installation will depend largely on the type of antenna and its correct installation. The transceiver can give excellent results if the antenna system and its installation are given careful attention.

Use a 50Ω impedance antenna and low-loss coaxial feed-line that has a characteristic impedance of 50 Ω, to match the transceiver input impedance. Coupling the antenna to the transceiver via feed-lines having an impedance other than 50Ω reduces the efficiency of the antenna system and can cause interference to nearby broadcast television receivers, radio receivers, and other electronic equipment.



NOTE

Transmitting without first connecting an antenna or other matched load may damage the transceiver. Always connect the antenna to the transceiver before transmitting.
All fixed stations should be equipped with a lightning arrester to reduce the risk of fire, electric shock, and transceiver damage.

The possible locations of antenna on a car are shown as following:

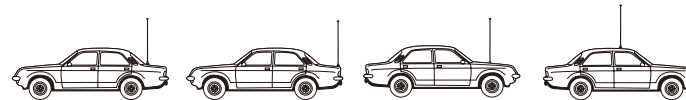

ACCESSORIES CONNECTIONS

EXTERNAL SPEAKER

If you plan to use an external speaker, choose a speaker with an impedance of 8 Ω . The external speaker jack accepts a 3.5 mm (1/8") mono (2-conductor) plug.

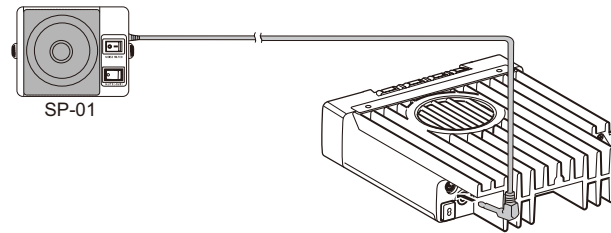

NOTE

External speaker adopt double port BTL, please care about the connecting way. The speaker can not connect with the ground, otherwise the speaker will be fault. The wrong connecting way as the following picture.

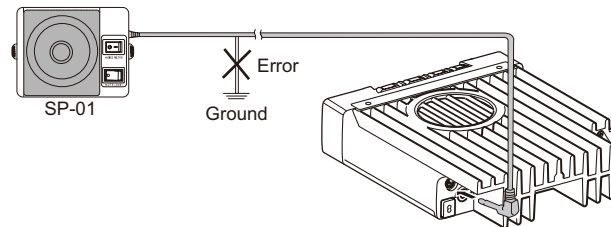

MICROPHONE

For voice communications, connect a microphone equipped with an 8-pin modular plug into the modular socket on the front of the main unit. Press firmly on the plug until the locking tab clicks. Attach the supplied microphone hanger in an appropriate location using the screws included in the screw set.

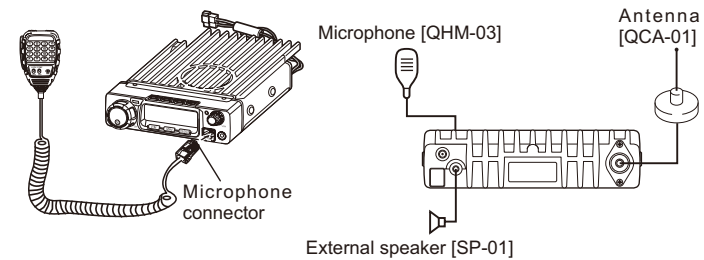

PC CONNECTING

To utilize the optional QPS-588 software, you must first connect the transceiver to your PC then using an optional programming cable PC50 (via Data socket).

Please use QPS-588 software for programming.

<http://www.qxdz.cn>



NOTE

Ask your dealer about purchasing a Programming Cable PC50.

4

Getting Acquainted

FRONT PANEL

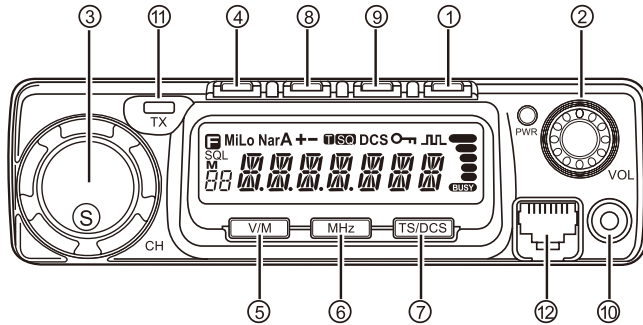

Basic Functions

NO.	KEY	FUNCTION
1	Pow(Power)	Power on/Off
2	VOL	Adjust Volume Key
3	Main Dial	Change frequency, memory channel and scan direction etc.
4	FUN/SET	Function Key
5	V/M/MW	Switches between VFO mode and Channel mode
6	MHz/SHIFT	Step Size Key (step:1MHz)
7	TS/DCS/LOCK	Sets CTCSS and DCS value
8	CAL/H/L	Call key
9	SQL/D	Squelch off
10	Data Terminal	Data reading/writing, cloning and theft alarm functions
11	TX	lights during Transmitting
12	Mic.connector	Microphone connection port

• Press **[FUN]** key until **[S]** icon appears then press the following key.

NO.	KEY	FUNCTION
4	FUN/SET	Confirms the selective functions and exit
5	V/M/MW	Stores data into channels
6	MHz/SHIFT	Sets offset direction and offset frequency
7	TS/DCS/LOCK	Sets Keypad lock function
8	CAL/ H/L	
9	SQL/D	Compander mode on/off

• Press **[FUN]** key and following key together to activate following function:

NO.	KEY	FUNCTION
1	PWR	Reset to factory default settings
5	V/M/MW	Erase the memory
6	MHz/SHIFT	Switches between Wide/ Narrow band
7	TS/DCS/LOCK	Auto dialer
8	CAL/H/L	Enters clone data function mode
9	SQL/D	Enters power supply voltage indication mode

• Functions that require continuous pressing following key to be activated

NO.	KEY	FUNCTION
4	FUN/SET	Press and hold for 2s to enter the Setting mode
9	SQL/D	Monitor mode

REAR PANEL

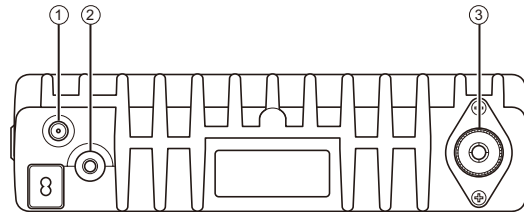

NO.	KEY	FUNCTION
1	Ext. Power Jack	Terminal for connecting optional cable QCC01 for use with ignition key On/Off function. The radio will auto power on when car is driving. The radio will auto power off when car stops.
2	Ext. Speaker Terminal	Terminal for optional external speaker SP01
3	Antenna Connector	Connection for 50Ω coaxial cable and antenna.

DISPLAY

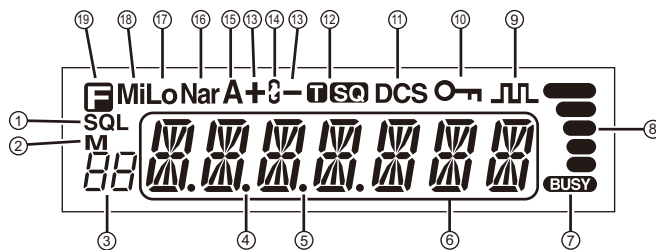

NO.	KEY	FUNCTION
1	SQL	Squelch level.
2	M	In channel mode.
3	88	Indicates the channel number in channel mode.
4	Decimal point	Channel skip.
5	Decimal point	Indicates the decimal point of frequency and the scanning function.
6	88888888	Indicates the frequency or memory name.
7	BUSY	Signal is being received or monitor.
8	Signal strength bars	Signal strength of receiving and transmitting.
9	JLJ	Compander.
10	Key lock icon	Keypad lock .
11	DCS	Set DCS function.
12	CTCSS icon	Set CTCSS function.
13	+ -	Offset frequency direction.
14	Scramble icon	Scramble.
15	A	Auto power off.
16	Nar	Narrow band.
17	LO	Low power.
18	Mi	
19	Function key icon	Pressing [FUN] key.

4

Getting Acquainted

MICROPHONE

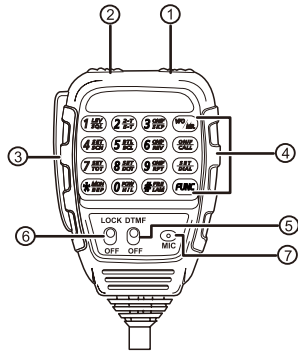

MIC Connector Diagram(in the front view of connector)

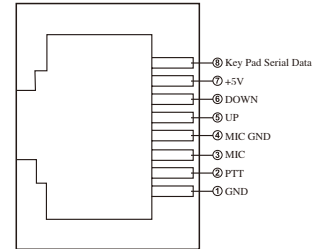

NO.	KEY	FUNCTION
1	UP	Increase frequency ,channel number or setting value.
2	DOWN	Decrease frequency, channel number or setting value.
3	PTT	Press the PTT (Push-TO-Talk) key to transmit.
4	Number Key	Input VFO frequency or DTMF dial out etc..
5	DTMF ON / OFF	Switches between DTMF dialing or function operating.
6	LOCK Switch	Locks out the UP 、 Down、 Numerical keys and Function keys.
7	MIC	Speak here during transmission.

WORKING MODE (AMATEUR TRANSCEIVER OR PROFESSIONAL TRANSCEIVER)

5

According to practical application, you can set the radio works as Amateur Transceiver mode or Professional Transceiver mode. There are also 2 levels operation menu to set functions as you need. It is easy and convenient (From No.1 to No. 15 are channel function setup, From No.15 to No.29 are general setting setup).

1. Working Mode:

A. By programming software: In PC software's "General Setting" menu, choose "Display Mode" to select Amateur Transceiver mode or Professional Transceiver mode.

B. By manual setup: Please refer to "Display Mode" in Page 24.

2. Amateur Transceiver Mode: Except setting as "CH" mode, others considered as Amateur transceiver mode. Under this mode, press  key to switch between Channel mode and VFO mode.

A. Frequency + Channel mode: When set display as "FR", it enters into Frequency+Channel mode, new setting of channel operation and shortcut operation can be temporarily used by user. Once the radio is turned off or switched to another channel, the temporary setting will be erased and back to initial settings. (As pic 1)

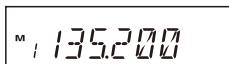

(Pic 1)

B. Channel+Name Tag Mode: When set display as "NM", it enters into Channel +Name Tag mode. At this mode, it will display corresponding channel name when the current channel is edited with name. Otherwise, it will display frequency + channel. Its operations are the same as frequency + channel mode. (As pic 2)



(Pic 2)

C. VFO Mode(Frequency mode):

This mode shows only frequency on the display. Shortcut operation and Channel setting will be changed & stored as the latest value permanently. Once the radio is turned off or changed to new VFO frequency, the latest setting is remained until next change. (As pic 3)



(Pic 3)

3. Professional Transceiver Mode: When set display mode as "CH", it enters into Professional Transceiver mode. At this mode, except scan, other shortcut operation can't operate. And from No.1-17 menu in function setting will be auto-hidden, they should be set by PC software. If there is corresponding name for current channel, the LCD will display current channel name. Otherwise, it shows current channel number. (As pic 4) (As pic 5)



(Pic 4)

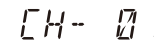

(Pic 5)



If transceiver programmed as professional transceiver mode and locked, you can't return to amateur transceiver mode by manual operation from general setting.

4. Under every mode, from No. 18-29 menu in general setting can be changed and saved.

6 Basic Operations

SWITCHING THE POWER ON/OFF

according to the option selected during installation Press the **[PWR]** switch or turn the ignition key to ACC (speed up) or ON (startup) position to power on radio . Press the **[PWR]** key for 1s or turn the ignition key to OFF position to turn off.

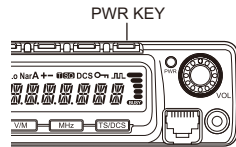

ADJUSTING THE VOLUME

Turn the VOL knob clockwise to increase the audio level, counterclockwise to decrease.

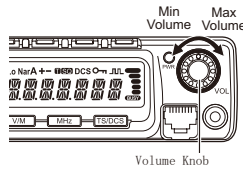

NOTE During communication, volume can be adjusted more accurate.

SWITCH BETWEEN VFO AND CHANNEL MODE

In standby, press **[V/M]** key or Microphone's **[VFO/MHz]** key until appear **M**, this indicates current channel in channel mode. Repeat above operation to switch between Frequency mode (VFO) and Channel mode.

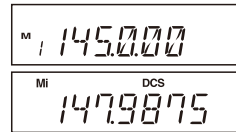

ADJUSTING FREQUENCY/CHANNEL THROUGH SELECTOR KNOB

- Under frequency (VFO) mode, you can change the current frequency to the desired one through selector knob; Turn clockwise to increase frequency; turn counterclockwise to decrease. Every gear will increase or decrease one step. Press **[MHz]** key, the decimal point of

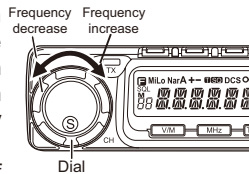

frequency in screen will be auto-hidden. In this status, turn selector knob or Microphone **[UP]** / **[DOWN]** key will increase or decrease frequency quickly by 1MHz step .

- Under channel mode, you can change the current channel to the desired one through selector knob, clockwise turn to the forward channel, anticlockwise turn to the backward channel. In relative working mode, Microphone's **[UP]** / **[DOWN]** key has same function for adjusting frequency and channel.

RECEIVING

When the channel you are operating is called, the screen shows **BUSY** and field intensity, in this way, you can hear the calling from transmitting party.

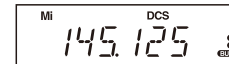

NOTE If the transceiver has set at higher squelch level, it may fail to hear the calling.

When the channel you are operating is called,the screen shows BUSY and field intensity,you can't hear the calling from transmitting party,it means current channel receives a matching carrier but unmatching signaling(Refer to CTCSS/DCS encode and decode or Optional Signaling setup).

TRANSMITTING

Press and hold **[SQL]** key or press MIC's **[*SQL]** key to monitor for a while to confirm the channel desired is not busy. Release **[SQL]** or press Mic's **[*SQL]** key to return standby status,Then press and hold **[PTT]** key to speak into microphone.

- ▼ Please hold the microphone approximately 2.5-5.0cm from your lips, and then speak into the microphone in your normal speaking voice to get best timbre.

 Press and hold [PTT] key, LED lights RED and power intensity showed in NOTE screen indicates it is transmitting, release to receive.





■ TRANSMITTING TONE-PULSE



Press and hold [PTT] key, then press Microphone [**DOWN**] key to transmit current selected tone-pulse signal.

■ TRANSMITTING OPTIONAL SIGNALING

Press and hold [PTT] key, then press Microphone **UP** key or press  key in front panel or press Mic's  key to transmit pre-stored and selected DTMF/2Tone/5Tone optional signaling.

■ CHANNEL EDIT





- Under frequency mode (VFO), turn selector knob to select the desired frequency or input frequency by MIC's numeric keys.
- Press  key to enter CTCSS/DCS signaling setup, turn selector knob to select the desired signaling.
- Press  key, LCD appears  **M** icon and current channel number, **M** icon flashing means current channel is empty.
- Turn selector knob to select the desired channel number to store.
- Press  key,  , **M** icon and channel number disappears and emit a prompt voice, thus the channel storage succeed.





7 Shortcut Operations

■ SQUELCH OFF/SQUELCH OFF MOMENTARY





 key programmed as Squelch Off or Squelch Off Momentary to monitor the weak signal.

1. Squelch Off: Press  key to disable squelch ,press  key again to resume squelch.
2. Squelch Off Momentary: Press and hold  key to disable squelch,release  key to resume squelch.

 NOTE The above functions should be set in programme software.

■ SQUELCH LEVEL SETUP

Setting the radio to a tight squelch level,you can avoid unwanted signals or noise,but you may not receive a weak signal. Therefore,it will be better for you to select the normal squelch level.

1. While standby, press  key and turn selector knob until LCD appears **SQL** and current squelch level
2. Turn selector knob or press MIC [ / ] key to set desired squelch level.
3. Press any key except  and  key to exit .

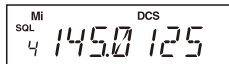

MI DCS
SQL 4 145.0 125

■ FREQUENCY/CHANNEL SCAN



✕ FREQUENCY SCAN

In frequency (VFO) mode, this function is designed to monitor signal of every communicative frequency point of transceiver "step size" you have set.

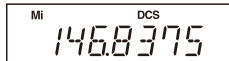
1. In VFO mode,press  for 1s to enter into frequency scan.







MI DCS
146.8375

2. Turn selector knob or press Microphone [ / ] key to change scan direction.

3. Press any key except  and  key to exit.

■ CHANNEL SCAN

In channel mode, this function is designed to monitor signal in every channel.



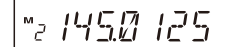

1. In channel mode,Press  key for 1s to enter into channel scan
2. Turn selector knob or press Microphone [ / ] key to change scan direction.
3. Press any key except  and  key to exit.



M 2 145.0 125

■ CTCSS/DCS ENCODE AND DECODE SETUP

Repeatedly press  key to check whether set CTCSS/DCS encode and decode in current channel or not.

1. When LCD appears **T** icon, it means current channel with CTCSS encode, turn selector knob or press Microphone's [ / ] key to select desired CTCSS encode.
2. When LCD appears **T** and **SO** icon, it means current channel with CTCSS encode and decode, turn selector knob or press Microphone's [ / ] to select desired CTCSS code.



M 88.5

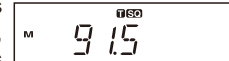

M 91.5

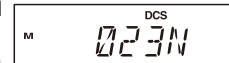

M DCS
023N

- When LCD appears **DCS** icon, it means current channel can be set with DCS encode and decode together, turn selector knob or press Microphone's [**UP** / **DOWN**] to select desired DCS encode and decode.
- CTCSS:62.5-254.1, Total 51groups; DCS:000N-777I total 1024 groups. **N** is positive code, **I** is inverse code.
- Press any key except **FUN**, **POW** and **TS/DCS** keys to return into standby status.

NOTE Under channel mode, this operation can be temporarily used by user. Once the radio is turned off or switched to another channel, the temporary setting will be erased.

CTCSS SCAN

Repeatedly press **TS/DCS** key until LCD displays **T** and **SC** icons, then hold **TS/DCS** key for 1S to enter into CTCSS scanning. Once finding a matching CTCSS signaling, it will stop for 15s then scan again.

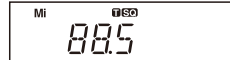

DCS SCAN

Repeatedly press **TS/DCS** key until LCD displays DCS icons, then hold **TS/DCS** key for 1S to enter into DCS scanning. Once finding a matching DCS signaling, it will stop for 15s then scan again.

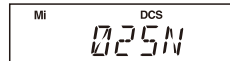

POWER

Press **FUN** key until LCD display **iron**, then press **CAL** key to switch to low power. The LCD appears:

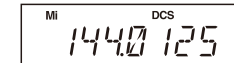
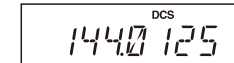

Lo: Transmit in low power

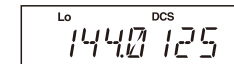

COMPANDER (DECREASE THE BACKGROUND NOISE AND ENHANCE AUDIO CLARITY)

Compander function will decrease the background noise and enhance audio clarity, especially in long range communication.

- Press **FUN** key, then press **SOL** key to turn on compander function, repeat above operation again to turn off compander function.
- When LCD appears **JUL** icon, enable compander in current channel.
- When LCD doesn't display **JUL** icon, disable compander in current channel.

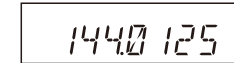
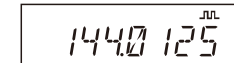

7

Shortcut Operations

■ OFFSET DIRECTION AND OFFSET FREQUENCY SETUP

Repeater receives a signal(UP-LINK) on one frequency and re-transmits on another frequency(DOWN-LINK). The difference between these two frequencies is called the offset frequency. If the UP-LINK frequency higher than DOWN-LINK frequency, the direction is positive, If it is lower, the shift direction is negative.

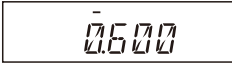
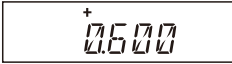
1. Press **[FUN]** key until the **[F]** icon displays on the LCD, then press **[MHz]** key, LCD displays offset direction and offset frequency. 
2. Repeatedly press **[MHz]** key to select positive offset and negative offset. 
3. When LCD displays "+" icon, it indicates positive offset, which means transmitting frequency higher than receiving frequency.
4. When LCD displays "-" icon, it indicates negative offset, which means transmitting frequency lower than receiving frequency.
5. Turn selector knob or Mic's [**UP** / **DOWN**] key to change offset frequency, offset frequency changed as per stepping.
6. Press any key except **[FUN]** and **[MHz]** key to exit into standby.



NOTE

Under channel mode, this operation can be temporarily used by user.
Once the radio is turned off or switched to another channel, the temporary setting will be erased.

■ KEYPAD LOCKOUT

Avoiding unintentional operation, this function will lock main keys, all keys except **[SQL]**、**[FUN]** and **[POW]** key are invalid.

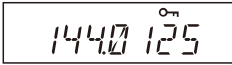
1. Press **[FUN]** key until LCD displays **[F]** icon, then press **[TS/DOS]** key until, LCD displays **[OK]** icon, it indicates keypad lockout function is valid. 
2. Repeat above operation, **[OK]** icon disappears, it indicates keypad lockout function is invalid.

■ CURRENT VOLTAGE ENQUIRY

This function will display Current Battery Voltage.

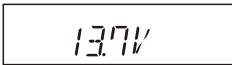
1. Press and hold **[FUN]** key, then press **[SQL]** key, LCD displays current battery voltage. 
2. Repeat above operation to return into VFO or Channel mode





In voltage display mode, all functions and channel or frequency selection are invalid.

■ AUTO-DIALER SETUP

This will automatically transmit pre-programmed and stored DTMF tones. And they are often used to remote control electronic devices or AUTOPATCH phone systems available on some repeater.

1. Press and hold **[FUN]** key, then press **[TS/DOS]** key to enter the auto-dialer enquiry mode, LCD displays current default data and current group displayed on left. If no data in current group, it shows "EMPTY".

2. Turn selector knob to choose group you desired. Total:16 group,01-16. 
3. Press **[SQL]** key to enter into editing of current group,press MIC's numeric keys to set your desired data. 
4. The display scrolls when the 7th digit is entered. The numbers 0-9, --, A-D, * and # can be stored up to a total of 23 digits. 
5. After editing,press PTT or **[CAL]** key to send current group and store edited DTMF signaling. Press **[SQL]** to exit and store.

■ TRANSMITTING EDITED DTMF TONES IN THE AUTO-DIALER MEMORY

1. Press **[FUN]** key, then press **[TS/DCS]** key to enter into auto-dialer enquiry
2. Turn selector knob to select desired transmitting group
3. Press PTT or **[CAL]** key to transmit current selected DTMF tones.

8

General Setting

1. Press and hold **[FUN]** key for over 2s to enter general setting menu.
2. Press **[CAL]** or **[SQL]** to select the desired function option.
3. Turn selector knob to select the desired setup.
4. Press **[TS/DCS]** to confirm and exit.

Meanwhile,if you want to edit channel name or start up menu,press **[V/M]** or **[TS/DCS]** to move forward or backward,Press **[MHZ]** to store and exit.

NOTE In Profession transceiver mode,the functions from No.1 to No.17 will be auto-hidden.

FREQUENCY CHANNEL STEP SETUP

Only in frequency (VFO) mode, this function is valid. Turn selector knob to select frequency or frequency scanning which is restricted by frequency step size.

1. Press and hold **[FUN]** key for over 2s to enter general setting menu. 
2. Press **[CAL]**/**[SQL]** key to choose No.01 menu, LCD displays "STP--125"
3. Turn selector knob to select the desired frequency channel step. Channel step: 12.5K
4. Press **[TS/DCS]** key to confirm and exit

NOTE This function is auto-hidden in channel mode.

DTMF, DTMF ANI, 2TONE OR 5TONE SIGNALING

DTMF/5Tone/2Tone signalling function as similarly as CTCSS/DCS. Without receiving correspondent tone signalling, the speaker will remain mute. DTMF and 5Tone signalling can be applied for other advanced

features such as ANI, PTT ID, group call, remotely stun,remotely kill, waken,...etc. The signalling edition must be done through programming software. Please refer to the HELP option in the programming software to know how to operate these features.

1. Press and hold **[FUN]** key for over 2s to enter into general setting menu.

2. Press **[CAL]**/**[SQL]** to choose No 2 menu,LCD displays"T-OFF" .

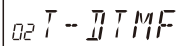

3. Turn selector knob to select the desired setup.

- ▼ "DTMF": the channel will be mute by a DTMF signal. The speaker won't be open until receiving a correspondent DTMF signal. Hold "PTT" then press [UP] or press **[CAL]** directly to transmit the pre-stored DTMF signaling.

NOTE In DTMF signaling mode,press **[CAL]** for 2s until LCD displays "AN---",turn selector knob to select desired digit(the other party ID).In this mode,press **[TS/DCS]** to confirm exist digit and move cursor to next,press **[V/M]** to forward cursor.After editing,press **[CAL]** key to operate ANI call.

- ▼ "2TONE": the channel will be mute by a 2-Tone signal. The speaker won't be open until receiving a correspondent 2-Tone signal.Hold "PTT" then press [UP] or press **[CAL]** directly to transmit the pre-stored 2-Tone signaling.

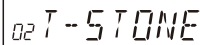
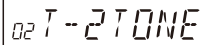

- ▼ "5Tone": the channel will be mute by a 5-Tone signal. The Speaker won't be open until receiving a correspondent 5-Tone signal. hold "PTT" then press [UP] or

Press **[CAL]** directly to transmit the pre-stored 5-Tone signaling.

NOTE In 5Tone signaling mode,press **[CAL]** for 2s until LCD displays "AN--",turn selector knob to select desired digit(caller ID).In this mode,press **[TS/DCS]** to confirm exist digit and move cursor to next,press **[V/M]** to forward cursor.After editing,press **[CAL]** key to operate ANI call.

4. Press **[TS/DCS]** key to confirm and exit

SENDING 2-TONE CALL

1. Press and hold **[FUN]** key for over 2s to enter general setting menu.

2. Press **[CAL]** / **[SQL]** key to choose No.03 menu, LCD displays "2TON XX","XX"indicates the group in the list.



3. Turn selector knob to select the desired sending 2TONE group,Press PTT to transmit selected group.

4. Total:32groups,00-31,Default:00.

5. Press **[TS/DCS]** key to confirm and exit.

NOTE Content and name of 2TONE will be edited by programming software. This radio only query edited group or name.If there is corresponding name for 2TONE,this operation will display 2TONE corresponding name.

SENDING 5-TONE CALL

1. Press and hold **[FUN]** key for over 2s to enter general setting menu

2. Press **[CAL]** / **[SQL]** key to choose No.04 menu, LCD displays "5TON XX","XX"indicates the group in the list.



3. Turn selector knob to select the desired sending 5TONE group,Press PTT to transmit selected group.

4. Total:100groups,00-99,Default:00.

5. Press **[TS/DCS]** key to confirm and exit.

NOTE Content and name of 5TONE will be edited by programming software.This radio only query edited group or name.If there is corresponding name for 5TONE,this operation will display 5TONE corresponding name.

SENDING DTMF CALL

1. Press and hold **[FUN]** key for over 2s to enter general setting menu.

2. Press **[CAL]** / **[SQL]** key to choose No.05 menu, LCD displays "DTMF XX","XX"indicates the group in the list.

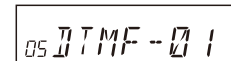

3. Turn selector knob to select the desired sending DTMF group,Press PTT to transmit selected group.

4. Total:16groups,00-16,Default:00.

5. Press **[TS/DCS]** key to confirm and exit.

SIGNALING COMBINATION SETUP

This function is to improve the level of protecting the radio against receiving irrelative signal.

8

General Setting

1. Press and hold **[FUN]** key for over 2s to enter general setting menu.

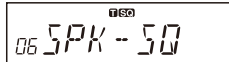

2. Press **[CAL]/[SQL]** key to choose No.06 menu, LCD displays "SPK--SQ".

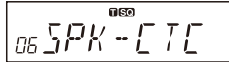

3. Turn selector knob to select the desired combination

If select "SQ",it indicates you can hear the calling from caller when receive a matching carrier.

▼ If LCD displays "CTC",it indicates you can hear the calling from caller when receive a matching carrier and CTCSS/DCS signaling .

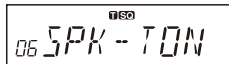

▼ If LCD displays "TON",it indicates you can hear the calling from caller when receive a matching carrier and DTMF/2TONE/5TONE signaling .

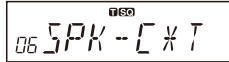

▼ If LCD displays "C/T",it indicates you can hear the calling from caller when receive a matching carrier and CTCSS/DCS and DTMF/2TONE/5TONE signaling .

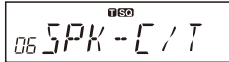

▼ If LCD displays "C/T",it indicates you can hear the calling from caller when receive a matching carrier and either CTCSS/DCS DTMF/2TONE/5TONE signaling. .

4. Press **[TS/DCS]** key to confirm and exit

 **NOTE** This setting will be set together with adding optional signaling and CTCSS/DCS.

TX OFF SETUP

Disable this function,it is invalid to press PTT,current channel only works in RX mode.

1. Press and hold **[FUN]** key for over 2s to enter general setting menu.

2. Press **[CAL]/[SQL]** key to choose No.09 menu, LCD displays"TX-ON".

3. Turn selector knob to select the desired setting .

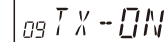

On:In current channel,Press PTT to transmit

OFF:In current channel,Press PTT is invalid.

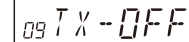

4. Press **[TS/DCS]** key to confirm and exit.Default:ON.

BUSY CHANNEL LOCKOUT

BCLO is to disable transmitting while RX signal is received. Once the channel is busy and you press PTT, the radio will beep as warning and get back to receiving.

1. Press and hold **[FUN]** key for over 2s to enter general setting menu
2. Press **[CAL]/[SQL]** key to choose No.10 menu, LCD displays "LOCK--OFF".
3. Turn selector knob to select the desired setting.

- ▼ BU: Enable BCLO, Carrier lockout, transmitting is inhibited when current channel receives a matching carrier;press [PTT] to emit error voice prompt and back to receiving status.
 - ▼ RL: Enable BTLO, transmitting is inhibited when current channel receives a matching carrier but dis-matching CTCSS/DCS.press [PTT] to emit error voice prompt and back to receiving status.
 - ▼ OFF: Busy channel lockout is disabled.It can transmit in any receiving status.
4. Press **[TS/DCS]** key to confirm and exit.

EDITING CHANNEL NAME

1. Press and hold **[FUN]** key for over 2s to enter general setting menu.
2. Press **[CAL]/[SQL]** key to choose No.11 menu, LCD displays cursor and flashing.
3. Turn selector knob to select the desired letter,press **[TS/DCS]** key to confirm selected letter and enter into next edition,Press **[V/M]** to return forward edition.
4. After edition,press **[MHz]** key to exit.



In Frequency (VFO) mode ,this function will be auto-hidden.

REVERSE TX/RX

TX frequency turns to RX frequency & RX frequency changes to TX frequency. The signaling will also be reversed if CTCSS/DCS signaling exited in this channel.

1. Press and hold **[FUN]** key for over 2s to enter general setting menu
2. Press **[CAL]/[SQL]** key to choose No.12 menu, LCD displays "REV—OF".
3. Turn selector knob to select the desired setting.
 - ON:Enable Frequency Reverse
 - OFF:Disable Frequency Reverse.
4. After edition,press **[TS/DCS]** key to exit.

8

General Setting

TALK AROUND

By Talk Around function, you can directly communicate with other radios in your group in case the repeater is not activated or when you are out of the repeater range. The transceiver will transmit by RX frequency with its CTCSS/DCS signaling.

1. Press and hold **[FUN]** key for over 2s to enter general setting menu.
2. Press **[CAL]/[SQL]** key to choose No.13 menu, LCD displays "TALK--OF".
3. Turn selector knob to select the desired setting.
ON:Enable Talk Around
OFF:Disable Talk Around
4. After edition, press **[TS/DCS]** key to exit.

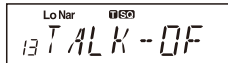
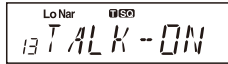

VOICE COMPANDER

Enable this function to reduce background noise and enhance audio clarity, especially in long range communication.

1. Press and hold **[FUN]** key for over 2s to enter general setting menu
2. Press **[CAL]/[SQL]** key to choose No.14 menu, LCD displays "COMP--OFF".
3. Turn selector knob to select the desired setting.
ON:Enable compander
OFF:Disable compander
4. Press **[TS/DCS]** key to confirm and exit.Default:OFF

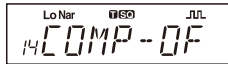
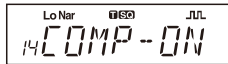

SCRAMBLER SETUP (ENCRYPTION)

An analog voice inversion scrambler can be equipped as optional.This special audio process can offer a more confidential communication.Other radios at same frequency will receive only disordered noises.

1. Press and hold **[FUN]** key for over 2s to enter general setting menu.
2. Press **[CAL]/[SQL]** key to choose No.15 menu, LCD displays "SCR--OF".
3. Turn selector knob to select the desired setting.
ON:Enable Scrambler
OF:Disable Scrambler
4. Press **[TS/DCS]** key to confirm and exit.Default:OFF.

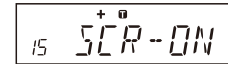

This function is optional

RADIO'S DTMF SELF ID ENQUIRY

1. Press and hold **[FUN]** key for over 2s to enter general setting menu.
2. Press **[CAL]/[SQL]** key to choose No.16 menu, LCD displays "D--XXX" XXX is radio's DTMF SELF ID.
3. Press **[TS/DCS]** key to confirm and exit.



RADIO'S 5TONE SELF ID ENQUIRY

1. Press and hold **[FUN]** key for over 2s to enter general setting menu.
2. Press **[CAL]/[SQL]** key to choose No.17 menu, LCD displays "F--XXXXX", "XXXXX" is radio's 5TONE SELF ID.
3. Press **[TS/DCS]** key to confirm and exit.

Lo Nar
17 F--12345

VOICE PROMPT

The prompting tone provides confirmation of entry, error status or malfunctions of the transceiver. You can enable or disable this function.

1. Press and hold **[FUN]** key for over 2s to enter general setting menu.
2. Press **[CAL]/[SQL]** key to choose No.18 menu, LCD displays "BEEP--ON".
3. Turn selector knob to select the desired setting.
ON:Enable voice prompt
OFF:Disable voice prompt
4. Press **[TS/DCS]** key to confirm and exit.Default:ON.

Lo Nar
18 BEEP--ON

Lo Nar
18 BEEP--OFF

Suggestion:Enable this function to check incorrect operation and malfunctions.
NOTE

TOT (TIME-OUT TIMER)

The time-out timer limits the amount of transmitting time. When you reach the time limit which has been programmed by your dealer, your transmission will be cut off. In order to transmit again, you must release PTT button to reset the timer.

1. Press and hold **[FUN]** key for over 2s to enter general setting menu.
2. Press **[CAL]/[SQL]** key to choose No.19 menu, LCD displays "TOT--3"
3. Turn selector knob to select the desired setting.
Timer:1-30min,each level 1min
OFF:Disable TOT
4. Press **[TS/DCS]** key to confirm and exit.Default:3.

Lo Nar
19 TOT--3

APO (AUTO POWER OFF)

Once APO is activated, the radio will be automatically switched off when the pre-set timer is running to end.

1. Press and hold **[FUN]** key for over 2s to enter general setting menu.
2. Press **[CAL]/[SQL]** key to choose No.20 menu, LCD displays "APO--OFF".
3. Turn selector knob to select the desired setting.
30MIN:Auto power off after 30m

Lo Nar A
20 APO--30

Lo Nar A
20 APO--OFF

8

General Setting

- 1HOUR:Auto power off after 1h
- 2HOUR:Auto power off after 2h
- OFF:Disable Auto power off
- 4. Press **[TS/DOS]** key to confirm and exit.Default:OFF

DTMF TRANSMITTING TIME

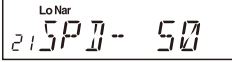
1. Press and hold **[FUN]** key for over 2s to enter general setting.
2. Press **[CAL]**/**[SQL]** key to choose No.21 menu, LCD displays"SPD--50".

3. Turn selector knob to select the desired setting. 30/50/100/200/300/500, which indicates the time for sending each DTMF signal & the interval between each DTMF being sent.
4. Press **[TS/DOS]** key to confirm and exit.Default:50MS.

SQUELCH LEVEL SETUP

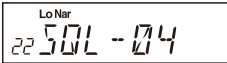
Setting the radio to a tight squelch level, you can avoid unwanted signals or noise, but you may not receive a weak signal. Therefore, it will be better for you to select the normal squelch level

1. Press and hold **[FUN]** key for over 2s to enter general setting menu.
2. Press **[CAL]**/**[SQL]** key to choose No.22 menu, LCD displays"SQL--04".

3. Turn selector knob to select the desired squelch level. OF-20 total 21,OF is min setting value(ON)

4. Press **[TS/DOS]** key to confirm and exit.Default:04





NOTE

Press **[SQL]**, then turn selector knob also can select the desired squelch level.
If the transceiver has set at higher squelch level, it may fail to hear the calling. If set at lower squelch level, the radio will be interfered.

SCAN DWELL TIME SETUP

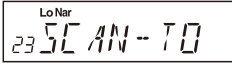
There are 3 kinds of Scan Dwell Time for option.

1. Press and hold **[FUN]** key for over 2s to enter general setting menu.

2. Press **[CAL]**/**[SQL]** key to choose No.23 menu, LCD displays"SCAN--TO".

3. Turn selector knob to select the desired Scan Dwell Time.
TO:it pauses 15s once scanning a matching signal, then resume scan.

CO:it pauses once scanning a matching signal, signal disappeared then resume scan.

SE:It stops once scanning a matching signal.

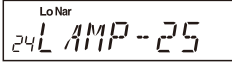
4. Press **[TS/DOS]** key to confirm the selection and exit.Default:TO.

LCD BACKLIGHT

1. Press and hold **[FUN]** key for over 2s to enter general setting menu.
2. Press **[CAL]**/**[SQL]** key to choose No.24

- menu, LCD displays "LAMP--25"
- Turn selector knob to select the desired LCD backlight brightness 1-32 total 32 level backlight brightness.
 - Press **[TS/DCS]** key to confirm and exit. Default: 25.

PILOT FREQUENCY

This function uses to start repeater. It needs a certain intensity Pilot Frequency to start dormant repeater. As usual, no need to send pilot frequency again once repeater started.

- Press and hold **[FUN]** key for over 2s to enter general setting.
- Press **[CAL]** / **[SQL]** key to choose No. 25 menu, LCD displays "TB--1750".
- Turn selector knob to select the desired pilot frequency.
 - 1750HZ: Pilot frequency 1750HZ
 - 2100HZ: Pilot frequency 2100HZ
 - 1000HZ: Pilot frequency 1000HZ
 - 1450HZ: Pilot frequency 1450HZ
- Press **[TS/DCS]** key to confirm the selection and exit. Default: 1750HZ

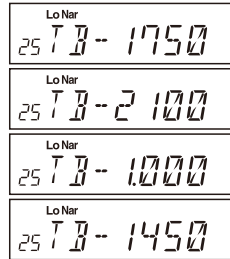

DISPLAY MODE SETUP

There are 3 different display modes: Frequency+Channel mode, Channel mode & Channel+Name Tag mode, .

- Press and hold **[FUN]** key for over 2s to enter general setting menu.

- Press **[CAL]** / **[SQL]** key to choose No. 26 menu, LCD displays "DSP--FR".
- Turn selector knob to select the desired mode.
 - FR: Frequency+Channel mode (Amateur transceiver mode).
 - CH: Channel mode (Professional transceiver mode).
 - NM: Channel+Name Tag mode (Amateur transceiver mode), if channel not named, it displays Frequency+Channel mode.
- Press **[TS/DCS]** key to confirm and exit. Default: FR.

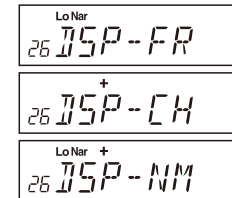

NOTE This function will be auto-hidden if channel mode locked. (Refer to programme software)

PIN SETUP

Enable this function, you have to insert a matching PIN to enter into normal status when radio is turned on. (Pin setup by programme software).

- Press and hold **[FUN]** key for over 2s to enter general setting menu.
- Press **[CAL]** / **[SQL]** key to choose No. 27 menu, LCD displays "CODE-OF".
- Turn selector knob to enable/disable Pin setup.
 - ON: Turn on Pin setup
 - OFF: Turn off Pin setup
- Press **[TS/DCS]** key to confirm and exit. Default: OFF

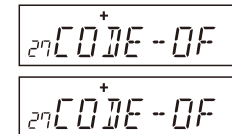



8

General Setting

ADDRESS LIST

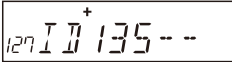
You store desired ID and corresponding ID name in address list. The LCD displays ID corresponding name if radio received ANI calling and find matching ID in address list.

1. Press and hold **[FUN]** key for over 2s to enter general setting menu.
2. Press **[CAL]**/**[SQL]** key to choose No.28 menu, LCD displays "BOOK".

3. Press **[MHz]** to enter into ID setting, press **[CAL]**/**[SQL]** to select the desired group (00-127, total is 128 group ID). Turn selector knob to select desired number, press **[TS/DCS]** confirm and move cursor to next edition, press **[V/M]** to clear out all digits.

4. After finishing edition, press **[MHz]** to confirm and enter into edition of current group's ID corresponding name. Turn selector knob to select desired letter, press **[TS/DCS]** to move cursor to next edition, Press **[V/M]** to clear out all letters. 00-127, total 128 group ID and corresponding ID name.
5. Press **[MHz]** to confirm and return into main menu. Repeat above Step 3 and Step 4 operations to edit multi-ID and corresponding ID name.
6. Press **[TS/DCS]** key to return into standby status.

FACTORY DEFAULT

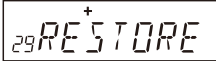
If your radio seems to be malfunctioning, resetting the microprocessor may solve the problem. When performing the reset, you may lose memory data and stored information. Back up or write down important data before performing the reset.

1. Press and hold **[FUN]** key for over 2s to enter general setting menu.



2. Press **[CAL]**/**[SQL]** key to choose No.29 menu, LCD displays "RESTORE".

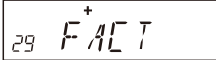

3. Turn selector knob to select the desired operation.

FACT: Resume factory default for channel, signaling and general setting.

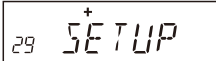

SETUP: Return initial setup for No.18-No 27 general setting menu.

4. Press **[MHz]** key to confirm.

Microphone Operation

9

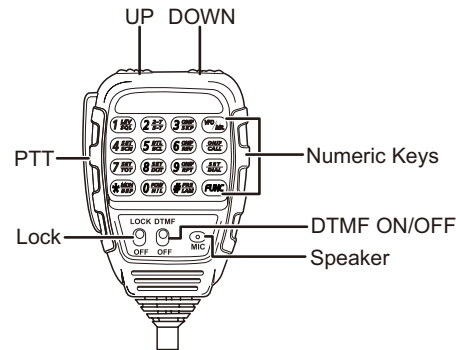

You can operate the transceiver by keypad or input desired frequency or channel through the QHM-03 microphone (Note:In professional transceiver mode,other keys are invalid except PTT,[**UP** / **DOWN**], **CALL** and **DATA**).

✘ KEYPAD LOCK

Pull down the slide switch to lock position,The lamp is turned off and all of keypads is not work except PTT switch.

✘ TRANSMITTING DTMF BY MICROPHONE KEYPAD

Slide DTMF key to DTMF position, press and hold the [PTT] key, transmitting the desired DTMF signaling by the numeric key directly. (Note:Slide DTMF key to DTMF position,the keyboard is invalid in standby).

■ FUNCTION SETUP BY MICROPHONE KEYPAD

Squelch off:In standby, press ***MCH OFF** key, the squelch is disabled when **BUSY** icon flashed in LCD, Press ***MCH ON** again to enable squelch and the **BUSY** icon disappears.

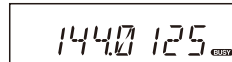

✘ SWITCHES BETWEEN VFO AND CHANNEL MODE

In standby,press **VFO/CH** key to switch between channel mode and Frequency mode (VFO).

✘ SHORT CALLING

In standby,press **CALL** to transmit the selected DTMF/2TONE/5TONE in current channel.

Transmitting DTMF Code:In standby,press **SET DATA**,LCD displays DTMF data and group.Press [**UP** / **DOWN**] key to select the desired transmitting DTMF group,then Press PTT to transmit.

If no DTMF data in current group,LCD displays "EMPTY",press **SET DATA** key again and input desired DTMF code by keypad,press PTT to transmit and store DTMF data.

■ SQUELCH LEVEL

1. In standby,press **FUNC**,then press **1 SQL**,LCD displays "SQL" and current squelch level.
2. Press **UP** / **DOWN** to adjust the desired squelch level.(press **FUNC**,then press **1 SQL**,turn selector knob also can adjust the desired squelch level.
3. Press number key to confirm and exit.

■ OPTIONAL SIGNALING

In standby,press **FUNC**,then press **2 SET** to add optional signaling,repeat above operation to set DTMF,2TONE or 5TONE signaling.

- ▼ When first bit of Exa byte in frequency displays "D",it indicates DTMF function enable.
- ▼ When first bit of Exa byte in frequency displays "T",it indicates 2Tone function enable.

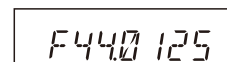
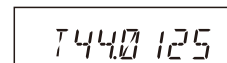
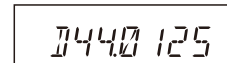

27

9

Microphone Operation

- ▼ When first bit of Exa byte in frequency displays "F",it indicates 5Tone function enable.



This function can be temporarily used in channel mode. Once the radio is turned off or switched to another channel, the temporary setting will be erased and back to initial settings.

■ SCAN SKIP

In Channel mode,press **[FUNC]** then press **[3^{ONE}SRF]**,decimal point displayed between frequency's ten digit and unit digit,it means current channel is scan skip. Repeat above operation to set scan or scan skip in current channel.

1. decimal point displayed between frequency's ten digit and unit digit,it means current channel is scanned skip.
2. decimal point is not displayed between frequency's ten digit and unit digit,it means current channel is scanned.

■ FREQUENCY/CHANNEL SCAN

In corresponding mode,press **[FUNC]** then press **[4^{SET}]** key to enter into scanning.

In scanning mode,press **[UP]** / **[DOWN]** to change scan direction.

■ BUSY CHANNEL LOCKOUT

BCLO is to disable transmitting while RX signal is received. Once the channel is busy and you press PTT, the radio will beep as warning and get back to receiving.

1. In standby,press **[FUNC]**, then press **[5^{BUCL}]** to enter into Busy Channel Lockout.
2. Press [**[UP]** / **[DOWN]**] to select the desired value.

BU: Enable BCLO, Carrier lockout, transmitting is inhibited when current channel receives a matching carrier;press [PTT] to emit error voice prompt.

RL: Enable BTLO, transmitting is inhibited when current channel receives a matching carrier but dis-matching CTCSS/DCS.press [PTT] to emit error voice prompt It can transmit in any receiving status.

OFF: Busy channel lockout is disabled.

3. Press number keys to confirm and exit.



This function can be temporarily used in Channel mode . Once the radio is turned off or switched to another channel, the temporary setting will be erased and back to initial settings.

■ REVERSE TX/RX

TX frequency turns to RX frequency & RX frequency changes to TX frequency. The signaling will also be reversed if CTCSS/DCS signaling existed in this channel.

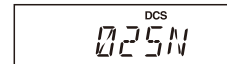

1. In standby,press **[FUNC]**, then press **[6^{REV}]**,LCD displays "REV—OF".
2. Press [**[UP]** / **[DOWN]**] to select the desired value.
ON:Enable Frequency Reverse
OFF:Disable Frequency Reverse
3. Press number keys to confirm and exit.



This function can be temporarily used in Channel mode . Once the radio is turned off or switched to another channel, the temporary setting will be erased and back to initial settings.

TOT (TIME-OUT TIMER)

The time-out timer limits the amount of transmitting time. When you reach the time limit which has been programmed by your dealer, your transmission will be cut off. In order to transmit again, you must release PTT button to reset the timer.

1. In standby, press **FUNC**, then press **7^{BEEP}** "LCD displays "TOT-X".
2. Press [**UP** / **DOWN**] to select the desired value.
3. Press number key to confirm and exit.

CTCSS/DCS ENCODE AND DECODE

1. In standby, press **FUNC**, then press **8^{SET}** to enter into CTCSS/DCS Encode and Decode.
2. Repeat above operation to set as below:
 - ▼ LCD displays T icon, it indicates CTCSS encode set in current channel.
 - ▼ LCD displays T and SQ icon, it indicates CTCSS encode and decode set in current channel.
 - ▼ LCD displays DCS icon, it indicates DCS encode and decode set in current channel.
3. In corresponding icon, press [**UP** / **DOWN**] to select the desired CTCSS/DCS encode and decode.
4. Press ***^{MON}** **BE^{EP}** **V/M**, or **C/SET** to confirm and exit.



NOTE

This function can be temporarily used in Channel mode. Once the radio is turned off or switched to another channel, the temporary setting will be erased and back to initial settings.

TALK AROUND

By Talk Around function, you can directly communicate with other radios in your group in case the repeater is not activated or when you are out of the repeater range. The transceiver will transmit by RX frequency with its CTCSS/DCS signaling.

1. In standby, press **FUNC**, then press **9^{OFF}** key, LCD displays "TALK--OF".
2. Press [**UP** / **DOWN**] to select the desired setting .
 - ON: Enable Talk Around
 - OFF: Disable Talk Around
3. Press number key to confirm and exit.



NOTE

This function can be temporarily used in Channel mode . Once the radio is turned off or switched to another channel, the temporary setting will be erased and back to initial settings.

VOICE PROMPT

The prompting tone provides confirmation of entry, error status or malfunctions of the transceiver. You can enable or disable this function.

1. In standby, press **FUNC**, then press ***^{MON}** **BE^{EP}**, LCD displays "BEEP--XX".
2. Press [**UP** / **DOWN**] to turn on/off BEEP voice prompt.
 - BEEP—OF : turn off voice prompt
 - BEEP—ON : turn on voice prompt
3. Press number key to exit and store.

LCD BACKLIGHT

1. In standby status, press **FUNC**, then press **#^{ERR}** LCD displays "LAMP-XX".
2. Press [**UP** / **DOWN**] to select desired backlight brightness (1-32 levels).
3. Press number keys to confirm and exit.



10

Long-distance Anti-theft Alarm

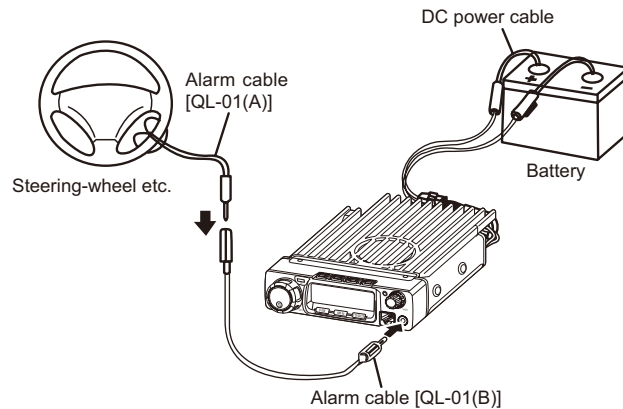
This function is mainly use for simple anti-theft alarm device in vehicles. When the transceiver be removed in an improper manner,the transceiver will emit and transmit alarming and background voice to system and other transceiver of the same frequency.



Connect DC power cable with car battery.

1. Connect the optional alarm cable QL-01(A) to the data jack on the front panel as shown. Secure the other end of the cable to an object that stays fixed in vehicle. (Note: if alarm cable QL-01 (A) is not enough long, you can choose optional alarm cable QL-01 (B) to extend).
2. When transceiver power off by press  key ,the long-distance anti-theft alarm enable. 
3. Note:The long-distance anti-theft alarm only available when transceiver power off .

4. When the alarm cable QL-01(A) or QL-01(B) is removed from the DATA jack or cut by improper sequence, the alarm function enable and will alarm as programmed. In alarming,the transceiver will stop alarm once receiving a matching signal. And alarm again when a matching signal disappeared.
5. Restart radio to cancel anti-theft alarming.Reconnect with alarm cable and turn off radio,the system will return to alarm mode.

This feature will copy the programmed data and parameters in the master unit to slave units. It copies the parameters and memory program settings.

1. Use optional CP50 cloning cable, connect the cable between the data jacks on both master and slave.
2. Press and hold **[FUN]** key, then press **[CAL]** key to enter into cloning mode, LCD displays "**CLONE**".

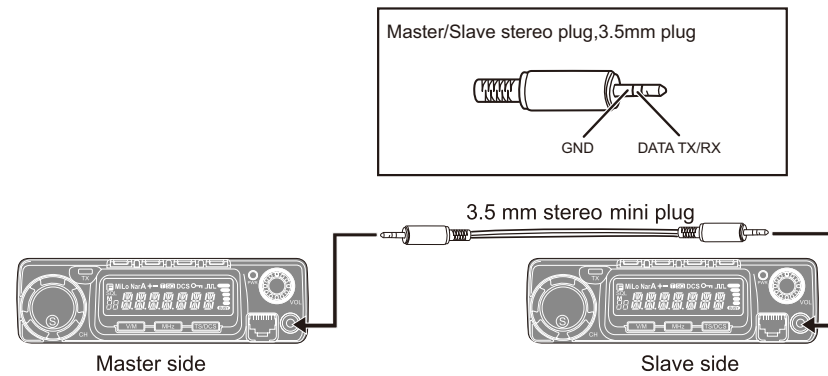

3. Press master unit's [PTT] key, LCD displays "SD XXX", "XXX" indicates data volume in transmitting. Slave unit displays "LD XXX", "XXX" indicates received data volume. When the transmission is successfully finished, the master and slave unit both display "**PASS**". Turn off the power, disconnect the cable and repeat step 2 to step 3 operations to clone the next slave unit.



NOTE If the data is not successfully transmitted, turn off both units, make sure the cable connection is correct and repeat the entire operation from the beginning.

12 Maintenance

■ DEFAULT SETTING AFTER RESETTING(VHF)

	588	DCS encode and decode	—
VFO frequency	145.00MHz	DCS code	023N
Memory channel 0–199	—	Output power	HI
Offset direction	—	Key-lock setting	OFF
Offset frequency	600KHz	TOT	OFF
Channel step	12.5KHz	APO	OFF
CTCSS encode and decode	—	Squelch Level	4
CTCSS frequency	88.5Hz		

■ TROUBLE SHOOTING

Problem	Possible Causes and Potential Solutions
(a) Power is on, nothing appears on Display.	+ and - polarities of power connection are reversed. Connect red lead to plus terminal and black lead to minus terminal of DC power supply.
(b) Fuse is blown.	Check and solve problem resulting in blown fuse and replace fuse with new fuse.
(c) Display is too dim.	Dimmer setting is "LAMP-L". Please make the dimmer setting "LAMP-H".
(d) No sound comes from speaker.	<ul style="list-style-type: none"> • Squelch is muted. Decrease squelch level. • Tone or CTCSS/DCS squelch is active. Turn CTCSS or DCS squelch off.
(e) Key and Dial do not function.	Key-lock function is activated. Cancel Key-lock function.
(i) Rotating Dial will not change memory channel.	Transceiver is in CALL mode. Press the VFO or memory mode.
(g) PTT key is pressed but transmission does not occur.	<ul style="list-style-type: none"> • Microphone connection is poor. Connect microphone properly. • Antenna connection is poor. Connect antenna properly.

Specifications 13

General	
Frequency Range	VHF: 136-174MHz
Number of Channels	200 channels
Channel Spacing	12.5K (Narrow band)
Phase-locked Step	12.5KHz
Operating Voltage	13.8V DC $\pm 15\%$
Squelch	Carrier/CTCSS/DCS/5Tone/2Tone/DTMF
Frequency Stability	± 2.5 ppm
Operating Temperature	-20°C~+60°C
Dimensions(WxHxD)	145 (W) x 47 (H) x 190 (L)mm
Weight	about 1.2Kg

 Specifications are subject to change without notice due to advancements in NOTE technology.

Receiver (ETSI EN 300 086 standard testing)	
Narrow band	
Sensitivity (12dB Sinad)	$\leq 0.35\mu V$
Adjacent Channel Selectivity	≥ 60 dB
Intermodulation	≥ 60 dB
Spurious Rejection	≥ 70 dB
Audio Response	+1~-3dB(0.3~2.55KHz)
Hum & Noise	≥ 40 dB
Audio distortion	$\leq 5\%$
Audio power output	> 2W@10%

Transmitter (ETSI EN 300 086 standard testing)	
Narrow band	
Power Output)	60W
Modulation	11KΦF3E
Adjacent Channel Power	≥ 60 dB
Hum & Noise	≥ 36 dB
Spurious Emission	≥ 60 dB
Audio Response	+1~-3dB(0.3~2.55KHz)
Audio Distortion	$\leq 5\%$

14 Attached Chart

50 GROUPS CTCSS TONE FREQUENCY(HZ)

67.0	79.7	94.8	110.9	131.8	156.7	171.3	186.2	203.5	229.1
69.3	82.5	97.4	114.8	136.5	159.8	173.8	189.9	206.5	233.6
71.9	85.4	100.0	118.8	141.3	162.2	177.3	192.8	210.7	241.8
74.4	88.5	103.5	123.0	146.2	165.5	179.9	196.6	218.1	250.3
77.0	91.5	107.2	127.3	151.4	167.9	183.5	199.5	225.7	254.1

1024 GROUPS DCS CODE.

000	001	002	003	004	005	006	007
010	011	012	013	014	015	016	017
020	021	022	023	024	025	026	027
030	031	032	033	034	035	036	037
040	041	042	043	044	045	046	047
050	051	052	053	054	055	056	057
060	061	062	063	064	065	066	067
070	071	072	073	074	075	076	077
100	101	102	103	104	105	106	107
110	111	112	113	114	115	116	117
120	121	122	123	124	125	126	127
130	131	132	133	134	135	136	137
140	141	142	143	144	145	146	147
150	151	152	153	154	155	156	157
160	161	162	163	164	165	166	167
170	171	172	173	174	175	176	177
200	201	202	203	204	205	206	207
210	211	212	213	214	215	216	217
220	221	222	223	224	225	226	227
230	231	232	233	234	235	236	237
240	241	242	243	244	245	246	247
250	251	252	253	254	255	256	257
260	261	262	263	264	265	266	267
270	271	272	273	274	275	276	277
300	301	302	303	304	305	306	307
310	311	312	313	314	315	316	317

Attached Chart

14

320	321	322	323	324	325	326	327
330	331	332	333	334	335	336	337
340	341	342	343	344	345	346	347
350	351	352	353	354	355	356	357
360	361	362	363	364	365	366	367
370	371	372	373	374	375	376	377
400	401	402	403	404	405	406	407
410	411	412	413	414	415	416	417
420	421	422	423	424	425	426	427
430	431	432	433	434	435	436	437
440	441	442	443	444	445	446	447
450	451	452	453	454	455	456	457
460	461	462	463	464	465	466	467
470	471	472	473	474	475	476	477
500	501	502	503	504	505	506	507
510	511	512	513	514	515	516	517
520	521	522	523	524	525	526	527
530	531	532	533	534	535	536	537
540	541	542	543	544	545	546	547
550	551	552	553	554	555	556	557
560	561	562	563	564	565	566	567
570	571	572	573	574	575	576	577
600	601	602	603	604	605	606	607
610	611	612	613	614	615	616	617
620	621	622	623	624	625	626	627
630	631	632	633	634	635	636	637
640	641	642	643	644	645	646	347
650	651	652	653	654	655	656	657
660	661	662	663	664	665	666	667
670	671	672	673	674	675	676	677

700	701	702	703	704	705	706	707
710	711	712	713	714	715	716	717
720	721	722	723	724	725	726	727
730	731	732	733	734	735	736	737
740	741	742	743	744	745	746	747
750	751	752	753	754	755	756	757
760	761	762	763	764	765	766	767
770	771	772	773	774	775	776	777

 **NOTE** N is positive code, I is negative code, total: 232groups.

SAFETY TRAINING INFORMATION



Your Qixiang Electron Science & Technology Co., Ltd radio generates RF electromagnetic energy during transmit mode. This radio is designed for and classified as “Occupational Use Only”, meaning it must be used only during the course of employment by individuals aware of the hazards, and the ways to minimize such hazards. This radio is NOT intended for use by the “General Population” in an uncontrolled environment.

This radio has been tested and complies with the FCC RF exposure limits for “Occupational Use Only”. In addition, your Qixiang Electron Science & Technology Co., Ltd radio complies with the following Standards and Guidelines with regard to RF energy and electromagnetic energy levels and evaluation of such levels for exposure to humans:

- ▮ FCC OET Bulletin 65 Edition 97-01 Supplement C, Evaluating Compliance with FCC Guidelines for Human Exposure to Radio Frequency Electromagnetic Fields.
- ▮ American National Standards Institute (C95.1-1992), IEEE Standard for Safety Levels with Respect to Human Exposure to Radio Frequency Electromagnetic Fields, 3 kHz to 300 GHz.
- ▮ American National Standards Institute (C95.3-1992), IEEE Recommended Practice for the Measurement of Potentially Hazardous Electromagnetic Fields— RF and Microwave.
- ▮ The following accessories are authorized for use with this product. Use of accessories other than those (listed in the instruction) specified may result in RF exposure levels exceed the FCC requirements for wireless RF exposure.



The information listed above provides the user with the information needed to make him or her aware of RF exposure, and what to do to as-sure that this radio operates with the FCC RF exposure limits of this radio.

Electromagnetic Interference/Compatibility

During transmissions, your Qixiang Electron Science & Technology Co., Ltd radio generates RF energy that can possibly cause interference with other devices or systems. To avoid such interference, turn off the radio in areas where signs are posted to do so. **DO NOT** operate the transmitter in areas that are sensitive to electromagnetic radiation such as hospitals, aircraft, and blasting sites.

Occupational/Controlled Use

The radio transmitter is used in situations in which persons are exposed as consequence of their employment provided those persons are fully aware of the potential for exposure and can exercise control over their exposure.

In order to comply with RF exposure requirements, a minimum distance of 200cm must be maintained between the antenna and all persons