



AT-778

FCC ID:T4KAT778V

USER'S MANUAL

MOBILE RADIO

Nice Housing, Stoutness & Stability, Advanced and Reliable functions, Perfect & Valuable. AT 778 mobile radio especially designs for drivers and it pursues company philosophy of innovation and practicality.

We only do best radio!



NOTE

When programming the transceiver, read the factory initial data firstly, then rewrite the frequency and signaling etc., otherwise errors may occur because of different frequency band etc..

AT-778 Mobile Radio Applicable Software: QPS778

Models Apply To This Manual: AT778 Mobile radio



MOBILE RADIO

Thank you for choosing this mobile radio vehicle transceiver, mobile radio always provides high quality products, And this transceiver is no exception. As you learn how to use this transceiver, you will find that mobile radio is pursuing "user friendliness". For example, each time you change the menu no. in Menu mode, you will see a text message on the display that lets you know what you are configuring.

Though friendly design for user, this transceiver is technically complicated and some features may be new to you. Consider this manual to be a personal tutorial from the designers, allow the manual to guide you through the learning process now, then act as a reference in the coming years.

Precautions

Please observe the following precautions to prevent fire, personal injury, or transceiver damage:

- ⚠ Do not attempt to configure your transceiver while driving, it is dangerous.
- ⚠ This transceiver is designed for a 13.8V DC power supply. Don't use a 24V battery to power on the transceiver.
- ⚠ Do not place the transceiver in excessively dusty, humid or wet areas, nor unstable surfaces.
- ⚠ Please keep it away from interferential devices (such as TV, generator etc.).
- ⚠ Do not expose the transceiver to long periods of direct sunlight nor place it close to heating appliances.
- ⚠ If an abnormal odor or smoke is detected coming from the transceiver, turn OFF the power immediately. Contact an Anytone service station or your dealer.
- ⚠ Do not transmit with high output power for extended periods; the transceiver may overheat.

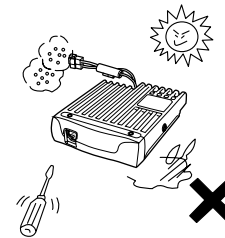

CONTENTS

New and Innovative Features	1	Transmitting Optional Signaling	13
Supplied Accessories/Optional Accessories	2	Channel Edit	13
Supplied Accessories.....	2	Channel Delete	13
Initial Installation	3	Shortcut Operations	14
Mobile Installation	3	Squelch Off/Squelch Off Momentary.....	14
DC Power Cable Connection	4	Squelch Level Setup	14
Power Supply Voltage Display	6	Frequency/Channel Scan	14
Antenna Connection	6	Channel Scan	14
Accessories Connections.....	7	CTCSS/DCS Encode and Decode Setup	14
Getting Acquainted	8	CTCSS Scan.....	15
Front panel.....	8	DCS Scan	15
Rear panel	9	Compander (Decrease the background noise and enhance audio clarity	15
Display	9	Offset Direction and Offset Frequency Setup	16
Microphone	10	Keypad Lockout	16
Working Mode(Amateur Transceiver or Professional Transceiver)	11	Current Voltage Enquiry.....	16
Basic Operations	12	Auto-Dialer Setup.....	16
Switching the Power On/Off	12	Transmitting Edited DTMF Tones in the Auto-dialer Memory.....	17
Adjusting the Volume	12	General Setting	18
Switch between VFO and Channel mode	12	Frequency Channel Step Setup	18
Adjusting Frequency/Channel Through Selector Knob	12	DTMF, DTMF ANI, 2Tone or 5Tone Signaling	18
Receiving	12	Sending 2-Tone Call.....	19
Transmitting	12	Sending 5-Tone Call.....	19
Transmitting Tone-Pulse	13	Sending DTMF call	19
		Signaling Combination Setup.....	19



CONTENTS

Band-width Selection	20	Squelch Level	27
TX OFF Setup.....	21	Optional Signaling	27
Busy Channel Lockout.....	21	Scan Skip	28
Editing Channel Name	21	Frequency/Channel Scan	28
Reverse TX/RX	21	Busy Channel Lockout.....	28
Talk Around	22	Reverse TX/RX.....	28
Voice Componder	22	TOT (Time-out timer).....	29
Scrambler Setup (Encryption).....	22	CTCSS/DCS Encode and Decode.....	29
Radio's DTMF SELF ID ENQUIRY	22	Talk Around	29
Radio's 5TONE SELF ID ENQUIRY	23	Voice Prompt.....	29
Voice Prompt.....	23	LCD Backlight	30
TOT (Time-out timer)	23	Long-distance Anti-theft Alarm	31
APO (Auto power off).....	23	Cable Clone	32
DTMF Transmitting Time.....	24	Programming Software Installing and Starting (in windows XP system)	33
Squelch Level Setup	24	Specifications	34
Scan Dwell Time Setup.....	24	Attached Chart.....	36
LCD Backlight	24	50 groups CTCSS Tone Frequency(Hz)	36
Pilot Frequency	25	1024 groups DCS Code.....	36
Display Mode Setup.....	25		
PIN Setup	25		
Address List	26		
Factory Default.....	26		
Microphone Operation	27		
Function Setup By Microphone Keypad.....	27		

New and Innovative Features

1

AT 778 Mobile Radio has nice housing, stoutness & stability, advanced and reliable functions, perfect & valuable. This amateur mobile radio especially designs for drivers and it pursues company philosophy of innovation and practicality. More functions as follows:

- ▼ Display on a large LCD with adjustable brightness, convenient for nighttime use. There are Amateur operation mode and Professional operation mode for option.
- ▼ Distribute buttons reasonably, convenient for operation. Adopt superior quality material, better technology and high quality radiator to ensure stable and durable operation.
- ▼ 200 programmable memorized channels, identified by editing name.
- ▼ Programming different CTCSS, DCS, 2Tone, 5Tone in per channel, rejecting extra calling from other radios.
- ▼ Various scan functions including CTCSS/DCS Scan function.
- ▼ Using 5Tone to send Message, Emergency alarm, Call all, ANI, Remotely kill, Remotely Waken, etc.
- ▼ Automatic calling Identification function by DTMF--ANI or 5Tone--ANI .
- ▼ Scramble function (Optional).
- ▼ Comander function for decrease the background noise and enhance audio clarity, it can set compander ON/OFF per channel.
- ▼ Theft alarm provides extra safety.

1

2

Supplied Accessories

■ SUPPLIED ACCESSORIES

After carefully unpacking the transceiver, identify the items listed in the table below. We suggest you keep the box and packaging.

- Transceiver

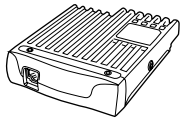

- Microphone (QHM-03)
(with DTMF keyboard)



- DC Power Cable with
Fuse Holder(QPL-01)



- User Manual



2

- Car Antenna
(QCA-01)
Antenna Gain:0dBi



Initial Installation

3

MOBILE INSTALLATION

To install the transceiver, select a safe, convenient location inside your vehicle that minimizes danger to your passengers and yourself while the vehicle is in motion. Consider installing the unit at an appropriate position so that knees or legs will not strike it during sudden braking of your vehicle. Try to pick a well ventilated location that is shielded from direct sunlight.

1. Install the mounting bracket in the vehicle using the supplied self-tapping screws (4pcs) and flat washers (4pcs).

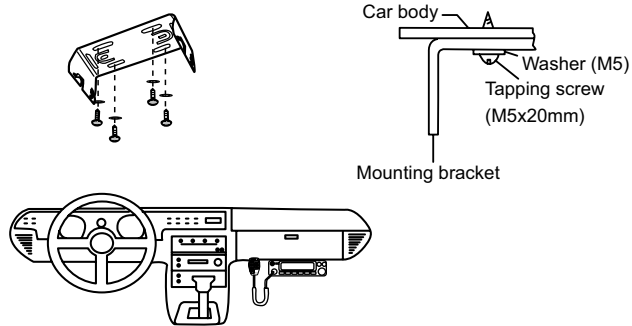

2. Position the transceiver, then insert and tighten the supplied hexagon SEMS screws.

- ▼ Double check that all screws are tightened to prevent vehicle vibration from loosening the bracket or transceiver.

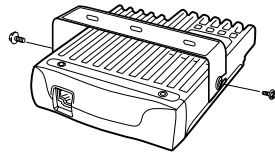

- ▼ Determine the appropriate angle of the transceiver, using the 3 screw hole positions on the side of the mounting bracket.

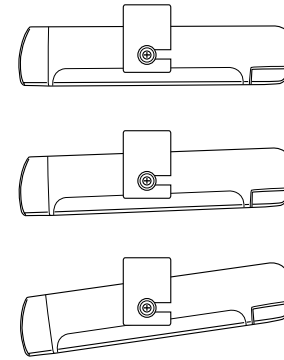

3

3

Initial Installation

DC POWER CABLE CONNECTION

 **NOTE** Locate the power input connector as close to the transceiver as possible.

MOBILE OPERATION

The vehicle battery must have a nominal rating of 12V. Never connect the transceiver to a 24V battery. Be sure to use a 12V vehicle battery that has sufficient current capacity. If the current to the transceiver is insufficient, the display may darken during transmission, or transmitting output power may drop excessively.

1. Route the DC power cable supplied with the transceiver directly to the vehicle's battery terminals using the shortest path from the transceiver.
 - ▼ We recommend you do not use the cigarette lighter socket as some cigarette lighter sockets introduce an unacceptable voltage drop.
 - ▼ The entire length of the cable must be dressed so it is isolated from heat, moisture, and the engine secondary (high voltage) ignition system/ cables.
2. After installing cable, in order to avoid the risk of damp, please use heat-resistant tap to tie together with fuse box. Don't forget to reinforce whole cable.
3. In order to avoid the risk of short circuit, please cut down connection with negative (-) of battery, then connect with radio.
4. Confirm the correct polarity of the connections, then attach the power cable to the battery terminals; red connects to the positive (+) terminal and black connects to the negative (-) terminal.
 - ▼ Use the full length of the cable without cutting off excess even if the cable is longer than required. In particular, never remove the fuse holders from the cable.
5. Reconnect any wiring removed from the negative terminal.

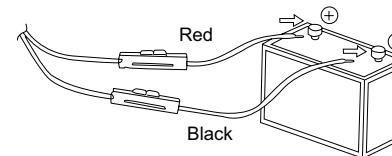

6. Connect the DC power cable to the transceiver's power supply connector.

▼ Press the connectors firmly together until the locking tab clicks.

If the ignition-key on/off feature is desired(optional feature), use the

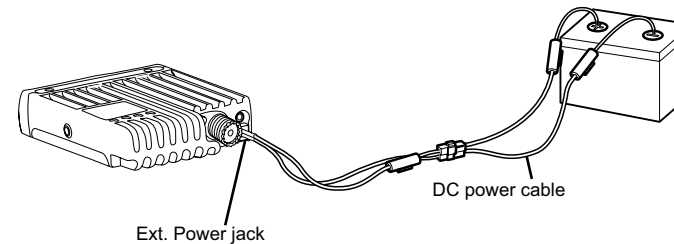

optional QCC-01(For Cigar-Plug connection) cable. Connect one of the cables between the ACC terminal or a Cigar-Plug that operates with the vehicle ignition or ACC switch on the vehicle and EXT POWER jack on the rear side of the unit.

 **NOTE** In many cars, the cigar-lighter plug is always powered. If this is the case, you cannot use it for the ignition key on/off function.

7. When the ignition key is turned to ACC or ON(Start) position with the radio turned off, the power switch illuminates. The illumination will be turned off when the ignition key is turned to the off position.

Initial Installation

3

To turn on the unit, press the power switch manually while it is illuminated. (While ignition key is at ACC or ON position)

8. When the ignition key is turned to ACC or ON position with the radio's power switch on, the unit turns on automatically and the power switch will be lit. Turn the ignition key to OFF position or manually turn the power switch off to shut down the radio.

9. Using extra cable, power consumption:5MAH.

10. Without this function, user can turn on/off radio by Power knob.

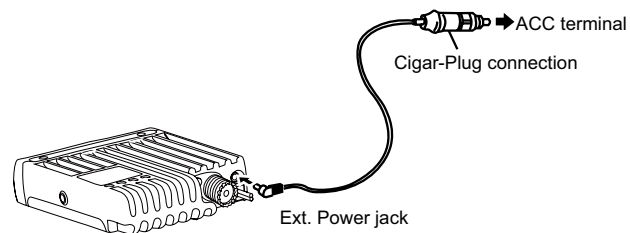

✘ FIXED STATION OPERATION

In order to use this transceiver for fixed station operation, you will need a separate 13.8V DC power supply (not included), power supply (QRP-01) as optional accessories. Please contact local dealer to require.

The recommended current capacity of your power supply is 12A.

1. Connect the DC power cable to the regulated DC power supply and ensure that the polarities are correct. (Red: positive, Black: negative).

▼ Do not directly connect the transceiver to an AC outlet.

- ▼ Use the supplied DC power cable to connect the transceiver to a regulated power supply.
- ▼ Do not substitute a cable with smaller gauge wires.

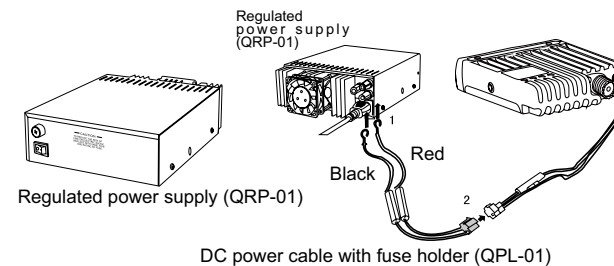

2. Connect the transceiver's DC power connector to the connector on the DC power cable.

▼ Press the connectors firmly together until the locking tab clicks.



NOTE

- ▼ Before connecting the DC power to the transceiver, be sure to switch the transceiver and the DC power supply OFF.
- ▼ Do not plug the DC power supply into an AC outlet until you make all connections.
- ▼ The EUT can be used on vehicle.

5

3

Initial Installation

✕ REPLACING FUSES

If the fuse blows, determine the cause, then correct the problem. After the problem is resolved, replace the fuse. If newly installed fuses continue to blow, disconnect the power cable and contact your authorized mobile radio dealer or an authorized mobile radio service center for assistance.

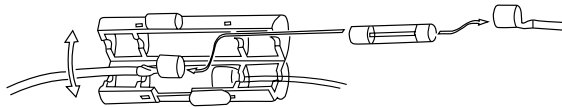

Fuse Location	Fuse Current Rating
Transceiver	15A
Supplied Accessory DC power cable	20A

6

Only use fuses of the specified type and rating, otherwise the transceiver could be damaged.



NOTE

If you use the transceiver for a long period when the vehicle battery is not fully charged, or when the engine is OFF, the battery may become discharged, and will not have sufficient reserves to start the vehicle. Avoid using the transceiver in these conditions.

■ POWER SUPPLY VOLTAGE DISPLAY

After connecting the transceiver to the power supply, the supply voltage can be displayed on LCD by pressing the **[FUN]** key together with the **[SQL]** key.

The display immediately changes as the voltage supply changes. It also displays voltage during transmission.

The transceiver will return to its normal operation when the power is switched ON or repeat above operation.

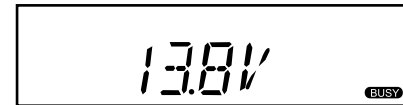

Important

The range of displayed voltage is only from 7V to 16V DC, because the displayed value is estimated, please use a voltmeter when a more precise reading is desired.

■ ANTENNA CONNECTION

Before operating, install an efficient, well-tuned antenna. The success of your installation will depend largely on the type of antenna and its correct installation. The transceiver can give excellent results if the antenna system and its installation are given careful attention.

Use a 50Ω impedance antenna and low-loss coaxial feed-line that has a characteristic impedance of 50Ω, to match the transceiver input impedance. Coupling the antenna to the transceiver via feed-lines having an impedance other than 50Ω reduces the efficiency of the antenna system and can cause interference to nearby broadcast television receivers, radio receivers, and other electronic equipment.



NOTE

Transmitting without first connecting an antenna or other matched load may damage the transceiver. Always connect the antenna to the transceiver before transmitting.
All fixed stations should be equipped with a lightning arrester to reduce the risk of fire, electric shock, and transceiver damage.

The possible locations of antenna on a car are shown as following:

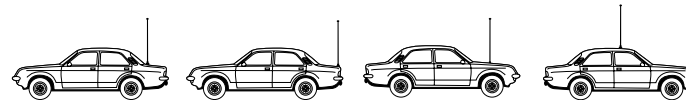

ACCESSORIES CONNECTIONS

EXTERNAL SPEAKER

If you plan to use an external speaker, choose a speaker with an impedance of 8Ω. The external speaker jack accepts a 3.5mm (1/8") mono (2-conductor) plug.

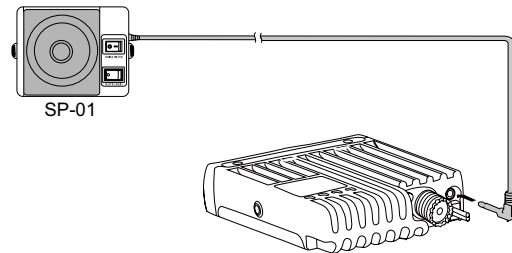

NOTE External speaker adopt double port BTL, please care about the connecting way. The speaker can not connect with the ground, otherwise the speaker will be fault. The wrong connecting way as the following picture.

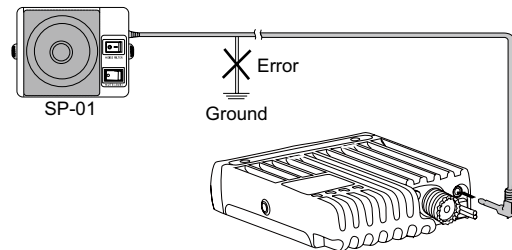

MICROPHONE

For voice communications, connect a microphone equipped with an 8-pin modular plug into the modular socket on the front of the main unit. Press firmly on the plug until the locking tab clicks. Attach the supplied microphone hanger in an appropriate location using the screws included in the screw set.

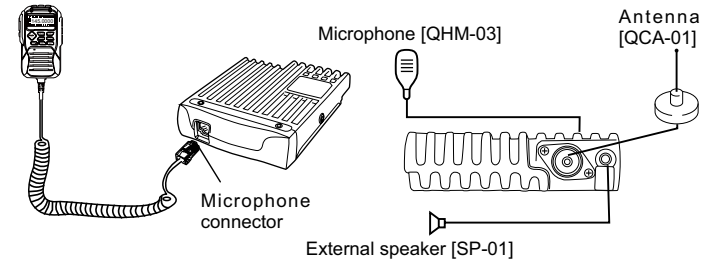

PC CONNECTING

To utilize the optional QPS-778 software, you must first connect the transceiver to your PC then using an optional programming cable PC50 (via Data socket).

Please use QPS-778 software for programming.

<http://www.qxdz.cn>

NOTE Ask your dealer about purchasing a Programming Cable PC50.

4

Getting Acquainted

FRONT PANEL

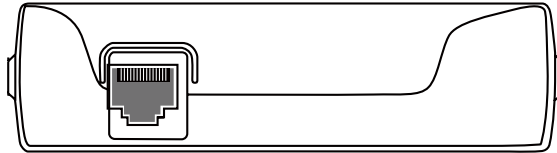

Basic Functions

NO.	KEY	FUNCTION
1	Pow(Power)	Power on/Off
2	VOL	Adjust Volume Key
3	Main Dial	Change frequency, memory channel and scan direction etc.
4	FUN/SET	Function Key
5	V/M/MW	Switches between VFO mode and Channel mode
6	MHz/SHIFT	Step Size Key (step:1MHz)
7	TS/DCS/LOCK	Sets CTCSS and DCS value
8	CAL	Call key
9	SQL/D	Squelch off
10	Data Terminal	Data reading/writing, cloning and theft alarm functions
11	TX	lights during Transmitting
12	Mic.connector	Microphone connection port

• Press key until icon appears then press the following key.

NO.	KEY	FUNCTION
4	FUN/SET	Confirms the selective functions and exit
5	V/M/MW	Stores data into channels
6	MHz/SHIFT	Sets offset direction and offset frequency
7	TS/DCS/LOCK	Sets Keypad lock function
9	SQL/D	Compander mode on/off

• Press key and following key together to activate following function:

NO.	KEY	FUNCTION
1	Pow(Power)	Reset to factory default settings
5	V/M/MW	Erase the memory
7	TS/DCS/LOCK	Auto dialer
8	CAL	Enters clone data function mode
9	SQL/D	Enters power supply voltage indication mode

• Functions that require continuous pressing following key to be activated

NO.	KEY	FUNCTION
4	FUN/SET	Press and hold for 2s to enter the Setting mode
9	SQL/D	Monitor mode

REAR PANEL

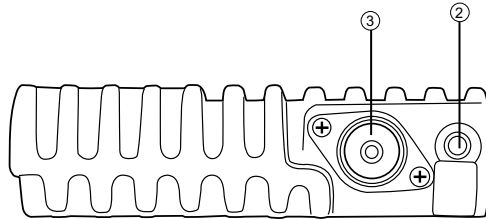

NO.	KEY	FUNCTION
1	Ext. Power Jack	Terminal for connecting optional cable QCC01 for use with ignition key On/Off function. The radio will auto power on when car is driving. The radio will auto power off when car stops.
2	Ext. Speaker Terminal	Terminal for optional external speaker SP01
3	Antenna Connector	Connection for 50Ω coaxial cable and antenna.

DISPLAY

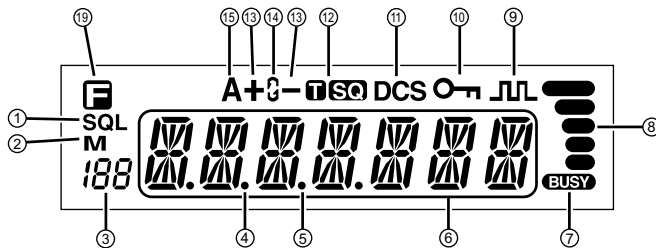

NO.	KEY	FUNCTION
1	SQL	Squelch level.
2	M	In channel mode.
3	188	Indicates the channel number in channel mode.
4	Decimal point	Channel skip.
5	Decimal point	Indicates the decimal point of frequency and the scanning function.
6	Frequency/Memory Name	Indicates the frequency or memory name.
7	BUSY	Signal is being received or monitor.
8	Signal Strength	Signal strength of receiving and transmitting.
9	Compander	Compander.
10	Keypad lock	Keypad lock .
11	DCS	Set DCS function.
12	CTCSS	Set CTCSS function.
13	+ -	Offset frequency direction.
14	Scramble	Scramble.
15	A	Auto power off.
16	Pressing [FUN] key.	Pressing [FUN] key.

4

Getting Acquainted

MICROPHONE

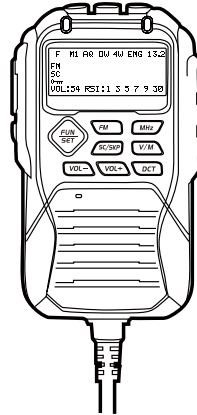

MIC Connector Diagram(in the front view of connector)

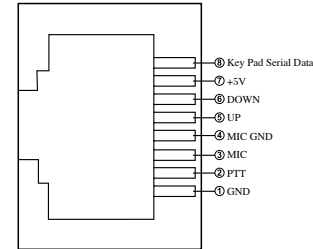

10

NO.	KEY	FUNCTION
1	UP	Increase frequency, channel number or setting value.
2	DOWN	Decrease frequency, channel number or setting value.
3	PTT	Press the PTT (Push-TO-Talk) key to transmit.
4	Number Key	Input VFO frequency or DTMF dial out etc..
5	DTMF ON / OFF	Switches between DTMF dialing or function operating.
6	LOCK Switch	Locks out the UP、Down、Numerical keys and Function keys.
7	MIC	Speak here during transmission.

WORKING MODE (AMATEUR TRANSCEIVER OR PROFESSIONAL TRANSCEIVER)

5

According to practical application, you can set the radio works as Amateur Transceiver mode or Professional Transceiver mode. There are also 2 levels operation menu to set functions as you need. It is easy and convenient (From No.1 to No.15 are channel function setup, From No.15 to No.29 are general setting setup).

1. Working Mode:

A. By programming software: In PC software's "General Setting" menu, choose "Display Mode" to select Amateur Transceiver mode or Professional Transceiver mode.

B. By manual setup: Please refer to "Display Mode" in Page 25.

2. Amateur Transceiver Mode: Except setting as "CH" mode, others considered as Amateur transceiver mode. Under this mode, press  key to switch between Channel mode and VFO mode .

A. Frequency + Channel mode: When set display as "FR", it enters into Frequency+Channel mode, new setting of channel operation and shortcut operation can be temporarily used by user. Once the radio is turned off or switched to another channel, the temporary setting will be erased and back to initial settings.

B. Channel+Name Tag Mode: When set display as "NM", it enters into Channel+Name Tag mode. At this mode, it will display corresponding channel name when the current channel is edited with name. Otherwise, it will display frequency+channel. Its operations are the same as frequency + channel mode.

C. VFO Mode(Frequency mode):

This mode shows only frequency on the display. Shortcut operation and Channel setting will be changed & stored as the latest value permanently. Once the radio is turned off or changed to new VFO frequency, the latest setting is remained until next change.(

3. Professional Transceiver Mode:When set display mode as "CH", it enters into Professional Transceiver mode.At this mode, except scan, other shortcut operation can't operate. And from No.1-17 menu in function setting will be auto-hidden, they should be set by PC software.If there is corresponding name for current channel, the LCD will display current channel name Otherwise, it shows current channel number. (As pic 4) (As pic 5)



(Pic 4)

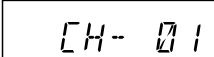

(Pic 5)

11



NOTE

If transceiver programmed as professional transceiver mode and locked, you can't return to amateur transceiver mode by manual operation from general setting.

4. Under every mode, from No.18-29 menu in general setting can be changed and saved.

6 Basic Operations

SWITCHING THE POWER ON/OFF

According to the option selected during installation Press the **POW** switch or turn the ignition key to ACC (speed up) or ON (startup) position to power on radio. Press the **POW** key for 1s or turn the ignition key to OFF position to turn off.

ADJUSTING THE VOLUME

Turn the VOL knob clockwise to increase the audio level, counterclockwise to decrease.



NOTE During communication, volume can be adjusted more accurate.

12

SWITCH BETWEEN VFO AND CHANNEL MODE

In standby, press **V/M** key or Microphone's **VFO/MHz** key until appear **M**, this indicates current channel in channel mode. Repeat above operation to switch between Frequency mode (VFO) and Channel mode.

ADJUSTING FREQUENCY/CHANNEL THROUGH SELECTOR KNOB

1. Under frequency (VFO) mode, you can change the current frequency to the desired one through selector knob; Turn clockwise to increase frequency; turn counterclockwise to decrease. Every gear will increase or decrease one step. Press **MHz** key, the decimal point of

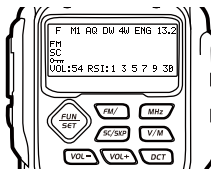

frequency in screen will be auto-hidden. In this status, turn selector knob or Microphone [**UP** / **DOWN**] key will increase or decrease frequency quickly by 1MHz step.

2. Under channel mode, you can change the current channel to the desired one through selector knob, clockwise turn to the forward channel, anticlockwise turn to the backward channel. In relative working mode, Microphone's [**UP** / **DOWN**] key has same function for adjusting frequency and channel.

RECEIVING

When the channel you are operating is called, the screen shows **BUSY** and field intensity, in this way, you can hear the calling from transmitting party.

NOTE If the transceiver has set at higher squelch level, it may fail to hear the calling.

When the channel you are operating is called, the screen shows **BUSY** and field intensity, you can't hear the calling from transmitting party, it means current channel receives a matching carrier but unmatching signaling(Refer to CTCSS/DCS encode and decode or Optional Signaling setup).

TRANSMITTING

Press and hold **SQ** key or press MIC's ***MON/REP** key to monitor for a while to confirm the channel desired is not busy. Release **SQ** or press Mic's ***MON/REP** key to return standby status, then press and hold **[PTT]** key to speak into microphone.

- ▼ Please hold the microphone approximately 2.5-5.0cm from your lips, and then speak into the microphone in your normal speaking voice to get best timbre.

 Press and hold [PTT] key, LED lights RED and power intensity showed in NOTE screen indicates it is transmitting, release to receive.





■ TRANSMITTING TONE-PULSE

Press and hold [PTT] key, then press Microphone [**DOWN**] key to transmit current selected tone-pulse signal.



■ TRANSMITTING OPTIONAL SIGNALING

Press and hold [PTT] key, then press Microphone **UP** key or press  key in front panel or press Mic's  key to transmit pre-stored and selected DTMF/2Tone/5Tone optional signaling.

■ CHANNEL EDIT

1. Under frequency mode (VFO), turn selector knob to select the desired frequency or input frequency by MIC's numeric keys.
2. Press  key to enter CTCSS/DCS signaling setup, turn selector knob to select the desired signaling.
3. Press  key, LCD appears  **M** icon and current channel number, **M** icon flashing means current channel is empty.
4. Turn selector knob to select the desired channel number to store.
5. Press  key,  **M** icon and channel number disappears and emit a prompt voice, thus the channel storage succeed.

■ CHANNEL DELETE





1. Under channel mode, turn selector knob to select channel which you want to delete.
2. Press  key and  key together, current channel will be deleted and emitted a prompt voice. **M** icon flashing means current channel is deleted.

7

Shortcut Operations

SQUELCH OFF/SQUELCH OFF MOMENTARY

 key programmed as Squelch Off or Squelch Off Momentary to monitor the weak signal.





1. Squelch Off: Press  key to disable squelch, press  key again to resume squelch.
2. Squelch Off Momentary: Press and hold  key to disable squelch, release  key to resume squelch.



NOTE The above functions should be set in programme software.

SQUELCH LEVEL SETUP





14 | Setting the radio to a tight squelch level, you can avoid unwanted signals or noise, but you may not receive a weak signal. Therefore, it will be better for you to select the normal squelch level.

1. While standby, press  key and turn selector knob until LCD appears **SQL** and current squelch level.
2. Turn selector knob or press MIC [ / ] key to set desired squelch level.
3. Press any key except  and  key to exit.

FREQUENCY/CHANNEL SCAN





✕ FREQUENCY SCAN

In frequency (VFO) mode, this function is designed to monitor signal of every communicative frequency point of transceiver "step size" you have set.

1. In VFO mode, press  for 1s to enter into frequency scan.
2. Turn selector knob or press Microphone [ / ] key to change scan direction.
3. Press any key except  and  key to exit.







CHANNEL SCAN

In channel mode, this function is designed to monitor signal in every channel.

1. In channel mode, Press  key for 1s to enter into channel scan.
2. Turn selector knob or press Microphone [ / ] key to change scan direction.
3. Press any key except  and  key to exit.

CTCSS/DCS ENCODE AND DECODE SETUP

Repeatedly press  key to check whether set CTCSS/DCS encode and decode in current channel or not.

1. When LCD appears  icon, it means current channel with CTCSS encode, turn selector knob or press Microphone's [ / ] key to select desired CTCSS encode.
2. When LCD appears  and  icon, it means current channel with CTCSS encode and decode, turn selector knob or press Microphone's [ / ] to select desired CTCSS code.

3. When LCD appears **DCS** icon, it means current channel can be set with DCS encode and decode together, turn selector knob or press Microphone's [**UP** / **DOWN**] to select desired DCS encode and decode.

M DCS
023N
4. CTCSS:62.5-254.1, Total 51groups; DCS:000N-777I total 1024 groups. **N** is positive code, **I** is inverse code.
5. Press any key except **FUN**, **POW** and **TS/DCS** keys to return into standby status.

 **NOTE** Under channel mode, this operation can be temporarily used by user. Once the radio is turned off or switched to another channel, the temporary setting will be erased.

■ CTCSS SCAN

Repeatedly press **TS/DCS** key until LCD displays **T** and **SC** icons, then hold **TS/DCS** key for 1S to enter into CTCSS scanning. Once finding a matching CTCSS signaling, it will stop for 15s then scan again.

■ DCS SCAN

Repeatedly press **TS/DCS** key until LCD displays **DCS** icons, then hold **TS/DCS** key for 1S to enter into DCS scanning. Once finding a matching DCS signaling, it will stop for 15s then scan again.

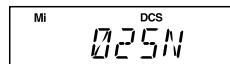

■ COMPANDER (DECREASE THE BACKGROUND NOISE AND ENHANCE AUDIO CLARITY)

Compander function will decrease the background noise and enhance audio clarity, especially in long range communication.

1. Press **FUN** key, then press **SOL** key to turn on compander function, repeat above operation again to turn off compander function.
2. When LCD appears **JL** icon, enable compander in current channel.
3. When LCD doesn't display **JL** icon, disable compander in current channel.

■ OFFSET DIRECTION AND OFFSET FREQUENCY SETUP

Repeater receives a signal(UP-LINK) on one frequency and re-transmits on another frequency(DOWN-LINK). The difference between these two frequencies is called the offset frequency. If the UP-LINK frequency higher than DOWN-LINK frequency, the direction is positive, If it is lower, the shift direction is negative.

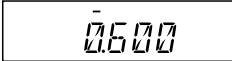
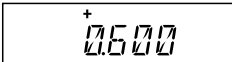
1. Press **[FUN]** key until the **[]** icon displays on the LCD, then press **[MHz]** key, LCD displays offset direction and offset frequency. 
2. Repeatedly press **[MHz]** key to select positive offset and negative offset.
3. When LCD displays "+" icon, it indicates positive offset, which means transmitting frequency higher than receiving frequency. 
4. When LCD displays "-" icon, it indicates negative offset, which means transmitting frequency lower than receiving frequency.
5. Turn selector knob or Mic's [**UP** / **DOWN**] key to change offset frequency, offset frequency changed as per stepping.
6. Press any key except **[FUN]** and **[MHz]** key to exit into standby.

 Under channel mode, this operation can be temporarily used by user.
NOTE Once the radio is turned off or switched to another channel, the temporary setting will be erased.

■ KEYPAD LOCKOUT

Avoiding unintentional operation, this function will lock main keys, all keys except **[SQL]**, **[FUN]** and **[POW]** key are invalid.

1. Press **[FUN]** key until LCD displays **[]** icon, then press **[TS/DCS]** key until, LCD displays **[]** icon, it indicates keypad lockout function is valid.
2. Repeat above operation, **[]** icon disappears, it indicates keypad lockout function is invalid.

■ CURRENT VOLTAGE ENQUIRY

This function will display Current Battery Voltage.

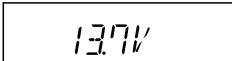
1. Press and hold **[FUN]** key, then press **[SQL]** key, LCD displays current battery voltage. 
2. Repeat above operation to return into VFO or Channel mode.

 In voltage display mode, all functions and channel or frequency selection are invalid.

■ AUTO-DIALER SETUP

This will automatically transmit pre-programmed and stored DTMF tones. And they are often used to remote control electronic devices or AUTOPATCH phone systems available on some repeater.

1. Press and hold **[FUN]** key, then press **[TS/DCS]** key to enter the auto-dialer enquiry mode, LCD displays current default data and current group displayed on left. If no data in current group, it shows "EMPTY".

2. Turn selector knob to choose group you desired. Total:16 group, 01-16.

3. Press **[SQL]** key to enter into editing of current group, press MIC's numeric keys to set your desired data.

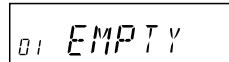
A rectangular LCD display showing the text '01' on the left and 'EMPTY' on the right.

4. The display scrolls when the 7th digit is entered. The numbers 0-9, --, A-D, * and # can be stored up to a total of 23 digits.

A rectangular LCD display showing '01' on the left, followed by seven dashes, and '123' on the right.

5. After editing, press PTT or **[CAL]** key to send current group and store edited DTMF signaling. Press **[SQL]** to exit and store.

A rectangular LCD display showing '01' on the left and '123' on the right.

■ TRANSMITTING EDITED DTMF TONES IN THE AUTO-DIALER MEMORY

1. Press **[FUN]** key, then press **[TS/DCS]** key to enter into auto-dialer enquiry
2. Turn selector knob to select desired transmitting group
3. Press PTT or **[CAL]** key to transmit current selected DTMF tones.

8

General Setting

1. Press and hold **[FUN]** key for over 2s to enter general setting menu.
2. Press **[CAL]** or **[SQL]** to select the desired function option.
3. Turn selector knob to select the desired setup.
4. Press **[TS/DCS]** to confirm and exit.

Meanwhile, if you want to edit channel name or start up menu, press **[V/M]** or **[TS/DCS]** to move forward or backward, Press **[MHZ]** to store and exit.

NOTE In Profession transceiver mode, the functions from No.1 to No.17 will be auto-hidden.

FREQUENCY CHANNEL STEP SETUP

Only in frequency (VFO) mode, this function is valid. Turn selector knob to select frequency or frequency scanning which is restricted by frequency step size.

1. Press and hold **[FUN]** key for over 2s to enter general setting menu.
2. Press **[CAL]**/**[SQL]** key to choose No.01 menu, LCD displays "STP--125".
3. Turn selector knob to select the desired frequency channel step. Channel step: 5K, 6.25K, 8.33K, 10K, 12.5K,
4. Press **[TS/DCS]** key to confirm and exit.

01 STP- 125

NOTE This function is auto-hidden in channel mode.

DTMF, DTMF ANI, 2TONE OR 5TONE SIGNALING

DTMF/5Tone/2Tone signalling function as similarly as CTCSS/DCS. Without receiving correspondent tone signalling, the speaker will remain mute. DTMF and 5Tone signalling can be applied for other advanced

features such as ANI, PTT ID, group call, remotely stun, remotely kill, waken,...etc.. The signalling edition must be done through programming software. Please refer to the HELP option in the programming software to know how to operate these features.

1. Press and hold **[FUN]** key for over 2s to enter into general setting menu.

2. Press **[CAL]**/**[SQL]** to choose No.2 menu, LCD displays "T-OFF".

02 T- DTMF

3. Turn selector knob to select the desired setup.

- ▼ "DTMF": The channel will be mute by a DTMF signal. The speaker won't be open until receiving a correspondent DTMF signal. Hold "PTT" then press [UP] or press **[CAL]** directly to transmit the pre-stored DTMF signaling.

NOTE In DTMF signaling mode, press **[CAL]** for 2s until LCD displays "AN---", turn selector knob to select desired digit (the other party ID). In this mode, press **[TS/DCS]** to confirm exist digit and move cursor to next, press **[V/M]** to forward cursor. After editing, press **[CAL]** key to operate ANI call.

- ▼ "2TONE": The channel will be mute by a 2-Tone signal. The speaker won't be open until receiving a correspondent 2-Tone signal. Hold "PTT" then press [UP] or press **[CAL]** directly to transmit the pre-stored 2-Tone signaling.

02 T- 2TONE

02 T- 5TONE

- ▼ "5Tone": The channel will be mute by a 5-Tone signal. The Speaker won't be open until receiving a correspondent 5-Tone signal. Hold "PTT" then press [UP] or

Press **[CAL]** directly to transmit the pre-stored 5-Tone signaling.

In 5Tone signaling mode, press **[CAL]** for 2s until LCD displays "AN--", turn selector knob to select desired digit(caller ID). In this mode, press **[TS/DCS]** to confirm exist digit and move cursor to next, press **[V/M]** to forward cursor. After editing, press **[CAL]** key to operate ANI call.



NOTE

4. Press **[TS/DCS]** key to confirm and exit.

SENDING 2-TONE CALL

1. Press and hold **[FUN]** key for over 2s to enter general setting menu.

2. Press **[CAL]**/**[SQL]** key to choose No.03 menu, LCD displays "2TON XX", "XX" indicates the group in the list.

03 2TON-00

3. Turn selector knob to select the desired sending 2TONE group, Press PTT to transmit selected group.

4. Total: 32groups, 00-31, Default: 00.

5. Press **[TS/DCS]** key to confirm and exit.

Content and name of 2TONE will be edited by programming software.
NOTE This radio only query edited group or name. If there is corresponding name for 2TONE, this operation will display 2TONE corresponding name.

SENDING 5-TONE CALL

1. Press and hold **[FUN]** key for over 2s to enter general setting menu

2. Press **[CAL]**/**[SQL]** key to choose No.04 menu, LCD displays "5TON XX", "XX" indicates the group in the list.

04 5TON-00

3. Turn selector knob to select the desired sending 5TONE group, Press PTT to transmit selected group.

4. Total: 100groups, 00-99, Default: 00.

5. Press **[TS/DCS]** key to confirm and exit.

Content and name of 5TONE will be edited by programming software. This radio only query edited group or name. If there is corresponding name for 5TONE, this operation will display 5TONE corresponding name.

SENDING DTMF CALL

1. Press and hold **[FUN]** key for over 2s to enter general setting menu.

2. Press **[CAL]**/**[SQL]** key to choose No.05 menu, LCD displays "DTMF XX", "XX" indicates the group in the list.

05 DTMF-01

3. Turn selector knob to select the desired sending DTMF group, Press PTT to transmit selected group.

4. Total: 16groups, 00-16, Default: 00.

5. Press **[TS/DCS]** key to confirm and exit.

SIGNALING COMBINATION SETUP

This function is to improve the level of protecting the radio against receiving irrelative signal.

8

General Setting

1. Press and hold **[FUN]** key for over 2s to enter general setting menu.

2. Press **[CAL]/[SQL]** key to choose No.06 menu, LCD displays "SPK--SQ".

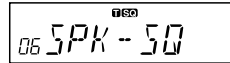

3. Turn selector knob to select the desired combination.

If select "SQ", it indicates you can hear the calling from caller when receive a matching carrier.

▼ If LCD displays "CTC", it indicates you can hear the calling from caller when receive a matching carrier and CTCSS/DCS signaling.

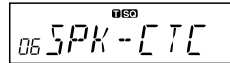

▼ If LCD displays "TON", it indicates you can hear the calling from caller when receive a matching carrier and DTMF/2TONE/5TONE signaling.

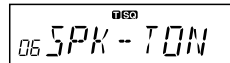

▼ If LCD displays "C*T", it indicates you can hear the calling from caller when receive a matching carrier and CTCSS/DCS and DTMF/2TONE/5TONE signaling.

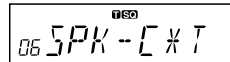

▼ If LCD displays "C/T", it indicates you can hear the calling from caller when receive a matching carrier and either CTCSS/DCS and DTMF/2TONE/5TONE signaling.

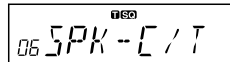

4. Press **[TS/DCS]** key to confirm and exit.

 **NOTE** This setting will be set together with adding optional signaling and CTCSS/DCS.

TX OFF SETUP

Disable this function, it is invalid to press PTT, current channel only works in RX mode.

1. Press and hold **[FUN]** key for over 2s to enter general setting menu.
2. Press **[CAL]/[SQL]** key to choose No.09 menu, LCD displays "TX-ON".
3. Turn selector knob to select the desired setting.
 - ON:** In current channel, Press PTT to transmit.
 - OFF:** In current channel, Press PTT is invalid.
4. Press **[TS/DCS]** key to confirm and exit. Default:ON.

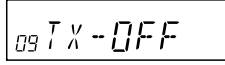
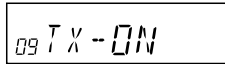

BUSY CHANNEL LOCKOUT

BCLO is to disable transmitting while RX signal is received. Once the channel is busy and you press PTT, the radio will beep as warning and get back to receiving.

1. Press and hold **[FUN]** key for over 2s to enter general setting menu.
2. Press **[CAL]/[SQL]** key to choose No.10 menu, LCD displays "LOCK--OFF".
3. Turn selector knob to select the desired setting.
 - ▼ BU: Enable BCLO, Carrier lockout, transmitting is inhibited when current channel receives a matching carrier; press [PTT] to emit error voice prompt and back to receiving status.

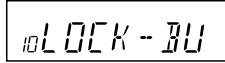

- ▼ RL: Enable BTLO, transmitting is inhibited when current channel receives a matching carrier but dis-matching CTCSS/DCS. Press [PTT] to emit error voice prompt and back to receiving status.
 - ▼ OFF: Busy channel lockout is disabled. It can transmit in any receiving status.
4. Press **[TS/DCS]** key to confirm and exit.

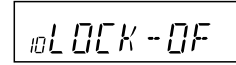
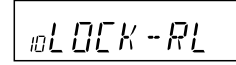

EDITING CHANNEL NAME

1. Press and hold **[FUN]** key for over 2s to enter general setting menu.
2. Press **[CAL]/[SQL]** key to choose No.11 menu, LCD displays cursor and flashing.
3. Turn selector knob to select the desired letter, press **[TS/DCS]** key to confirm selected letter and enter into next edition, Press **[V/M]** to return forward edition.
4. After edition, press **[MHZ]** key to exit.

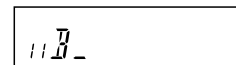

21

NOTE In Frequency (VFO) mode, this function will be auto-hidden.

REVERSE TX/RX

TX frequency turns to RX frequency & RX frequency changes to TX frequency. The signaling will also be reversed if CTCSS/DCS signaling existed in this channel.

1. Press and hold **[FUN]** key for over 2s to enter general setting menu

8

General Setting

2. Press **[CAL]/[SQL]** key to choose No.12 menu, LCD displays "REV—OF".
3. Turn selector knob to select the desired setting.
ON: Enable Frequency Reverse
OFF: Disable Frequency Reverse.
4. After edition, press **[TS/DCS]** key to exit.

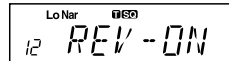

Lo Nar 12 REV-ON

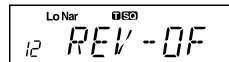

Lo Nar 12 REV-OFF

TALK AROUND

By Talk Around function, you can directly communicate with other radios in your group in case the repeater is not activated or when you are out of the repeater range. The transceiver will transmit by RX frequency with its CTCSS/DCS signaling.

- 22
1. Press and hold **[FUN]** key for over 2s to enter general setting menu.
 2. Press **[CAL]/[SQL]** key to choose No.13 menu, LCD displays "TALK—OF".
 3. Turn selector knob to select the desired setting.
ON: Enable Talk Around
OFF: Disable Talk Around
 4. After edition, press **[TS/DCS]** key to exit.

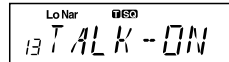

Lo Nar 13 TALK-ON

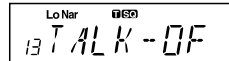

Lo Nar 13 TALK-OFF

VOICE COMPANDER

Enable this function to reduce background noise and enhance audio clarity, especially in long range communication.

1. Press and hold **[FUN]** key for over 2s to enter general setting menu.

2. Press **[CAL]/[SQL]** key to choose No.14 menu, LCD displays "COMP—OF".
3. Turn selector knob to select the desired setting.
ON: Enable compander
OFF: Disable compander
4. Press **[TS/DCS]** key to confirm and exit. Default:OFF

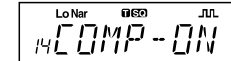

Lo Nar 14 COMP-ON

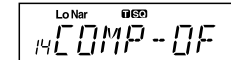

Lo Nar 14 COMP-OFF

SCRAMBLER SETUP (ENCRYPTION)

An analog voice inversion scrambler can be equipped as optionals. This special audio process can offer a more confidential communication. Other radios at same frequency will receive only disordered noises.

1. Press and hold **[FUN]** key for over 2s to enter general setting menu.
2. Press **[CAL]/[SQL]** key to choose No.15 menu, LCD displays "SCR—OF".
3. Turn selector knob to select the desired setting.
ON:Enable Scrambler
OFF:Disable Scrambler
4. Press **[TS/DCS]** key to confirm and exit.Default:OFF.

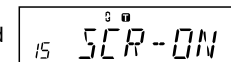

Lo Nar 15 SCR-ON

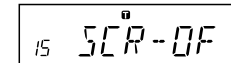

Lo Nar 15 SCR-OFF

 NOTE This function is optional.

RADIO'S DTMF SELF ID ENQUIRY

1. Press and hold **[FUN]** key for over 2s to enter general setting menu.
2. Press **[CAL]/[SQL]** key to choose No.16

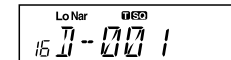

Lo Nar 16 1-001

- menu, LCD displays "D--XXX", "XXX" is radio's DTMF SELF ID.
 3. Press **[TS/DCS]** key to confirm and exit.

RADIO'S STONE SELF ID ENQUIRY

1. Press and hold **[FUN]** key for over 2s to enter general setting menu.
2. Press **[CAL]**/**[SQL]** key to choose No.17 menu, LCD displays "F--XXXXX", "XXXXX" is radio's 5TONE SELF ID.
3. Press **[TS/DCS]** key to confirm and exit.

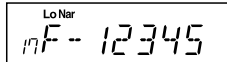

VOICE PROMPT

The prompting tone provides confirmation of entry, error status or malfunctions of the transceiver. You can enable or disable this function.

1. Press and hold **[FUN]** key for over 2s to enter general setting menu.
2. Press **[CAL]**/**[SQL]** key to choose No.18 menu, LCD displays "BEEP--ON".
3. Turn selector knob to select the desired setting.
ON: Enable voice prompt
OFF: Disable voice prompt
4. Press **[TS/DCS]** key to confirm and exit. Default:ON.

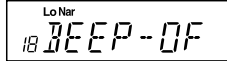
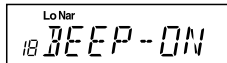

NOTE Suggestion:Enable this function to check incorrect operation and malfunctions.

TOT (TIME-OUT TIMER)

The time-out timer limits the amount of transmitting time. When you reach the time limit which has been programmed by your dealer, your transmission will be cut off. In order to transmit again, you must release PTT button to reset the timer.

1. Press and hold **[FUN]** key for over 2s to enter general setting menu.
2. Press **[CAL]**/**[SQL]** key to choose No.19 menu, LCD displays "TOT--3".
3. Turn selector knob to select the desired setting.
Timer: 1-30min, each level 1min
OFF: Disable TOT
4. Press **[TS/DCS]** key to confirm and exit. Default:3.

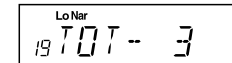

APO (AUTO POWER OFF)

Once APO is activated, the radio will be automatically switched off when the pre-set timer is running to end.

1. Press and hold **[FUN]** key for over 2s to enter general setting menu.
2. Press **[CAL]**/**[SQL]** key to choose No.20 menu, LCD displays "APO--OFF".
3. Turn selector knob to select the desired setting.
30MIN: Auto power off after 30m

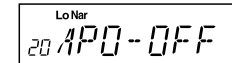
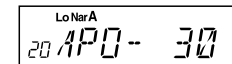

8

General Setting

- 1HOUR:** Auto power off after 1h
2HOUR: Auto power off after 2h
OFF: Disable Auto power off
4. Press **[TS/DCS]** key to confirm and exit. Default:OFF

DTMF TRANSMITTING TIME

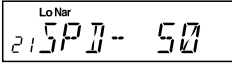
1. Press and hold **[FUN]** key for over 2s to enter general setting.
2. Press **[CAL]/[SQL]** key to choose No.21 menu, LCD displays "SPD--50".

3. Turn selector knob to select the desired setting. 30/50/100/200/300/500, which indicates the time for sending each DTMF signal & the interval between each DTMF being sent.
4. Press **[TS/DCS]** key to confirm and exit. Default:50MS.

24

SQUELCH LEVEL SETUP

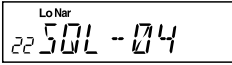
Setting the radio to a tight squelch level, you can avoid unwanted signals or noise, but you may not receive a weak signal. Therefore, it will be better for you to select the normal squelch level

1. Press and hold **[FUN]** key for over 2s to enter general setting menu.
2. Press **[CAL]/[SQL]** key to choose No.22 menu, LCD displays "SQL--04".

3. Turn selector knob to select the desired squelch level. OF-20 total 21, OF is min setting value(ON)

4. Press **[TS/DCS]** key to confirm and exit. Default:04



Press **[SQL]**, then turn selector knob also can select the desired squelch level.
If the transceiver has set at higher squelch level, it may fail to hear the calling. If set at lower squelch level, the radio will be interfered.

SCAN DWELL TIME SETUP

There are 3 kinds of Scan Dwell Time for option.



1. Press and hold **[FUN]** key for over 2s to enter general setting menu.
2. Press **[CAL]/[SQL]** key to choose No.23 menu, LCD displays "SCAN--TO".
3. Turn selector knob to select the desired Scan Dwell Time.

TO:It pauses 15s once scanning a matching signal, then resume scan.

CO:It pauses once scanning a matching signal, signal disappeared then resume scan.

SE:It stops once scanning a matching signal.

4. Press **[TS/DCS]** key to confirm the selection and exit.Default:TO.



LCD BACKLIGHT

1. Press and hold **[FUN]** key for over 2s to enter general setting menu.
2. Press **[CAL]/[SQL]** key to choose No.24

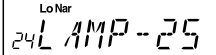

menu, LCD displays "LAMP--25".

3. Turn selector knob to select the desired LCD backlight brightness 1-32 total 32 level backlight brightness.
4. Press **[TS/DCS]** key to confirm and exit. Default:25.

PILOT FREQUENCY

This function uses to start repeater. It needs a certain intensity Pilot Frequency to start dormant repeater. As usual, no need to send pilot frequency again once repeater started.

1. Press and hold **[FUN]** key for over 2s to enter general setting.

2. Press **[CAL]**/**[SQL]** key to choose No.25 menu, LCD displays "TB--1750".

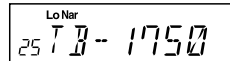

3. Turn selector knob to select the desired pilot frequency.

1750HZ:Pilot frequency 1750HZ

2100HZ:Pilot frequency 2100HZ

1000HZ:Pilot frequency 1000HZ

1450HZ:Pilot frequency 1450HZ

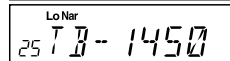
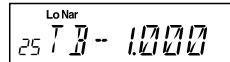
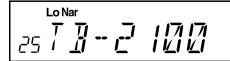

4. Press **[TS/DCS]** key to confirm the selection and exit. Default:1750HZ

DISPLAY MODE SETUP

There are 3 different display modes: Frequency+Channel mode, & Channel mode&Channel+Name Tag mode.

1. Press and hold **[FUN]** key for over 2s to enter general setting menu.

2. Press **[CAL]**/**[SQL]** key to choose No.26 menu, LCD displays "DSP--FR".

3. Turn selector knob to select the desired mode.

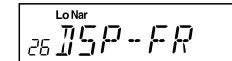

FR:Frequency+Channel mode(Amateur transceiver mode).

CH:Channel mode(Professional transceiver mode).

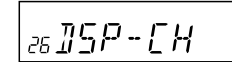

NM:Channel+Name Tag mode(Amateur transceiver mode), if channel not named, it displays Frequency+Channel mode.

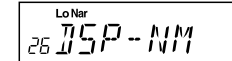

4. Press **[TS/DCS]** key to confirm and exit. Default:FR.

NOTE This function will be auto-hidden if channel mode locked.(Refer to programme software)

25

PIN SETUP

Enable this function, you have to insert a matching PIN to enter into normal status when radio is turned on.(Pin setup by programme software).

1. Press and hold **[FUN]** key for over 2s to enter general setting menu.

2. Press **[CAL]**/**[SQL]** key to choose No.27 menu, LCD displays "CODE-OF".

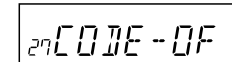

3. Turn selector knob to enable/disable Pin setup.

ON: Turn on Pin setup

OFF:Turn off Pin setup

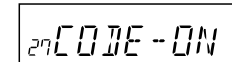

4. Press **[TS/DCS]** key to confirm and exit.Default:OFF

ADDRESS LIST

You store desired ID and corresponding ID name in address list. The LCD displays ID corresponding name if radio received ANI calling and find matching ID in address list.

1. Press and hold **[FUN]** key for over 2s to enter general setting menu.

2. Press **[CAL]**/**[SQL]** key to choose No.28 menu, LCD displays "BOOK".

28 BOOK

3. Press **[MHz]** to enter into ID setting, press **[CAL]**/**[SQL]** to select the desired group (00-127, total is 128 group ID). Turn selector knob to select desired number, press **[TS/DOS]** confirm and move cursor to next edition, press **[V/M]** to clear out all digits.

127 ID 135 --

127 JHONSON

4. After finishing edition, press **[MHz]** to confirm and enter into edition of current group's ID corresponding name. Turn selector knob to select desired letter, press **[TS/DOS]** to move cursor to next edition, Press **[V/M]** to clear out all letters. 00-127, total 128 group ID and corresponding ID name.

5. Press **[MHz]** to confirm and return into main menu. Repeat above Step 3 and Step 4 operations to edit multi-ID and corresponding ID name.

6. Press **[TS/DOS]** key to return into standby status.

FACTORY DEFAULT

If your radio seems to be malfunctioning, resetting the microprocessor may solve the problem. When performing the reset, you may lose memory data and stored information. Back up or write down important data before performing the reset.

1. Press and hold **[FUN]** key for over 2s to enter general setting menu.

2. Press **[CAL]**/**[SQL]** key to choose No.29 menu, LCD displays "RESTORE".

29 RESTORE

3. Turn selector knob to select the desired operation.

FACT:Resume factory default for channel, signaling and general setting.

29 FACT

SETUP:Return initial setup for No.18-No.27 general setting menu.

29 SETUP

4. Press **[MHz]** key to confirm.

Microphone Operation

9

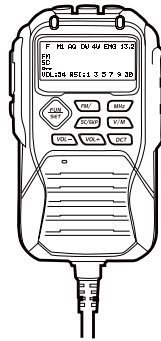

You can operate the transceiver by keypad or input desired frequency or channel through the QHM-03 microphone (Note:In professional transceiver mode, other keys are invalid except PTT, [**UP** / **DOWN**], **CALL** and **SET**).

✘ KEYPAD LOCK

Pull down the slide switch to lock position, the lamp is turned off and all of keypads is not work except PTT switch.

✘ TRANSMITTING DTMF BY MICROPHONE KEYPAD

Slide DTMF key to DTMF position, press and hold the [PTT] key, transmitting the desired DTMF signaling by the numeric key directly. (Note:Slide DTMF key to DTMF position, the keyboard is invalid in standby).

■ FUNCTION SETUP BY MICROPHONE KEYPAD

Squelch off:In standby, press ***MOP** key, the squelch is disabled when **BUSY** icon flashed in LCD, Press ***MOP** again to enable squelch and the **BUSY** icon disappears.

✘ SWITCHES BETWEEN VFO AND CHANNEL MODE

In standby, press **VFO/CH** key to switch between channel mode and Frequency mode (VFO).

✘ SHORT CALLING

In standby, press **CALL** to transmit the selected DTMF/2TONE/5TONE in current channel.

Transmitting DTMF Code:In standby, press **SET**, LCD displays DTMF data and group. Press [**UP** / **DOWN**] key to select the desired transmitting DTMF group, then Press PTT to transmit.

If no DTMF data in current group, LCD displays "EMPTY", press **SET** key again and input desired DTMF code by keypad, press PTT to transmit and store DTMF data.

■ SQUELCH LEVEL

1. In standby, press **FUNC**, then press **1LEV**, LCD displays "**SQL**" and current squelch level.
2. Press **UP** / **DOWN** to adjust the desired squelch level. (press **FUNC**, then press **1LEV**, turn selector knob also can adjust the desired squelch level.
3. Press number key to confirm and exit.

■ OPTIONAL SIGNALING

In standby, press **FUNC**, then press **2ST** to add optional signaling, repeat above operation to set DTMF, 2TONE or 5TONE signaling.

- ▼ When first bit of Exa byte in frequency displays "**D**", it indicates DTMF function enable.
- ▼ When first bit of Exa byte in frequency displays "**T**", it indicates 2Tone function enable.

27

9

Microphone Operation

- ▼ When first bit of Exa byte in frequency displays "F", it indicates 5Tone function enable.



This function can be temporarily used in channel mode. Once the radio is turned off or switched to another channel, the temporary setting will be erased and back to initial settings.

■ SCAN SKIP

In Channel mode, press **FUNC** then press **3**, decimal point displayed between frequency's ten digit and unit digit, it means current channel is scan skip. Repeat above operation to set scan or scan skip in current channel.

1. decimal point displayed between frequency's ten digit and unit digit, it means current channel is scanned skip.
2. decimal point is not displayed between frequency's ten digit and unit digit, it means current channel is scanned.

■ FREQUENCY/CHANNEL SCAN

In corresponding mode, press **FUNC** then press **4** key to enter into scanning.

In scanning mode, press **UP** / **DOWN** to change scan direction.

■ BUSY CHANNEL LOCKOUT

BCLO is to disable transmitting while RX signal is received. Once the channel is busy and you press PTT, the radio will beep as warning and get back to receiving.

1. In standby, press **FUNC**, then press **5** to enter into Busy Channel Lockout.

2. Press [**UP** / **DOWN**] to select the desired value.

BU: Enable BCLO, Carrier lockout, transmitting is inhibited when current channel receives a matching carrier; press [PTT] to emit error voice prompt.

RL: Enable BTLO, transmitting is inhibited when current channel receives a matching carrier but dis-matching CTCSS/DCS. Press [PTT] to emit error voice prompt It can transmit in any receiving status.

OFF: Busy channel lockout is disabled.

3. Press number keys to confirm and exit.



This function can be temporarily used in Channel mode. Once the radio is turned off or switched to another channel, the temporary setting will be erased and back to initial settings.

■ REVERSE TX/RX

TX frequency turns to RX frequency & RX frequency changes to TX frequency. The signaling will also be reversed if CTCSS/DCS signaling exited in this channel.

1. In standby, press **FUNC**, then press **6**, LCD displays "REV—ON".
2. Press [**UP** / **DOWN**] to select the desired value.

ON:Enable Frequency Reverse

OFF:Disable Frequency Reverse

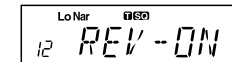

3. Press number keys to confirm and exit.



This function can be temporarily used in Channel mode. Once the radio is turned off or switched to another channel, the temporary setting will be erased and back to initial settings.

TOT (TIME-OUT TIMER)

The time-out timer limits the amount of transmitting time. When you reach the time limit which has been programmed by your dealer, your transmission will be cut off. In order to transmit again, you must release PTT button to reset the timer.

1. In standby, press **FUNC**, then press **7** LCD displays "TOT-X".
2. Press [**UP** / **DOWN**] to select the desired value.
3. Press number key to confirm and exit.

CTCSS/DCS ENCODE AND DECODE

1. In standby, press **FUNC**, then press **8** to enter into CTCSS/DCS Encode and Decode.
2. Repeat above operation to set as below:
 - ▼ LCD displays **T** icon, it indicates CTCSS encode set in current channel.
 - ▼ LCD displays **T** and **SQ** icon, it indicates CTCSS encode and decode set in current channel.
 - ▼ LCD displays **DCS** icon, it indicates DCS encode and decode set in current channel.
3. In corresponding icon, press [**UP** / **DOWN**] to select the desired CTCSS/DCS encode and decode.
4. Press ***MON**, **SET**, **CALL** or **VFO/VR** to confirm and exit.



NOTE

This function can be temporarily used in Channel mode. Once the radio is turned off or switched to another channel, the temporary setting will be erased and back to initial settings.

TALK AROUND

By Talk Around function, you can directly communicate with other radios in your group in case the repeater is not activated or when you are out of the repeater range. The transceiver will transmit by RX frequency with its CTCSS/DCS signaling.

1. In standby, press **FUNC**, then press **9** key, LCD displays "TALK--OF".
2. Press [**UP** / **DOWN**] to select the desired setting.
 - ON**: Enable Talk Around
 - OFF**: Disable Talk Around
3. Press number key to confirm and exit.



NOTE

This function can be temporarily used in Channel mode. Once the radio is turned off or switched to another channel, the temporary setting will be erased and back to initial settings.

VOICE PROMPT

The prompting tone provides confirmation of entry, error status or malfunctions of the transceiver. You can enable or disable this function.

1. In standby, press **FUNC**, then press ***MON**, LCD displays "BEEP--XX".
2. Press [**UP** / **DOWN**] to turn on/off BEEP voice prompt.
 - BEEP—OF**: turn off voice prompt
 - BEEP—ON**: turn on voice prompt
3. Press number key to exit and store.

LCD BACKLIGHT

1. In standby status, press **FUNC**, then press **#機** LCD displays "LAMP-XX".
2. Press [**UP** / **DOWN**] to select desired backlight brightness(1-32 levels).
3. Press number keys to confirm and exit.

Long-distance Anti-theft Alarm

10

This function is mainly use for simple anti-theft alarm device in vehicles. When the transceiver be removed in an improper manner, the transceiver will emit and transmit alarming and background voice to system and other transceiver of the same frequency.

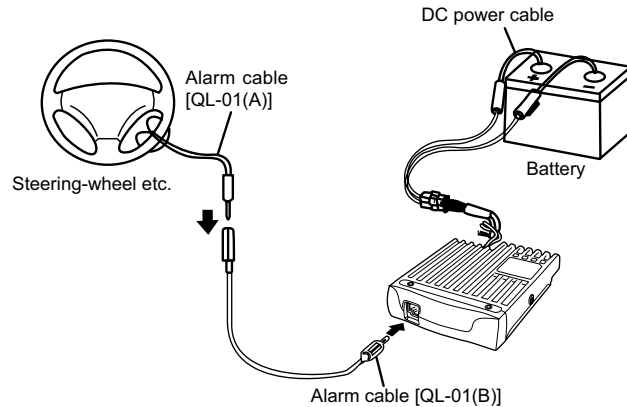

Connect DC power cable with car battery.

1. Connect the optional alarm cable QL-01(A) to the data jack on the front panel as shown. Secure the other end of the cable to an object that stays fixed in vehicle. (Note: if alarm cable QL-01 (A) is not enough long, you can choose optional alarm cable QL-01 (B) to extend).
2. When transceiver power off by press  key, the long-distance anti-theft alarm enable.

 **NOTE** The long-distance anti-theft alarm only available when transceiver power off.

3. When the alarm cable QL-01(A) or QL-01(B) is removed from the DATA jack or cut by improper sequence, the alarm function enable and will alarm as programmed. In alarming, the transceiver will stop alarm once receiving a matching signal. And alarm again when a matching signal disappeared.
4. Restart radio to cancel anti-theft alarming. Reconnect with alarm cable and turn off radio, the system will return to alarm mode.

11

Cable Clone

This feature will copy the programmed data and parameters in the master unit to slave units. It copies the parameters and memory program settings.

1. Use optional CP50 cloning cable, connect the cable between the data jacks on both master and slave.
2. Press and hold **[FUN]** key, then press **[CAL]** key to enter into cloning mode, LCD displays "**CLONE**".
3. Press master unit's [PTT] key, LCD displays "**SD XXX**", "**XXX**" indicates data volume in transmitting. Slave unit displays "**LD XXX**", "**XXX**" indicates received data volume. When the transmission is successfully finished, the master and slave unit both display "**PASS**". Turn off the power, disconnect the cable and repeat step 2 to step 3 operations to clone the next slave unit.



NOTE If the data is not successfully transmitted, turn off both units, make sure the cable connection is correct and repeat the entire operation from the beginning.

Double click "QPS778 setup.exe", then follow the installing instruction.

INSTALL USB CABLE DRIVER PROGRAMME

1. Click start menu in computer, under "ALL PROGRAMS" menu, choose and click "USB To Com port" in QPS778 program, install "USB To Com port" driver by indication.
2. Connect the optional PC50 USB Programming cable to USB port in PC with transceiver.(As pic 1)
3. Double click QPS778 shortcut or click QPS778 in procedure index of start menu, choose serial com port as indicated then click OK to start programming software. (As pic 2)
4. According to instruction, select correct "COM Port"(As pic 3), then click "OK" to start programming software.

Note:Even in same computer, the selective COM Port is different when USB cable connects with different USB port.

You shall install software before connecting the USB cable line. Switch on transceiver before writing frequency. You had better not switch on or off the power supply of transceiver when it is connected with computer, otherwise, it will make transceiver unable to read or write frequency. In this case, you have to turn off programming software, pull out USB cable, then reinsert USB cable and open software, then rechoose COM Port, it will turn into normal operation. Therefore, please connect transceiver with computer after switching on the transceiver. Don't restart transceiver power when it is connected with computer.

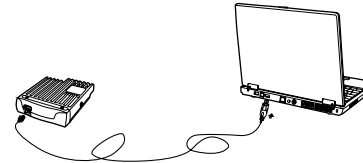

(As pic 1)

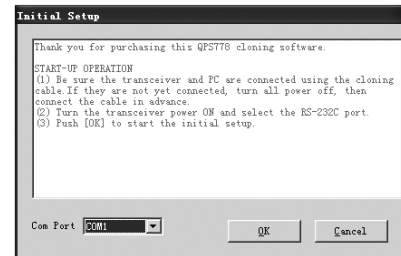

(As pic 2)

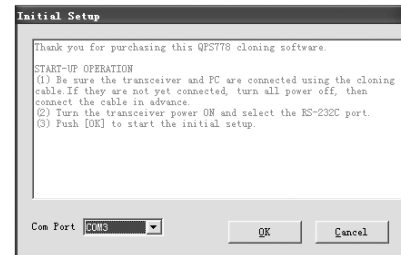

(As pic 3)

NOTE This software has product identify system, so when firstly installing the software, you have to connect the products, otherwise you can not start the software.

13 Specifications

General			
Frequency Range			
Frequency Range	Band A	TX & RX	136-174MHz
	Band B		
Number of channels		200	
Operation mode		F3E (FM)	
Antenna Impedance		50Ω	
Working temperature		-20°C~+60°C	
Power Supply		13.8V DC±15% (11.7~15.8V)	
Grounding Method		Negative ground	
Current Drain	TX	Low	Less than 3.0 A
	RX	Less than 0.8A Max.	
Frequency Stability		±2.5ppm	
Dimensions (W x H x D)		Microphone: 110 x 30 x 143 mm	
With projections		Body: 65 x 38 x 106 mm	
Weight		Approx. 0.8kg	

TRANSMITTER	
Power Output	25W
Maximum frequency deviation	±2.5kHz
Spurious emission	70dB
Adjacent channel power	60dB
Noise and hum ratio	36dB
Microphone Impedance	1KΩ
RECEIVER	
Sensitivity (12dB SINAD)	0.25μV or less
Squelch Sensitivity	0.126μV or less
Adjacent channel selectivity	60dB
Intermodulation rejection ratio	60dB
Spurious and image rejection ratio	70dB
Audio Output (16Ω, 10% distortion)	0.5W or higher (10% distortion)
Audio Output Impedance	16Ω

15 Attached Chart

■ 50 GROUPS CTCSS TONE FREQUENCY(HZ)

67.0	79.7	94.8	110.9	131.8	156.7	171.3	186.2	203.5	229.1
69.3	82.5	97.4	114.8	136.5	159.8	173.8	189.9	206.5	233.6
71.9	85.4	100.0	118.8	141.3	162.2	177.3	192.8	210.7	241.8
74.4	88.5	103.5	123.0	146.2	165.5	179.9	196.6	218.1	250.3
77.0	91.5	107.2	127.3	151.4	167.9	183.5	199.5	225.7	254.1

■ 1024 GROUPS DCS CODE.

000	001	002	003	004	005	006	007
010	011	012	013	014	015	016	017
020	021	022	023	024	025	026	027
030	031	032	033	034	035	036	037
040	041	042	043	044	045	046	047
050	051	052	053	054	055	056	057
060	061	062	063	064	065	066	067
070	071	072	073	074	075	076	077
100	101	102	103	104	105	106	107
110	111	112	113	114	115	116	117
120	121	122	123	124	125	126	127
130	131	132	133	134	135	136	137
140	141	142	143	144	145	146	147
150	151	152	153	154	155	156	157
160	161	162	163	164	165	166	167
170	171	172	173	174	175	176	177
200	201	202	203	204	205	206	207
210	211	212	213	214	215	216	217
220	221	222	223	224	225	226	227
230	231	232	233	234	235	236	237
240	241	242	243	244	245	246	247
250	251	252	253	254	255	256	257
260	261	262	263	264	265	266	267
270	271	272	273	274	275	276	277
300	301	302	303	304	305	306	307
310	311	312	313	314	315	316	317

Attached Chart

15

320	321	322	323	324	325	326	327
330	331	332	333	334	335	336	337
340	341	342	343	344	345	346	347
350	351	352	353	354	355	356	357
360	361	362	363	364	365	366	367
370	371	372	373	374	375	376	377
400	401	402	403	404	405	406	407
410	411	412	413	414	415	416	417
420	421	422	423	424	425	426	427
430	431	432	433	434	435	436	437
440	441	442	443	444	445	446	447
450	451	452	453	454	455	456	457
460	461	462	463	464	465	466	467
470	471	472	473	474	475	476	477
500	501	502	503	504	505	506	507
510	511	512	513	514	515	516	517
520	521	522	523	524	525	526	527
530	531	532	533	534	535	536	537
540	541	542	543	544	545	546	547
550	551	552	553	554	555	556	557
560	561	562	563	564	565	566	567
570	571	572	573	574	575	576	577
600	601	602	603	604	605	606	607
610	611	612	613	614	615	616	617
620	621	622	623	624	625	626	627
630	631	632	633	634	635	636	637
640	641	642	643	644	645	646	647
650	651	652	653	654	655	656	657
660	661	662	663	664	665	666	667
670	671	672	673	674	675	676	677

700	701	702	703	704	705	706	707
710	711	712	713	714	715	716	717
720	721	722	723	724	725	726	727
730	731	732	733	734	735	736	737
740	741	742	743	744	745	746	747
750	751	752	753	754	755	756	757
760	761	762	763	764	765	766	767
770	771	772	773	774	775	776	777

 **NOTE** N is positive code, I is negative code, total: 232groups.

SAFETY TRAINING INFORMATION



Your Qixiang Electron Science & Technology Co.,Ltd. radio generators RF electromagnetic energy during transmit mode. This radio is designed for and classified as "Occupational Use Only", meaning it must be used only during the course of employment by individuals aware of the hazards, and the ways to minimize such hazards. This radio is NOT intended for use by the "General Population" in an uncontrolled environment. This radio has been tested and complies with the FCC RF exposure limits for "Occupational Use Only". In addition, your Qixiang Electron Science & Technology Co.,Ltd. radio complies with the following Standards and Guidelines with regard to RF energy and electromagnetic energy levels and evaluation of such levels for exposure to humans:

- ◆ FCC OET Bulletin 65 Edition 97-01 Supplement C, Evaluating Compliance with FCC Guidelines for Human Exposure to Radio Frequency Electromagnetic Fields.
- ◆ American National Standards Institute (C95.1-1992), IEEE Standard for Safety Levels with Respect to Human Exposure to Radio Frequency Electromagnetic Fields, 3 kHz to 300 GHz.
- ◆ American National Standards Institute (C95.3-1992), IEEE Recommended Practice for the Measurement of Potentially Hazardous Electromagnetic Fields—RF and Microwave.
- ◆ The following accessories are authorized for use with this product. Use of accessories other than those (listed in the instruction) specified may result in RF exposure levels exceed the FCC requirements for wireless RF exposure.



To ensure you're your exposure to RF electromagnetic energy is within the FCC allowable limits for occupational use, always adhere to the following guidelines

The information listed above provides the user with the information needed to make him or her aware of RF exposure, and what to do to assure that this radio operates with the FCC RF exposure limits of this radio.

Electromagnetic Interference/Compatibility

During transmissions, Qixiang Electron Science & Technology Co.,Ltd. radio generates RF energy that can possibly cause interference with other devices or systems. To avoid such interference, turn off the radio in areas where signs are posted to do so. **DO NOT** operate the transmitter in areas that are sensitive to electromagnetic radiation such as hospitals, aircraft, and blasting sites.

Occupational/Controlled Use

The radio transmitter is used in situations in which persons are exposed as consequence of their employment provided those persons are fully aware of the potential for exposure and can exercise control over their exposure.

In order to comply with RF exposure requirements, a minimum distance of 44.4 cm must be maintained between the antenna and all persons

SAFETY TRAINING INFORMATION

WARNING:

This radio generates RF electromagnetic energy during transmission. This radio is designed for and classified as "Occupational Use Only", meaning it must be used only during the course of employment by individuals aware of the hazards, and the ways to minimize such hazards. This radio is NOT intended for use by the "General Population" in an uncontrolled environment.

- For compliance with FCC and Industry Canada RF Exposure Requirements, the transmitter antenna installation shall comply with the following two conditions:

1. The transmitter antenna gain shall not exceed 0 dBi.
2. The antenna is required to be located outside of a vehicle and kept at a distance of 44.4 centimeters or more between the transmitting antenna of this device and any persons during operation. For small vehicle as worst case, the antenna shall be located on the roof top at any place on the centre line along the vehicle in order to achieve 44.4 centimeters separation distance. In order to ensure this distance is met, the installation of the antenna must be mounted at least 44.4 centimeters away from the nearest edge of the vehicle in order to protect against exposure to bystanders.

CAUTION:

To ensure that your exposure to RF electromagnetic energy is within the FCC allowable limits for occupational use, always adhere to the following guidelines:

- DO NOT operate the radio without a proper antenna attached, as this may damage the radio and may also cause you to exceed FCC

RF exposure limits. A proper antenna is the antenna supplied with this radio by the manufacturer or an antenna specifically authorized by the manufacturer for use with this radio.

- DO NOT transmit for more than 50% during the time of employment (50% duty cycle or less). Transmitting excessive amount of time can cause RF exposure compliance requirements to be exceeded. Please carefully read this instruction manual to learn how to transmit and stop transmitting before starting to use it.

Electromagnetic Interference/Compatibility

During transmissions, your radio generates RF energy that can possibly cause interference with other devices or systems. To avoid such interference, turn off the radio in areas where signs are posted to do so. DO NOT operate the transmitter in areas that are sensitive to electromagnetic radiation such as hospitals, aircraft, and blasting sites.

Occupational/Controlled Use

This product is used in situations that users are exposed to RF as consequence of their employment provided those users are fully aware of the potential RF hazards and can exercise control over their exposure.

- This transceiver is NOT ATEX approved and NOT intended for the use in hazardous explosive atmospheres.
-