

Life. Camera. Action!

ACTIVEON



CX
GOLD

USER MANUAL

www.activeon.com

Table Of Contents

1. Name of each part	1
2. How to use	2
3. Start the camera	4
4. LCD screen shot	5
5. Graphical icon description	6
6. Mode menu	7
7. Video mode	8
8. Photo mode	10
9. Playback mode	12
10. Setup mode	14
11. Quick menu	17
12. Recharging Battery	17
13. Smart phone control	18
14. Connect ACTIVEON CX GOLD to smartphone(using ACTIVEON App)	18
15. Transferring data to computer	20
16. Firmware update	21
17. Features and specification	22
18. Inside the Package	23
※ CAUTION	78
※ FCC RADIO FREQUENCY INTERFERENCE STATEMENT	78
※ RF Exposure Information (SAR)	79
※ Warranty	81

www.activeon.com

CE2200 FC  RoHS HDMI

ACTIVEON

CX
GOLD

** Please read this manual carefully before the use!*

1. Name of each part

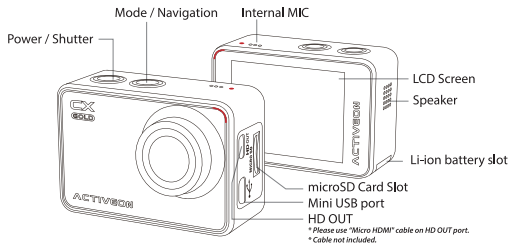



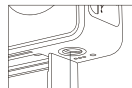

● LED Indicator
(Top, Bottom, Front, Back)















Tripod hole (Bottom)

2. How to use

Button operation

- ACTIVEON CX GOLD IS OPERATED BY TWO BUTTONS. ( button ,  button)
- () BUTTON FEATURES " Power, Shutter and Enter".
- () BUTTON FEATURES "Mode change, Program change and Navigator".
- The feature of buttons are defined as below table.

Function	Button	Description
Power On / Off		Press () button and hold for 2 seconds <i>* If Auto Power off is set, the camera will automatically shut down in 3 minutes when there is no operation.</i>
REC Start / Stop		Press () button to start video recording or photo shoot (Video / Photo / Burst / Timelapse)
Confirm setting menu		Within user setup mode, press () button to enter setting menu in each category
Mode change		Press the () button to switch modes (Video> Photo>Playback>Setup)
Program mode		Press the () button and hold for 2 seconds to enter Program mode
Navigator		Press the () button to move select bar on OSD menu or change setting

Touch operation

- If you want to use the CX Gold display responds to touch-based gestures like tapping and swiping.

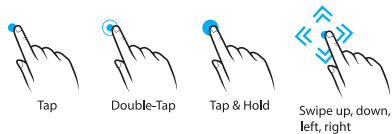

- You can easily access the menu

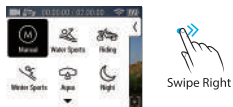

<Program menu>

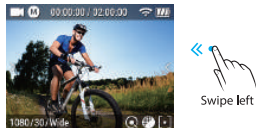

<Mode menu>

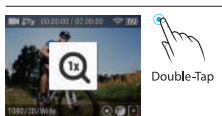

<Zoom>



<Quick menu>

3. Start the camera

1. Open the battery cover and insert ACTIVEON CX GOLD Li-ion battery.
2. Insert microSD Card on the microSD Card slot. (The camera will not record when microSD Card is not inserted.)
3. Press the () button and hold for two seconds. (The camera will turn on and LCD screen will display live screen .)

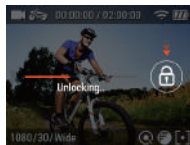
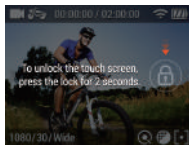

How to unlock the Touch operation

- If you want to use touch operation, tap the screen first. And then it will show " Lock image". Tap and hold the "Lock image" until the live screen is ready.

Power saving features

- CX Gold includes special power saving features.
 1. Auto Backlight Dimming : When you set [Auto LCD Off] , auto backlight dimming will start at mid-point of your setting time.
 2. Quick LCD OFF : [During video recording] Tap and hold the screen for 2-3 seconds. LCD will go off automatically.
 - * For turning on the LCD again, please press the () button once.
 - * If lock image appears, please refer to How-to-Unlock-the-Touch-Operation guide.

4. LCD screen shot

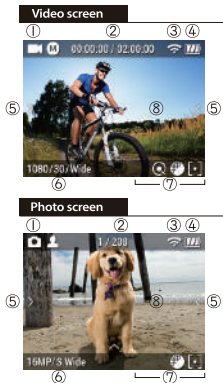

No.	Function	Description
①	Recording mode	Recording mode/Program status
②	Recording time	Recording time information
③	WiFi	WiFi status
④	Battery	Battery status
⑤	Swipe icon	Program/Mode/Quick Mode
⑥	Recording Info	Resolution/FPS/FOV/Interval info
⑦	Function Zone	Quick REC/Effect Setup/AE/Zoom
⑧	Zoom	Double-tap the screen to activate zoom function

5. Graphical icon description

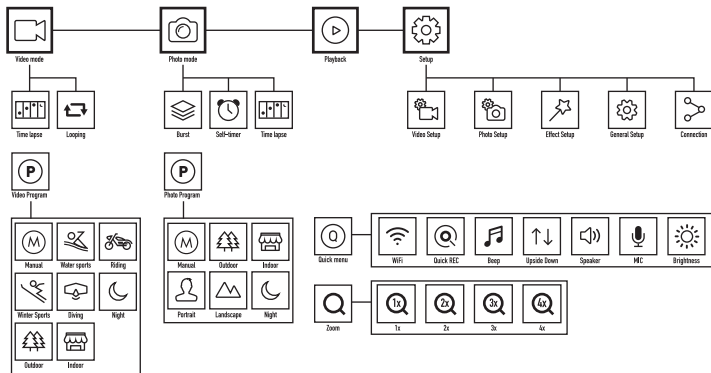



6. Mode menu

Mode menu is available with both button and touch screen.



For Button : There are 4 modes in "Mode menu" - Video, Photo, Playback and Setup.

1. Press () button once. Then Video mode icon will appear
2. Press () button once again to shift mode you want among Video, Photo, Playback and Setup.
3. Wait for a one second, the selected menu will show up automatically.
4. For Playback and Setup mode, Press () button to see more options.



For Touch screen

1. Swipe left. Then Mode menu screen will appear.
2. Tap the mode which you wish to enter among Video, Photo, Playback or Setup.

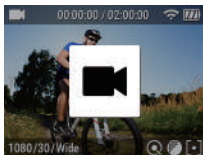

7. Video mode

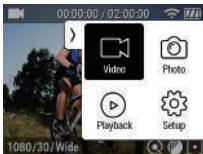

Screen shot of using button



Screen shot of using touch screen

1. After the camera is turned on, Press() button to start video recording.
2. When the camera starts to record, LED light blinks* and shows recording time on the screen.
3. Press() button to stop recording.
4. You can adjust video settings in "Video Setup".

** If LED OFF option is selected in General setup, LED light will not blink.*



Time Lapse-video

Captures images in set intervals and creates a Time lapse video file.
(0.5 SEC/1 SEC/3 SEC/5 SEC/10 SEC/30 SEC/60 SEC)



Looping

Continuously records a video until you stop.

**** Maximum video file capacity is 4GB. If the file size is over the looping space, the camera will overwrite current recording file.**



Zoom

Double-tap shortly on live screen, zoom function will appear.
After 3sec the zoom menu automatically disappear and save value during recording. (x1/x2/x3/x4)



Double-Tap

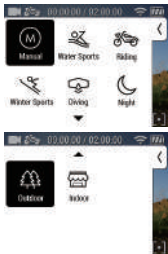

Program menu

Program menu provides fast and simple camera effect settings based on your environment. Program menu is available with both button and touch screen.

For button

1. At the Video mode, press and hold (⊖) button for two seconds. Then Program menu icon will appear.
2. Press (⊖) button once again to shift the mode you want.
3. Press (⊙) button to enter mode in each category.

For touch screen

1. At the Video mode, swipe right. Then Program menu screen will appear.
2. Tap the mode you want.



Manual

Rollback to previous setting before the Program mode



Water sports

For Recording on the water or beach



Diving

For Recording under the Water



Winter sports

For recording on the Snow



Riding

For Recording Speedy Activity



Outdoor

For Recording Outdoor with strong shine



Indoor

For Recording Indoor place



Night

For Recording Night time

8. Photo mode

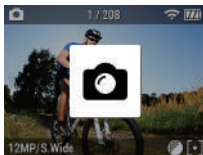

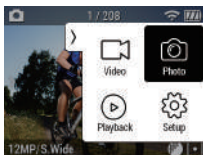

Screen shot of using button



Screen shot of using touch screen

Please change your mode into Photo mode.

1. Press () button. The mode menu will appear on your LCD screen.
2. Press () button once again, the camera will change into Photo mode.
3. After 1 sec, the mode menu will disappear from LCD screen automatically. Then you can start photo shooting.
4. You can adjust detailed photo settings in Setup menu.

You can also change mode by using touch screen more easily.

1. Swipe left to change mode.
2. Tap Photo icon.
3. Press () button to start photo shooting.



Time Lapse-photo

Captures images in set intervals and creates a Time lapse photo file.
(0.5 SEC/1 SEC/3 SEC/5 SEC/10 SEC/30 SEC/60 SEC)



Burst

Photo burst shooting.
(6/1sec)



Zoom(x1/x2/x3/x4)

Double-tap shortly on live screen, zoom function will appear. After 3sec the zoom menu automatically disappear and save zoom setting during recording.



Self-timer

Captures an image after a set time.
(5 SEC/10 SEC/15 SEC)



Program menu

Program menu provides fast and simple camera effect settings based on your environment. Program menu is available with both button and touch screen.

For button

1. At the Video mode, press and hold (ⓘ) button for two seconds.
Then Program menu will appear.
2. Press (ⓘ) button once again to shift the mode you want.
3. Press (ⓘ) button to enter mode in each category.

For touch screen

1. At the Photo mode, swipe right. Then Program menu screen will appear.
2. Tap the mode you want.



Manual

Rollback to previous setting before the Program mode



Portrait

For Shooting Portrait



Indoor

For Shooting Indoor place



Outdoor

For Shooting Outdoor with strong shine



Landscape

For Shooting Outdoor with strong shine



Night

For Recording Night time

9. Playback mode











Please change the mode into Playback mode.

User can view recorded video or photo on the screen.

Press () button to select control panel on top menu.

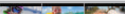
While the file is playing, you can call the play control panel by pressing () button.

Icon	Description
  	Sorting function provides 3 options : All (both video & photo), Video and Photo
 	Select to delete a file. Multiple files can be deleted at once.
1/34	File IDX number or Selected file quantity / Total file quantity
	Back button
	Thumbnail image
 	File type
00:00:16 / 1	Recording Time(For video file) / Picture quantity(For photo file)

**Swipe left or right to go into next page.*

PLAYBACK (Video)

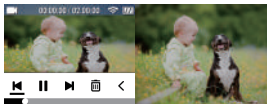

With one tap, you can hide the control bar. When you tap the screen once again, the control bar will appear.

No.	Icon	Description
①		File type
		Playback Time / Total time
②		Battery remaining
		Prev. file / Pause / Next file
③		Delete / Back
		Scroll bar

PLAYBACK (Photo)

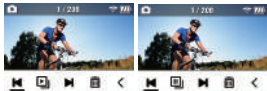

You can see all photo files with slide show function.
*Time lapse & burst photo will only show the first picture.

No.	Icon	Description
①		File type
		Playback Time / Total time
②		Battery remaining
		Prev. file / Pause / Next file
③		Delete / Back

10. Setup mode

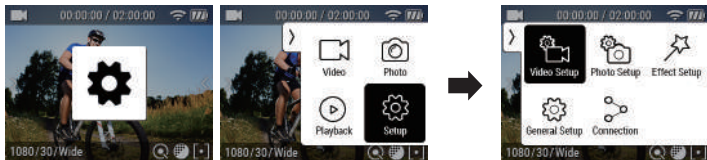

Screen shots of using button & Touch screen

Please change the mode into Setup mode.

- Able to choose more options with Setup mode.
- Video Setup : Provides detailed video recording options.
- Photo Setup : Provides photo shooting options.
- Effect Setup : Provides effect setup options for shooting.
- General Setup : Provides general camera setup options.
- Connection : Provides WiFi function.

Setup	Option
Video Setup	Mode/Resolution/FPS/FOV/Video Quality /Interval/WDR/DIS
Photo Setup	Mode/Mega Pixel/FOV/Picture Quality/Interval/DIS
Effect Setup	Filter/AE Meter/Zoom/EV/White Balance /ISO/Upside Down/ Time Stamp
General Setup	Control/Beep/LED indicator/Quick REC /Auto LCD OFF/Auto Power OFF /Screen Lock/ TV Out/Time Setup /Memory Format/Default/Software Info
Connection	WiFi/WiFi Info

10-1. Setup options

VIDEO SETUP <	
MODE	Manual
RESOLUTION	1080P
FPS	30

PHOTO SETUP <	
MODE	Manual
MEGA PIXEL	16MP
FOV	Super Wide

Function	Description
MODE	Manual/ Looping/ Time Lapse
RESOLUTION	1080P/ 720P/ 480P
FPS	240/120/60/30
FOV	Super wide/ Wide/ Medium/ Narrow
VIDEO QUALITY	S-Fine/ Fine/ Normal
T/LAPSE INTERVAL	0.5/ 1 / 3 / 5 / 10 /30 / 60 (sec)
WDR	ON/OFF
DIS	ON/OFF

Function	Description
MODE	Manual/Time Lapse/Burst/Self Timer
MEGA PIXEL	16MP / 12MP / 8.5MP/ 7MP
FOV	Super wide/ Wide/ Medium/ Narrow
Picture Quality	S-Fine/Fine/Normal
T/LAPSE INTERVAL	0.5/ 1 / 3 / 5 / 10 /30 / 60 (sec)
Self Timer INTERVAL	5/ 10 / 15 (sec)
DIS	ON/OFF

EFFECT SETUP <	
ZOOM	x1
FILTER	Off
AE METER	Average

GENERAL SETUP <	
CONTROL	Mic
BEEP	On
LED INDICATOR	Four

Function	Description
Zoom	x1/ x2/x3/x4
Filter	Off/Black&White/Sepia/Vivid/Natural/Negative/Warm /Cool/Red/Green/Blue
AE Meter	CENTER/AVERAGE/SPOT
EV	-2.0/-1.0/0/+1.0/+2.0
White Balance	AUTO/3000K/5500K/6500K
ISO	AUTO/100/200/400/800/1600/3200
Upside Down	ON/OFF
Time Stamp	ON/OFF

Function	Description
CONTROL	Mic/Speaker/ LCD Brightness
BEEP	ON/OFF
LED INDICATOR	OFF/TWO/FOUR
QUICK REC	OFF/0SEC/3SEC/5SEC
AUTO LCD OFF	OFF/ 30sec/ 1min/ 5min
AUTO POWER OFF	OFF/ 5min/ 10min/ 30min
Screen lock	OFF/ 5sec/ 10sec/ 30sec
TV OUT	NTSC/PAL
TIME SETUP	DATE - TIME
MEMORY FORMAT	YES/NO
DEFAULT	YES/NO
SOFTWARE INFO	



WIFI INFO

SSID-PW

Function	Description
WiFi	ON/OFF
WiFi INFO	SSID-PW

11. Quick Menu

Quick menu provides easy access to your most often used menu.

Quick menu is only available with touch screen.

1. Swipe up. Then Quick menu screen will appear.
2. Tap the menu you wish to enter.



Function	Description
WiFi	ON/OFF
UPSIDE DOWN	ON/OFF
QUICK REC	ON/OFF(last setting value)
BEEP	ON/OFF
SPEAKER	ON/OFF(last setting value)
MIC	ON/OFF(last setting value)
Brightness	CONTROL BAR

12. Recharging battery

LCD will show the low battery icon() when the battery is too low and close to the cut off level.

The camera will save the file automatically until it is turned off. You must recharge your battery to restart.

It will take about 3.5 hours for a full charge by USB port.

You can use a Battery Charger (optional accessory) for fast charging.

1. Turn off the camera.
2. Connect the camera to your computer via USB cable.
3. LED will turn on indicating battery is being charged.
4. LED will be turned off when it is fully charged.

13. Smartphone control

- Utilizing WiFi APP function of ACTIVEON, user can control the camera through smartphone.
- Compatible with iOS and Android OS.
- Before connecting the camera, download 'ACTIVEON' application from smartphone app store.
- Search for 'ACTIVEON' in Apple App Store or Google Play Store.

** While smartphone is connected to the camera, camera button operation will be disabled.*

** You can take a video and photo, and adjust camera setting on 'ACTIVEON'.*

** 'ACTIVEON' features will be upgraded through application updates on your smartphone.*

14. Connect ACTIVEON CX GOLD to smartphone(using ACTIVEON App)

On your camera

- Turn on 'WiFi APP' function in ACTIVEON CX Gold.
- The camera screen will display "Waiting for connection"

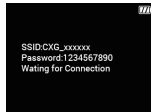

14. Connect ACTIVEON CX GOLD to smartphone(using ACTIVEON App)

On your Smartphone

- On your smartphone or tablet, turn the WiFi on and select the network CXG-xxxxxx under WiFi setting.
- Default password is '1234567890'.
- Run '**ACTIVEON**' app on your smartphone or tablet.
- Press 'Connect ACTIVEON' on the app. You can now control your ACTIVEON camera.

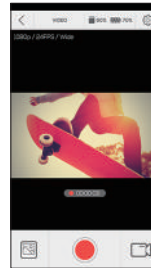
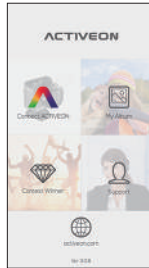

15. Transferring data to computer (compatible with both Windows OS and Mac OS)

- If the camera is connected to a computer or battery charger while it is powered off, the camera starts to recharge the battery.
- If the camera is connected to a computer while it is powered on, the camera changes to file-transfer mode.
- While the camera is connected to a battery charger or car charger for recharge, the camera can record while it is recharging.
 1. Power on ACTIVEON CX GOLD.
 2. Connect the camera to a computer via USB cable.
 3. The camera LCD will display as 'USB Ready'.
 4. Go to 'My Computer' in PC.
 5. Search 'Removable Disk'.
 6. Double click 'Removable Disk'.
 7. Double click 'DCIM' folder.
 8. Open the folders to find video or photo file.
 9. Copy and paste files to the computer.

16. Firmware update (Find the latest firmware at www.activeon.com)

- You can always find the latest firmware updates of ACTIVEON products on the website. (www.activeon.com)
- Firmware upgrade may fail if battery is too low.
- Recharge up to two cells of battery gauge for proper upgrade.
 1. Format the memory card, and copy firmware file to the root directory of microSD Card.
 2. Insert the microSD to ACTIVEON CX GOLD and turn on the power.
 3. Firmware upgrade will automatically start as showing the updating status on the screen.
 4. When upgrade is completed, the camera will show 'F/W Updating' and will automatically turn off.
** Do Not turn off the camera or take out the battery during firmware upgrade.*

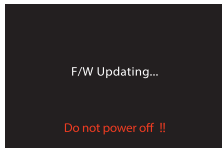

17. Features and specifications

- "ACTIVEON CX GOLD" 1080p 60fps Action Camera.
- FULL HD(1920 x 1080) resolution, 60fps recording.
- 196ft(60m) waterproof housing.
- 16M SONY IMX CMOS sensor.
- Easily control camera Effect setting by Program mode.
- Super wide angle field of view(FOV).
- Built in 2.0" LCD(320x240) with touch panel.
- Built in WiFi.
- Versatile recording resolution(1080p/720p/480p).
- Burst photo-shooting(*6 shots in 1 second).
- H.264 codec, saved as MP4 format.
- Rechargeable Li-ion Battery.
- Battery running time : Approximately 120minutes of continuous recording(1080p 30 fps)
** recording time may vary depending on the condition*
- Recharging time : 3.5 hours by USB port/ 2.5 hours by AC adapter(Optional Accessory)
- Easy graphical user interface
- Full line of accessories

18. Inside the Package



ACTIVEON CX GOLD
Action camera



Waterproof
Housing



Opened Backdoor



Curved Adhesive
Mount



Connecting Screw



Short Connector



Rechargeable Li-ion Battery

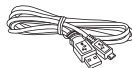

USB Cable



microSD Card



Life. Camera. Action!

ACTIVEON



CX
GOLD

MODE D'EMPLOI

www.activeon.com

Table des matières

1. Nom de chaque pièce	27
2. Mode d'emploi	28
3. Allumez la caméra	30
4. Capture d'écran LCD	31
5. Description des icônes graphiques	32
6. Mode menu	33
7. Mode vidéo	34
8. Mode photo	36
9. Mode playback	38
10. Mode paramètres	40
11. Menu rapide	43
12. Recharge de la batterie	43
13. Contrôle par Smartphone	44
14. Connexion de l'ACTIVEON CX GOLD à un Smartphone (à l'aide de l'app ACTIVEON)	44
15. Transférer les données vers un ordinateur	46
16. Mise à jour du firmware	47
17. Fonctionnalités et spécifications	48
18. Dans l'emballage	49
※ ATTENTION	78
※ DÉCLARATION SUR LES INTERFÉRENCES DE FRÉQUENCE RADIO FCC	78
※ Informations sur l'exposition aux RF (SAR)	79
※ GARANTIE	81

www.activeon.com

CE2200 FC  RoHS **ACTIVEON****CX
GOLD**** Veuillez lire attentivement ce mode d'emploi avant toute utilisation !*

1. Nom de chaque pièce

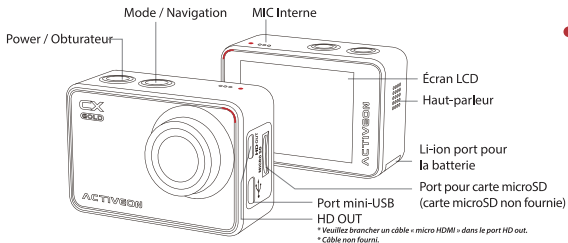



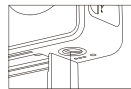

 Diode d'indication
(Haut, Base, Avant, Arrière)















Trou de vis pour le pied
(Base)

2. Mode d'emploi

Utilisation des boutons

- L'ACTIVEON CX GOLD est utilisée à l'aide de deux boutons ( bouton ,  bouton).
- Le bouton () pilote la mise en marche, l'obturateur et la saisie.
- Le bouton () permet le changement de mode, de programme et l'accès au navigateur.
- Les fonctionnalités des boutons sont décrites dans le tableau ci-dessous.

Fonction	Bouton	Description
Alimentation On / Off		Appuyez sur le bouton () et maintenez-le enfoncé pendant 2 secondes. <i>* Si l'extinction automatique est activée, la caméra s'éteindra automatiquement après 3 minutes sans opération.</i>
Start / Stop enregistrement		Appuyez sur le bouton () pour lancer l'enregistrement vidéo ou prendre une photo. (Vidéo/ Photo / Rafale / Timelapse)
Confirmer le paramètre du menu		Dans le mode paramètre utilisateur, appuyez sur le bouton () pour saisir un paramètre menu dans chaque catégorie
Changement du mode		Appuyez sur le bouton () pour alterner entre les modes (Vidéo > Photo > Rafale > Timelapse)
Mode programme		Appuyez sur le bouton () et maintenez-le enfoncé pendant 2 secondes pour accéder au mode programme.
Navigateur		Appuyez sur le bouton () pour déplacer la barre de sélection dans le menu OSD ou modifier un paramètre.

Utilisation tactile

- L'écran du CX Gold est tactile, et répond aux gestes tels que tapotements et glissements.
- Vous pouvez aisément accéder au menu.

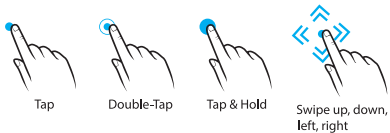

<Menu programme >



Swipe right



Swipe left



<Mode menu>

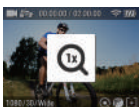

<Zoom>



Double-Tap



Swipe up



<Menu rapide>

3. Allumez la caméra

1. Ouvrez le compartiment de la batterie et insérez-y la batterie Li-ion ACTIVEON CX GOLD.
2. Insérez la carte microSD dans le compartiment prévu à cet effet. (La caméra n'enregistre pas si la carte microSD n'est pas insérée.)
3. Appuyez sur le bouton (🔴) et maintenez-le enfoncé pendant 2 secondes (la caméra s'allume et l'écran LCD affiche l'image visualisée)

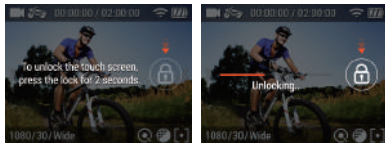

Comment débloquer le fonctionnement tactile

- Pour une utilisation tactile, tapotez l'écran. L'écran affichera ensuite "Lock image". Tapotez et maintenez "Lock image" jusqu'à ce que l'écran soit prêt.

Fonction d'économie d'énergie

- CX Gold comprend des caractéristiques spéciales d'économie d'énergie.
 1. Auto rétro éclairage par palier : Lorsque vous réglez sur [Arrêt auto LCD], l'auto rétro éclairage par palier débutera au mileu de votre temps de réglage.
 2. Pour éteindre l'écran LCD : [Pendant l'enregistrement vidéo] Appuyez et maintenez l'écran pendant 2-3 secondes. L'écran LCD s'éteindra automatiquement.
 - * Pour ré allumer l'écran LCD à nouveau, s'il vous plaît appuyez sur le bouton (🔴) une fois.
 - * Si l'image de cadenas apparaît, s'il vous plaît consulter le guide-du-Touch-Opération How-to-Unlock. (comment débloquer)

4. Capture d'écran LCD

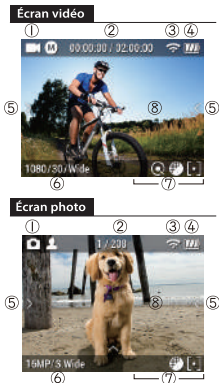

No.	Fonction	Description
①	Mode d'enregistrement	Mode d'enregistrement / Statut du programme
②	Temps d'enregistrement	Informations du temps d'enregistrement
③	WiFi	Statut du WiFi
④	Batterie	État de la batterie
⑤	Icône de balayage	Programme / Mode / Mode rapide
⑥	Infos d'enregistrement	Résolution/FPS/FOV/Infos d'intervalle
⑦	Zone de Fonction	Enregistrement rapide / Paramètres des effets / AE / Zoom
⑧	Zoom	Tapotez deux fois sur l'écran pour activer la fonction zoom.

5. Description des icônes graphiques

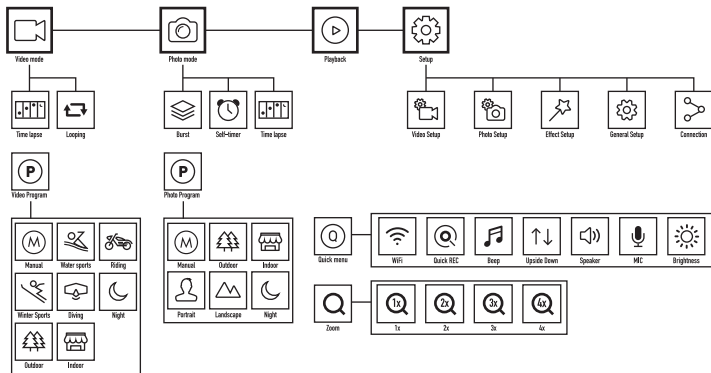

6. Mode menu

Le mode menu est disponible avec le bouton et l'écran tactile.



Avec le bouton : Il y a 4 modes en "mode menu": Vidéo, Photo, Playback et Paramètres.

1. Appuyez une fois sur le bouton (⊙). L'icône du mode vidéo s'affiche.
2. Appuyez encore une fois sur le bouton (⊙) pour passer d'un mode à l'autre (Vidéo, Photo, Playback et Paramètres).
3. Attendez une seconde, et le menu sélectionné s'affiche automatiquement.
4. Pour le mode playback et paramètres, appuyez sur le bouton (⊙) pour afficher davantage d'options.

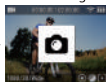

Avec l'écran tactile

1. Balayez vers la gauche. L'écran du mode menu s'affiche.
2. Tapotez sur le mode auquel vous souhaitez accéder. (Vidéo, Photo, Playback, Paramètres).



7. Mode vidéo

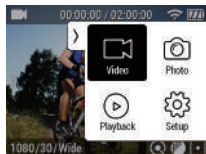

Capture d'écran de l'utilisation du bouton



Capture d'écran de l'utilisation de l'écran tactile

1. Une fois la caméra allumée, Appuyez sur le bouton () pour lancer l'enregistrement vidéo.
2. Lorsque la caméra commence à enregistrer, la diode clignote* et la durée de l'enregistrement s'affiche à l'écran.
3. Appuyez sur le bouton () pour arrêter l'enregistrement.
4. Vous pouvez modifier les paramètres vidéo dans "Paramètres vidéo".

** Si l'option LED OFF est sélectionnée dans les paramètres généraux, la diode ne clignotera pas.*



Vidéo timelapse

Prise d'images à intervalles définis et création d'un fichier vidéo timelapse.
(0,5 SEC/1 SEC/3 SEC/5 SEC/10 SEC/30 SEC/60 SEC)



Looping

Enregistrement en continu jusqu'à ce que vous arrêtez.

**** La capacité maximale du fichier vidéo est de 4 Gb. Si la taille du fichier excède celle de l'espace looping, la caméra écrasera le fichier d'enregistrement en cours.**



Zoom

Tapotez brièvement deux fois sur l'écran, la fonction zoom s'affiche. Après 3 secondes, le zoom disparaît automatiquement et enregistre la valeur pendant l'enregistrement (x1/x2/x3/x4).



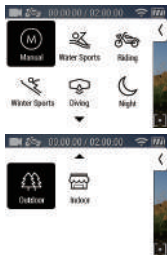

Menu programme (vidéo)

Le menu programme fournit les paramètres d'effet simples et rapides pour la caméra, en fonction de votre environnement. Le menu programme est disponible avec le bouton et l'écran tactile.

Avec le bouton

1. En mode vidéo, appuyez sur le bouton (⊙) et maintenez-le enfoncé pendant 2 secondes. L'icône du menu programme s'affiche.
2. Appuyez encore une fois sur le bouton (⊙) pour passer d'un mode à l'autre.
3. Appuyez sur le bouton (⊙) pour saisir un paramètre menu dans chaque catégorie.

Avec l'écran tactile

1. En mode vidéo, balayez vers la droite. L'écran du menu programme s'affiche.
2. Tapotez sur le mode souhaité.



Manuel

Retour au paramètre précédent avant le mode programme



Sports aquatiques

Pour enregistrer sur la plage ou dans l'eau



Plongée

Pour enregistrer sous l'eau



Sports d'hiver

Pour enregistrer dans la neige



Équitation

Pour enregistrer une activité rapide



Extérieur

Pour enregistrer à l'extérieur avec une forte lumière



Intérieur

Pour enregistrer à l'intérieur



Nuit

Pour enregistrer la nuit

8. Mode photo

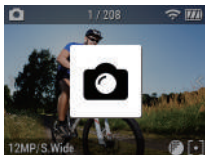

Capture d'écran de l'utilisation du bouton

Veillez changer le mode en mode photo.

1. Appuyez sur le bouton (ⓘ). Le mode menu s'affichera sur votre écran LCD.
2. Appuyez une fois encore sur le bouton (ⓘ), la caméra passera en Mode photo.
3. Après une seconde, le mode menu disparaît automatiquement de votre écran LCD.
Vous pouvez prendre des photos.
4. Vous pouvez modifier les paramètres photo dans le Menu paramètres.

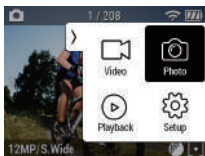

Capture d'écran de l'utilisation de l'écran tactile

Vous pouvez également changer de mode en touchant simplement l'écran.

1. Balayez à gauche pour changer de mode.
2. Tapotez l'icône de la photo.
3. Appuyez sur le bouton (ⓘ) pour commencer à prendre des photos.



Photo timelapse

Prise d'images à intervalles définis et création d'un fichier photo timelapse.
(0.5 SEC/1 SEC/3 SEC/5 SEC/10 SEC/30 SEC/60 SEC)



Rafale

Photos en rafale
(6/1 sec)



Zoom(x1/x2/x3/x4)

Tapotez brièvement deux fois sur l'écran, la fonction zoom s'affiche.
Après 3 secondes, le zoom disparaît automatiquement et enregistre la valeur pendant l'enregistrement



Auto-Timer

Prise d'une image après un temps défini.
(5 sec/10 sec/15 sec)



Menu programme (Photo)

Le menu programme fournit les paramètres d'effet simples et rapides pour la caméra, en fonction de votre environnement. Le menu programme est disponible avec le bouton et l'écran tactile.

Avec le bouton

1. En mode vidéo, appuyez sur le bouton (⊙) et maintenez-le enfoncé pendant 2 secondes. L'icône du menu programme s'affiche.
2. Appuyez encore une fois sur le bouton (⊙) pour passer d'un mode à l'autre.
3. Appuyez sur le bouton (⊙) pour saisir un paramètre menu dans chaque catégorie.

Avec l'écran tactile

1. En mode photo, balayez vers la droite. L'écran du menu programme s'affiche.
2. Tapotez sur le mode souhaité.



Manuel

Retour au paramètre précédent avant le mode programme



Portrait

Pour prendre un portrait



Intérieur

Pour une prise de vue à l'intérieur



Extérieur

Pour une prise de vue à l'extérieur avec une forte lumière



Paysage

Pour une prise de vue à l'extérieur avec une forte lumière



Nuit

Pour enregistrer la nuit

9. Mode playback

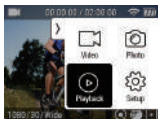









Veillez modifier le mode en mode playback.

L'utilisateur peut voir les photos ou les vidéos enregistrées à l'écran.

Appuyez sur le bouton (○) pour sélectionner le panneau de contrôle dans le haut du menu.

Pendant la lecture, vous pouvez appeler le panneau de contrôle de lecture en appuyant sur le bouton (○).

Icon	Description
ALL  	La fonction de tri propose 3 options : Tout (vidéo & photo), vidéo et photo
 	Sélection pour supprimer un fichier. Plusieurs fichiers peuvent être supprimés en une fois.
1/34	Numéro IDX du fichier ou quantité de fichiers sélectionnée / Nombre total de fichiers
	Bouton retour
	Image en onglet
 	Type de fichier
00:00:16 / 1	Temps d'enregistrement (pour fichier vidéo) / Quantité de photos (pour fichier photo)

**Balayez à gauche ou à droite pour passer à la page suivante.*

Playback (vidéo)

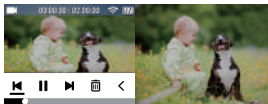

D'un tapotement, vous pouvez masquer la barre de contrôle. Tapotez à nouveau l'écran, et la barre de contrôle réapparaît.

No.	Icon	Description
①		Type de fichier
		Durée du playback / Temps total
		Batterie restante
②		Fichier précédent/Pause/Fichier suivant
		Supprimer / Retour
③		Barre de navigation

Playback (photo)

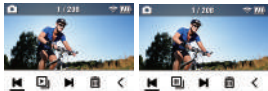

Vous pouvez voir tous les fichiers photo avec la fonction diaporama.

* En timelapse et en rafale, seule la première photo s'affiche

No.	Icon	Description
①		Type de fichier
		Durée du playback / Temps total
		Batterie restante
②		Fichier précédent / Pause / Fichier suivant
		Supprimer / Retour

10. Mode paramètres

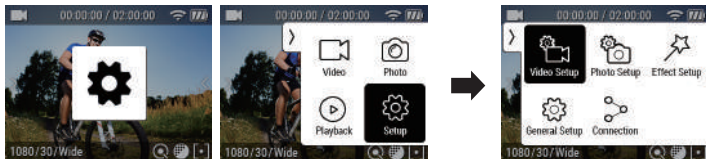

Capture d'écran de l'utilisation du bouton et de l'écran tactile

Veillez modifier le mode en mode paramètres.

- permet de choisir plus d'options dans le mode paramètres.
- Paramètres vidéo : Fournit des options d'enregistrement détaillées.
- Paramètres photo : Fournit les options pour la prise de photos.
- Paramètres effets : Fournit les options pour les effets pour les prises.
- Paramètres généraux : Fournit les paramètres généraux de la caméra.
- Connexion : Fournit la fonction WiFi.

Setup	Option
Paramètres vidéo	Mode/Résolution/FPS/FOV/Video Qualité /Intervalle/WDR/DIS
Paramètres photo	Mode/Pixel/FOV/Photo Qualité/Intervalle/DIS
Paramètres effets	Filtre/Compteur AE/Zoom/EV/Balance des blancs /ISO/Inversé/Estampille temporelle
Paramètres généraux	Contrôle/Bip/Indicateur LED/Quick REC /Auto LCD OFF/Auto Power OFF/TV Out /Verrouillage de l'écran/Réglage de l'heure /Formater la mémoire/Défaut/Infos Logicielles
Connexion	WiFi/WiFi Info

10-1. Options de réglage

VIDEO SETUP	
MODE	Manual
RESOLUTION	1080P
FPS	30

PHOTO SETUP	
MODE	Manual
MEGA PIXEL	16MP
FOV	Super Wide

Fonction	Description
Mode	Manuel/Looping/Time Lapse
Résolution	1080P/ 720P/ 480P
FPS	240/120/60/30
FOV	Super wide/ Wide/ Medium/ Narrow
VIDÉO Qualité	Super Fin / Fin / Normal
INTERVALLE T/LAPSE	0.5/ 1 / 3 / 5 / 10 /30 / 60 (sec)
WDR	ON/OFF
DIS	ON/OFF

Fonction	Description
Mode	Manuel/Time Lapse/Rafale/Self Timer
MEGA PIXEL	16MP / 12MP / 8.5MP/ 7MP
FOV	Super Large / Large / Medium / Étroit
Photo Qualité	Super Fin / Fin / Normal
INTERVALLE T/LAPSE	0.5/ 1 / 3 / 5 / 10 /30 / 60 (sec)
INTERVALLE Self Timer	5/ 10 / 15 (sec)
DIS	ON/OFF

★ EFFECT SETUP <	
ZOOM	x1
FILTER	Off
AE METER	Average

⚙️ GENERAL SETUP <	
CONTROL	Mic
BEEP	On
LED INDICATOR	Four

Fonction	Description
Zoom	x1/ x2/x3/x4
Filter	OFF/Noir&Blanc/Sépia/vif/Naturel/Natif/Chaud/Frais/Rouge/Vert/Bleu
Compteur AE	CENTRE/MOYEN/SPOT
EV	-2.0/-1.0/0/+1.0/+2.0
Balance des blancs	AUTO/3000K/5500K/6500K
ISO	AUTO/100/200/400/800/1600/3200
Inversé	ON/OFF
Estampille temporelle	ON/OFF

Fonction	Description
CONTRÔLE	Mic/Haut-parleur/Luminosité LCD
BIP	ON/OFF
DIODE D'INDICATION	OFF/DEUX/QUATRE
QUICK REC	OFF/ 0sec/ 3sec/ 5sec
AUTO LCD OFF	OFF/30sec/ 1min/ 5min
AUTO POWER OFF	OFF/ 5min/ 10min/ 30min
VERROUILLAGE DE L'ÉCRAN	OFF/ 5sec/ 10sec/ 30sec
TV OUT	NTSC/PAL
REGLAGE DE L'HEURE	DATE - HEURE
FORMATER LA MÉMOIRE	OUI/NON
DÉFAUT	OUI/NON
INFOS LOGICIELLES	



WIFI INFO

SSID-PW

Fonction	Description
WiFi	ON/OFF
WiFi INFO	SSID / Mot de passe

11. Menu rapide

Le menu rapide fournit un accès aisé au menu le plus utilisé.

Le menu rapide n'est accessible qu'avec l'écran tactile.

- Balayez vers le haut. L'écran du menu rapide s'affiche
- Tapotez le menu auquel vous souhaitez accéder.



Fonction	Description
WiFi	ON/OFF
Inversé	ON/OFF
QUICK REC	ON/OFF (last setting value)
BIP	ON/OFF
Haut-parleur	ON/OFF (last setting value)
MIC	ON/OFF (last setting value)
Luminosité	Barre de navigation

12. Recharge de la batterie

L'écran affichera l'icône d'une batterie plate () lorsque la batterie est trop faible et proche du niveau d'extinction de l'appareil.

La caméra enregistrera automatiquement jusqu'à ce qu'elle soit éteinte. Vous devez recharger la batterie pour redémarrer.

Il faut environ 3,5 heures pour une recharge complète via un port USB.

Pour une recharge plus rapide, vous pouvez utiliser un chargeur (accessoire en option).

- Éteignez la caméra.
- Connectez le port USB de la caméra à votre ordinateur à l'aide du câble.
- La diode s'allume lorsque la batterie est en charge.
- La diode s'éteint lorsque la batterie est chargée.

13. Contrôle par smartphone

- À l'aide de la fonction de l'app WiFi de l'ACTIVEON, l'utilisateur peut contrôler sa caméra avec un Smartphone.
- Compatible avec iOS et Android.
- Avant de connecter la caméra, téléchargez l'app 'ACTIVEON' dans l'app store de votre smartphone.
- Dans l'Apple App Store ou dans le Google Play Store, faites une recherche sur 'ACTIVEON'.

** Une fois le smartphone connecté à la caméra, les boutons de la caméra sont désactivés.*

** Vous pouvez prendre une photo ou une vidéo et régler les paramètres sur 'ACTIVEON'.*

** Les fonctionnalités 'ACTIVEON' seront actualisées grâce aux mises à jour de l'application via votre Smartphone.*

14. Connexion de l'ACTIVEON CX GOLD à un Smartphone (à l'aide de l'app ACTIVEON)

Sur votre caméra

- Activez la fonction « WiFi App » dans ACTIVEON CX GOLD.
- L'écran de la caméra affichera « Waiting for connection ».

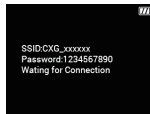

14. Connexion de l'ACTIVEON CX GOLD à un Smartphone (à l'aide de l'app ACTIVEON)

Sur votre Smartphone

- Sur votre smartphone / tablette, activez le WiFi et sélectionnez le réseau CXG-xxxxxx dans les paramètres WiFi.
- Le mot de passe par défaut est '1234567890'.
- Lancez l'app 'ACTIVEON' sur votre Smartphone / tablette.
- Appuyez sur « Connect ACTIVEON » dans l'app. Vous pouvez maintenant contrôler votre caméra ACTIVEON.

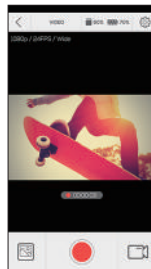
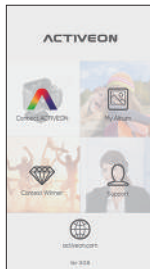

15. Transférer les données vers un ordinateur (compatible avec Windows et Mac OS)

- Si la caméra est connectée à un ordinateur ou à un chargeur alors qu'elle est sur off, la caméra commence à recharger sa batterie.
 - Si la caméra est connectée à un ordinateur alors qu'elle est sur o, la caméra passe en mode transfert.
 - Lorsque la caméra est connectée à un chargeur de batterie ou de voiture, elle peut enregistrer tout en étant en charge.
1. Allumez l'ACTIVEON CX GOLD.
 2. Connectez le port USB de la caméra à votre ordinateur à l'aide du câble.
 3. L'écran de la caméra affiche « USB Ready ».
 4. Allez dans « My computer » sur votre ordinateur.
 5. Recherchez « removable disk ».
 6. Double-cliquez sur « removable disk ».
 7. Double-cliquez sur le dossier « DCIM ».
 8. Ouvrez les dossiers pour trouver les fichiers photo ou vidéo.
 9. Copiez et collez les fichiers sur votre ordinateur.

16. Actualisation du firmware (vous trouverez la dernière mise à jour du firmware sur www.activeon.com)

- Vous trouverez toujours la dernière mise à jour du firmware des produits ACTIVEON sur le site. (www.activeon.com)
- La mise à jour du firmware peut ne pas être possible si la batterie est trop déchargée.
- Il faut deux barres de batterie pour pouvoir faire une mise à jour.
 1. Formatez la carte-mémoire, et copiez le fichier du firmware dans le répertoire racine de la carte microSD.
 2. Insérez la carte microSD dans l'ACTIVEON CX GOLD et allumez-la.
 3. La mise à jour du firmware se fera automatiquement, avec un affichage de la progression à l'écran.
 4. Une fois la mise à jour terminée, la caméra affiche « F/W Updating » et s'éteint.
** N'éteignez pas votre appareil ou n'enlevez pas la batterie pendant la mise à jour.*

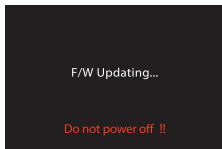

17. Fonctionnalités et spécifications

- Caméra d'action « ACTIVEON CX GOLD » 1080p 60fps
- Résolution FULL HD (1920 x 1080), enregistrement en 60fps.
- Boîtier étanche 196ft (60m)
- Capteur CMOS 16M SONY IMX
- Contrôle aisé des effets de la caméra avec le mode programme.
- Champs de vue plus larges (FOV).
- Écran LCD 2.0" (320x240) intégré.
- Wi-Fi intégré.
- Résolution d'enregistrement variable (1080p/720p/480p)
- Photos en rafale (* 6 photos par seconde)
- Codec H.264, enregistrement au format MP4.
- Batterie Li-ion rechargeable.
- Autonomie de la batterie : Environ 120 minutes en enregistrement continu (1080 30 fps)
** Le temps d'enregistrement peut varier en fonction des conditions*
- Temps de charge : 3,5 heures par USB / 2,5 heures avec un adaptateur AC (accessoire en option)
- Interface graphique utilisateur conviviale
- Gamme complète d'accessoires

18. Dans l'emballage



CAMÉRA D'ACTION
ACTIVEON CX GOLD



Boitier étanche



Clapet arrière ouvert



Support de montage
adhésif courbe



Vis de connexion



Connecteur court



Batterie Li-ion rechargeable

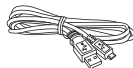

Câble USB



carte microSD

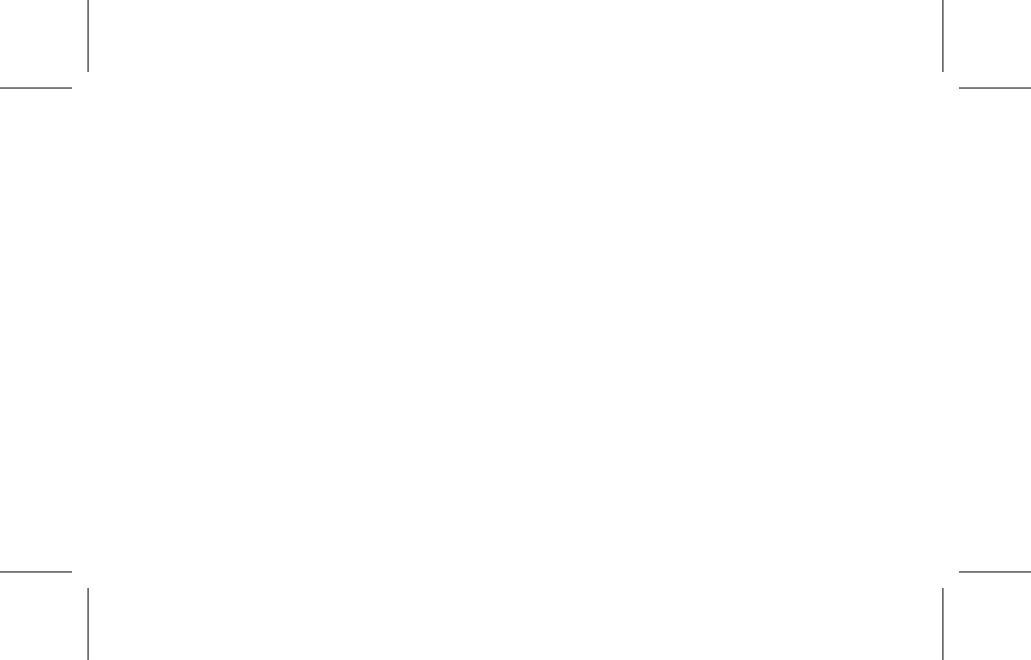

Life. Camera. Action!

ACTIVEON



CX
GOLD

MANUAL DE USUARIO

www.activeon.com

Índice

1. Nombre de cada pieza	53
2. Modo de empleo	54
3. Encienda la cámara	56
4. Vista de la pantalla LCD	57
5. Descripción de los iconos gráficos	58
6. Menú de modo	59
7. Menú de vídeo	60
8. Modo de foto	62
9. Modo de reproducción	64
10. Modo de configuración	66
11. Menú rápido	69
12. Recargar la batería	69
13. Control desde smartphone	70
14. Conecte ACTIVEON CX Gold a su smartphone (con la app ACTIVEON)	70
15. Transferir los datos al ordenador	72
16. Actualizar el firmware	73
17. Características y especificaciones	74
18. Contenido del paquete	75
※ PRECAUCIÓN	78
※ DECLARACIÓN DE INTERFERENCIAS DE RADIOFRECUENCIA DE FCC	78
※ Información sobre exposición a RF (SAR)	79
※ GARANTÍA	81

www.activeon.com

CE2200 FC  RoHS **HDMI**

ACTIVEON

CX
GOLD

** Lea este manual detenidamente antes de usar el producto.*

1. Nombre de cada pieza

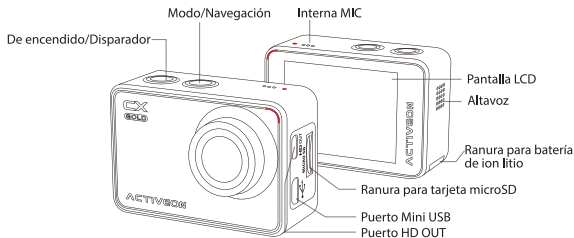

- Indicador LED (Parte superior, inferior, delantera y trasera)

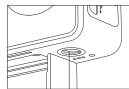

















Orificio para trípode (parte inferior)

* Utilice un cable "Micro HDMI" en el puerto HD OUT.
* Cable no incluido.

2. Modo de empleo

Funcionamiento del botón

- ACTIVEON CX Gold se maneja mediante dos botones. (el botón  , el botón )
- () funciones del botón "encendido, disparador y aceptar".
- () funciones del botón "cambio de modo, navegación y menú de usuario".
- Las funciones de los botones se definen en la tabla siguiente.

Función	Botón	Descripción
Activado / Desactivado		Mantenga pulsado el botón () durante 2 segundos. <i>* Si está activado el apagado automático, la cámara se apagará automáticamente después de 3 minutos sin utilizarla.</i>
Inicio / Fin de la grabación		Mantenga pulsado el botón () para iniciar la grabación de vídeo o captura de fotos. (Vídeo/Foto/Ráfaga/Intervalo)
Confirmar ajustes del menú		En el modo de configuración del usuario, pulse el botón () para acceder al menú de ajustes en cada categoría.
Cambiar de modo		Pulse el botón () para cambiar de modo. (Vídeo > Fotos > Ráfaga de fotos > Intervalo)
Menú de usuario		Mantenga pulsado el botón () durante 2 segundos para acceder al modo de configuración del usuario.
Navigator		Pulse el botón () para mover la barra de selección en el menú OSD o cambiar el ajuste.

Operación táctil

- La pantalla CX Gold responde a los gestos táctiles como dar pequeños golpes o arrastrar.

- Puede acceder fácilmente al menú.



Tap



Double-Tap



Tap & Hold



Swipe up, down,
left, right



<Program menu>



Swipe Right



Swipe left



<Mode menu>

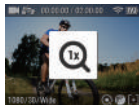

<Zoom>



Double-Tap



Swipe Up



<Quick menu>

3. Encienda la cámara

1. Abra la tapa de la batería e introduzca la batería de ion litio ACTIVEON CX GOLD.
2. Inserte la tarjeta microSD en la ranura para tarjetas microSD. (La cámara no grabará sin una tarjeta microSD insertada).
3. Presione el botón (🔴) y manténgalo durante 2 segundos (La cámara se encenderá y la pantalla LCD mostrará la pantalla en directo).

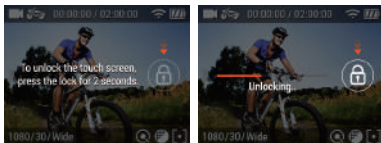

Cómo desbloquear el funcionamiento táctil

Si desea usar el funcionamiento táctil, toque primero la pantalla. A continuación aparecerá "Bloquear imagen". Pulse y mantenga "Bloquear imagen" hasta que esté lista la pantalla en directo.

Función de ahorro de energía

- CX GOLD incluye características especiales de ahorro de energía.
 1. Atenuación de la Auto-retroiluminación : Cuando se ajusta [Auto LCD Off] , El nivel de atenuación de la auto-retroiluminación se iniciará en el punto medio del ajuste de tiempo.
 2. Apagado rápido del LCD : [Durante la grabación de vídeo] Toque y mantenga pulsada la pantalla durante 2-3 segundos. La pantalla LCD se apagará automáticamente.
 - * Para encender la pantalla LCD de nuevo, por favor, pulse el botón (🔴) una vez.
 - * Si la imagen de bloqueo aparece, por favor, consulte la guía "Como desbloquear la función táctil".

4. Vista de la pantalla LCD



N.º	Función	Descripción
①	Modo de grabación	Modo de grabación/Estado del programa
②	Tiempo de grabación	Información sobre el tiempo de grabación
③	WiFi	Estado del WiFi
④	Batería	Estado de la batería
⑤	Icono de arrastre	Programa/Modo/Modo rápido
⑥	Información de grabación	Resolución/FPS/Campo de visión/ Información de intervalo
⑦	Zona de función	Quick REC/Configuración de efectos/EA/Zoom
⑧	Zoom	Toque la pantalla dos veces para activar la función del zoom.

5. Descripción de los iconos gráficos

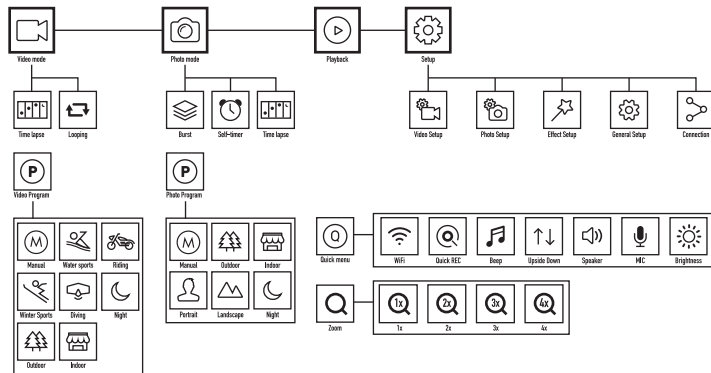

6. Menú de modo

El menú de modo está disponible con botón y con pantalla táctil.



Botón : El menú de modo tiene 4 modos: vídeo, fotografía, reproducción y configuración.

1. Presione una vez el botón (⏏). Aparecerá el icono del modo de vídeo.
2. Presione de nuevo el botón (📷) para cambiar al modo que desea, entre vídeo, fotografía, reproducción y configuración.
3. Espere un segundo; el menú seleccionado aparecerá automáticamente.
4. Para los modos de reproducción y configuración, presione el botón (⚙️) para consultar más opciones.

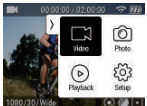
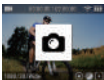

Para la pantalla táctil

1. Arrastre el dedo hacia la izquierda. Aparecerá la pantalla del modo de menú.
2. Toque el modo en el que desea entrar: vídeo, fotografía, reproducción o configuración.



7. Modo de vídeo

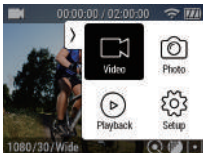

Captura de pantalla de uso del botón.



Captura de pantalla de uso de la pantalla táctil.

1. Después de encender la cámara, pulse el botón () para iniciar la grabación de vídeo.
 2. Cuando la cámara empieza a grabar, el indicador LED parpadea * y muestra el tiempo de grabación en la pantalla.
 3. Pulse el botón () para detener la grabación.
 4. Puede modificar los ajustes de vídeo en la "configuración de vídeo".
- * Si selecciona la opción LED desactivado en la configuración general, el indicador LED no parpadeará.



Vídeo a intervalos

Captura imágenes a intervalos definidos y crea un archivo de vídeo a intervalos.
(0,5 S/1 S/3 S/5 S/10 S/30 S/60 S)



Bucle

Graba un vídeo continuamente hasta que detenga la grabación.

** La capacidad máxima del archivo de vídeo es de 4 GB. Si el tamaño del archivo es superior al espacio del bucle, la cámara sobrescribirá el archivo de grabación actual.



Zoom

Toque dos veces brevemente en la pantalla táctil y aparecerá la función del zoom. Después de 3 segundos, el menú del zoom desaparece automáticamente y guarda el valor durante la grabación. (x1/x2/x3/x4)



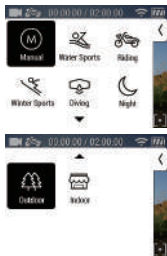

Doble toque



Menú de vídeo

El menú de vídeo proporciona una configuración de efectos de cámara rápidos y sencillos basada en su entorno. El menú de programa está disponible con botón y con pantalla táctil.

Para botón

1. En el modo de vídeo, presione el botón () y manténgalo pulsado durante dos segundos. A continuación, aparecerá el icono el menú de programa.
2. Presione de nuevo el botón () para cambiar al modo que desea.
3. Pulse el botón () para acceder al menú de ajustes en cada categoría.

Para la pantalla táctil

1. En el modo de vídeo, arrastre el dedo hacia la derecha. A continuación, aparecerá la pantalla del menú de programa.
2. Toque el modo que desea.



Manual

Vuelva a la configuración anterior antes del modo de programa



Deportes acuáticos

Para grabaciones en el agua o en la playa



Submarinismo

Para grabaciones bajo el agua



Deportes de invierno

Para grabaciones en la nieve



Equitación

Para grabaciones de actividades veloces



Exteriores

Para grabaciones en exteriores con mucha luz



Interiores

Para grabaciones en interiores



Nocturno

Para grabaciones por la noche

8. Modo de foto

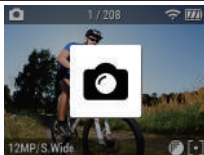

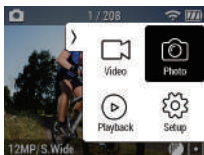

Captura de pantalla de uso del botón.



Captura de pantalla de uso de la pantalla táctil.

Por favor, cambie el modo a fotografía.

1. Presione el botón (). Aparecerá el menú de modo en su pantalla LCD.
2. Presione de nuevo el botón (), la cámara cambiará al modo de fotografía.
3. Después de 1 segundo, desaparecerá automáticamente el menú de modo de la pantalla LCD. Ya puede empezar a tomar fotografías.
4. Puede modificar los ajustes de fotos en detalle en el menú de configuración.

También puede cambiar el modo más fácilmente tocando la pantalla.

1. Arrastre el dedo hacia la izquierda para cambiar el modo.
2. Toque el icono de la fotografía.
3. Presione el botón () para empezar a tomar fotografías.



Fotografía a intervalos

Captura imágenes a intervalos definidos y crea un archivo de fotografía a intervalos.
(0,5 S/1 S/3 S/5 S/10 S/30 S/60 S)



Ráfaga

Ráfaga de fotografías.
(6/1 s)



Zoom(x1/x2/x3/x4)

Toque dos veces brevemente en la pantalla táctil y aparecerá la función del zoom. Después de 3 segundos, el menú del zoom desaparece automáticamente y guarda el zoom durante la grabación.



Autodisparador



Captura una imagen después del tiempo establecido.
(5 s/10 s/15 s)



Menú de fotografía

El menú de vídeo proporciona una configuración de efectos de cámara rápidos y sencillos basada en su entorno. El menú de programa está disponible con botón y con pantalla táctil.

Para botón

1. En el modo de vídeo, presione el botón () y manténgalo pulsado durante dos segundos. A continuación, aparecerá el icono del menú de programa.
2. Presione de nuevo el botón () para cambiar al modo que dese.
3. Pulse el botón () para acceder al menú de ajustes en cada categoría.

Para la pantalla táctil

1. En el modo de foto, arrastre el dedo hacia la derecha.
A continuación, aparecerá la pantalla del menú de programa.
2. Toque el modo que desea.



Manual

Vuelva a la configuración anterior antes del modo de programa



Retrato

Para hacer retratos



Interiores

Para fotografías en interiores



Exteriores

Para fotografías en exteriores con mucha luz



Paisaje

Para fotografías en exteriores con mucha luz



Nocturno

Para grabaciones por la noche

9. Modo de reproducción

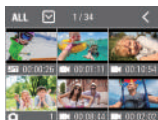







Por favor, cambie el modo a reproducción.

El usuario puede ver las fotos o el vídeo grabado en la pantalla.

Pulse el botón (⊙) para seleccionar el panel de control en el menú superior.

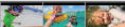
Mientras se reproduce el archivo, puede invocar el panel de control de reproducción presionando el botón (⊙).

Icono	Descripción
ALL  	La función de clasificación ofrece 3 opciones: Todo (vídeo y fotografía), vídeo y fotografía
 	Seleccione para borrar un archivo. Es posible borrar varios archivos de una vez.
1/34	Número IDX de archivo o cantidad de archivos seleccionados / Cantidad de archivos total
	Botón para volver
	Imagen en miniatura
 	Tipo de archivo
00:00:16 / 1	Tiempo de grabación (para el archivo de vídeo) / Cantidad de imágenes (para el archivo de fotografía)

*Arrastre el dedo a la derecha o a la izquierda para ir a la siguiente página.

Reproducción (vídeo)

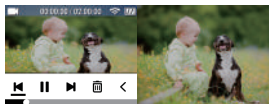

Con un toque puede ocultar la barra de control. Cuando vuelva a tocar la pantalla, aparecerá la barra de control.

N.º	Icono	Descripción
①		Tipo de archivo
		Tiempo de reproducción / Tiempo total
		Batería restante
②		Archivo anterior / Pausa / Archivo siguiente
		Borrar / Volver
③		Barra de desplazamiento

Reproducción (fotografía)

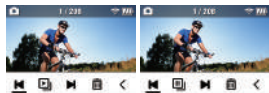

Puede ver todos los archivos de fotografía con la función de mostrar diapositivas.

*Intervalo y ráfaga solo mostrarán la primera fotografía.

N.º	Icono	Descripción
①		Tipo de archivo
		Tiempo de reproducción / Tiempo total
		Batería restante
②		Archivo anterior / Pausa / Archivo siguiente
		Borrar / Volver

10. Modo de configuración

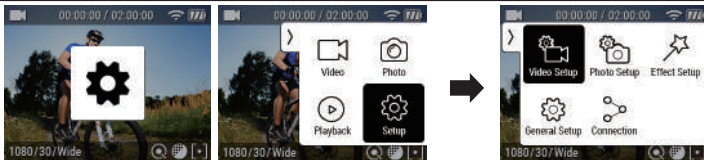

Captura de pantalla de uso de la pantalla táctil y el botón

Por favor, cambie el modo a configuración.

- Puede elegir más opciones con el modo configuración.
- Configuración de video: Proporciona opciones detalladas de grabación de video.
- Configuración de fotografía: Proporciona opciones de disparo de fotografía.
- Configuración de efectos: Proporciona opciones de configuración de efectos para el disparo.
- Configuración general: Proporciona opciones de configuración general de la cámara.
- Conexión : Proporciona función WiFi.

Configuración	Opción
Configuración de video	Modo/Resolución/FPS/campo de visión /Video Calidad/intervalo/WDR/DIS
Configuración de fotografía	Modo/Pixel/FOV/Photo Calidad/Intervalo/DIS
Configuración de efectos	filtro/medidor EA/Zoom/exposición/ equilibrio blanco/ISO/invertido/marca de tiempo
Configuración general	Control/bip/indicador LED/Quick REC/LCD automático apagado/potencia automática apagada/bloqueo de pantalla/salida TV/ configuración de tiempo/formato de memoria /predeterminado/Infomación de Software
Conexión	WiFi/WiFi Info

10-1. Opciones de configuración

VIDEO SETUP <	
MODE	Manual
RESOLUTION	1080P
FPS	30

PHOTO SETUP <	
MODE	Manual
MEGA PIXEL	16MP
FOV	Super Wide

Función	Descripción
Modo	Manual/bucle/intervalo
Resolución	1080P/ 720P/ 480P
FPS	240/120/60/30
Campo de visión	Súper gran angular/gran angular/normal/teleobjetivo
VÍDEO Calidad	Súper alta /Alta /Normal
INTERVALLE T/LAPSE	0.5/ 1 / 3 / 5 / 10 /30 / 60 (sec)
WDR	ACTIV./DESACTIV.
DIS	ACTIV./DESACTIV.

Función	Descripción
Modo	Manual/intervalo/ráfaga/autodisparo
MEGA PÍXEL	16MP / 12MP / 8.5MP/ 7MP
Campo de visión	Súper gran angular/gran angular/normal/teleobjetivo
Photo Calidad	Súper alta /Alta /Normal
INTERVALO	0.5/ 1 / 3 / 5 / 10 /30 / 60 (s)
INTERVALO autodisparo	5/ 10 / 15 (s)
DIS	ACTIV./DESACTIV.

★ EFFECT SETUP <	
ZOOM	x1
FILTER	Off
AE METER	Average

⚙️ GENERAL SETUP <	
CONTROL	Mic
BEEP	On
LED INDICATOR	Four

Función	Descripción
Zoom	x1/ x2/x3/x4
Filtro	Desactivado/Blanco y negro/Sepia/Vivido/Natural /Negativo/Cálido/Fresco/Rojo/Vede/Azul
Medidor de AE	CENTRO/PROMEDIO/PUNTOS
Exposición	-2.0/-1.0/0/+1.0/+2.0
Balance de blancos	AUTOMÁTICA/3000K/5500K/6500K
ISO	AUTOMÁTICA/100/200/400/800/1600/3200
Invertido	ACTIV./DESACTIV.
Marca de tiempo	ACTIV./DESACTIV.

Función	Descripción
CONTROL	Micrófono/altavoz/brillo LCD
BEEP	ACTIV./DESACTIV.
INDICADOR LED	DESACTIVADO/DOS/CUATRO
QUICK REC	DESACTIVADO/05/35/55
LCD AUTOMÁTICO DESACTIVADO	OFF/30sec/ 1min/ 5min
POTENCIA AUTOMÁTICA DESACTIVADA	OFF/ 5min/ 10min/ 30min
BLOQUEO DE PANTALLA	OFF/ 5sec/ 10sec/ 30sec
SALIDA TV	NTSC/PAL
CONFIGURACIÓN DE TIEMPO	FECHA - HORA
FORMATO DE MEMORIA	SÍ/NO
PREDETERMINADO	SÍ/NO
INFORMACIÓN DE SOFTWARE	



WIFI INFO

SSID-PW

Función	Descripción
WiFi	ON/OFF
WiFi INFO	SSID-PW

11. Menú rápido

El menú rápido proporciona acceso a su menú más utilizado.

El menú rápido solo está disponible con la pantalla táctil.

1. Arrastrar hacia arriba. A continuación, aparecerá la pantalla del menú rápido.
2. Toque el menú en el que desea entrar.



Función	Descripción
WIFI	ACTIV./DEACTIV.
Invertido	ACTIV./DEACTIV.
QUICK REC	ACTIV./DEACTIV.
Bip	ACTIV./DEACTIV.
Altavoz	ACTIV./DEACTIV.
Micrófono	ACTIV./DEACTIV.
Brillo	Barra de control

12. Recargar la batería

- La pantalla mostrará el icono de batería baja () cuando la batería tenga poca carga y la cámara esté a punto de apagarse.
- La cámara grabará el archivo automáticamente hasta que se apague. Debe recargar la batería para reanudar la grabación.
- Tardará unas 3,5 horas en obtener una carga completa desde un puerto USB.
- Puede usar un cargador de baterías (accesorio opcional) para cargar más rápido.

1. Apague la cámara.
2. Conecte el puerto USB de la cámara a su ordenador con un cable USB.
3. El indicador LED se encenderá para indicar que la batería está cargándose.
4. El indicador LED se apagará cuando esté completamente cargada.

13. Control desde smartphone

- Mediante la función WiFi APP de ACTIVEON, el usuario puede controlar la cámara desde su smartphone.
- Compatible con dispositivos iOS y Android OS.
- Antes de conectar la cámara, descargue la aplicación 'ACTIVEON' desde la tienda de aplicaciones de su smartphone.
- Busque 'ACTIVEON' en Apple App Store o en Google Play Store.

** Cuando el smartphone está conectado a la cámara, no funcionarán los botones de la cámara.*

** Puede grabar vídeos, tomar fotos y modificar los ajustes de la cámara en 'ACTIVEON'.*

** Las funciones de 'ACTIVEON' se mejorarán actualizando la aplicación a través de su smartphone.*

14. Conecte ACTIVEON CX GOLD a su smartphone (con la app ACTIVEON)

En su cámara

- Active la función 'WiFi APP' en ACTIVEON CX Gold.
- La pantalla de la cámara mostrará "Waiting for connection" ("Esperando conexión")

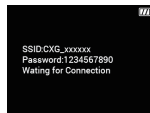

14. Conecte ACTIVEON CX GOLD a su smartphone (con la app ACTIVEON)

En su smartphone

- En su smartphone o tableta, active la conexión WiFi y seleccione la red CXG-xxxxxx en los ajustes de WiFi.
- La contraseña predeterminada es '1234567890'.
- Inicie la app '**ACTIVEON**' en su smartphone o tableta.
- Pulse 'Connect ACTIVEON' ('Conectar ACTIVEON') en la app; ya puede controlar su cámara ACTIVEON.

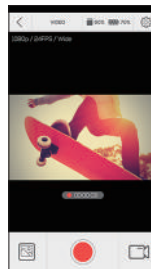
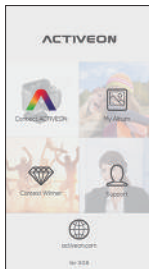

15. Transferir datos al ordenador (compatible con sistemas operativos Windows y Mac)

- Si la cámara está conectada a un ordenador o cargador de baterías mientras está apagada, la cámara comienza a recargar la batería.
- Si la cámara está conectada a un ordenador mientras está encendida, la cámara cambia al modo de transferencia.
- Cuando la cámara está conectada a un cargador de baterías o cargador de coche para recargarla, la cámara puede grabar mientras se recarga.
 1. Encienda su ACTIVEON CX Gold.
 2. Conecte la cámara a su ordenador con un cable USB.
 3. La pantalla LCD de la cámara indicará 'USB ready' 'USB preparado'.
 4. Vaya a 'Mi PC' en su ordenador.
 5. Busque 'removable disk' ('disco extraíble').
 6. Haga doble clic en 'removable disk' ('disco extraíble').
 7. Haga doble clic en la carpeta 'DCIM'.
 8. Abra las carpetas para ver sus archivos de vídeo o fotos.
 9. Copie y pegue los archivos en el ordenador.

16. Actualización del firmware (puede encontrar el firmware más reciente en www.activeon.com)

- Siempre puede encontrar las actualizaciones del firmware más recientes de los productos ACTIVEON en la página web. (www.activeon.com)
- La actualización del firmware podría no estar disponible si la carga de la batería es demasiado baja.
- Recargue hasta dos celdas del indicador de la batería para realizar la actualización.
 1. Formatee la tarjeta de memoria y copie el archivo de firmware en el directorio raíz de la tarjeta microSD.
 2. Inserte la tarjeta microSD en su ACTIVEON CX GOLD y encienda la cámara.
 3. La actualización del firmware se iniciará automáticamente y se mostrará el estado de la actualización en la pantalla.
 4. Cuando finalice la actualización, la cámara mostrará 'F/W Updating' ('Actualizando firmware') y se apagará automáticamente.
** Do Not turn off the camera or take out the battery during firmware upgrade.*

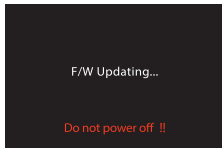

17. Características y especificaciones

- Cámara de acción "ACTIVEON CX GOLD" 1080p 60 fps.
- Grabación con resolución Full HD (1920 x 1080) a 60 fps.
- Carcasa impermeable de 60m.
- Sensor 16M SONY IMX CMOS.
- Configuración de efectos de la cámara de fácil control mediante el modo de programa.
- Campo de visión súper gran angular.
- LCD de 2,0" integrada (320x240) con panel táctil.
- Wifi integrada.
- Resolución de grabación versátil (1080p/720p/480p)
- Captura de ráfaga de fotos (* 6 tomas en 1 segundo)
- Códec H.264, guardado como formato MP4.
- Batería recargable de ion de litio.
- Autonomía de la batería: aproximadamente 120 minutos de grabación continua (1080p 30 fps)
 - * *el tiempo de grabación puede variar en función de las condiciones*
- Tiempo de recarga: 3,5 horas mediante puerto USB/2,5 horas mediante adaptador de CA (accesorio opcional)
- Sencilla interfaz de usuario gráfica.
- Amplia gama de accesorios.

18. Contenido del paquete



ACTIVEON CX Gold
Cámara de acción



Cubierta resistente al agua



Dispositivo abierto



Soporte adhesivo curvo



Tornillo de conexión



Conector corto



Batería recargable de ion litio

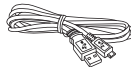

Cable USB



Tarjeta microSD

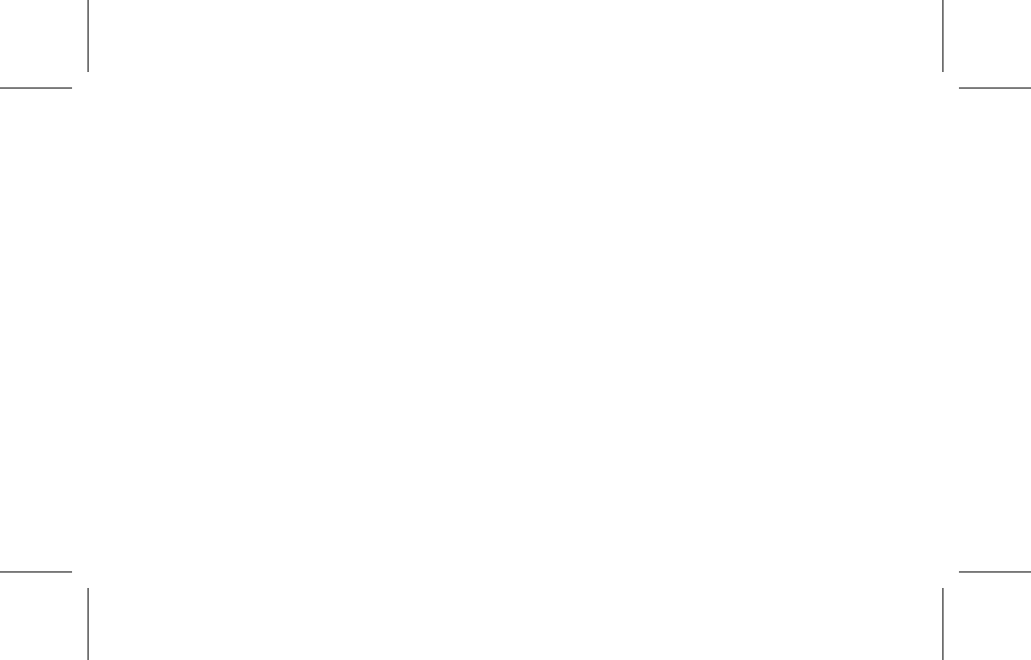



NOTICE

www.activeon.com



CAUTION

It could be exploded if the battery is inappropriate type. Please insert proper type of battery according to instructions.



The symbol means that according to local laws and regulations your product should be disposed of separately from household waste. When this product reaches its end of life, take it to a collection point designated by local authorities. Some collection points accept products for free. The separate collection and recycling of your product at the time of disposal will help conserve natural resources and ensure that it is recycled in a manner that protects human health and the environment.

FCC RADIO FREQUENCY INTERFERENCE STATEMENT

FCC ID : XOMGCX01

This device complies with Part 15 of the FCC Rules. Operation is subject to the following two conditions:

- (1) This device may not cause harmful interference, and
- (2) This device must accept any interference received, including interference that may cause undesired operation.

Warning: Changes or modifications to this unit not expressly approved by the party responsible for compliance could void the user's authority to operate the equipment.

Note: This equipment has been tested and found to comply with the limits for a Class B digital device, pursuant to Part 15 of the FCC Rules.

These limits are designed to provide reasonable protection against harmful interference in a residential installation. This equipment generates, uses and can radiate radio frequency energy and, if not installed and used in accordance with the instructions, may cause harmful interference to radio communications. However, there is no guarantee that interference will not occur in a particular installation. If this equipment does cause harmful interference to radio or television reception, which can be determined by turning the equipment off and on, the user is encouraged to try to correct the interference by one or more of the following measures:

- Reorient or relocate the receiving antenna.
- Increase the separation between the equipment and receiver.
- Connect the equipment into an outlet on a circuit different from that to which the receiver is connected.
- Consult the dealer or an experienced radio/TV technician for help.

The device has been evaluated to meet general RF exposure requirement.

The device can be used in portable exposure condition without restriction.00

RF Exposure Information (SAR)

This device meets the U.S. government's requirements for exposure to radio waves.

This device is designed and manufactured not to exceed the emission limits for exposure to radio frequency (RF) energy set by the Federal Communications Commission of the U.S. Government.

The exposure standard employs a unit of measurement known as the Specific Absorption Rate (SAR). The SAR limit set by the FCC is 1.6W/kg. Tests for SAR are conducted using standard operating positions accepted by the FCC, with the device transmitting at the certified power level in all tested different channels.

The FCC have granted an Equipment authorization for this device with all reported SAR levels evaluated as in compliance with the FCC RF exposure guidelines. SAR information on this device is on file with the FCC, and can be found under the Display Grant section of www.fcc.gov/oet/ea/fddid after searching on

This device is compliance with SAR for general population / uncontrolled exposure limits in ANSI/IEEE C95.1-1999 and had been tested in accordance with the measurement methods and procedures specified in OET bulletin 65 Supplement C.

FCC ID : XOMGCX01



HDMI, the HDMI logo, and High-Definition Multimedia Interface are trademarks or registered trademarks of HDMI Licensing LLC.



USA Warranty

www.activeon.com



ACTIVEON LIMITED WARRANTY

This limited warranty is provided by ACTIVEON to the original end-user purchaser ("Purchaser"), when delivered in new condition in its original container.

The Product is warranted to be free from manufacturing defects under normal use and service for a period of 12 months from the date of original purchase ("Warranty Period"). Where there is no evidence of the date of original purchase, ACTIVEON shall consider the date of manufacture as the date of original purchase.

If the Product is returned to an ACTIVEON and ACTIVEON concludes in its discretion that the product is defective in manufacture, ACTIVEON may, at its sole discretion and without charge (a) exchange the Product for a new Product, or (b) exchange the Product for a refurbished Product.

Exchange or replacement of the Product does not extend the original warranty period of the Product.

No warranty shall be provided if the Product is damaged through the negligence or fault of others, abuse, mishandling, improper packaging by you, alteration, accident, electrical current fluctuations, failure to follow ACTIVEON's operating and maintenance instructions, or if services are performed to the Product by someone other than ACTIVEON or its authorized service provider. Water, environmental, sand, and corrosion damage; battery leakage, scratches, or damage to the Product will be presumed to have resulted from misuse, abuse or failure to operate the Product as set forth in the operating and maintenance instructions. No warranty shall be provided if the Product has had its serial number or dating altered or removed.

ACTIVEON SPECIFICALLY DISCLAIMS ANY IMPLIED WARRANTY OF MERCHANTABILITY OR FITNESS FOR A PARTICULAR PURPOSE DURING OR AFTER THE EXPRESS WARRANTY PERIOD STATED ABOVE, AND NO OTHER EXPERT WARRANTY OR GUARANTEE, EXCEPT AS MENTIONED ABOVE, SHALL BE BINDING ON ACTIVEON. (SOME STATES AND PROVINCES DO NOT ALLOW LIMITATIONS ON HOW LONG AN IMPLIED WARRANTY LASTS, SO THE ABOVE LIMITATION MAY NOT APPLY TO YOU) ACTIVEON SHALL NOT BE LIABLE FOR AND SPECIFICALLY DISCLAIMS LIABILITY FOR INCIDENTAL OR CONSEQUENTIAL DAMAGES, ANY ACCIDENT, INJURY, DEATH, LOSS OR OTHER CLAIM RELATED TO OR RESULTING FROM THE USE OF THIS PRODUCT, INCLUDING BUT NOT LIMITED TO LOSS OF REVENUES OR PROFITS, INCONVENIENCE, EXPENSE FOR SUBSTITUTE EQUIPMENT OR SERVICE, STORAGE CHARGES, LOSS OR CORRUPTION OF DATA, OR ANY OTHER SPECIAL, INCIDENTAL OR CONSEQUENTIAL DAMAGES CAUSED BY THE USE OR MISUSE OF, OR INABILITY TO USE, THE PRODUCT, REGARDLESS OF THE LEGAL THEORY ON WHICH THE CLAIM IS BASED. ACTIVEON SHALL NOT BE LIABLE FOR WATER HOUSING LEAKAGE OR ANY RESULTING DAMAGES CAUSED BY USER'S RESEALING ERROR. IN NO EVENT SHALL RECOVERY OF ANY KIND AGAINST ACTIVEON BE GREATER IN AMOUNT THAN THE PURCHASE PRICE OF THE PRODUCT. WITHOUT LIMITING THE FOREGOING, THE PURCHASER ASSUMES ALL RISK AND LIABILITY FOR LOSS, DAMAGE OR INJURY TO YOU AND YOUR PROPERTY AND TO OTHERS AND THEIR PROPERTY ARISING OUT OF USE OR MISUSE OF, OR INABILITY TO USE, THE PRODUCT NOT CAUSED DIRECTLY BY THE NEGLIGENCE OF ACTIVEON. (SOME STATES AND PROVINCES DO NOT ALLOW THE EXCLUSION OR LIMITATION OF INCIDENTAL OR CONSEQUENTIAL DAMAGES, SO THE ABOVE EXCLUSION OR LIMITATION MAY NOT APPLY TO YOU). THIS LIMITED WARRANTY SHALL NOT EXTEND TO ANYONE OTHER THAN THE ORIGINAL PURCHASER OF THE PRODUCT, AND IS THE PURCHASER'S SOLE AND EXCLUSIVE REMEDY.

For assistance (USA)—If you purchased ACTIVEON product in USA and have questions regarding the product or this Limited Warranty, please call 1-858-798-3300. Or visit www.activeon.com.

It is the Purchaser's responsibility to properly package and send the Product, together with a copy of the original proof of purchase, an explanation of the problem, and a return address to ACTIVEON at the Purchaser's expense. If the Product covered by this limited warranty and proven to be defective upon inspection, it will be serviced and returned to the Purchaser at no charge. Any received Product that is not covered by this limited warranty or is beyond the Warranty Period will be returned as it is.



EU Warranty

www.activeon.com



ACTIVEON LIMITED WARRANTY (EU)

The following limited warranty is provided by ACTIVEON with respect to the ACTIVEON product ("Product") purchased by the original end user purchaser ("Purchaser"), when delivered in new condition in its original container. Consumers have legal rights under applicable national legislation governing the sale of consumer goods. Such rights are not affected by the warranties in this limited warranty.

The Product is warranted to be free from manufacturing defects under normal use and service for a period of 24 months as from the date of original purchase ("Warranty Period"). Where there is no evidence of the date of original purchase, ACTIVEON shall consider the date of manufacture as the date of original purchase.

If the Product is returned to ACTIVEON and ACTIVEON concludes in its discretion that the product is defective in manufacture, ACTIVEON may, at its sole discretion and without charge (a) exchange the Product for a new Product, or (b) exchange the Product for a refurbished Product.

Exchange or replacement of the Product does not extend the original Warranty Period of the Product.

No warranty shall be provided if the Product is damaged through the negligence or fault of others, abuse, mishandling, improper packaging by you, alteration, accident, electrical current fluctuations, failure to follow ACTIVEON's operating and maintenance instructions, or if services are performed to the Product by someone other than ACTIVEON or its authorized service provider. Water, environmental, sand, and corrosion damage; battery leakage, scratches, or damage to the Product will be presumed to have resulted from misuse, abuse or failure to operate the Product as set forth in the operating and maintenance instructions. No warranty shall be provided if the Product has had its serial number or dating altered or removed. Damages deriving from an accident or caused by the natural wear and tear (including but not limited to accessories and batteries) do not fall within this guarantee or other guarantees.

ACTIVEON SPECIFICALLY DISCLAIMS ANY IMPLIED WARRANTY OF MERCHANTABILITY OR FITNESS FOR A PARTICULAR PURPOSE DURING OR AFTER THE EXPRESS WARRANTY PERIOD STATED ABOVE, AND NO OTHER EXPERT WARRANTY OR GUARANTEE, EXCEPT AS MENTIONED ABOVE, SHALL BE BINDING ON ACTIVEON. (SOME TERRITORIES DO NOT ALLOW LIMITATIONS ON HOW LONG AN IMPLIED WARRANTY LASTS, SO THE ABOVE LIMITATION MAY NOT APPLY TO YOU) ACTIVEON SHALL NOT BE LIABLE FOR AND SPECIFICALLY DISCLAIMS LIABILITY FOR INCIDENTAL OR CONSEQUENTIAL DAMAGES, ANY ACCIDENT, INJURY, DEATH, LOSS OR OTHER CLAIM RELATED TO OR RESULTING FROM THE USE OF THIS PRODUCT, INCLUDING BUT NOT LIMITED TO LOSS OF REVENUES OR PROFITS, INCONVENIENCE, EXPENSE FOR SUBSTITUTE EQUIPMENT OR SERVICE, STORAGE CHARGES, LOSS OR CORRUPTION OF DATA, OR ANY OTHER SPECIAL, INCIDENTAL OR CONSEQUENTIAL DAMAGES CAUSED BY THE USE OR MISUSE OF, OR INABILITY TO USE, THE PRODUCT, REGARDLESS OF THE LEGAL THEORY ON WHICH THE CLAIM IS BASED. ACTIVEON SHALL NOT BE LIABLE FOR WATER HOUSING LEAKAGE OR ANY RESULTING DAMAGES CAUSED BY USER'S RESEALING ERROR. IN NO EVENT SHALL RECOVERY OF ANY KIND AGAINST ACTIVEON BE GREATER IN AMOUNT THAN THE PURCHASE PRICE OF THE PRODUCT. WITHOUT LIMITING THE FOREGOING, THE PURCHASER ASSUMES ALL RISK AND LIABILITY FOR LOSS, DAMAGE OR INJURY TO YOU AND YOUR PROPERTY AND TO OTHERS AND THEIR PROPERTY ARISING OUT OF USE OR MISUSE OF, OR INABILITY TO USE, THE PRODUCT NOT CAUSED DIRECTLY BY THE NEGLIGENCE OF ACTIVEON (SOME STATES AND PROVINCES DO NOT ALLOW THE EXCLUSION OR LIMITATION OF INCIDENTAL OR CONSEQUENTIAL DAMAGES, SO THE ABOVE EXCLUSION OR LIMITATION MAY NOT APPLY TO YOU), EXCEPT WHERE PROHIBITED BY APPLICABLE LAW. (I) THIS LIMITED WARRANTY SHALL NOT EXTEND TO ANYONE OTHER THAN THE ORIGINAL PURCHASER OF THE PRODUCT, AND IS THE PURCHASER'S SOLE AND EXCLUSIVE REMEDY AND (II) THIS LIMITED WARRANTY IS LIMITED TO THE COUNTRY OF PURCHASE OF THE PRODUCT.

For assistance (EU) – If you purchased an ACTIVEON product in the EU and if you have questions regarding the Product or this Limited Warranty, please visit www.activeon.com.

It is the Purchaser's responsibility to properly package and send the Product, together with a copy of the original proof of purchase, an explanation of the problem, and a return address to ACTIVEON. If the Product is covered by this Limited Warranty and proven to be defective upon inspection, it will be serviced and returned to the Purchaser at no charge. Any received Product that is not covered by this Limited Warranty will be returned to the Purchaser as it is.

ACTIVEON EU B.V. HULLENBERGWEG 278 1101 BV AMSTERDAM THE NETHERLANDS (Not a visiting address)

ACTIVEON