

IQ DOOR/WINDOW

The Qolsys IQ Door/Window is a sleek, high-performance wireless sensor that detects opening and closing of doors, windows and anything else which opens and closes (drawers, cabinets, etc). It works seamlessly with the Qolsys IQPanel.

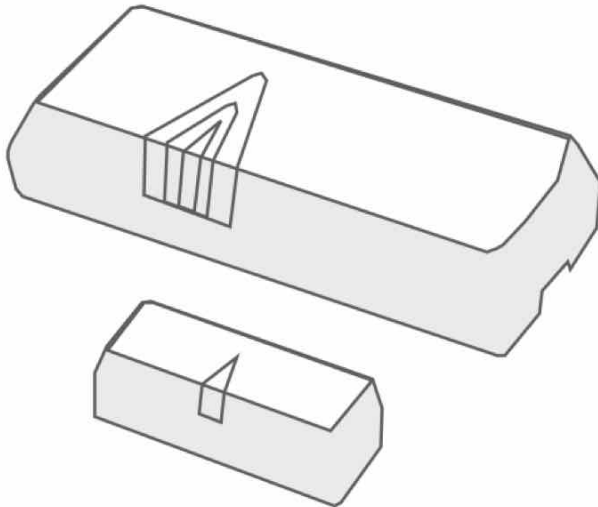

TECHNICAL SPECIFICATIONS

Wireless signal range: 600ft (200M), open air.
 Code outputs: tamper, tamper restore, alarm (primary open), alarm restore (primary close), external alarm (secondary wired open), external restore (secondary wired closed), low battery.
 Transmitter frequency : 319.5MHZ
 Unique code ID
 Supervisory keep-alive interval: 70 minutes.
 RF output power 91.1dBuV +/- 5% at 3m

PARTS INCLUDED

1 Door/Window Sensor
 1 Magnet
 6 screws
 1 large strip of double sided adhesive
 1 small strip of double sided adhesive



PRODUCT FEATURES

- Low profile
- Supports one or two doors, windows, etc.
- Primary wireless magnet contact and secondary wired contact
- Internal or external reed switch
- Easy, wire-free installation
- Secondary (optional) sensor (external wired Door/Window sensor)
- Advanced circuit technology resulting in ultra-low power consumption
- Easy to install Batteries
- Over 5 years of battery life
- Tamper Detection
- Supervisory health messaging
- Sensor Open and Close detection

GUIDELINES

- Mount the sensor on the door frame and the magnet on the door. If the sensor is used on double doors, mount the sensor on the least-used door and the magnet on the most-used door.
- If possible, locate sensors within 100 ft. (30 m) from the panel.
- While a transmitter may have a range of 600 ft. (200 m) or more out in the open, the environment at the installation site can have a significant effect on transmitter range. Sometimes a change in sensor orientation can help overcome adverse wireless conditions.
- Make sure the alignment arrow on the magnet points to the alignment mark on the sensor.
- Place sensors at least 6 in. (15.24 cm) above the floor to avoid damaging them.
- Avoid mounting sensors in areas where they will be exposed to moisture or where the sensor operating temperature range of 0 to 120°F (0 to 49°C) will be exceeded.
- Use spacers (not included) to keep sensors and magnets away from metal or metallic surfaces such as foil wallpaper.
- Avoid mounting sensors in areas with a large quantity of metal or electrical wiring, such as a furnace or utility room

PLACEMENT AND SPACING

Be sure to align the triangle guides on the sensor and magnet as shown. This will enable the proper contact between the sensor and magnet. When closed, the magnet should be within .4" of the sensor for optimum sensitivity.

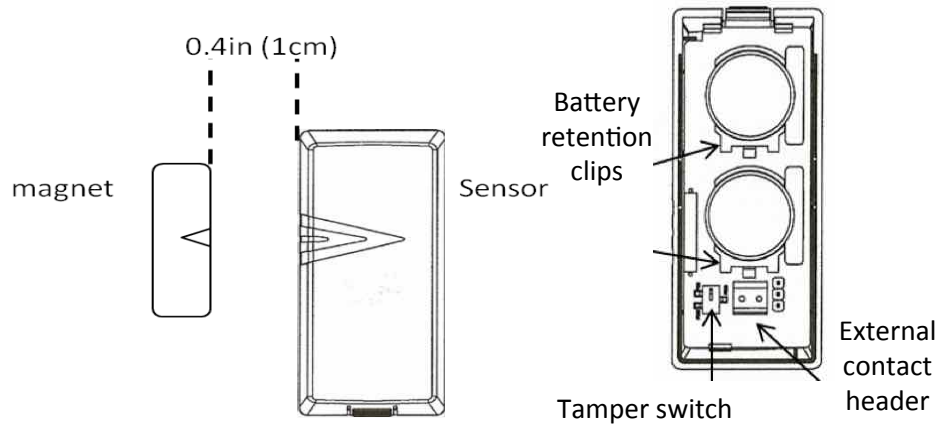

Please note: the sensor will not operate the reed switch and external contact header simultaneously.

BATTERY ACTIVATION

To activate the batteries in the sensor, remove the cover and pull out the plastic tabs between the batteries and the contacts.

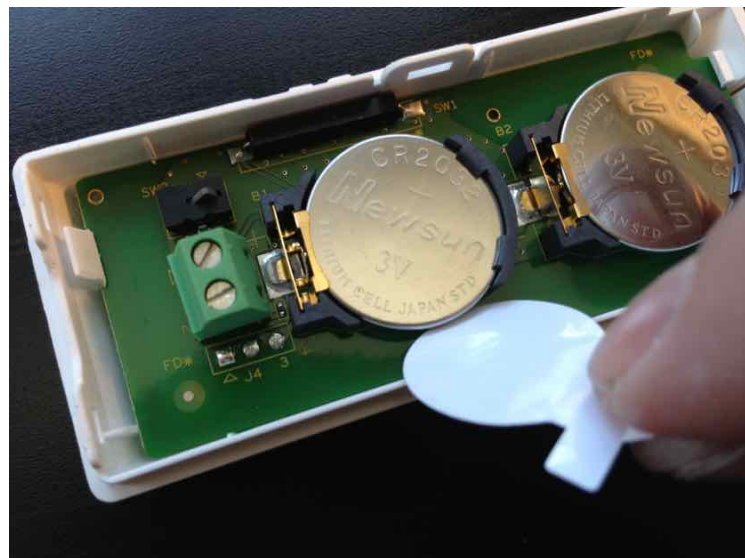

MOUNTING WITH PROVIDED ADHESIVE

- Remove backing on one side of the large double-sided tape and stick the exposed side on the back of the sensor as shown.
- Remove the other side of the large double-sided tape and mount the device according to the installation instructions
- Remove the backing one side of the small double-sided tape and place on back of magnet
- Lineup the magnet with the sensor using the arrows shown on each device respectively. Ensure the sensor and magnet are not separated more than 0.4 inches as shown.
- Remove the second side of the double-sided tape and secure the magnet.

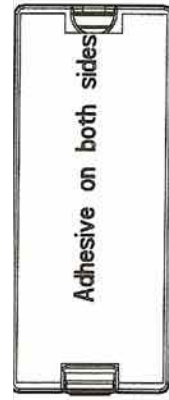

MOUNTING WITH PROVIDED HARDWARE

- Remove the back of the sensor by pressing on the tab and pulling the cover off
- Place the base of the sensor on the appropriate surface and use 4 of the supplied screws to secure the mounting plate to the chosen location
- To secure the magnet, remove the mounting plate by prying it off the magnet casing.
- Be sure the arrows on the top of the casing align with the arrows on the sensor casing. The sensor and magnet should not be mounted more than 0.4 inches apart.
- Use the 2 remaining screws provided to secure the magnet mounting plate in the proper location. Clip the magnet casing back into place once the plate is secure.

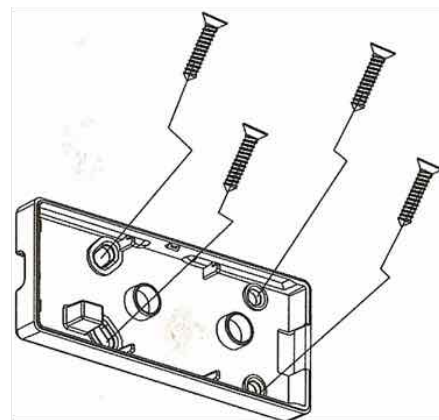
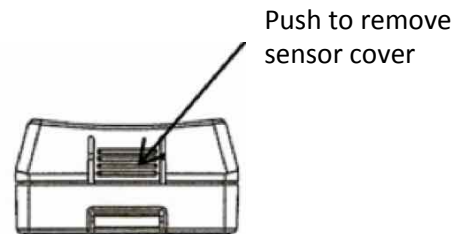



PROGRAMMING THE IQ DOOR/WINDOW

The following steps describe general guidelines for programming (learning) the sensor into the IQ Panel. Refer to the IQ Panel's installation instructions for complete programming details.

1  From the home screen of the IQ panel, touch the "Settings" icon

2  Enter the installer passcode. Default installer passcode is 1111

3  Touch the "Installation" app

4  Touch the "Security Sensors" app

5  Touch the "AutoLearn Sensor" app

4  Tamper the sensor by pressing the tab and lifting off the cover.

6  A chime will sound

7  Touch "Ok"

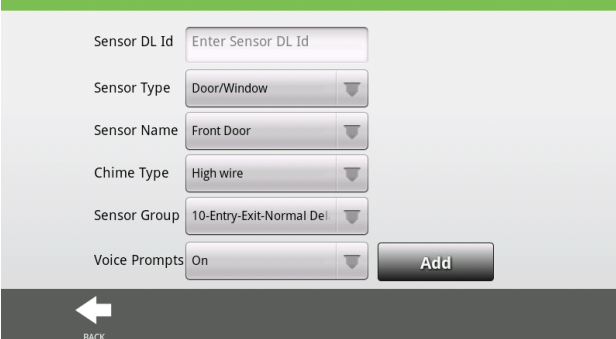
8  The screenshot shows the 'Add Sensor' screen with the following fields: Sensor DL Id (Enter Sensor DL Id), Sensor Type (Door/Window), Sensor Name (Front Door), Chime Type (High wire), Sensor Group (10-Entry-Exit-Normal Del), and Voice Prompts (On). There is an 'Add' button at the bottom right and a 'BACK' button at the bottom left.

Check the auto-populated fields to ensure accuracy. Customize device settings as desired.

9  The screenshot shows the 'Sensor Name' field with a dropdown menu set to 'Custom Description' and the text 'Sarahs Bedroom Window' entered in the input field.

Create custom names by selecting "Sensor name" and choosing "Custom description." A keyboard will appear, allowing you to type the name of your choice into the field.

10  A large grey button with the word 'Add' in white text.

Click "Add" to complete the process

BATTERY REPLACEMENT

To replace batteries:

- Push tab on side of sensor and lift off cover.
- Place fingernail or small screwdriver under the battery and gently lift up. The battery should release easily. Remove old battery. Replace with a new battery by putting one end under the golden battery retention clip. Gently push toward the opposite side until the the battery snaps into place under the black plastic.
- Repeat this process for the second battery.
- Close cover by snapping the cover back onto the sensor.

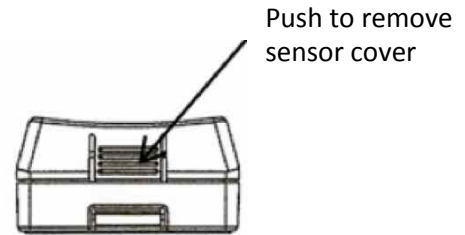

BATTERY TYPE

3V CR2032 Lithium
(2 batteries per sensor)
5+ years battery life

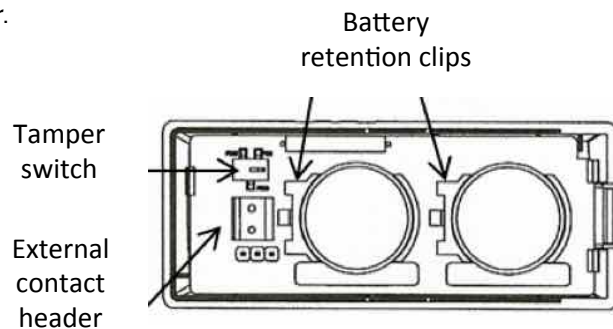

ENVIRONMENTAL CHARACTERISTICS

Operating Temperature: -10C~50C
Relative Humidity: 5-95% Non-Condensing
Storage Temperature: -40-80C

PHYSICAL SPECIFICATIONS

Sensor: 3.25H x 1.3W x 1D in. (8x3x1.5 cm)
Magnet: 1.3H x 0.435W x 0.312D in. (3.3 x 1.1 x 0.79 cm)

SUPPORT



GOT QUESTIONS?
CONTACT TECH SUPPORT

TechSupport@Qolsys.com

IMPORTANT INFORMATION

15.21

§ 15.21 Information to user.

The users manual or instruction manual for an intentional or unintentional radiator shall caution the user that changes or modifications not expressly approved by the party responsible for compliance could void the user's authority to operate the equipment.

CAUTION: Any changes or modifications not expressly approved by the party responsible for compliance could void the user's authority to operate the equipment.

15.105(b)

§ 15.105 Information to the user.

(b) NOTE: This equipment has been tested and found to comply with the limits for a Class B digital device, pursuant to part 15 of the FCC Rules. These limits are designed to provide reasonable protection against harmful interference in a residential installation. This equipment generates, uses and can radiate radio frequency energy and, if not installed and used in accordance with the instructions, may cause harmful interference to radio communications. However, there is no guarantee that interference will not occur in a particular installation. If this equipment does cause harmful interference to radio or television reception, which can be determined by turning the equipment off and on, the user is encouraged to try to correct the interference by one or more of the following measures:

- Reorient or relocate the receiving antenna.
- Increase the separation between the equipment and receiver.
- Connect the equipment into an outlet on a circuit different from that to which the receiver is connected.
- Consult the dealer or an experienced radio/TV technician for help.

RSS-GEN Section 8.4

8.4 User manuals for licence-exempt radio apparatus shall contain the following text, or an equivalent notice that shall be displayed in a conspicuous location, either in the user manual or on the device, or both:

This device complies with Industry Canada's licence-exempt RSSs. Operation is subject to the following two conditions:

- (1) This device may not cause interference; and*
- (2) This device must accept any interference, including interference that may cause undesired operation of the device.*

Document#: IQDW-IM-02-15
Revision#: 2/27/15
Issue Date: FEB 2015
Qolsys Product #: QS-1100-PO1
Firmware : OA_20121130



Conforms to ANSI/UL Std. 634
Certified to ULC Sub. C634
Qolsys Inc. proprietary.
Reproduction without permission is not permitted.