

IQ MOTION

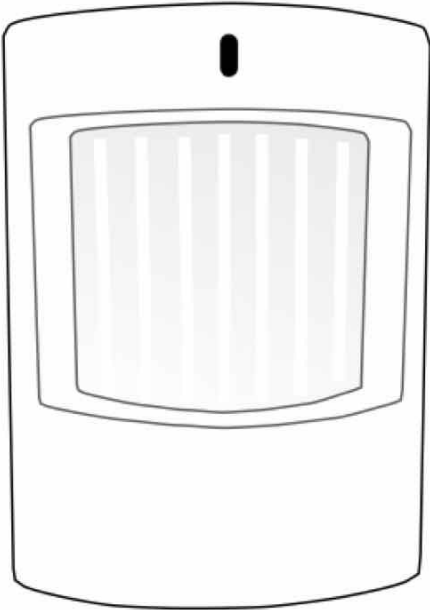

The Golsys IQ Motion is a high-performance wireless motion sensor that uses advanced power circuit technology to extend battery life. The tamper-resistant casing along with an electronic sensor discourages physical tampering and the sensor is equipped with a pet immunity feature that prevents accidental triggers by household pets. The IQ Motion works seamlessly with the Golsys IQ Panel.

TECHNICAL SPECIFICATIONS

- Wireless signal range: 600 ft (200 m), open air
- Code outputs: paring, tamper, tamper restore, alarm detect motion, alarm restore, supervisory, low battery
- Transmitter frequency: 319.5MHZ +/-15KHz
- Transmitter bandwidth: 24KHZ
- Modulation type: ASK-OOK
- RF output power 91.1dBuV +/- 5% at 3m
- Sensor Range 30 ft (9.1 m) x 50 ft (15.2 m)
- Maximum Horizontal Sensing Angle 80°

PARTS INCLUDED

PIR (Passive Infrared) Motion Sensors
2 Mounting screws
2 AAA Alkaline batteries



PRODUCT FEATURES

- Advanced circuit technology resulting in ultra-low power consumption
- Tamper detection/reporting
- Rigid wall mounting for discreet placement
- Pet immunity
- Easy to install batteries
- Supervisory health messaging
- Sensor Motion detection
- Transmits 2 signals per 5 minute period

GUIDELINES

•IQMotionSensor is designed for indoor use and is compatible with homes where pets up to 40 lbs (18 kg) are present. To minimize the possibility of false alarms the following guidelines should be followed:

- The sensor may be mounted in a corner or on a flat wall that is free of vibrations.

- If possible, mount the sensor within 100 ft (30.5 m) of the panel. While the transmitter may have a range of 600 ft (200 m) or more out in the open, the environment at the installation site can have a significant effect on transmitter range. Verify actual transmitter range for each installation.

- Position the sensor to protect an area where an intruder is most likely to walk across the detection pattern.

- Mount the sensor permanently on a flat wall or in a corner.

- Mount the sensor on an interior wall facing in.

- Position the sensor so it faces a solid reference point, such as a wall.

- Close all windows in an area with an armed motion sensor.

DO NOT:

- Aim the sensor at windows, fireplaces, air conditioners, area heaters, or forced air heating vents.

- Place the sensor in direct sunlight as sudden changes in temperature may trigger a false alarm.

- Mount the sensor near duct work or other large metallic surfaces that may affect the RF signals.

- Set the sensor on a shelf.

MOUNTING OPTIONS

Flush-mount or corner-mount the sensor depending on the selected location and desired coverage area

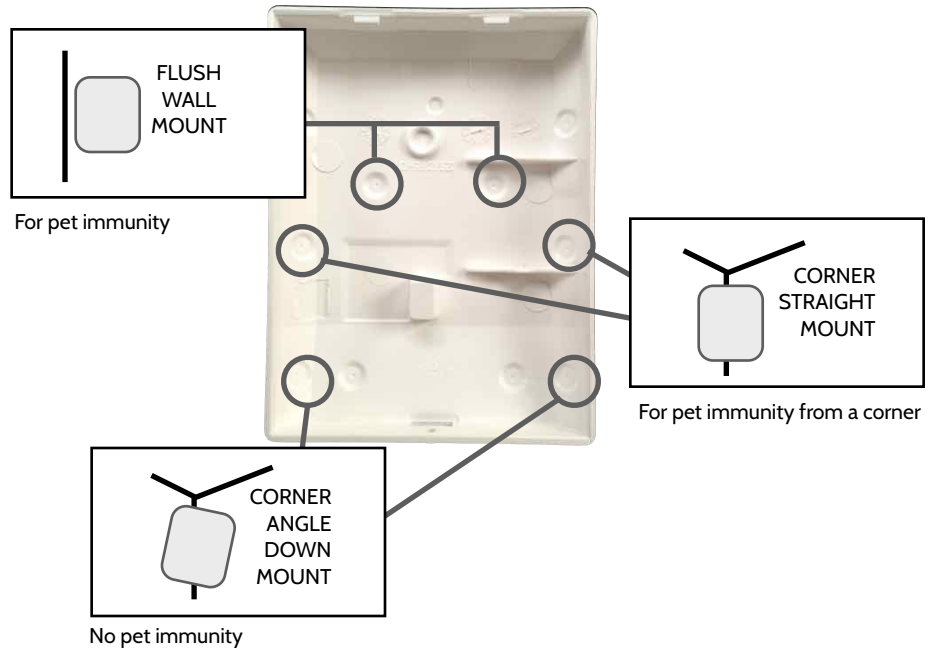

BATTERY ACTIVATION

To activate the batteries in the sensor, remove the cover and pull out the plastic tab between the batteries and the contacts.



MOUNTING INSTRUCTIONS

Remove back cover by pressing bottom button and sliding back cover off in an upward motion.

If a flush mount is required screw in the back cover on the wall using the screw templates as shown.

If corner mount is required use the screw templates as shown.

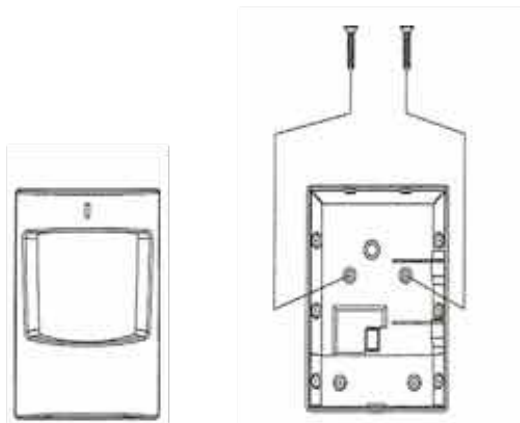

Front Plate

Back Cover

(A) Flush mount

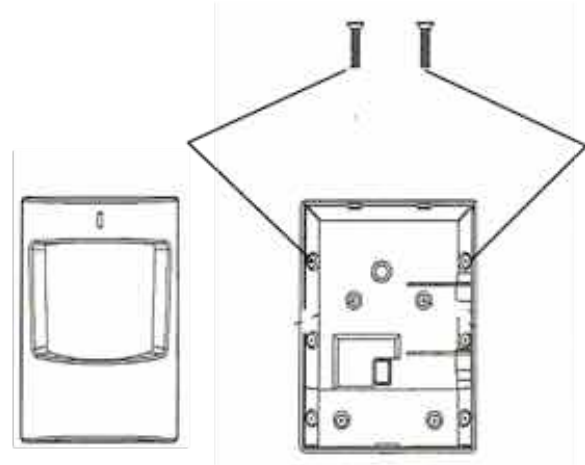

Front Plate

Back Cover

(B) Corner mount

MOUNTING FOR PET SENSITIVITY

Mount the sensor 6.5 to 7 ft (0.9 and 1.5 m) high. For best results, install the sensor higher than the highest point the pet might reach in the detection area.

Use the following formula to calculate the optimal mount height:

mount height = pet's stature + (distance/20).

That means when the farthest sense area to sensor is 33 ft (10 m), and the pet's stature is 2.6 ft (0.8 m), mount 4.25 ft (1.3 m) from the floor. (Do not exceed the highest 5 ft [1.5 m]).

If the detection area contains furniture or other objects on which the pet can climb or jump, either (a) remove these objects, (b) mount the sensor a safe distance above these objects, or (c) mask these areas.

PROGRAMMING THE IQ DOOR/WINDOW

The following steps describe general guidelines for programming (learning) the sensor into the IQ Panel. Refer to the IQ Panel's installation instructions for complete programming details.

1  From the home screen of the IQ panel, touch the "Settings" icon

2  Enter the installer passcode. Default installer passcode is 1111

3  Touch the "Installation" app

4  Touch the "Security Sensors" app

5  Touch the "AutoLearn Sensor" app

4  Tamper the sensor by pressing the tab and lifting off the cover.

6  A chime will sound

7  Touch "Ok"

8  Check the auto-populated fields to ensure accuracy. Change the settings as you see fit.

Be sure to select the proper "Sensor Group"

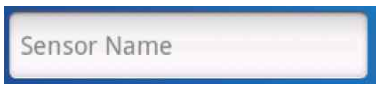
9  Create custom names by selecting "Sensor name" and choosing "Custom description." A box will appear to the right. Selecting that box will open a keyboard, allowing you to type the name of your choice into the field.

10  Touch "Add" to complete the process

BATTERY REPLACEMENT

To replace batteries:

- Push button on side of sensor and lift off cover.
- Remove old batteries and replace with new ones.
- Close cover by snapping the cover back onto the sensor.

BATTERY TYPE

AAA Alkaline (2 per sensor)
 Battery life expectancy: 3 years. (Lifetime may vary depending on number of activations, environmental conditions, etc.)

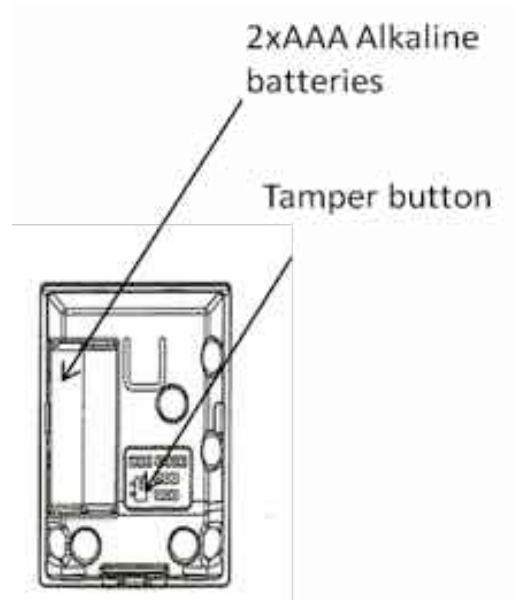

ENVIRONMENTAL CHARACTERISTICS

Operating Temperature: -10C-50C (TBD)
 Relative Humidity: 5-85%
 Storage Temperature: -40-80C

SPECIFICATIONS

Sensor: 3.4H x 2.4W x 1.5D in. (7.7x6.0x4.3 cm)

Number of sensing elements: 2
 Spectral Response: 5um – 14um
 Sensor Responsivity (500K, 1Hz): 3.6mVp-p
 Pet Immune to 50 lbs. Pets must not be allowed to jump up on tables or furniture within the detection area.

SUPPORT



GOT QUESTIONS?
 CONTACT TECH SUPPORT

TechSupport@Qolsys.com

IMPORTANT INFORMATION

15.21

§ 15.21 Information to user.

The users manual or instruction manual for an intentional or unintentional radiator shall caution the user that changes or modifications not expressly approved by the party responsible for compliance could void the user's authority to operate the equipment.

CAUTION: Any changes or modifications not expressly approved by the party responsible for compliance could void the user's authority to operate the equipment.

15.105(b)

§ 15.105 Information to the user.

(b) NOTE: This equipment has been tested and found to comply with the limits for a Class B digital device, pursuant to part 15 of the FCC Rules. These limits are designed to provide reasonable protection against harmful interference in a residential installation. This equipment generates, uses and can radiate radio frequency energy and, if not installed and used in accordance with the instructions, may cause harmful interference to radio communications. However, there is no guarantee that interference will not occur in a particular installation. If this equipment does cause harmful interference to radio or television reception, which can be determined by turning the equipment off and on, the user is encouraged to try to correct the interference by one or more of the following measures:

- Reorient or relocate the receiving antenna.
- Increase the separation between the equipment and receiver.
- Connect the equipment into an outlet on a circuit different from that to which the receiver is connected.
- Consult the dealer or an experienced radio/TV technician for help.

RSS-GEN Section 8.4

8.4 User manuals for licence-exempt radio apparatus shall contain the following text, or an equivalent notice that shall be displayed in a conspicuous location, either in the user manual or on the device, or both:

This device complies with Industry Canada's licence-exempt RSSs. Operation is subject to the following two conditions:

- (1) This device may not cause interference; and*
- (2) This device must accept any interference, including interference that may cause undesired operation of the device.*

Document#: IQM-IM-02-15
Revision#: 2/27/15
Issue Date: FEB 2015
Qolsys Part #: QS-1200-p01
Firmware : OB_20130627



Conforms to ANSI/UL Std. 639
Certified to ULC Sub S306
Qolsys Inc. proprietary.
Reproduction without permission is not permitted.