

Lenovo IdeaPad S10-3 User Guide v1.0

New World. New Thinking.™
www.lenovo.com

©Lenovo China 2009



P/N: 147002750
Printed in China

lenovo

lenovo

ideapad

Notes

- Before using this information and the product it supports, be sure to read Important safety information on page iii and Notices in Appendix E first.
- Some instructions in this guide may assume that you are using Windows® 7. If you are using other Windows operating system, some operations may be slightly different. If you are using other operating systems, some operations may not apply to you, but it won't substantially affect your use of this computer.
- The features described in this guide are common to most models. Some features may not be available on your computer and/or your computer may include features that are not described in this user guide.

lenovo

**If your product is not working correctly,
DO NOT RETURN IT TO THE STORE.**

For technical assistance, contact a Lenovo support specialist 24 hours a day by calling toll free **1-877-4 LENOVO (1-877-453-6686)**.

Additionally, you can find support information and updates on the Lenovo Web site located at **<http://consumersupport.lenovo.com>**.

* Only for the users from the United States.

First Edition (November 2009)

© Copyright Lenovo 2009.

LENOVO products, data, computer software, and services have been developed exclusively at private expense and are sold to governmental entities as commercial items as defined by 48 C.F.R. 2.101 with limited and restricted rights to use, reproduction and disclosure. LIMITED AND RESTRICTED RIGHTS NOTICE: If products, data, computer software, or services are delivered pursuant a General Services Administration "GSA" contract, use, reproduction, or disclosure is subject to restrictions set forth in Contract No. GS-35F-05925.

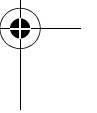
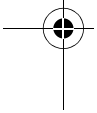

Dear user,

Thank you for purchasing your new Lenovo notebook computer!

Before using this product, make sure to read this user guide carefully.

We are pleased that you have chosen Lenovo for your mobile computing needs. To help you master the usage of your new computer quickly, we have prepared this user guide. In this manual you will find information on the system configuration, basic operating instructions, and important notices. We have done our best to avoid any errors in making sure that the information provided in this manual is accurate and reliable. However, due to the short length of the user guide it is impossible to cover all topics in great depth. For this reason, we apologize for any omissions you might find.

Lenovo is always trying to improve the performance and reliability of its products. For that reason, the hardware and software components shown within the user guide might not perfectly match those of your system.

However, any inconsistencies between what is described in the user guide and the operations of your computer should not substantially affect your use.

Thank you for your cooperation.

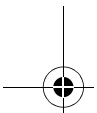
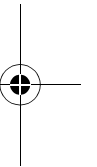
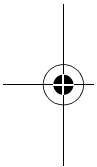

Explanation of hard disk capacity

Dear user,

While using your computer, you may find that the nominal hard disk capacity indicated is somewhat different from the disk capacity displayed by the operating system. For example, a nominal 40GB hard disk will appear as less than 40GB in the operating system. This discrepancy is not an error in hard disk installation nor any other problem, but a normal phenomenon of computers. This phenomenon is primarily due to the following reasons:

I. Different standards used by the manufacturer and operating system when calculating hard disk capacity

Hard disk manufacturers use a radix of 1000, i.e., 1G = 1,000MB, 1MB = 1,000KB, 1KB = 1,000 bytes. However, when identifying hard disk capacity, operating systems use a radix of 1024, i.e., 1GB = 1,024MB, 1MB = 1,024KB, 1KB = 1,024 bytes. The standard adopted by your computer is that of the hard disk manufacturers. Since the standards adopted by the hard disk manufacturer and operating system are different, the hard disk capacity displayed by the operating system will be different from the nominal hard disk capacity.

For example, if the hard disk is nominally X G, even when it is completely empty, the capacity displayed by the operating system will be:

$$X \times 1000 \times 1000 \times 1000 / (1024 \times 1024 \times 1024) = X \times 0.931 \text{ G}$$

In addition, if a portion of the hard disk space has been used for some specific purpose, then the capacity indicated by the operating system will be even less than $X \times 0.931$ G.

II. A portion of the hard disk space is used for specific purposes

Lenovo computers may come with preinstalled OneKey Rescue system, so the hard disk has a special portion partitioned before delivery, which is used to store hard disk mirror and OneKey Rescue system program files. The size of the reserved space for this partition varies according to the model, operating system and software of the computer. For the sake of safety, this partition is not apparent, which is commonly referred to as a "hidden partition".

In addition, after the hard disk is partitioned or formatted, the system will assign a certain amount of hard disk space for the system files.

For the above reasons, the available hard disk space indicated by the operating system is always less than the computer's nominal hard disk capacity.

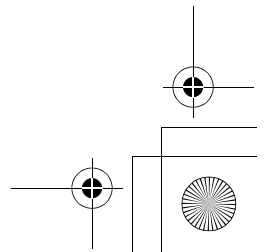
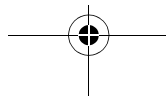
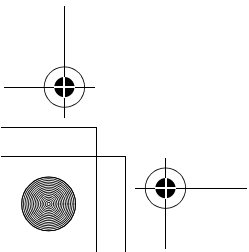
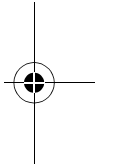
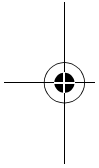
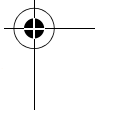
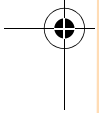
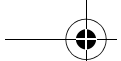

Contents

Important safety information.....	iii
Important safety information	iii
Chapter 1. Getting to know your computer	1
Top view	1
Left-side view	3
Right-side view	4
Bottom view	5
Chapter 2. Learning the basics	7
First use.....	7
Using AC adapter and battery	10
Using the touchpad.....	13
Using the keyboard.....	14
Special buttons.....	17
System status indicators.....	19
Securing your computer.....	20
Connecting external devices.....	22
Using Lenovo Quick Start (select models only)	25
Chapter 3. Using the Internet	27
Wired connection	27
Wireless connection	29
Chapter 4. OneKey Rescue system	34
OneKey Rescue system	34
Chapter 5. Troubleshooting	37
Frequently asked questions	37
Troubleshooting	40
Chapter 6. Upgrading and replacing devices	48
Replacing the battery	48
Replacing the hard disk drive ..	50
Replacing memory	54
Appendix A. Getting help and service	58
Getting help on the Web	59
Calling the customer support center	59
Getting help around the world	62
Lenovo warranty service telephone numbers.....	62
Appendix B. Use, and care Information	63
Caring your computer	63
Accessibility and comfort.....	69
Maintenance.....	71

Contents

Appendix C. Lenovo limited warranty	76	Appendix F. Features and specifications	114
Warranty information	86	Trademarks.....	116
Appendix D. Customer replaceable units (CRUs).....	90	Index.....	117
Appendix E. Notices.....	92		
Notices.....	92		
ENERGY STAR model information	95		
Wireless related information....	97		
Electronic emissions notices...	101		
WEEE and recycling statements	108		
Turkish statement of compliance	108		
EU WEEE statements	109		
Japan recycling statements	110		
Notice for users in the U.S.A.....	112		
Notice on deleting data from your hard disk	112		

Important safety information

■ Important safety information

This information can help you safely use your notebook personal computer. Follow and retain all information included with your computer. The information in this document does not alter the terms of your purchase agreement or the Lenovo Limited Warranty. For more information, see "Appendix C. Lenovo limited warranty" on page 76.

■ Read this first

Personal computers are electronic devices. Power cords, power adapters, and other features can create potential safety risks that can result in physical injury or property damage, especially if misused. The safety risks are categorized as follows:

*** Danger:**

Physical injury or even death may be caused.

⦿ Attention:

Property damage or even minor injury may be caused.

To protect yourself from hazards and create a safer computer work environment, follow the instructions hereafter.

Important safety information

Unpack



Inspect the covers of the computer and the AC adapter, especially parts with the following labels attached for any crack or damage.



*** Danger:**

- Hazardous voltage, current, and energy levels are present inside any component that has this label attached.

Important safety information

Working place



Do NOT use the computer in humid places such as a bathroom.
Keep the computer and other parts away from liquids.

*** Danger:**

- An electric shock may be caused by spilled liquid.



Do NOT use the computer during a lightning storm.

o Attention:

- Lightning storms may damage the computer and result in an electric shock.



Ensure your computer and other components maintain good ventilation.

*** Danger:**

- Placing the working computer or other parts on a bed, sofa or other flexible surface may block the ventilation slots causing overheating of your computer or other parts and increases the risk of fire.



Turn off wireless devices where they may cause interference, such as in a hospital or at an airport.

Important safety information

Correct usage procedures



Use **ONLY** the power cord, power adapter and battery pack shipped with the computer. Never use these devices with another product.

Be sure the power outlet is suitable for the plug and provides the correct voltage and current for the product you are using.

*** Danger:**

- An unsuitable power supply may damage your computer and can cause an electric shock or fire.



Do **NOT** use a power outlet, power cord, power adapter or battery pack that appears to be damaged or corroded.



Do **NOT** share an electrical outlet with other home or commercial appliances that draw large amounts of electricity.

If power strips are used, the load should **NOT** exceed the power strip's input rating. Unplug the power cord if there are any cracking, hissing, or popping sounds, or if a strong odor comes from the computer.

*** Danger:**

- Overloading the power supply may cause unstable voltages which might damage the computer, data, attached devices, or even cause a fire.

Important safety information



Do NOT wrap the power cord around the power adapter or other objects.

Do NOT squeeze or pinch the cord, or place heavy objects on it.

● **Attention:**

- Stressing the cord may cause the cord to fray, crack or crimp which may present a safety hazard.



Avoid keeping your hands, your lap, or any other part of your body in contact with a hot section of the working computer for any extended length of time.

● **Attention:**

- Extended contact with your body, even through clothing, could cause discomfort or even a skin burn.



Do not drop, bump, scratch, hit or place heavy objects on the liquid crystal display (LCD) of your computer.

● **Attention:**

- Direct contact with liquid crystal material from a broken LCD is hazardous; if contact occurs, rinse with large amount of running water for more than 15 minutes.

Important safety information

Service and upgrades



Do NOT attempt to service a product yourself unless instructed to do so by the customer support center or your documentation.

○ **Attention:**

- DO NOT take risks or attempt to diagnose the situation yourself. Contact the customer support center for further guidance. For a list of service and support phone numbers, go to <http://consumersupport.lenovo.com>.

Lenovo provides documentation with instructions when it is appropriate for customers to install options or replace units (CRUs). Closely follow all instructions when installing or replacing parts.

Disconnect the attached power cords, battery pack, and all the cables before you open the device covers, unless instructed otherwise in the installation and configuration procedures.

Keep the covers closed whenever the computer is plugged in.

Chapter 1. Getting to know your computer

■ ■ Top view

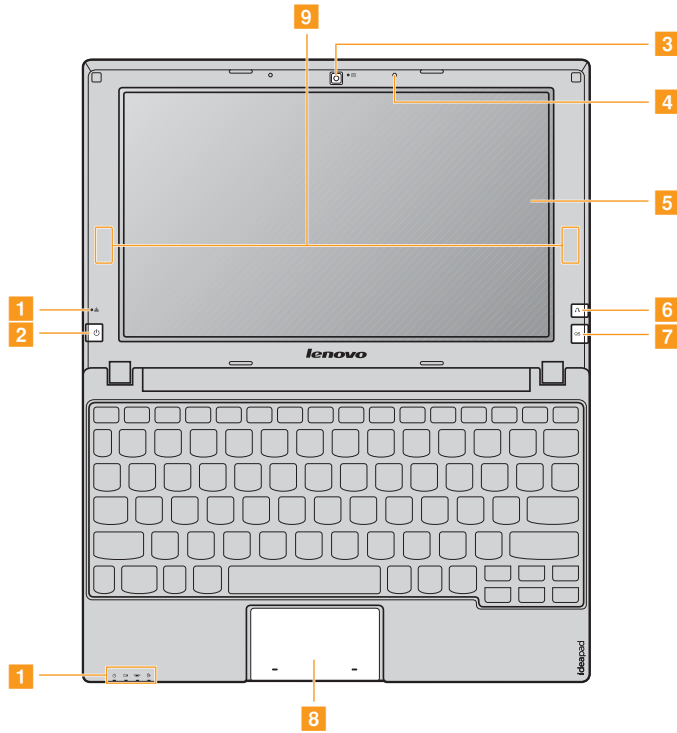

Note: The illustrations in this manual may differ from the actual product. Please refer to the actual product.

Chapter 1. Getting to know your computer

ⓘ Attention:

- Do NOT open the display panel beyond 130 degrees. When closing the display panel, be careful NOT to leave pens or any other objects in between the display panel and the keyboard. Otherwise, the display panel may be damaged.

- 1 System status indicators** For details, see "System status indicators" on page 19.
- 2 Power button** Press this button to turn on the computer.
- 3 Integrated camera** Use the camera for video communication.
- 4 Built-in microphone** The built-in microphone (with noise reduction) can be used for video conferencing, voice narration, or simple audio recordings.
- 5 Computer display** The LCD display with LED backlight provides brilliant visual output.
- 6 OneKey Rescue system button** Press this button to open OneKey Rescue system (If OneKey Rescue system has been preinstalled) when the computer is powered off.
Note: For details, see "Chapter 4. OneKey Rescue system" on page 34.
- 7 Quick Start button** When the computer is powered-off, press this button to enter the Lenovo Quick Start if it has been installed.
- 8 One-piece touchpad** The touchpad functions as a conventional mouse with built-in left-click and right-click buttons.
Note: For details, see "Using the touchpad" on page 13.
- 9 Wireless module antennas (select models only)** The built-in antennas ensure optimal reception of wireless communication radio.

Chapter 1. Getting to know your computer

■ ■ Left-side view

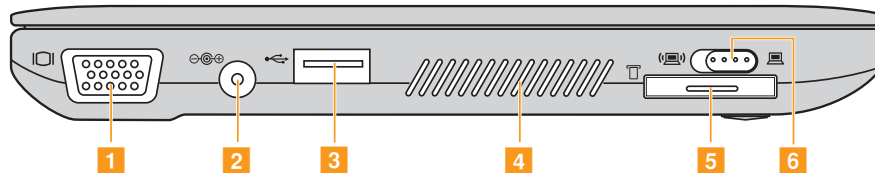

- 1 VGA port** Connects to external display devices.
- 2 AC power adapter jack** Connect the AC adapter here.
Note: For details, see "Using AC adapter and battery" on page 10.
- 3 USB port** Connects to USB devices.
Note: For details, see "Connecting a universal serial bus (USB) device" on page 24.
- 4 Fan louvers** Dissipate internal heat.
Note: Make sure that none of the fan louvers are blocked or else overheating of the computer may occur.
- 5 Memory card slot** Insert memory cards (not supplied) here.
Note: For details, see "Using memory cards (not supplied)" on page 22.
- 6 Integrated wireless device switch** Use this switch to turn on/off the wireless radio of all wireless devices on your computer.

Chapter 1. Getting to know your computer

■ ■ Right-side view

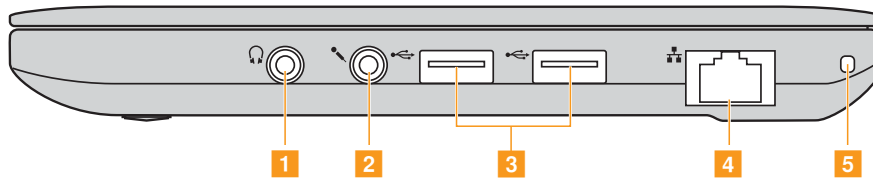

1 Headphone jack Connects to external headphones.

○ **Attention:**

- Listening to music at high volume over extended periods of time may damage your hearing.

2 Microphone jack Connects to external microphones.

3 USB port Connects to USB devices.

Note: For details, see “Connecting a universal serial bus (USB) device” on page 24.

4 RJ-45 port Connects to an Ethernet network.

Note: For details, see “Wired connection” on page 27.

5 Kensington slot Attach a security lock (not supplied) here.

Note: For details, see “Attaching a security lock (not supplied)” on page 20.

Chapter 1. Getting to know your computer

Bottom view

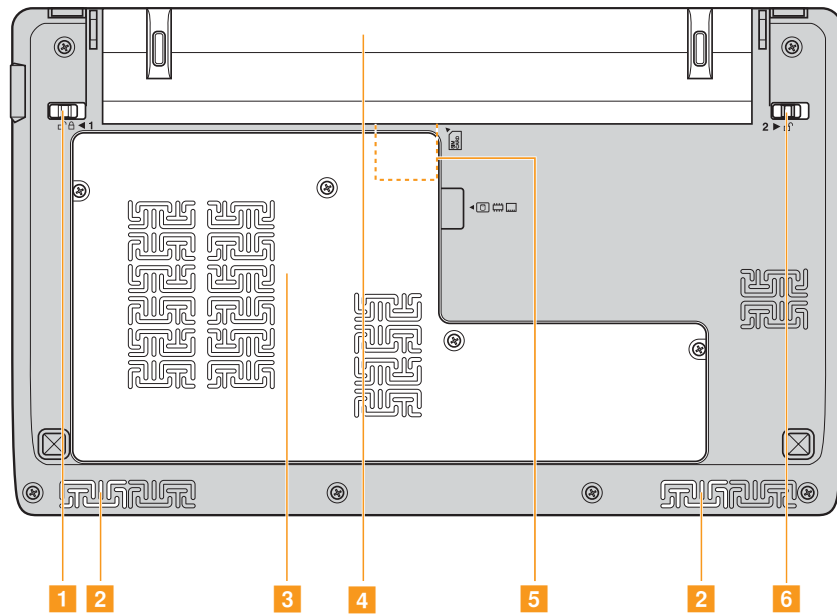

5

Chapter 1. Getting to know your computer

- 1 Battery latch - manual** The manual battery latch is used to keep the battery pack secured in place.
- 2 Speakers** The stereo speakers provide rich and powerful sound.
- 3 Hard disk/ Memory/Mini PCI ExpressCard slot compartment**
- 4 Battery pack** For details, see "Using AC adapter and battery" on page 10.
- 5 SIM card slot (select models only)** Insert a SIM card (not supplied) for using Mobile Broadband.
Notes:
 - After removing the battery pack, you can insert a SIM card into this slot.
 - For details, see "Using Mobile Broadband (select models only)" on page 31
- 6 Battery latch - spring loaded** The spring-loaded battery latch keeps the battery pack secured in place.

Chapter 2. Learning the basics

■ ■ First use

■ Read the manuals

Read the supplied manuals before using your computer.

■ Connect to the power

The supplied battery pack is not fully charged at purchase. To charge the battery and begin using your computer, insert the battery pack and connect the computer to an electrical outlet. The battery is automatically charged while the computer is running on AC power.

Install the battery pack

Refer to the supplied *Setup Poster* to install the battery pack.

Connect the computer to an electrical outlet

- 1 Connect the power cord to the AC adapter.
- 2 Connect the AC adapter to the AC power adapter jack of the computer.
- 3 Plug the power cord into an electrical outlet.

Chapter 2. Learning the basics

■ Turn on the computer

Press the power button to turn on the computer.

■ Configure the operating system

You may need to configure the operation system when it is first used. The configuration process may include the procedures below.

- Accepting the end user license agreement
- Configuring the Internet connection
- Registering the operating system
- Creating a user account

■ Putting your computer into sleep state or shutting it down

When you finish working with your computer, you can put it into sleep state or shut it down.

Putting your computer into sleep state

If you will be away from your computer for only a short time, put the computer into sleep state.

When the computer is in sleep state, you can quickly wake it to resume use, and bypass the startup process.

Chapter 2. Learning the basics

To put the computer into sleep state, do one of the following.

- Click  and select **Sleep** from the **Start** menu.
- Press **Fn + F1**.

Note: Wait until the power indicator light starts blinking (indicating that the computer is in sleep state) before you move your computer. Moving your computer while the hard disk is spinning can damage the hard disk, causing loss of data.

To wake the computer, do one of the following.

- Press the power button.
- Press any key on the keyboard.

■ Shutting down your computer

If you are not going to use your computer for a day or two, shut it down.

To shut down your computer, click  and select **Shut down** from the **Start** menu.

Chapter 2. Learning the basics

■ ■ Using AC adapter and battery

■ Checking battery status

You can determine the percentage of battery power remaining by checking the battery icon in the notification area.

Note: As each computer user has different habits and needs, it is difficult to predict how long a battery charge will last. There are two main factors:

- The amount of energy stored in the battery when you commence work.
- The way you use your computer: for example, how often you access the hard disk drive and how bright you make the computer display.

■ Charging the battery

When you find that the battery power is low, you need to charge the battery or replace it with a fully charged one.

You need to charge the battery in any of the following situations:

- When you purchase a new battery
- If the battery status indicator starts blinking
- If the battery has not been used for a long time

Chapter 2. Learning the basics

Notes:

- You are advised to insert the battery pack when using your computer to prevent small particles from entering the inside of your computer.
- To increase the life of the battery pack, the computer does not start recharging the battery immediately after it drops from fully charged.
- Charge the battery at a temperature between 50 °F and 80 °F (10 °C-30 °C).
- Full charge or discharge is not required.

■ Removing the battery pack

If you are not going to use the computer for an extended period of time, or if you need to send your computer to Lenovo for service, etc., remove the battery pack from the computer. Before removing the battery pack, make sure the computer has been shut down.

Chapter 2. Learning the basics

■ Handling the battery

If the rechargeable battery pack is replaced with an incorrect type, there may be danger of an explosion. The battery pack contains a small amount of harmful substances. To avoid possible injury and detriment to the environment, pay attention to the following points:

- Replace only with a battery of the type recommended by Lenovo.
- Keep the battery pack away from fire.
- Do not expose the battery pack to water or rain.
- Do not attempt to disassemble the battery pack.
- Do not short-circuit the battery pack.
- Keep the battery pack away from children.
- Do not put the battery pack in trash that is disposed of in landfills. When disposing of the battery, comply with local ordinances or regulations and your company's safety standards.

Chapter 2. Learning the basics

■ ■ Using the touchpad

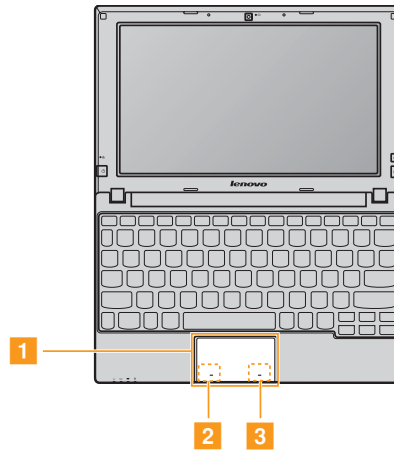

- 1 One-piece touchpad** To move the cursor on the screen, slide your fingertip over the pad in the direction in which you want the cursor to move.
- 2 Bottom left area** The function corresponds to that of the left mouse button on a conventional mouse, which can be implemented by clicking this area.
- 3 Bottom right area** The function corresponds to that of the right mouse button on a conventional mouse, which can be implemented by clicking this area.

Note: You can enable/disable the touchpad using **Fn+F6**.

Chapter 2. Learning the basics

■ ■ Using the keyboard

Your computer has a numeric keypad and function keys incorporated in its standard keyboard.

■ Numeric keypad

The keyboard has keys that, when enabled, work as a 10-key numeric keypad.

To enable or disable the numeric keypad, press **Fn+Insert**.

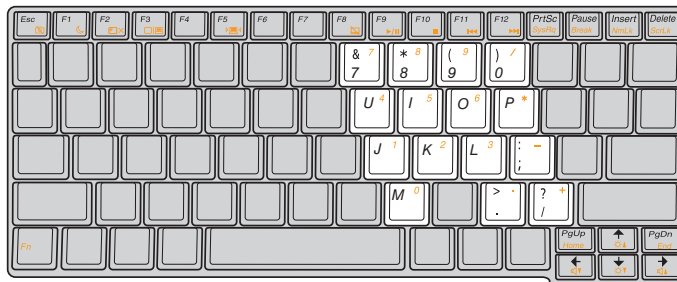

Note: The  indicator will light on if the numeric keypad is enabled.

Chapter 2. Learning the basics

■ Function key combinations

Through the use of the function keys, you can change operational features instantly. To use this function, press and hold **Fn** **1**; then press one of the function keys **2**.

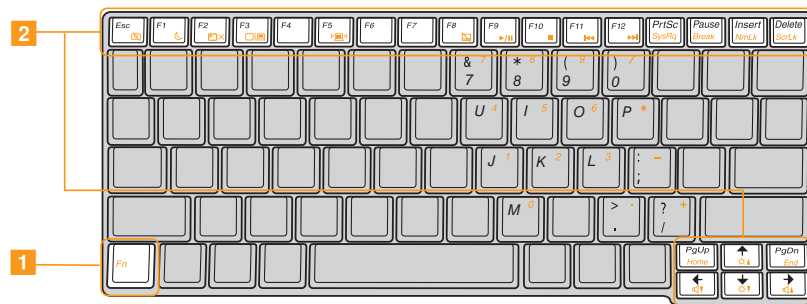

Chapter 2. Learning the basics

The following describes the features of each function key.

Fn + Esc:	Turn on/off the integrated camera.
Fn + F1:	Enter sleep mode.
Fn + F2:	Turn on/off the LCD screen.
Fn + F3:	Open the interface for the display device switch to select notebook or external display.
Fn + F4:	Open the interface for display resolution settings.
Fn + F5:	Open the interface for integrated wireless devices settings (enable/disable).
Fn + F6:	Enable/Disable the touchpad.
Fn + F7:	Start/Pause playback of Windows Media Player.
Fn + F8:	Stop playback of Windows Media Player.
Fn + F9:	Skip to the previous track.
Fn + F10:	Skip to the next track.
Fn + F11:	Activate the F12 function. * You can press Fn+F11 during computer startup to open the boot selection menu.
Fn + PrtSc:	Activate the system request.
Fn + Pause:	Activate the break function.
Fn + Insert:	Enable/Disable the numeric keypad.
Fn + Delete:	Enable/Disable the Scroll Lock.
Fn + ↑ / ↓ :	Increase/Decrease display brightness.
Fn + → / ← :	Increase/Decrease volume level.

Chapter 2. Learning the basics

Special buttons

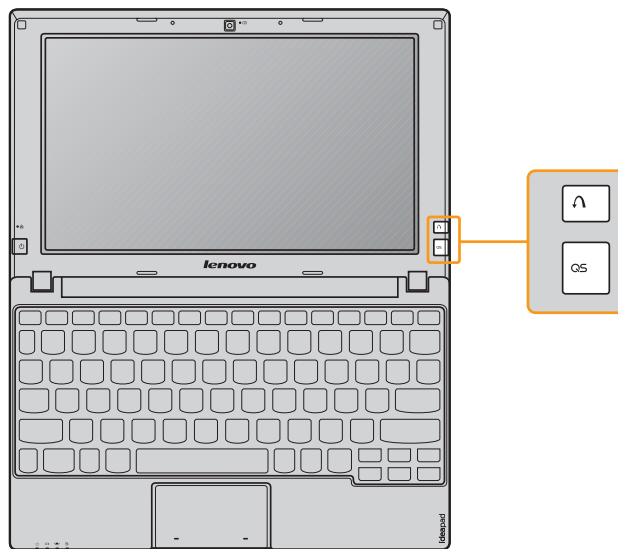

Chapter 2. Learning the basics

OneKey Rescue system button

- When the computer is powered off, press this button to enter the OneKey Rescue system if Lenovo OneKey Rescue system has been preinstalled.
- Under Windows operating systems, press this button to start Lenovo OneKey Recovery.

Note: For details, see “OneKey Rescue system” on page 34.

Quick Start button

- When the computer is powered-off, press this button to enter Lenovo Quick Start if it has been installed.

Note: For details, see “Using Lenovo Quick Start (select models only)” on page 25.

- Under Windows operating systems, press this button to launch a self-defined program, file or a Website.

Note: To re-define the Quick Start button, select **Self-defined program setting** (start ↓ All Programs ↓ Lenovo ↓ Energy Management ↓ Self-defined program setting).

Chapter 2. Learning the basics

System status indicators

These indicators inform you of the computer status.

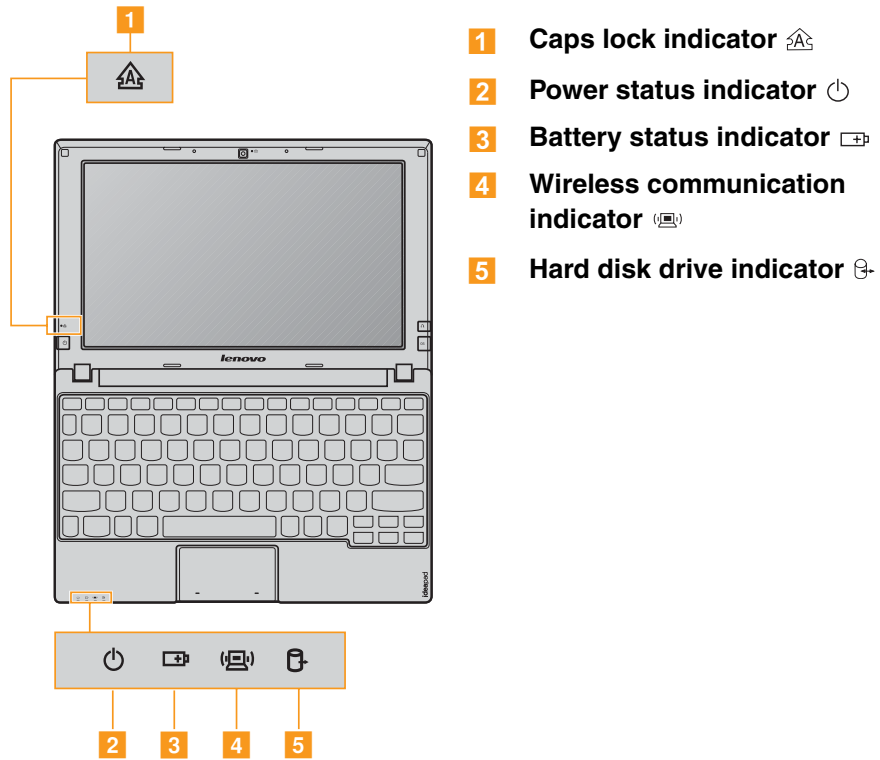

Chapter 2. Learning the basics

■ ■ Securing your computer

This section provides information about how to help protect your computer from theft and unauthorized use.

■ Attaching a security lock (not supplied)

You can attach a security lock to your computer to help prevent it from being removed without your permission. For details on installing the security lock, please refer to the instructions shipped with the security lock that you have purchased.

Refer to the “Right-side view” on page 4 for the location of the Kensington slot.

Notes:

- Before purchasing any security product, verify that it is compatible with this type of security keyhole.
- You are responsible for evaluating, selecting, and implementing the locking devices and security features. Lenovo offers no comment, judgement, or warranty regarding the function, quality or performance of locking devices and security features.

Chapter 2. Learning the basics

■ Using VeriFace™

VeriFace is a face recognition software which takes a digital snapshot, extracts key features of your face, and creates a digital map that becomes the system's "password".

If you want to activate VeriFace for the first time, click the VeriFace icon on the desktop to register your facial image.

Notes:

- The face registration and verification works best in an environment with steady and even light.
- You can determine whether to use this function when you log on the system.

For more instructions on VeriFace, see the help file on your software.

■ Using passwords

Using passwords helps prevent your computer from being used by others. Once you set a password and enable it, a prompt appears on the screen each time you power on the computer. Enter your password at the prompt. The computer cannot be used unless you enter the correct password.

Note: This password can be from one to seven alphanumeric characters in any combination.

For details about how to set the password, see the help to the right of the screen in **BIOS Setup Utility**.

Note: To enter **BIOS Setup Utility**, press **F2** when the Lenovo logo appears on the screen while the computer is starting up.

Chapter 2. Learning the basics

■ Connecting external devices

Your computer has a wide range of built-in features and connection capabilities.

■ Using memory cards (not supplied)

Your computer supports the following types of memory cards:

- Secure Digital (SD) card
- High Capacity Secure Digital (SDHC) card
- MultiMediaCard (MMC)
- Memory Stick (MS)
- Memory Stick PRO (MS PRO)

Notes:

- Insert ONLY one card in the slot at a time.
- This card reader does not support SDIO devices (e.g., SDIO Bluetooth, etc.).

Chapter 2. Learning the basics

■ Inserting a memory card

- ➊ Push the dummy card until you hear a click. Gently pull the dummy card out of the memory card slot.

Note: The dummy card is used for preventing dust and small particles from entering the inside of your computer when the memory card slot is not in use. Retain the dummy card for future use.

- ➋ Slide the memory card in until it clicks into place.

■ Removing a memory card

- ➊ Push the memory card until you hear a click.
- ➋ Gently pull the memory card out of the memory card slot.

Note: Before removing the memory card, disable it via Windows safely remove hardware and eject media utility to avoid data corruption.

Chapter 2. Learning the basics

■ Connecting a universal serial bus (USB) device

Your computer comes with three USB ports compatible with USB devices.

Note: When using a high power consumption USB device such as USB ODD, use the external device's power adapter. Otherwise, the device may not be recognized, and system shut down may result.

■ Connecting a *Bluetooth* enabled device (select models only)

If your computer has an integrated *Bluetooth* adapter card, it can connect to and transfer data wirelessly to other *Bluetooth* enabled devices, such as notebook computers, PDAs and cell phones. You can transfer data between these devices without cables at up to 10 meters range in open space.

Note: The actual maximum range may vary due to interference and transmission barriers. To get the best possible connection speed, place the device as near your computer as possible.

Enabling *Bluetooth* communications on your computer

- 1 Slide the integrated wireless device switch to .
- 2 Press **Fn + F5** to make configuration.

Notes:

- When you do not need to use the *Bluetooth* function, turn it off to save battery power.
- You need to pair the *Bluetooth* enabled device with your computer before you can transfer data between them. Read the documentation supplied with the *Bluetooth* enabled device for details on how to pair the device with your computer.

Chapter 2. Learning the basics

■ ■ Using Lenovo Quick Start (select models only)

With a boot time of just a few seconds, Lenovo Quick Start offers a handy environment that allows you to enjoy an instant access to functions such as Web browsing, instant messaging and other entertainment functions without entering the traditional operating system.

Notes:

- If Lenovo Quick Start is not installed, a prompt notice will appear on the screen when you start it.
- The Web browser of Lenovo Quick Start is designed for you to get an instant access to online information and does not fully support video streaming. You may experience low frame rate when watching online video in Lenovo Quick Start. To view online video, restart the computer to your Windows operating system and use Internet Explorer to play the online video.



Chapter 2. Learning the basics

■ Starting Lenovo Quick Start

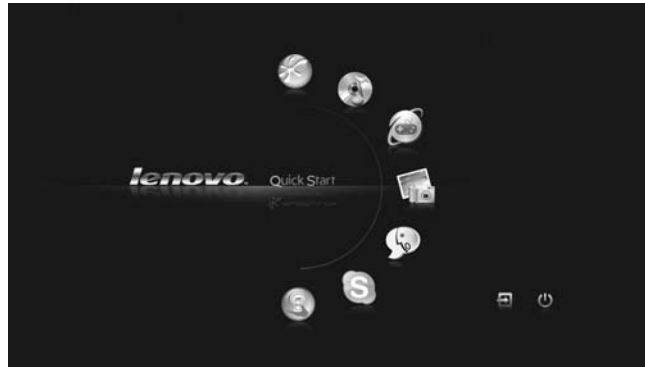
Press the **QS** button when the computer is powered-off. The following will appear on the screen after a few seconds.



■ Exiting Lenovo Quick Start

- Click  to restart the computer.
- Click  to turn off the computer.

Chapter 3. Using the Internet

As a global network, the Internet connects computers worldwide, providing services such as e-mailing, information searching, electronic commerce, Web browsing and entertainment.

You can connect the computer to the Internet in the following ways:

Wired connection: uses physical wiring to connect.

Wireless network technology: connect without wiring.

■ Wired connection

Wired connections are a reliable and safe way to connect the computer to the Internet. Generally, the following two accessing methods are widely used.

Cable	Cable Internet services use a cable modem connected to the residential cable TV line.
DSL	DSL is a family of related technologies that bring high-speed network access to homes and small businesses over ordinary telephone lines.

Chapter 3. Using the Internet

■ Hardware connection:

Cable

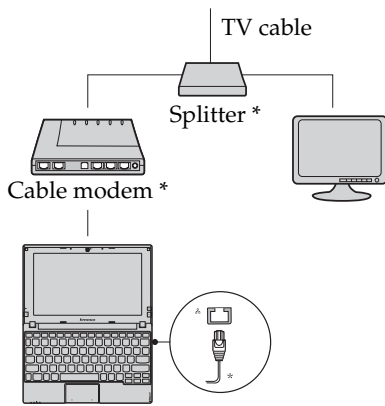

DSL

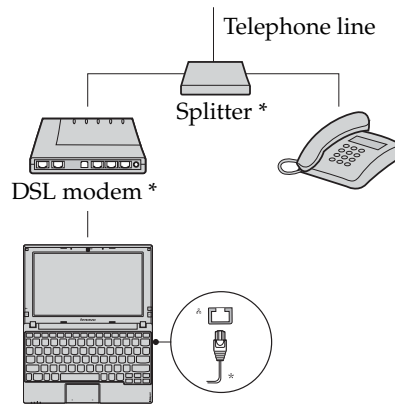

* Not supplied.

Note: The above diagrams are for reference only. Actual connection method may vary.

■ Software configuration

Consult your Internet Service Provider (ISP) for details on how to configure your computer.

Chapter 3. Using the Internet

■ ■ Wireless connection

Wireless connections provide mobile access to the Internet, allowing you to stay online anywhere the wireless signal covers.

Divided by the signal scales, wireless connection to the Internet can be built based on the following standards.

Wi-Fi	Wi-Fi networks cover a small physical area, like a home, office, or small group of buildings. An access point is necessary for the connection.
WiMAX	WiMAX networks connect several Wireless LAN systems to cover a metropolitan area, providing high-speed broadband access without the need for cables.
Mobile Broadband	The Mobile Broadband network provides Internet access to computers, cell phones and other devices over a large geographic area. Mobile networks are used for data transmission, and access is usually provided by a mobile network operator. A Mobile Broadband SIM card is necessary for the connection.

Note: Your computer may not support all wireless connection methods.

Chapter 3. Using the Internet

■ Using Wi-Fi/WiMax (select models only)

Enabling wireless connection

To enable wireless communications, do the following:

- 1 Slide the integrated wireless device switch to .
- 2 Press **Fn + F5** to make configuration.

Hardware connection

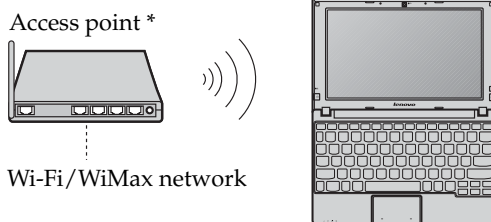

* Not supplied

Software configuration

Consult your Internet Service Provider (ISP) and search Windows Help and Support Center for details on how to configure your computer.

Chapter 3. Using the Internet

■ Using Mobile Broadband (select models only)

Before getting started with Mobile Broadband, you first need to choose a mobile network operator and make sure you are in the coverage area of the network. After that, you also need:

- To activate the Mobile Broadband service through your local mobile network operator. You will get a Subscriber Identity Module (SIM) card after activation. For instructions on inserting the SIM card, refer to “Inserting the SIM card” on page 32.

Notes:

- Various standards are in use by mobile operators to provide Mobile Broadband services. The Lenovo Mobile Broadband module may support one or more of the following standards:
 - GSM (Global System for Mobile Communications)
 - TD-SCDMA (Time Division-Synchronous Code Division Multiple Access)
 - SCDMA (Synchronous Code Division Multiple Access)
 - EV-DO (Evolution Data Optimized)
 - HSPA (High Speed Packet Access)
- Mobile Broadband is a subscription service. Refer to your local mobile network operator for availability, cost and other information.
- A SIM card is a type of smart card used by mobile network operators to identify their service subscribers on the mobile network. You will get the SIM card from your mobile network operator after you have activated the Mobile Broadband service.

Chapter 3. Using the Internet

- A connection management utility to connect/disconnect to your Mobile Broadband network.

Note: In general, your mobile service provider provides this utility.

Inserting the SIM card

To insert the SIM card:

- 1 Turn off the computer; then disconnect the AC adapter and all cables from the computer.
- 2 Close the computer display and turn it over.
- 3 Remove the battery.
- 4 Insert the SIM card to the card slot until it clicks into place as shown in the illustration.

Note: Inserting the SIM card in the wrong direction may damage the SIM card slot.

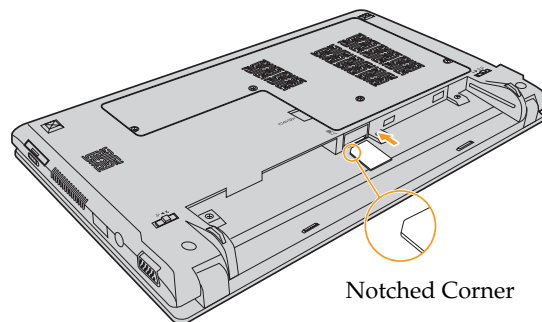

Chapter 3. Using the Internet

- 5 Put the battery back in place. Turn the computer over and reconnect the cables.

Removing the SIM card

To remove the SIM card:

- 1 Turn off the computer, then disconnect the AC adapter and all cables from the computer.
- 2 Close the computer display and turn it over.
- 3 Remove the battery.
- 4 Push the SIM card in until you hear a click, and then pull the SIM card out.

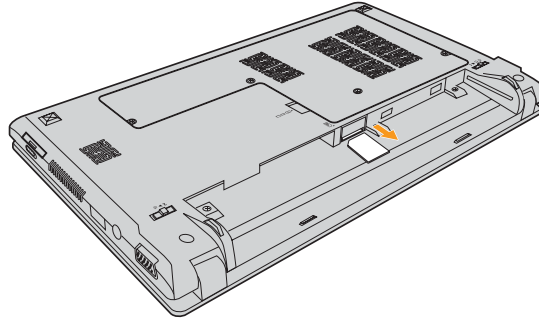

- 5 Put the battery back in place. Turn the computer over and reconnect the cables.

Note: Never insert or remove the SIM card while the computer is on. Doing so may cause permanent damage to the SIM card as well as the SIM card reader.

Chapter 4. OneKey Rescue system

■ OneKey Rescue system

■ Introduction

The Lenovo OneKey Rescue system is an easy-to-use application that can be used to back up the data on your system partition (C drive) for easy restore when required. You can run Lenovo OneKey Recovery under the Windows operating system, and the OneKey Rescue system without starting the Windows operating system.

○ Attention:

In order to utilize the features of the OneKey Rescue system, your hard disk already includes a hidden partition by default to store the system image file and OneKey Rescue system program files. This default partition is hidden for security reasons and is the reason the available disk space is less than it claims. The exact available hard disk space depends on the file size of the mirror image file (based on the size of operating system and pre-installed software).

Chapter 4. OneKey Rescue system

■ Using Lenovo OneKey Recovery (Within Windows operating system)

In Windows operating system, double click the OneKey Recovery system Icon on the desktop to launch Lenovo OneKey Recovery.

Within the program, you can back up the system partition on the hard disk drive, other storage devices, or by creating recovery discs.

Notes:

- The backup process and creation of recovery discs may take some time, connect the AC adapter and battery pack to your computer.
- After the recovery discs are burned, please number them so that you can use them in the correct order.
- Computers without an integrated optical drive support the creation of recovery discs; however an appropriate external optical drive is needed to physically create the recovery discs.

For more instructions, see the help file of Lenovo OneKey Recovery.

Chapter 4. OneKey Rescue system

■ Using Lenovo OneKey Rescue system (Without Windows operating system)

In the event that the operating system cannot be loaded, follow the steps below to access OneKey Rescue system.

- Shut down your computer.
- Press the  key to launch OneKey Rescue system.

Within the program, you can choose to restore your system partition to the original factory status, or to a previously generated backup.

Note: The recovery process is irreversible. Make sure to back up any critical data before using the recovery feature.

Chapter 5. Troubleshooting

■ Frequently asked questions

This section lists frequently asked questions and tell where you can find detailed answers. For details about each publication included in the package with your computer, see *Lenovo IdeaPad S10-3 Setup Poster*.

What safety precautions should I follow when using my computer?

See "Important safety information" on page iii of this guide.

How can I prevent problems with my computer?

See "Appendix B. Use, and care Information" on page 63 of this guide.
More tips can be found in Chapter 1 and 2.

What are the main hardware features of my new computer?

More information can be found in Chapter 1 and 2.

Where can I find the detailed specifications for my computer?

See <http://consumersupport.lenovo.com>.

I need to upgrade a device *or* I need to replace one of the following: the hard disk drive, memory, or the keyboard.

See "Appendix D. Customer replaceable units (CRUs)" on page 90 of this guide.

Chapter 5. Troubleshooting

Where are the recovery discs?

Your computer did not come with a recovery disc. For an explanation of the alternative recovery methods offered by Lenovo, see “Chapter 4. OneKey Rescue system” on page 34.

How can I contact the customer support center?

See “Appendix A. Getting help and service” on page 58 of this guide.

Where can I find warranty information?

For the warranty applicable to your computer, including the warranty period and type of warranty service, see “Appendix C. Lenovo limited warranty” on page 76.

How can I install the device drivers?

A compatible device driver is a requirement to ensure correct operation and performance of each component in your computer. If your computer is pre-installed with an operating system, Lenovo provides all the driver you need in your hard disk.

What can I do if the backup process fails?

If you can start the backup feature without a problem, but it fails during the backup process, please try the following steps:

- 1 Close other applications, then restart the backup process.
- 2 Check if the destination media is damaged, try to select another path and then try again.

Chapter 5. Troubleshooting

When do I need to restore the system to the factory status?

You can use this feature when your system fails or you need to re-install your operating system. This will restore your computer back to the initial status when you first booted up your computer after receiving it from the store. If there is critical data on your current partition, back it up before you run this recovery feature.

Chapter 5. Troubleshooting

■ ■ Troubleshooting

If you do not find your problem here, see Chapter 2. The following section only describes problems that might negate the need to refer to the more comprehensive information in Chapter 2.

Display problems

When I turn on the computer, nothing appears on the screen.

- If the screen is blank, make sure that:
 - The battery is installed correctly.
 - The AC adapter is connected to the computer and the power cord is plugged into a working electrical outlet.
 - The computer power is on. (Press the power button again for confirmation.)
 - The memory is installed correctly.
- If these items are properly set, and the screen remains blank, have the computer serviced.

When I turn on the computer, only a white cursor appears on a blank screen.

- Restore backed-up files to your Windows environment or the entire contents of your hard disk to the original factory contents using OneKey Recovery. If you still see only the cursor on the screen, have the computer serviced.

Chapter 5. Troubleshooting

My screen goes blank while the computer is on.

- Your screen saver or power management may be enabled. Do one of the following to exit from the screen saver or to resume from sleep or hibernation mode:
 - Touch the touchpad.
 - Press any key on the keyboard.
 - Press the power button.
 - Press **Fn+F2** to confirm whether the LCD screen has been turned off.

A Password problem

I forgot my password.

- If you forget your user password, you must take your computer to a Lenovo authorized servicer or a marketing representative to have the password changed.
- If you forget your HDD password, a Lenovo authorized servicer cannot reset your password or recover data from the hard disk. You must take your computer to a Lenovo authorized servicer or a marketing representative to have the hard disk drive replaced. Proof of purchase is required, and a fee will be charged for parts and service.
- If you forget your supervisor password, a Lenovo authorized servicer cannot reset your password. You must take your computer to a Lenovo authorized servicer or a marketing representative to have the system board replaced. Proof of purchase is required, and a fee will be charged for parts and service.

Chapter 5. Troubleshooting

Keyboard problems

A number appears when you enter a letter.

- The numeric lock function is on. To disable it, press **Fn + Insert**.

Sleep or hibernation problems

The computer enters sleep mode unexpectedly.

- If the processor overheats, the computer automatically enters sleep mode to allow the computer to cool and to protect the processor and other internal components. Check the settings for sleep mode.

The computer enters sleep mode immediately after Power-on self-test (POST).

- Make sure that:
 - The battery is charged.
 - The operating temperature is within the acceptable range. See "Appendix B. Use, and care Information" on page 63.

Note: If the battery is charged and the temperature is within range, have the computer serviced.

The critical low-battery error message appears, and the computer immediately turns off.

- The battery power is getting low. Connect the AC adapter to the computer, or replace the battery with a fully charged one.

Chapter 5. Troubleshooting

The computer does not return from sleep mode and does not work.

- If the computer does not return from sleep mode, it may have entered hibernation mode automatically because the battery is depleted. Check the power indicator.
- If your computer is in sleep mode connect the AC adapter to the computer, then press any key or the power button.
- If your computer is in hibernation mode or power-off state. Connect the AC adapter to the computer, then press the power button to resume operation.

Note: If the system still does not return from sleep mode, your system has stopped responding, and you cannot turn off the computer, reset the computer. However, unsaved data may be lost. To reset the computer, press and hold the power button for 4 seconds or more. If the computer is still not reset, remove the AC adapter and the battery.

Chapter 5. Troubleshooting

Computer screen problems

The screen is blank.

- Do the following:
 - If you are using the AC adapter, or using the battery, and the battery status indicator is on, press **Fn + ↑** to make the screen brighter.
 - If the Power indicator is blinking, press the power button to resume from the sleep mode.
 - If the problem persists, follow the solution in the following problem "The screen is unreadable or distorted."

The screen is unreadable or distorted.

- Make sure that:
 - The display device driver is installed correctly.
 - The screen resolution and color quality are correctly set.
 - The monitor type is correct.

Incorrect characters appear on the screen.

- Did you install the operating system or application program correctly? If they are installed and configured correctly, have the computer serviced.

Chapter 5. Troubleshooting

Sound problems

No sound can be heard from the speaker even when the volume is turned up.

- Make sure that:
 - The Mute function is off.
 - The headphone jack is not used.
 - Speakers are selected as the playback device.

Battery problems

Your computer shuts down before the battery status indicator shows empty.

-or-

Your computer operates after the battery status indicator shows empty.

The operating time for a fully charged battery is short.

The computer does not operate with a fully charged battery.

The battery does not charge.

- Discharge and recharge the battery.
- For details, see "Handling the battery" in Chapter 2.
- The surge protector in the battery might be active. Turn off the computer for one minute to reset the protector, then turn on the computer again.
- For details, see "Handling the battery" in Chapter 2.

A hard disk drive problem

The hard disk drive does not work.

- In the **Boot** menu in **BIOS Setup Utility**, make sure that the hard disk drive is included in the **Boot order** correctly.

Chapter 5. Troubleshooting

A startup problem

The Microsoft® Windows operating system does not start.

- Use the OneKey Rescue system to help solve or identify your problem. For details on the OneKey Rescue system, see “Chapter 4. OneKey Rescue system” on page 34.

OneKey Rescue system problems

Backup cannot be made.

- You are not currently using a Windows operating system.
- There is not enough space to store the backed up data. You will need to free more hard disk space on your system partition (C drive).

Fail to restore system partition to factory default.

- The system partition, such as the partition size or the drive capacity of C, has been modified.

Other problems

The computer does not respond.

- To turn off your computer, press and hold the power button for 4 seconds or more. If the computer still does not respond, remove the AC adapter and the battery.
- Your computer might lock when it enters sleep mode during a communication operation. Disable the sleep timer when you are working on the network.

Chapter 5. Troubleshooting

The computer does not start from the desired device.

- See the **Boot** menu of **BIOS Setup Utility**. Make sure that **Boot order** in **BIOS Setup Utility** is set so that the computer starts from the device you want.
- Also make sure that the device from which the computer starts is enabled. In the **Boot** menu in **BIOS Setup Utility**, make sure that the device is included in the **Boot order** list.

The connected external device does not work.

- Do not connect or disconnect any external device cables other than USB while the computer power is on; otherwise, you might damage your computer.
- When using a high power consumption external devices such as an external USB optical disk drive, use external device power adapter. Otherwise, the device may not be recognized, or system shut down may result.

Chapter 6. Upgrading and replacing devices

■ Replacing the battery

Note: Use only the battery provided by Lenovo. Any other battery could ignite or explode.

■ To replace the battery

- 1 Turn off the computer, or enter hibernation mode. Disconnect the AC adapter and all cables from the computer.
- 2 Close the computer display, and turn the computer over.
- 3 Unlock the manual battery latch 1. Hold the spring-loaded battery latch in the unlocked position 2, remove the battery pack in the direction shown by the arrow 3.

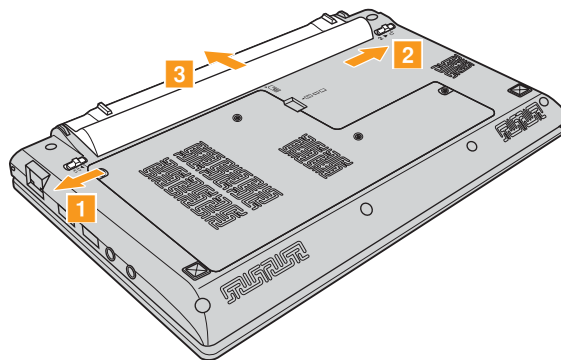

Chapter 6. Upgrading and replacing devices

- ④ Install a fully charged battery.
- ⑤ Slide the manual battery latch to the locked position.
- ⑥ Turn the computer over again. Connect the AC adapter and the cables to the computer again.

Chapter 6. Upgrading and replacing devices

■ ■ Replacing the hard disk drive

You can increase the storage capacity of your computer by replacing the hard disk drive with one of greater capacity. You can purchase a new hard disk drive from your reseller or Lenovo marketing representative.

Notes:

- Replace the hard disk drive only if you upgrade it or have it repaired. The connectors and bay of the hard disk drive were not designed for frequent changes, or drive swapping.
- The preinstalled softwares are not included on an optional hard disk drive.

Handling a hard disk drive

- Do not drop the drive or subject it to physical shocks. Put the drive on a material, such as soft cloth, that absorbs the physical shock.
- Do not apply pressure to the cover of the drive.
- Do not touch the connector.

The drive is very sensitive. Incorrect handling can cause damage and permanent loss of data on the hard disk. Before removing the hard disk drive, make a backup copy of all the information on the hard disk, and then turn the computer off. Never remove the drive while the system is operating, in sleep mode, or in hibernation mode.

Chapter 6. Upgrading and replacing devices

To replace the hard disk drive, do the following:

- ❶ Turn off the computer; then disconnect the AC adapter and all cables from the computer.
- ❷ Close the computer display, and then turn the computer over.
- ❸ Remove the battery pack.
- ❹ Remove the Hard disk/Memory/Mini PCI ExpressCard slot compartment cover.
 - a. Loosen the screws that secure the compartment cover ❶.
 - b. Remove the compartment cover ❷.

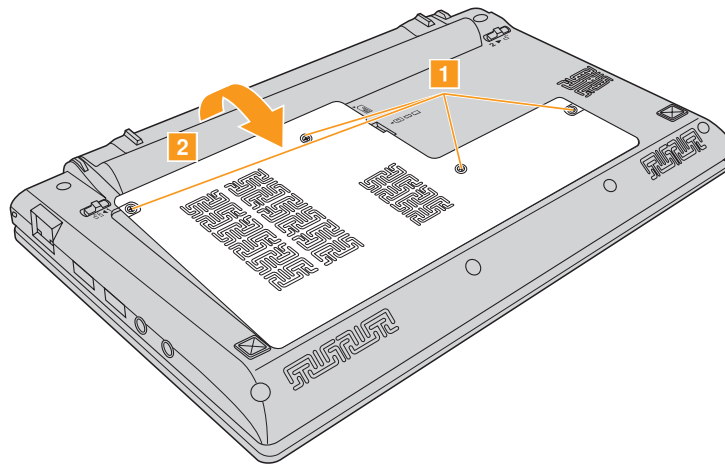

Chapter 6. Upgrading and replacing devices

- 5 Remove the screw **3** that secures the hard disk.

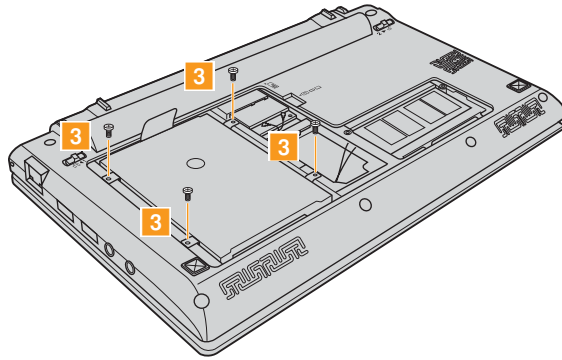

- 6 Pull the tab in the direction shown by arrow **4**, and take out the hard disk drive secured in a metal frame **5**.

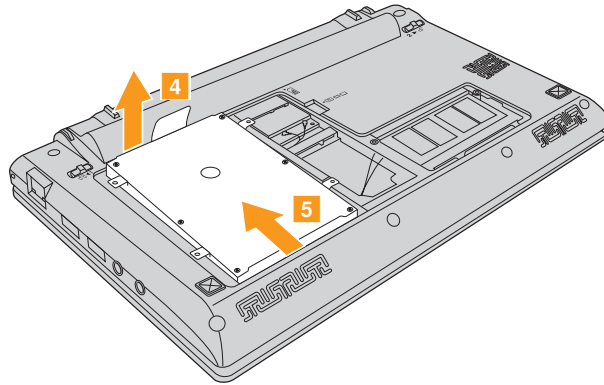

Chapter 6. Upgrading and replacing devices

- 7 Remove the screws and detach the metal frame from the hard disk drive.
- 8 Attach the metal frame to a new hard disk drive; then tighten the screws.
- 9 Put the hard disk drive gently into the hard disk drive bay with the tab facing upwards and the connectors facing each other; then push it firmly into space.
- 10 Reinstall the screw that secures the hard disk drive.
- 11 Reinstall the compartment cover.
- 12 Reinstall the screws.
- 13 Reinstall the battery pack.
- 14 Turn the computer over again. Connect the AC adapter and the cables to the computer again.