



CELSIUS Mobile H

EasyGuide

FUJITSU COMPUTERS
SIEMENS

Are there ...

... any technical problems or other questions you need clarified?

Please contact:

- your sales partner
- your sales outlet

You will find further information in the "Safety, Warranty and Ergonomics" booklet.

The latest information on our products, tips, updates, etc., can be found on the Internet under:
<http://www.fujitsu-siemens.com>



Dieses Handbuch wurde auf Recycling-Papier gedruckt.
This manual has been printed on recycled paper.
Ce manuel est imprimé sur du papier recyclé.
Este manual ha sido impreso sobre papel reciclado.
Questo manuale è stato stampato su carta da riciclaggio.
Denna handbok är tryckt på recyclingpapper.
Dit handboek werd op recycling-papier gedrukt.

Herausgegeben von/Published by
Fujitsu Siemens Computers GmbH

Bestell-Nr./Order No.: **A26391-Kyyy-Z120-1-19**
Printed in the Federal Republic of Germany
AG 0601 06/01

CELSIUS Mobile H

Operating Manual

Introduction

Important notes

Preparing the notebook
for use

Working with your
notebook

Connecting external
devices

Settings in BIOS Setup

Troubleshooting and tips

Memory extension

Technical data

Index

June 2001 edition

DPMS and VESA are registered trademarks of Video Electronics Standards Association.

Intel is a registered trademark, Pentium and Celeron are trademarks of Intel Corporation, USA.

Microsoft, MS, MS-DOS, Windows, and Windows NT are registered trademarks of Microsoft Corporation.

OS/2 and PS/2 are registered trademarks of International Business Machines, Inc.

Zip is a trademark of Iomega Corporation.

Macrovision is a trademark of Macrovision Corporation, USA.

All other trademarks referenced are trademarks or registered trademarks of their respective owners, whose protected rights are acknowledged.

Copyright © Fujitsu Siemens Computers GmbH 2001

All rights, including rights of translation, reproduction by printing, copying or similar methods, in part or in whole, are reserved.

Offenders will be liable for damages.

All rights, including rights created by patent grant or registration of a utility model or design, are reserved.

Delivery subject to availability. Right of technical modification reserved.

Contents

Introduction

Your CELSIUS Mobile A is a versatile and ergonomic notebook. Innovative technology and ergonomic design make this notebook the ideal user-friendly and reliable travel companion.

To simplify the initial start-up of your notebook, one or two operating systems are preinstalled on the hard disk (dual-installation). If two operating systems are preinstalled, you can select which of the two operating systems you want to install during initial start-up.

The energy-saving processor and the energy-saving functions that can be configured allow you to make the most effective use of the battery capacity.

Your notebook has 128 -1024 Mbyte of main memory installed, depending on the upgrade level. Data is stored on a hard disk drive. Your notebook is also equipped with a 3 1/2-inch disk drive. Depending on the model, your notebook is delivered with a CD-RW drive or a DVD-ROM drive. A PC card slot (CardBus or PCMCIA) enables the notebook to operate two type I or type II PC cards or one type III PC card. Depending on the variant, your notebook may be equipped with an internal mini-PCI board.

Your notebook has connectors for external devices such as an external monitor, a printer, and a mouse. The ECP capable parallel port is designed for fast bidirectional data transfer. You can connect peripheral devices such as a scanner, loudspeakers, gamepads, keyboard, or mouse via the two USB ports. In addition, your notebook is equipped with a TV-Out connector to connect to a television.

For mouse control, the notebook has a touchpad with touchpad buttons.

An audio controller, two built in loudspeakers and a built in microphone provide your notebook with an audio capability. You can thus incorporate voice, noise effects and music into your notebook environment. You can also connect an external microphone and an external loudspeaker.

The system settings of the notebook can be configured via the user-friendly *BIOS Setup* programme. Certain system settings (e.g. screen display, energy saving functions) can be modified via various key combinations while you are using the notebook.

Your notebook has a number of security features to ensure that no unauthorised persons can access your data. For example, you can activate a screen saver with password protection. The security functions in the *BIOS Setup* also allow you to protect your data by means of passwords.

This Operating Manual tells you how to put your notebook into operation and how to operate it in daily use.

Additional information on your notebook is contained in the following documents:

- in the manual „Safety and Ergonomics“
- in the manual "Getting Started"
- in the documentation of the operating system
- in the information files (e.g. *.TXT, *.DOC, *.WRI, *.HLP)

Notational conventions

The following symbols are used in this manual:



Indicates information which is important for your health or for preventing physical damage. Failure to follow the instructions may lead to loss of data, invalidate your warranty, destroy the notebook, or endanger your life.



Indicates important information which is required to use the system properly.

Ê

Text which follows this symbol describes activities that must be performed in the order shown.

`This font`

represents text output on the screen.

This font

indicates programme names, commands, or menu items.

"Quotation marks"

indicate names of chapters, data carriers, and terms that are being emphasised.

Important notes

Here you will find essential safety information regarding your notebook. In addition, the manufacturer's notes contain helpful information about your notebook.

Safety



Pay attention to the information provided in the manual "Safety and Warranty" and in the following security notes.

Observe the sections in the manual marked with the symbol on the left.

- When connecting and disconnecting cables, observe the relevant notes in this operating manual.
- Only use batteries designed for this notebook.
Do not store batteries for longer periods in the notebook.
Take care not to drop the batteries or otherwise damage their casing (fire risk).
If the rechargeable batteries are defective, they must not be used.
Do not touch the contacts of the batteries.
Never interconnect the positive and negative terminals of a battery.
Used batteries must be disposed of in accordance with local regulations (special waste).
- If a lithium battery (button cell) is installed in the notebook for real-time buffering, please note that:
The lithium battery may only be replaced by authorised, specially trained personnel. Incorrect handling may lead to a risk of explosion.
The lithium battery may be replaced only with an identical battery or with a type recommended by the manufacturer.
The lithium battery must be disposed of in accordance with local regulations concerning special waste.
- All batteries containing pollutants are marked with one of the two symbols below (crossed-out garbage can).

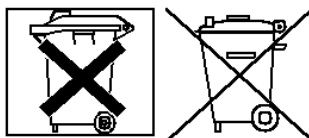

In addition, the marking is provided with the chemical symbol of the heavy metal decisive for the classification as a pollutant.

Cd Cadmium

Hg Mercury

Pb Lead

- During installation and before operating the device, please observe the instructions on environmental conditions in the chapter entitled "錯誤! 找不到參照來源。" as well as the instructions in the chapter "Preparing the notebook for use".
- When cleaning the device, please observe the relevant notes in the paragraph "

Cleaning the notebook*

This notebook complies with the relevant safety regulations for data processing equipment. If you have questions as to whether you can set up the notebook in the intended environment, please contact your sales point or our Hotline/Help Desk.

Notes on installing and removing boards and modules



Only qualified technicians should repair the device. Unauthorised opening or incorrect repair may greatly endanger the user (electric shock, fire risk).

Boards with electrostatic sensitive devices (ESD) are identifiable by the label shown.

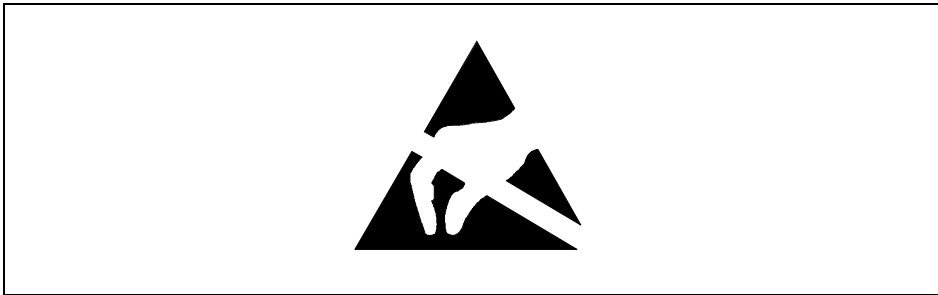

When you handle boards fitted with ESDs, you must, under all circumstances, observe the following points:

- You must statically discharge yourself before working with boards (e.g. by touching a grounded object).
- The equipment and tools you use must be free of static charges.
- Remove the power plug from the mains supply before inserting or removing boards containing ESDs.
- Always hold boards with ESDs by their edges.
- Never touch pins or conductors on boards fitted with ESDs.

Notes on diation Exposure Statement

This device and its antenna(s) must operate with a separation distance of at least 20 cm from all persons and must not be co-located or operating in conjunction with any other antenna or transmitter. End-users must be provided with specific operating instructions for satisfying RF exposure compliance.

Manufacturer's notes

Keep this operating manual together with your device. If you pass on the device to third parties, you should include this manual.

Copyright-protected technology

This product incorporates copyright protection technology that is protected by method claims of certain U. S. patents and other intellectual property rights owned by Macrovision Corporation and other rights owners. Use of this copyright protection technology must be authorised by Macrovision Corporation, and is intended for home and other limited viewing uses only unless otherwise authorised by Macrovision Corporation. Reverse engineering or disassembly is prohibited.

Energy saving

If you will not be using your notebook, switch it off.

Make use of the device's energy saving functions (see "Working with your notebook"). The notebook uses less power when the power management features are enabled. You will then be able to work for longer before having to recharge the battery.

Energy saving under Windows

If a monitor with energy saving features is connected to your notebook, you can use the *Screen Saver* tab to activate the energy saving features of the monitor. Select the following item in the start menu: *Settings - Control Panel - Display - Display Properties - Screen Saver - Energy saving functions for the display*. You can set additional energy saving functions in the start menu by selecting the following item: *Settings - Control Panel - Energy - Extended*.

Energy Star

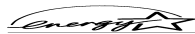

The notebook from Fujitsu Siemens Computers is designed to conserve electricity by dropping to less than 8 W when it goes into standby/suspend mode and to less than 3 W when it goes into OFF mode. With this level of power management, the notebook qualifies for the U.S. Environmental Protection Agency's (EPA) Energy Star Computers award.

The EPA estimates that computer equipment uses 5 percent of all business electricity and that this is growing rapidly. If all desktop PCs and peripherals enter a low-power mode when not in use, the overall savings in electricity could amount to \$ 2 milliard annually. These savings could also prevent the emission of 20 million tons of carbon dioxide into the atmosphere - the equivalent of 5 million automobiles.

錯誤! 尚未定義樣式。

錯誤! 尚未定義樣式。

As an Energy Star Partner, Fujitsu Siemens Computers GmbH has determined that this product meets the Energy Star guidelines for energy efficiency.

Disposal and recycling

This device has been manufactured to the highest possible degree from materials which can be recycled or disposed of in a manner that is not environmentally damaging. The device may be taken back after use to be recycled, provided that it is returned in a condition that is the result of normal use. Any components not reclaimed will be disposed of in an environmentally acceptable manner.

Do not throw lithium batteries into the household waste. They must be disposed of in accordance with local regulations concerning special waste.

If you have any questions on disposal, please contact your local office, our Hotline/Help Desk, or:

Fujitsu Siemens Computers GmbH
Recyclingcenter
D-33106 Paderborn

Tel: +49 5251 81 80 10
Fax: +49 5251 81 80 15

CE marking



The shipped version of this device complies with the requirements of the EEC directives 89/336/EEC "Electromagnetic compatibility" and 73/23/EEC "Low voltage directive".

GS symbol

In normal screen mode (dark characters against a light background) the LCD panel satisfies the ergonomic requirements for the GS symbol.

FCC Class B

This equipment has been tested and found to comply with the limits for a Class B digital device, pursuant to Part 15 of the FCC Rules. These limits are designed to provide reasonable protection against harmful interference in a residential installation. This equipment generates, uses and can radiate radio frequency energy and, if not installed and used in accordance with the instructions, may cause harmful interference to radio communications. However, there is no guarantee that interference will not occur in a particular installation. If this equipment does cause harmful interference to radio or television reception, which can be determined by turning the equipment off and on, the user is encouraged to try to correct the interference by one of the following measures:

- Reorient or relocate the receiving antenna.
- Increase the separation between the equipment and receiver.
- Connect the equipment into an outlet on a circuit different from that to which the receiver is connected.
- Consult the dealer or an experienced radio/TV technician for help.

FCC Caution: To assure continued compliance, (example - use only shielded interface cables when connecting to computer or peripheral devices). Any changes or modifications not expressly approved by the party responsible for compliance could void the user's authority to operate this equipment. This

device complies with Part 15 of the FCC Rules. Operation is subject to the following two conditions: (1) This device may not cause harmful interference, and (2) this device must accept any interference received, including interference that may cause undesired operation.

Battery storage



If you do not use the batteries for long periods, remove them from the notebook. Never store the batteries in the unit.

Store the battery in a fully charged state. The battery should be stored in a dry area at a temperature between 0°C and +30°C. The lower the temperature at which the batteries are stored, the lower is the rate of self-discharge.

If storing for a long period of time (longer than two months) batteries should be fully charged before storage.

To be able to use the optimum battery charging capacity, you should work in the battery mode until the battery is completely discharged, and then recharge the battery.

Transporting the notebook

Please observe the points listed below when transporting your notebook.

Before you travel

- Copy important data from the hard disk onto a floppy disk.
- If you wish to use your notebook during a flight, first check with the flight attendants if it is permissible to do so.
- If you are travelling abroad, ensure that the power adapter can be operated with the local mains voltage. If this is not the case, obtain the appropriate power adapter for your notebook. Do not use any other voltage converter!



If you travel in another country, check whether the local power supply and the specifications of the power cable are compatible. If this is not the case, buy a power cable that matches the local conditions. Do not use a connection adapter for electrical devices to connect the notebook.

If you use a modem, incompatibilities with the local telecommunications system may result.

Transporting the notebook

- Remove all data carriers (e.g. floppy disk, CD) from the drives.

錯誤! 尚未定義樣式。

錯誤! 尚未定義樣式。

- Switch off the notebook.
- Unplug the power adapter and all peripheral devices from the mains outlet.
- Disconnect the power adapter cable and the data cables of all peripheral devices.
- Close the LCD screen so that it locks into place.
- If the notebook needs to be shipped, use the original packaging or other suitable packaging to protect it from damage caused by mishandling.
- To protect against damaging jolts and bumps, use a notebook carrying case to transport your notebook.
- Protect the notebook from severe shocks and extreme temperatures (e.g. direct sunlight in a car).



Cleaning the notebook

Ê Switch off the notebook.

Ê Pull the power plug of the network adapter out of the mains outlet.

Ê Remove the battery.

How to remove the battery is described in the section "Inserting and removing the battery".



Do not clean any interior parts yourself; leave this job to a service technician.

Do not use any cleaning agents that contain abrasives or may corrode plastic.

Ensure that no liquid enters the notebook.

Wipe the casing with a dry cloth.

If particularly dirty, use a cloth that has been moistened in mild domestic detergent and then carefully wrung out.

To clean the keyboard and the touchpad, you can use disinfectant wipes.

Wipe the LCD screen with a soft, moistened cloth.

Preparing the notebook for use



Please read the chapter "Important notes".

Before you can work with your notebook, you need to charge the battery and install and configure the delivered software. The operating system and required drivers are preinstalled.

Upon delivery, the battery can be found in the battery compartment and is not charged. You need to charge the battery if you want to operate your notebook with a rechargeable battery.

If you use the notebook in a normal office situation, run it from the mains using the power adapter.

Unpacking and checking the delivery

- Ê Unpack all the individual parts.
- Ê Check the delivery for damage incurred during transportation.
- Ê Check whether the delivery agrees with the details in the delivery note.



Should you discover that the delivery does not correspond to the delivery note, notify your local sales outlet immediately.

Do not discard the original packing material of the devices. Keep the original packing material in case you need to ship the equipment again.

Switching on the notebook for the first time

When you switch on your notebook for the first time, the supplied software is installed and configured. You should plan some time for this, as this process must not be interrupted.



Do not place it on a soft surface (e.g. a carpet or soft furnishings). The space between the notebook's feet must be clear. Place the notebook on a flat, stable, nonslippery surface.

Do not place the power adapter on heat-sensitive material.

The notebook and the power adapter should be at least 200 mm apart.

Keep other objects 100 mm away from the notebook and its to ensure adequate ventilation.

Never cover the fan intake or exhaust openings of the notebook or the power adapter.

The power cable supplied conforms to the requirements of the country in which you purchased your notebook. Make sure that the power cable is approved for use in the country in which you intend to use it.

The power adapter's AC cord should only be connected to a mains outlet if the notebook is already connected to the power adapter.

Do not expose the notebook to extreme environmental conditions. Protect it from dust, humidity and heat.

Upon delivery, the battery can be found in the battery compartment and is not charged.

- Ê Place the notebook on a flat, stable, nonslippery surface.

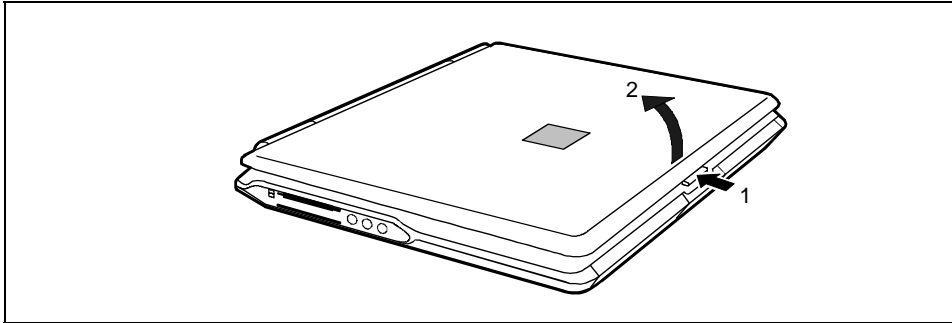

Ê Press the release button (1) and open the LED display panel (2).

Connecting the power adapter and switching on the notebook

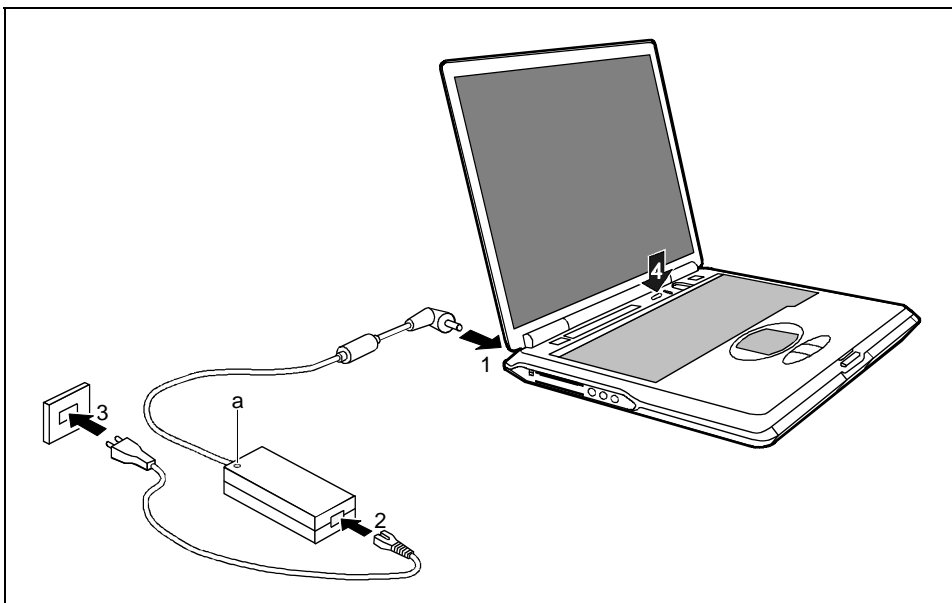

Ê Connect the power adapter cable to the DC jack (DC IN) of the notebook (1).

Ê Connect the power cable to the power adapter (2).

Ê Plug the power cable into the mains supply (3).

The power indicator  on the notebook and the indicator on the power adapter (a) should illuminate. The battery is charging.

Ê Press the Suspend/Resume button (4), and release it again.
The Suspend/Resume button functions like an ON/OFF switch.

The power-on indicator  on the notebook lights up.



After switch-on a self-test (POST, Power On Self Test) is automatically carried out. Never switch the notebook off during the self-test.

First-time software installation



Leave the external power adapter connected to your notebook during the initial installation. Once the installation has been started, the notebook must not be switched off! During installation the notebook may only be rebooted when you are requested to do so!

Ê During installation, follow the instructions on screen.

Consult the operating system manual if there is anything unclear about the requested input data.



You will find further information about the system, drivers, utilities, updates, manuals etc. on the "Drivers & Utilities" CD supplied.

Working with your notebook

This chapter describes the basics for operating your notebook.

Please see the chapter "錯誤! 找不到參照來源。" for instructions on how to connect devices such as a mouse and a printer to the notebook.



Please take note of the information in the chapter "Important notes".

Switching on the notebook

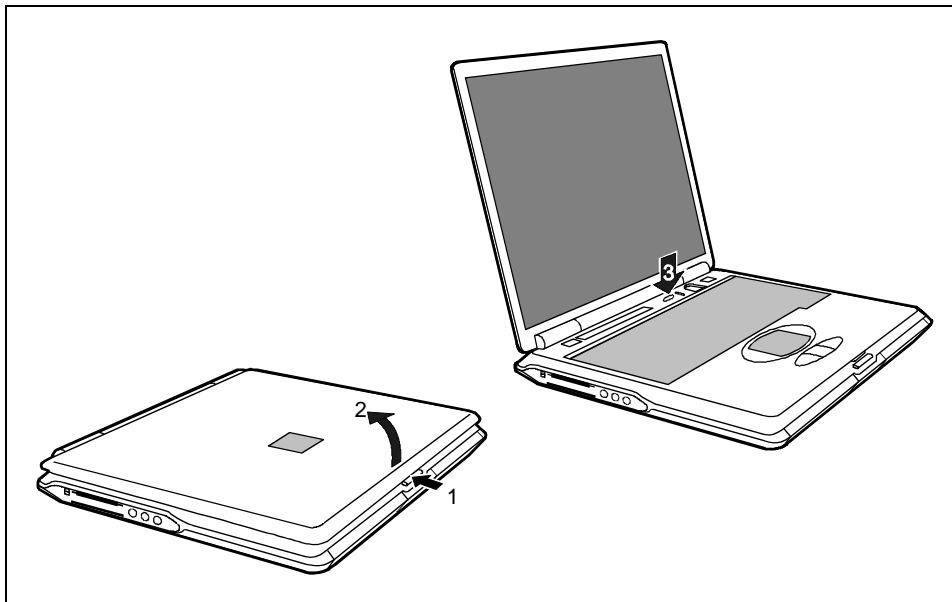

Ê Press the release button (1) and open the LED display panel (2).

Ê Press the Suspend/Resume button to switch on the notebook (3).

The power-on indicator  on the notebook lights up.



You can configure the Suspend/Resume button under *Start - Settings - Control Panel - Power Options - Power Options Properties*.

If you have assigned a password, in order to start the operating system you must enter this password when requested to do so.

Switching off the notebook

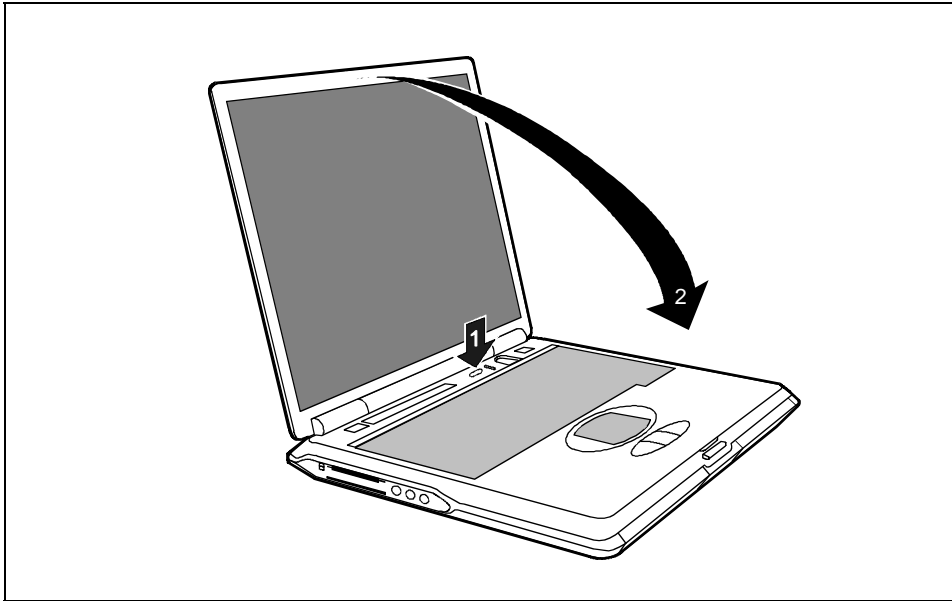

- Ê Shut down the operating system properly.
If the notebook is not switched off automatically, press the Suspend/Resume button (1) and release it again.
- Ê Immediately press the Suspend/Resume button again once, and hold it down for approximately four seconds until you hear an acoustic signal.
- Ê Close the LCD screen of the notebook (2) so that it locks into place.

Switching off notebook via operating system

How you can switch off your notebook via the operating system is dependent on the settings of the power-management feature. Additional information is contained in the section "Using the power-management features" in this chapter.



Save all open files before switching the notebook into the Standby mode to avoid data loss when the notebook remains switched off for a longer time.

Indicators

The following icons appear in the display field of your notebook:

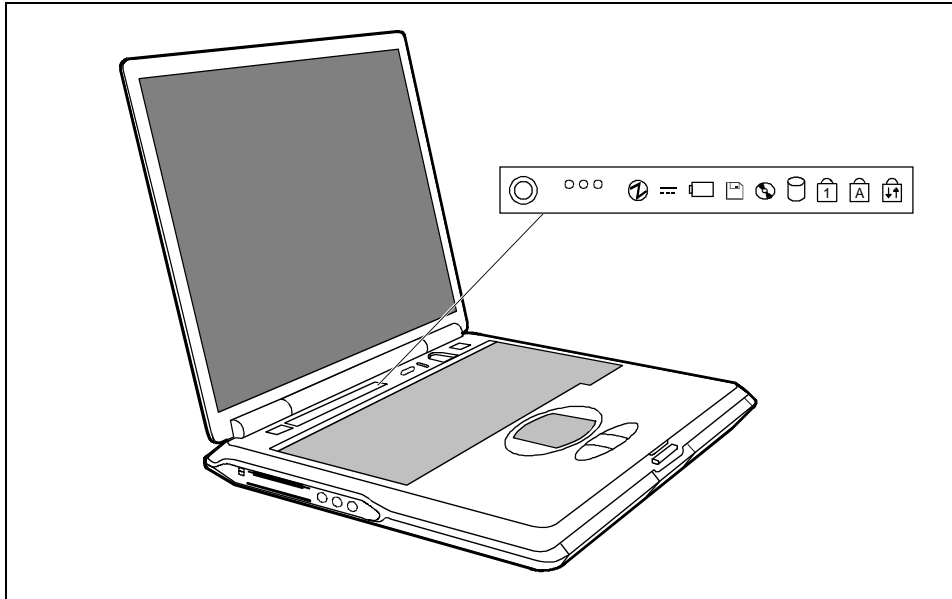

The meanings of the symbols are as follows:



Power-on indicator

- The indicator lights up: The notebook is on.
- The indicator flashes (1 second on / 1 second off): The notebook is in energy-saving mode.
- The indicator is dark: The notebook is switched off.



Power indicator

The power adapter is supplying power to the notebook.



Battery indicator

The battery charging state is indicated in the status indicator panel.



Indicator PC card 1

The indicator lights up when a PC card disk in slot 1 is being accessed. You must not remove the PC card from the slot when this indicator is lit.

錯誤! 尚未定義樣式。



Indicator PC card 2

The indicator lights up when a PC card disk in slot 2 is being accessed. You must not remove the PC card from the slot when this indicator is lit.



Hard disk indicator

The indicator lights up when the hard disk drive is being accessed.



Floppy disk drive indicator

The indicator lights up when a floppy disk in the floppy disk drive is being accessed. You must not remove the floppy disk from the floppy disk drive when this indicator is lit.



Optical drive indicator

The indicator is lit when the CD/DVD in the optical drive is being accessed. You must not remove the CD/DVD from the drive when this indicator is lit.



CapsLK indicator (Caps Lock)

The **l** key has been pressed. All the characters you type appear in uppercase. In the case of overlay keys, the character on the upper left on the keycap appears when that key is pressed.



Scroll indicator (Scroll Lock)

The **[Scr]** key has been pressed. The effect this key has varies from programme to programme.



NumLK indicator (Num Lock)

The key combination **[Fn] + [Num LK]** has been pressed. The numbers on the lower left on keys in the integrated numeric keypad are enabled.



Information on the displays of the security panel is contained in the chapter "錯誤! 找不到參照來源。", in the section "錯誤! 找不到參照來源。".

Keyboard

The following description of keys refers to Windows. Additional functions supported by the keys are described in the relevant manuals supplied with your application programmes.

The figure below shows how to access the different characters on keys with overlaid functions. The example applies when the CapsLK indicator is not lit.

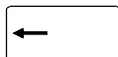
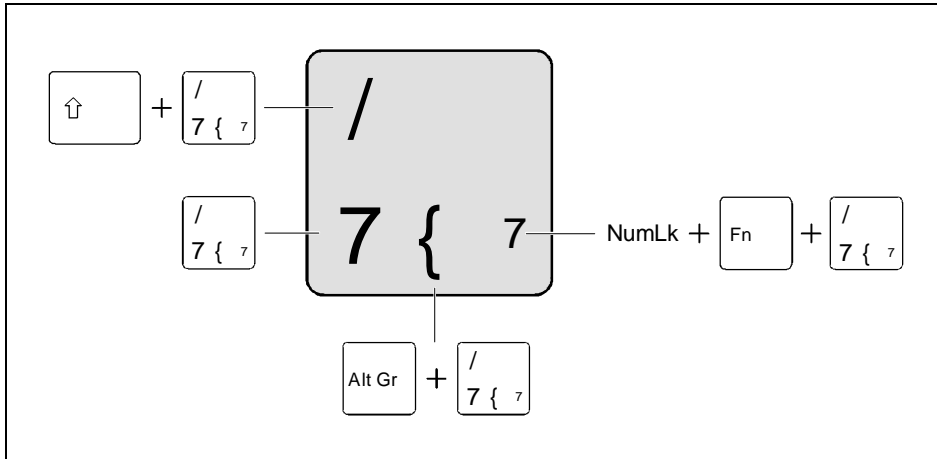

Backspace key

The Backspace key deletes the character to the left of the cursor.



Tab key

The Tab key moves the cursor to the next tab stop.

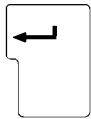

Enter key (return, enter, line feed, carriage return)

The enter key terminates a command line. The command you have entered is executed when you press this key.





Caps Lock key

The Caps Lock key activates uppercase mode (CapsLK indicator lit). The Caps Lock function causes all the characters you type to appear in uppercase. In the case of overlay keys, the character on the upper left on the keycap appears when that key is pressed.

To cancel the Caps Lock function, simply press the Caps Lock key again.



Shift key

The Shift key causes uppercase characters to appear. In the case of overlay keys, the character on the upper left of the keycap appears when that key is pressed.



Alt Gr key

The [Alt Gr] key causes the characters in the lower middle of the keycap to appear (e.g. { in the case of the [7] key on the German keyboard).



Fn key

The [Fn] key enables the special functions indicated on overlay keys (see "Key combinations").

If the external keyboard does not feature an [Fn] key, you can simultaneously press the [Ctrl] + [Alt Gr] keys or the [Ctrl] + [Alt] keys.

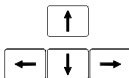

Cursor keys

The cursor keys move the cursor in the direction of the arrow, i.e. up, down, left, or right.



Pause key

The [Pause] key temporarily suspends display output. Output will resume when you press any other key.



Start key

The Start key invokes the Windows Start menu.



Menu key

The Menu key invokes the menu for the marked item.

Numeric keypad

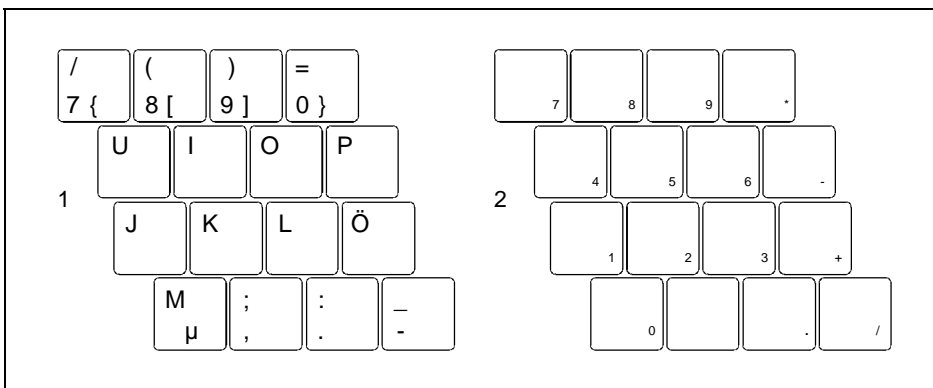

1 = Characters enabled when NumLK indicator is not lit (see "

錯誤! 尚未定義樣式。

Indicators").
2 = Characters enabled when NumLK indicator is lit (see "



錯誤! 尚未定義樣式。

Indicators").

If the numeric keypad is enabled (NumLK indicator is lit) and you hold down the **[Fn]** key, you can output the characters printed in blue on the bottom right of the keys.

Key combinations

The following description of key combinations refers to functions when using Microsoft Windows. Some of the following key combinations may not function in other operating systems and with some device drivers.

Other key combinations are described in the relevant manuals supplied with your application programmes.

Key combinations are performed as follows:

Ê Press and hold the first key in the combination.

Ê While keeping the first key pressed, press the other key or keys in the combination.



If the external keyboard does not feature an **[Fn]** key, you can simultaneously press the **[Ctrl] + [Alt Gr]** keys or the **[Ctrl] + [Alt]** keys.



+



Undocking

This key combination prepares the device for undocking off the Port Replicator.



+



Enlarge MS-DOS screen

This key combination enlarges the screen in the MS-DOS mode to the full-screen mode or switches it back to the normal display mode.



+



Switch internal touchpad on/off

This key combination enables and disables the touchpad function.

To do this, set the setting *Internal Pointing Device to Auto Disabled* in the *BIOS Setup* in the menu *Advanced - Keyboard/Mouse Features*.



+



Switching on the Speed Skp® mode

This key combination switches between the possible Speed Skp® modes:

- Maximum power
- Battery optimised power (reduced processor speed during battery mode)



+



Switching the loudspeakers on/off

This key combination switches your notebook's integrated loudspeakers off and on.



+



Increasing the volume

This key combination raises the volume of the integrated loudspeakers.



+



Reducing the volume

This key combination decreases the volume of the integrated loudspeakers.



+



LCD off

This key combination switches off the LCD monitor to save energy.



+



Increasing the display brightness

This key combination increases the brightness of the display.

錯誤! 尚未定義樣式。

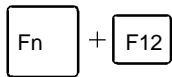

Reducing the display brightness

This key combination reduces the brightness of the display.

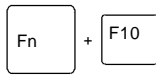

Switching between internal and external screen

If an external monitor is connected, the monitor on which the output is to be displayed can be selected with this key combination. You can opt to use:

- just the notebook's internal display
- just the external display
- both the internal and the external display.

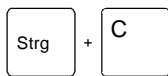

Halting the current operation

This key combination can be used to halt an operation instantly without clearing the keyboard buffer.

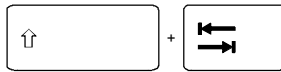

Backtab (Shift+Tab)

This key combination moves the cursor back to the previous tabular stop.

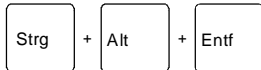

Carrying out a warm boot

This key combination triggers a reset and warm-boots the notebook. First hold down the **[Ctrl]** and **[Alt]** key, and then press the **[Del]** key. With Windows 98, Windows 2000, Windows ME and Windows NT Task Manager appears first. Then you must press all three keys again to re-boot.

Touchpad and touchpad buttons

The touchpad enables you to move the mouse pointer on the screen. The two touchpad buttons allow the selection and execution of commands. They correspond to the buttons on a conventional mouse.

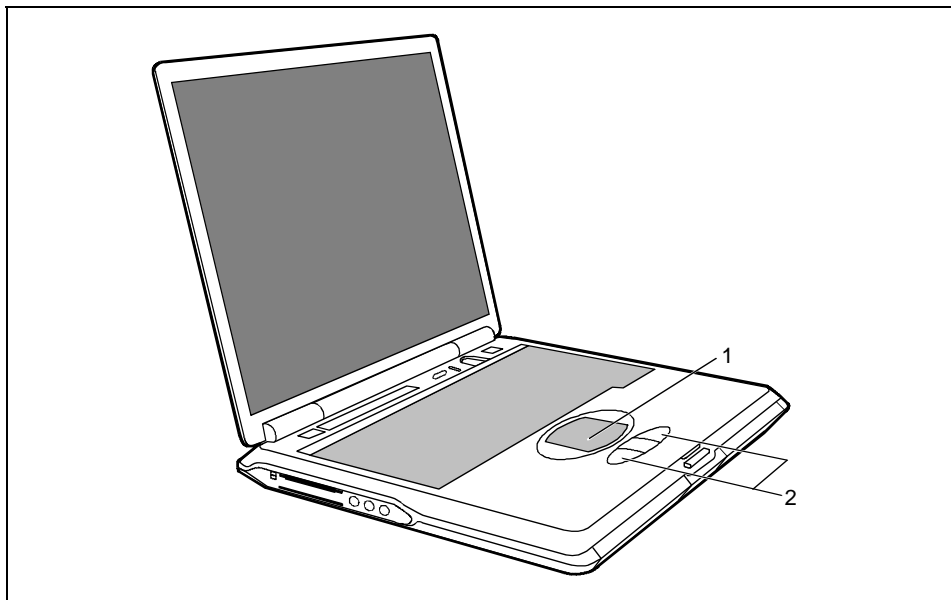

1 = Touchpad

2 = Touchpad buttons

Moving the pointer

Ê Move your finger on the touchpad.

Selecting

Ê Tap the touchpad once or press the left button once.

Executing a command

Ê Tap the touchpad twice or press the left button twice.

Dragging an object

Ê Move the pointer to the item you wish to select.

Ê Select the desired object, and leave your finger on the touchpad.

Ê Drag the object to the desired position.

Ê Lift your finger from the touchpad.

Display settings

Setting the desktop area

You can change the screen resolution under *Start - Settings - Control Panel - Display - Settings* and then selecting from the *Resolution* field.

Adjusting the font size

Under *Start - Settings - Control Panel - Display - Settings* you can choose between a larger and a smaller font in the *Font size* field.

Setting the display brightness

You can adjust the brightness of your LCD screen with the keys **[Fn]** and **[F11]** or **[Fn]** and **[F12]**: With **[Fn]** and **[F12]** you adjust the screen darker, and with **[Fn]** and **[F11]** brighter.

Synchronising the display on the LCD screen and an external monitor

Your notebook supports the simultaneous display on the LCD monitor and an external monitor. If the picture does not appear correctly on the LCD monitor, press the key combination **[Fn] + [F10]** several times, or switch the external monitor off and then on again. This achieves good picture synchronisation.

Adjusting the speed of the mouse pointer

You can change the speed of the mouse pointer under *Start - Settings - Control Panel - Mouse* and clicking on the *Motion* tab.



Battery

The battery is one of the most important components of your notebook. When not plugged into a mains outlet, the notebook runs on its built-in battery. You can increase the life of the battery by caring for the battery properly. The average battery life is around 500 charge/discharge cycles. You can extend the battery life by taking advantage of the available energy saving functions.



Only use batteries released for your notebook.

Take care not to drop the batteries or otherwise damage their casing (fire risk).

If the rechargeable batteries are defective, they must not be used.

Do not touch the contacts of the batteries.

Never interconnect the positive and negative terminals of a battery.

Used batteries must be disposed of in accordance with local regulations (special waste).

Observe the information on battery storage in the chapter "Important notes".

Performing the battery learning cycle

The battery contains electronics that continuously monitor the battery charging level and display the current charging level. To compensate for measuring errors in the electronics, and because the chemical properties of the battery change over time, the electronics must be recalibrated regularly. This calibration is carried out using a battery learning cycle. Using the battery learning cycle ensures that the maximum battery capacity can always be used. During the learning cycle a defined charging cycle is carried out.



The battery learning cycle lasts between four and six hours and must not be aborted. During this period you can not work with the notebook!

↳ Restart the notebook (switching ON/OFF or warm boot).

The following display briefly appears on the screen during start-up:

<ESC> Diagnostic screen <F12> Boot Menu <F2> BIOS Setup

↳ Press function key **[F6]**.

The learning cycle is started. When the learning cycle is ended, a corresponding message is displayed.

Charging the battery

The battery indicator displays the remaining battery charge (see the section "

Indicators"). When you switch on the notebook, it takes a few seconds before the battery status is displayed.

You can charge the battery by connecting the notebook to the power adapter (see "Connecting the power adapter and switching on the notebook").

The battery can only be charged when the ambient temperature is between 5°C and max. 35°C.

With the notebook switched on or off, the battery will completely recharge in approximately three to four hours.

Work in the battery mode until an acoustic warning prompts you to recharge and the battery indicator begins to flash. The notebook battery should not be charged before this point.

If you do not connect the power adapter within five minutes of the signals described above, your notebook automatically switches itself off.

Monitoring charging time

The remaining battery charge is indicated by the battery symbol in the status indicator panel (see the section "



錯誤! 尚未定義樣式。

Indicators"). When you switch on the notebook, it takes a few seconds before the battery status is displayed.

During mobile operation you can also use a "battery charge meter" for energy-saving monitoring under Windows.

A battery icon is shown in the taskbar. When you position the cursor on the battery icon, the battery charge level is displayed with a blue status bar. This blue bar progressively decreases as the battery discharges.

Inserting and removing the battery



Only use batteries released for this notebook.

Never use force when inserting or removing a battery.

Make sure that no foreign objects enter the slots.

Ê Switch off the notebook.

Ê Place the notebook on a flat surface.

Ê Open the LCD display panel.

Removing the battery

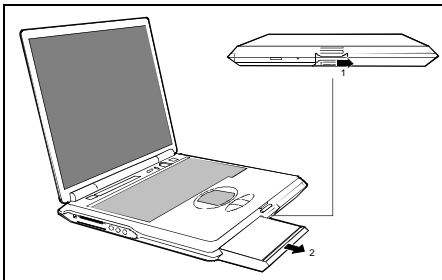

Ê Push the slide in the direction of the arrow up to the stop (1).

Ê Pull the battery out of the casing in the direction of the arrow (2).

Installing the battery

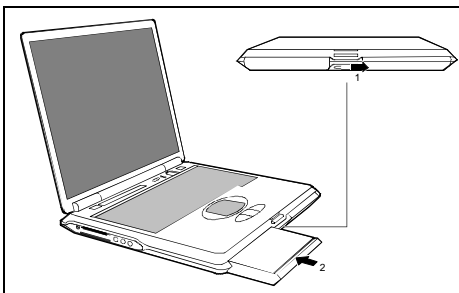

Ê Push the slide in the direction of the arrow up to the stop (1).

Ê Position the battery at the edge of the casing (2) and then press it into the notebook.

Using the power-management features

The notebook uses less power when the power management features are enabled. You will then be able to work longer when using the battery before having to recharge it.



If you are connected to a network or use the integrated modem, PC LAN card, or PC modem card, we advise against enabling an energy saving mode. This could lead to an interruption of your network connection.

When not using the notebook for long periods of time, first end the energy saving mode, then switch off the notebook. Never switch off the notebook with the Suspend/Resume button while the notebook is in one of the energy-saving modes.

If your notebook is in an energy-saving mode mode:

- Do not connect any external peripheral devices.
- Do not disconnect any external peripheral devices.
- Do not attempt to switch the notebook on if the built-in battery is flat.
- Do not change or remove the floppy disk, if inserted.
- Do not add or remove RAM.
- Do not add or remove a PC card.
- Do not replace or remove the battery.



Energy-saving modes of notebook

You can set two energy-saving modes with your notebook.

In the Suspend mode (*Suspend to DRAM/Standby*) all current data (active programmes, files) are buffered in the main memory, and in the Save-to-Disk mode (*Save to Disk/HibernateMode*) all current data are saved on the hard disk. Then the notebook is switched off. After the notebook is switched on, you can continue working exactly where you left off before.

Operating systems with ACPI (Windows 98, Windows ME and Windows 2000)



For operating systems with ACPI you can set the energy-saving functions under *Settings - Control Panel - Power Management* (e.g. *Standby, Hibernate mode* and *LCD off*).

You can configure the Suspend/Resume button and the lid switch in the *Settings* tab under *Settings - Control Panel - Power Management*.

Settings for energy-saving functions in the *BIOS Setup* are not taken into account by operating systems with ACPI.

Changing settings

Ê Double-click on the *My Computer* symbol.

Ê Double-click on the *Control Panel* symbol.

Ê Double-click on the *Power management* symbol in the Control Panel window.

The *Properties* dialogue field appears.

Ê Adjust the setting to your needs.

Ê Click on *OK* to save the settings.



With Windows 2000 and Windows ME the *Hibernate mode* is switched off in the default setting.

With Windows 98 please read the chapter "PHDISK (for Windows 98 and Windows NT only)".

Additional information on this service programme is contained in the help function of Windows 98 and Windows 2000.

Operating systems with APM (Windows 95, Windows NT with APM extensions)



For operating systems with APM (Advanced Power Management) you can set the energy-saving functions in the *BIOS Setup* (e.g. *Suspend to RAM*, *Save to Disk*, *LCD off* etc.).

Setting energy-saving modes

- Ê Call the *BIOS Setup*.
- Ê Set which energy-saving mode you want to use in the *Power* menu.
- Ê Set the *Auto Suspend Timeout* parameter in the *Power* menu to a time period after which the notebook is to be switched into the energy-saving mode.

Suspend to DRAM

In this mode the current data in the main memory (DRAM) is stored. The data is stored for as long as the notebook is supplied with energy. If the battery is full, the data is stored for a matter of days. Without a battery and without a power supply the current data is lost.

Save to Disk

So that the current data can be saved, sufficient memory must be available on the hard disk. If the operating system Windows NT or OS/2 Warp is used, a Save-to-Disk partition must be created on the hard disk (see manual for respective operating system).

In this case also see the section "PHDISK (for Windows 98 and Windows NT only)".

PHDISK (for Windows 98 and Windows NT only)

The *PHDISK* service programme reserves the memory space required for the use of Save-to-Disk mode. The programme creates a file or partition for saving the main memory contents and the system register when your notebook is switched over to Save-to-Disk mode. The positions of the first and last free sectors are saved in the CMOS after running this programme.

- Run *PHDISK* after you have installed or removed memory modules.
- Run *PHDISK* after you have installed or restored Windows 98.
- Run *PHDISK* after you have replaced your hard disk.
- Run *PHDISK* if you have received a BIOS error message in conjunction with Save-to-Disk mode during the self test (POST).



In Windows NT the *PHDISK* service programme is not supported by the NTFS file system.
In Windows 2000/ME the required memory space on the hard disk is not reserved until you make the required Hibernate mode settings under *Settings - Control Panel - Power Management*.

Running PHDISK

- Ê Click on *Start* and then *Shut down* in Windows.
- Ê Activate the *Start computer in MS-DOS mode* checkbox and click on *Yes*.

錯誤! 尚未定義樣式。

- Ê Enter `CD\UTILITY\PHDISK` at the DOS prompt and press the Enter key.
- Ê Enter `PHDISK` after the DOS prompt.
- Ê Follow the instructions on the screen.



Be sure to define a sufficiently large partition.

If you require additional information on the programme parameters, enter `PHDISK` or `PHDISK /INFO` at the DOS prompt.



We recommend that you use the considerably more flexible option *FILE* when running *PHDISK*. We discourage the use of the *PARTITION* option, as the safety of the data already saved on the hard disk is not ensured.

Additional power-management features

Closed cover switch

When you close the LCD display panel, the notebook switches into Standby mode. Opening the LCD display panel ends Standby mode.

- Ê Set the value *On* in the *BIOS Setup* in the *Power - Advanced Features* menu for the *Lid Closure Suspend* parameter if your notebook is to go into the energy-saving mode when the lid is folded down.
- Ê If the energy-saving mode is to be ended again by folding up the LCDscreen, then also set the *LidOpen Resume* parameter to *On*.

Power Button

You can configure the Suspend/Resume button.

If you want to use the Suspend/Resume button as an ON/OFF switch, set the *Power Button* parameter to *Power Off* in the *Power - Advanced Features* menu in the *BIOS Setup*.

Standby Timeout

With this mode you switch off the LCD screen and internal components after a defined period of time. Any activity automatically returns the notebook to normal operation.

Hard Disk timeout

With this mode the motor of the hard disk drive is switched off as soon as no activity with the keyboard or the pointing device, or any other input or output activity takes place for a time period defined in the *BIOS Setup*.

This parameter is set in the *Power* menu in the *BIOS Setup*. When the hard disk is accessed, the motor of the hard disk drive is automatically switched on again.

Hard disk

The hard disk is the most important storage medium of your notebook. You can work considerably faster and more efficiently if you copy applications and files from floppy disks or CDs to your hard disk.

When the hard disk is accessed, the hard disk indicator lights up .

Inserting and removing modules

Modules can be optical drives, additional hard disk or floppy disk drives or batteries.



Only use modules released for this notebook.

Do not use force when installing or removing a module.

Make sure that no foreign objects enter the slots.

- Ê Switch off the notebook.
- Ê Place the notebook on a flat surface.
- Ê Open the LCD display panel.



錯誤! 尚未定義樣式。

Removing modules

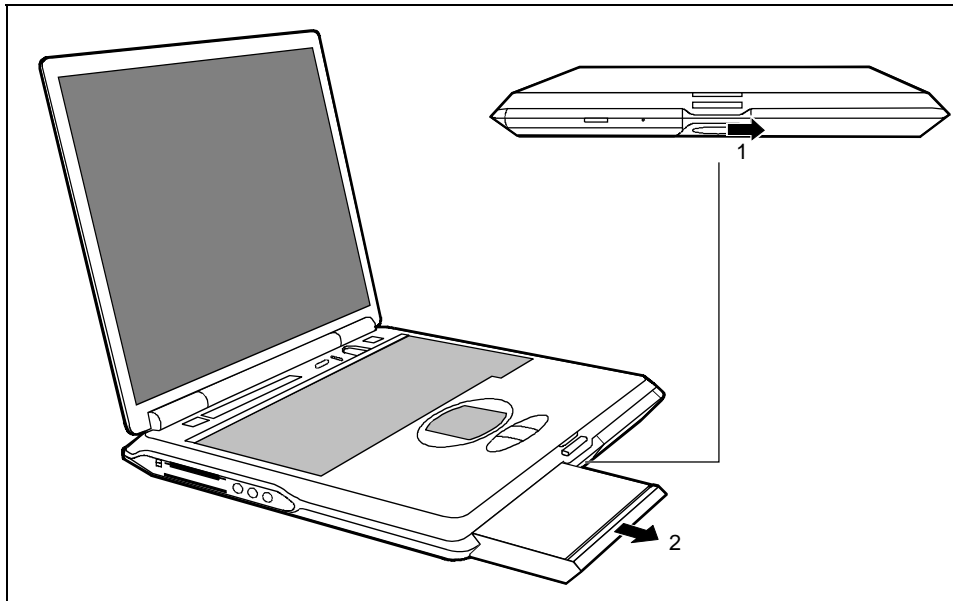

Ê Push the slide in the direction of the arrow up to the stop (1).

i Before removing the left module, slide the release button to the right. Before removing the right module, slide the release button to the left.

Ê Remove the module the direction of the arrow (2).

Installing modules

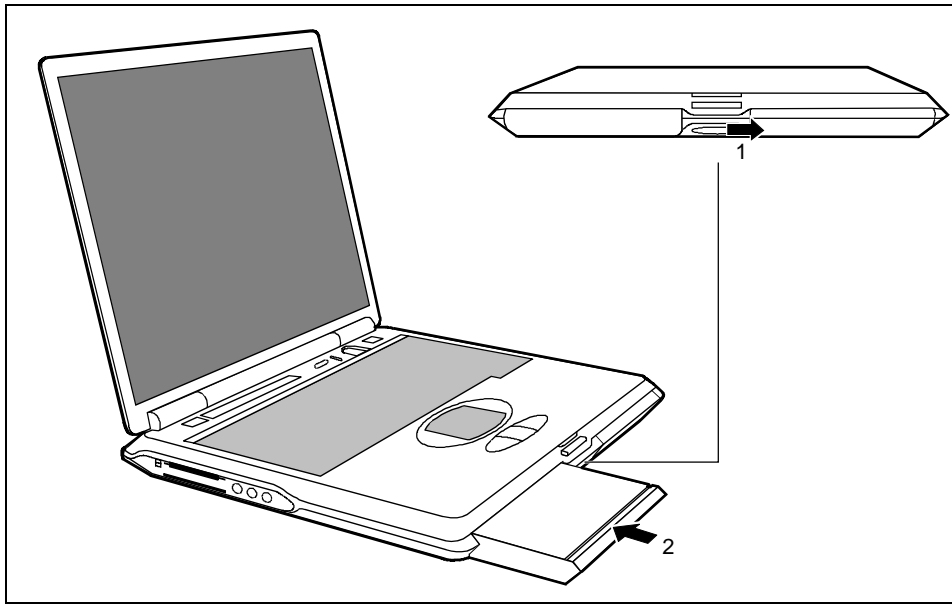

Ê Push the slide in the direction of the arrow up to the stop (1).

i Before removing the left module, slide the release button to the right. Before removing the right module, slide the release button to the left.

Ê Position the module at the edge of the casing (2) and then press it into the notebook.

Ê Release the slide (2).

Optical drives

Depending on the model, your notebook is equipped with a CR-ROM drive, a CD-RW drive, or a DVD-ROM drive.



This device contains a light-emitting diode, classified according to IEC 825-1:1993: LASER CLASS 1, and must not be opened.

Avoid touching the surface of a CD/DVD. Handle CDs/DVDs only by their edges!

Always store CDs/DVDs in their cases. Thus you avoid dust contamination, scratches, bending or other damage.

Protect your CDs/DVDs from dust, mechanical vibration and direct sunlight!

Avoid storing a CD/DVD in areas subject to high temperatures or humidity.

You may use both 8-cm and 12-cm CDs/DVDs in the optical drive.

When using CDs/DVDs of minor quality vibrations and reading errors may occur.

Optical drive indicator

The indicator  flashes when a CD/DVD is inserted. The indicator goes out when the drive is ready-to-operate. The indicator lights up when the drive is accessed.



If the indicator does not go out after the CD/DVD is inserted, and continues to flash, the CD/DVD is probably damaged or dirty.

Inserting or removing a CD/DVD

The notebook must be switched on.

Ê Push the insert/eject button (1).

The drive tray will open.

Ê Pull the drive tray completely out.

Ê Place the CD/DVD in the drive tray with the label facing upwards.

or

Ê Take out an inserted CD/DVD.

Ê Push in the drive tray until you feel it lock into place.

Manual removal (emergency removal)

In the event of a power failure or damage to the drive it may be necessary to manually remove the CD/DVD.

Ê Switch off the notebook.

Ê Push a pen or a piece of wire (such as a paper clip) into the opening for manual ejection.

The drive tray is unlocked. You can now pull the drive tray out of the drive.



Where the opening for manual ejection is located please refer to the documentation of the drive.

Floppy disk drive



Never clean the floppy disk drive with cleaning disks. Any attempt would destroy the read/write head in the disk drive within 20 seconds.

Make sure that no floppy disk is inserted in the floppy disk drive during transport. Otherwise the eject button may break off and the floppy disk drive will be damaged.

Working with floppy disks



Follow the instructions supplied by the vendor of the floppy disks.



錯誤! 尚未定義樣式。

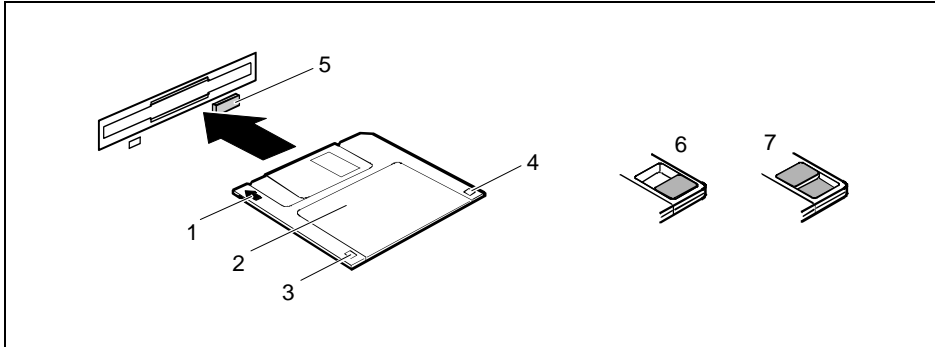

1 = Insertion direction

2 = Label area

3 = Write protection tab for a 1.44 Mbyte floppy disk

4 = Identification of a 1.44 MB floppy disk or write protect switch on a 120 MB floppy disk

5 = Eject button for inserted floppy disks

6 = Disk is write-protected

7 = Disk is not write-protected

To insert a diskette:

É Push the floppy disk into the drive in the insertion direction (1) until it engages. The label should be facing upward.

To remove a diskette:

É Push the eject button (5).

Protect the floppy disk against being overwritten or erased

É Slide the write-protect slider into position (6). The hole is now visible.

Deactivate write protection

É Slide the write-protect slider into position (7). The hole is now covered.

Integrated 56k modem

Depending on the device version, a modem may already be installed in your notebook. The integrated 56k modem supports all data communication applications, such as:

- Modem operation: High-speed downloads at up to 56,000 bit/s (V.90). Downward-compatible to V.34 modems.
- Fax mode: Transmitting and receiving at up to 14,400 bit/s
- Simple country adaptation with programme

The modem complies with the EU Directive 91/263/EEC (Telecommunications terminal equipment directive) and has been checked in agreement with the guideline TBR-21.

錯誤! 尚未定義樣式。

