

## Federal Communications Commission (FCC) Statement

This device complies with Part 15 of the FCC Rules. Operation is subject to the following two conditions:

- This device may not cause harmful interference, and
- This device must accept any interference received; including interference that may cause undesired operation.

This Equipment has been tested and found to comply with the limits for a Class B digital device, pursuant to Part 15 of the FCC rules. These limits are designed to provide reasonable protection against harmful interference in a residential installation. This equipment generates uses and can radiate radio frequency energy and, if not installed and used in accordance with the instructions, may cause harmful interference to radio communications. However, there is no guarantee that interference will not occur in a particular installation. If this equipment does cause harmful interference to radio or television reception, which can be determined by turning the equipment off and on, the user is encouraged to try to correct the interference by one or more of the following measures:

- Reorient or relocate the receiving antenna.
- Increase the separation between the equipment and receiver.
- Connect the equipment into an outlet on a circuit different from that to which the receiver is connected.
- Consult the dealer or an experienced radio/TV technician for help.

**CAUTION!** Changes or modifications to this unit not expressly approved by the party responsible for the compliance could void the user's authority to operate this equipment.

## FCC RF Radiation Exposure Statement:

1. This Transmitter must not be co-located or operating in conjunction with any other antenna or transmitter.
2. This equipment complies with FCC RF radiation exposure limits set forth for an uncontrolled environment. This device was tested for typical lap held operations with the device contacted directly to the human body to the back side of the notebook computer. To maintain compliance with FCC RF exposure compliance requirements, avoid direct contact to the transmitting antenna during transmitting.

## MACROVISION CORPORATION PRODUCT NOTICE

This product incorporates copyright protection technology that is protected by U.S. patents and other intellectual property rights. Use of this copyright protection technology must be authorized by Macrovision, and is intended for home and other limited viewing uses only unless otherwise authorized by Macrovision. Reverse engineering or disassembly is prohibited.

# CONTENTS

---

|                                                    |           |
|----------------------------------------------------|-----------|
| <b>TAKING CARE OF YOUR NOTEBOOK PC .....</b>       | <b>5</b>  |
| <b>1 BEFORE YOU START .....</b>                    | <b>9</b>  |
| 1-1 Making sure you have everything .....          | 9         |
| 1-2 Finding where everything is located .....      | 10        |
| <b>2 GETTING STARTED .....</b>                     | <b>19</b> |
| 2-1 Power Sources .....                            | 19        |
| 2-2 Display Panel .....                            | 22        |
| 2-3 Starting Your Notebook PC .....                | 24        |
| 2-4 Status Display Indicators .....                | 26        |
| 2-5 Using the Keyboard .....                       | 29        |
| 2-6 Volume Control .....                           | 31        |
| 2-7 Power Management .....                         | 32        |
| <b>3 USING YOUR NOTEBOOK PC .....</b>              | <b>35</b> |
| 3-1 Touchpad Pointing Device .....                 | 35        |
| 3-2 Memory Card Reader .....                       | 37        |
| 3-3 Optical Drive .....                            | 38        |
| 3-4 PC Cards .....                                 | 45        |
| 3-5 Memory Upgrade Module .....                    | 47        |
| 3-6 Device Ports on Optional Port Replicator ..... | 51        |
| <b>4 TROUBLESHOOTING .....</b>                     | <b>55</b> |
| 4-1 Identifying the Problem .....                  | 55        |
| <b>APPENDIX .....</b>                              | <b>57</b> |
| Notebook Specifications .....                      | 57        |
| WLAN Specifications .....                          | 58        |

This page is intentionally left blank.

# TAKING CARE OF YOUR NOTEBOOK PC

---

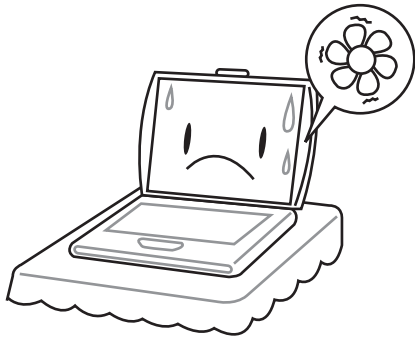

To prevent possible overheating of the computer's processor, make sure you don't block the openings provided for ventilation.



**DO NOT** press or touch the display panel.

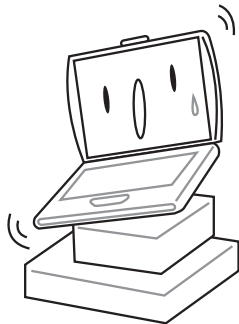

**DO NOT** place on uneven or unstable work surfaces.



**DO NOT** use your notebook computer under harsh conditions.

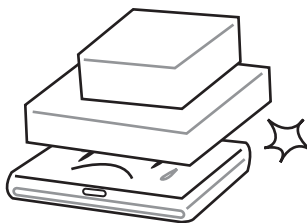

**DO NOT** place or drop objects on the computer and **DO NOT** apply heavy pressure on it.



**DO NOT** subject the computer to magnetic fields.

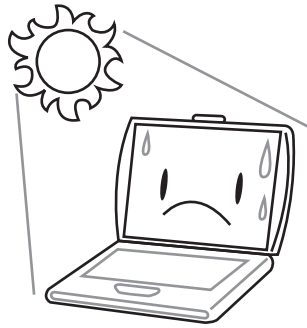

**DO NOT** expose to direct sunlight.



**DO NOT** use or store in extreme temperatures.

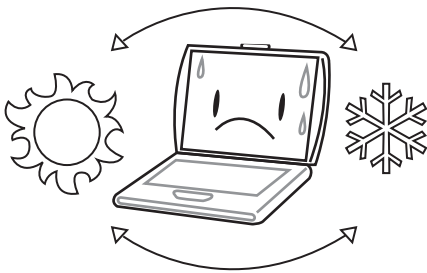

Avoid sudden changes in temperature or humidity by keeping it away from A/C and heating vents.



**DO NOT** expose the computer to rain or moisture.



**DO NOT** place near fire or other sources of heat.

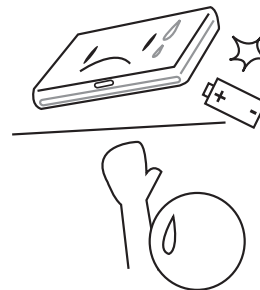

**DO NOT** tamper with the batteries. Keep them away from children.



**DO NOT** expose to dust and/or corrosive chemicals.

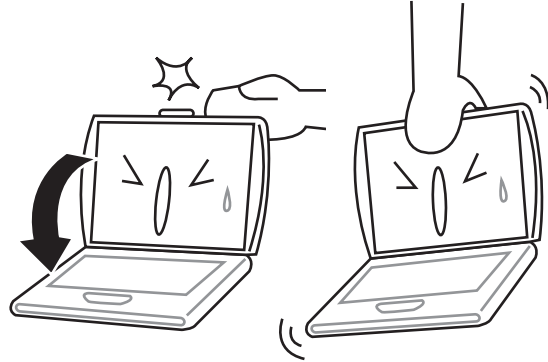

**DO NOT** slam your notebook shut and never pick up or hold your notebook by the display.

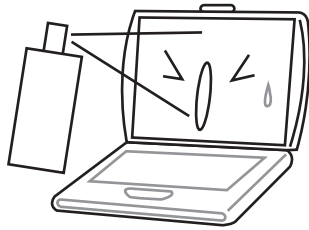

**DO NOT** spray water or any other cleaning fluids directly on the display.

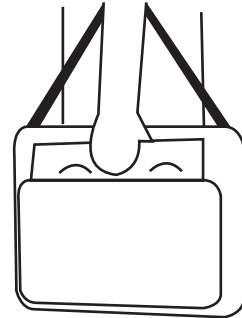

If you are traveling with your computer, remember to carry it as hand luggage. Do not check it in as baggage.

This page is intentionally left blank.

# 1 BEFORE YOU START

---

## 1-1 Making sure you have everything

When you receive your notebook PC, unpack it carefully, and check to make sure you have all the items listed below. For a pre-configured model you should have the following:

- Notebook Computer
- Lithium ion battery
- AC adapter with AC power cord
- Driver and Applications CD
- Getting Started Guide or User Guide

Depending upon the configuration of your notebook, you may have also received the following items:

- CD-ROM Application CD
- DVD Application CD
- DVD / CD-RW Combo Application CD
- DVD-RW Application CD

Once you have checked and confirmed that your notebook system is complete, read through the following pages to learn about all of your notebook components.



## 1. BEFORE YOU START

---

### 1-2 Finding where everything is located

#### 1-2-1 OPENING THE DISPLAY PANEL

1. Slide the latch located at the top of the display panel to the right. This releases the locking mechanism and raises the display slightly.
2. Lift the display backwards, being careful not to touch the screen, until it is at a comfortable viewing angle.

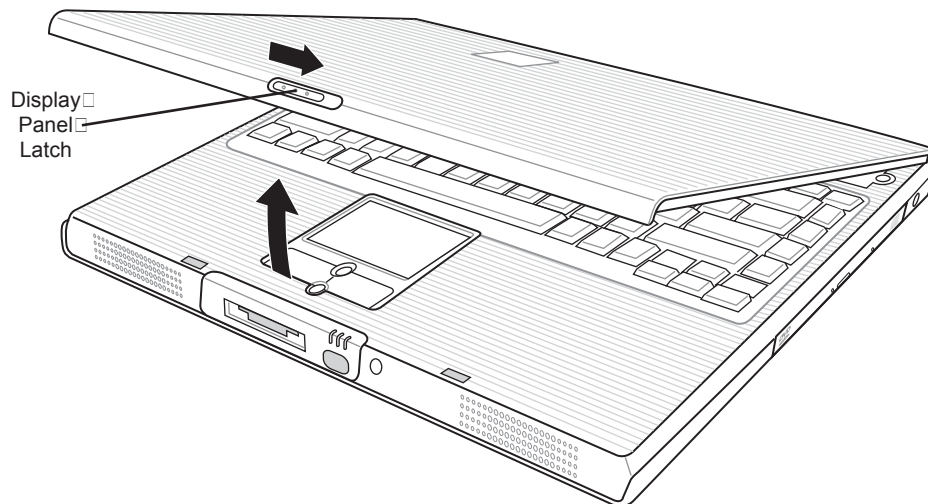

## 1-2-2 TOP COMPONENTS

The following is a brief description of your notebook's top components.

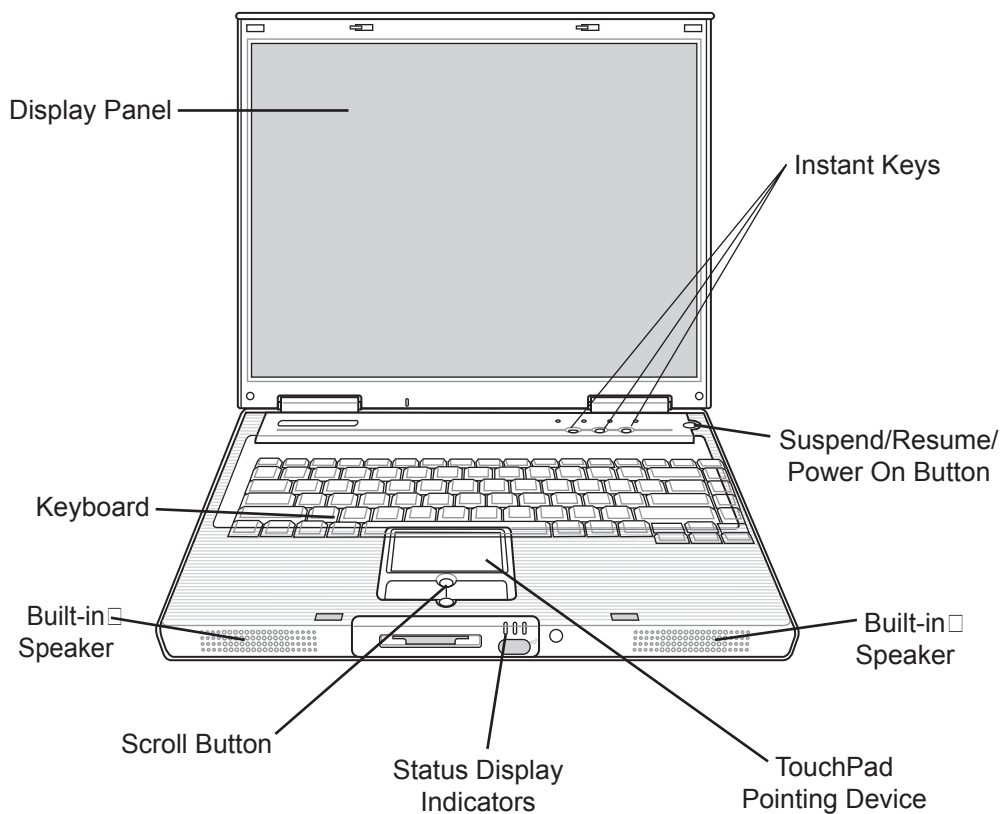

### Display Panel

The display panel is a color LCD panel with back lighting for the display of text and graphics.

### Keyboard

A full-size keyboard with dedicated Windows keys.

### Stereo Speakers

The built-in dual speakers allow for stereo sound.

## **1. BEFORE YOU START**

---

### **Status Display Indicators**

The Status display indicator lights correspond to specific components of your notebook. (See suspend notebook activity without powering off, resume your notebook from suspend mode, and power on your notebook when it has been shut down from Windows. (See *Suspend/Resume/Power On Button in 2-3-1 Power On for more information.*)

### **Touchpad Pointing Device**

The Touchpad pointing device is a mouse-like cursor control with four buttons (left, right, and two scroll buttons).

### **Suspend/Resume/Power On Button**

This button turns your notebook pc on and off as well as put it to sleep. (See *Suspend/Resume/Power On Button in 2-3-1 Power On for more information.*)

### **Instant Keys**

The two instant keys allow you to launch your favorite email and internet applications with the touch of a button.

### 1-2-3 FRONT PANEL COMPONENTS

The following is a brief description of your notebook's front panel components.

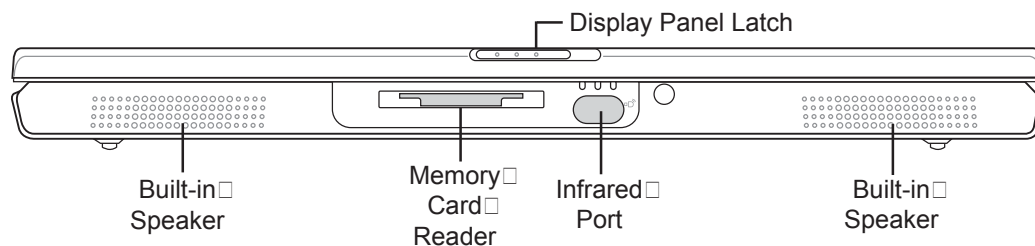

#### **Built-in Stereo Speakers**

The built-in dual speakers allow for stereo sound.

#### **Memory Card Reader**

The memory card reader offers the fastest and most convenient method to transfer pictures, music and data between your notebook PC and flash-compatible devices such as digital cameras, MP3 players, mobile phones, and PDAs.

#### **Infrared Port**

The fast IrDA-compatible port allows you to communicate wirelessly with another IrDA-compatible infrared device without a cable.

#### **Display Panel Latch**

The display panel latch locks and releases the display panel.

## 1. BEFORE YOU START

---

### 1-2-4 LEFT-SIDE PANEL COMPONENTS

The following is a brief description of your notebook's left-side components.

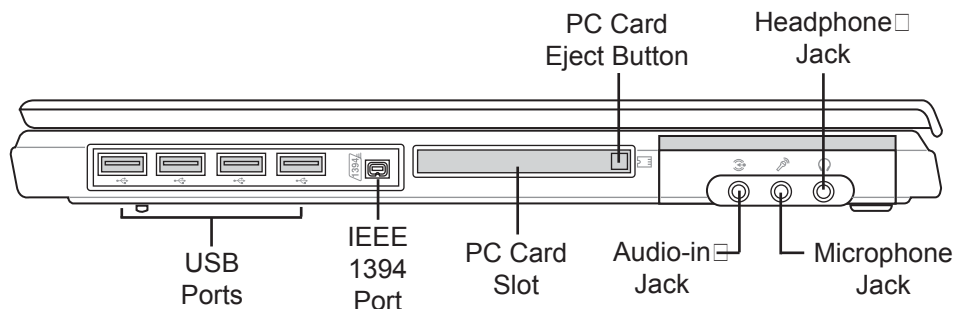

#### USB Ports (V2.0)

The four USB ports allow you to connect Universal Serial Bus devices.

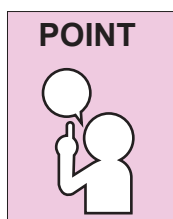

The leftmost USB port is disabled when your notebook PC is connected to an optional Port Replicator.

#### IEEE 1394 Port

The 1394 port is used to connect between your and a peripheral such as a digital video camera.

#### PC Card Slot

The PC Card Slot allows you to install one Type II PC Card.

#### Audio-In Jack

The audio-in jack allows audio sources to be recorded by your computer.

#### Microphone Jack

The microphone jack allows you to connect an external mono microphone.

#### Headphone Jack

The headphone jack allows you to connect headphones or external speakers with amplifier.

## 1-2-5 RIGHT-SIDE PANEL COMPONENTS

The following is a brief description of your notebook's right-side components.

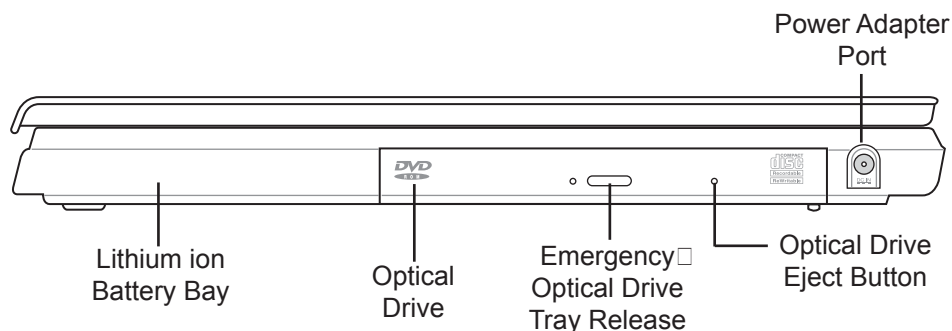

### Lithium ion Battery Bay

The internal battery pack can be removed for installation of a fully charged battery pack. (See *2-1-3 Replacing the Battery* for more information.)

### Optical Drive

The Optical Drive allows you to play back a media disc.

### Optical Drive Eject Button

The Optical Drive Eject Button allows you to open the Optical Drive tray to remove or install a DVD, CD-R, or CD-ROM.

### Emergency Optical Drive Tray Release

The Emergency Optical Drive Tray Release allows you to open the Optical Drive tray without powering on your notebook.

### Power Adapter Port

The power adapter port allows you to plug in the AC adapter to power your notebook and charge the internal Lithium ion battery.

## 1. BEFORE YOU START

---

### 1-2-6 BACK PANEL COMPONENTS

The following is a brief description of your notebook's back panel components.

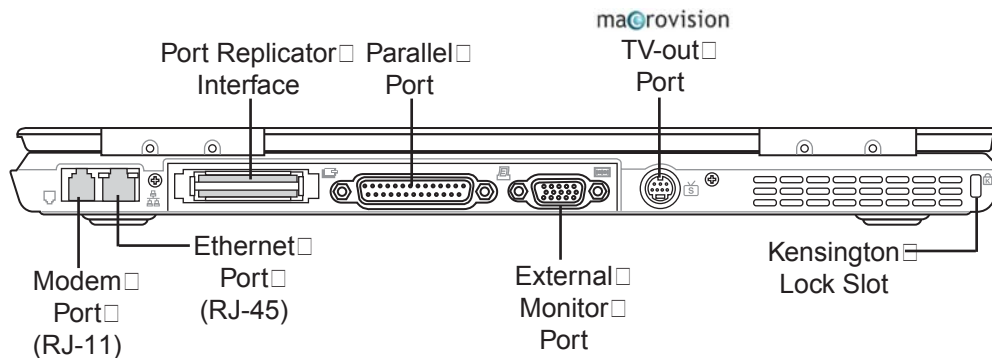

#### Modem (RJ-11) Port

The modem (RJ-11) port is used to attach a telephone line to the internal 56K modem.

#### LAN Port (RJ-45)

The LAN port is designed to support a 10/100/1000 Base-T standard RJ-45 plug.

#### Port Replicator Connector

The Port Replicator connector extends the functionality of your notebook by providing ports to connect PS/2 devices, an external monitor, a serial device, a parallel device, USB devices, a LAN (RJ-45) cable, an external audio source, and an AC adapter.

#### Parallel Port

The parallel port allows you to connect parallel devices, such as a printer. (This is also sometimes referred to as an LPT port.)

#### External Monitor Port

The external monitor port allows you to connect an external monitor.

#### S-Video/TV Out Port

The S-video/TV out port allows you to connect to video devices such as, a television, projector, or a VCR.

### **Kensington Lock Port**

The Kensington lock slot allows you to secure your notebook to an immovable object through an optional security cable.

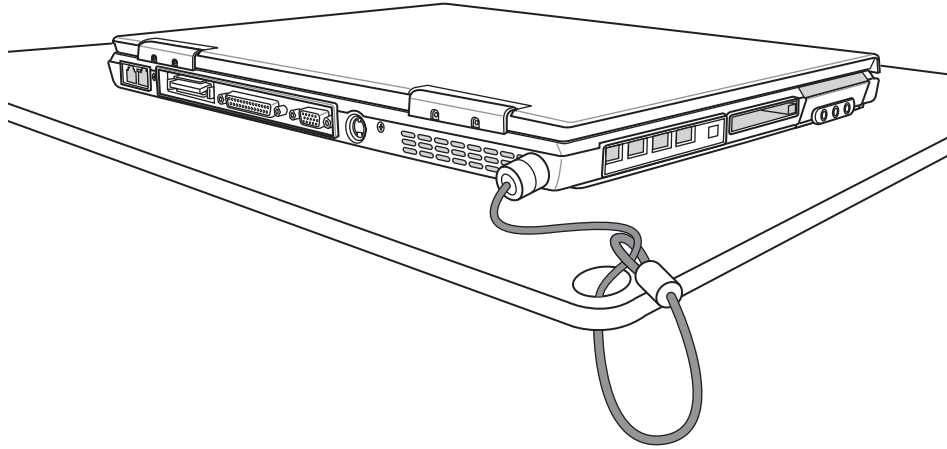

### **1-2-7 BOTTOM COMPONENTS**

The following is a brief description of your notebook's bottom panel components.

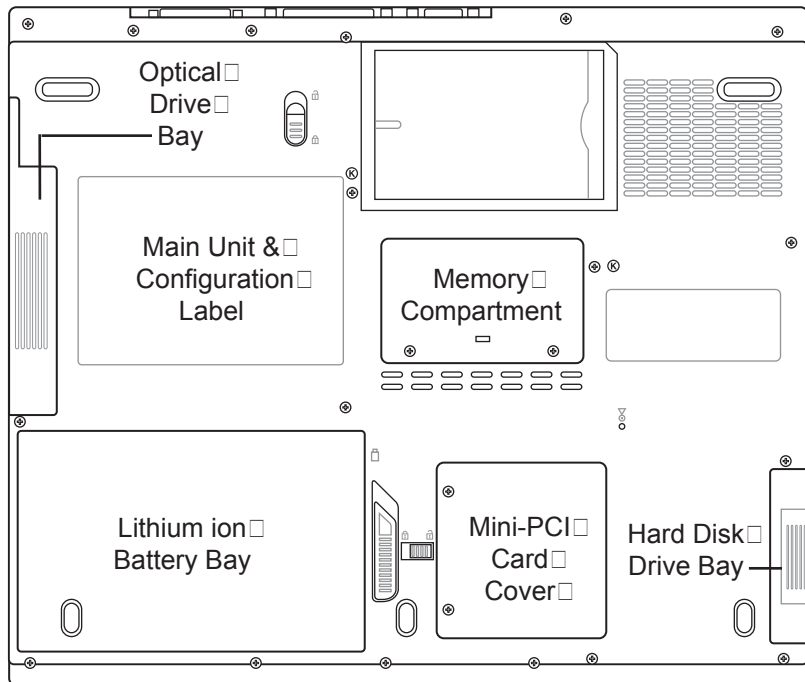



## **1. BEFORE YOU START**

---

### **Optical Drive Bay**

The internal optical drive is accessible through the optical drive bay.

### **Main Unit and Configuration Label**

The configuration label shows the model number and other information about your notebook. In addition, the configuration portion of the label has the serial number and manufacturer information that you will need to give your support representative. It identifies the exact version of various components of your notebook.

### **Memory Compartment**

The memory compartment contains the system RAM.

### **Lithium ion Battery Bay**

The battery bay contains the internal Lithium ion battery. It can be opened for the removal of the battery when stored over a long period of time or for swapping a discharged battery with a charged Lithium ion battery.

### **Hard Disk Drive Bay**

The internal hard disk drive is accessible through the hard disk drive bay.

## 2 GETTING STARTED

---

### 2-1 Power Sources

Your notebook PC has two possible power sources: a primary Lithium ion battery or an AC adapter.

#### 2-1-1 CONNECTING THE POWER ADAPTERS

The AC adapter provides power for operating your notebook PC and charging the batteries.

##### Connecting the AC Adapter

1. Plug the DC output cable into the adapter power port of your notebook PC.
2. Plug the AC adapter into an AC electrical outlet.

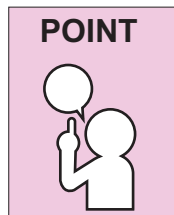

The Lithium ion battery is not charged upon purchase. Initially, you will need to connect the AC adapter to use your notebook PC.

## 2. GETTING STARTED

---

### 2-1-2 RECHARGING THE BATTERY

The Lithium ion battery is recharged internally using the AC adapter. To recharge the battery make sure the battery that needs to be charged is installed in your notebook PC and connect the AC adapter.

There is no memory effect on the Lithium ion battery, therefore you do not need to discharge the battery completely before recharging. The charge times will be significantly longer if your notebook PC is in use while the battery is charging. If you want to charge the battery more quickly, put your notebook PC into Suspend mode, or turn it off while the adapter is charging the battery. (See *2-7 Power Management* for more information on Suspend mode and shutdown procedure)

#### Low Battery State

When the battery is running low, a low battery notification message will appear. If you do not respond to the low battery message, the battery will continue to discharge until it is too low to operate. When this happens, your notebook PC will go into Suspend mode. There is no guarantee that your data will be saved once the notebook reaches this point.

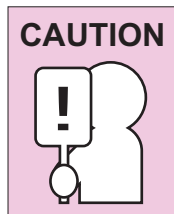

To protect your notebook PC from damage, use only the power adapter that came with the notebook PC because each power adapter has its own power output rating.

Once your notebook PC goes into Dead Battery Suspend mode you will be unable to resume operation until you provide a source of power either from an adapter, or a charged battery. Once you have provided power, you will need to press the Suspend/Resume button to resume operation. In the Dead Battery Suspend mode, your data can be maintained for some time, but if a power source is not provided promptly, the Power indicator will stop flashing and go out, meaning that you have lost the data that was not stored. Once you provide power, you can continue to use your notebook PC while an adapter is charging the battery.

#### Shorted Battery

The Status Indicator panel uses a symbol inside the battery outline of the Battery Level indicator to display the operating level available in that battery. If this display shows a Shorted Battery, it means that the battery is damaged and must be replaced so it does not damage any other parts of your notebook PC.

### 2-1-3 REPLACING THE BATTERY

This notebook PC features a rechargeable bridge battery that allows for fast warm swapping of batteries. All you need is an additional battery and you can have a fully charged spare to swap with one that is not charged without having to close all your applications and powering down your computer.

1. Have a charged battery ready to install.
2. Press [F1] while holding down [FN] to place your notebook PC in suspend mode and disconnect the AC adapter.

#### POINT



The bridge battery maintains memory in suspend mode for up to 5 minutes, more than enough time for you to swap batteries.

Charge your notebook PC for at least 24 hours before using it for the first time. Doing so insures that the bridge battery is fully charged so that no data is lost during a warm swap.

3. Slide the battery release latch while pulling the battery from the bay.
4. Remove the battery from the bay.
5. Slide the new battery into the bay. The pins will automatically align with the connector.
6. Press the battery in until the battery release latch snaps into place.
7. Plug in the AC adapter and press the resume/suspend/power on button.

#### CAUTION

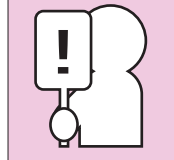

If the Lithium ion battery connector is not fully seated, you may not be able to use your notebook PC or charge your battery.

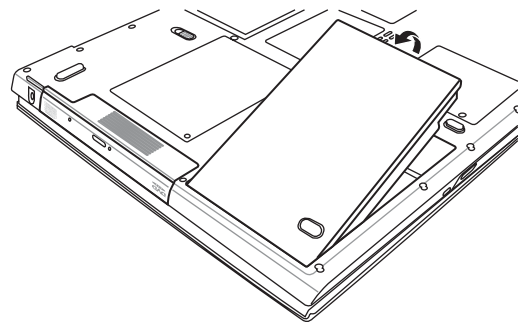
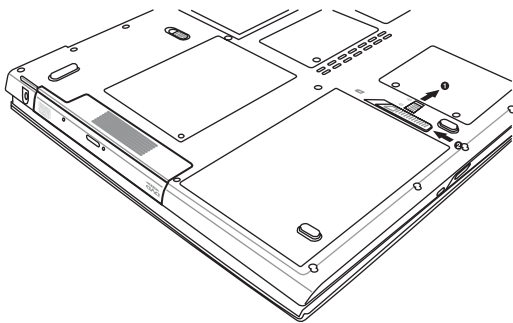

## 2. GETTING STARTED

---

### 2-2 Display Panel

Your notebook PC contains a display panel that is backlit for easier viewing in bright environments and maintains top resolution through the use of active-matrix technology.

#### 2-2-1 OPENING THE DISPLAY PANEL

1. Slide the latch located at the top of the display panel to the right. This releases the locking mechanism and raises the display slightly.
2. Lift the display backwards, being careful not to touch the screen, until it is at a comfortable viewing angle.

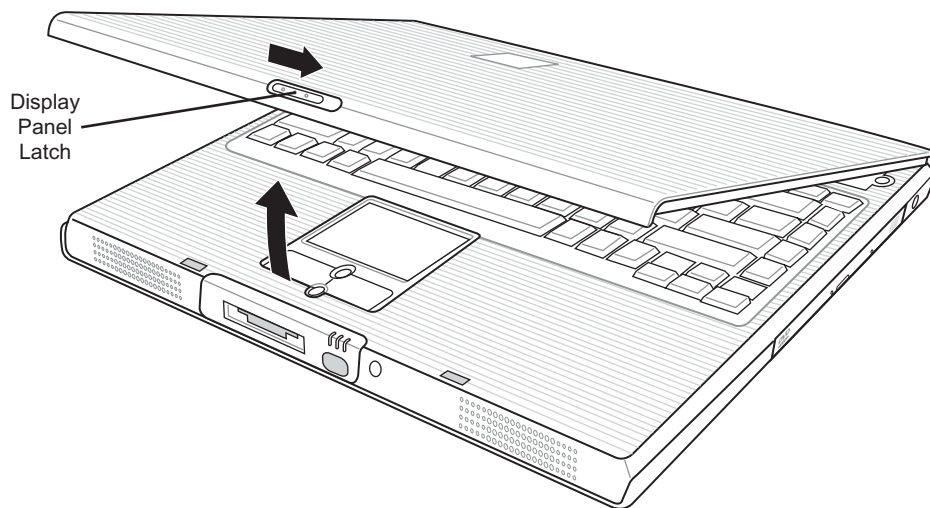

### 2-2-2 ADJUSTING DISPLAY PANEL BRIGHTNESS

Once you have turned on your notebook PC, you may want to adjust the brightness level of the screen to a more comfortable viewing level. There are two ways to adjust the brightness, keyboard and power management utility.

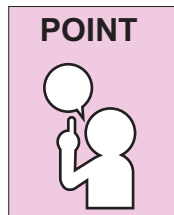

The higher the brightness level, the more power the notebook PC will consume and the faster your batteries will discharge. For maximum battery life, set the brightness to as low a level as possible.

#### Keyboard

Adjusting the brightness using the keyboard changes the setting only temporarily.

- [FN+F4]: Pressing repeatedly will lower the brightness of your display.
- [FN+F5]: Pressing repeatedly will increase the brightness of the display.

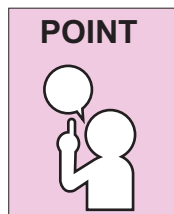

If using AC power, your brightness setting is set to its highest level by default. If using battery power, your brightness settings is set to approximately mid-level by default.

### 2-2-3 CLOSING THE DISPLAY PANEL

1. Holding the edge of your display panel, pull it forward until it is flush with the body of your notebook.
2. Push down until you hear a click. This will engage the locking mechanism and prevent your display panel from opening unexpectedly.

### 2-3 Starting Your Notebook PC

#### 2-3-1 POWER ON

##### Suspend/Resume/Power On Button

The suspend/resume/power on switch is used to turn on your notebook from its off state. Once you have connected your AC adapter or charged the internal Lithium ion battery, you can power on your notebook.

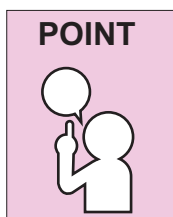

When you turn on your notebook be sure you have a power source. This means that either the battery is installed and charged, or that the AC adapter is connected with AC power.

Press the suspend/resume/on button located above the keyboard to turn on your notebook. If you need to take an extended break, you may either place it in Suspend mode (*See 2-7-2 Suspend Mode for more information*) or turn it off directly (*See 2-7-6 Power Off for more information*).

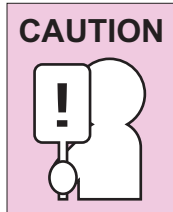

Do not carry your notebook around with the power on or subject it to shocks or vibration, as you risk damaging your notebook.

When you power on your notebook, it will perform a Power On Self Test (POST) to check the internal parts and configuration for correct functionality. If a fault is found, your notebook PC will emit an audio warning and/or an error message will be displayed. Depending on the nature of the problem, you may be able to continue by starting the operating system or by entering the BIOS setup utility and revising the settings.

After satisfactory completion of the Power On Self Test (POST), your notebook will load your operating system.

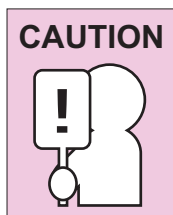

Never turn off your notebook during the Power On Self Test (POST) or an unrecoverable error may occur.

### **2-3-2 BOOT SEQUENCE**

The procedure for starting-up your notebook is termed the Bootup sequence and involves your notebook's BIOS. When your notebook is turned on for the first time, the main system memory is empty, and it needs to find instructions to start up your notebook. This information is stored in the BIOS program. Each time you power on or restart your notebook, it goes through a boot sequence which displays a flash screen until your operating system is loaded. During booting, your notebook is performing a standard boot sequence including a Power On Self Test (POST). When the boot sequence is completed without a failure and without a request for the BIOS Setup Utility, the system displays the operating system's opening screen.

The boot sequence is executed when:

- You turn on the power to your notebook.
- You restart your notebook from the Windows Shut Down dialog box.
- The software initiates a system restart. Example: When you install a new application.

### **2-3-3 BIOS SETUP UTILITY**

The BIOS Setup Utility is a program that sets up the operating environment for your notebook. Your BIOS is set at the factory for normal operating conditions, therefore there is no need to set or change the BIOS environment to operate your notebook.

The BIOS Setup Utility configures:

- Device control feature parameters, such as changing I/O addresses and boot devices.
- SystemData Security feature parameters, such as passwords.

#### **Entering the BIOS Setup Utility**

To enter the BIOS Setup Utility, do the following:

1. Turn on or restart your notebook.
2. Press the [F2] key once the flash screen appears on the screen. This will open the main menu of the BIOS Setup Utility with the current settings displayed.
3. Press the [RIGHT ARROW] or [LEFT ARROW] key to scroll through the other setup menus to review or alter the current settings.



## 2. GETTING STARTED

---

### 2-4 Status Display Indicators

The Status Display Indicator LEDs correspond to specific components of your notebook. These lights (when visible) tell you that those components are operating. There are two additional lights on the front edge of the system to indicate battery and power states.

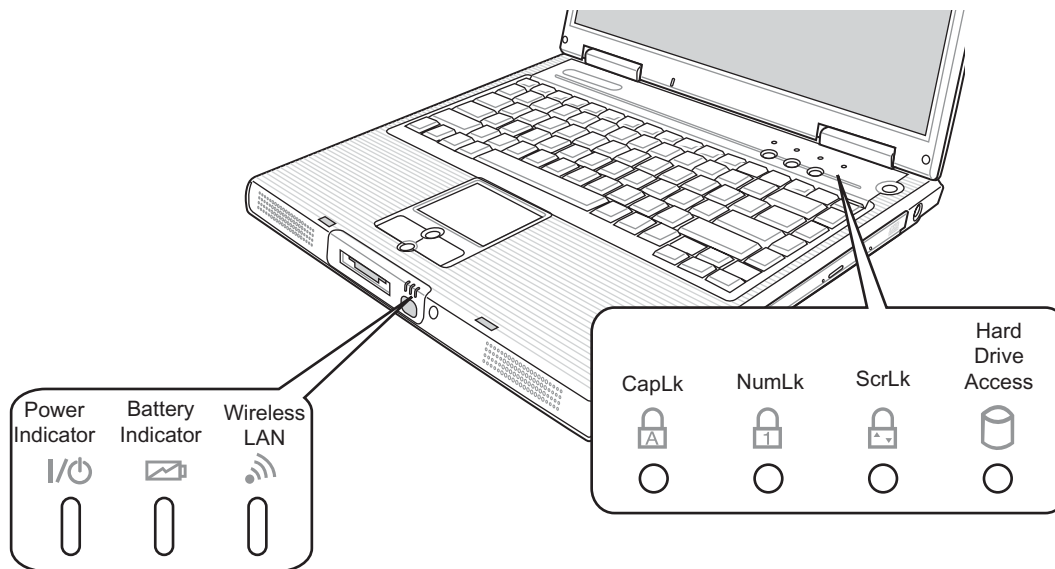

#### 2-4-1 POWER INDICATOR

The Power indicator symbol states whether your system is powered on. It has several different states, each state indicates your notebook's operating mode.

- **Steady On:** This means that there is power to your notebook and that it is ready for use.
- **Flashing:** This means that your notebook is in Suspend mode.
- **Steady Off (not visible):** This means that your system is either in Save-to-Disk mode, or that your notebook has been turned off with the power switch.

If you are charging your battery, the Power indicator symbol will remain on even if your notebook is shut off. The Power indicator symbol will also remain on if you have either adapter connected and are shut down from Windows, but have not turned off the power switch.

### 2-4-2 BATTERY INDICATOR

The Battery indicator tells you whether the primary Lithium ion battery is charging or fully charged.

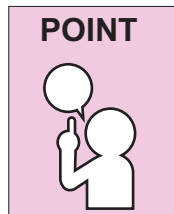

If there is no battery activity, the power adapters are not connected, or the power switch is Off, the Battery indicator will also be off.

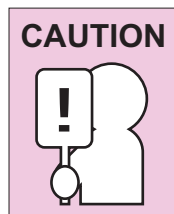

Batteries subjected to shocks, vibration or extreme temperatures can be permanently damaged.

### 2-4-3 WIRELESS CONNECTION INDICATOR

The Wireless Connection indicator states whether your notebook PC is connected to a wireless network.

### 2-4-4 CAPSLOCK INDICATOR

The CapsLock indicator states that your keyboard is set to type in all capital letters.

### 2-4-5 NUMLK INDICATOR

The NumLk indicator states that the internal keyboard is set in ten-key numeric keypad mode.

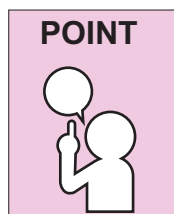

If you are using the optional external numerical keypad, pressing the [NumLk] key will activate the external keypad. The indicator will come on, however it will not change any of the functionality of your keyboard keys.

## **2. GETTING STARTED**

---

### **2-4-6 SCRLK INDICATOR**

The ScrLk indicator states that your scroll lock is active.

### **2-4-7 HARD DRIVE ACCESS INDICATOR**

The Hard Drive Access indicator states whether your internal hard drive is being accessed.

## 2-5 Using the Keyboard

Your notebook has an integral 87-key keyboard. The keys perform all the standard functions of a 101-key keyboard, including the Windows keys and other special function keys. This section describes the following keys.

- Numeric keypad
- Cursor keys
- Function keys
- Windows keys

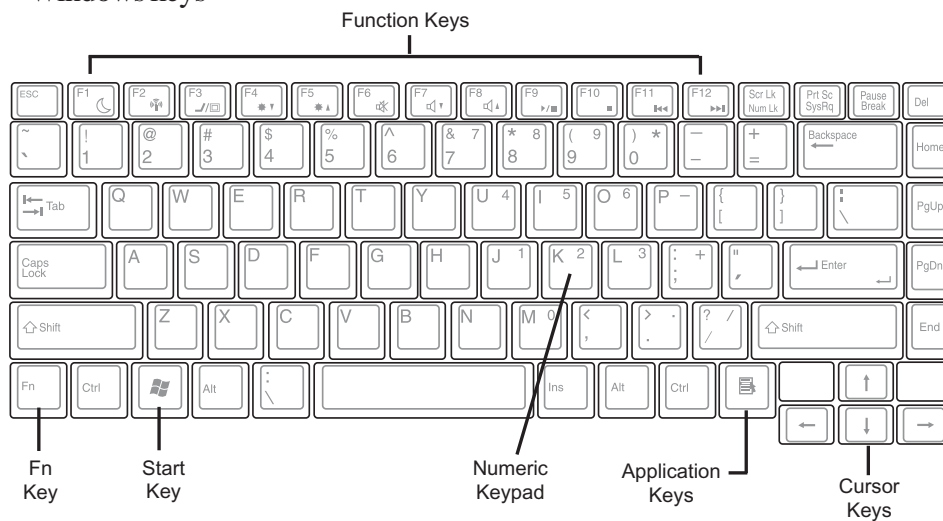

### 2-5-1 NUMERIC KEYPAD

Certain keys on the keyboard perform dual functions as both standard character keys and numeric keypad keys. NumLk can be activated by pressing the [NumLk] keys. Turning off the NumLk feature is done the same way. Once this feature is activated you can enter numerals 0 through 9, perform addition (+), subtraction (-), multiplication (\*), or division (/), and enter decimal points (.) using the keys designated as ten-key function keys. The keys in the numeric keypad are marked on the front edge of the key to indicate their secondary functions.

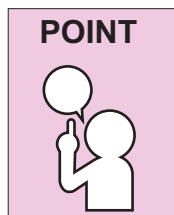

If you are using the optional external numerical keypad, pressing the [NumLk] key will activate the external keypad. The indicator will come on, however it will not change any of the functionality of your keyboard keys.

## **2. GETTING STARTED**

---

### **2-5-2 WINDOWS KEYS**

Your notebook has three Windows keys, consisting of two Start keys and an Application key. The two Start keys display the Start menu. This button functions the same as your on-screen Start menu button. The Application key functions the same as your right mouse button and displays shortcut menus for the selected item. (Please refer to your Windows documentation for additional information regarding the Windows keys.)

### **2-5-3 CURSOR KEYS**

The cursor keys are the four arrow keys on the keyboard which allow you to move the cursor up, down, left and right in applications. In programs such as Windows Explorer, it moves the “focus” (selects the next item up, down, left, or right).

### **2-5-4 FUNCTION KEYS**

Your notebook PC has 12 function keys, F1 through F12. The functions assigned to these keys differ for each application. You should refer to your software documentation to find out how these keys are used.

The [FN] key provides extended functions for the notebook and is always used in conjunction with another key.

- [FN+F1]: Pressing [F1] while holding [FN] will toggle the notebook between suspend mode and active mode
- [FN+F2]: Pressing [F2] while holding down [FN] allows you to toggle between enabling and disabling wireless network connection.
- [FN+F3]: Pressing [F3] while holding [FN] allows you to change your selection of where to send your display video. Each time you press the combination of keys you will step to the next choice. The choices, in order, are: built-in display panel only, both built-in display panel and external monitor, or external monitor only.
- [FN+F4]: Pressing [F4] repeatedly while holding [FN] will lower the brightness of your display.
- [FN+F5]: Pressing [F5] repeatedly while holding [FN] will increase the brightness of the display.
- [FN+F6]: Pressing [F6] while holding [FN] will toggle the Audio Mute on and off.
- [FN+F7]: Pressing [F7] repeatedly while holding [FN] will decrease the volume of your notebook PC.

- [FN+F8]: Pressing [F8] repeatedly while holding [FN] will increase the volume of your notebook PC.
- [FN+F9]: Pressing [F9] while holding down [FN] allows you to toggle between playing and pausing your optical drive.
- [FN+F10]: Pressing [F10] while holding [FN] stops your optical drive.
- [FN+F11]: Pressing [F11] while holding [FN] to go back to the previous file.
- [FN+F12]: Pressing [F12] while holding [FN] to go to the next file.

## 2-6 Volume Control

Your notebook has multiple volume controls which interact with each other.

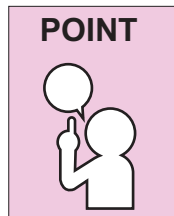

Any software that contains audio files will also contain a volume control of its own. If you install an external audio device that has an independent volume control, the hardware volume control and the software volume control will interact with each other. It should be noted that if you set your software volume to Off, you will override the external volume control setting.

### 2-6-1 CONTROLLING THE VOLUME

- The volume can be controlled in several different ways:
- Volume can be set from within the Volume Control on the Taskbar.
- Volume can be controlled with the [F7] and [F8] functions keys. Pressing [F7] repeatedly while holding [Fn] will decrease the volume of your notebook. Pressing [F8] repeatedly while holding [Fn] will increase the volume of your notebook.
- Volume can be controlled by many volume controls that are set within individual applications.
- Certain external audio devices you might connect to your system may have hardware volume controls. Each source discussed above puts an upper limit on the volume level that must then be followed by the other sources.

We recommend that you experiment with the various volume controls to discover the optimal sound level.

### 2-7 Power Management

Your notebook has many options and features for conserving battery power. Some of these features are automatic and need no user intervention. However, others depend on the parameters you set to best suit your operating conditions.

#### 2-7-1 SUSPEND/RESUME/POWER ON BUTTON

When your notebook is active, the Suspend/Resume/Power On button can be used to manually put your notebook into Suspend mode. Push the Suspend/Resume/Power On button when your notebook is active, but not actively accessing anything, and immediately release the button. You will hear two short beeps and your system will enter Suspend mode.

If your notebook is suspended, pushing the Suspend/Resume/Power On button will return your notebook to active operation. You can tell whether or not your system is in Suspend mode by looking at the Power icon on the Status LCD Panel. (*See 2-4 Status Display Indicators for more information.*)

If the indicator is visible and not flashing, your notebook is fully operational. If the indicator is both visible and flashing, your notebook is in Suspend mode. If the indicator is not visible at all, the power is off or your notebook is in Hibernation (Save-to-Disk) mode. (*See 2-7-3 Hibernation Feature*)

#### 2-7-2 SUSPEND MODE

Suspend or Standby mode saves the contents of your notebook's system memory during periods of inactivity by maintaining power to critical parts. This mode will turn off the CPU, the display, the hard drive, and all of the other internal components except those necessary to maintain system memory and allow for restarting. Your notebook can be put in Suspend mode by:

- Pressing the Suspend/Resume/Power On button when your system is turned on.
- Selecting Standby from the Windows Shut Down menu.
- Timing out from lack of activity.
- Allowing the battery to reach the Dead Battery Warning condition.

Your notebook's system memory typically stores the files on which you are working, opens applications information, and any other data required to support the operations in progress. When you resume operation from Suspend mode, your notebook will return to the point where it left off. You must use the Suspend/Resume/Power On button to resume operation, and there must be an adequate power source available, or your notebook will not resume.

### 2-7-3 HIBERNATION (SAVE-TO-DISK) FEATURE

The Hibernation (Save-to-Disk) feature saves the contents of your notebook's system memory to the hard drive as a part of the Suspend/Resume mode. You can enable or disable this feature.

#### Enable or Disable the Hibernation Feature

The default settings are not enabled for Windows 98 Second Edition or Windows 2000 Professional; Hibernation is the default setting for Windows XP. To enable or disable the Hibernation feature, follow these steps:

1. From the Start menu, select **Settings**, and then select **Control Panel**.
2. From the Control Panel, select **Power Options**.
3. Select the **Hibernation** tab. Select the box to enable or disable this feature.

#### Using the Hibernation Feature

1. From the Start menu, select **Settings**, then select **Control Panel**.
2. From the Control Panel, select **Power Options**.
3. Select the **Advanced** tab. Select **Hibernate** from the pull down menu for Power buttons.

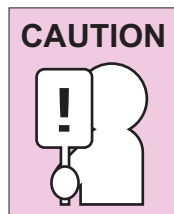

The Suspend or Hibernation (Save-to-Disk) mode should not be used with certain PC Cards. Check your PC Card documentation for more information.



## **2. GETTING STARTED**

---

### **2-7-4 STANDBY MODE**

Standby mode is one of the power management parameters. When Standby mode is activated, your notebook shuts off the display and turns off the hard drive when there is no activity (keystroke, pointer action, sound generation, video display change, modem transmission or reception, etc.) on your notebook for the user-selected Standby timeout period. Any activity will cause your notebook to return to normal operation automatically. This feature is independent of the Suspend/Resume/Power On button.

### **2-7-5 DISPLAY TIMEOUT**

The Video Timeout is one of the power management parameters. This feature saves power by turning off the display if there is no keyboard or pointer activity for the user selected timeout period. Any keyboard or pointer activity will cause the display to restart automatically.

### **2-7-6 POWER OFF**

Before turning off the power by choosing Shut Down from Windows, check that the Hard Drive, optical drive drive, PC Card and Floppy Disk Drive Access indicators are all OFF. If you turn off the power while accessing a disk or PC Card, there is a risk of data loss. To ensure that your notebook shuts down without error, use the Windows shut down procedure.

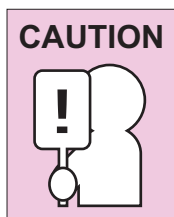

Turning off your notebook without exiting Windows or turning on your notebook within 10 seconds of the notebook being shut off may cause an error when you start the next time.

## 3 USING YOUR NOTEBOOK PC

---

### 3-1 Touchpad Pointing Device

The Touchpad pointing device comes built into your notebook PC. It is used to control the movement of the pointer to select items on your display panel. The Touchpad is composed of a cursor control, a left and right button, and a scrolling button. The cursor control works the same way a mouse does, and moves the cursor around the display. It only requires light pressure with the tip of your finger. The left and right buttons function the same as mouse buttons. The actual functionality of the buttons may vary depending on the application that is being used. The scrolling button allows you to navigate quickly through pages, without having to use the scroll bars.

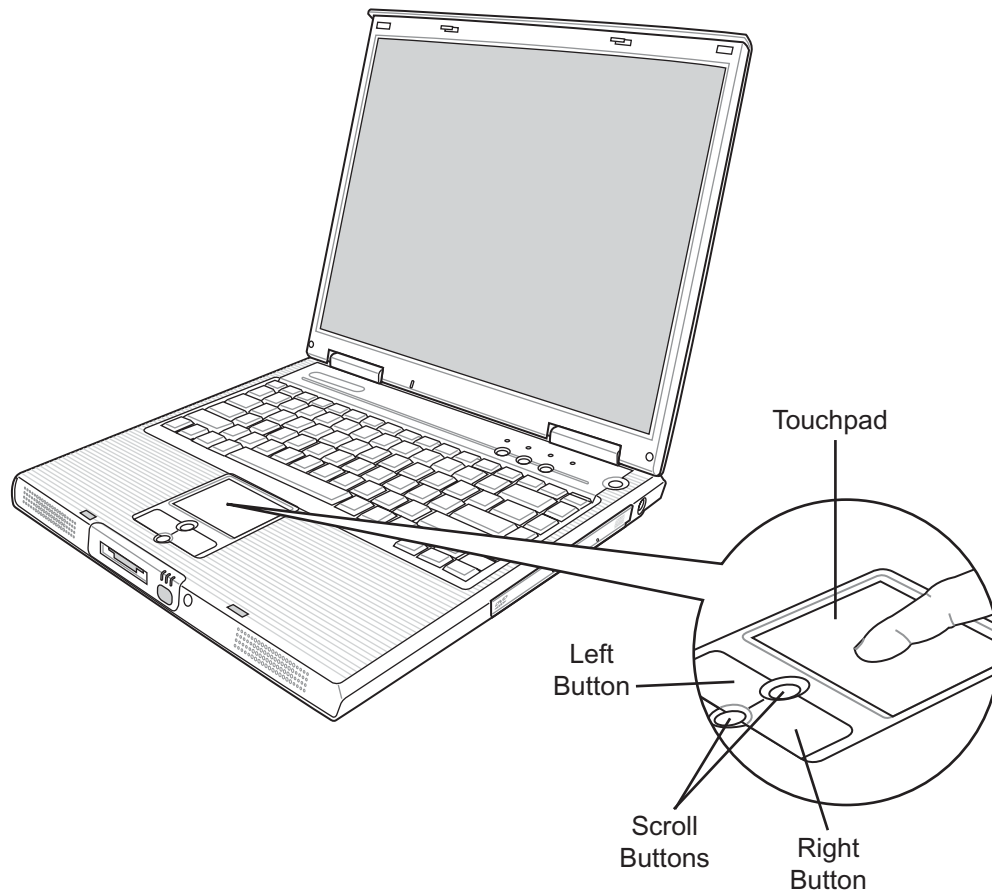

## 3. Using Your Notebook PC

---

### 3-1-1 CLICKING

Clicking means pushing and releasing a button. To left-click, move the cursor to the item you wish to select, press the left button once, and then immediately release it. To right-click, move the mouse cursor to the item you wish to select, press the right button once, and then immediately release it. You also have the option to perform the clicking operation by tapping lightly on the Touchpad once.

### 3-1-2 DOUBLE-CLICKING

Double-clicking means pushing and releasing the left button twice in rapid succession. This procedure does not function with the right button. To double-click, move the cursor to the item you wish to select, press the left button twice, and then immediately release it. You also have the option to perform the double-click operation by tapping lightly on the Touchpad twice.

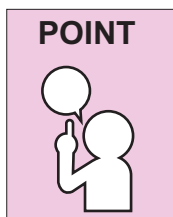

If the interval between clicks is too long, the double-click will not be executed.

Parameters for the Touchpad can be adjusted from the Mouse Properties dialog box located in the Windows Control Panel.

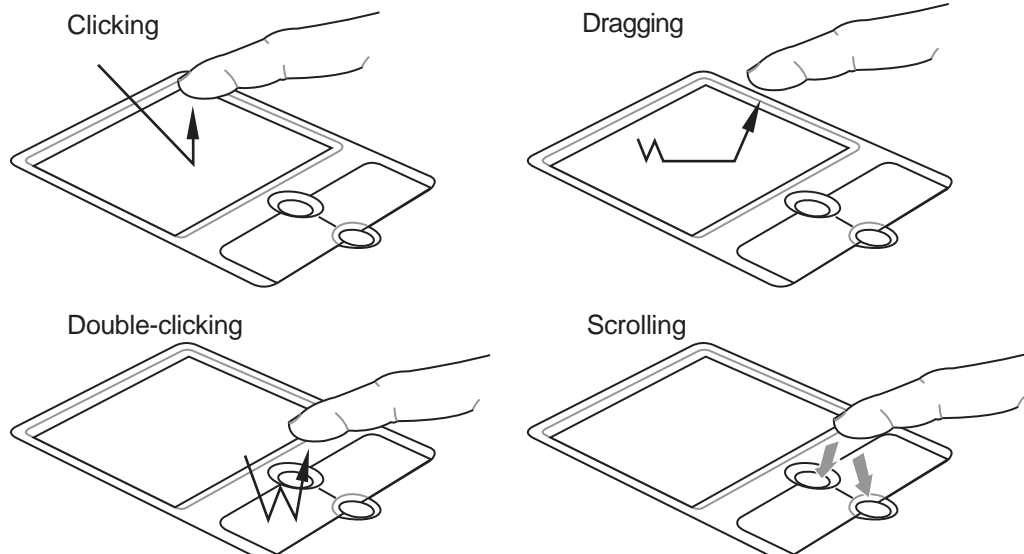

### 3-1-3 DRAGGING

Dragging means pressing and holding the left button, while moving the cursor. To drag, move the cursor to the item you wish to move. Press and hold the left button while moving the item to its new location and then release it. Dragging can also be done using the Touchpad. First, tap the Touchpad twice over the item you wish to move making sure to leave your finger on the pad after the final tap. Next, move the object to its new location by moving your finger across the Touchpad, and then release your finger.

Using the Scrolling button allows you to navigate through a document quickly without using the window's scroll bars. This is particularly useful when you are navigating through on-line pages. To use the Scrolling button, press the top or bottom of the button

## 3-2 Memory Card Reader

Your notebook PC is equipped with a memory card reader that can read and write to seven different popular digital media - CF-I, CF-II, SmartMedia™, Memory Stick™, Micro Drive™, MultimediaCard™, and Secure Digital Card™. With this 7-in-1 reader, you can easily transfer data to your notebook PC from digital cameras, digital camcorders, PDAs, MP3 players, digital voice recorders and more.

### 3-2-1 INSERTING A MEMORY CARD

Depending on the type of memory card, you may need to insert it into the reader conducting plate/label side up or down.

| <b>Memory Type</b>            | <b>Insert</b>            |
|-------------------------------|--------------------------|
| MicroDrive, CompactFlash I/II | label side up            |
| SmartMedia                    | conducting plate side up |
| MemoryStick                   | label side down          |
| SecureDigital/MultiMedia      | label side up            |

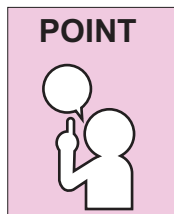

Inserting your memory card incorrectly may cause your system to slow down or even hang up. If that happens, restart your system and insert the card correctly.

#### 3-2-2 REMOVING A MEMORY CARD

To remove the memory card from the reader, follow these simple steps:

1. Locate the drive icon for your memory card reader.
2. Right-click the icon and select **Eject**.
3. Remove memory card from the reader.



Physically removing the memory card before it is ejected may result in data loss.

#### 3-3 Optical Drive

Depending upon the configuration of your notebook PC, you may have one of the following drives:

- CD-ROM
- DVD
- DVD/CD-RW combo
- DVD-RW

ADVD player gives you access to movie, software, data, and audio DVD/CDs. A CD-RW player allows you to access software, data, or audio CDs, and to write data onto recordable CDs. ADVD-RW gives you access to movie, software, data, and audio DVD/CDs, and to write data onto recordable CDs.

### 3-3-1 OPTICAL DRIVE SOFTWARE

*DVD Model only:* With the optical drive and Optical Drive software you can play DVD movies on your notebook PC. The optical drive includes controls which allow you to take full advantage of the features of a DVD movie, as well as standard features such as fast forward, fast reverse, pause, etc.

*DVD/CD-RW Model only:* With this optical drive, you can read audio CDs, play DVD movies, and write data onto a recordable CD-R or CD-RW disc. In addition to the Optical Drive software, you also receive software for burning CDs. If you should need to install your Optical Drive software, refer to the applicable readme file on the Driver Applications CD-ROM.

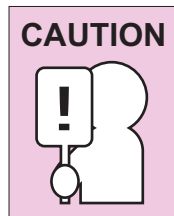

Do not operate your optical drive unless your notebook PC is sitting on a flat surface. Using a drive when the system is not level may damage the drive or prevent proper operation.

Prolonged use of the optical drive, such as watching a DVD movie, will substantially reduce the battery life if no other power source is attached.

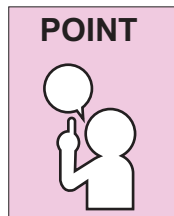

You should periodically check updated drivers.

The DVD player is set to play DVD titles with region code number 1 which is specified for the North American market. The region number is a regional restriction code defined by the DVD Forum acting on the requirements of Hollywood. Different region codes are recorded on video DVD titles for publication in different areas of the world. If the regional code of the DVD player does not match the regional codes on the titles, then playback is impossible.

### 3. Using Your Notebook PC

---

#### 3-3-2 LOADING A CD, DVD, CD-R, OR CD-RW

To load a disc into your optical drive drive, follow these steps:

1. Push and release the eject button on the front of the optical drive drive to open the holder tray. The tray will come out of the notebook PC a short distance.
2. Gently pull the tray out until a media disc can easily be placed in the tray.
3. Place the media into the tray, label side up, with the hole in the center of the disc. Snap the disc onto the raised circle in the center of the tray.
4. Gently push the holder tray back in until you hear a click.

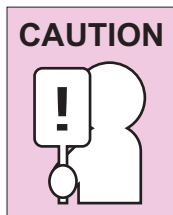

There may be a protective sheet in the tray from when it was shipped; please make sure it is removed before operating the drive.

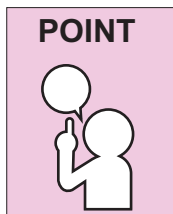

If you have disabled the Auto Insert Notification Function, you will have to start the drive from your desktop, since your notebook PC will not automatically recognize that media has been loaded.

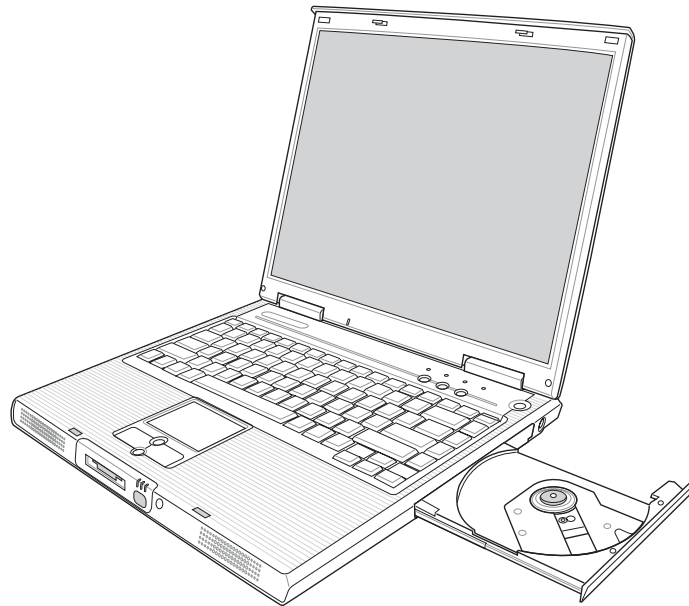

### 3-3-3 REMOVING MEDIA

1. Push and release the eject button on the front of the optical drive drive. This will stop the drive and the holder tray will come out of the notebook PC a short distance.
2. Gently pull the tray out until the disc can easily be removed from the tray.
3. Carefully remove the media disc from the holder tray.
4. Gently push the holder tray back in until you hear a click.

### 3-3-4 EMERGENCY TRAY RELEASE

In the event the media tray does not open after pressing the Optical Drive Eject button, it may be necessary to use the emergency tray release button.

### 3-3-5 USING THE OPTICAL DRIVE SOFTWARE

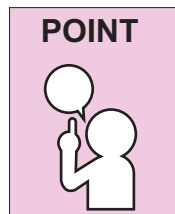

Depending upon its configuration, your system may not have the optical drive software pre-installed. If it is not installed, reference the documentation that accompanies the media application.

#### Starting a DVD Movie (DVD Models only)

1. Insert the DVD movie into the optical drive drive of your notebook PC. If the CD AutoRun feature activates, skip Step 2.
2. From the Start menu, select **Programs**, then locate the DVD player software that you installed from the application CD that accompanied your notebook PC.
3. Click **OK** to close the About DVD Player Performance dialog box, and the movie will begin.

#### Opening the Optical Drive Control Panel

With most DVD-ROMs, you have the option of altering how the movie should play and what you wish to view. You can do this by using the Optical Drive control panel and the mouse.

1. Right-click on the movie screen to open a dropdown menu for options.
2. Select **View**, then **Player** for all the controls available. This will open the control panel into the bottom of the screen.



### 3. Using Your Notebook PC

---

#### 3-3-6 USING DOLBY™ HEADPHONE

The Dolby Headphone utility lets you enjoy multi-channel sound sources, such as DVD movies, with realistic surround sound using your *conventional* stereo headphones. The Dolby Headphone is a utility that is available in the DVD player software.

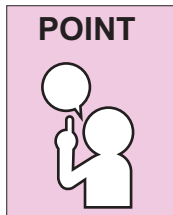

##### POINT

Media discs which do not have the Dolby Surround 5:1 symbol will not support Dolby Headphone.

After making changes to the Dolby Headphone feature and clicking OK, wait at least ten seconds before making another change in order to allow the system to stabilize.

To use the Dolby Headphone feature, perform the following steps:

1. Double click the DVD player application icon on your desktop.
2. On the toolbar that appears, click the **Properties** button (the fourth button from the left, with the image of a wrench).
3. On the Properties window, select the **Dolby Headphone** tab.
4. To enable Dolby Headphone, check the **Enable Dolby Headphone** box. To change the type of surround sound, select one of the radio buttons listed under Room Filter Setting.
5. Click **OK**. The Dolby Headphone feature will now be enabled until you disable it by unchecking Enable Dolby Headphone.

#### 3-3-7 USING THE OPTICAL DRIVE ON BATTERY POWER

Since optical drive drives consume a lot of power, your overall battery life will be significantly shorter when operating the optical drive drive continuously (such as watching a DVD movie) than during standard operation. Many movies run-times are longer than your notebook PC can support on a single charged battery. If you are watching a DVD movie on battery power you may need to swap in an additional, charged battery or attach AC power during the movie to view it in its entirety.

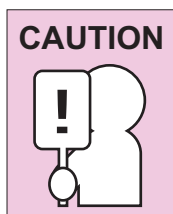

##### CAUTION

Prolonged use of the optical drive drive, such as watching a DVD movie, will substantially reduce your notebook PC's battery life.

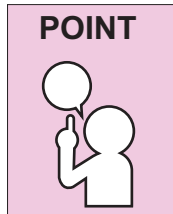

Many movie run-times are longer than your system can support on a single battery. If you are watching a DVD movie on battery power you may need to swap in an additional, charged battery or attach AC power during the movie to view it in its entirety.

An additional fully-charged battery is highly recommended if you will be watching DVD movies on battery power.

#### To Watch a Movie on Battery Power:

1. Have an additional fully-charged battery or your AC adapter ready for use.
2. Start watching your DVD movie.
3. When the low battery warning occurs, immediately stop the movie and exit the optical drive.

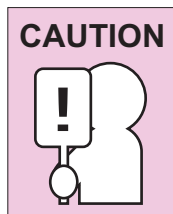

If you do not stop the optical drive quickly and the notebook PC attempts to auto-suspend (critical battery low state) the notebook PC will shut down improperly. If this occurs, you will need to perform a hard reset and follow the instruction, if any, presented to you before the system will reboot.

4. Manually place your notebook PC into suspend mode by depressing the Suspend button and replace the discharged battery with an additional full-charged battery. Or, if you do not have an additional battery, you may attach AC power as soon as you see the low battery warning.
5. Resume your notebook PC by pressing the **Suspend** button again. This step is not required if you attached AC power without entering suspend mode.
6. Restart your optical drive, locate and skip to the chapter of the movie you were last watching.
7. Continue watching your DVD movie.

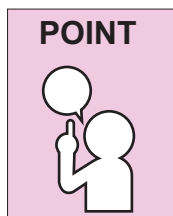

Some shorter DVD movies may not require you to swap batteries or attach AC power to complete them. However, it is best to be prepared since actual battery life while operating the optical drive cannot be guaranteed.

#### 3-3-8 AUTO INSERT NOTIFICATION FUNCTION

The Auto Insert Notification function allows your notebook PC to automatically start a DVD/CD as soon as it is inserted in the optical drive drive and the tray is closed. Your notebook PC will begin playing an audio DVD/CD or will start an application if the DVD/CD includes an auto run file.

#### Disabling Auto Insert Notification Function

To disable the Auto Insert Notification function, follow these easy steps:

1. Save all data and close all open applications.
2. From the Start menu, select **Settings**, and then select **Control Panel**.
3. Double-click the **System** icon. This will open the System Properties dialog box.
4. Select the **Device Manager** tab to display the device lists for your notebook PC.
5. Click on the + to the left of the CD player drive icon. The treeview will expand to show the optical drive drive manufacturer's name and model number.
6. Double-click on the optical drive drive manufacturer's name and model number. This will open the optical drive drive manufacturer's name and model number dialog box.
7. Select the **Settings** tab and then remove the check mark in the Auto Insert Notification box to turn it off.
8. Click **OK**.
9. Click **Close** in the System Properties dialog box, then click **Yes** in the System Settings Change pop-up window when it asks you to restart your machine and activate this change.

The Auto Insert Notification function can be re-activated by repeating this process and placing a check mark in the Auto Insert Notification box to turn it back on.

## 3-4 PC Cards

Your notebook PC supports Type II PC Cards, which can perform a variety of functions depending on which type of PC Card you install. You can install one PC Card at a time in your notebook PC. Make sure that the PC Card conforms to PCMCIA 2.1 or CardBus standards.

For further information, refer to the instructions supplied with your PC Card.

### 3-4-1 INSTALLING PC CARDS

PC Cards are installed in the PC Card slot. To install a PC Card(s), follow these easy steps:



Installing or removing a PC Card(s) during your notebook PC's shutdown or bootup process may damage the card and/or your notebook PC.

Do not insert a PC Card into a slot if there is water or any other substance on the card as you may permanently damage the card, your notebook PC, or both.

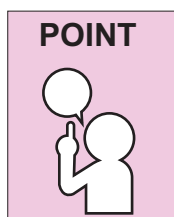

You may be required to log on as an Administrator or a member of the Administrator's Group to complete this procedure. If your computer is connected to a network, network policy settings may also prevent you from completing this procedure.

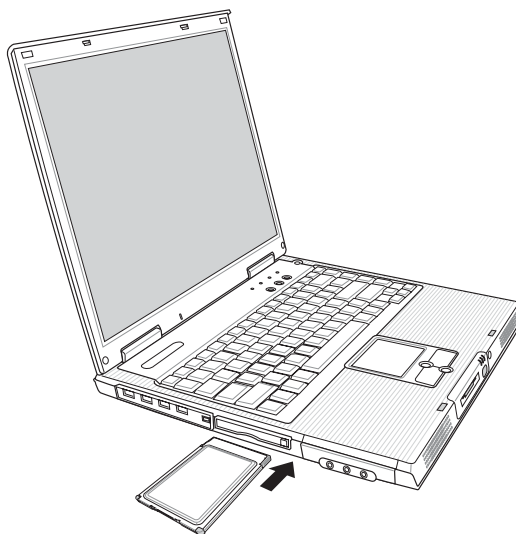

### 3. Using Your Notebook PC

---

1. See your PC Card manual for specific instructions on the installation of your card. Some PC Cards may require your notebook PC to be OFF while installing them.
2. Make sure there is no PC Card currently in the slot. If there is, see **3-4-2 Removing PC Cards**.
3. If the eject button is extended, press it in until it clicks.
4. Insert your PC Card into the slot with the product label facing up.
5. Push the card firmly into the slot until it is seated in the connector.

#### 3-4-2 REMOVING PC CARDS

To remove a PC Card(s), follow these easy steps:

1. See your PC Card manual for specific instructions on removing your card. Some PC Cards may require your notebook PC to be in Suspend Mode or OFF while removing them.

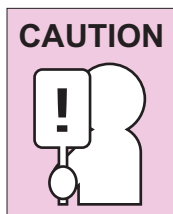

Windows has a shutdown procedure for PC Cards that must be followed before removing a card. (Please review your operating system manual for the correct procedure.)

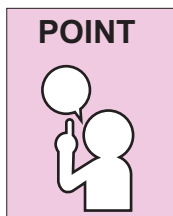

If the dialog box states that the device cannot be removed, you must save all of your open files, close any open applications and shut down your notebook. Once your notebook PC has been shut down, you must turn Off the power using the power switch.

2. Unlock the PC Card from the slot by first pressing the eject button associated with the slot in which the card is located. When pressed, the button will pop out.
3. Firmly press the button again until it is flush with the notebook PC. This will eject the card slightly out of the slot allowing you to remove the card.

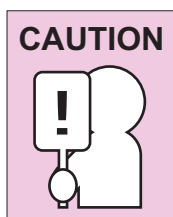

If the PC Card(s) has an external connector and cable, **do not pull the cable when removing the card.**

## 3-5 Memory Upgrade Module

Your notebook PC comes with either 128MB or 256MB of high speed Synchronous Dynamic RAM (SDRAM) factory installed. To increase your notebook's memory capacity, you may install an additional memory upgrade module. The memory upgrade must be a dual-in-line (DIMM) SDRAM module.

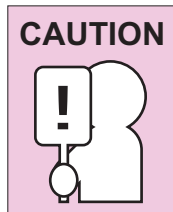

Do not remove any screws from the memory upgrade module compartment except the one specifically shown in the directions for installing and removing the memory upgrade module.

### 3-5-1 INSTALLING A MEMORY UPGRADE MODULE

To install a memory upgrade module follow these steps:



You must turn off power before installing the memory upgrade module.

1. Turn off power to your notebook PC using the power switch, and remove any power adapter.
2. Place your notebook PC upside-down on a clean work surface.
3. Open the top cover all the way, so that it is lying flat on the work surface.
4. Remove the screw holding the memory compartment cover.

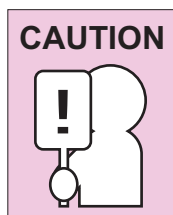

The memory upgrade module can be severely damaged by electrostatic discharge (ESD). Be sure you are properly grounded when handling and installing the module.

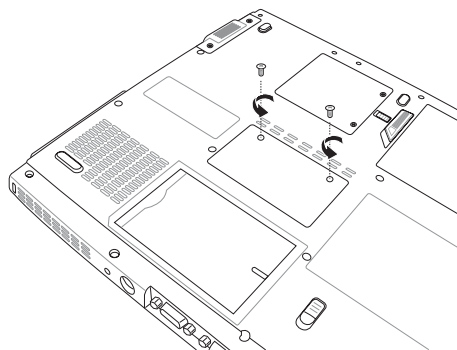

### 3. Using Your Notebook PC

---

5. Align the connector edge of the memory upgrade module, chip side up, with the connector slot in the compartment.

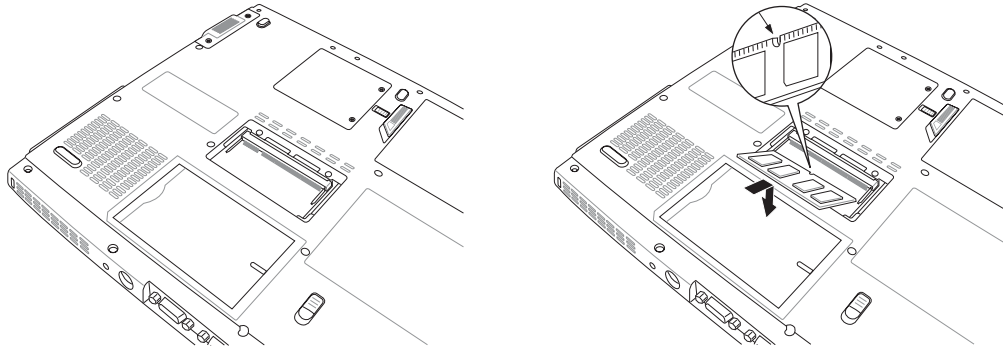

6. Insert the memory upgrade module at a 45 o angle and press it firmly onto the connector.
7. Press the memory upgrade module down into the compartment until it locks underneath the retaining clip. You will hear a click when it is properly in place.
8. Replace the cover and screw that were removed previously. Installation of the new memory module is now complete.

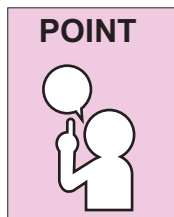

The memory upgrade module is not something you routinely remove from your notebook PC. Once it is installed, you should leave it in place unless you want to increase system memory capacity.

### 3-5-2 REMOVING A MEMORY UPGRADE MODULE

1. Perform steps 1 through 4 of *3-5-1 Installing a Memory Upgrade Module*.
2. Pull the clips sideways away from each side of the memory upgrade module at the same time.

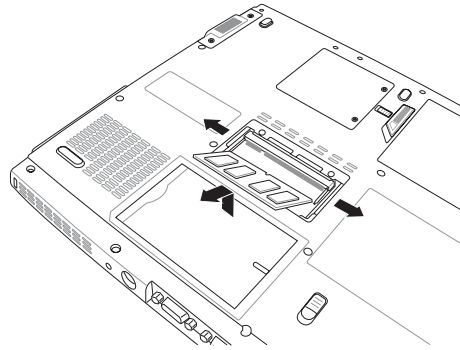

3. While holding the clips out, remove the module from the slot by lifting it up and pulling towards the back of your notebook PC.
4. Store the memory upgrade module in a static guarded sleeve.
5. Replace the memory compartment cover by following step 8 of *3-5-1 Installing a Memory Upgrade Module*.



After changing your memory module configuration, you must complete the Resetting the Hibernation (Save-to-Disk) Parameters procedure in order for the Hibernation (Save-to-Disk) mode to operate properly on your notebook PC. (See *Hibernation (Save-to-Disk) Feature* on page 30 for more information.)



#### 3-5-3 CHECKING NEW MEMORY CAPACITY

Once you have changed the system memory capacity by either adding or removing a memory upgrade module, be sure to check that your notebook PC has recognized the change.

You can check the memory capacity by looking at the main menu of the BIOS setup:

1. Turn on the power to your notebook PC using the power switch.
2. Allow the system to start booting and press the [F2] key once the flash screen appears on the screen. This will open the main menu of the BIOS setup with the current settings displayed. *(See 2-3-3 BIOS Setup Utility for more information)*  
Use the right arrow key to select Info in the BIOS Setup menu.

The System Memory and the Extended Memory capacity, as detected by your notebook PC during the Power On Self Test (POST), are displayed at the bottom of the Info menu screen.

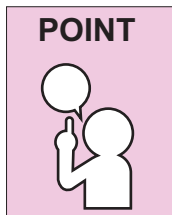

If the total memory displayed is incorrect, check that your memory upgrade module is properly installed.

## 3-6 Device Ports on Optional Port Replicator

Your notebook PC and the optional Port Replicator come equipped with multiple ports to which you can connect external devices including: disk drives, keyboards, USB devices, printers, etc.

### 3-6-1 PS/2 PORT

The PS/2 port allows you to connect an external keyboard, and/or numeric keypad and mouse. In order to connect a PS/2 interface device follow these easy steps:

1. Align the connector with the port opening.
2. Push the connector into the port until it is seated.

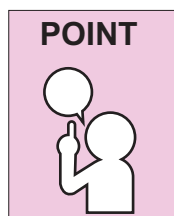

A mouse, keyboard, or keypad may be installed and automatically recognized by your notebook without restarting or changing setups.

### 3-6-2 EXTERNAL MONITOR PORT

The external monitor port allows you to connect an external monitor. In order to connect an external monitor follow these easy steps:

1. Align the connector with the port opening.
2. Push the connector into the port until it is seated.
3. Tighten the two hold-down screws, located on each end of the connector.

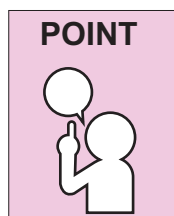

Pressing the [FN] + [F10] keys allows you to change your selection of where to send your display video. Each time you press the key combination, you will step to the next choice, starting with the built-in display panel only, moving to the external monitor only, finally moving to both the built-in display panel and an external monitor.

Is there a stereo line-in jack? If not, remove from above.

### **3. Using Your Notebook PC**

---

#### **3-6-3 SERIAL PORT**

The serial port, or COM port, allows you to connect serial devices, such as printers or scanners. In order to connect a serial interface device follow these easy steps:

1. Align the connector with the port opening.
2. Push the connector into the port until it is seated.
3. Tighten the two hold-down screws, located on each end of the connector.

#### **3-6-4 PARALLEL PORT**

The parallel port, or LPT port, allows you to connect parallel devices, such as a printer to your notebook. In order to connect a parallel interface device, follow these steps:

1. Align the connector with the port opening.
2. Push the connector into the port until it is seated.
3. Tighten the two hold-down screws, located on each end of the connector.

#### **3-6-5 UNIVERSAL SERIAL BUS PORTS**

The two Universal Serial Bus ports (USB) allow you to connect USB devices such as external game pads, pointing devices, keyboards and/or speakers. In order to connect a USB device follow these easy steps:

1. Align the connector with the port opening.
2. Push the connector into the port until it is seated.

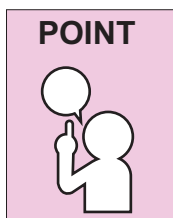

Due to the ongoing changes in USB technology and standards, not all USB devices and/or drivers are guaranteed to work.

### **3-6-6 INTERNAL LAN (RJ-45) PORT**

The RJ-45 port is used to connect the internal Fast Ethernet (10/100 Base-T/Tx) to a Local Area Network (LAN) in your office or home, or broadband devices such as a cable modem, DSL, or satellite internet. If your notebook has been configured with internal LAN capability you will need to configure your notebook to work with your particular network. (To properly set up your LAN environment, consult with a networking professional. Please refer to your network administrator for information on your network configuration.)

To connect the LAN cable follow these easy steps:

1. Align the connector with the port opening.
2. Push the connector into the port until it is seated.
3. Plug the other end of the cable into a LAN outlet.

### **3-6-7 STEREO LINE-OUT PORT**

The optional stereo line-out port allows you to connect a set of speakers or a headphone to your notebook PC.

To connect, follow these easy steps:

1. Align the connector with the port opening.
2. Push the connector into the port until it is seated.

### ***3. Using Your Notebook PC***

---

This page is intentionally left blank.

# 4 TROUBLESHOOTING

---

Your notebook PC is sturdy and subject to few problems in the field. However, you may encounter simple setup or operating problems that you can solve on the spot, or problems with peripheral devices, that you can solve by replacing the device. The information in this section helps you isolate and resolve some of these straightforward problems and identify failures that require service.

## 4-1 Identifying the Problem

If you encounter a problem, go through the following procedure before pursuing complex troubleshooting:

1. Turn off your notebook PC.
2. Make sure the AC adapter is plugged into your notebook PC and to an active AC power source.
3. Make sure that any card installed in the PC Card slot is seated properly. You can also remove the card from the slot, thus eliminating it as a possible cause of failure.
4. Make sure that any devices connected to the external connectors are plugged in properly. You can also disconnect such devices, thus eliminating them as possible causes of failure.
5. Turn on your notebook PC. Make sure it has been off at least 10 seconds before you turn it on.
6. Go through the boot sequence.
7. If the problem has not been resolved, contact your support representative.

Before you place the call, you should have the following information ready so that the customer support representative can provide you with the fastest possible solution:

- Product name
- Product configuration number
- Product serial number
- Purchase date
- Conditions under which the problem occurred

#### ***4. Troubleshooting***

---

- Any error messages that have occurred
- Hardware configuration
- Type of device connected, if any

See the Configuration Label on the bottom of your notebook for configuration and serial numbers.

# APPENDIX

---

## Notebook Specifications

|                            |                                                                                                                                                                                                                                                                                                                                                          |
|----------------------------|----------------------------------------------------------------------------------------------------------------------------------------------------------------------------------------------------------------------------------------------------------------------------------------------------------------------------------------------------------|
| <b>Processor</b>           | Intel® Centrino™ Mobile Technology                                                                                                                                                                                                                                                                                                                       |
| <b>BIOS</b>                | Phoenix 512K BB Flash ROM                                                                                                                                                                                                                                                                                                                                |
| <b>Chipset</b>             | Intel 855PM (Odem) + ICH4-M                                                                                                                                                                                                                                                                                                                              |
| <b>Main memory</b>         | Zero on board and two SO-DIMM memory sockets                                                                                                                                                                                                                                                                                                             |
| <b>LCD</b>                 | 14"XGA/15"XGA and SXGA+ TFT-LCD                                                                                                                                                                                                                                                                                                                          |
| <b>Graphic</b>             | ATI M9-CSP64 support AGP4X                                                                                                                                                                                                                                                                                                                               |
| <b>Hard Disk</b>           | One 2.5" 9.5mm IDE HDD 5400rpm; Support 20/30/40 GB                                                                                                                                                                                                                                                                                                      |
| <b>Optical Disk Drive</b>  | DVD or Combo drive                                                                                                                                                                                                                                                                                                                                       |
| <b>Modem</b>               | 56K MDC S/W Modem, V.90/92 support                                                                                                                                                                                                                                                                                                                       |
| <b>PC card slot</b>        | PCMCIA 2.1 compliance                                                                                                                                                                                                                                                                                                                                    |
| <b>LAN</b>                 | Ethernet 10/100/Gbit Base-T on board                                                                                                                                                                                                                                                                                                                     |
| <b>Interface I/O ports</b> | 1 IEEE 1394<br>1 Infrared IrDA port support FIR<br>2 Audio jacks: Microphone-in/Line-in<br>1 SPDIF Optical out, combo with speaker-out<br>1 VGA port/Mini D-sub 15-pin for external monitor<br>4 USB ports (v2.0)<br>1 TV-out<br>1 Printer port<br>1 RJ11 connector for Modem<br>1 RJ45 connector for Ethernet<br>1 Port Replicator Connector<br>1 DC-in |
| <b>Audio</b>               | Built-in AC'97 stereo sound, with 3D sound effects                                                                                                                                                                                                                                                                                                       |
| <b>Memory card reader</b>  | 4-in-1 Smart Media Reader (Internal USB interface)                                                                                                                                                                                                                                                                                                       |
| <b>Mini-PCI</b>            | One Mini-PCI Slot, Type 3A, CTO ready                                                                                                                                                                                                                                                                                                                    |
| <b>Keyboard</b>            | 86/87/88-key with Windows function keys                                                                                                                                                                                                                                                                                                                  |
| <b>Battery</b>             | Li-Ion 8 cells, 4400mAh, 65W battery pack                                                                                                                                                                                                                                                                                                                |
| <b>AC adapter</b>          | Output: 19VDC, 3.95A, 75W<br>Input: 100~240V AC, 50/60Hz Universal                                                                                                                                                                                                                                                                                       |
| <b>Pointing device</b>     | Built-in touch pad with 4-way scroll function                                                                                                                                                                                                                                                                                                            |
| <b>OS</b>                  | Window 2000 and Windows XP compliance                                                                                                                                                                                                                                                                                                                    |
| <b>Dimensions</b>          | 334(W) x 280(D) x 29.8(H) mm                                                                                                                                                                                                                                                                                                                             |
| <b>Weight</b>              | 2.75 Kg (with 14.1" TFT LCD, DVD-ROM)<br>2.85 Kg (with 15" TFT LCD, Combo Driver)                                                                                                                                                                                                                                                                        |



## **WLAN Specifications**

IEEE 802.11b standard technology

124-pin SO-DIMM edge connector

2.4GHz support

Data rate up to 11Mbps, 5.5Mbps, 2Mbps, 1Mbps

Transmit output power: 16.7dBm

Voltage: 3.3V