

# Rugged Handheld Computer

- PA730 -

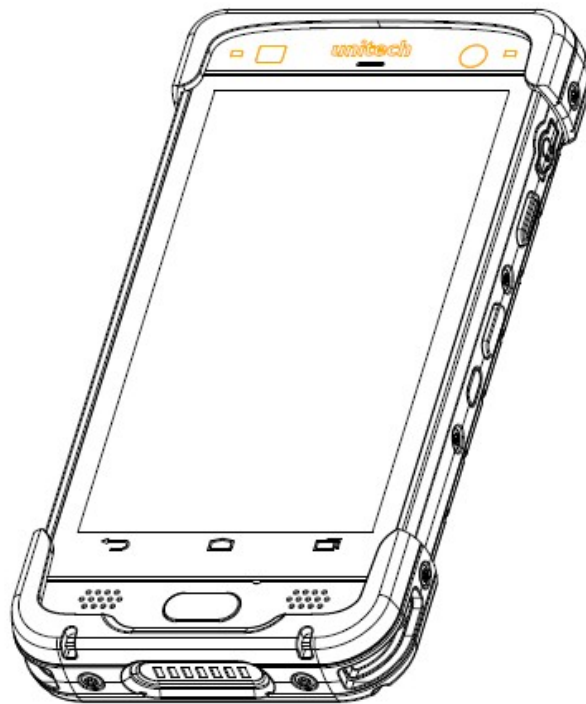

## User's Manual

Version 1.1

## Revision History

<b>Date</b>	<b>Change Description</b>	<b>Version</b>
2017/9/26	first published version	1.0
2017/10/13	Update photos Update spec info.	1.1

### About This Manual

Thank you for purchasing the unitech product.

This manual explains how to install, operate and maintain our product.

No part of this publication may be reproduced or used in any form, or by any electrical or mechanical means, such as photocopying, recording, or information storage and retrieval systems, without permission in writing from the manufacturer. The material in this manual is subject to change without notice.

## Regulatory Compliance Statements

---



### FCC Warning Statement

This device has been tested and found to comply with the limits for a Class B digital device, pursuant to part 15 of the FCC rules. These limits are designed to provide reasonable protection against harmful interference in a residential installation. This equipment generates, uses and can radiate radio frequency energy and, if not installed and used in accordance with the instructions, may cause harmful interference with radio communications. However, there is no guarantee that interference will not occur in a particular installation. If this equipment does cause harmful interference with radio or television reception, which can be determined by turning the equipment off and on, the user is encouraged to try to correct the interference by one or more of the following measures:

- Reorient or relocate the receiving antenna.
  - Increase the separation between the equipment and receiver.
  - Connect the equipment into an outlet on a circuit different from that to which the receiver is connected.
  - Consult the dealer or an experienced radio/TV technician for help.
1. This transmitter must not be co-located or operating in conjunction with any other antenna or transmitter.
  2. This device complies with FCC RF radiation exposure limits set forth for an uncontrolled environment. To maintain compliance with FCC RF exposure requirements, avoid direct contact to the transmitting antenna during transmitting.
  3. Any changes or modifications (including the antennas) made to this device that are not expressly approved by the manufacturer may void the user's authority to operate the equipment.

Operation on the 5.15 - 5.25GHz frequency band is restricted to indoor use only. The FCC requires indoor use for the 5.15-5.25GHz band to reduce the potential for harmful interference to co-channel Mobile Satellite Systems. Therefore, it will only transmit on the 5.25-5.35 GHz, 5.47-5.725 GHz and 5.725 – 5.850 GHz band when associated with an access point (AP).

## **FCC Label Statement**

This device complies with part 15 of the FCC rules. Operation is subject to the following two conditions:

1. This device may not cause harmful interference.
2. This device must accept any interference received, including interference that may cause undesired operation.

## **Hearing Aid Compatibility Information**

The FCC has adopted hearing aid compatibility (HAC) rules for digital wireless phones. These rules require certain phones to be tested and rated under the American National Standard Institute (ANSI) C63.19-2007 or C63.19-2011 hearing aid compatibility standards.

The ANSI standard for hearing aid compatibility contains the below rating:  
An “ M “ rating for reduced radio frequency interference to enable acoustic coupling with hearing aids that are not operating in telecoil mode.

These rating are given on a scale form one to four, where four is the most compatible. A phone is considered hearing aid compatible under FCC rules if it is rated M4 for acoustic coupling.

Hearing aid compatibility ratings don't guarantee that a particular hearing aid works with a particular phone. Some hearing aids might work well with phones that don't meet particular ratings. To ensure interoperability between a hearing aid and a phone, try using them together before purchase.

This phone has been tested and rated for use with hearing aids for some of the wireless technologies it uses. However, there may be some newer wireless technologies used in this phone that have not been tested yet for use with hearing aids. It is important to try the different features of this phone thoroughly and in different locations, using your hearing aid or cochlear implant, to determine id you hear any interfering noise. Consult your carrier or Unitech for information on hearing aid compatibility. If you have questions about return or exchange policies, consult your carrier or phone retailer.

## **RF Radiation Exposure Statement**

For body contact during operation, this device has been tested and meets FCC RF exposure guidelines when used with an accessory that contains no metal and that positions the handset a minimum of 1 cm from the body.

Use of other accessories may not ensure compliance with FCC RF exposure guidelines.

## Canadian Compliance Statement

This Class B Digital apparatus meets all requirements of the Canadian Interference-Causing Equipment Regulations.

Cet appareil numérique de la classe B respecte les exigences du Règlement sur le matériel brouilleur du Canada.

## European Conformity Statement

unitech Electronics co., Ltd herewith declares that the unitech product is in compliance with the essential requirements and all other provisions of the RED 2014/53/EU directive, the EMC 2014/30/EU directive and the Low Voltage 2014/35/EU directive.

The declaration of conformity is available for download at :

<https://portal.unitech.eu/public/Safetyregulatorystatement>

## CE RF Exposure Compliance

This device meets EU requirements (2014/53/EU) on the limitation of exposure of the general public to electromagnetic fields by way of health protection.

For body-worn operation, this device has been tested and meets the ICNIRP guidelines and the European Standard EN 62209-2, for use with dedicated accessories, SAR is measured with this device at a separation of 0.5 cm to the body, while transmitting at the highest certified output power level in all frequency bands of this device. Use of other accessories which contain metals may not ensure compliance with ICNIRP exposure guidelines.

## CE Mark Warning



This equipment complies with the requirements of Directive 2014/53/EU of the European Parliament and Commission from 24 May, 2014 governing Radio and Telecommunications Equipment and mutual recognition of conformity.

The highest CE SAR values for the device are as follows :

0.776 W/kg @ 10g (Head)

1.400 W/kg @ 10g (Body)

## RoHS Statement



This device conforms to RoHS (Restriction Of Hazardous Substances) European Union regulations that set maximum concentration limits on hazardous materials used in electrical and electronic equipment.

## Waste electrical and electronic equipment (WEEE)

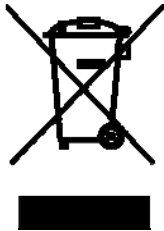

unitech has set up a policy and process to meet the EU directive 2002/96/EC and update 2003/108/EC concerning electronic waste disposal.

For more detailed information of the electronic waste disposal of the products you have purchased from unitech directly or via unitech's resellers, you shall either contact your local supplier or visit us at :

<https://portal.unitech.eu/public/WEEE>

## Taiwan NCC Warning Statement

### 低功率電波輻射性電機管理辦法

第十二條：經型式認證合格之低功率射頻電機，非經許可，公司、商號或使用者均不得擅自變更頻率、加大功率或變更原設計之特性及功能。

第十四條：低功率射頻電機之使用不得影響飛航安全及干擾合法通信；經發現有干擾現象時，應立即停用，並改善至無干擾時方得繼續使用。

前項合法通信，指依電信法規定作業之無線電通信。

低功率射頻電機需忍受合法通信或工業、科學及醫療用電波輻射性電機設備之干擾。

#### 注意事項：

1. 使用過度恐傷害視力。
2. 使用30分鐘請休息10分鐘；2歲以下幼兒不看螢幕，2歲以上每天看螢幕不要超過1小時。
3. 減少電磁波影響，請妥適使用。



## Laser Information

---

The unitech product is certified in the U.S. to conform to the requirements of DHHS/CDRH 21CFR Subchapter J and to the requirements of IEC 60825-1. Class II and Class 2 products are not considered to be hazardous. The unitech product contains internally a Visible Laser Diode (VLD) whose emissions do not exceed the maximum limits as set forth in the above regulations. The scanner is designed so that there is no human access to harmful laser light during normal operation, user maintenance or prescribed service operations.

The laser safety warning label required by the DHHS/IEC for the unitech product's optional laser scanner module is located on the memory compartment cover, on the back of the unit.

\* Laser information only applies to the products with laser components.

**CAUTION!** Use of controls or adjustments or performance of procedures other than those specified herein may result in hazardous laser light. Use of optical instruments with the scanner, including binoculars, microscopes, and magnifying glasses, will increase eye damage. This does not include eyeglasses worn by the user.

## LED Information

---

The unitech product contains LED indicator(s) or LED ring whose luminance is not harmful to human eyes during normal operation, user maintenance or prescribed service operations.

\*LED information only applies to the products with LED components.

## Battery Notice

---

1. To guarantee optimal performance, it is recommended that rechargeable batteries be replaced every year, or after 500 charging cycles are completed. It is normal for the battery to balloon or expand after one year or 500 cycles. Although it does not cause damage, it cannot be used again and must be disposed of according to the location's safe battery disposal procedures.
2. If a battery performance decreases more than 20%, the battery is at the end of its life cycle. Stop use and ensure the battery is disposed of properly.
3. The length of time that a battery lasts depends on the battery type and how the device is used. Conserve the battery life by doing the following:
  - Avoid fully uncharging the battery because this places additional strain on it. Several partial uncharges with frequent charges are better than a fully uncharged battery. Charging a partially charged battery does not cause harm to the unit.
  - Keep the battery cool. Avoid hot vehicles. For prolonged storage, keep the battery at a 40% charge level.
  - Do not leave the battery uncharged and unused for an extended period of time, the battery will wear out and the longevity of the battery will be at least half of one with frequent charges.
4. Protect battery life by not over or under charging the battery.
5. Please do not leave battery unused for long time without charging it. Despite unitech's safety precautions, the battery pack may begin to change shape. If so, stop using it immediately. Please check to see if you are using a proper power adapter to charge the battery or contact your service provider for service.
6. If you cannot charge the battery after it has been idle for an extended period of time and it begins to heat up, please do not try to charge it. It may not be functional anymore.
7. Please only use the original battery from unitech. Using a third party battery can damage our products. Please note that when such damage occurs, it is not covered by unitech's warranty policy.

**CAUTION!**

- RISK OF EXPLOSION IF BATTERY IS REPLACED INCORRECTLY. DISPOSE OF USED BATTERIES ACCORDING TO THE INSTRUCTIONS.
- 如果更換不正確之電池會有爆炸的風險  
請依製造商說明書處理用過之電池
- 如果更換不正確之電池會有爆炸的風險  
請依製造商說明書處理用過之電池

## Battery charge notice

It is important to consider temperature when the battery pack is charging. Charging is most efficient at normal room temperature or in a slightly cooler environment. It is essential that batteries are charged within the stated range of 0°C to 40°C. Charging batteries outside of the specified range could damage the batteries and shorten their life cycle.

**CAUTION!** Do not charge batteries at a temperature lower than 0°C. This will make the batteries unstable and dangerous. Please use a battery temperature detecting device for a charger to ensure a safe charging temperature range.

**CAUTION!** To ensure the unit working properly, please keep all connectors away from the contaminants staying inside of them such as dust, grease, mud, and water. The negligence may cause the unit with no communication, short circuited, overheated and so on.

**CAUTION!** If the connector is damaged, please ensure the connector is being fully repaired before use the unit to avoid causing short circuited.

## Storage and safety notice

Although charged batteries may be left unused for several months, their capacity may be depleted due to build up of internal resistance. If this happens, they will require recharging prior to use. Batteries may be stored at temperatures between -20°C to 60°C, however they may deplete more rapidly at higher temperatures. It is recommended to store batteries at room temperature.

*\* The message above only applies to the usage of the removable batteries.  
For the products with non-removable batteries / without batteries, please refer to the specification of each product.*

## Product Operation and Storage Notice

The unitech product has applicable operation and storage temperature conditions. Please follow the limitation of suggested temperature conditions to avoid failure, damage or malfunction.

*\* For applicable temperature conditions, please refer to the specification of each product.*

## Adapter Notice

---

1. Please do not leave the power adapter in the socket when it is not connected to your unitech product for charging.
2. Please remove the power adapter when the battery is fully recharged.
3. The bundled power adapter that comes with your unitech product is not meant to be used outdoors. An adapter exposed to water or rain, or a very humid environment can cause damage to both the adapter and the product.
4. Please only use the bundled power adapter or same specification of adapter to charge your unitech product. Using the wrong power adapter can damage your unitech product.

*\* The message above only applies to the product connected to the adapter.  
For the products without using the adapters, please refer to the specification of each product.*

# Hearing Damage Warning

---

## Zx.3 Warning

The warning shall be placed on the equipment, or on the packaging, or in the instruction manual and shall consist of the following:

- the symbol of Figure 1 with a minimum height of 5 mm; and
- the following wording, or similar :

To prevent possible hearing damage, do not listen at high volume levels for long periods.



Figure 1 – Warning label (IEC 60417-6044)

Alternatively, the entire warning may be given through the equipment display during use, when the user is asked to acknowledge activation of the higher level.

## Worldwide Support

unitech's professional support team is available to quickly answer questions or assist with technical-related issues. Should an equipment problem occur, please contact the nearest unitech regional service representative.

For complete contact information please visit the Web sites listed below:

<p><b>Taipei, Taiwan – Headquarters</b></p> <p><b>Tel:</b> +886-2-89121122</p> <p><b>E-mail:</b> info@hq.ute.com</p> <p><b>Address:</b> 5F, No. 136, Lane 235, Baoqiao Road, Xindian District, New Taipei City 231, Taiwan (R.O.C.)</p> <p><b>Website:</b> <a href="http://www.ute.com">http://www.ute.com</a></p>	<p><b>Europe</b></p> <p><b>Tel:</b> +31-13-4609292</p> <p><b>E-mail:</b> info@eu.ute.com</p> <p><b>Address:</b> Kapitein Hatterasstraat 19, 5015 BB, Tilburg, the Netherlands</p> <p><b>Website:</b> <a href="http://eu.ute.com">http://eu.ute.com</a></p>
<p><b>China</b></p> <p><b>Tel:</b> +86-59-2310-9966</p> <p><b>E-mail:</b> info@cn.ute.com</p> <p><b>Address:</b> Room401C, 4F, RIHUA International Mansion, Xinfeng 3rd Road, Huoju Hi-tech District, Xiamen, Fujan , China</p> <p><b>Website:</b> <a href="http://cn.ute.com">http://cn.ute.com</a></p>	<p><b>Japan</b></p> <p><b>Tel:</b> +81-3-35232766</p> <p><b>E-mail:</b> info@jp.ute.com</p> <p><b>Address:</b> Kayabacho Nagaoka Building 8F.,1-5-19 Shinkawa, Chuo-Ku, Tokyo, 104-0033, Japan</p> <p><b>Website:</b> <a href="http://jp.ute.com">http://jp.ute.com</a></p>
<p><b>Asia &amp; Pacific / Middle East</b></p> <p><b>Tel:</b> +886-2-27911556</p> <p><b>E-mail:</b> info@apac.ute.com info@india.ute.com info@mideast.ute.com</p> <p><b>Address:</b> 4F., No. 236, ShinHu 2nd Rd., NeiHu Chiu, 114, Taipei,Taiwan</p> <p><b>Website:</b> <a href="http://apac.ute.com">http://apac.ute.com</a> / <a href="http://mideast.ute.com">http://mideast.ute.com</a></p>	<p><b>Latin America</b></p> <p><b>Tel:</b> +52-55-5171-0528</p> <p><b>E-mail:</b> info@latin.ute.com</p> <p><b>Address:</b> 17171 Park Row, Suite 210 Houston, TX 77084USA (Rep.)</p> <p><b>Website:</b> <a href="http://latin.ute.com">http://latin.ute.com</a></p>
<p><b>North America</b></p> <p><b>Tel:</b> +1-714-8916400</p> <p><b>E-mail:</b> info@us.ute.com / info@can.ute.com</p> <p><b>Address:</b> 6182 Katella Ave, Cypress, CA 90630, USA</p> <p><b>Website:</b> <a href="http://us.ute.com">http://us.ute.com</a></p>	<p><b>Please scan QR Code to visit us :</b></p> 

## Warranty Policy

---

The following items covered under the unitech Limited Warranty are free from defects during normal use:

The warranty period is varied from each country. Please consult with your supplier or unitech local office for actual length of warranty period to your purchased product.

Warranty becomes void if equipment is modified, improperly installed or used, damaged by accident or neglect, or if any parts are improperly installed or replaced by the user.

## Table of Contents

<b>Preface</b> .....	i
Regulatory Compliance Statements .....	i
Laser Information .....	v
LED Information .....	v
Battery Notice.....	vi
Adapter Notice.....	viii
Hearing Damage Warning .....	ix
Worldwide Support .....	xii
Warranty Policy .....	xiii
<b>Chapter 1 - Overview</b> .....	1
1.1 Package .....	1
1.2 Product Detail.....	2
1.3 Specifications .....	5
1.4 Getting Started .....	9
<b>Chapter 2 – Installation &amp; Operation</b> .....	14
2.1 Barcode Setting.....	14
2.2 HF Setting .....	19
2.3 UHF Setting.....	20
2.4 MSR Setting .....	20
2.5 WWAN Setting.....	21
2.6 WLAN Setting.....	23
2.7 PAN Setting .....	24
2.8 GPS Setting.....	25
2.9 PC Setting .....	27
2.10 Camera Setting .....	29
2.11 Performing a Hardware Reset .....	32
2.12 Performing Factory Data Reset.....	33
2.13 Programmable Keys.....	34
2.14 Battery Swap .....	36



Chapter 3 – Introduction to Applications.....	37
3.1 Scan Service .....	37
3.2 File Manager .....	40
3.3 Update Center .....	41
3.4 Sound Recorder .....	42
3.5 Push To Talk .....	44
3.6 MoboLink.....	45
3.7 SOTI.....	49

# Chapter 1 - Overview

## 1.1 Package

---

Please make sure the following contents are in the PA730 gift box. If something is missing or damaged, please contact your unitech representative.

### The standard package contents

- PA730 Terminal
- Battery
- Hand Strap
- Quick Start Guide
- USB Cable (with two special ferrite cores )
  - ✧ *the special USB cable must be used with this device*
- Power Adapter ( EU or US )
- Regulatory Compliance Statements

## 1.2 Product Detail

### PA730 Front View

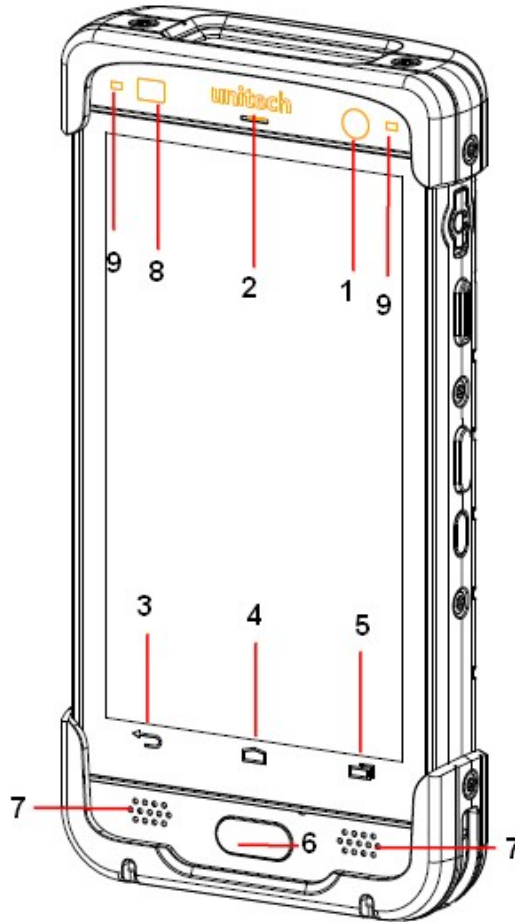

1	Front camera	6	Camera button
2	Logo	7	Speaker
3	Back key	8	Light sensor
4	Home key	9	LED
5	Menu key		

## PA730 Rear View

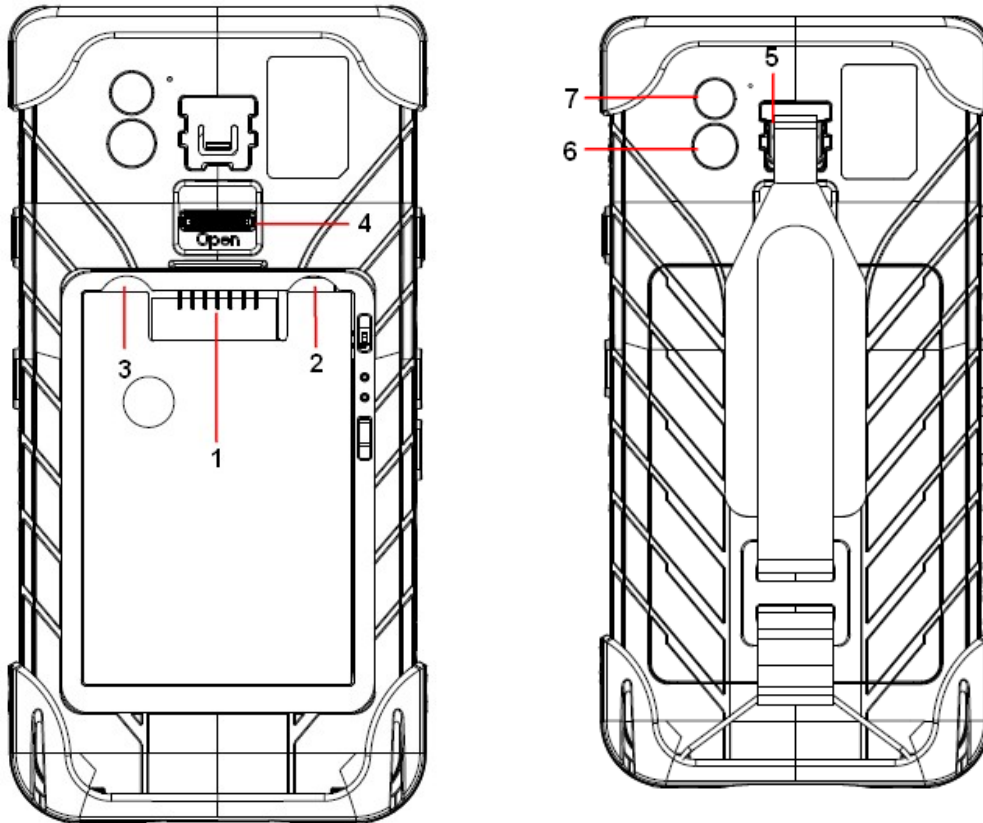

1	Battery pin	5	Hand strap hook
2	SIM card slot	6	Back camera
3	Micro SD card slot	7	Flash LED
4	Battery cover lock switch		

## PA730 Left and Right View

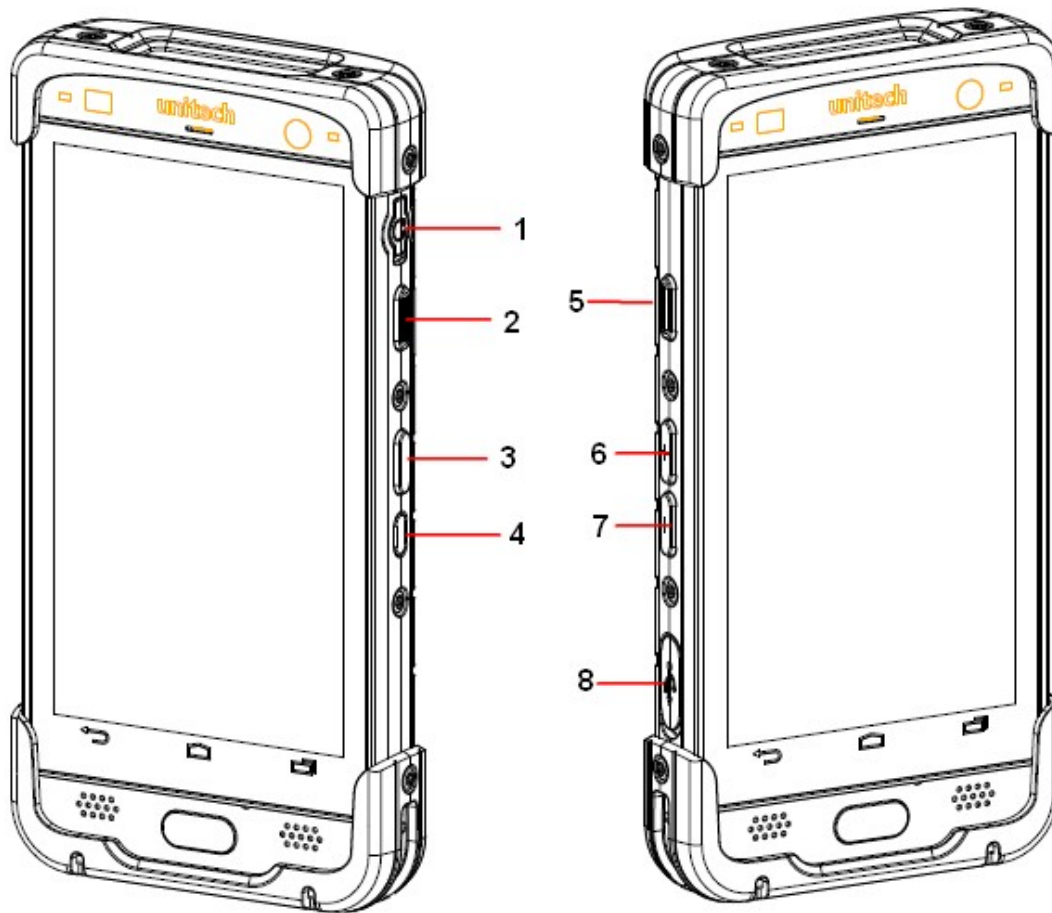

1	Ear phone jack	5	Scan button
2	Scan button	6	Volume up
3	Function Key	7	Volume down
4	Power button	8	USB connect

## 1.3 Specifications

<b>System Features</b>	
<b>Processor</b>	Qualcomm APQ8052(617) ARM A53 64 bits CPU Quad Core*1.5Ghz &Quad Core*1.2Ghz
<b>Memory</b>	16GB eMMC Flash ROM plus 2GB LPDDR3 RAM
<b>Expanded slot</b>	One user accessible Micro SD Memory Slot One user accessible SIM slot
<b>Display</b>	
5.0", Color FHD Capacitive type 5 points multi-touch touch panel with Gorilla Glass Support finger, glove and stylus FHD(full high definition):1920 x 1080 (1080P) Brightness: 500cd/m <sup>2</sup> (nits) Transmissive type TFT LCD	
<b>Keypad</b>	
Front Key :Standard Android 3 keys(touch key together with touch panel) and one function key. Side Key : Scan key left and right., volume key up and down, power key and function key.	
<b>Indicator</b>	
2 x LED indicators for charging LED & information LED. One vibrator for scan or ring in indication Audio tone indication	
<b>Engines</b>	
<b>2D Imager engine (SE 4750)</b>	1D All major codes 2D : PDF417, MicroPDF417, Composite, RSS, TLC-39, Datamatrix, QR code, Micro QR code, Aztec, MaxiCode, Postal Codes: US PostNet, US Planet, UK Postal, Australian Postal, Japan Postal Dutch Postal (KIX)
<b>Audio</b>	
Dual speaker One receiver and dual noise-cancelling microphones 3.5mm DIA stereo headset jack with MIC. In	

<b>External Connector</b>		
One user accessible micro SD Memory slot with SDHC, SDXC compliance and software image upgrade features		
One user accessible Micro SIM slot		
Micro USB (B type) support USB 2.0 OTG and USB charge		
Cradle connector support USB 2.0 and DC power input		
<b>Software</b>		
MoboLink, SOTI		
<b>Regulatory Approvals</b>		
CE, FCC, RoHS compliance		
<b>■ FCC certification :</b>		
Max 1g Reported Head SAR (W/kg)	0.46	Limit: 1.60 W/kg
Max 1g Reported Body SAR (W/kg)	0.39	
Max Product specific 10g Reported Body SAR (W/kg)	0.32	Limit: 4.00 W/kg
Max Reported 1g Simultaneous Transmission SAR (W/kg)	0.97	Limit: 1.60 W/kg
Distance (mm)	10	
Verdict	PASS	
<b>Communication</b>		
<b>USB</b>	USB 2.0 OTG	
<b>WLAN</b>	802.11a/b/g/n/ac Wireless LAN, 2.4GHz and 5GHz Compliant with WEP, WPA and IEEE 802.11i WPA2 Fast roaming under 100ms Enterprise security	
<b>PAN</b>	Bluetooth 4.1 LE Support profile : HID, A2DP, OPP, SPP	
<b>WWAN (Option)</b>	<ul style="list-style-type: none"> <li>● Europe: FDD LTE: B1/B3/B5/B7/B8/B20 TDD LTE: B38/B40/B41 WCDMA: B1/B5/B8 GSM: 900/1800</li> <li>● North America-Verizon FDD LTE: B4/B13</li> </ul>	
<b>GPS</b>	GPS/GLONASS (Only for WAN model)	

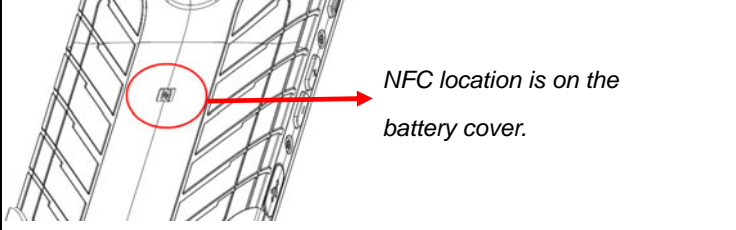
<p><b>NFC</b></p>	<p>ISO14443-4 (Type A, Type B), ISO15693 Mifare, Felica(ISO/IEC18092)</p> 
<p><b>Camera and Flash Light</b></p>	
<p>Rear camera: 16M pixels CMOS color camera with autofocus Front camera: 5.0M pixels CMOS color camera LED flash light with torch</p>	
<p><b>Sensors</b></p>	
<p>Accelerometer, Light sensor, Proximity sensor Gyroscope, E-compass</p>	
<p><b>Power Source</b></p>	
<p><b>Battery</b></p>	<p>Replaceable Main Battery : 3.7V, typ. 2960mAh Li-Ion battery pack(standard), typ. 5920mAh (extended) One rechargeable RTC backup battery One rechargeable backup battery for battery swap</p>
<p><b>Power Adapter</b></p>	<p>100~240Vac, 50/60Hz Input 5V, 2A / 9V, 2A output</p>
<p><b>Enclosure</b></p>	
<p><b>Weight</b></p>	<p>Approximately 340g with standard battery</p>
<p><b>Dimension</b></p>	<p>Approximately 158 X 77 X 16.9 mm</p>
<p><b>Environmental</b></p>	
<p><b>Operating temperature</b></p>	<p>-4°F to 122°F (-20°C to 50°C)</p>
<p><b>Storage temperature</b></p>	<p>-22°F to 140°F (-30°C to 60°C) (without Battery)</p>
<p><b>Relative Humidity</b></p>	<p>10% ~ 90% ( non-condensing )</p>
<p><b>Drop test to Concrete</b></p>	<p>1.8m MIL-STD 810G</p>
<p><b>Environmental Sealing</b></p>	<p>IP67 &amp; IP65 standard</p>
<p><b>ESD</b></p>	<p>+/-8KV direct discharge, +/-15KV air discharge</p>
<p><b>Tumble</b></p>	<p>0.5m tumbles for 300 cycles and 600 drops</p>
<p><b>Operating System</b></p>	
<p>Android 6.0</p>	



Radio Type	Description	Frequency	Maximum Output
Bluetooth	Bluetooth BR+EDR	2400~2483.5 MHz	4dBm
	Bluetooth 4.0-LE	2400~2483.5 MHz	4dBm
WLAN	2.4GHz	2400~2483.5 MHz	17dBm
	5GHz	5150~5350 MHz	21dBm
		5470~5725 MHz	22dBm
GSM	GSM 900	880~915 MHz	33dBm
	GSM 1800	1710~1785 MHz	30.5dBm
WCDMA	WCDMA Band I	1920~1980 MHz	24dBm
	WCDMA Band VIII	880~915 MHz	24dBm
LTE	LTE Band 1	1920~1980 MHz	23.5dBm
	LTE Band 3	1710~1785 MHz	23dBm
	LTE Band 5	824MHz~849MHz	23dBm
	LTE Band 7	2500~2570 MHz	23dBm
	LTE Band 8	880~915 MHz	23dBm
	LTE Band 20	832~862 MHz	23dBm
	LTE Band 38	2570~2620 MHz	23dBm
	LTE Band 40	2300~2400 MHz	23dBm
Other	NFC	13.56 MHz	
	GPS	1575.42 MHz	

**NOTE :** Requirements in

AT/BE/BG/CZ/DK/EE/FR/DE/IS/IE/IT/EL/ES/CY/LV/LI/LT/LU/HU/MT/NL/NO/PL/PT/RO/SI/SK/TR/FI/SE/CH/UK/HR. 5150MHz~5350MHz is for indoor use only.

## 1.4 Getting Started

---

### 1.4.1 Installing The Battery

1. Press and push the hand hook to loosen or move the hand strap from PA730.

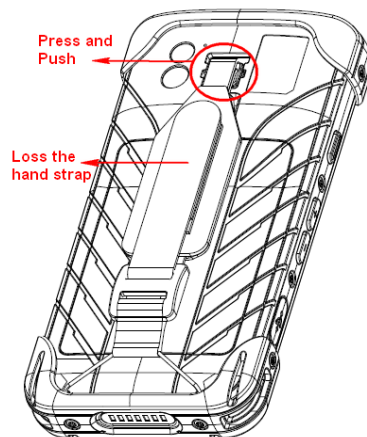

2. Push up the battery cover switch to unlock, and remove battery cover from top.

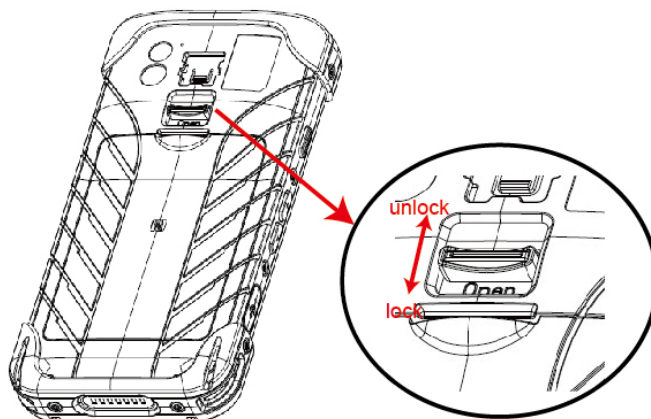

3. Insert the battery pack, and then put back the battery cover.

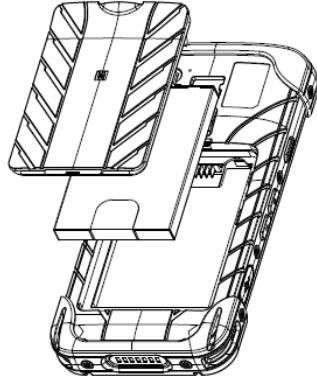

4. Push down the battery cover switch to lock the cover.

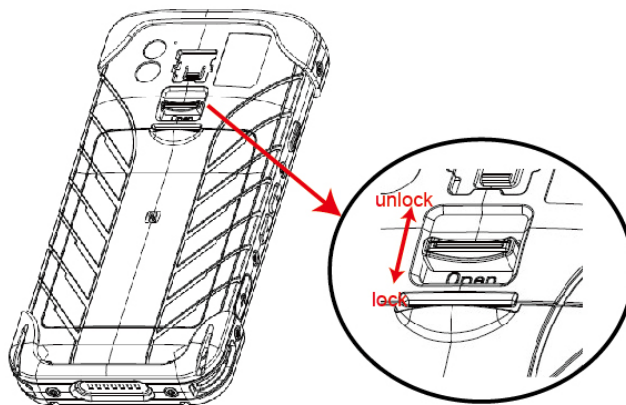

**NOTE:** After installing the battery, make sure the battery cover is securely closed, or you may be unable to turn ON the terminal.

**WARNING!** There is a risk of fire and burns if the battery pack is handled improperly. DO NOT disassemble, crush, puncture, short external contacts, or dispose the battery pack in fire or water. DO NOT attempt to open or service the battery pack. Dispose of used batteries according to local recycling guidelines in your area.

## 1.4.2 Charging The Battery

Before you turn on and start using this device, it is recommended that you charge the battery.

If the battery has been discharged for several days, you may need to charge for several minutes before powering it on.

Use only the adapter and the USB cable that came with this device to charge the battery. When the battery power is too low, make sure to use the power adapter or put into the dock to charge, not the USB cable connection with your computer.

### ■ Charge with USB

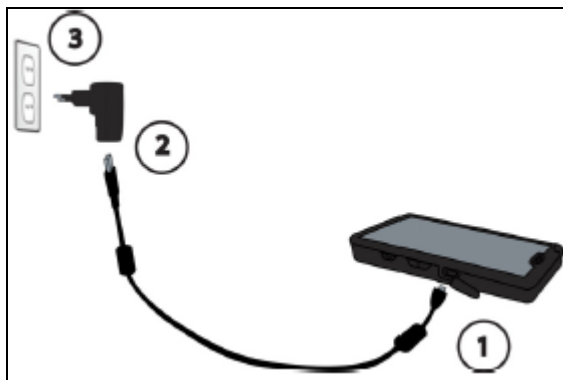

### ■ Charge with cradle

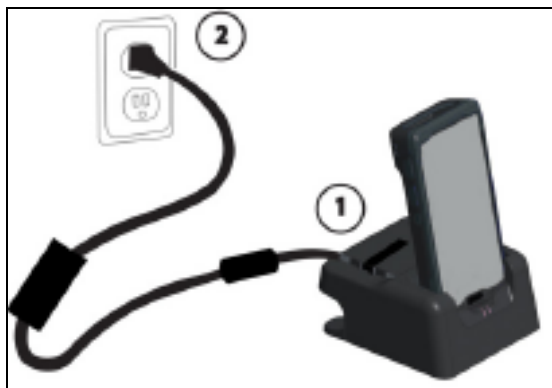

## 1.4.3 Turning On The Terminal For The First time

After you have initially charged your device for about 24 hours, the device is ready to be used. You can now start up your device. You can then set up the languages, WiFi setting, and date and time.

### Power-On Button

Turn ON your device by pressing the power button of the terminal.

## 1.4.4 Checking The LED Status

	Status	LED	Description
Terminal	Message	Blue light	Message received
		Blue light	Miss called
	Power	Red light	Being charged
		Green light	Fully charged
		Orange light	Quick charged

### Checking the battery status

If the battery level becomes low in the course of normal use, a status icon appears on the device screen indicating low or very low battery status. In both cases, connect PC with USB to back up your data, and then recharge your device as soon as possible.

## 1.4.5 Using The SD/SIM Card

The PA730 has SD/SIM card slots inside the battery compartment.

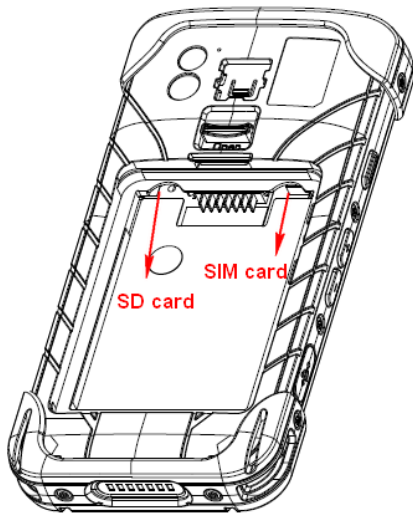

### Inserting a SD/SIM card

1. Remove the battery cover and battery pack.
2. Insert the SD card to the left slot.
3. Insert the SIM card to the right slot.
4. Insert the battery pack and battery cover.
5. Push down the battery cover switch to lock the cover.



# Chapter 2 – Installation & Operation

## 2.1 Barcode Setting

1. Tap  go to APPS, then tap  ScanService.
2. You are now enter the ScanService application. There are three main items : **Settings, Test and Version.**

### 2.1.1 Settings

Tap the default barcode symbologies for a different application

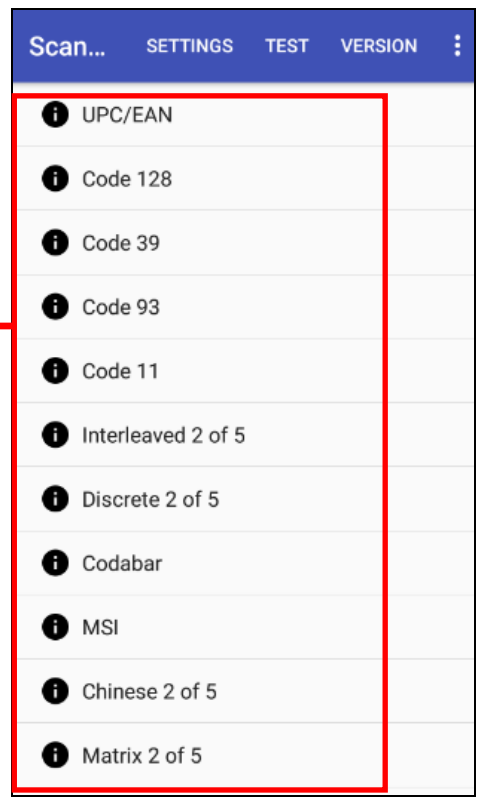

- For **Save / Load Settings**, and **Factory Default** section,

To save data, Please tap  and then tap **Save / Load Settings**.

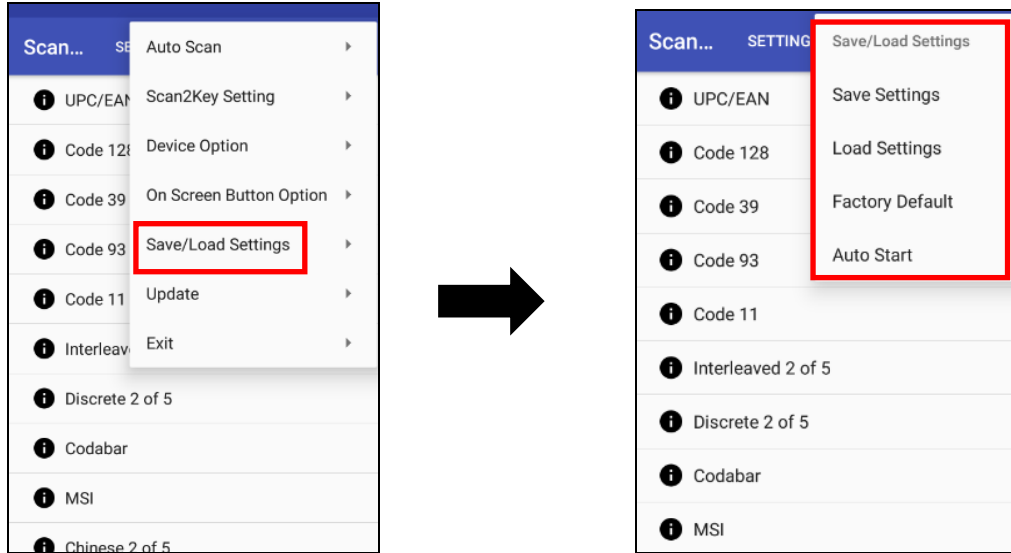

Please tap **Save Settings – input path - OK**





The save setting data is stored in File Manager. (Please see [3.2 File Manager](#) )

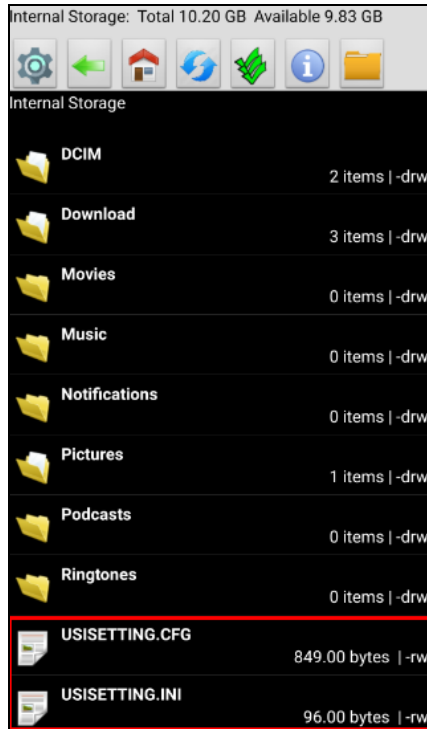

## 2.1.2 Test

Scanned data information

Code type: CODE128  
Data Length: 3  
Data: //A

Code type: CODE128  
Data Length: 4  
Data: //X4

Remove scan information

Save to file

Scan... SETTINGS TEST VERSION

Code type: CODE128  
Data Length: 7  
Data: Unitech

Enter the path and filename here:  
/sdcard/scan.txt

CANCEL OK

1 Tap 

2 Choose the path and filename to save the scanned data.

## Version

Show the recent version of ScanService.

Tab  to update Scanservice manually.

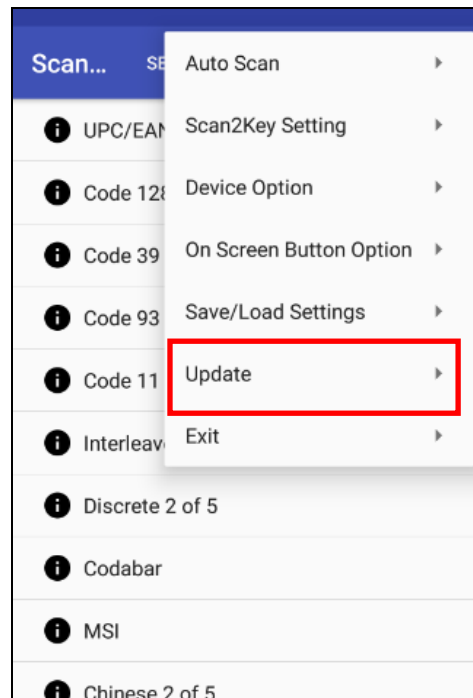

## 2.2 HF Setting

---

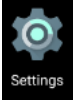
1. Tap  go to APPS, and tap  **Settings** and then under **Wireless & networks**, tap **More...**
2. Tap **NFC** check box to Enable / disable NFC function.
3. If enable / disable NFC check box, it will also enable / disable Android Beam too.

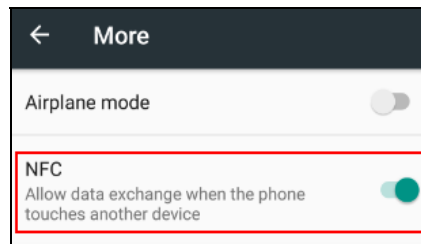

4. Make sure that both devices are unlocked and have NFC turned on. If the other device has an Android Beam option, make sure it is also turned on.
5. Make sure that the NFC area (shaded part) of PA730 and the other phone's NFC area are close to one another. Experiment by slightly moving the phones until a connection is made. Tap the screen.

## 2.3 UHF Setting

---

Current model is not available.

## 2.4 MSR Setting

---

Current model is not available.

## 2.5 WWAN Setting

1. Turn off the terminal to insert the SIM card.



**Note :** • For the instruction, please refer to [1.4.5 Using the Micro SD/SIM Card](#).  
• It only applies to the device which supports WWAN.

2. Turn on the terminal, 4G signal will show at the top of the screen.

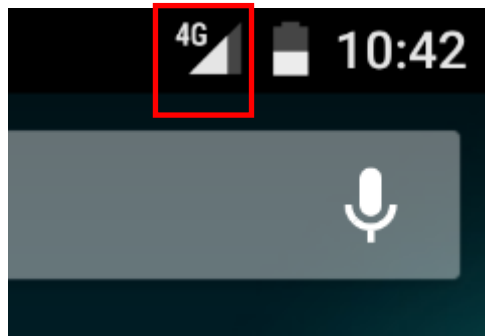
If you insert 3G SIM card into PA730, the icon  is displayed on the status bar.



### 2.5.1 Mobile Network Settings

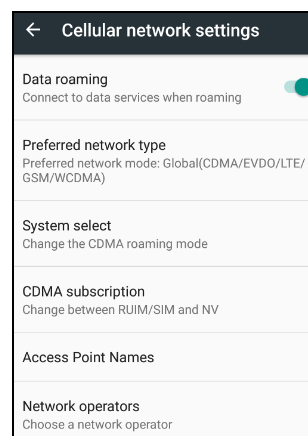
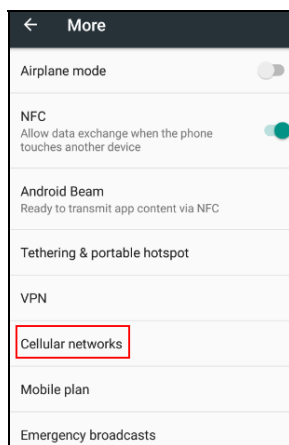

1. Tap  go to APPS, and tap  **Settings**.  
Go to Wireless & networks, Tap **More**, and tap **Cellular networks**.

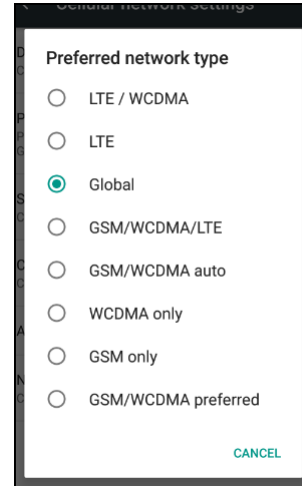
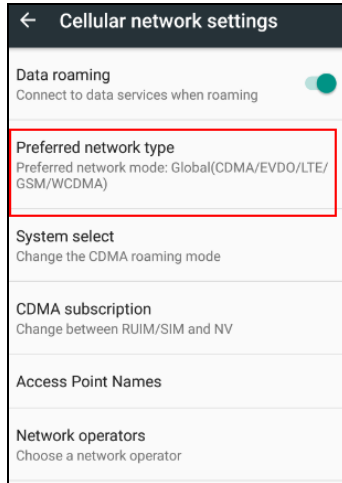

2. You can have more **Cellular network settings** in this section.  
For network type, please tap **Preferred network type**.



## 2.6 WLAN Setting

1. Tap  go to APPS, and tap  **Settings** and then go to Wireless & networks, Tap **WLAN**.

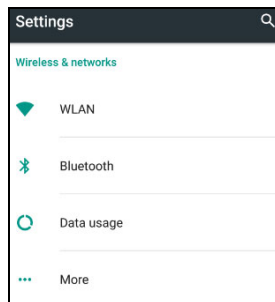

2. To see available networks, turn Wi-Fi **ON**. And tap to choose the available networks.

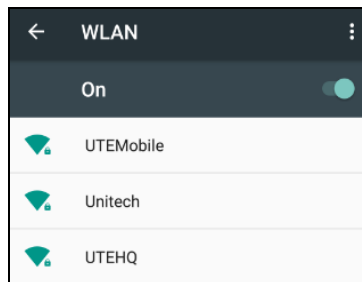

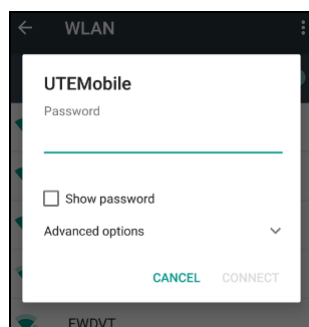

3. Choose the available networks, and enter the Password and tap **Connect**.



4. If the wireless network that you want is not listed, tap + to manually add it.
5. When enabled, the Wi-Fi icon  is displayed on the status bar.



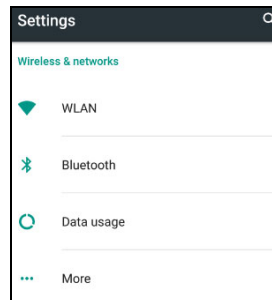

## 2.7 PAN Setting

1. Tap  go to APPS, and tap  **Settings**.
2. Select Bluetooth from Wireless & Networks.



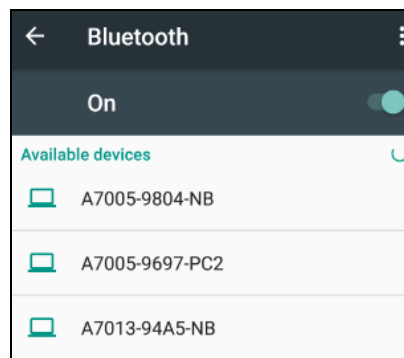

3. Tap the Bluetooth tile to turn Bluetooth on.
4. Tap the Bluetooth to see a list of available devices.



5. If prompted to enter a passcode, try 0000 or 1234, or consult the headset documentation to find the passcode.
6. When enabled, the Bluetooth icon  is displayed in the status bar.

When the Bluetooth device is connected, you'll see in the status bar. Normally, you can easily reconnect your device by switching on Bluetooth on PA730, and then turning on the device. However, you might have to connect manually if PA730 has been used with another Bluetooth device.

## 2.8 GPS Setting

1. Tap  go to APPS, and tap  **Settings**.
2. Go to **PERSONAL** , Tap **Location**.

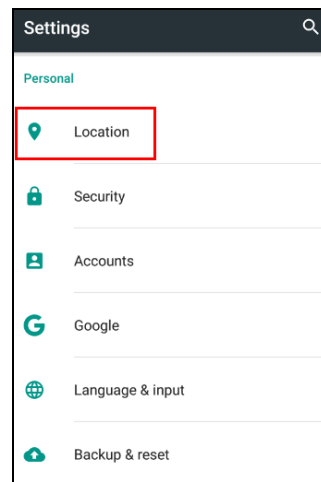

3. Tap **ON/OFF** for the permission to use your location information.

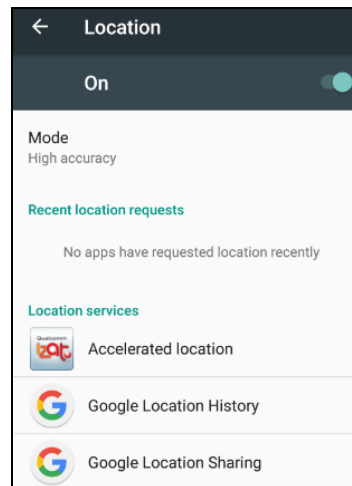

4. Tap **Mode** for more location mode settings.

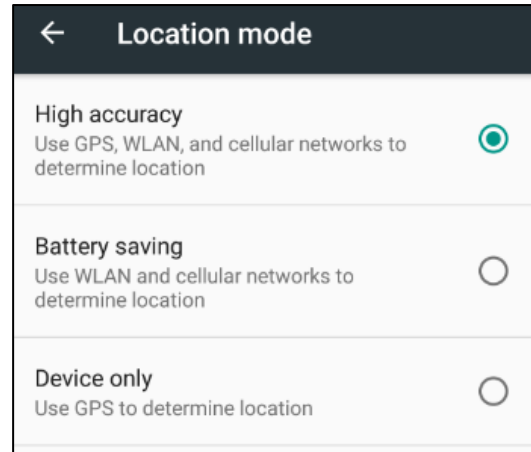
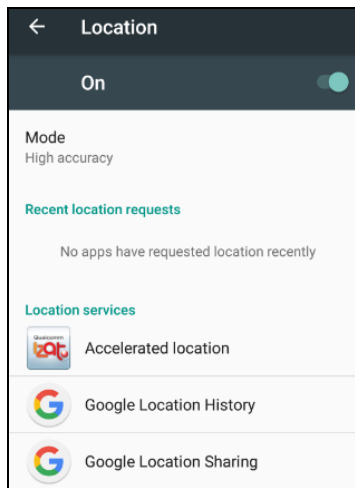

- **High accuracy :**  
Use GPS, Wi-Fi and cellular networks to determine location
- **Battery saving :**  
Use Wi-Fi and cellular networks to determine location
- **Device only :**  
Use GPS to determine location

## 2.9 PC Setting

You can transfer your file from or to your computer. The OS of host side please use Windows 7 or upper.

1. Connect PA730 to your computer with the USB cable. Your computer will recognize it is USB charging.
2. Then slide from top, the system will show as follow picture, then you can select File transfers item.

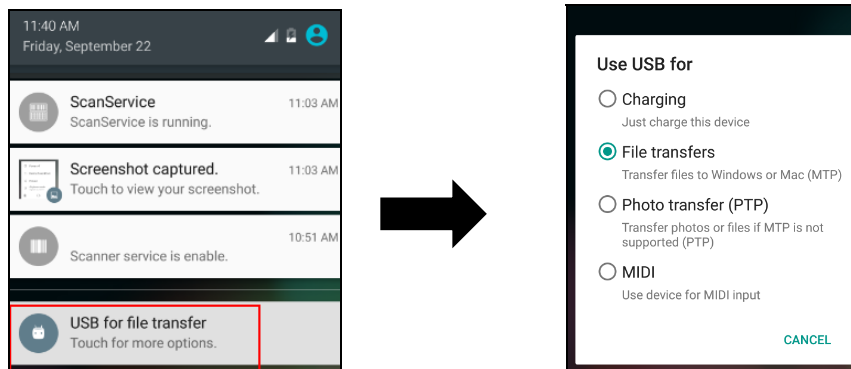

Use USB for	Description
Charging	For charging when you connect with PC host. If your OS of PC host is Windows XP, only this item be selected and you can't select other items.
File Transfers	For file transfer when you connect with PC host. You can find a storage device on your PC host site.
Photo Transfer (PTP)	For file transfer when you connect with PC host. You can find DCIM folder of storage device on your PC host site.
MIDI	For file transfer when you connect with PC host. You can find some folder of storage device on your PC host site.

3. After connecting the terminal to PC with USB, you can find a removable storage on **my computer**.

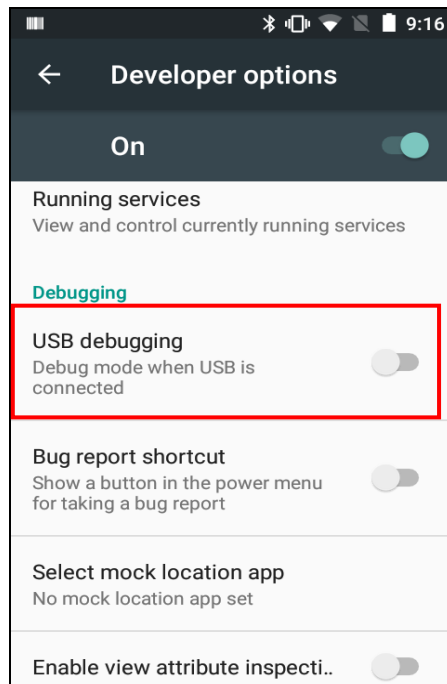

You may also download the Google sync device manager software on your computer. You can set it up to automatically get music, photos, and videos file of PA730 to your computer.

Please disable check box of USB debugging on the Developer options item of android Setting when you want transfer file from computer to PA730.



## 2.10 Camera Setting

### 2.10.1 Camera Settings

1. Please tap  to start Camera App, press  to take a picture.

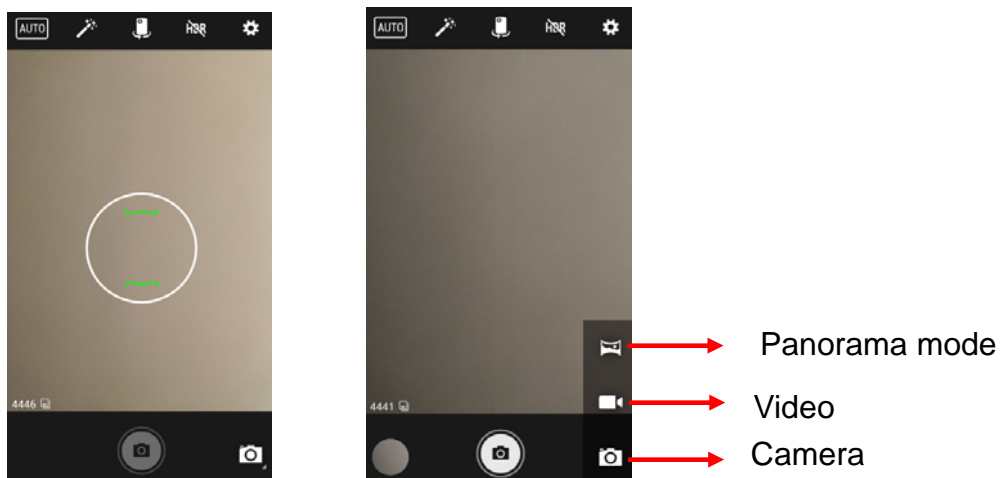

2. Press  to do advance setting.

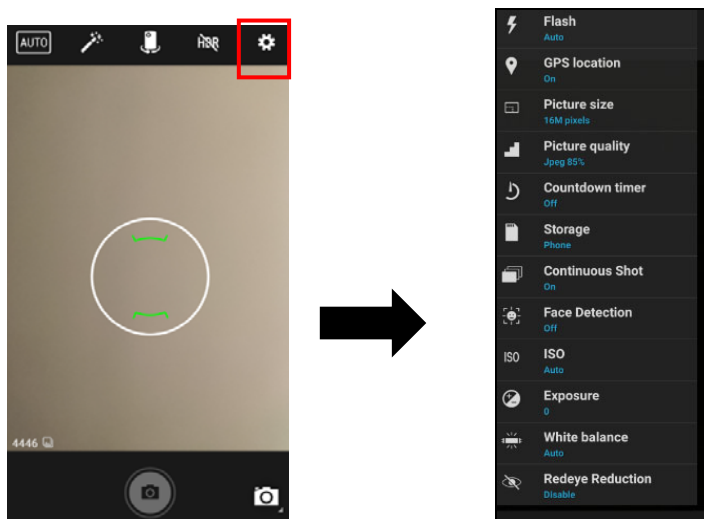

3. Press  to do mode setting

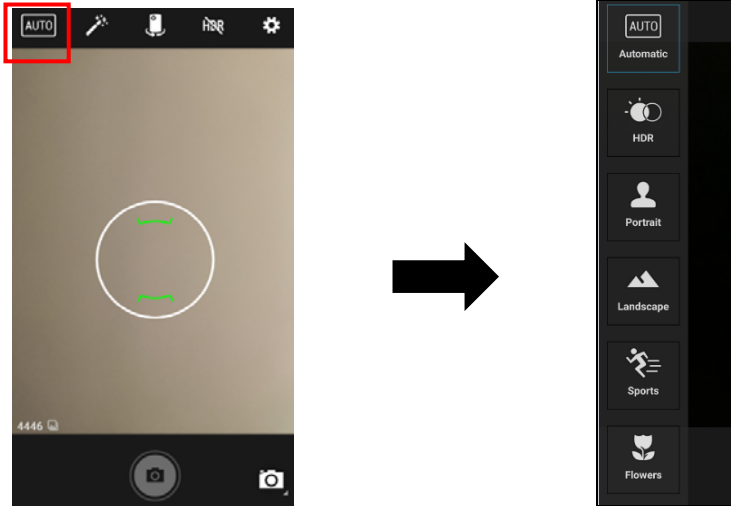

4. Press  to do effects setting

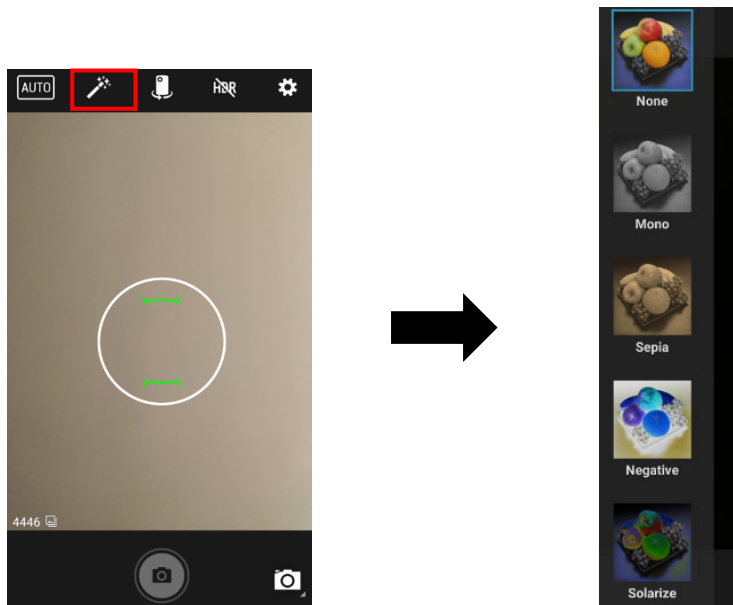

## 2.10.2 Video Settings

Press  to do advance setting.

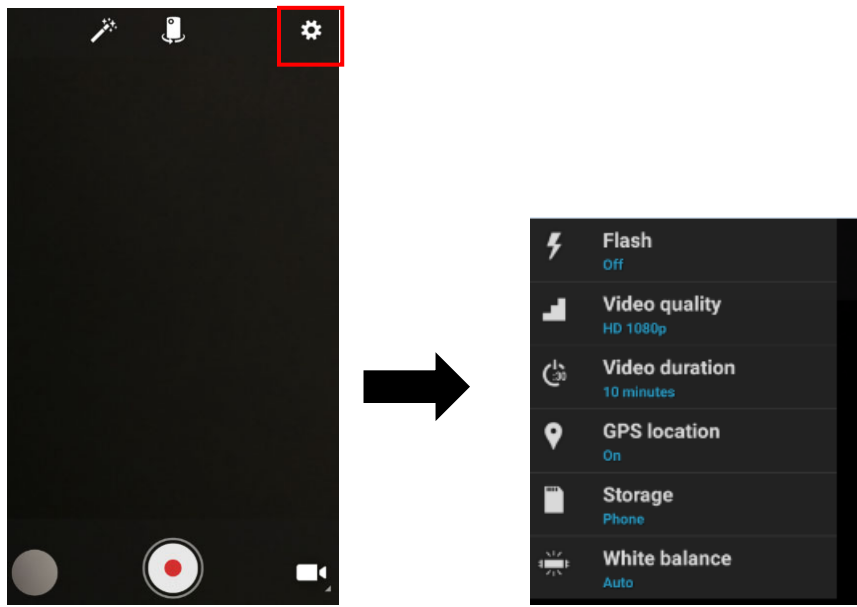

## 2.10.3 Photos & Videos Storage Location

You can choose two different storage ways to save photos & videos : Phone or SD card. SD Card item can not be activated if no SD Card installed in PA730. Please see the photo below.

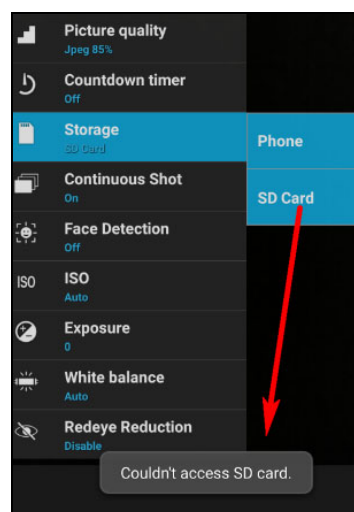



## 2.11 Performing a Hardware Reset



---

You may have to perform a reset if the device freezes (i.e., the terminal no longer responds to the buttons or tapping on the screen).

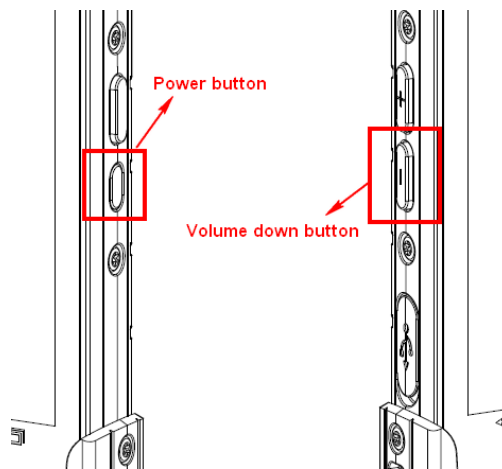
Long press **Power button** and **Volume down button** simultaneously to make the device restart the system within 20 seconds.



## 2.12 Performing Factory Data Reset

1. Tap  go to APPS, and tap  **Settings**.
2. You can reset to factory default when you select **Factory data reset** item, it will erase all include enterprise folder.
3. You can reset to factory default when you select **Network Setting reset** item, it will erase all RF data

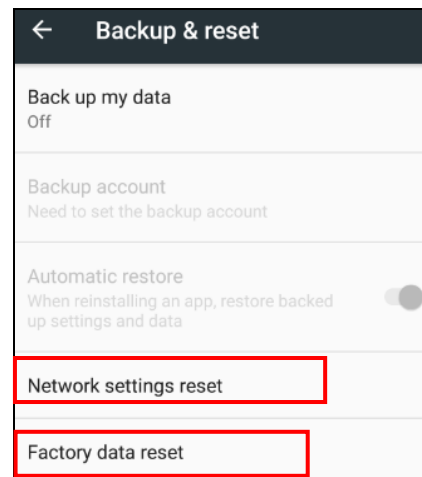
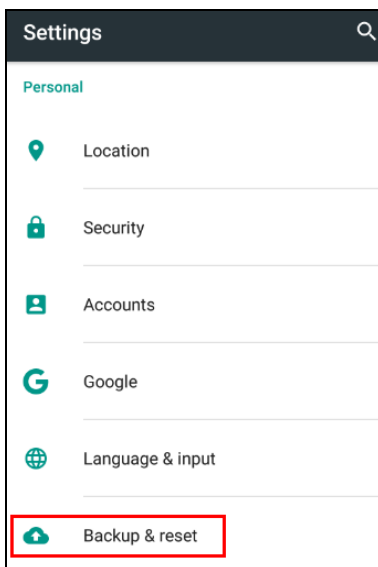

### Factory Data Reset

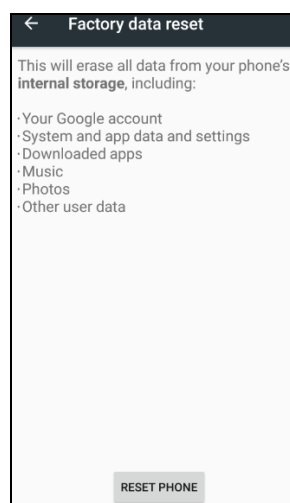

### Network Setting Reset

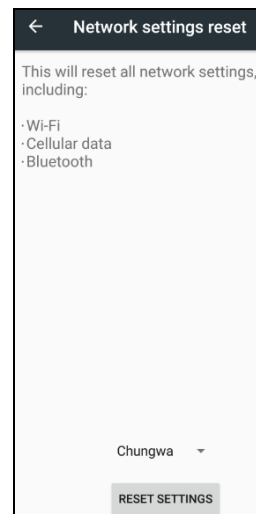

## 2.13 Programmable Keys

The PA730's keys can be programmed for users to be able to perform different functions or applications.

### 2.13.1 Programming a Physical Key

1. Tap  go to APPS, and tap  **Settings**, go to SYSTEM, Tap **Programmable keys**

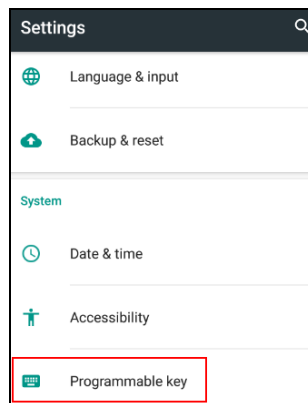

2. Tap **Redefine Key** to select the physical key to remap.  
Then select the redefined type that you prefer : **Keycode / Unicode**  
*Note: Power key can not be redefined.*

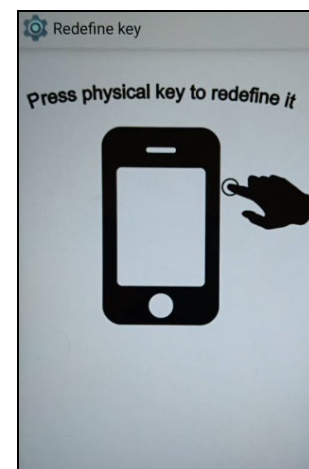
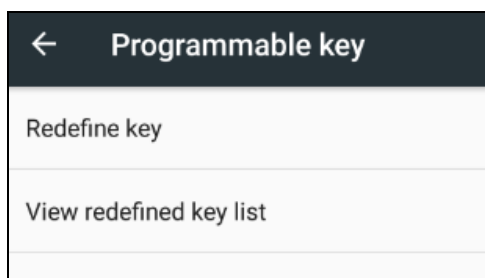

3. Please tap **Redefine this key** after remapping the physical key.

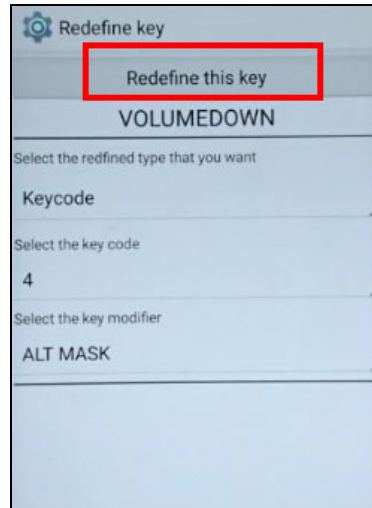

## 2.13.2 View Redefined Key List

Please tap **view redefined key list** to check the redefined keys.

To remove all redefined keys, please tap 

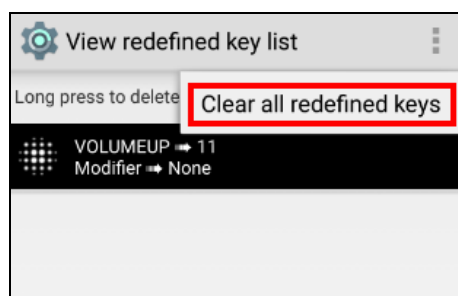

## 2.14 Battery Swap

---

Please follow the steps for the battery swap.

1. Long press power button until you see the pop up window and tap **Battery Swap Mode**.

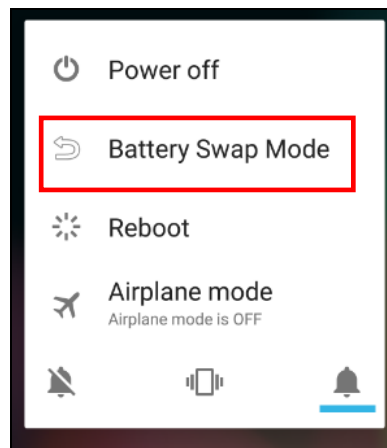

2. The LED indicator will start showing solid red light. **Please swap the battery after the LED red light goes off.** Make sure do not turn on PA730 during the battery swap process.



3. When the battery swap is done, press the power button to restart PA730.

*Note:* Please see [1.4.1 Installing the Battery](#) for more information.

## Chapter 3 – Introduction to Applications

### 3.1 Scan Service

---

1. Tap  go to APPS, then tap  **ScanService**.
2. You are now enter the ScanService application. There are three main items : **Settings, Test and Version**.

**Note :** For more Scan Service settings, please refer to [2.1 Barcode Setting](#).

#### 3.1.1 Test

1. Scanned data information / Save / Clear all scanned data.  
Tap **Test** to start scanning barcodes.

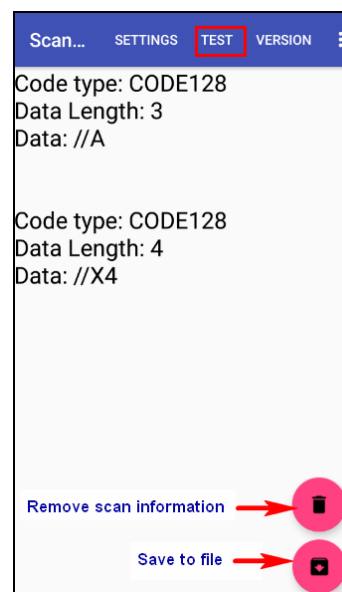

2. Aim the Barcode Scan Engine to the barcode and press one of two scan buttons.

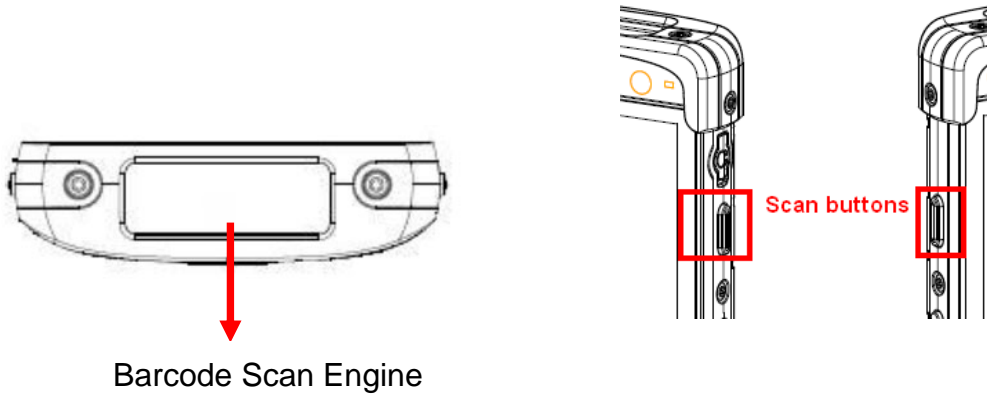

3. After scanning the barcodes, the barcode information is as shown below.

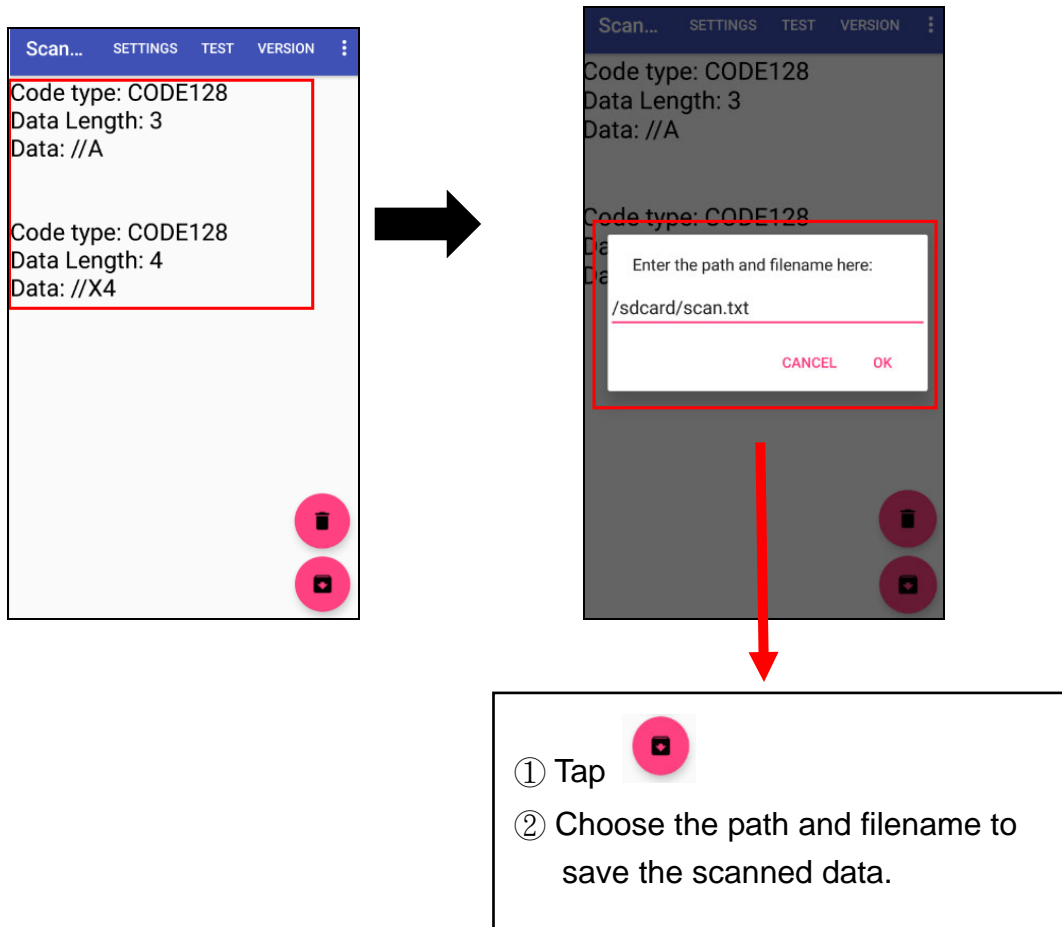

### 3.1.2 More Options

- For more options and settings, please tap .

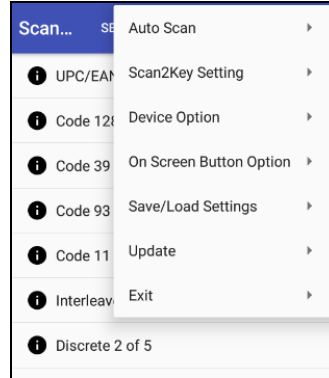

- Auto Scan**

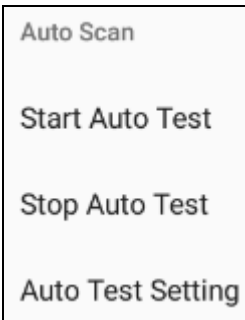

- Scan2key Setting**

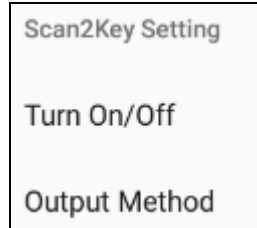

- Device Option**

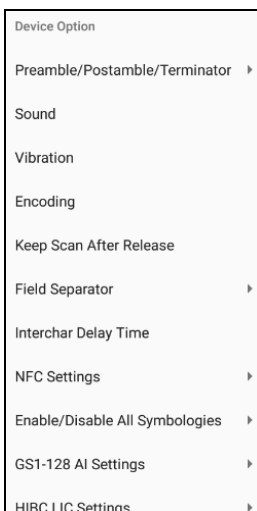

- On Screen Button Option**

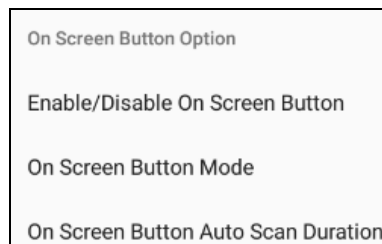

- Save / Load Settings**

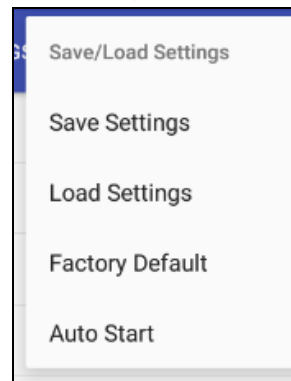

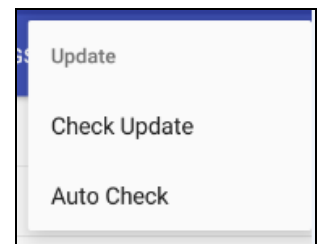

- Update**





## 3.2 File Manager

1. Tap  go to APPS, and tap  **File Manager**.

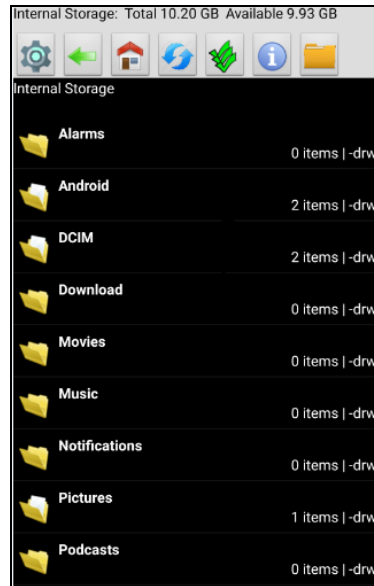

: Settings



: Return to the previous page



: Main page



: Refresh



: Folder arrangement



: Folder Information



: Solutions

## 3.3 Update Center

1. Tap  go to APPS, and tap  **Settings**, and then tap **About Phone** to search for **System updates**.

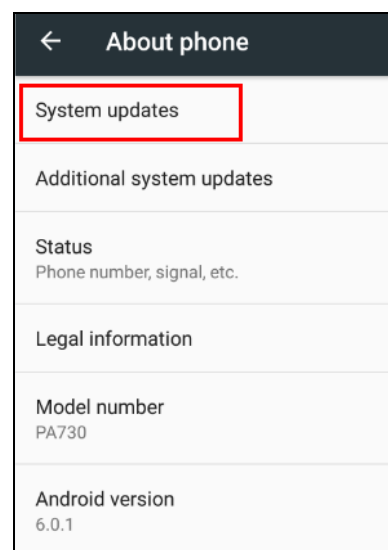
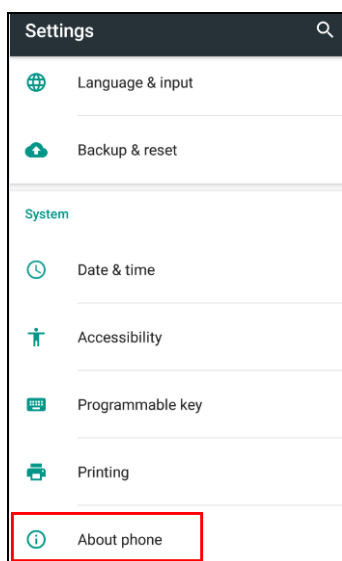

Or tap  for system updates.

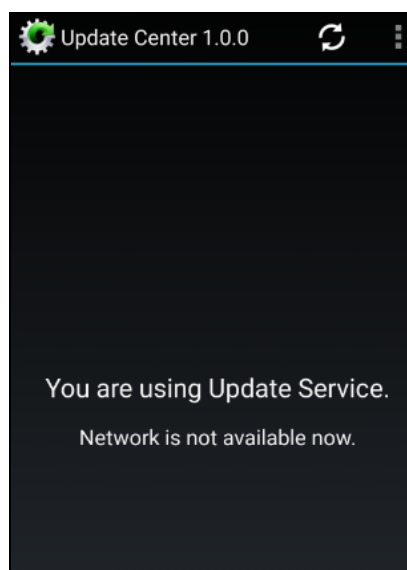

2. To update or check the latest version of software and applications, you will need to do it manually.



## 3.4 Sound Recorder

1. Tap  go to APPS, and tap  **Sound Recorder**.
2. **Recording** : Tap  to start the sound recording.

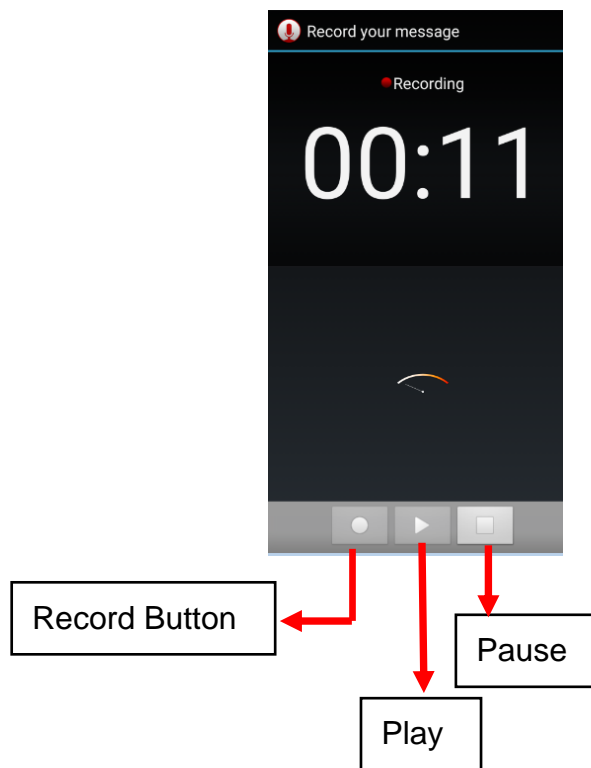

3. After recording messages, all the recording files will be saved in [filemanger](#). Please tap  first to refresh all the files.

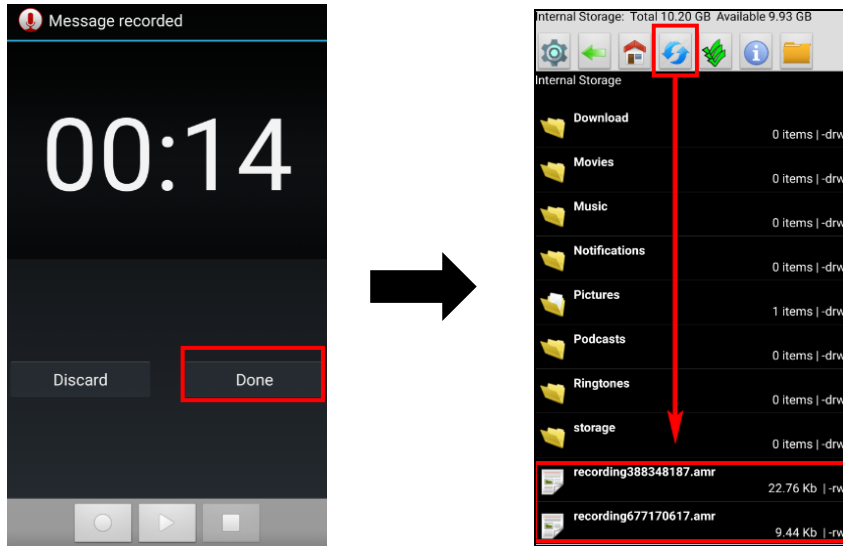

4. Long press the recording files for more file operations.

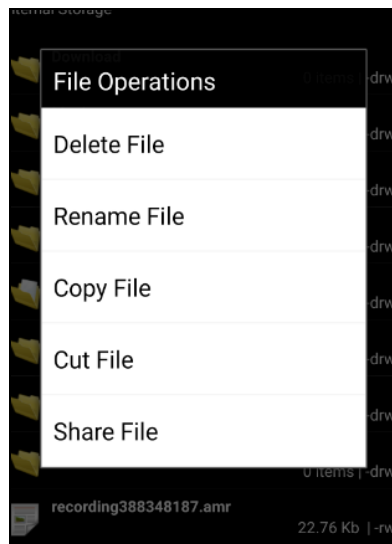

## 3.5 Push To Talk

---

To operate push to talk, please go to Google Play store  to download the walkie talkie apps which can support any android device.

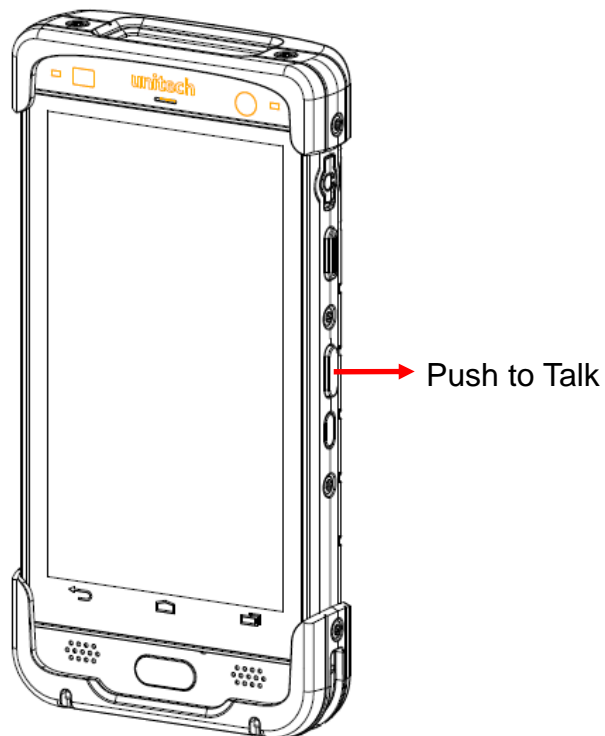

For example, *Zello PTT Walkie Talkie* is the most recommended walkie talkie app.



## 3.6 MoboLink

---

MoboLink is a software platform that helps unitech customers to remote manage their purchased devices and applications. The core of the MoboLink platform provides functionalities in the MDM (Mobile Device Management) and MAM (Mobile Application Management) domains, and then further extends into other management functions such as alert notification management and account management.

1. Tap  go to APPS, and tap  **MoboLink**.

**MoboLink** will run in the background.

*Note: If there is no internet connection, **MoboLink** will be activated after few seconds.*

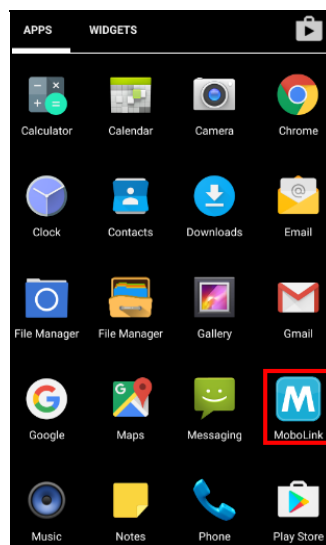

2. **MoboLink** setting is shown as below :

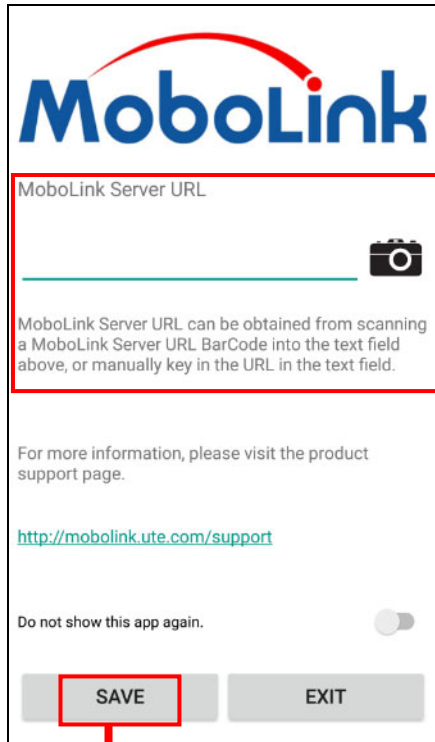

Enter **MoboLink** server URL manually in the text field or scan a **MoboLink** server URL Barcode

Tap "**Save**" to initiate **MoboLink Server URL**

3. **MoboLink** screen information is as below:

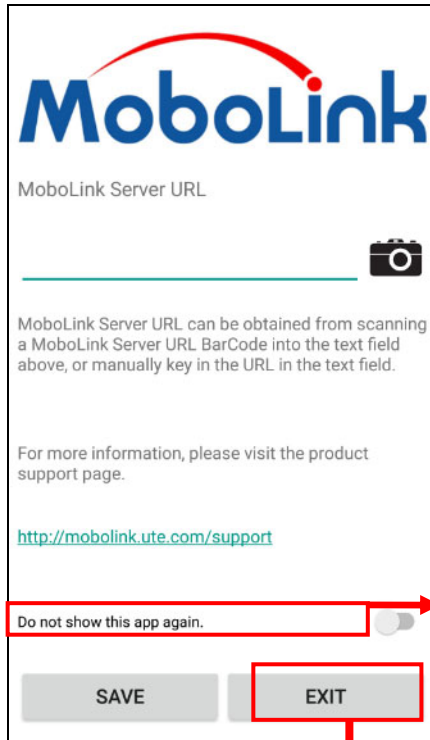

Slide **ON/OFF** button to show **MoboLink**

Tap **“Exit”** to leave the screen



### 3.6.1 More about MoboLink

For detailed operation, solution and usage, please refer to **MoboLink** user's guide. ( <http://mobolink.tw.ute.com/support> )

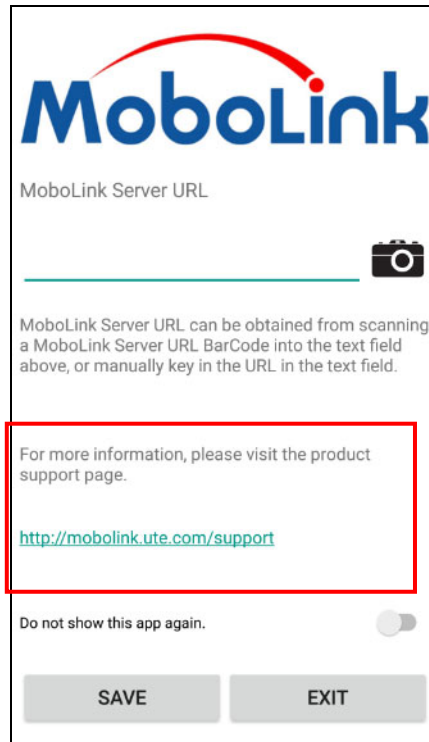

## 3.7 SOTI

PA730 is supported by SOTI which provides advanced helpdesk solutions for our users. To download SOTI, please go to : <https://www.soti.net/oem>

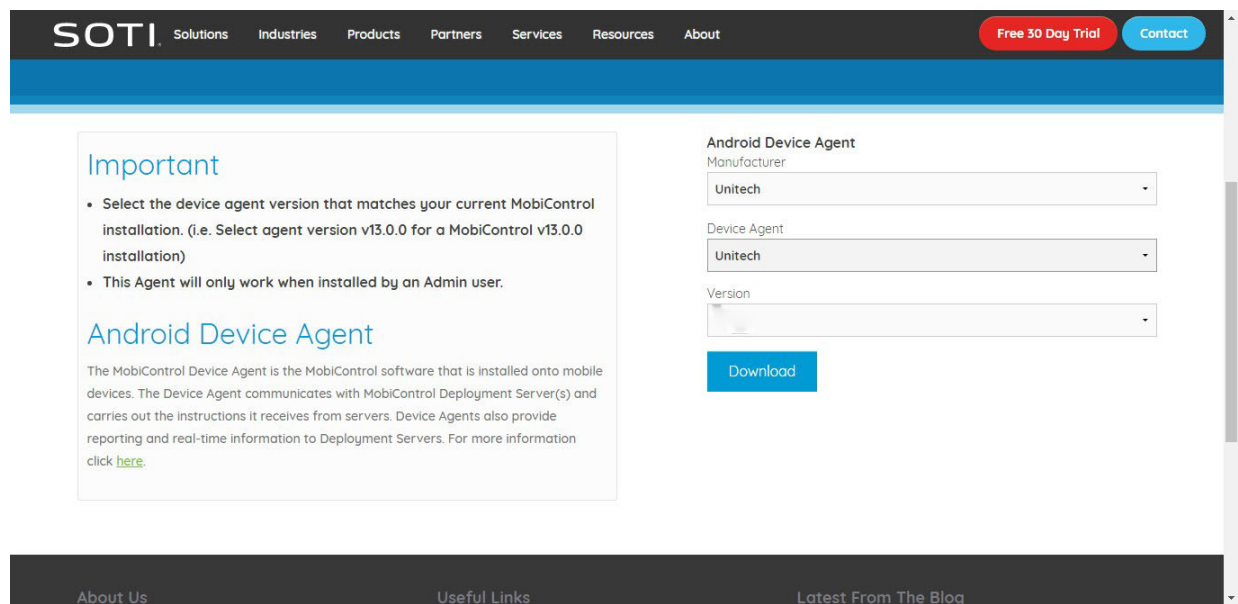

The screenshot shows the SOTI website interface. At the top, there is a navigation bar with the SOTI logo and menu items: Solutions, Industries, Products, Partners, Services, Resources, and About. On the right side of the navigation bar, there are two buttons: "Free 30 Day Trial" (red) and "Contact" (blue). Below the navigation bar, the main content area is divided into two columns. The left column features a section titled "Important" with two bullet points: "Select the device agent version that matches your current MobiControl installation. (i.e. Select agent version v13.0.0 for a MobiControl v13.0.0 installation)" and "This Agent will only work when installed by an Admin user." Below this is a section titled "Android Device Agent" with a paragraph of text and a link "click here." The right column contains a form titled "Android Device Agent" with three dropdown menus: "Manufacturer" (set to Unitech), "Device Agent" (set to Unitech), and "Version". Below the dropdowns is a blue "Download" button. At the bottom of the page, there is a dark footer bar with three links: "About Us", "Useful Links", and "Latest From The Blog".