

RCA

INSTRUCTION MANUAL

MRM400

VHF Marine Two-Way Radio



RCA Communications Systems

TO USER:

Thank you for purchasing this marine radio. You will find the professional and human oriented design of the transceiver during use. Please read all instructions carefully and completely before using the transceiver.

CAUTION

- Never use the Distress call when your ship or a person is not in an emergency.
- Do not use or place the transceiver in areas with heat, humidity and dust.
- The working voltage for the transceiver is 13.8V. If the power source is 24V, please use a power converter (24V convert to 13.8V), or the transceiver won't work.
- Never directly connect to AC220V, this will ruin the transceiver. If an abnormal odor or smoke is detected coming from the transceiver, turn off the power immediately.
- Do not transmit before connecting the antenna, this will ruin the transceiver.
- After long time use, the heating panel becomes hot, that is normal state.

CONTENTS

PREPARATION

Supplied accessories.....	1
Transceiver mounting.....	1
Antenna connection.....	2
Connections.....	2
Dimensions.....	3

PANEL DESCRIPTION

Front panel.....	4
Microphone.....	5
Function display.....	5

BASIC OPERATION

Power ON / OFF.....	7
Receiving and transmitting.....	7
Channel group selection.....	7
Channel selection.....	7
Call channel programming.....	8
Channel comments.....	9
Microphone lock function.....	9
Display backlighting.....	9
AquaQuake water draining function.....	9

SCAN OPERATION

Scan types.....	10
Setting TAG channels.....	10
Starting a scan.....	10

DUAL-WATCH / TRI-WATCH

Description.....	11
Operation.....	11

DSC OPERATION

MMSI code programming.....	12
MMSI code check.....	12
DCS address ID.....	12
Distress call.....	13
Individual call.....	14
Group call.....	16
All Ships call.....	17
Geographical Area call.....	18
Position indication.....	18

SET MODE

Set mode programming.....	21
Set mode items.....	21

CHANNEL LIST.....	23
SPECIFICATIONS.....	24
TROUBLESHOOTING.....	24

PREPARATION

■ Supplied accessories

The following accessories are supplied:

ITEM	QTY
DC power cable	1
Spare fuse	1
Mounting bracket	1
Screws for mounting bracket	1
Microphone hanger	1
Instruction manual	1

■ Transceiver mounting

◆ Using the supplied mounting bracket

The universal mounting bracket supplied with your transceiver allows overhead or dashboard mounting.

1. Fix the mounting bracket to shelf or dashboard with the supplied screws and mount the transceiver to the mounting bracket with the knob bolts.
2. Mount the transceiver so that the face of the transceiver is at 90° to your line of sight when operating it and tighten the knob bolts so that the transceiver is securely mounted.
 - You may use a spongy cushion between the transceiver and mounting bracket to reduce the vibration.

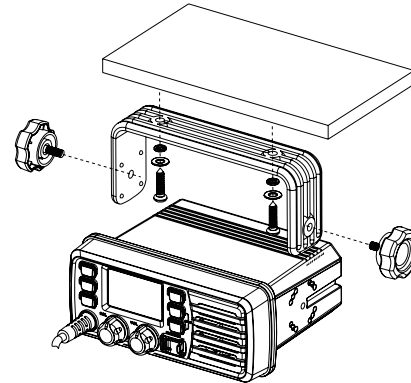

◆ Embedded mounting

1. Cut a hole into the instrument panel (or wherever you plan to mount the transceiver).
2. Slide the transceiver through the holes as shown below.

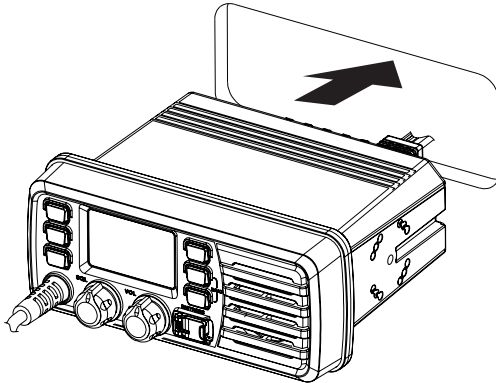

3. Attach the clamps on either side of the transceiver with 2 supplied bolts.

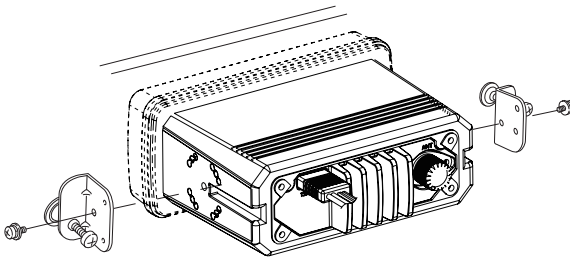

4. Tighten the end bolts on the clamps so that the clamps press firmly against the inside of the instrument control panel.

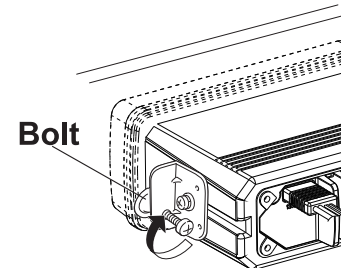

■ Antenna connection

Please connect an antenna before transmitting. Select the antenna with the relative frequency and connect on the ANT antenna connector. Use the antenna and low loss concentric with the same natural impedance 50Ω .

- Transmitting without an antenna may damage the transceiver.

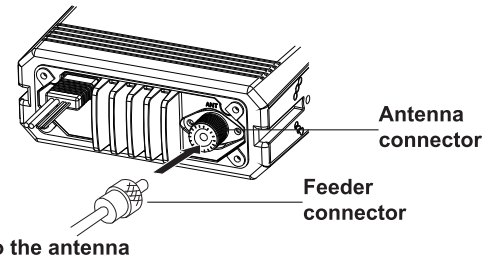

■ Connections

After connecting the DC power cable, GPS receiver lead and external speaker lead, cover the connector and leads with an adhesive tape as below, to prevent water seeping into the transceiver.

Rubber vulcanizing tape

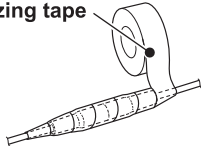

DC15A/32V.

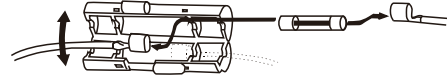

◆ External speaker lead

Connect to an external speaker.

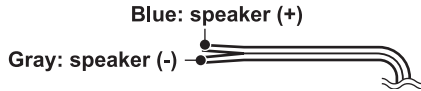

◆ GPS receiver lead

Connect to a GPS receiver for position indication.

- An NMEA0183 ver.2.0 or 3.01 (sentence formatters RMC, GGA, GNS, GLL) compatible GPS receiver is required.

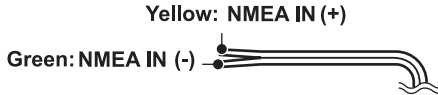

◆ DC power connector

Connect the supplied DC power cable from this connector to an external 13.8V DC power source. Do not connect to 24V storage battery.

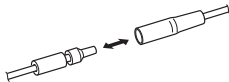

◆ Fuse replacement

One fuse is installed in the supplied DC power cable. If a fuse blows or the transceiver stops functioning, track down the source of the problem, if possible, and replace the damaged fuse with a new, rated one.

- Please power off before replacing the fuse, the required fuse is

■ Dimensions

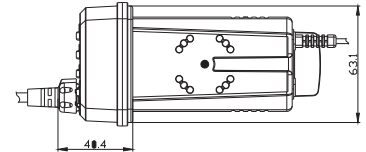
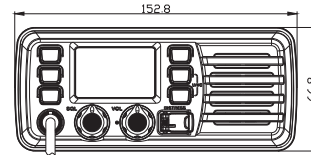
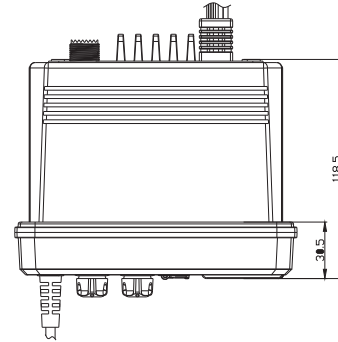

PANEL DESCRIPTION

■ Front panel

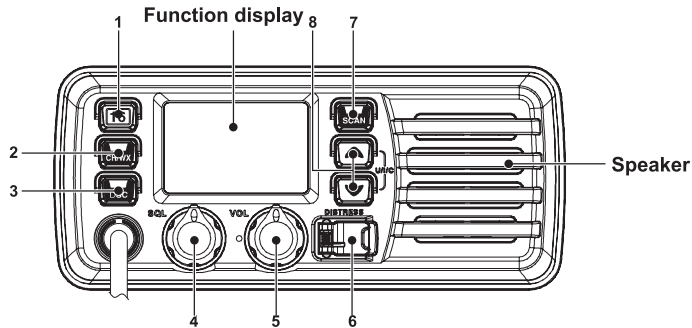

1. Channel 16 / Call Channel Key [16]

- Push to select Channel 16.
- Push and hold for 1 sec. to select call channel.
“CALL” appears when the call channel is selected.
- While pushing and holding [CH/WX], push [16] to enter the channel comments programming condition.
- Push to move the cursor backward.
- While turning power ON, push [16] to enter set mode.

2. Channel / Weather Channel Key

- Select and toggle the regular channel and weather channel when pushed momentarily.
- Push and hold for 1 sec. to start Dualwatch or Tri-watch.
- Push to stop Dualwatch or Tri-watch when either is activated.
- Push to move the cursor forward.

3. DSC / Position Key

- Push to enter DSC menu.
- Push and hold for 1 sec. to show the current position from a GPS receiver.

4. Squelch Control [SQL]

- Rotate to set the squelch threshold level.

5. Power / Volume Control [VOL]

- Rotate to turn the transceiver power ON and OFF and adjusts the audio level.

6. Distress Key [DISTRESS]

- Push and hold for 5 sec. to transmit a Distress call.

7. Scan / Tag Key [SCAN]

- Push to start or stop the normal or priority scan.
- Push and hold for 1 sec. to set or clear the displayed channel as a TAG (scanned) channel.
The favorite channels are set by the TAG channel setting.
- Push and hold [HI/LO] and [SCAN] to clear all TAG channels in the selected channel group.
Repeat above procedure to set all TAG channels.

8. [▲][▼] / [U/I/C]

- Select the operating channels, set mode settings, etc.
- While pushing and holding [SCAN], push [▲] or [▼] to adjust the brightness of the LCD and key backlight.
- Select one of three channel groups in sequence when both keys are pushed.
- While turning power ON, push and hold both keys to activate the AquaQuake function.

■ Microphone

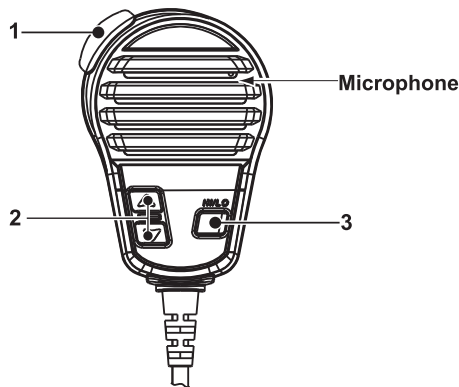

1. [PTT]

→ Push and hold to transmit; release to receive.

2. Channel UP / DOWN Keys[▲]/[▼]

- Push either key to change the operating channel, set mode settings, etc.
- When the favorite channel function is turned ON, push either key to select the favorite channels in the selected channel group in sequence.

3. Transmit Power Key [HI/LO]

- Push to toggle the power high and low.
- Some channels are set to low power only.
- While push and hold [HI/LO], turn power ON to toggle the microphone lock function ON and OFF.

■ Function display

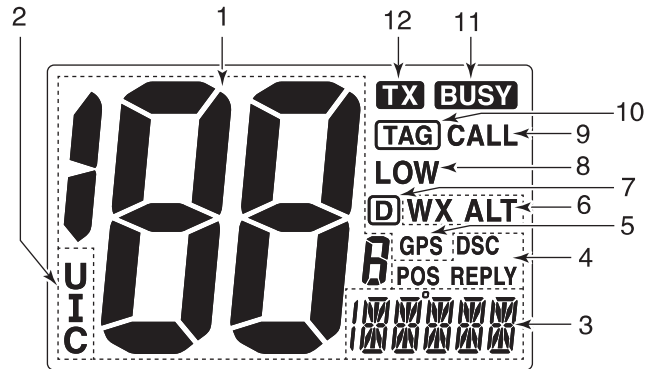

1. Channel Number Readout

- Indicate the selected operating channel number. (Refer to channel list)
- In set mode, indicate the selected condition.

2. Channel Group Indicator

Indicate whether a U.S.A. "U", International "I" or Canadian "C" channel is in use.

3. Channel Comment Indicator

- Channel comment appears if programmed.
- "LOW BATTERY" scrolls when the battery voltage drops approx. 10.8V DC or below.
- "SC" blinks during priority scan; "SCAN" blinks during normal scan.
- "DW" blinks during Dualwatch; "TW" blinks during Tri-watch.

4. DSC Indicators

- "DSC" appears when a DSC call is received.
- "POS REPLY" appears when a position reply call or position report reply

call is received.

5. GPS Indicator

- Appears while valid position data is received.
- Blinks when invalid position data is received.
- Disappears when no GPS receiver is connected.

6. Weather Channel Indicator

- “WX” appears when a weather channel is selected.
- “WX ALT” appears when the weather alert function is in use; blinks when an alert tone is received.

7. Duplex Indicator

Appears when a duplex channel is selected.

8. Low Power Indicator

Appears when low power is selected.

9. Call Channel Indicator

Appears when the call channel is selected.

10. TAG Channel Indicator

Appears when a TAG channel is selected.

11. Busy Indicator

Appears when receiving a signal or when the squelch opens.

12. Transmit Indicator

Appears while transmitting.

BASIC OPERATION

■ Power ON / OFF

1. Rotate [VOL] clockwise to turn power on;
2. Rotate [VOL] counter-clockwise to turn power off.

■ Receiving and transmitting

◆ Transmitting

1. Push [HI/LO] on the microphone to select the output power if necessary.
 - "LOW" appears when low power is selected.
 - Choose low power for short range communication, choose high power for longer distance communication.
 - Some channels are for low power only.
2. Push and hold [PTT] to transmit, then speak into the microphone.
 - "TX" appears.
 - Channel 70 cannot be used for transmission other than DSC.
3. Release [PTT] to receive.

Note:

- Do not transmit before connecting the antenna, this will ruin the transceiver.
- The TOT (Time-out Timer) function inhibits continuous transmission over a preset time period after the transmission starts.

◆ Receiving

1. Set the audio and squelch levels.
2. Rotate [SQL] fully counterclockwise in advance.
3. Rotate [VOL] to adjust the audio output level.
4. Rotate [SQL] clockwise until the noise disappears.
 - "When receiving a signal, "BUSY" appears and audio is emitted from the speaker.

■ Channel group selection

The transceiver is pre-programmed with 59 U.S.A., 59 international and 63 Canadian channels. These channel groups may be specified for the operating area.

1. Push [CH/WX] to select a regular channel.
 - If a weather channel appears, push [CH/WX] again.
2. Push [U/I/C] (both [▲] and [▼] on the transceiver to change the channel group, if necessary.
 - U.S.A., International and Canadian channel groups can be selected in sequence.
3. Push [▲] or [▼] to select a channel.
 - "D" appears for duplex channels.

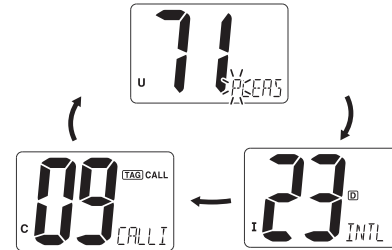

■ Channel selection

◆ Channel 16

Channel 16 is the distress and safety channel. It is used for establishing initial contact with a station and for emergency communication. Channel 16 is monitored during both Dual-watch and Tri-watch. While standing by, you must monitor Channel 16.

1. Push [16] momentarily to select Channel 16.
2. Push [CH/WX] to return to the condition before selecting Channel 16, or push [▲] or [▼] to select operating channel.



Convenient:

When the favorite channel function is turned ON, [▲]/[▼] keys on the microphone select the favorite channels in the selected channel group in sequence when pushed.

- The favorite channels are set by the TAG channel setting. (P.10)

◆ Channel 9 (Call channel)

Each regular channel group has a separate leisure-use call channel (Channel 9; default). The call channel is monitored during Tri-watch.

1. Push and hold [16] for 1 sec. to select the call channel of the selected channel group. "CALL" and call channel number appear.
2. Push [CH/WX] to return to the condition before selecting call channel, or push [▲] or [▼] to select a channel.



◆ Weather channels

The transceiver has 10 pre-programmed weather channels. The transceiver can automatically detect a weather alert tone on the selected weather channel while receiving the channel or during scanning.

1. Push [CH/WX] once or twice to select a weather channel.

- "WX" appears when a weather channel is selected.
 - "WX ALT" appears when the weather alert function is in use.
2. Push [▲] or [▼] to select a channel.



When weather alert is OFF.

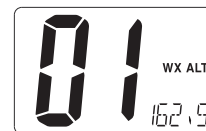

When weather alert is ON.

■ Call channel programming

Call channel is used to select Channel 9 (default), however, you can program the call channel with your most offer-used channel in each channel group for quick recall.

1. Push [U/I/C] (both [▲] and [▼] on the transceiver several times to select the desired channel group (U.S.A., International or Canada) to be programmed.
2. Push and hold [16] for 1 sec. to select the call channel of the selected channel group.
 - "CALL" and call channel number appear.
3. Push and hold [16] again for 3 sec. (until a long beep changes to 2 short beeps) to enter call channel programming condition.
 - Channel number starts blinking.



4. Push [▲] or [▼] to select the desired channel.
5. Push [16] to program the displayed channel as the call channel.
 - Push [CH/WX] to cancel.



■ Channel comments

Memory channels can be labeled with a unique alphanumeric ID of up to 10 characters each. More than 6 characters comment scrolls automatically at the channel comment indicator after the channel selection.

Capital letters, small letters (except f, j, k, p, s, v, x, z), 0 to 9, some symbols (= * + - . /) and space can be used.

1. Select the desired channel.
 - Cancel Dualwatch, Tri-watch or scan in advance.
2. While pushing **[CH/WX]**, push **[16]** to edit the channel comment.
 - A cursor and the first character start blinking alternately.

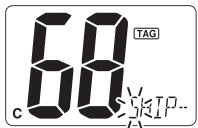

3. Pushing **[▲]** or **[▼]** to select the desired character.
 - Push **[16]** or **[CH/WX]** to move the cursor forward or backward, respectively.
4. Repeat step ③ to input all characters.
5. Push **[DSC]** to input and set the comment.
 - Push **[SCAN]** to cancel.
 - The cursor and the character stop blinking.

■ Microphone lock function

The microphone lock function electrically locks **[▲]** and **[▼]** keys on the supplied

microphone. This prevents accidental channel changes and function access.

→ While pushing and holding **[HI/LO]** on the microphone, turn power ON to toggle the microphone lock function ON and OFF.

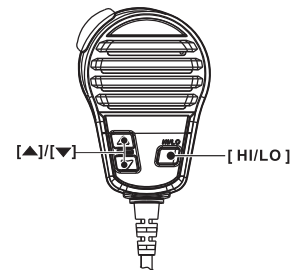

■ Display backlighting

The function display and keys can be backlit for better visibility under low light conditions.

→ While pushing and holding **[SCAN]**, push **[▲]** or **[▼]** to adjust the brightness of the LCD and key backlight.

- The backlight is selectable in 3 levels and OFF.

■ AquaQuake water draining function

AquaQuake helps drain water away from the speaker housing (water that might otherwise muffle the sound coming from the speaker). The transceiver emits a vibrating noise when this function is being used.

1. While pushing and holding **[▲]** and **[▼]**, turn power ON.
 - "AQUA QUAKE" appears.
2. A low beep tone sounds while **[▲]** or **[▼]** keys are held to drain water, regardless of **[VOL]** control setting.
 - The transceiver never accepts a key operation while the AquaQuake function is activated.

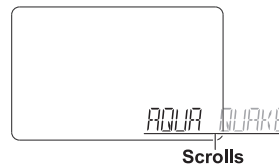

SCAN OPERATION

■ Scan types

The transceiver has priority scan and normal scan. (Refer to set mode programming).

When the weather alert function is turned ON, the previously selected (last used) weather channel is also checked while scanning.

Set the TAG channels (scanned channels) before scanning. Clear the TAG channels which inconveniently stop scanning.

Normal scan:

Normal scan searches through all TAG channels in sequence. Channel 16 is not checked unless Channel 16 is set as a TAG channel.

Priority scan:

Priority scan searches through all TAG channels in sequence while monitoring Channel 16.

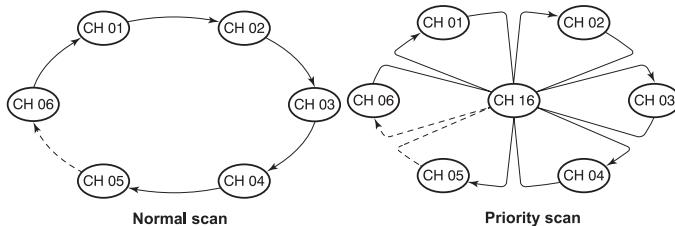

■ Setting TAG channels

For more efficient scanning, add desired channels as TAG channels or clear the TAG for unwanted channels.

Channels that are not tagged will be skipped during scanning.

◆ Setting / clearing a single tagged channel

1. Push [U/I/C] (both [▲] and [▼]) several times to select the desired channel group.
2. Select the desired channel to be set as a TAG channel.
3. Push and hold [SCAN] for 1 sec. to set the displayed channel as a TAG channel.
 - "TAG" appears in the display.
4. To cancel the TAG channel setting, repeat step ③.
 - "TAG" disappears.

◆ Setting / clearing all tagged channels

1. While pushing and holding [HI/LO] on the microphone, push [SCAN] for 3 sec. to clear all TAG channels in the selected channel group.
2. Repeat above procedure to set all TAG channels.

■ Starting a scan

Set scan resume timer in advance using Set mode.

1. Push [SCAN] to start priority or normal scan.
 - "SC" blinks during priority scan; "SCAN" blinks during normal scan.
 - Channel 16 is monitored during priority scan.
 - Push [▲] or [▼] to change the scanning direction.
 - A beep tone sounds and "SC 16" blinks at the channel comment indicator when a signal is received on Channel 16 during priority scan.
2. To stop the scan, push [SCAN].

DUAL-WATCH / TRI-WATCH

■ Description

The transceiver has Dualwatch and Tri-watch.

Dualwatch monitors Channel 16 while you are receiving on another channel.

Tri-watch monitors Channel 16 and the call channel while receiving another channel.



Dualwatch

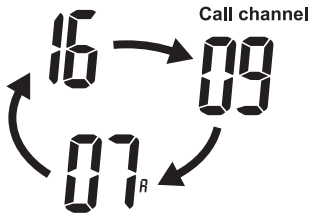

Tri-watch

■ Operation

1. Select Dualwatch or Tri-watch in set mode.
2. Select the desired channel.
3. Push and hold [CH/WX] for 1 sec. to start Dualwatch or Tri-watch.
 - "DW" blinks during Dualwatch; "TW" blinks during Tri-watch.
 - A beep tone sounds when a signal is received on Channel 16.
4. To cancel Dualwatch or Tri-watch, push [CH/WX].



Dualwatch



Tri-watch

DSC OPERATION

■ MMSI code programming

The 9-digit MMSI (Maritime Service Identity: DSC self ID) code can be programmed at power ON.

1. Rotate [VOL] to turn power OFF.
2. While pushing and holding [DSC], turn power ON to enter MMSI code programming condition.
3. After the display appears, release [DSC], a cursor starts blinking.

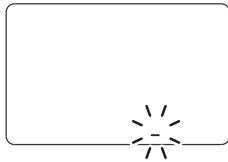

4. Edit the specified MMSI code by pushing [▲] or [▼].
 - Push [16] or [CH/WX] to move the cursor forward or backward, respectively.
5. Input 9-digit code, then push [DSC] to set the code.
 - Returns to the normal operation.

Note:

- This code programming can be performed only twice. After the code programming, it can be changed only by your dealer or distributor.

■ MMSI code check

The 9-digit MMSI (DSC self ID) code can be checked.

1. Push [DSC] to enter the DSC menu.
2. Push [▲] or [▼] to select "MMSI" and push [DSC].



3. Check the 9-digit MMSI (DSC self ID) code.
 - The MMSI code is displayed and scrolls at the channel comment indicator.

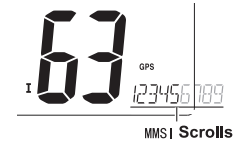

4. Push [DSC] to return to the normal operation.

■ DCS address ID

A total of 30 DSC address IDs (9-digit) can be programmed and named with up to 5 characters.

◆ Programming address ID

1. Push [DSC] to enter the DSC menu.
2. Push [▲] or [▼] to select "ADDRESS", and push [DSC].



3. Push [▲] or [▼] to select "ADD", and push [DSC].



4. Push [▲] or [▼] to input 9-digit of the appropriate address ID.
 - Push [16] or [CH/WX] to move the cursor forward or backward, respectively.
 - Push [SCAN] to cancel and exit the condition.

Note: 1st digit "0" is fixed for a group ID. When you input 1st digit "0" and other 8 digits, the ID is automatically registered as a group ID.



5. After inputting 9-digit ID, push [DSC] to input 5 characters ID name using [▲] or [▼].
 - Push [16] or [CH/WX] to move the cursor forward or backward, respectively.
 - Push [SCAN] to cancel and exit the condition.
6. Push [DSC] to program and exit the DSC menu.

◆ Deleting address ID

1. Push [DSC] to enter the DSC menu.
2. Push [▲] or [▼] to select "ADDRESS" and push [DSC].



3. Push [▲] or [▼] to select "DEL", then push [DSC].

- When no address ID is programmed, "NO ID" is displayed.



4. Push [▲] or [▼] to select the desired ID name for deleting and push [DSC], "READY" appears.



■ Distress call

A Distress call should be transmitted if, in the opinion of the master, the ship or a person is in distress and requires immediate assistance.

Note: Never use the Distress call when your ship or a person is not in an emergency. A Distress call can be used only when immediate help is needed.

◆ Transmitting a Distress call

1. While opening the key cover, push [DISTRESS] for 5 sec. to transmit the Distress call.
 - Emergency channel (Channel 70) is automatically selected and the Distress call is transmitted.



2. After transmitting the call, the transceiver waits for an acknowledgment call on Channel 70.
 - The Distress call is automatically transmitted about every 4 minutes.
 - "DSC REPEAT" scrolls at the channel comment indicator.

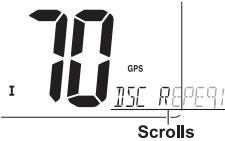

3. After receiving the acknowledgment, reply using the microphone.
 - “RCV DISTRESS ACK” scrolls at the channel comment indicator.
4. Push and hold [DISTRESS] for 5 sec. to transmit a re-newed Distress call, if desired.
5. Push any key except [DISTRESS] to cancel the ‘call repeat’ mode.

Note: A distress alert contains:

- Kinds of distress: Undesignated distress
- Position data: GPS position data held until receiving an ‘acknowledgement’.

◆ Receiving a Distress call

While monitoring Channel 70 and a Distress call is received:

1. The emergency alarm sounds.
 - Push any key to stop the alarm.
2. “DSC” appears and “RCV DISTRESS” scrolls at the channel comment indicator, then Channel 16 is automatically selected.
3. Continue monitoring Channel 16 as a coast station may require assistance.



◆ Receiving a Distress acknowledgement

While monitoring Channel 70 and a Distress acknowledgement to other ship is received:

1. The emergency alarm sounds.
 - Push any key to stop the alarm.

2. “DSC” appears and “RCV DISTRESS ACK” scrolls at the channel comment indicator, then Channel 16 is automatically selected.

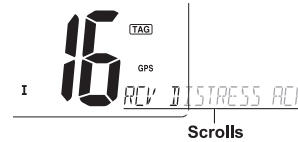

◆ Receiving a Distress Relay call

While monitoring Channel 70 and a Distress Relay acknowledgement is received:

1. The emergency alarm sounds.
 - Push any key to stop the alarm.
2. “DSC” appears and “RCV RELAY” scrolls at the channel comment indicator, then Channel 16 is automatically selected.



■ Individual call

The Individual call function allows you to transmit a DSC signal to a specific ship only.

◆ Transmitting Individual call

1. Push [DSC] to enter the DSC menu.
 - “INDIVIDUAL” scrolls at the channel comment indicator.

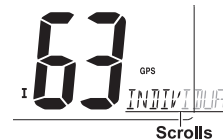

- Push **[DSC]** to select the desired pre-programmed individual address using **[▲]** or **[▼]**, then push **[DSC]**.
 - The ID code for the Individual call must be set in advance.



- Push **[▲]** or **[▼]** to select a desired intership channel, push **[DSC]**.
 - Intership channels are already preset into the transceiver in recommended order.
 - Channel 70 is selected and "READY" appears after pushing **[DSC]**.

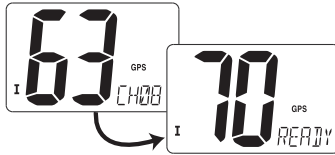

- Push **[DSC]** to transmit the Individual call.
 - If Channel 70 is busy, the transceiver stands by until the channel becomes clear.



- After transmitting the Individual call, standby on Channel 70 until an acknowledgement is received.
 - "WAIT ACK" scrolls at the channel comment indicator.



- When the acknowledgement 'Able to comply' is received, the specified channel (in step ③) is selected with beeps automatically. Or, when the acknowledgement 'Unable to comply' is received, the display returns to the operated channel (before entering the DSC menu) with beeps.
 - "RCV ABLE ACK" OR "RCV UNABLE ACK" scrolls at the channel comment indicator.

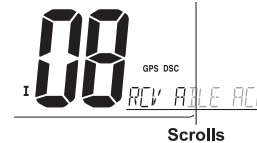

- Push and hold **[PTT]** to communicate your message to the responding ship when 'Able to comply' is received.

◆ Transmitting Individual acknowledgement

When receiving an Individual call, you can transmit an acknowledgement ('Able to comply' or 'Unable to comply') by using the on screen prompts (refer to "Receiving an Individual call"). You can also send an acknowledgement through the menu system as follows.

- Push **[DSC]** to enter the DSC menu.
- Push **[▲]** or **[▼]** to select "INDV ACK" and push **[DSC]**.
 - "INDV ACK" item appears after an Individual call is received.
 - "INDV ACK" item disappears if another call is received after the Individual call.
 - The Individual acknowledgement can be transmitted to the last received Individual call only.



- Push **[▲]** or **[▼]** to select the acknowledgement "ABLE" or "UNABL".



4. Push [DSC] to enter the standby condition for Individual acknowledgement call.

- "READY" appears at the channel comment indicator.



5. Push [DSC] to transmit the acknowledgement to the selected station.



6. After the Individual acknowledgement has been transmitted, the display changes to the channel specified by the calling station automatically when "ABLE" is selected.

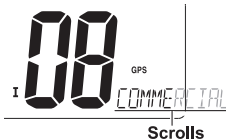

◆ Receiving an Individual call

While monitoring Channel 70 and an Individual call is received:

1. The emergency alarm or beeps sound depending on the received category.
2. "DSC" appears and "RCV INDIVIDUAL" scrolls at the channel comment indicator.
3. Push any key to stop beep.
4. Push [DSC] to reply the call and select the channel specified by the calling station for voice communication; Push any other key to ignore the Individual call.

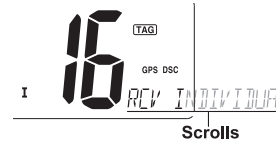

■ Group call

The Group call function allows you to transmit a DSC signal to a specific group only.

◆ Transmitting Group call

1. Push [DSC] to enter the DSC menu.
2. Push [▲] or [▼] to select "GROUP", and push [DSC].



3. Push [▲] or [▼] to select the desired pre-programmed group address, and push [DSC].

- The ID code for the Group call must be set in advance.



- Push [**▲**] or [**▼**] to select the desired intership channel, and push [**DSC**].
 - Channel 70 is selected and "READY" appears.

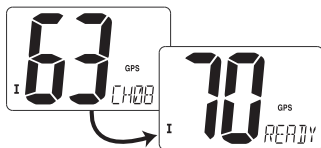

- Push [**DSC**] to transmit the Group call.
 - If Channel 70 is busy, the transceiver stands by until the channel become clear.



- After the Group call has been transmitted, the display changes to the previously specified channel.



- Push and hold [**PTT**] to communicate your message to the responding ship.

◆ Receiving a Group call

While monitoring Channel 70 and a Group call is received:

- The emergency alarm or beeps sound depending on the received category.
- "DSC" appears and "RCV GROUP" scrolls at the channel comment indicator.

- Push any key to stop beep.
- Push [**DSC**] to select the channel specified by the calling station for voice communication; Push any other key to ignore the Group call.



■ All Ships call

The All Ships call function allows you to transmit a DSC signal to all ships.

◆ Transmitting All Ships call

Large ships use Channel 70 as their 'listening channel'. When you want to announce a message to these ships, use the 'All Ships call' function.

- Push [**DSC**] to enter the DSC menu.
- Push [**▲**] or [**▼**] to select "ALL SHIPS".

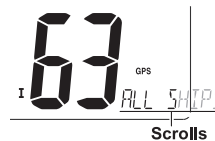

- Push [**DSC**] to enter the standby condition for All Ships call.
 - Channel 70 is selected and "READY" appears.



- Push [**DSC**] to transmit the All Ships call.

- Low power is selected.



5. After the All Ships call has been transmitted, the display changes to Channel 16 automatically.



◆ Receiving an All Ships call

While monitoring Channel 70 and an All Ships call is received:

1. The emergency alarm sounds when the category is 'Distress' or 'Urgency'; 2 beeps sound for other categories.
2. "DSC" appears and "RCV ALL SHIPS" scrolls at the channel comment indicator.
3. Push any key to stop beep.
4. Push [DSC] to monitor channel 16 for an announcement from the calling vessel, push any other key to ignore the call.

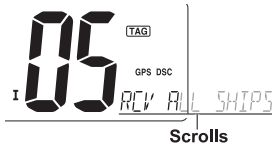

■ Geographical Area call

The Geographical Area call function allows you to transmit a DSC signal to all ships in a geographical area.

◆ Receiving a Geographical Area call

While monitoring Channel 70 and a Geographical Area call (for the area you are in) is received:

1. The emergency alarm or beeps sound depending on the received category.
2. "DSC" appears and "RCV GEOGRAPHICAL" scrolls at the channel comment indicator.
3. Push any key to stop the beep.
4. Push [DSC] to change to the channel specified by the calling station for voice communication; Push any other key to ignore the Geographical Area call.

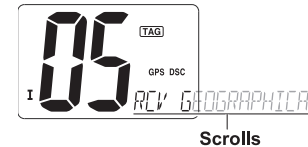

■ Position indication

◆ Positioning instructions

When a GPS receiver is connected, the transceiver indicates the current position data in seconds of accuracy.

A NMEA0183 ver. 2.0 or 3.01 (sentence formatters RMC, GGA, GNS, GLL) compatible GPS receiver is required.

Push and hold [DSC] for 1 sec. to display the current position.

- 'Latitude' and 'Longitude' scroll in sequence at the channel comment indicator.
- "NO POSITION" scrolls when no GPS is connected.
- "GPS" blinks when the GPS data is invalid.

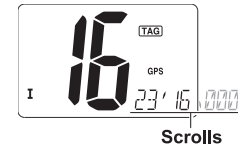

◆ Transmitting Position Request call

Transmit a Position Request call when you want to know a specified ship's current position, etc.

1. Push [DSC] to enter the DSC menu.
2. Push [▲] or [▼] to select "POS REQUEST", then push [DSC].

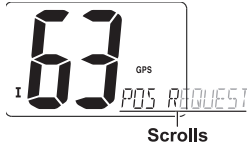

3. Push [▲] or [▼] to select the desired pre-programmed individual address.
 - The ID code for position request must be set in advance.



4. Push [DSC] to enter the standby condition for Position Request call.
 - Channel 70 is selected and "READY" appears.



5. Push [DSC] to transmit the Position Request call.



6. After the Position Request call has been transmitted, the following indication is displayed.

- "WAIT ACK" scrolls at the channel comment indicator.



7. Push any key to exit the condition and return to the normal operation.

◆ Transmitting Position Report call

Transmit a Position Report call when you want to announce your own position to a specific ship and to get an answer, etc.

1. Push [DSC] to enter the DSC menu.
2. Push [▲] or [▼] to select "POS REPORT", and push [DSC].

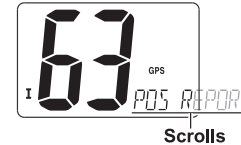

3. Push [▲] or [▼] to select the desired pre-programmed individual address.
 - The ID code for the position report call can be set in advance.



4. Push [DSC] to enter the standby condition for Position Report call.
 - Channel 70 is selected and "READY" appears.



5. Push [DSC] to transmit the Position Report call.



- After the Position Report call has been transmitted, stand by on Channel 70 until an acknowledgement is received.
 - “WAIT ACK” scrolls at the channel comment indicator.



- Push any key to exit the condition and return to the normal operation.

◆ Receiving a Position Request call

While monitoring Channel 70 and a Position Request call is received:

- “DSC” appears and “RCV POS REQUEST” scrolls at the channel comment indicator.
- Push any key to stop the beep.
- Push [DSC] to reply to the call; Push any other key to ignore the call.

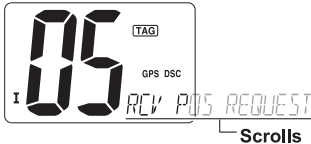

◆ Receiving a Position Report call

While monitoring Channel 70 and a Position Report call is received:

- “DSC” appears and “RCV POS REPORT” scrolls at the channel comment indicator.
- Push any key to stop the beep.

- Push [DSC] to reply to the call; Push any other key to ignore the call.
 - The ‘Latitude’ and ‘Longitude’ from the called station is displayed and scrolled automatically in order of Latitude co-ordinates and then Longitude co-ordinates after replying the call.

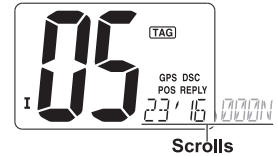

◆ Receiving a Position Reply call

While monitoring Channel 70 and a Position Reply call is received:

- “DSC” and “POS REPLY” appear in the display.
 - The ‘Latitude’ and ‘Longitude’ from the called station is displayed and scrolled automatically in order of Latitude co-ordinates and then Longitude co-ordinates.
- Push any key to stop the beep.

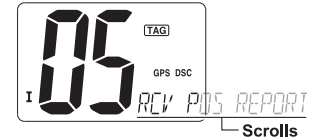

◆ Receiving a Position Report Reply call

While monitoring Channel 70 and a Position Report Reply call is received:

- “DSC” and “POS REPLY” appear in the display.
 - The ‘Latitude’ and ‘Longitude’ you have sent is displayed and scrolled automatically in order of Latitude co-ordinates and then Longitude co-ordinates.
- Push any key to stop the beep.

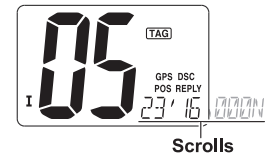

SET MODE

■ Set mode programming

Set mode is used to change the conditions of the transceiver's functions: Scan type (Normal or Priority), Scan resume timer, Weather alert, Dual/Tri-watch, DSC watch, Beep tone, Auto acknowledgement and Favorite channel function.

Set mode operation

1. Turn power OFF.
2. While pushing [16], turn power ON to enter Set mode.
3. After the display appears, release [16].
 - "SCAN" appears at the channel comment indicator.
4. Push [16] to select the desired item, if necessary.
5. Push [▲] or [▼] to select the desired condition of the item.
6. Turn power OFF, then ON again to exit Set mode.

No.	Display	Item	Option	Default
1	SCAN	Scan type	n- (normal scan) / p- (priority scan)	n- (normal scan)
2	TIMER	Scan resume timer	of (OFF) / on (ON)	of (OFF)
3	WX ALERT	Weather alert	of (OFF) / on (ON)	of (OFF)
4	DUAL	Dual/Tri-watch	d-(Dualwatch) / t- (Tri-watch)	d-(Dualwatch)
5	DSC WATCH	DSC watch	of (OFF) / on (ON)	of (OFF)
6	BEEP	Beep tone	of (OFF) / on (ON)	on (ON)
7	AUTO ACK	Auto acknowledgement	of (OFF) / on (ON)	of (OFF)
8	FAVORITE CH	Favorite channel	of (OFF) / on (ON)	on (ON)

■ Set mode items

◆ Scan type

The transceiver has 2 scan types: Normal scan and Priority scan. Normal scan searches all TAG channels in the selected channel group. Priority scan searches all TAG channels in sequence while monitoring Channel 16.

◆ Scan resume timer

The scan resume timer can be selected as a pause (OFF) or timer scan (ON). When OFF is selected, the scan pauses until the signal disappears. When ON is selected, the scan pauses 5 sec. and resumes even if a signal has been received on any other channel than Channel 16.

◆ Weather alert

A NOAA broadcast station transmits a weather alert tone before important weather information. When the weather alert function is turned ON, the transceiver detects the alert, then the "WX ALT" indicator blinks until the transceiver is operated. The previously selected (used) weather channel is checked any time while scanning.

- "WX ALT" appears instead of "WX" indication when the function is set ON.

◆ Dual / Tri-watch

This item can be selected as Dualwatch or Tri-watch.

◆ DSC watch

DSC watch monitors Channel 70 while you are receiving another channel.

If a distress signal is received on Channel 70, the transceiver monitors Channel 16 and 70 alternately until the distress signal disappears. If a signal is received on another channel, DSC watch pauses until the signal disappears.

- This function may not be available for some channel groups depending on dealer setting.
- "DSC WATCH" scrolls at the channel comment indicator.

◆ Beep tone

You can select silent operation by turning beep tones OFF or you can have confirmation beeps sound at the push of a key by turning beep tones ON.

◆ Automatic acknowledgement

This item sets the Automatic acknowledgement function ON or OFF.

When Position Request call or Position Report call is received, transceiver automatically transmits Position Request Reply call or Position Report Reply call, respectively.

- "AUTO ACK" scrolls at the channel comment indicator.

◆ Favorite channel

This item sets the Favorite channel function ON or OFF.

The favorite channel is programmed by the TAG channel setting.

When the Favorite channel function is turned ON, [▲] or [▼] keys on the microphone select the favorite channels in the selected channel group in sequence when pushed. "FAVORITE CH" scrolls at the channel comment indicator.

Operational Instructions and Training Guidelines

To ensure optimal performance and compliance with the General Public (Uncontrolled Environment) RF energy exposure limits in the above standards and guidelines, users should transmit not more than 50% of the time and always adhere to the following procedures:

- The antenna must be installed complying with the requirements of manufacturer or supplier, and it must be at least 1.5 meters away from human body. •

Antenna Gain=3.00dBi for model No.:TQJ-GB-3-159.5V

Antenna Gain=3.50dBi for model No.:MA-F-3.5-162V-09A(MA-F09A)

■ CHANNEL LIST

Channel number					Frequency(MHz)					Channel number					Frequency(MHz)				
USA	INT	CAN	Transmit	Receive	USA	INT	CAN	Transmit	Receive	USA	INT	CAN	Transmit	Receive	USA	INT	CAN	Transmit	Receive
	01	01	156.050	160.650		21	21	157.050	161.650	68	68	68	156.425	156.425	86A			157.325	157.325
01A			156.050	156.050	21A		21A	157.050	157.050	69	69	69	156.475	156.475	87	87	87	157.375	161.975
	02	02	156.100	160.700			21b	Only receiver	161.650	70 ³	70 ³	70 ³	156.525	156.525	87A			157.375	157.375
	03	03	156.150	160.750		22		157.100	161.700	71	71	71	156.575	156.575	88	88	88	157.425	162.025
03A			156.150	156.150	22A		22A	157.100	157.100	72	72	72	156.625	156.625	88A			157.425	157.425
	04		156.200	160.800		23	23	157.150	161.750	73	73	73	156.675	156.675					
		04A	156.200	156.200	23A			157.150	157.150	74	74	74	156.725	156.725					
	05		156.250	160.850	24	24	24	157.200	161.800	75*1	75*1	75*1	156.775	156.775					
05A		05A	156.250	156.250	25	25	25	157.250	161.850	76*1	76*1	76*1	156.825	156.825					
06	06	06	156.300	156.300			25b	Only receiver	161.850	77*1	77	77*1	156.875	156.875					
	07		156.350	160.950	26	26	26	157.300	161.900		78		156.925	161.525					
07A		07A	156.350	156.350	27	27	27	157.350	161.950	78A		78A	156.925	156.925					
08	08	08	156.400	156.400	28	28	28	157.400	162.000		79		156.975	161.575					
09	09	09	156.450	156.450			28b	Only receiver	162.000	79A		79A	156.975	156.975					
10	10	10	156.500	156.500		60	60	156.025	160.625		80		157.025	161.625					
11	11	11	156.550	156.550		61		156.075	160.675	80A		80A	157.025	157.025					
12	12	12	156.600	156.600	61A		61A	156.075	156.075		81		157.075	161.675	WX channel		Frequency(MHz)		
13 ²	13	13 ¹	156.650	156.650		62		156.125	160.725	81A		81A	157.075	157.075			Transmit	Receive	
14	14	14	156.700	156.700			62A	156.125	156.125		82		157.125	161.725	1		Only receiver	162.550	
15 ²	15 ¹	15 ¹	156.750	156.750		63		156.175	160.775	82A		82A	157.125	157.125	2		Only receiver	162.400	
16	16	16	156.800	156.800	63A			156.175	156.175		83	83	157.175	161.775	3		Only receiver	162.475	
17 ¹	17	17 ¹	156.850	156.850		64	64	156.225	160.825	83A		83A	157.175	157.175	4		Only receiver	162.425	
	18		156.900	161.500	64A		64A	156.225	156.225			83b	Only receiver	161.775	5		Only receiver	162.450	
18A		18A	156.900	156.900		65		156.275	160.875	84	84	84	157.225	161.825	6		Only receiver	162.500	
	19		156.950	161.550	65A	65A	65A	156.275	156.275	84A			157.225	157.225	7		Only receiver	162.525	
19A		19A	156.950	156.950		66		156.325	160.925	85	85	85	157.275	161.875	8		Only receiver	161.650	
20	20	20 ¹	157.000	161.600	66A	66A	66A ¹	156.325	156.325	85A			157.275	157.275	9		Only receiver	161.775	
20A			157.000	157.000	67 ²	67	67	156.375	156.375	86	86	86	157.325	161.925	10		Only receiver	163.275	

¹Low power only. ²Momentary high power. ³DSC operation.

■ SPECIFICATIONS

General	
Frequency coverage	TX: 156.025-157.425 MHz
	RX: 156.050 -163.275 MHz
Mode	FM (16K0G3E) DSC (16K0G2B)
Frequency stability	± 10ppm
Operating temperature range	-20°C ~ +60°C
Antenna impedance	50Ω
Dimensions (WxDxH)	153mmx152mmx67mm
Weight (main unit)	742g (with microphone)

Transmitter		Receiver	
Output power	25W / 1W	Sensitivity	≤0.2uV
Max. frequency deviation	±5.0 kHz	Squelch sensitivity	≤0.2uV
Spurious emissions	≤-70dB (H)	Adjacent channel selectivity	≥70dB
	≤-56dB (L)	Spurious response rejection ratio	≥70dB
Adjacent channel power	≥70dB	Intermodulation rejection ratio	≥70dB
Audio harmonic distortion	≤10%	Max. current	≤1.5A
Current drain	≤5.5A (H)	Audio output power	≥4.5W (10%)
	≤1.5A (L)	GPS signal ver.	NMEA0183-2.0
Input resistance	2kΩ	Output impedance	4Ω

■ TROUBLESHOOTING

Issues described in the following table are some common operational failure. These types of errors are generally due to improperly connected, the operation caused by incorrect settings, or operator error caused due to incomplete programming. These problems are usually not caused by circuit failure. Before suspect intercom failure, please refer to the relevant parts of these forms and the instructions for use.

Question	Possible Cause	Solutions	Reference page
Power did not respond.	1.the power cable is connected well. 2. the power cable fuse broken. 3. the voltage exceeds 17V or below 9V.	1, check the power cable is connected correctly: red (+); black (-). 2, then find the cause of blown fuse, replace the fuse current to 15A. 3, adjust the power supply is 13.8V.	3
Unable to connect with GPS.	1. connection error. 2. different external GPS format.	1, check the connections are correct. 2, external GPS format should be NMEA0183-2.0.	3
Can not be scanned.	Not set mark channels (TAG).	The channel you want to scan is set to mark channels.	10
Can not launch.	Work on the weather channel or 70 channels.	Exit the weather channel or 70 channels.	4,8
High power can not be selected.	Some channels can transmit at low power.	Choose other channels.	5,7
The same channel can not talk.	1, the channel is different frequency (DUP). 2, the working group on its own channel.	1, select a channel. 2, the channel is set to the same frequency.	5,7
No beep	Beep off	Open the beep function in the settings mode.	22
Can not transmit a distress call.	MMSI code is not set.	Hold down the [DSC] key to boot into MMSI setting mode.	12
No sound from the speaker.	1, tone squelch level too. 2, the volume is too small. 3, the speaker grid water.	1, rotate [SQL] knob to adjust the squelch level. 2, rotate [VOL] knob to adjust the volume. 3, the use of vibration drainage water discharge.	7,9



RCA

