

The logo consists of a black rectangular background. At the top, there is a thin white horizontal bar. Below this bar, the word "PROSCAN" is written in a large, white, serif font. Underneath "PROSCAN", the words "USER MANUAL" are written in a smaller, white, sans-serif font, all contained within a white rectangular box.

PROSCAN
USER MANUAL

IMPORTANT INFORMATION

WARNING

To reduce the risk of fire or shock hazard, do not expose this TV to rain or moisture.

WARNING

RISK OF ELECTRIC SHOCK DO NOT OPEN

To reduce the risk of electric shock, do not remove cover (or back). No user serviceable parts inside. Refer servicing to qualified service personnel.



This symbol indicates "dangerous voltage" inside the product that presents a risk of electric shock or personal injury.



This symbol indicates important instructions accompanying the product.

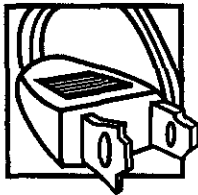

Caution: To reduce the risk of electric shock, match wide blade of plug to wide slot, fully insert.

Attention: Pour éviter les chocs électriques, introduire la lame la plus large de la fiche dans la borne correspondante de la prise et pousser jusqu'au fond.

Refer to the identification/rating label located on the back panel of your product for its proper operating voltage.

FCC Regulations state that unauthorized changes or modifications to this equipment may void the user's authority to operate it.

If fixed (non-moving) images are left on the screen for long periods, they may be permanently imprinted on the screen. Such images include network logos, phone numbers, and video games. This damage is not covered by your warranty. Extended viewing of channels displaying these images should be avoided.

Cable TV Installer: This reminder is provided to call your attention to Article 820-40 of the National Electrical Code (Section 54 of the Canadian Electrical Code, Part 1) which provides guidelines for proper grounding and, in particular, specifies that the cable ground shall be connected to the grounding system of the building as close to the point of cable entry as practical.

VCR Plus+, PlusCode and GUIDE Plus+ are trademarks of Gemstar Development Corporation. TV GUIDE is a trademark of TV Guide Financial, Inc. The VCR Plus+ and TV GUIDE Plus+ systems are manufactured under license from Gemstar Development Corporation and VCR Index Systems B.V., respectively.

TABLE OF CONTENTS

FIRST THINGS FIRST	3
Connecting your TV	4
TV Only	4
TV with other Components	4
TV GUIDE Plus+ Controller	5
USING THE MENU SYSTEM	7
The Menu Rule: Point and Select	8
What is Point and Select?	8
Menus and Control Panels	10
Menus	10
Control Panels	11
Sliders	11
Choice Lists	12
Numeric Entry	13
TV GUIDE Plus+ Menus	14
INTERACTIVE SETUP	15
Entering Setup	16
Select a Language	16
Auto Channel Search	16
TV GUIDE Plus+ System	17
Set the Time	23
Set the VCR1 Channel	24
Set the DVD/VCR2 Channel	25
Set the SAT/CABLE Channel	26
Label the Channels	27
PROGRAMMING THE REMOTE	29
Programming the Remote	30
To Control a VCR	30
To Control a DVD Player or Laserdisc Player	32
To Control an RCA Audio Device:	32
To Control a Satellite Receiver or Cable Box	33
Using the Remote to Control a Device	33
TOUR OF THE TV	35
Remote Buttons	36
Back Panel	38
Front Panel	40
Channel Marker	41

TABLE OF CONTENTS

QUICK REFERENCE	43
Audio Menu	44
Picture Quality Menu	45
Screen Menu	46
Channel Menu	47
Time Menu	49
Parental Controls Menu	50
TV GUIDE Plus+ Menu	51
Setup Menu	52
ADVANCED FEATURES	53
TV GUIDE Plus+ Operation	54
Surf Menu	54
Next Menu	55
Scan Menu	55
Sort Menu	56
One Touch Recording	57
PIP (Picture-in-Picture) Operation	58
Two Tips for Using PIP Buttons	59
Fetch Menu	60
Choosing an Audio Processor	61
Choosing an audio processor from the remote	61
Closed Captioning	62
To display Closed Captioning	62
Closed Captioning Modes	63
On-screen Program Details	64
APPENDIX A: TV CONNECTIONS	65
APPENDIX B: OTHER COMPONENTS	76
APPENDIX C: TROUBLESHOOTING ...	78
APPENDIX C: TROUBLESHOOTING ...	79
APPENDIX D: LIMITED WARRANTY	80
APPENDIX E: CARE AND CLEANING ..	81
ACCESSORIES	82
INDEX	85

FIRST THINGS FIRST

HI, I'M ROGER.

I wrote this manual to help you get the most from your TV. I know you expect a lot from your TV, so I designed this user manual to give you the information you need... when you need it.

READ THE FIRST FOUR CHAPTERS

The manual is designed to get you started quickly... and let you catch up on the details when you get a chance. The first four sections of the manual will get your TV up and running. You'll learn how to use the menu system, run the interactive setup routine and program the remote.

The rest of the manual gives you the specifics: a tour of the TV, a quick reference guide, details on the TV GUIDE Plus+ system, advanced features and appendices.

Well... if your TV's out of the box, let's get started. First things first.

1 FIRST THINGS FIRST



2 USING THE MENU SYSTEM



3 INTERACTIVE SETUP



4 PROGRAM THE REMOTE

Check out the notes I've added throughout the manual. I've got some great tips that will help you get the most from your TV.

FIRST THINGS FIRST

STEP 1

Unpack the TV. Make sure to locate the remote control and Connections Foldout.

STEP 2: CONNECTING YOUR TV

If you're only going to connect the TV to your home antenna or cable system, use the "TV Only" connection. If you're going to connect the TV to a VCR, satellite receiver, DVD player or other component, look at the Connections Foldout. The Connections Foldout details recommended connection schemes for hooking up the TV to a cable box or antenna, one or two VCRs, a laserdisc player, and a satellite receiver.

TV ONLY

This is a basic connection from an antenna or cable system to your TV. Connect the cable as shown. If you have a VCR or other components to connect to the TV, skip to the next section.

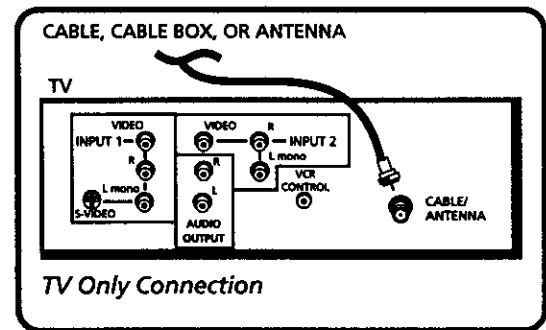

TV WITH OTHER COMPONENTS

Use the Connections Foldout to connect your TV to a VCR, DVD player, and/or satellite receiver. After connecting your TV and other components, proceed to the next step. See *Appendix A* for detailed information about using each of these connections.

If your components don't match those shown on the foldout, or if you prefer a different connection, see your dealer or specific component user manuals.

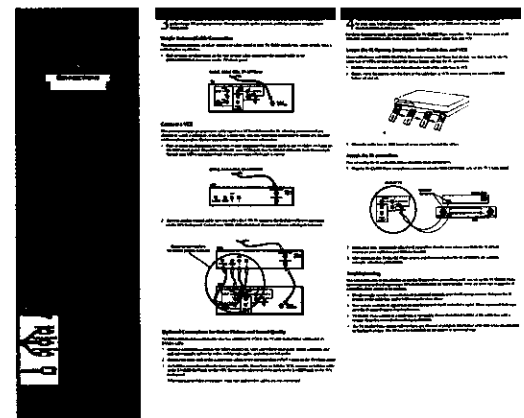

FIRST THINGS FIRST

TV GUIDE PLUS+ CONTROLLER

The TV GUIDE Plus+* controller allows direct control of a cable box and VCR using a pair of IR (infrared) controllers.

- Plug the TV GUIDE Plus+ controller into the VCR CONTROL jack on the back of the TV.
- Affix the IR controllers directly over the IR remote sensors on your cable box and VCR.

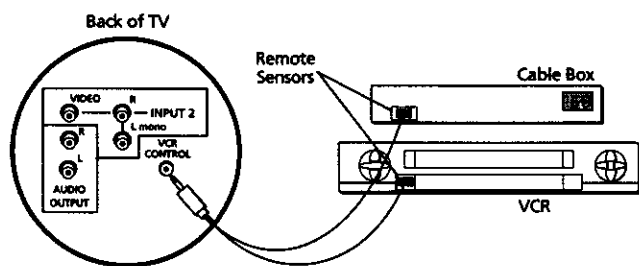

Connect IR controllers to the infrared remote sensors on your cable box and VCR

STEP 3

Plug in the TV.

Plug the end into the wall outlet, matching the wide blade of the plug with the wide slot in the outlet. Be sure to insert the plug completely.

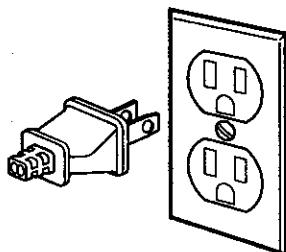

* GUIDE Plus+ is a trademark of Gemstar Development Corporation. TV GUIDE is a trademark of TV Guide Financial, Inc.

Locating the IR (infrared) Remote Control Sensor on Your Cable Box or VCR

The IR controllers must be affixed directly over the IR remote sensors on your cable box or VCR.

Some cable boxes and VCRs label the IR sensors; others do not. If the sensors are labeled, affix the IR controllers directly over them.

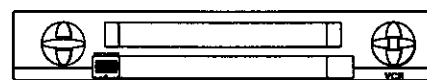

IR Remote Sensor

For those that do not label the IR sensor, you need to use the cable box or VCR's remote to locate the sensor before affixing the IR controllers.

1. Hold the remote control so that it is touching the front of the cable box or VCR.
2. Slowly move the remote over the front of the cable box or VCR while pressing the remote's POWER button on and off
3. When the cable box or VCR turns off or on, you've located the sensor.

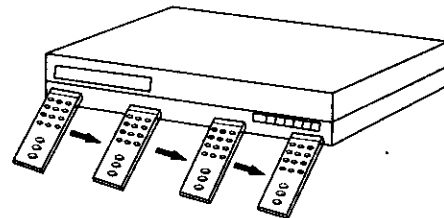

You should test the IR controllers after setting up the TV GUIDE Plus+ system.

Temporarily attach the IR controllers with clear tape to the spots where you think the sensors are located. After determining that the controllers are working correctly, affix them permanently.

FIRST THINGS FIRST

STEP 4

Put batteries in the remote.

- Remove the battery compartment cover from the back of the remote.
- Insert batteries as shown, matching the + and – ends of each battery in the compartment.
- Replace the cover.

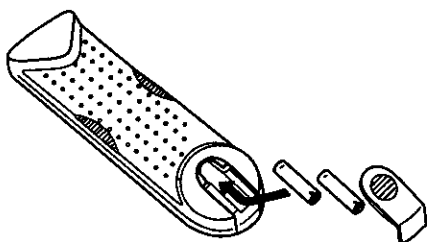

STEP 5

Turn on the TV.

Press TV on the remote, or press POWER on the TV itself.

STEP 6

Read the next section, *Using the Menu System*, which is a brief overview of the basic rules for getting around in the menus.

STEP 7

Proceed to section three, *Interactive Setup*. The interactive setup routine walks you through the steps needed to fully configure the TV. The first steps ask you to select your preferred language for the menu system and to begin the auto channel search, which puts available cable TV or antenna signals into the TV's memory. You can skip any of the steps and return to them later.

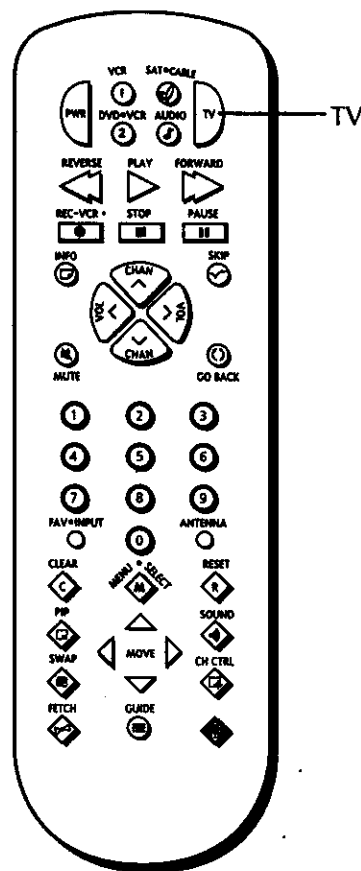

If the picture appears to have a double or triple image, you may have to adjust the color convergence. Details can be found under the Screen menu heading in the Quick Reference section.

USING THE MENU SYSTEM

ONE RULE TO REMEMBER

You control and customize the TV by making changes to various control panels in the menu system. The great thing is, you only need to know one rule: point and select.

1 FIRST THINGS FIRST



2 USING THE
MENU SYSTEM



3 INTERACTIVE SETUP



4 PROGRAM THE
REMOTE

USING THE MENU SYSTEM

THE MENU RULE: POINT AND SELECT

You only need to know one rule to use the on-screen menus and control panels: point and select.

WHAT IS POINT AND SELECT?

The point and select method has two steps.

1. **Point** to a menu item using the MOVE arrows on the remote.

To point up or down, press the up or down arrows. To point left or right, press the left or right arrows.

2. **Select** a menu item by pressing MENU•SELECT.

Selecting an item tells the TV's menu system to go ahead and make the change or go to a place you have indicated.

For example, to select the Channel menu from the Main menu:

1. Press MENU to bring up the Main menu.

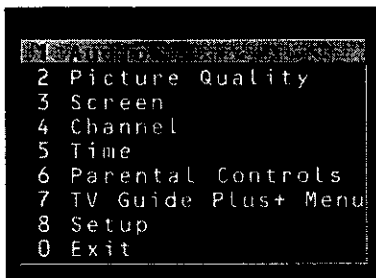

2. Point to *Channel* by pressing the down arrow until the word Channel is highlighted.

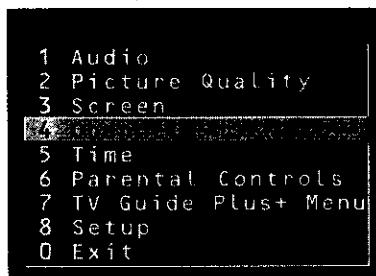

Tip: You can also select a menu item by entering the item number with the number buttons on the remote.

Press CLEAR at any time to remove all displays from the screen and return to TV viewing.

Many VCR user manuals refer to a PROGRAM button. The MENU•SELECT button on this remote works as a PROGRAM button in VCR mode. The rest of this manual refers to this button only as MENU.

USING THE MENU SYSTEM

3. Press **MENU** to select *Channel*. The Channel menu comes up.

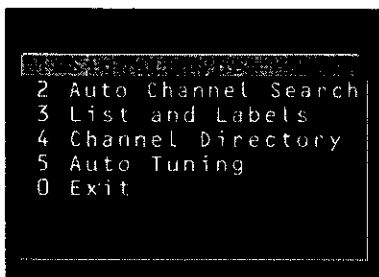

4. Point to *Exit* and press **MENU** to return to the Main menu.
5. Point to *Exit* and press **MENU** to leave the menu system and return to TV viewing.

If you ever want to leave the menu system, press **CLEAR**.

Once you know how to point and select your way through the menus, you can apply this rule in the control panels, which do the real work in the menu system.

USING THE MENU SYSTEM

MENUS AND CONTROL PANELS

There are three parts to the menu system: menus, control panels, and TV GUIDE Plus+ menus. But before you can use control panels or the TV GUIDE Plus+ system, you first have to move through at least one menu—the Main menu.

MENUS

The first menu is called the Main menu. To bring up the Main menu:

1. Press MENU on the remote or front panel:

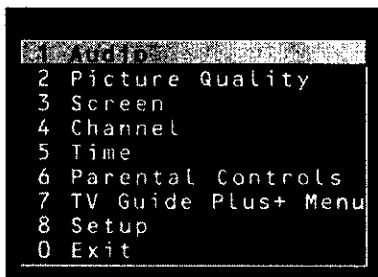

Menus take you to another menu or a control panel. There are two ways to make a choice in a menu:

- Point and select with the MOVE arrows and MENU.
- Press a number button on the remote. For example, in the Main menu press 3 to go straight to the Screen menu.

Exiting a menu

There are three ways to exit a menu:

- Point to *Exit* and press MENU.
- Press 0 on the remote.
- Press CLEAR. The on-screen displays are cleared from the screen and you are returned to TV viewing.

Feel free to explore the menu system. If you're ever unsure where you are in the menu system, or you're just plain tired of exploring, press CLEAR to remove the menus from the screen and start over again.

USING THE MENU SYSTEM

CONTROL PANELS

Control Panels do the work in the menu system: it's where you choose a setting, enter a number, or adjust a level such as tint or brightness. There are three kinds of control panels: sliders, choice lists, and numeric entry.

Sliders

Sliders are used to make adjustments to a particular control.

For example, to adjust the TV's contrast:

1. Press MENU to bring up the Main menu.
2. Point to *Picture Quality* and press MENU. The Picture Quality menu comes up.
3. Press MENU to select Basic Picture Controls.

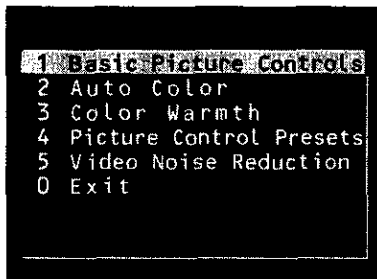

4. Press the right or left arrow to adjust the indicator line. Notice that the picture changes as you adjust the contrast.

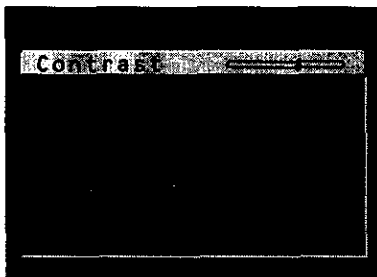

Now that you know how the Contrast slider works, you know how all sliders work.

You don't need to remember the names of the control panel types. Once you've learned how each type works, you'll be able to use any part of the menu system.

USING THE MENU SYSTEM

CHOICE LISTS

Choice lists are used to choose a particular setting from a list of settings. The current setting in a choice list is always the highlighted item.

For example, to indicate whether you're currently using a home antenna or a cable TV signals:

1. Press MENU to bring up the Main menu.
2. Point to *Channel* and press MENU. The Channel menu comes up.

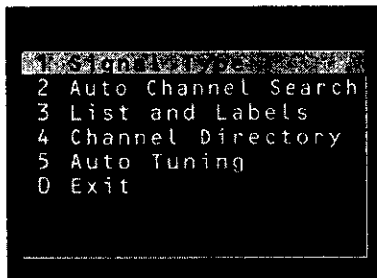

3. Point to *Signal Type* and press MENU. The Signal Type choice list comes up with the current setting highlighted. For example:

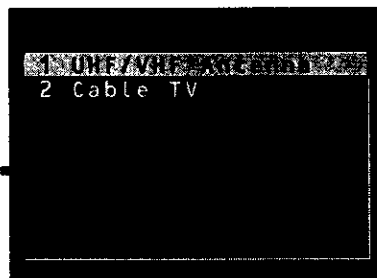

4. Point to the correct setting for your connection and press MENU. As soon as you select a choice, the TV saves your change, and you are returned to the previous menu.
5. Point to *Exit* and press MENU to return to the Main menu.
6. Point to *Exit* and press MENU to return to TV viewing.

USING THE MENU SYSTEM

NUMERIC ENTRY

A numeric entry control panel is used to enter numbers or letters.

For example, to set the current time:

1. Press MENU to bring up the Main menu.
2. Point to *Time* and press MENU.

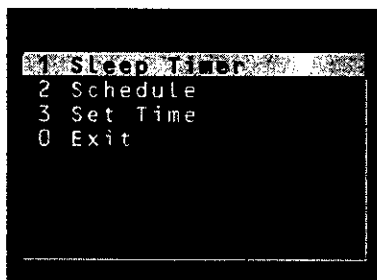

3. Point to *Set Time* and press MENU. The Set Time numeric entry control panel comes up. Notice the pointer underneath the first column.

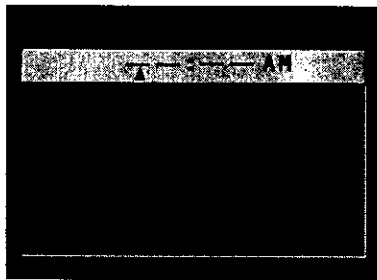

4. Press the up arrow to enter a number in that column.
5. Press the right arrow to move to the next column, then press the up or down arrow to enter a number.
6. Repeat Step 5 until you have entered the hour and minute for the current time. Notice that when you reach the last column, pressing the up or down arrow changes whether the time reads AM or PM.
7. When you have entered the correct time, press MENU. You are returned to the Time menu.
8. Point to *Exit* and press MENU to return to the Main menu.
9. Point to *Exit* and press MENU to return to TV viewing.

If the control panel is not set at the current time, use the left arrow to go back over the columns and the up arrow to make changes.

You can also enter numbers directly by using the number buttons.

USING THE MENU SYSTEM

TV GUIDE PLUS+ MENUS

The TV GUIDE Plus+ system is an interactive on-screen program guide that lists TV schedules for your area, and allows your TV direct control of a cable box and VCR. Use of the system's menus differs slightly from the point and select method described earlier.

1. Press GUIDE to bring up the TV GUIDE Plus+ menu.

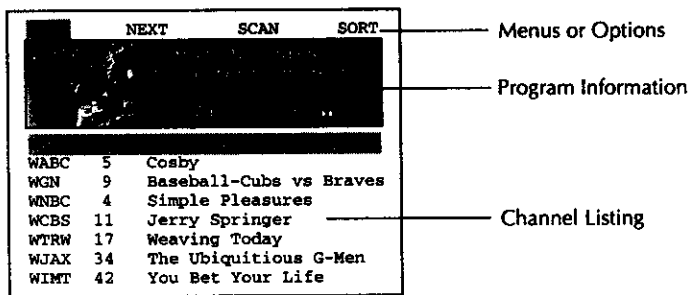

There are three sections to a TV GUIDE Plus+ menu:

- A row of menus or options across the top of the screen
- Program information
- Channel listing

Unlike your TV's other menus, TV GUIDE Plus+ menus use two methods of pointing and selecting on the same screen—one for menus or options, and one for program information.

To select menus or options:

- Press the right or left arrow to highlight your choice.
- Press MENU to select the highlighted item. *MENU is used only when selecting menus or options.*

To make selections in the program listing:

- Press the up or down arrow to select a channel.
- Press GUIDE to exit the TV GUIDE Plus+ system. The TV will change to the channel you selected.

See *Interactive Setup and Advanced Features* for more information on using the TV GUIDE Plus+ system.

TV GUIDE Plus+ screens illustrated in this book are representations of what you are likely to see. Not all channels, programs, and TV GUIDE Plus+ information depicted will be available in your area.

Currently, program information can include title, brief description, time program starts, length, and the availability of closed captioning, stereo and additional program information.

New features and options can be downloaded to the TV GUIDE Plus+ system, so these too are subject to change.

INTERACTIVE SETUP

THERE'S AN ON-SCREEN SETUP ROUTINE

Your TV has software that tells it what to do, just like a computer. The interactive setup routine takes you through the steps needed to configure the TV:

- Select a menu language
- Search for available channels
- Set up the TV GUIDE Plus+ System
- Set the time
- Set the VCR1 channel
- Set the DVD/VCR2 channel
- Set the SAT/CABLE channel
- Make the channel list and labels

1 FIRST THINGS FIRST

2 USING THE
MENU SYSTEM

3 INTERACTIVE SETUP

4 PROGRAM THE
REMOTE

Complete the first two steps, Select Language and Auto Channel Search, to receive antenna or cable TV signals. After that, you can skip other steps and return to them at your convenience.

INTERACTIVE SETUP

ENTERING SETUP

Setup is accessed through the Main menu:

1. Press MENU to bring up the Main menu.
2. Point to *Setup* and press MENU. The first Setup screen comes up, asking you to confirm that you want to begin.

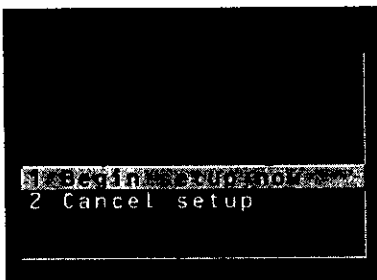

3. Press MENU to begin the Setup routine.

SELECT A LANGUAGE

The first part of the setup routine asks you to select your preferred language for the menuing system.



1. Point to your preferred language for the menuing system.
2. Press MENU to select that language for the menuing system.

AUTO CHANNEL SEARCH

The next part of the setup routine asks you if you want the TV to search automatically for all channels available through your antenna or cable TV system. This is sometimes called "autoprogramming."

INTERACTIVE SETUP



1. Press MENU to tell the TV to begin searching for channels. The display gives you a progress report and tells you when it has finished.
2. Press MENU to continue.

If you skip Auto Channel Search now, you can access it later through the Channel menu. You can also put channels in memory manually using List & Labels. See *Quick Reference* for more details.

TV GUIDE PLUS+ SYSTEM

The next step lets you set up the TV GUIDE Plus+ system to display your local program listings, and control your cable box and VCR.

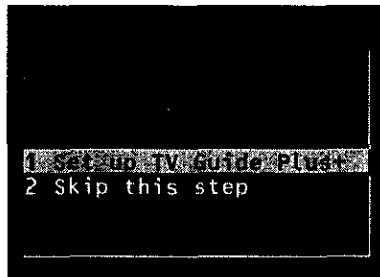

1. Press MENU to bring up the TV GUIDE Plus+ initial menu.

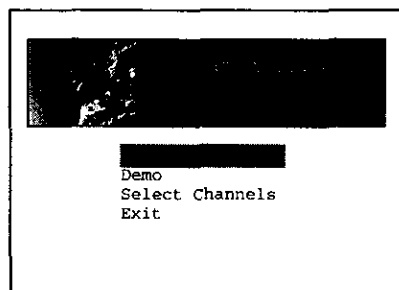

2. Press MENU to begin setup.

To complete TV GUIDE Plus+ setup, you must have already connected the TV GUIDE Plus+ controllers to your cable box and VCR. Refer to *First Things First* for more details.

INTERACTIVE SETUP

The first two screens ask for information about where you live.

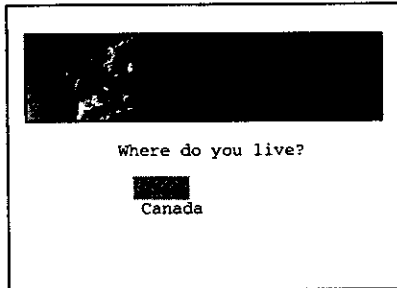

3. Select your country.

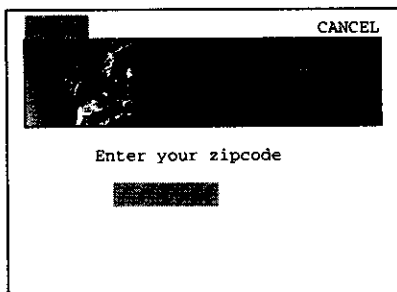

4. Enter your ZIP code (Postal Code in Canada) using the numeric keypad. If you make a mistake, press MENU to back up a number.

The next series of screens asks you about your cable TV setup. If you have a cable box, you will want to set the TV GUIDE Plus+ system to control it. Otherwise, it may not be able to locate and download program information.

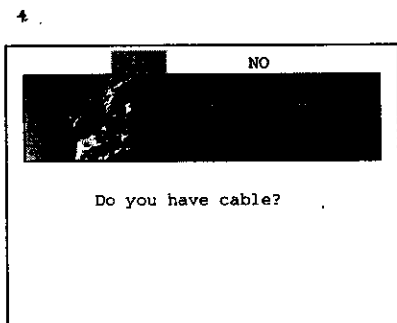

5. Select YES if you have cable, or NO if you do not.

Since the program information provided by the TV GUIDE Plus+ system is based on your locale, you will need to run setup again if you move.

INTERACTIVE SETUP

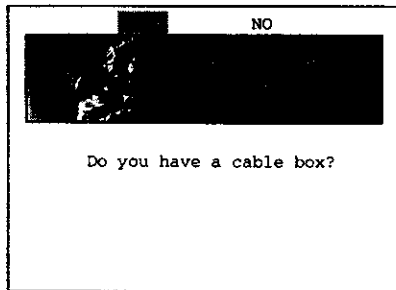

6. Select **YES** if you have a cable box, or **NO** if you do not.

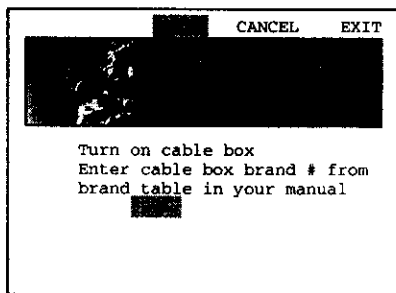

7. Enter the code for your cable box's brand from the table on the following pages.

When the TV GUIDE Plus+ system correctly identifies the brand and model of your cable box, the cable box changes to channel 9.

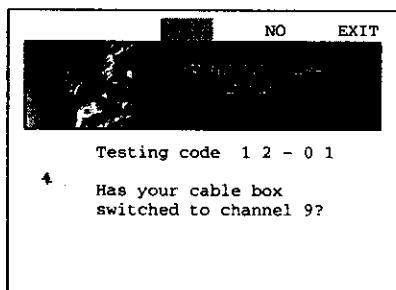

8. Select **YES** if the cable box changed to channel 9, or **NO** if it did not. If you select **NO**, the system will try another code.

Once the correct model of cable box has been identified, you will need to set the cable box's output channel.

When the TV GUIDE Plus+ system cannot recognize either your cable box or VCR after several tries, a screen reading, "Cable Box (VCR) test failed... Please consult manual and try again" appears. If this happens, you should:

- Double check the codes listed in the tables. Try entering another if one is listed.
- Check to make sure the IR controllers are positioned correctly.

INTERACTIVE SETUP

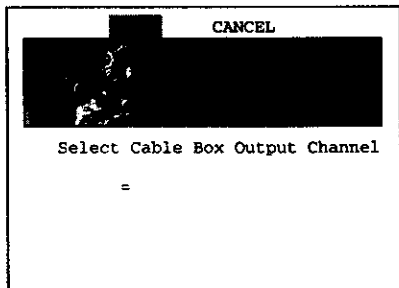

9. Enter the channel you normally use to view channels through your cable box—usually 3 or 4. Consult your cable box's instruction book or your cable company if you are not sure. Choose 0 to use VIDEO INPUT 1.

The last series of screens asks about your VCR setup.

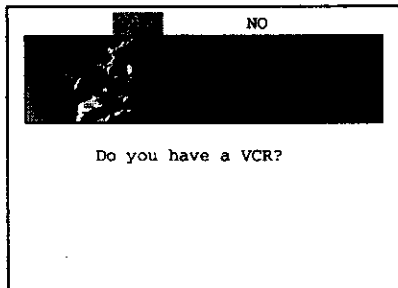

10. Select YES if you have a VCR, or NO if you do not.

Answering NO automatically skips forward to the end of TV GUIDE Plus+ setup.

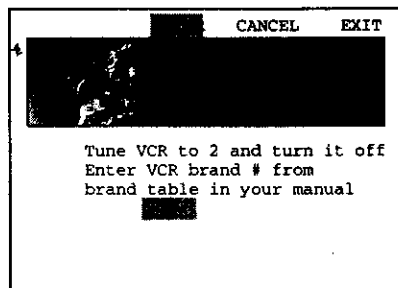

11. Tune your VCR to channel 2 and turn it off.
12. Enter the code for your VCR's brand from the table on the following pages.

Channels 0–7 can be used for the cable box's output channel. "0" is used for VIDEO INPUT 1 (INPUT 2 cannot be used); 1–7 are regular TV channels.

See *Advanced Features* for more details on using the TV GUIDE Plus+ system to control a cable box and VCR.

INTERACTIVE SETUP

When the TV GUIDE Plus+ system correctly identifies the brand and model of your VCR, the VCR's tuner changes to channel 9.

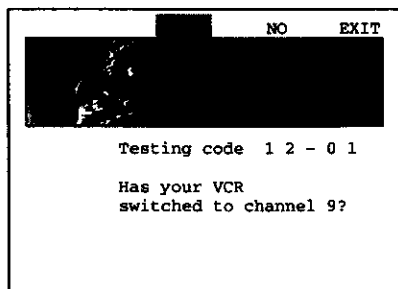

13. Select **YES** if the VCR automatically changed to channel 9, or **NO** if it did not. If you select **NO**, the system will try another code.

This screen comes up when you've successfully finished TV GUIDE Plus+ setup.

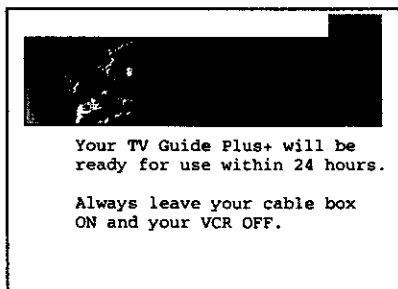

14. Select **EXIT** to continue with the remainder of the interactive setup.

The TV GUIDE Plus+ system will be unavailable until it completes its first download of program information.

When the power is turned off, the TV locates a "host channel" that carries TV GUIDE Plus+ data containing program schedule and channel mapping information. A channel map is the list of stations and their respective channels. See *Advanced Features* for more details.

Downloads may be scheduled several times a day. *The TV must be turned off for TV GUIDE Plus+ data to download.*

If more than one cable company services your area, the TV GUIDE Plus+ system may download a channel map for each company.

After the TV completes its first download, you will be prompted to manually select the channel map.

See *Advanced Features* for complete instructions.

INTERACTIVE SETUP

TV GUIDE Plus+ VCR Codes

Admiral	19	MTC	14
Akai	15	Multitech	14
Audio Dynamics	11	NEC	11
Belcor	16	Nikko	16,22
Bell&Howell	04	Olympus	03
Broksonic	26	Optimus	27
Candle	27	Optonica	19
Canon	03	Orion	24
Capehart	16	Panasonic	03
Craig	17	Pentax	21
Curtis	23	Philco	28
Daewoo	16	Philips	28
DBX	11	Pilot	22
Electrohome	08	Pioneer	21
Electron	01	ProScan	01
Emerson	05	Quasar	03
Fisher	04	Radio Shack/Realistic	30
Funai	14	Randix	22
GE	01	RCA	01
Go Video	02	Samsung	23
Goldstar	22	Sansui	20
Grundig	03	Sanyo	04
Harman Kardon	08	Scott	05
Hitachi	21	Sears	06
Images	02	Sharp	19
JC Penney	25	Shintom	17
Jenson	31	Shogun	23
JVC	12	Signature	19
Kenwood	12	Sony	13
KLH	17	Sylvania	28
Magnavox	07	Symphonic	14
Magnin	23	Tatung	31
Marantz	11	Teac	31
Marta	22	Teknika	18
Memorex	29	Telefunken	05
MGA	08	TMK	05
Minolta	21	Toshiba	10
Mitsubishi	08	Totevision	23
Montgomery Ward	14	Vector Research	11
Movie Walker	14	Zenith	09

TV GUIDE Plus+ Cable Box Codes

Archer	14
Cable Cinema	31
Cabletenna	31
Cableview	31
Century	27
Citizen	29
Curtis	04
Diamond'	31
Eagle	09
Eastern	13
GC Electronics	26
Gemini	15
General Electric	19
General Instrument	01
Gerrard	27
Hamlin	06,13
Hitachi	16
Jasco	15
Jerrold	01
Macom	16
Magnavox	11
Matsushita	07
Movietime	17
NEC	22
Novavision	04
NSC	22
Oak	05
Oak Sigma	05
Panasonic	07
Philips	10
Pioneer	02
Pulser	24
Quest	02
RCA	07
Realistic	27
Recoton	27
Regal	06
Regency	13
Rembrandt	26
L.L. Marx	23
Samsung	23
Scientific Atlanta	04
Sheritech	12
Signal	11
Sprucer	07
Standard Components	17
Stargate	24
Sylvania	08
Teknika	20
Telecaption	21
Television	22
Texscan	08
Tocom	18
Toshiba	30
Unika	26
Universal	25
Videoway	03
Vidtek	28
Viewstar	09
Zenith	03

The TV GUIDE Plus+ system may not operate all models of the brands listed in the tables on this page.

INTERACTIVE SETUP

SET THE TIME

The next step lets you set the time of day.

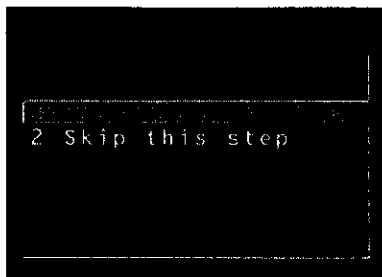

1. Press MENU to bring up the Set Time control panel.

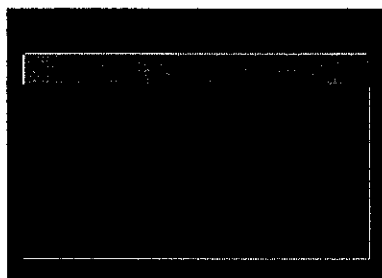

2. Use the left and right arrows to point to the hour and minutes spaces. Use the up and down arrows to scroll through the numbers and change from AM to PM.
3. Press MENU to continue.

INTERACTIVE SETUP

SET THE VCR1 CHANNEL

The next step lets you set the VCR1 channel. When you set the VCR1 channel, you're telling the TV what channel to tune to when you press the VCR1 button on the remote.

For example, if you have a VCR connected to the Video 1 input jacks on the back of the TV, you want the TV to tune to the Video 1 input channel when you press the VCR1 button. If you don't have a VCR1 component connected to the TV, skip this step or select *Not Connected* from the VCR1 Channel choice list. (For more, see *Auto Tuning* in the Quick Reference section.)

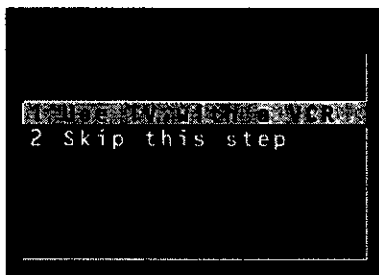

1. Press MENU to bring up the VCR1 choice list.

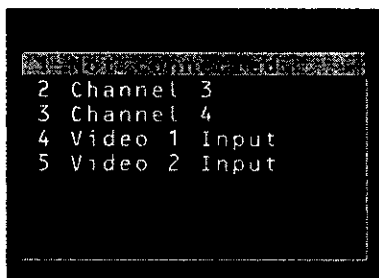

2. Point to the choice that matches the way you have your VCR connected to the TV.

If you used the Connections Foldout to hook up your TV, use the table shown at the right to select the VCR1 channel.

3. Press MENU to continue.

If you used	Select
Connection A	Video 1 Input
Connection B	Video 1 Input
Connection C	Video 1 Input
Connection D	Video 1 Input
Connection E	Not Connected
Connection F	Not Connected
Connection G	Video 2 Input
Connection H	Channel 3*
Connection I	Video 2 Input

* Or Channel 4, depending on how your VCR's 3/4 switch is set.

INTERACTIVE SETUP

SET THE DVD/VCR2 CHANNEL

The next step lets you set the DVD/VCR2 channel. When you set the DVD/VCR2 channel, you're telling the TV what channel to tune to when you press the DVD•VCR2 button on the remote.

For example, if you have a DVD player connected to the Video 2 input jacks on the back of the TV, you want the TV to tune to the Video 2 input channel when you press DVD•VCR2. If you don't have a DVD•VCR2 component connected to the TV, skip this step or select *Not Connected* from the DVD/VCR2 Channel choice list. (For more, see *Auto Tuning* in the Quick Reference section.)

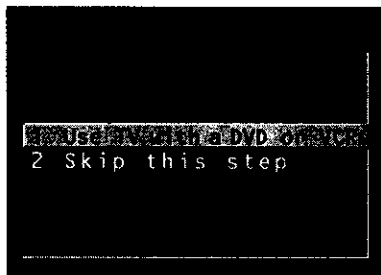

1. Press MENU to bring up the DVD/VCR2 choice list.

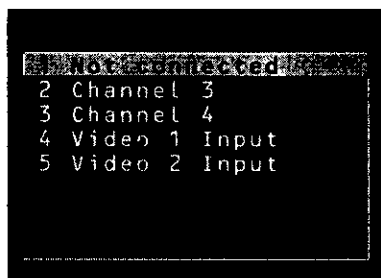

2. Point to the choice that matches the way you have your DVD player or second VCR connected to the TV.

If you used the Connections Foldout to hook up your TV, use the table at right to select the DVD/VCR2 channel.

3. Press MENU to continue.

If you used	Select
Connection A	Not Connected
Connection B	Not Connected
Connection C	Video 2 Input
Connection D	Channel 3*
Connection E	Video 1 Input
Connection F	Not Connected
Connection G	Not Connected
Connection H	Video 2 Input
Connection I	Channel 3*

* Or Channel 4, depending on how your VCR's 3/4 switch is set.

INTERACTIVE SETUP

SET THE SAT/CABLE CHANNEL

The next step lets you set the SAT/CABLE channel. When you set the SAT/CABLE channel, you're telling the TV what channel to tune to when you press the SAT•CABLE button on the remote.

For example, if you have a cable box connected to the Antenna jack on the back of the TV, and you usually tune your TV to channel 3 to see cable stations, you want the TV to tune to channel 3 when you press SAT•CABLE. If you don't have a satellite receiver or cable box connected to the TV, skip this step or select *Not Connected* from the SAT/CABLE Channel choice list. (For more, see *Auto Tuning* in the Quick Reference section.)

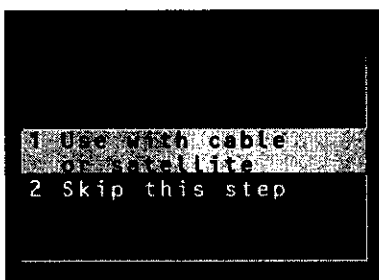

1. Press MENU to bring up the SAT/CABLE choice list.

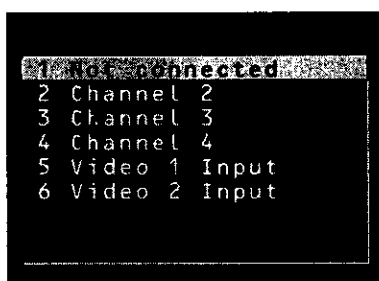

2. Point to the choice that matches the way you have your satellite receiver or cable box connected to the TV.

If you used the Connections Foldout to hook up your TV, use the table at the right to select the SAT/CABLE channel.

3. Press MENU to complete the Setup routine and return to TV viewing.

Important:

If you have both a satellite receiver and a cable box connected to the TV...

...The remote cannot control both a cable box and the satellite receiver. The chart details how to set the SAT•CABLE button to control the satellite receiver. You must then use your cable box remote to control the cable box. You may, however, prefer to use the satellite receiver remote for satellite programming, and set your SAT•CABLE button to control your cable box. It's your choice.

If you used	With Cable Box Select
Connection A	Channel 3*
Connection B	Channel 3*
Connection C	Channel 3*
Connection D	Channel 3*
Connection E	Channel 3*
If you used	With Satellite Receiver Select
Connection F	Video 1 Input
Connection G	Video 1 Input
Connection H	Video 1 Input
Connection I	Video 1 Input

* Or Channel 4, depending on how your VCR's 3/4 switch is set.

INTERACTIVE SETUP

LABEL THE CHANNELS

The next step lets you make your channel list and label your channels.
(For more, see *List and Labels* in the Quick Reference section.)

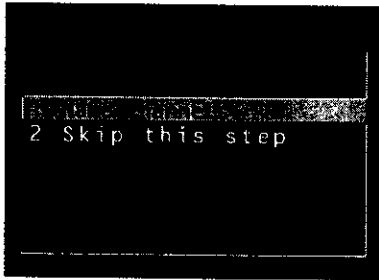

1. Press MENU to bring up the List and Labels control panel.

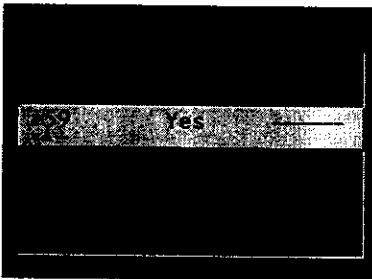

2. Use the left and right arrows to point to the three different areas of the control panel (called "fields").
3. Use the up and down arrows to scroll through the numbers and letters and select *Yes* or *No* in the Normal List field. You may wish to refer to the call letters listed in your newspaper's TV section for ideas on labelling the channels.
4. Repeat this process for each of your channels. Then press MENU to continue. The TV can store up to 27 labels in memory.

Use the CH ^ (channel up) or CH v (channel down) buttons to change channels in the Chan # field. This works even if you're not in the Chan # field. Or, enter the channel number directly using the number buttons on the universal remote. To enter a number greater than 99, press and hold "1" to enter the hundreds digit, then press the two remaining numbers.

The list and labels feature can also be accessed from the Channel menu. Because this procedure can be time consuming, feel free to skip this step and come back to it later.

INTERACTIVE SETUP

What Now?

Now that you've finished the interactive setup, you can sit back, relax, and enjoy the TV. Or...

Program the Remote

Since you've gone this far, you can take a few minutes to program the remote to control your VCR, DVD player, laserdisc player, and other component. To find out how to program the remote, go to the next section.

PROGRAM THE REMOTE

IF YOU HAVE A VCR OR OTHER COMPONENT...

The universal remote can be programmed to control most brands of remote controllable VCRs, satellite receivers, DVD players and cable boxes. If you have a ProScan, RCA, or GE component, you probably don't need to program it at all—other manufacturers' brands need to be programmed.

NOW WATCH SOME TV!

Once you've programmed the remote, you will have completed all four setup sections. Now you can sit back and enjoy the TV. If you want to know more about the different parts of the TV, see the next section, *Tour of the TV*. Refer to the other sections and appendices as needed.

1 FIRST THINGS FIRST



2 USING THE
MENU SYSTEM



3 INTERACTIVE SETUP



4 PROGRAM THE
REMOTE

PROGRAM THE REMOTE

PROGRAMMING THE REMOTE

The universal remote can be programmed to control most brands of remote controllable VCRs and cable boxes. The remote is already programmed to control most ProScan, RCA, and GE TVs VCRs, DVD players, laserdisc players and satellite receivers. Other manufacturers' brands need to be programmed.

PROGRAMMING THE REMOTE TO CONTROL A VCR

To determine whether the universal remote needs to be programmed, turn the VCR on, point the remote at the VCR, and press the VCR1 button. Then press POWER or CH ^ (channel up) or CH v (channel down) to see if the VCR responds to the remote commands. If not, the remote needs to be programmed.

Follow these steps to program your universal remote to control your VCR:

1. Turn on the VCR to be programmed.
2. Look up your VCR brand and code number(s) on the code list on the next page.
3. Press and hold the VCR1 button on the remote.
4. Enter the two-digit code from the code list.
5. Release VCR1 then press POWER to see if the VCR responds to the remote commands. If it doesn't, try pressing VCR1 and POWER to see if the VCR responds.
6. Repeat these steps using the next code listed for your brand, until the VCR responds to the remote commands.

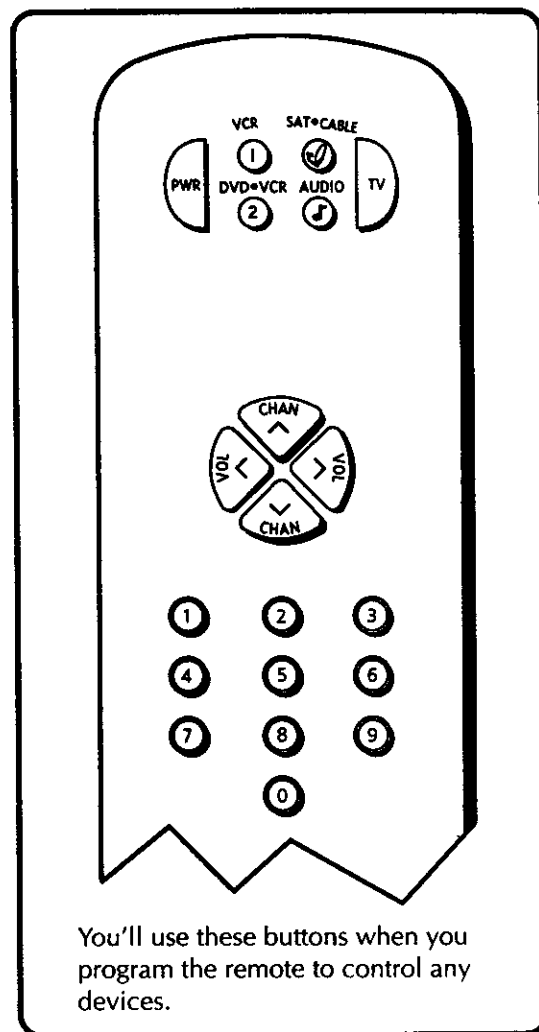

This remote may not operate all models of the brands that are shown. Use the codes shown at right or on the sheet packed in with your remote.

To program the DVD•VCR2 button to control a second VCR, follow these steps but use the DVD•VCR2 button instead of the VCR1 button.

PROGRAM THE REMOTE

Universal Remote VCR Codes

Admiral	06,79	Panasonic	08,53,75,77
Aiwa	15	Pentax	05,35,44
Akai	03,17,22,23,63,66	Pentax Research +	46
Audio Dynamics	14,16	Philco	08,29,53,56
Bell&Howell	02	Philips	08,29
Broksonic	10	Pioneer	05,16,50
Candle	07,09,13,44,	Portland	44,45,52
.....	45,46,52	ProScan	00
Cannon	08,53	Quartz	02
Capehart	01	Quasar	08,53
Citizen	07,09,13,44,	Radio Shack/Realistic	02,06,08,
.....	45,46,52	09,12,15,19,27,43,53
Colortyme	14	RCA	00,05,07,08,28,35,37,54,69
Craig	07,12	Samsung	07,13,22,32,42
Curtis-Mathes	00,07,08,14,	Sansui	16,71
.....	15,44,46,53,64,67	Sanyo	02,12
Daewoo	13,45,52,76	Scott	04,13,41,49,68
DBX	14,16	Sears	02,05,09,12,18,19,35,43,48
Dimensia	00	Sharp	06,24,27,39,45
Dynatech	15	Shintom	17,26,31,55
Electrohome	27	Signature	15
Emerson	08,09,10,13,15,20,23,	Sony	17,26,38
.....	27,34,41,42,47,49,	Sylvania	08,15,29,53,56
.....	57,62,65,67,68,70	Symphonic	15
Fisher	02,12,18,19,43,48,58	Tandy	02,15
Funai	15	Tashiko	09
GE	00,07,08,32,37,53	Tatung	30
Goldstar	09,14,46,60	Teac	15,30,69
Harman Kardon	14	Technics	08
Hitachi	05,15,35,36	Teknika	08,09,15,21
Instant Replay	08	TMK	67
JCL	08	Toshiba	05,13,19,48,49
JC Penney	02,05,07,08,14,	Totevision	07,09
.....	16,30,35,51,53	Unitech	07
JVC	02,14,16,30,46,74	Vector Research	14,16,44
Kenwood	02,14,16,30,44,46	Victor	16
KLH	73	Video Concepts	14,16,44
Lloyd	15	Videosonic	07
Logik	31	Wards	05,06,07,08,09,
Magnavox	08,29,53,56	12,13,15,25,27,31,35
Marantz	02,08,14,16,29,	Yamaha	02,14,16,30,46
.....	30,44,46,61	Zenith	11,17,26,72,79
Marta	09		
MEI	08		
Memorex	08,09,12,15		
MGA	04,27		
Midland	32		
Minolta	05,35		
Mitsubishi	04,05,27,35,40		
Montgomery Ward	06		
MTC	07,15		
Multitech	07,15,31,32		
NEC	02,14,16,30,44,46,59,61,64		

PROGRAM THE REMOTE

PROGRAMMING THE REMOTE TO CONTROL A DVD PLAYER OR LASERDISC PLAYER

The remote's DVD•VCR button is preprogrammed to control the primary functions of a Proscan, GE, or RCA DVD player. If you would like this button to control a device other than a DVD player, you may program the remote to control a laserdisc player or VCR. To program the DVD•VCR button to control a device, use the DVD player or laserdisc player codes at the right or the VCR codes on the previous page.

1. Turn on the DVD player, laserdisc player or VCR.
2. Look up your brand and its code number(s) on the code lists.
3. Press and hold the DVD•VCR2 button on the remote.
4. Enter the two-digit code from the code list.
5. Release the DVD•VCR2 button and press POWER or another button to see if the device responds to the remote commands.
6. Repeat these steps using the next code listed for your brand, until the device responds to the remote commands.

PROGRAMMING THE REMOTE TO CONTROL AN RCA AUDIO DEVICE:

Your remote controls only RCA audio equipment such as an audio receiver or amplifier—it does not control other brands of audio equipment. Also, the remote may need to be programmed for your equipment. This remote may not operate all models of the brands that are shown at right. Use the codes below or on the sheet packed in with your remote.

1. Turn on the component to be programmed.
2. Look up your brand and its code number(s) on the code list.
3. Press and hold the AUDIO button.
4. Enter the two-digit code from the code list.
5. Release the AUDIO button and press POWER or CH ^ (channel up) or CH v (channel down) to see if the audio device responds to the remote commands.
6. Repeat these steps using the next code listed for your brand until the audio device responds to the remote commands.

DVD Player Codes

GE	78
ProScan	78
RCA	78

Laserdisc Player Codes

Pioneer	33,37
ProScan	33,37
RCA	33,37

Audio Codes

RCA/Dimensia	
AM/FM	03
CD	07
Tape	06
Phono	05
Aux	04

PROGRAM THE REMOTE

PROGRAMMING THE REMOTE TO CONTROL A SATELLITE RECEIVER OR CABLE BOX

Refer to the Connection Foldout or contact your cable company to hook up your cable box. If you have a cable box with its own remote, then you may also be able to use the TV's remote with your cable box. This remote may not operate all models of the brands that are shown. Use the codes at the right, or on the sheet packed with your remote.

1. Turn on the cable box or satellite receiver.
2. Look up your brand and its code number(s) on the code list.
3. Press and hold the SAT•CABLE button on the remote.
4. Enter the two-digit code from the code list.
5. Release the SAT•CABLE button and press POWER or CH ^ (channel up) or CH v (channel down) to see if the cable box responds to the remote commands.
6. Repeat these steps using the next code listed for your brand until the cable box or satellite receiver responds to the remote commands.

USING THE REMOTE TO CONTROL A DEVICE

Once the remote has been programmed with the correct codes, you are ready to use it to control your devices.

To operate the device:

1. Press the device button (TV, VCR1, SAT•CABLE, DVD•VCR2, or AUDIO) to set the remote to control the device.
2. Press POWER to turn the device off or on.
3. Use the remote buttons that apply to that device.

Satellite / Cable Box Codes

ABC	22,46,53,54
Anvision	07,08
Cablestar	07,08
Chaparral	80,81
Cheyenne	81
Diamond	56
Drake	82,83
Eagle	07,08
Eastern Int.	02
General Instruments	46,92,93,94
GI 400	04,05,15,23,24,25,30,36
Hamlin	03,12,13,34,48
Hitachi	37,43,46
Jerrold	04,05,15,23,24,25,30, 36,45,46,47,62,65
Macom	37,43
Magnavox	07,08,19,21,26,28, 29,32,33,40,41
NSC	09
Oak	01,16,38
Oak Sigma	16
Panasonic	03,27,39,61
Philips	07,08,19,21,26,28, 29,32,33,40,41
Pioneer	18,20,44
Randtek	07,08
RCA	00,27,66
Realistic	84
Regal	03,12,13
Regency	02,33
Samsung	44
Sierra I,II,III	81
Sci. Atlanta	03,22,35,63,64
Signature	46
Sony DBS	95
Sprucer	27
Starcom	46
Stargate 2000	58
STS1,2,3,4	85,86,87,88
Sylvania	11,59
Teknika	06
Texscan	10,11,59
Tocom	17,21,49,50,55
Toshiba	89
Uniden	90
Unika	31,32,41
Universal	51,52,60
Video Cipher II	91
Viewstar	07,08,19,21,26,28, 29,32,33,40,41
Warner Amex	44
Zenith	14,42,57,61

TOUR OF THE TV

A PICTURE BOOK TOUR

This section talks about the TV's main parts (at least the parts you'll actually use):

- **The remote control**
- **The back panel**
- **The front panel**
- **The channel marker**

TOUR OF THE TV

REMOTE BUTTONS

POWER When in TV mode, turns off the TV. In VCR mode, and if programmed, turns on and off most VCRs.

VCR1 If programmed, turns on VCR and puts the remote in VCR mode. Also turns on the TV.

SAT•CABLE If programmed, turns on satellite receiver or cable box. Puts the remote in SAT•CABLE mode. Also turns on the TV.

DVD•VCR2 If programmed, turns on DVD player or second VCR or laserdisc player. Puts the remote in DVD•VCR2 mode. Also turns on the TV.

AUDIO If programmed, turns on RCA audio component and puts the remote in audio mode.

TV Turns on the TV and puts the remote in TV mode. Also displays channel information.

REVERSE, PLAY, FORWARD, REC•VCR+, STOP, PAUSE If programmed, provides transport control for some remote-controllable VCRs, DVD players, laserdisc players, tape decks, and CD players. Pressing REC-VCR+ when using the TV GUIDE+ system sets the VCR to record a program.

VOL – or VOL + Decreases or increases the TV's volume.

CH ^ or CH v Scans up or down through the current channel list. Press once to change the channel up or down; press and hold to continue changing channels.

INFO Brings up channel information. Press repeatedly to see detailed program information, if available.

SKIP Press once before changing channels and the TV will wait 30 seconds before returning you to the original channel. Press repeatedly to add more time.

MUTE Reduces the TV's volume to its minimum level. Press again to restore the volume.

GO BACK Returns you to the previous channel.

(0-9) Number Buttons Enters channel numbers and time settings directly through the remote control. To enter a two-digit channel, press the two digits. To enter a three-digit channel, press and hold the first digit, then add the second two. Example: to tune to channel 123, press and hold 1, press 2, then press 3.

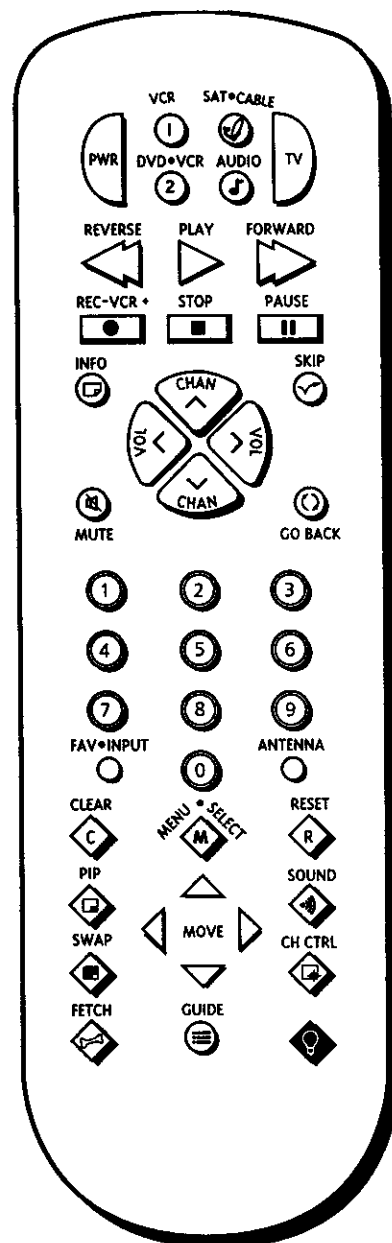

For more details, see the previous section, *Program the Remote*.

TOUR OF THE TV

FAV•INPUT In TV mode, press to toggle through the available input sources (VID1, VID2, previous channel). In SAT mode, press to select available channel lists.

ANTENNA Functions as TV/VCR button in VCR mode and TV/receiver button in SAT•CABLE mode.

CLEAR Removes any menu or display from the screen and returns you to TV viewing.

MENU•SELECT Brings up the Main menu. When in the menu system, selects highlighted items or returns you to the previous menu. When in VCR mode, it functions as a PROGRAM button.

RESET Resets picture quality controls to the *Bright Lighting* Picture Control Preset. Point and select to choose a different Picture Control Preset.

MOVE (Arrows) Used to point to different items in the menu system. Also used to adjust the menu controls. Also move the PIP window when no menus are on the screen.

PIP Brings up the small picture-in-picture window. Press again to remove the PIP window.

SOUND Press once to display the audio processor control panel. Point and select to choose a different processor or press CLEAR to exit.

SWAP Swaps the main picture with the PIP window.

CH CTRL Selects the picture window, (that is, the main or PIP window) that is changed by the CH ^ (channel up) or CH v (channel down) buttons.

FETCH Brings up the FETCH menu. Point to different menu items with the arrow buttons. Press MENU to select a highlighted FETCH menu item.

GUIDE Brings up TV GUIDE Plus+ menus. In SAT•CABLE mode brings up available on-screen guides. Press GUIDE button several times to toggle through the different types of guides.

TOUR OF THE TV

BACK PANEL

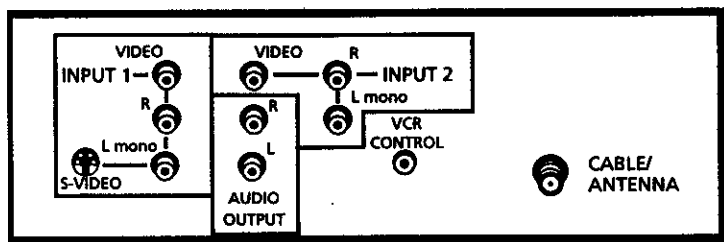

INPUT 1 Lets you connect a video component such as a VCR, satellite receiver, DVD player or laserdisc player.

L/MONO Provides left audio connection. Or, if you are connecting a mono component, use the L/MONO input. The left audio connector is usually white.

RIGHT Provides right audio connection. The right audio connector is usually red.

VIDEO Provides video connection. The video connector is usually yellow.

S-VIDEO Lets you connect a component with S-Video capability, such as an S-video satellite receiver, DVD player or VCR. When using S-Video, make sure to connect the three audio/video cables as well as the S-Video connector.

INPUT 2 Provides a connection for a second video component such as a VCR, satellite receiver, DVD player or laserdisc player.

L/MONO Provides left audio connection. Or, if you are connecting a mono component, use the L/MONO input. The left audio connector is usually white.

RIGHT Provides right audio connection. The right audio connector is usually red.

VIDEO Provides video connection. The video connector is usually yellow.

ANT (Antenna) Provides connection to a home antenna or cable TV system.

If you are connecting a component to the VIDEO 1 INPUT and you are using S-Video, remember to connect the regular VIDEO 1 INPUT video cable as well.

Hooking up components isn't hard, but double-checking the cable and jack connections may help you avoid problems.

TOUR OF THE TV

AUDIO OUTPUT Provides variable-controlled or fixed-level stereo audio output.

Variable output is ideal when connecting the TV to an amplifier that does not have its own volume control or remote control.

Fixed output is ideal when connecting to an A/V receiver or amplifier that has its own remote control.

You can choose the type of audio output by selecting the Audio Output & Speakers control panel in the Audio menu.

VCR CONTROL Lets you connect the TV GUIDE Plus+ controller, which allows direct control of your cable box and VCR.

To connect an amplified subwoofer to the TV, use the left (L) AUDIO OUTPUT jack.

TOUR OF THE TV

FRONT PANEL

MENU Brings up the Main menu. When in the menu system, it selects highlighted items. Also returns you to the previous menu.

CH v Scans down through the current channel list. In the menu system, it points down to items and adjusts menu controls.

CH ^ Scans up through the channel list. In the menu system, it points up to items and adjusts menu controls.

VOL - Decreases the volume. When in the menu system, VOL - is used to point left to items and adjust menu controls.

VOL + Increases the volume. When in the menu system, VOL + is used to point right to items and adjust menu controls.

POWER Turns the TV on and off.

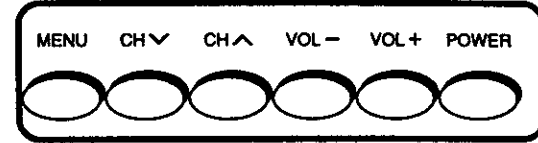

The front panel above shows a typical button layout. The exact look of the buttons may be different from those on the front of your TV.

If you turn Parental Control on, or lockout the front panel, the front panel no longer provides access to the menus. For more information, see *Parental Control*, in the Quick Reference section.

TOUR OF THE TV

CHANNEL MARKER

There are several indicators that come up when you change channels, press the INFO button, or press the TV button. This display is called the Channel Marker.

12:01 Displays the current time.

CC Displayed when Closed Captioning is available on the current channel.

VCR1 Displays the label assigned to the current channel.

VID1 Displays the current channel or input channel.

Mute (or Stereo) Mute is displayed when you mute the audio. Stereo is displayed when the current channel is broadcasting in Stereo.

SAP Displayed when the current channel is broadcasting SAP (Second Audio Program) information.

PIP 59 (PIP Chan) Displays the current PIP channel.

Remote batteries are low Displayed when the batteries in the remote need to be replaced.

Sleep Displayed when the Sleep Timer has been set.

00:00 Displayed to count down time left on the commercial skip (SKIP) timer.



The channel marker shown above is just an example, of course.

QUICK REFERENCE

A SHORT GUIDE TO THE MENU SYSTEM

This section provides a brief explanation of all the menu commands. These commands are organized in the chapter by their location in the Main menu.

- **AUDIO** Contains the controls that let you adjust the way the TV sounds.
- **PICTURE QUALITY** Contains the controls that let you adjust the picture.
- **SCREEN** Contains the controls that let you adjust the projection tubes' alignment, menu language, and closed-caption mode and display.
- **CHANNEL** Contains all the commands used to control your channels, including custom-building your channel list and setting up your TV to control the components connected to the TV.
- **TIME** Contains the controls that let you set the time and schedule the TV to turn off and on at specific times.
- **PARENTAL CONTROLS** Contains the controls that let you block out specific channels and lock the TV's front panel controls.
- **TV GUIDE PLUS+ MENU** Contains the controls that let you set up the TV GUIDE Plus+ menu, run a demo, or turn the Label & Title display on and off.
- **SETUP** Begins an interactive setup routine that lets you adjust your TV's menu system, channel list and how your TV receives signals from other components.

QUICK REFERENCE

AUDIO MENU

Mute Press MENU to reduce the TV's volume to its minimum level. Press MENU again to restore the volume.

Tone Controls Displays the slider controls for adjusting the TV's treble, bass and balance.

Audio Processor Displays a choice list of available audio modes, which control the way the sound comes through your speakers.

Mono Plays the sound in mono only. Use this setting when receiving broadcasts with weak stereo signals .

Stereo Splits the incoming stereo audio signal into left and right channels. Most TV programs and recorded materials have stereo audio. The TV displays the word STEREO when you tune to a program that is broadcast in stereo.

SRS Stereo (•) SRS* is an audio processing technology that adds greater depth and stereo separation to stereo audio signals.

Enhanced SRS Stereo Enhances the SRS signal to give the impression of even greater depth and stereo separation.

Sound Logic Stereo Sound Logic monitors a program's audio track and limits the volume to a minimum and maximum volume range. Whenever you adjust the volume on the TV, the minimum and maximum volume range adjusts, too.

Second Audio Program (SAP) Plays the program's audio in a second language, if one is available. The TV displays the word SAP when you tune to a program that is broadcast with SAP information. SAP audio is broadcast in mono.

Audio Output & Speakers Displays a choice list that lets you turn the TV's internal speakers on or off and set the audio outputs to fixed-level or variable control level.

Variable Output, Speakers On This setting turns the TV's speakers on and allows variable output from the TV's audio output jacks.

Variable Output, Speakers Off This setting turns the TV's speakers off and allows variable output from the TV's audio output jacks.

Fixed Output, Speakers Off This setting turns the TV's speakers off and allows fixed output from the TV's audio output jacks.

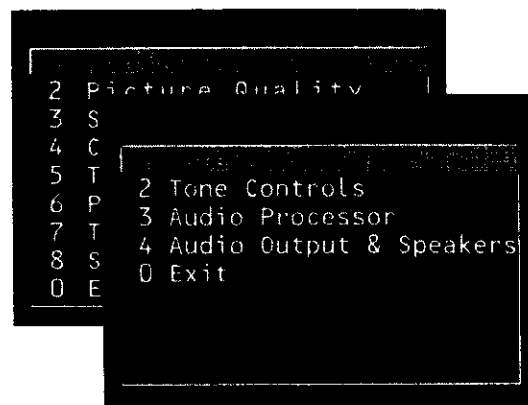

* SRS, Sound Retrieval System and the SRS logo (•) are registered trademarks of SRS Labs, Inc.

If a loud commercial comes on, Sound Logic can compress the sound and limit the volume to a minimum and maximum volume range.

QUICK REFERENCE

PICTURE QUALITY MENU

Basic Picture Controls Displays the five slider controls for adjusting the way the picture looks.

Contrast Adjusts the difference between the light and dark areas of the picture.

Color Adjusts the richness of the color.

Tint Adjusts the balance between the red and green levels.

Black Level Adjusts the brightness of the picture.

Sharpness Adjusts the crispness of edges in the picture.

Auto Color Displays a choice list that lets you turn on the feature that automatically corrects the color of the picture. (This is especially useful for tracking realistic flesh tone colors as you switch from channel to channel.) Choose *On* or *Off*, depending on your preference. It's your choice.

Color Warmth Displays a choice list that lets you set one of three automatic color adjustments: *Cool* for a more blue palette of picture colors; *Normal*; and *Warm* for a more red palette of picture colors.

Picture Control Presets Displays a choice list that lets you select one of three preset picture settings: *Bright Lighting*, *Normal Lighting* or *Soft Lighting*. Choose the setting that is best for your viewing environment.

Video Noise Reduction Displays a choice list that lets you turn on the feature that automatically reduces noise, or "snow," from the picture.

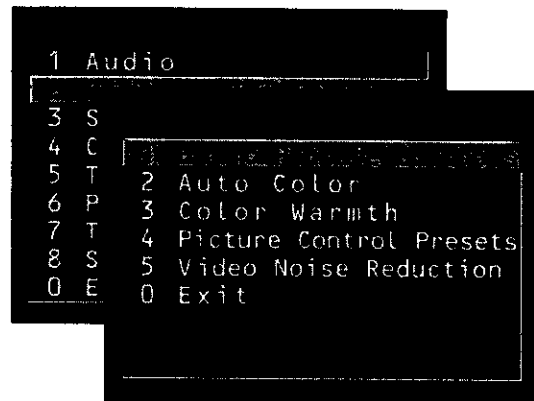

Press the RESET button on the remote to bring up the Picture Control Presets choice list. Point to the desired setting; press MENU to select it.

QUICK REFERENCE

SCREEN MENU

Closed Caption Display Displays a choice list that lets you choose the way closed captioning information is shown on the screen.

Off No captioning information displayed.

On Always Captioning information shown always, when available.

On When Sound is Muted Displays captioning information, when available, whenever the TV's sound is muted by pressing the MUTE button. The captioning information is not displayed when the sound is not muted.

Closed Caption Mode Displays a choice list that lets you choose which captioning mode is used for displaying captioning information.

Menu Language Displays a choice list that lets you select your preferred language: *English, Spanish, or French.*

Adjusting Projection TV Lets you adjust the TV's three color projection tubes for precise picture alignment.

Selecting *Green Centering* brings up a control panel that lets you center the green projection tube on the screen. Selecting *Red Convergence* or *Blue Convergence* lets you align the red and blue projection tubes.

Center the green projection tube first. Then, adjust the red and blue projection tubes until the test patterns on the TV screen appear white.

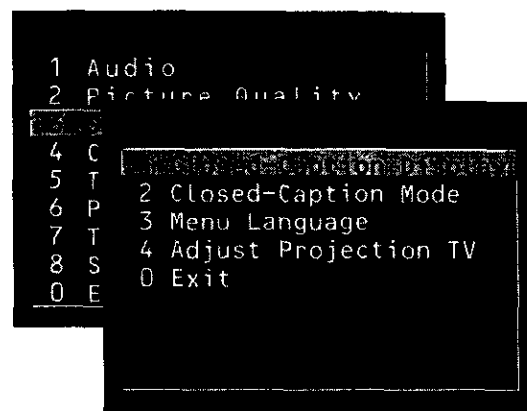

Your projection TV has three color projection tubes—one for red, one for green, and one for blue. When the tubes are precisely aligned they create the color images you see on the TV screen. Over time, the picture can drift out of alignment due to normal bumps and vibrations or moving the TV. If you notice rings or halos around objects in the picture, you may want to adjust the picture tubes.

QUICK REFERENCE

CHANNEL MENU

Signal Type Displays a choice list that lets you select the current antenna type. This option does not appear when the TV GUIDE Plus+ system is set up.

UHF/VHF Antenna Choose this if you are currently using an off-air antenna for TV signals.

Cable TV Choose this if you are currently using cable or a cable box for TV signals.

Auto Channel Search Tells the TV to search automatically for all the channels available through the antenna input. When the TV finds an active channel, it places it in the channel list; inactive channels (weak stations or channels with no signal at all) will be removed from the channel list.

List and Labels Displays a control panel that lets you custom-build your Normal channel list and choose a six-character label for each channel. Follow the on-screen directions to enter your channels and other information.

Chan # Use the up and down arrows to scroll up and down through the channel scan list. You can enter the channel number directly using the number buttons.

Normal List Only the channels included in the Normal list are available when you scan up and down using the CHAN buttons. Use the up and down arrows to indicate whether the channel number indicated is included (Yes) or is not included (No) in the Normal channel list.

Chan Labels Use the up and down arrows to enter a six-character label for each channel. Hold the button down to scroll quickly through the characters. Press RESET to clear a label. **The TV can store up to 27 labels in memory.**

Channel Directory Displays all of the labeled channels. In the Channel Directory control panel, you can select a channel by entering the channel number, or by pressing MENU to return to the current channel. This option does not appear when the TV GUIDE Plus+ system is set up.

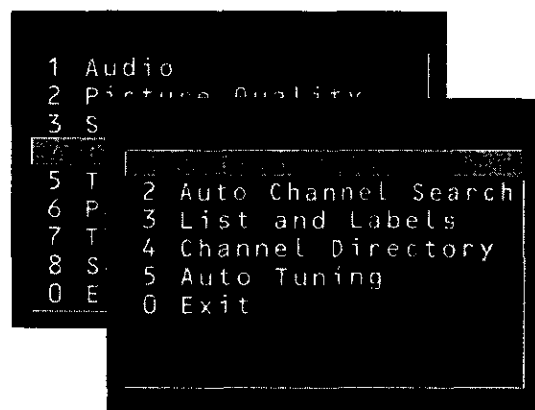

QUICK REFERENCE

(Channel Menu continued)

Auto Tuning Displays a choice list that lets you set up the TV to automatically tune to the correct input channel when you press a component button (VCR1, DVD•VCR2, or SAT•CABLE).

Set VCR 1 Channel Displays a choice list that lets you select the channel that the TV tunes to when you press the VCR1 button.

Set DVD•VCR 2 Channel Displays a choice list that lets you select the channel that the TV tunes to when you press the DVD•VCR2 button.

Set SAT•Cable Channel Displays a choice list that lets you select the channel that the TV tunes to when you press the SAT•CABLE button.

The choices are:

Not Connected Choose this if you do not have a component connected to an antenna or video input on the back of the TV, or if you don't want the TV to tune to a channel when the particular component button is pressed.

Channel 2 (SAT/Cable only) Choose this if your component is connected to the antenna jack on the back of the TV, and you want the TV to tune to channel 2 when you press the specified component button. Reminder: Make sure the component's Ch 2/3/4 switch is set to channel 2.

Channel 3 Choose this if your component is connected to the antenna jack on the back of the TV, and you want the TV to tune to channel 3 when you press the specified component button. Reminder: Make sure the component's Ch 3/4 switch is set to channel 3.

Channel 4 Choose this if your component is connected to the antenna jack on the back of the TV, and you want the TV to tune to channel 4 when you press the specified component button. Reminder: Make sure the component's Ch 3/4 switch is set to channel 4.

Video 1 Input Choose this if your component is connected to the Video 1 jacks on the back of the TV and you want the TV to tune to Video1 input when you press the specified component button.

Video 2 Input Choose this if your component is connected to the Video 2 jacks on the back of the TV and you want the TV to tune to Video 2 input when you press the specified component button.

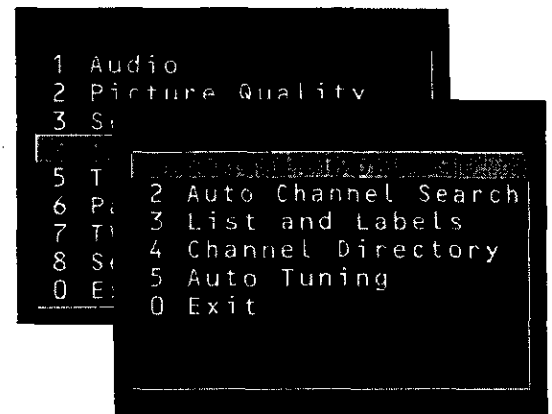

QUICK REFERENCE

TIME MENU

Sleep Timer Displays a control panel that lets you select the amount of time you want to give the TV before it shuts itself off.

Schedule Displays a control panel that lets you set up a schedule for turning the TV on and off automatically. **Make sure to turn the schedule On.** The on-screen directions guide you through the steps needed to set the schedule.

Set Time Displays a control panel that lets you enter the current time. The on-screen directions guide you through the steps needed to set the time.

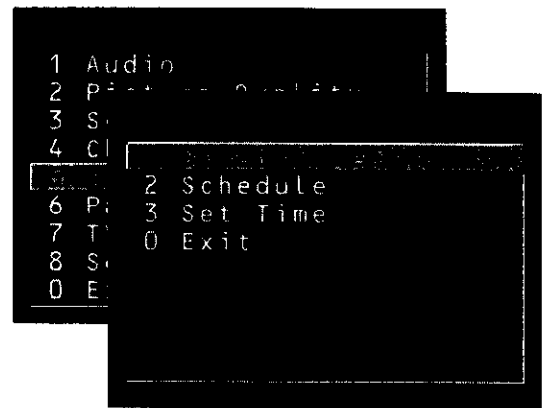

QUICK REFERENCE

PARENTAL CONTROLS MENU

Displays the menu items that let you adjust the Parental Controls feature.

Parent Approved Channels Displays a control panel that lets you decide what channels can be viewed or selected using the TV's front panel controls.

Chan # Use the up and down arrows to scroll up and down through the channel scan list. You can enter the channel number directly using the number buttons.

Parent Approved Use the up and down arrows to choose whether the channel indicated should be shown when the Channel Block feature is turned on. Select *Yes* to indicate that the channel can be shown at any time, regardless of whether Channel Block is turned on. Select *No* to indicate that the front panel cannot tune to that channel when Channel Block is turned on. **Important:** You must turn the Channel Block feature on. (See Channel Block, below.)

Channel Block Displays a control panel that lets you decide when a channel can be viewed.

Off All channels are available

On Always The front panel CH (channel) buttons will tune only to channels that you have marked as "Parent Approved." The remote will still tune to any channel.

Scheduled Selected channels will be blocked out between start and stop times you enter in the control panel. The front panel CH (channel) buttons will tune only to channels that you have marked as "Parent Approved." The remote will still tune to any channel.

Front Panel Lockout Displays a control panel that lets you lock (disable) the TV's front control panel, or unlock (enable) the TV's front control panel. The remote will still tune to any channel.

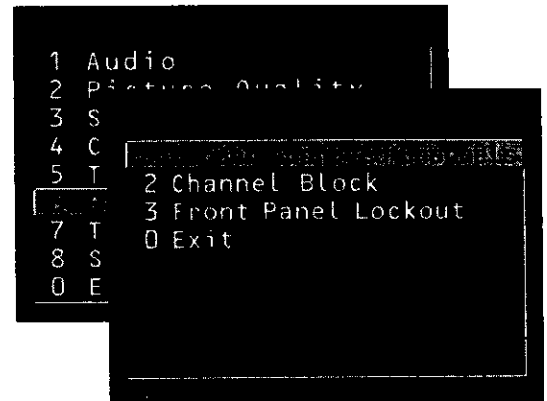

If you can't access a channel or use the TV's front panel control, maybe you've forgotten to turn off a parental control. Check the Channel Block and Front Panel Lockout control panels.

QUICK REFERENCE

TV GUIDE PLUS+ MENU

TV GUIDE Plus+ Setup Displays the TV GUIDE Plus+ setup screen.

Setup Setting up the TV GUIDE Plus+ system is detailed earlier in *Interactive Setup*.

Demo Runs the TV GUIDE Plus+ demonstration.

Select Channels Allows you to choose which channels appear in the TV GUIDE Plus+ program schedule.

TV GUIDE Plus+ Label & Title Displays the TV GUIDE Plus+ Label & Title menu.

On Displays the station name and show title when you change channels.

Off Disables the Label & Title feature.

Continuous Demo Runs the TV GUIDE Plus+ demonstration until it is turned off.

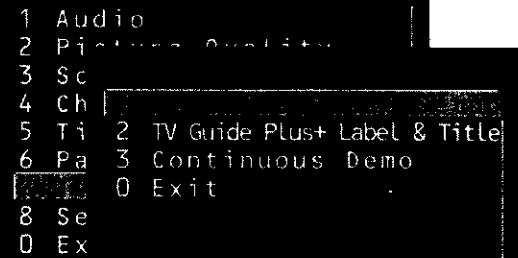

```
1 Audio
2 Picture Quality
3 Sc
4 Ch
5 Ti
6 Pa
0 Exit
  2 TV Guide Plus+ Label & Title
  3 Continuous Demo
  0 Exit
```

QUICK REFERENCE

SETUP MENU

The setup routine is detailed earlier in the manual in the Interactive Setup section.

```
1 Audio
2 Picture Quality
3 S
4 C
5 T
6 P
7 T
8
0 E
```

```
2 Cancel setup
```

ADVANCED FEATURES

**THIS SECTION DETAILS SOME OF THE
TV'S IMPORTANT FEATURES:**

- **TV GUIDE Plus+ operation**
- **PIP (Picture-in-Picture) operation**
- **Fetch menu display**
- **Choosing an audio processor**
- **Using closed captioning**
- **Displaying on-screen program details**

For more about the different menus and control panels in the menu system, see the *Quick Reference* section.

ADVANCED FEATURES

TV GUIDE PLUS+ OPERATION

The TV GUIDE Plus+ system offers four different menus for browsing program listings: SURF, NEXT, SCAN, and SORT.

1. Press GUIDE to bring up the TV GUIDE Plus+ display.

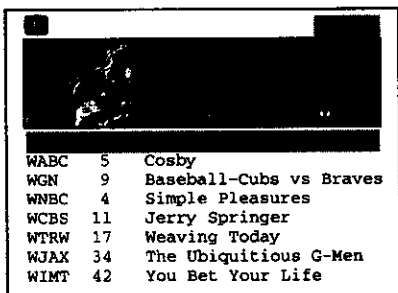

2. To choose a menu, select *CHOICE*. The Surf Menu comes up by default.
3. Use the left and right arrows to access another menu. Press MENU to select your choice.

Surf Menu

The Surf Menu displays the current program on each channel. The live program displayed in the video window changes as you surf channel listings.

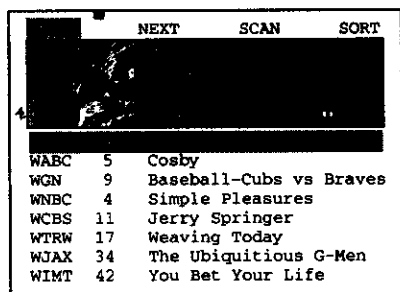

- Use the up and down arrows to surf channel listings.
- To select another menu, use the left and right arrows, and then press MENU.
- Press GUIDE or CLEAR to exit the TV GUIDE Plus+ system. Pressing GUIDE changes to the last channel highlighted. Pressing CLEAR returns to the original channel.

Channel Mapping

If more than one cable company services your area, you may be prompted with this Channel Mapping screen after the first TV GUIDE Plus+ download. You will need to identify your cable company by selecting the correct channel numbers for the stations in question.

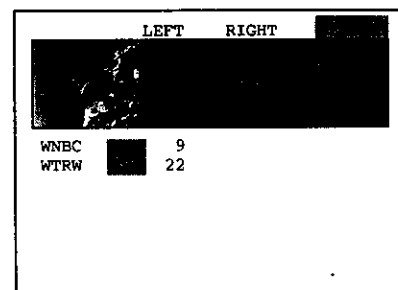

1. Determine the correct channels for the stations. Check your local listings if you are not sure.
2. Select *LEFT* or *RIGHT* to change the channel group.
3. Select *SELECT* when the correct channel group is highlighted.

ADVANCED FEATURES

Next Menu

The Next Menu displays the programs on a selected channel from the current time to midnight of the next day.

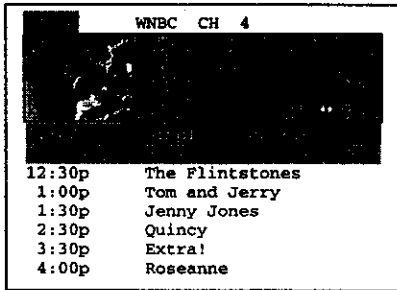

Time	Program
12:30p	The Flintstones
1:00p	Tom and Jerry
1:30p	Jenny Jones
2:30p	Quincy
3:30p	Extra!
4:00p	Roseanne

- Use the up and down arrow buttons to move through the schedule. An asterisk after the time indicates that the program is scheduled for tomorrow.
- Use the right and left arrows to select a different menu, or press GUIDE or CLEAR to exit the TV GUIDE Plus+ system.

Scan Menu

The Scan Menu shows programming schedules for all channels from the current time to midnight on the following day.

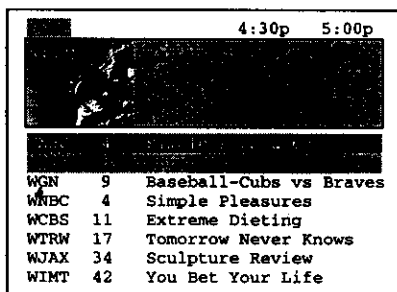

Channel	Program
WGN 9	Baseball-Cubs vs Braves
WNBC 4	Simple Pleasures
WCBS 11	Extreme Dieting
WTRW 17	Tomorrow Never Knows
WJAX 34	Sculpture Review
WINT 42	You Bet Your Life

- Use the left and right arrows to highlight the time of day, and then press MENU to select it.
- Use the up and down arrows to move through the schedule. The channel displayed in the video window remains on the initial channel.
- Select SURF to return to the surf menu, or press GUIDE or CLEAR to exit the TV GUIDE Plus+ system.

The Info Center

If this icon ▼ appears in the program information, you may access additional information about that program by pressing INFO. This feature is available in all four menus.

Even if the ▼ icon isn't displayed, pressing INFO will show a PlusCode programming number which allows you to program your VCR to record using VCR Plus+.

Press INFO a second time to return to the TV GUIDE Plus+ menu.

Alternately, you will find the Info Center in the Surf and Sort menus. Select it to view additional information.

Along with additional programming information, the Info Center may contain information on local events, or on the TV GUIDE Plus+ system itself. Information contained in the info center will vary from area to area, so not all of these options may be available to you at this time.

Press INFO to exit back to the menu.

ADVANCED FEATURES

Sort Menu

The Sort Menu lets you browse programs by category. The channel you are currently tuned to is displayed in the video window and by name.

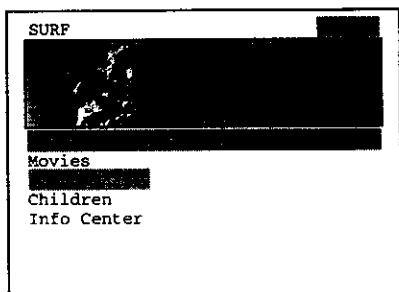

1. Use the up and down arrows to select a category. In this example we'll choose *Sports*. A listing of subcategories comes up.

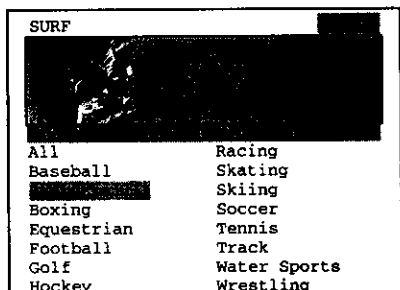

2. Use the up and down arrows to select a subcategory, in this example *Basketball*. The message, "Searching in progress. Please Wait" comes up.

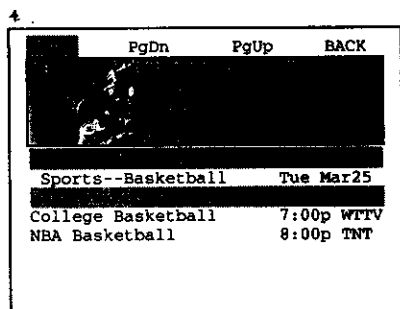

3. When the listing comes up, select *PgDn* to view more entries. Seven days of programming are listed in the Sort Menu.
4. Select *SURF* to return to the surf menu, or press *GUIDE* or *CLEAR* to exit the TV GUIDE Plus+ system.

Customizing Your Channel Listing

You may customize the channel listing by enabling or disabling the display of certain channels. For instance, you may disable channels that you never watch. You can restore disabled channels at a later point in time, of course.

1. From the TV's Main Menu, select *TV Guide Plus+ Menu*.
2. Select *TV Guide Plus+ Setup*. The TV GUIDE Plus+ menu comes up.
3. Select *Select Channels*.

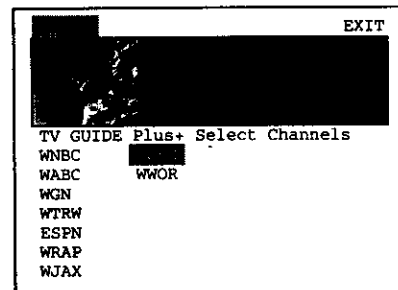

4. Use the up and down arrows to select a channel.
5. Select *ENABLE* or *DISABL* to add or remove a channel from the guide's listing. Note that this button's name changes depending on the activation status of the selected channel.
6. Select *EXIT* when you are finished.

Selected channels will be added or removed from the list during the next download.

Sort Menu Options

PgDn shows more listings

PgUp returns to the previous screen.

BACK allows you to select another category to sort.

ADVANCED FEATURES

One-Button Recording

The TV GUIDE Plus+ system allows one-button recording if you have connected the IR controller to your VCR. See *First Things First* for more details on connecting the IR controller.

1. Press GUIDE to bring up the TV GUIDE Plus+ menu.

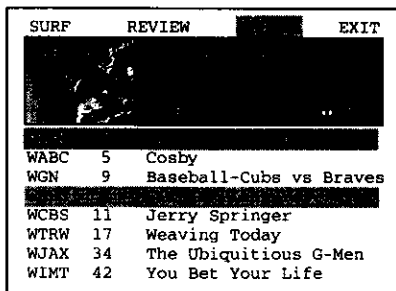

2. Select a program to record. You may choose a program from any of the four browsing menus.
3. Press REC•VCR+. A screen confirming your selection comes up.

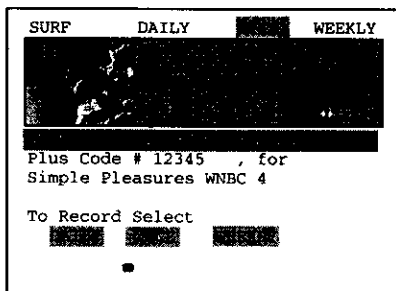

4. Select a recording option: *DAILY*, *ONCE*, or *WEEKLY*.

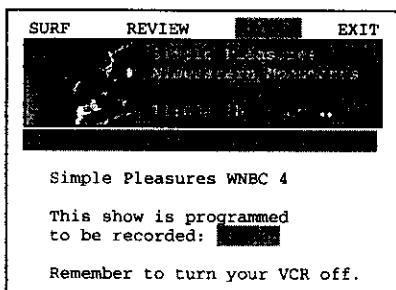

5. Insert a blank tape into your VCR and turn it off.

Recording Options

DAILY records the same program Monday through Friday.

ONCE records only on that day.

WEEKLY records the program each week at the same time.

REVIEW displays a list of programs set to be recorded. You may delete programs from this list.

Tip: You can record the program you are currently watching by simply pressing REC•VCR+.

ADVANCED FEATURES

PIP (PICTURE-IN-PICTURE) OPERATION

The PIP feature (picture-in-picture) lets you display a second, smaller picture on top of the main picture.

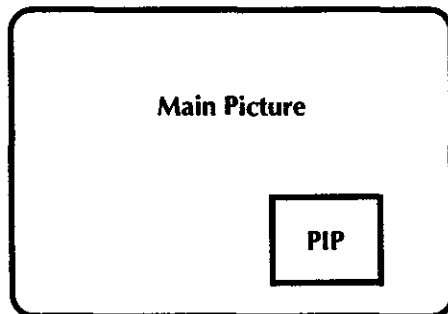

There are seven remote buttons that control the way the PIP window works:

PIP Brings up the PIP window. Press PIP again to remove the window.

MOVE buttons Let you move the PIP window to different areas of the screen.

SWAP Switches, or "swaps," the video from the PIP window with the main picture.

CH CTRL (Channel Control) Lets you switch channel control between the PIP window and the main picture.

For instance, press PIP to bring up the PIP window. You can change channels by entering channel numbers or pressing the CH ^ (channel up) or CH v (channel down) buttons. When you press the CH CTRL button the channel control switches to the main picture. You can now change channels in the main picture by entering channel numbers or pressing the CH ^ (channel up) or CH v (channel down) buttons.

Press CH CTRL again to return the channel control to the PIP window.

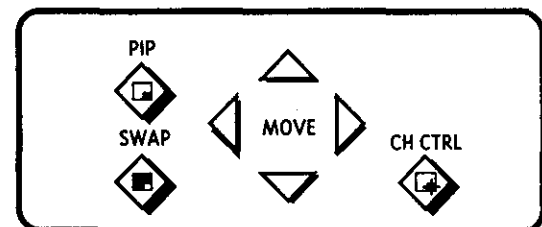

A typical use of SWAP is to scan through channels in the PIP window, and when you find a channel you like, press SWAP to display that channel in the main picture, sending the current channel to the PIP window.

ADVANCED FEATURES

Two Tips for Using PIP Buttons

Skip to PIP: Channel Surfing in the Main Picture

You can surf through the channels during commercial breaks using the SKIP and CH (channel) buttons.

1. Press SKIP to set the commercial skip timer and bring up the PIP window. The current channel appears in both the main picture and the PIP window.
2. Press the CH ^ (channel up) or CH v (channel down) buttons. The main picture surfs through the channel list. When the SKIP feature times out, the original channel will return automatically to the main picture.

Channel Surfing in the PIP Window

You can use the PIP window to surf through channels as well.

1. Press PIP to bring up the PIP window.
2. Press the CH ^ (channel up) or CH v (channel down) buttons. The TV begins displaying each channel in the PIP window. If you see a channel that interests you, press SWAP.

ADVANCED FEATURES

FETCH MENU

The FETCH menu is a short-cut to several commonly used features and appears as colored icons at the bottom of your screen. You can display the FETCH menu by pressing the FETCH button on the remote. Use the arrow buttons to highlight an item and press MENU to select it.

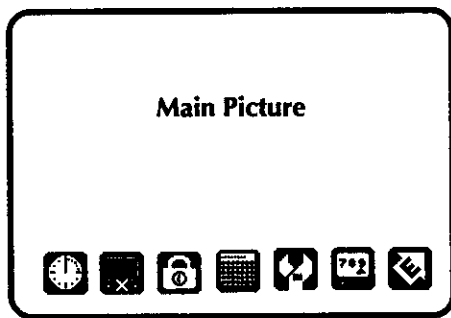

Sleep Timer Select this item to go directly to the Sleep Timer control panel. Use the arrow buttons to adjust the timer.



Front Panel Lockout Takes you directly to the Front Panel Lock control panel. Here you can enable or disable the buttons on the front of the TV.



Parental Controls Select this item to display the Parental Controls menu. Select a menu item to go to the desired control panel.



Schedule Displays a control panel that lets you program the TV to turn on and off automatically. Make sure to turn the schedule *On*.



Begin Setup Starts the Interactive Setup routine that lets you choose a menu language, search for available channels and set component channels.



Channel Directory Select this item to display a list of all labeled channels in alphabetical order. Enter a channel number to go to that channel or press MENU to return to the current channel.



Exit Select this item to exit the FETCH menu and return to normal channel viewing.

ADVANCED FEATURES

CHOOSING AN AUDIO PROCESSOR

Changing the audio processor changes the way your TV sounds. There are two ways to change the audio processor: a) from the Audio menu, and b) by pressing SOUND on the remote. For more, see Audio menu in the Quick Reference section.

Choosing an audio processor from the Audio menu

1. Press MENU to bring up the Main menu.
2. Press MENU again to select the Audio menu.
3. Point to *Audio Processor* and press MENU. The Audio Processor choice list comes up, with the current mode highlighted.
4. Point to an audio processor mode and press MENU to select it and return to the Audio menu. The options are:

Mono Plays the sound in mono only.

Stereo Splits the incoming stereo audio signal into left and right channels.

SRS Stereo (•) SRS is an audio processing technology that adds greater depth and stereo separation to stereo audio signals.

Enhanced (•) SRS Stereo Enhances the SRS signal to give the impression of even greater depth and stereo separation.

Sound Logic Stereo Sound Logic monitors a program's audio track and limits the volume to a minimum and maximum volume range. Whenever you adjust the volume on the TV, the minimum and maximum volume range adjusts, too.

Second Audio Program (SAP) Plays the program's audio in a second language, if one is available. Setting the audio processor to SAP tells the TV to play the program's audio in this second language, if one is available.

Choosing an audio processor from the remote

1. Press SOUND to display the audio processor choice list.
2. Point to and select a different audio processor or press CLEAR to exit.



The number of audio processor choices available depends on the type of signal you are currently using. For example, depending on the way you have your VCR connected to the TV, the number of choices is greater when you are watching TV than when you are watching a video tape.

ADVANCED FEATURES

CLOSED CAPTIONING

Many programs are encoded with closed captioning information, which lets you display the audio portion of a program as text on the TV screen. You can tell the TV to display closed captioning: a) never, b) whenever it is available, or c) whenever the program is muted.

TO DISPLAY CLOSED CAPTIONING

1. Press MENU to bring up the Main menu.
2. Point to *Screen* and press MENU. The Screen menu comes up with Closed-Caption Display highlighted.
3. Press MENU to select *Closed-Caption Display*.

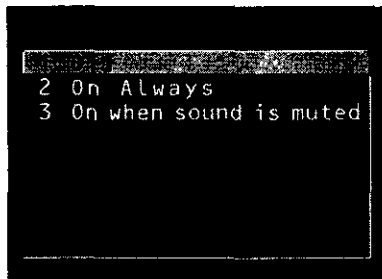

Off No closed captioning information will be displayed.

On Always Closed captioning will be displayed whenever it is available.

On when sound is muted Closed captioning will be displayed only when you have muted the sound by pressing the MUTE button.

4. Point to your choice and press MENU to select it and return to the Screen menu.

Closed captioning is not available on all channels at all times. Only specific programs encoded with closed captioning information are applicable. When a program is closed captioned, the letters CC are displayed in the channel marker.

ADVANCED FEATURES

CLOSED CAPTIONING MODES

The TV offers eight closed-captioned modes, including four text modes.

To Set the Closed-Captioning Mode:

1. Select *Screen* from the Main menu
2. Point to *Closed-Caption Mode* and press MENU. This choice list comes up:

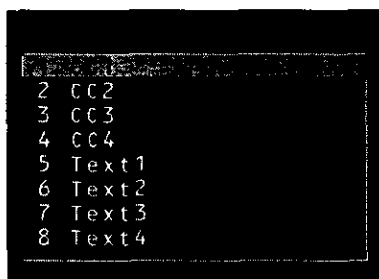

3. Point to your choice and press MENU to select it and return to the Screen menu.

Turning off Closed Captioning

1. Select *Screen* from the Main menu.
2. Press MENU to select *Closed-Caption Display*
3. Point to *Off* and press MENU. The closed captioning is turned off and you are returned to the Screen menu.

If you are unsure of the differences among the modes, you may prefer to leave the closed captioned mode set to CC1, which displays complete text of the program in the primary language in your area.

ADVANCED FEATURES

ON-SCREEN PROGRAM DETAILS

Program providers have the option of sending information through the airwaves along with their programs. If this information is available, the TV can display it up when you press INFO on the remote. To display the on-screen program details:

1. Press INFO once to bring up the channel marker.
2. Press INFO again to bring up the program title, the program's length and elapsed time.
3. Press INFO again to bring up other program details such as the story line and whether Closed-Captioning is available.
4. Press INFO again to clear the screen.

Whether all (or any) of the program details are displayed depends on whether the program provider has sent the information along with the program.

APPENDIX A: USING THE TV CONNECTIONS

THINGS TO DO BEFORE CONNECTING COMPONENTS

Protect your components from power surges

- **Connect all components before plugging any power cords into the wall outlet.**
- **Always turn off the TV and/or component before you connect or disconnect any cables.**

POSITION CABLES CORRECTLY TO AVOID AUDIO HUM OR INTERFERENCE

- **Insert all cable plugs firmly into their jacks.**
- **Place the audio/video cables to the sides of the TV's back panel instead of straight down the middle after you connect your components.**
- **Try not to coil any twin-lead cables and keep them away from the audio/video cables as much as possible.**
- **Make sure all antennas and cables are properly grounded. Refer to the Safety Tips sheet packed with your TV.**

PROTECT YOUR COMPONENTS FROM OVERHEATING

- **Do not block ventilation holes in any of the components. Arrange the components so that air can circulate freely.**
- **Do not stack components.**
- **Allow adequate ventilation when placing your components in a stand.**
- **Place an amplifier on the top shelf of the stand so heated air rising from it will not flow around other components.**

Important:

This section assumes that you have already used the Interactive Setup and programmed the remote.

APPENDIX A: USING CONNECTION A

TV AND MONO VCR (CONNECTION A)

This information applies to Connection A in the Connections Foldout.

Connection A provides:

- stereo sound from broadcast programs
- mono sound from VCR
- Picture in Picture (PIP)
- watch one channel on TV while recording another channel

To use this connection you must have:

- (2) audio/video cables
- (2) coaxial cables

To connect:

1. Connect cables as shown in Connection A.
2. Return to *First Things First*, then follow the steps in the Interactive Setup.

USING CONNECTION A

To watch TV programs:

1. Turn VCR off.
2. Press TV and tune to a channel.

To record one program and watch another:

1. Press VCR1 and tune to a channel.
2. Begin recording.
3. Make sure the TV/VCR switch on the VCR is set to TV.
4. Press TV and tune to a channel.

To play a tape on the VCR:

1. Press VCR1.
2. Press PLAY.

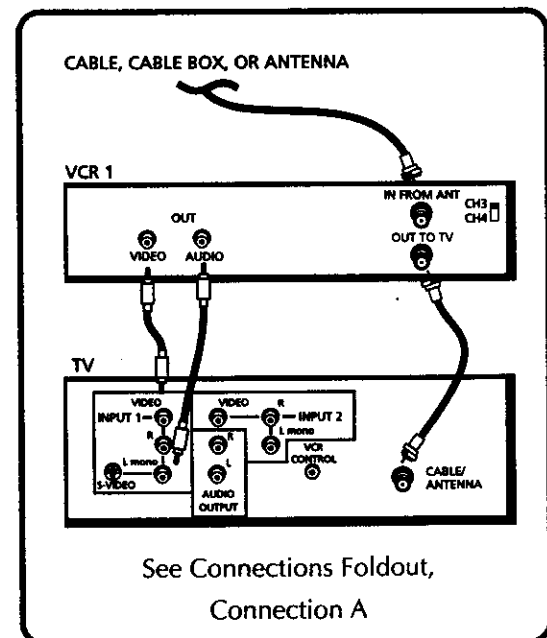

APPENDIX A: USING CONNECTION B

TV AND STEREO VCR (CONNECTION B)

This information applies to Connection B in the Connections Foldout.

Connection B provides:

- stereo sound from broadcast programs
- stereo sound from VCR
- Picture in Picture (PIP)
- watch one channel on TV while recording another channel

To use this connection you must have:

- (2) coaxial cables
- (3) audio/video cables
- (1) S-Video cable (optional)

To connect:

1. Connect cables as shown in Connection B.
2. Return to *First Things First*, then follow the steps in the Interactive Setup.

USING CONNECTION B

To watch TV programs:

1. Turn VCR off.
2. Press TV and tune to a channel.

To record one program and watch another:

1. Press VCR1 and tune to a channel.
2. Begin recording.
3. Make sure the TV/VCR switch on the VCR is set to TV.
4. Press TV and tune to a channel.

To play a tape on the VCR:

1. Press VCR1.
2. Press PLAY.

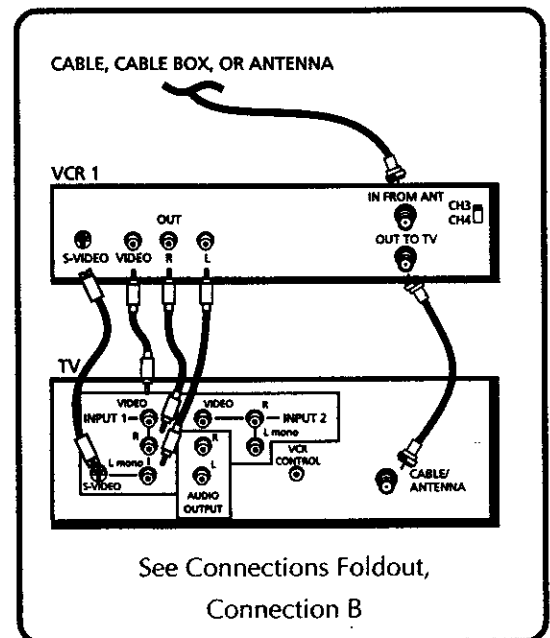

APPENDIX A: USING CONNECTION C

TV, VCR AND DVD PLAYER (CONNECTION C)

This information applies to Connection C in the Connections Foldout.

Connection C provides:

- stereo sound from broadcast programs
- stereo sound from VCR
- Picture in Picture (PIP)
- watch one channel on TV while recording another channel

To use this connection you must have:

- (2) coaxial cable
- (6) audio/video cables
- (1) S-Video cable (optional)

To connect:

1. Connect cables as shown in Connection C.
2. Return to *First Things First*, then follow the steps in the Interactive Setup.

USING CONNECTION C

To watch TV programs:

1. Turn VCR off.
2. Press TV and tune to a channel.

To record one program and watch another:

1. Press VCR1 and tune to a channel.
2. Begin recording.
3. Make sure the TV/VCR switch on the VCR is set to TV.
4. Press TV and tune to a channel.

To play a tape on the VCR:

1. Press VCR1.
2. Press PLAY.

To play a disc:

1. Press DVD•VCR2.
2. Press PLAY.

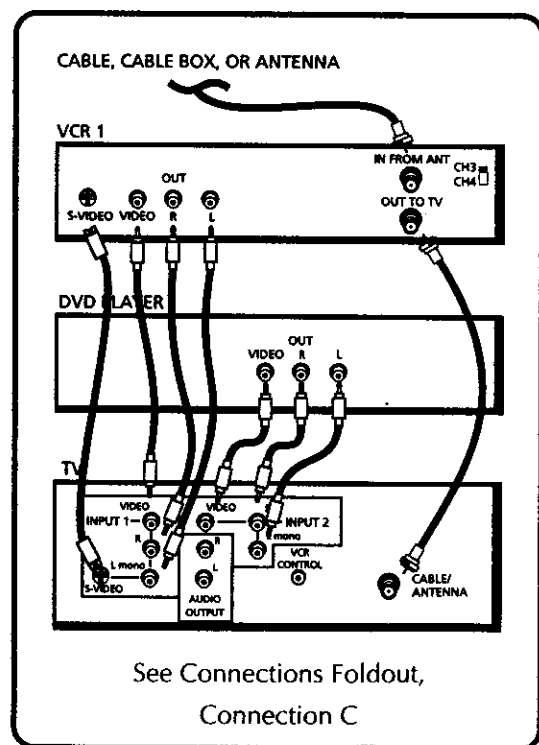

APPENDIX A: USING CONNECTION D

TV AND (2) VCRS (CONNECTION D)

This information applies to Connection D in the Connections Foldout.

Connection D provides:

- stereo sound from broadcast programs
- stereo sound from VCR
- Picture in Picture (PIP)
- watch one channel on TV while recording another channel
- record from one VCR to the other

To use this connection you must have:

- (3) coaxial cable
- (6) audio/video cables
- (1) S-Video cable (optional)

To connect:

1. Connect cables as shown in Connection D.
2. Return to *First Things First*, then follow the steps in the Interactive Setup.

USING CONNECTION D

To watch TV programs:

1. Turn VCR off.
2. Press TV and tune to a channel.

To record one program and watch another:

1. Turn VCR2 off.
2. Press VCR1 and tune to a channel.
3. Begin recording.
4. Make sure the TV/VCR switch on the VCR1 is set to TV.
5. Press TV and tune to a channel.

To play a tape on the VCR:

1. Press VCR1.
2. Press PLAY.

You can record from one tape to another (tape dubbing):

1. Insert original tape into VCR2.
2. Insert blank tape into VCR1.
3. Press VCR1.
4. Set VCR to line input (for more, see your VCR User Manual).
5. Press RECORD to begin recording.
6. Press DVD•VCR2, then press PLAY.
7. If you want to watch a different channel, set both the TV/VCR switch on both VCRs to TV; press TV; then tune to a channel.

Note: The unauthorized recording of satellite broadcasts, television programs, or other copyrighted materials may infringe the rights of others.

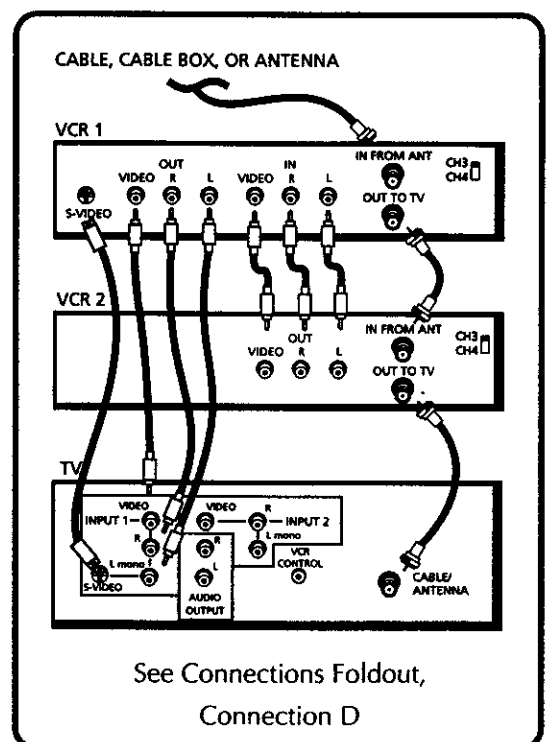

APPENDIX A: USING CONNECTION E

TV AND DVD PLAYER (CONNECTION E)

This information applies to Connection E in the Connections Foldout.

Connection E provides:

- stereo sound from broadcast programs
- Picture in Picture (PIP)

To use this connection you must have:

- (1) coaxial cable
- (3) audio/video cables
- (1) S-Video cable (optional)

To connect:

1. Connect cables as shown in Connection E.
2. Return to *First Things First*, then follow the steps in the Interactive Setup.

USING CONNECTION E

To watch TV programs:

1. Press TV and tune to a channel.

To play a disc:

1. Press DVD•VCR2.
2. Press PLAY.

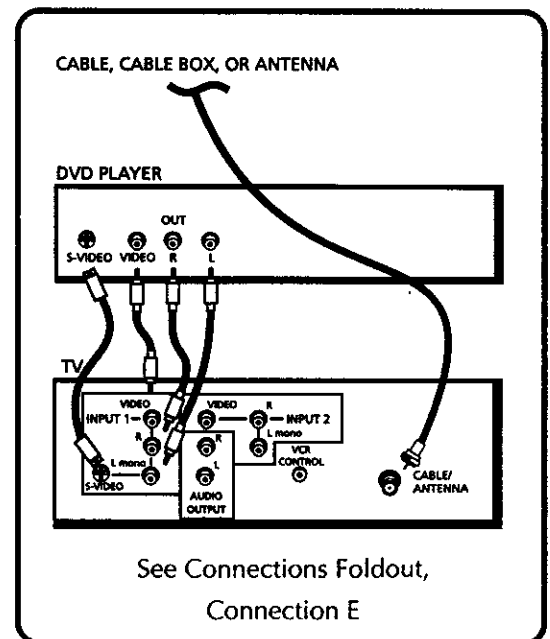

APPENDIX A: USING CONNECTION F

TV AND SATELLITE RECEIVER (CONNECTION F)

This information applies to Connection F in the Connections Foldout.

Connection F provides:

- stereo sound from broadcast programs
- stereo sound from the satellite receiver
- Picture in Picture (PIP)

To use this connection you must have:

- (3) coaxial cable
- (3) audio/video cables
- (1) S-Video cable (optional)
- stereo sound from satellite programming

To connect:

1. Connect cables as shown in Connection F.
2. Return to *First Things First*, then follow the steps in the Interactive Setup.

USING CONNECTION F

To watch TV programs:

1. Turn satellite receiver off.
2. Press TV and tune to a channel.

To watch satellite programming:

1. Press SAT•CABLE and tune to a channel.

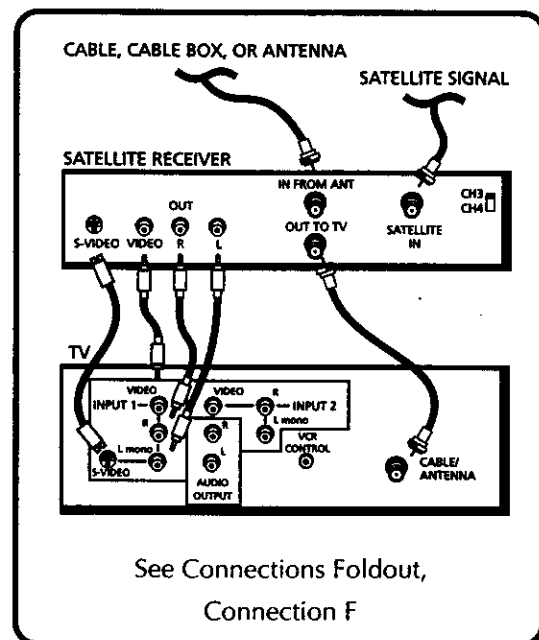

APPENDIX A: USING CONNECTION G

TV, VCR, AND SATELLITE RECEIVER (CONNECTION G)

This information applies to Connection G in the Connections Foldout.

Connection G provides:

- stereo sound from broadcast programs
- stereo sound from VCR
- Picture in Picture (PIP)
- watch one channel on TV while recording another channel

To use this connection you must have:

- (4) coaxial cable
- (6) audio/video cables
- (1) S-Video cable (optional)

To connect:

1. Connect cables as shown in Connection G.
2. Return to *First Things First*, then follow the steps in the Interactive Setup.

USING CONNECTION G

To watch TV programs:

1. Turn VCR and satellite receiver off.
2. Press TV and tune to a channel.

To watch Satellite programming:

1. Press SAT•CABLE and tune to a channel.

To record off-air broadcasts and watch a different channel:

1. Turn satellite receiver off.
2. Press VCR1 and tune to a channel.
3. Begin recording.
4. To watch another channel, make sure the TV/VCR switch on the VCR is set to TV; then press TV and tune to a channel.

To play a tape on the VCR:

1. Press VCR1 and then press PLAY.

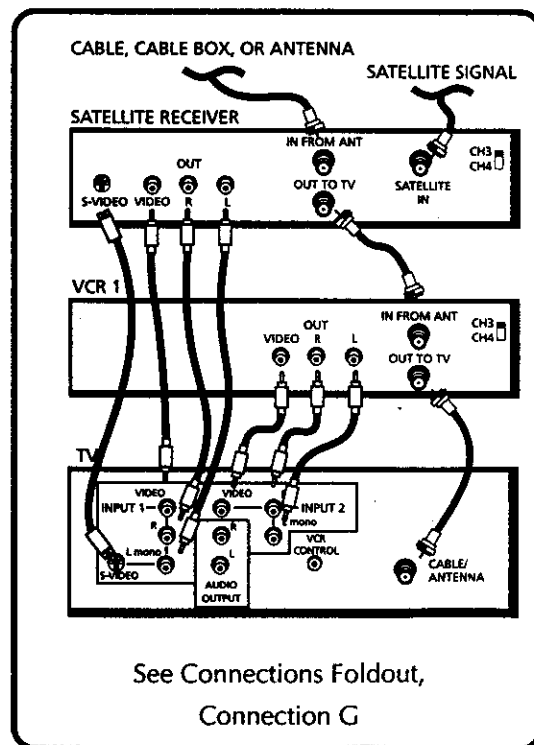

APPENDIX A: USING CONNECTION H

TV, VCR, SATELLITE RECEIVER, AND DVD PLAYER (CONNECTION H)

This information applies to Connection H in the Connections Foldout.

Connection H provides:

- stereo sound from broadcast programs
- stereo sound from VCR
- Picture in Picture (PIP)
- watch one channel on TV while recording another channel

To use this connection you must have:

- (4) coaxial cable
- (6) audio/video cables
- (1) S-Video cable (optional)

To connect:

1. Connect cables as shown in Connection H.
2. Return to *First Things First*, and do the Interactive Setup.

USING CONNECTION H

To watch TV programs:

1. Turn VCR and satellite receiver off.
2. Press TV and tune to a channel.

To watch satellite programming:

1. Press SAT•CABLE and tune to a channel.

To record off-air (cable or antenna) broadcasts and watch a different channel:

1. Turn satellite receiver off.
2. Press VCR1 and tune to a channel.
3. Press RECORD to begin recording.
4. To watch another channel, make sure the TV/VCR switch on the VCR is set to TV; then press TV and tune to a channel.

To play a tape on the VCR:

1. Press VCR1 and then press PLAY.

To play a disc:

1. Press DVD•VCR2 and then press PLAY.

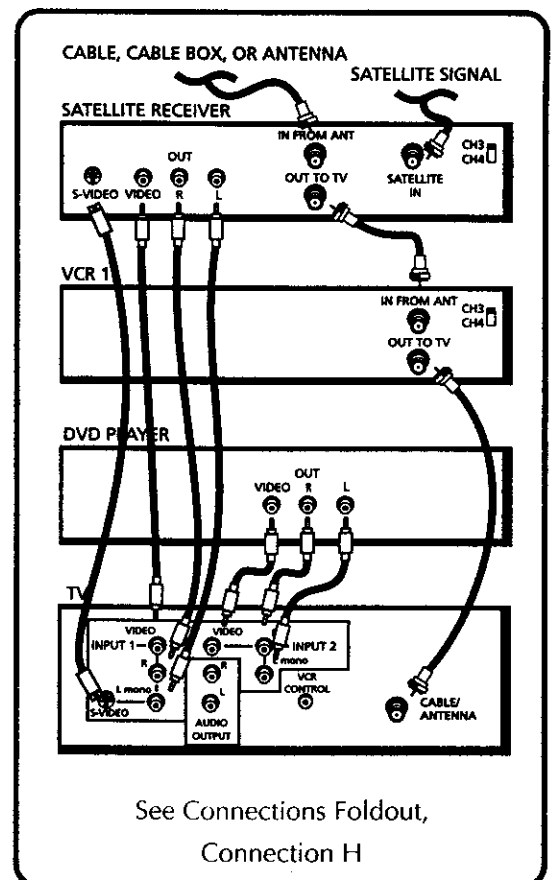

APPENDIX A: USING CONNECTION I

TV, (2) VCRs, AND SATELLITE RECEIVER (CONNECTION I)

This information applies to Connection I in the Connections Foldout.

Connection I provides:

- stereo sound from broadcast programs
- stereo sound from VCR
- Picture in Picture (PIP)
- watch one channel on TV while recording another channel

To use this connection you must have:

- (5) coaxial cable
- (9) audio/video cables
- (1) S-Video cable (optional)

To connect:

1. Connect cables as shown in Connection I.
2. Return to *First Things First*, then follow the steps in the Interactive Setup.

USING CONNECTION I

To watch TV programs:

1. Turn VCR and satellite receiver and laserdisc player off.
2. Press TV and tune to a channel.

To watch Satellite programming:

1. Press SAT•CABLE and tune to a channel.

To record from one VCR to the other (tape dubbing):

1. Turn satellite receiver off.
2. Insert original tape into VCR2.
3. Insert blank tape into VCR1.
4. Press VCR1.
5. Set VCR to line input (for more, see your VCR User Manual).
6. Press RECORD to begin recording.
7. Press DVD•VCR2, then press PLAY.
8. If you want to watch a different channel, set the TV/VCR switch on both VCRs to TV; press TV; then tune to a channel.

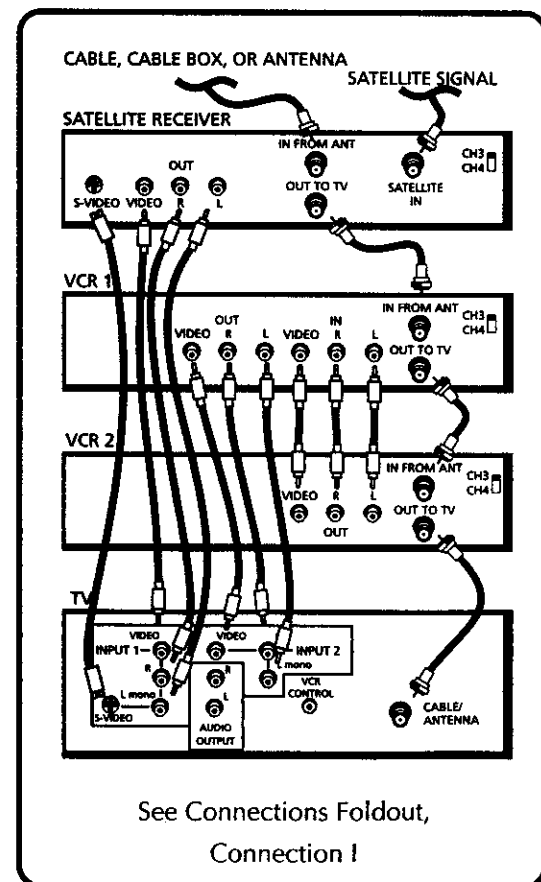

APPENDIX A: USING CONNECTION I

To record off-air (cable or antenna) broadcasts and watch a different channel:

1. Turn off VCR2.
2. Insert blank tape into VCR1.
3. Press VCR1 and tune to a channel.
4. Press RECORD to begin recording
5. To watch another channel, make sure the TV/VCR switch on the VCR is set to TV; then press TV and tune to a channel.

To play a tape on VCR1:

1. Press VCR1 and then press PLAY.

Note: The unauthorized recording of satellite broadcasts, television programs, or other copyrighted materials may infringe the rights of others.

APPENDIX B: OTHER COMPONENTS

CONNECTING AUDIO COMPONENTS

CONNECTING A STEREO AMPLIFIER

1. Connect the amplifier's TV audio inputs to the left (L) and right (R) AUDIO OUTPUT jacks.
2. You may prefer to turn off the TV's internal speakers by selecting *Audio Output and Speakers* from the Audio menu, then turning the speakers off.

If your audio amplifier is part of a system that uses its own remote control, you may prefer to select the fixed output settings.

Important: Do not use the amplifier's PHONO inputs. If the amplifier is not stereo, use the left (L) AUDIO OUT jack. Consult the amplifier's owner's manual for the manufacturer's recommended hookup.

CONNECTING A SUBWOOFER

To connect a subwoofer to the TV:

1. Connect the subwoofer's audio input to the left (L) AUDIO OUT jack.

CONNECTING A TAPE DECK

To use a tape deck to record audio from TV:

1. Connect the tape deck's audio inputs to the AUDIO OUTPUT jacks on the back of the TV.

APPENDIX B: OTHER COMPONENTS

CONNECTING A CAMCORDER FOR PLAYBACK

This connection is recommended for playing back from the camcorder to the TV:

1. Connect the camcorder's audio/video outputs to the INPUT 1 or INPUT 2 audio and video jacks on the TV.
2. Press INPUT on the remote until the channel marker displays VID1.
3. Start playback on the camcorder.

PLAYBACK FROM AN S-VHS CAMCORDER

To connect a camcorder with S-Video capability:

1. Connect an S-Video cable from the camcorder to the S-VIDEO jack on the TV.
2. Connect the camcorder's audio/video outputs to the INPUT 1 audio and video jacks on the TV.
3. Press INPUT on the remote until the channel marker displays VID1.
4. Start playback on the camcorder.

APPENDIX C: TROUBLESHOOTING

TROUBLESHOOTING

Troubles sometimes are caused by simple “faults” that you can correct without the help of a service technician. If you experience any difficulty with your TV, check a few basic remedies before calling your service technician.

TV will not turn on

- Check to make sure it is plugged in.
- Check the wall receptacle (or extension cord) to make sure it is “live” by plugging in something else.
- Maybe batteries in remote control are “dead.”
- Maybe remote control is not aimed at remote sensor.
- The front panel controls may be locked (disabled). Use the remote control to unlock the front panel controls by selecting the *Front Panel Lockout* in the Parental Controls menu and choosing *Unlock*.

Controls don't work

- If using remote control, make sure remote is in TV mode by first pressing TV button.
- Try unplugging set for two minutes and then plug it back in and turn it on again.
- The front panel MENU button may be disabled. Use the remote control to turn off channel blocking. Select *Channel Block* in the Parental Controls menu and choose *Off*.

Problems with Remote

- Maybe something is between the remote and the remote sensor.
- Maybe the remote is not aimed directly at the component (TV or VCR) you are trying to control.
- Maybe remote is not in TV Mode. Press the TV button so remote will control TV.
- Maybe batteries in remote are weak, dead or installed incorrectly. Try replacing batteries. (Note, if you remove the batteries, you may have to reprogram the remote to control other components.)
- Remove batteries and hold number 1 for at least 60 seconds to drain the microprocessor inside the remote. Release number 1, replace the batteries, and (if necessary) reprogram the remote.
- Remove all batteries for approximately 12 hours. Then replace batteries and (if necessary) reprogram the remote.

Turns off while playing

- Schedule function may have been activated.
- Electronic protection circuit may have been activated because of a power surge. Wait 30 seconds and then turn on again. If this happens frequently, the voltage in your house may be abnormally high or low.

TV Turns on unexpectedly

- Schedule On function may have been activated.

APPENDIX C: TROUBLESHOOTING

Blank screen

- Maybe the device connected to the input jacks is not turned on.
- Try another channel.
- Press RESET, in case the picture controls are set too low.

No sound, picture okay

- Maybe sound is muted. Try pressing volume up button to restore sound.
- Maybe TV's speakers are turned off. Check the Audio Output and Speakers control panel in the Audio menu.
- If using an S-VHS component, remember to also connect the component's L and R AUDIO OUT jacks to the TV's L and R INPUT 1 jacks.

Can't select certain channel

- Channel may be blocked or not approved in the Parental Controls menu.
- If using a VCR, check to make sure the TV/VCR switch on the VCR is in the correct position.

Noisy stereo reception

- May be a weak station. Use SOUND button to change to mono mode instead of stereo.

No picture, no sound but TV is on

- Maybe the cable/air function is set to the wrong position.
- Maybe a vacant channel is tuned.
- If watching VCR (connected only through antenna input), make sure TV is tuned to channel 3 or 4 – same as CH3/4 switch on VCR. Also check to make sure TV/VCR switch on VCR is in correct position.

Sound okay, picture poor

- Check antenna connections.
- Try adjusting sharpness function to improve weak signals.

Black Box appears on the screen:

- Captioning may be turned on. Check the Closed-Caption Display control panel in the Channel menu.

TV GUIDE Plus+ IR Controllers not working

- Check to make sure the controllers are positioned correctly over the IR remote sensors.
- Your remote may be interfering with the IR controller. Place a piece of dark tape over the IR controller.
- TV GUIDE Plus+ control of a cable box is slower than direct control of the box itself. Keep this in mind when changing channels.

APPENDIX D: LIMITED WARRANTY

What your warranty covers:

- Any defect in materials or workmanship.

For how long after your purchase:

- One year for labor charges.
- One year for parts.
- Two years for picture tube.

(The warranty period for rental units begins with the first rental or 45 days from date of shipment to the rental firm, whichever comes first.)

What we will do:

- Pay any Authorized ProScan Television Servicenter the labor charges to repair your television.
- Pay any Authorized ProScan Television Servicenter for the new or, at our option, refurbished replacement parts and picture tube required to repair your television.

How you get service:

- Request home service from any Authorized ProScan Television Servicenter. To identify your nearest Authorized ProScan Television Servicenter, ask your dealer, look in the Yellow Pages, or call 1-800-PROSCAN.
- Show the service technician your evidence of purchase date or first rental.

What your warranty *does not* cover:

- Customer instruction. (Your Owner's Manual clearly describes how to install, adjust, and operate your television. Any additional information should be obtained from your dealer.)
- Installation and related adjustments.
- Signal reception problems not caused by your television.
- Damage from misuse or neglect.
- Batteries.
- Images burnt onto the screen.
- A television that has been modified or incorporated into other products or is used for institutional or other commercial purposes.
- A television purchased or serviced outside the USA.
- Acts of God, such as but not limited to lightning damage.

Product Registration:

- Please complete and mail the Product Registration Card packed with your television. It will make it easier to contact you should it ever be necessary. The return of the card is not required for warranty coverage.

How state law relates to this warranty:

- This warranty gives you specific legal rights, and you may have other rights that vary from state to state.

If you purchased your product outside the USA:

- This warranty does not apply. Contact your dealer for warranty information.

APPENDIX E: CARE AND CLEANING

CARE AND CLEANING

You can clean the TV as required, using a soft lint-free cloth. Be sure to occasionally dust the ventilation slots in the cabinet to help assure adequate ventilation.

The TV's screen may be cleaned with a soft, lint-free cloth as well. Take care not to scratch or mar the screen. If necessary, you may use a cloth dampened with warm water.

Never use strong cleaning agents, such as ammonia-based cleaners, or abrasive powder. These types of cleaners will damage the TV.

While cleaning do not spray liquid directly on the screen, or allow liquid to run down the screen and inside the TV. Also, avoid placing drinks or vases with water on top of the TV. This could increase the risk of fire or shock hazard or damage to the TV.

Caution: If fixed (non-moving) images are left on the screen for long periods, they may be permanently imprinted on the screen. Such images include network logos, phone numbers, and video games. Extended viewing of channels displaying these images should be avoided.

ACCESSORIES

General Cable Information

Antenna (or cable-TV) connections are made with either coaxial antenna cable or twin-lead cable. Coaxial cables are shielded so they are less susceptible to hum or interference from adjacent cables.



Push-on Connector



Round 75-ohm coaxial cable

Screw-on Coaxial Connector



Flat 300-ohm twin-lead cable

Most audio/video connections between components can be made with shielded audio and video cables that have RCA-type phono connectors.



Standard Audio/Video cable with RCA-type phono plugs (such as No. VH83)

Color-Coded Jacks

The jacks on the TV's monitor panel are color-coded for ease of use. The VIDEO jacks are yellow, the right AUDIO jacks are red, and the left AUDIO JACKS are white. When connecting components to each other, be sure that you always connect left outputs to left inputs and right outputs to right inputs. If a component has only one output (mono), connect it to the R/MONO INPUT jack.

To connect S-VHS (Super-VHS) components, an S-VHS video cable is required.



S-Video cable (such as No. VH913)

Gold-Plated Jacks and Gold-Tipped Cables

Gold plating helps prevent oxidation of contacts which provides much less loss than conventional contacts. A complete line of gold-tipped cables is available to help you obtain optimum performance from your equipment.

The following accessories are available from most dealers and electronics supply stores in case you want to position your components farther apart or need additional cables.

Antenna Cables



VH81 (3-ft)
VH82 (6-ft)

Screw-on Cable attaches to the round antenna connectors (called 75-ohm F-type) on the back of your VCR or TV. The ends screw onto the connectors for a secure connection.



VH89 (6-ft)

Push-on Cable attaches to the round antenna connectors (called 75-ohm F-type) on the back of your VCR or TV. Ends push on for a quick connection.

Audio/Video Cables

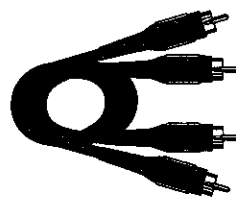

Gold-Tipped cable
VH83 (6-ft)

Monaural VCR Dubbing Cable

Double cable that lets you connect the VIDEO and AUDIO JACKS of two VHS VCRs to duplicate tapes. Can also be used to connect a VCR to your TV. Cable is color-coded and shielded. Has RCA-type phono plugs on each end.

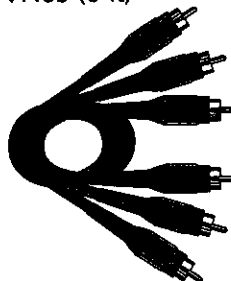

Gold-Tipped cable
AH84 (6-ft)

Stereo VCR Dubbing Cable

Triple cable that lets you connect the VIDEO and AUDIO jacks of stereo components.



VH976 (6-ft)
VH913 (12-ft)

S-Video Cable has multi-pin connectors on each end for connecting S-Video components to your TV.

ACCESSORIES

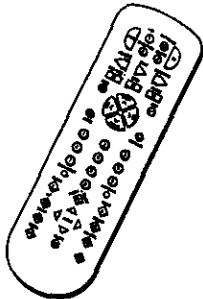

CRK83ML1
238145

Remote Control This is the remote control that came packed with your TV. Replacements or spares can be ordered as needed.

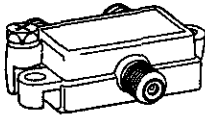

Splitter
VH47

2-way Signal Splitter helps you connect to a second TV or VCR.

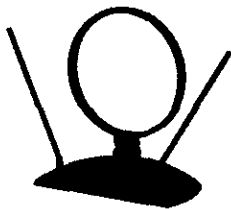

ANT200

Amplified VHF/UHF/FM Antenna allows you to easily switch from the antenna signal to cable or satellite easily without disconnecting antenna.

Accessory Order Form

Description	Part No.	Price	Qty
Screw-on antenna cable (3-ft)	VH81	\$4.95	
Screw-on antenna cable (6-ft)	VH82	\$6.95	
Push-on antenna cable (6-ft)	VH89	\$5.95	
Monoaural VCR Dubbing Cable (6-ft)	VH83	\$5.95	
Stereo VCR Dubbing Cable (6-ft)	VH84	\$9.95	
S-Video Cable (6-ft)	VH976	\$7.95	
S-Video Cable (12-ft)	VH913	\$8.95	
2-way Signal Splitter	VH47	\$3.95	
Amplified Antenna	ANT200	\$49.95	
Antenna Mixer	193984	\$10.95	
Remote Control (CRK83ML1)	238145	\$27.75	
Audio•Video Adapter	228449	\$4.35	

Prices are subject to change without notice.

Total Merchandise \$ _____

Sales Tax \$ _____

We are required by law to collect the appropriate sales tax for each individual state, country, and locality to which the merchandise is being sent.

Shipping and Handling \$ 5.00

Total Amount Enclosed \$ _____

Use VISA, MasterCard, or Discover Card preferably.

Money order or check must be in U.S. currency only.

No COD or CASH.



Detach Here

All accessories are subject to availability. Where applicable, we will ship a superseding model.



ACCESSORIES

Charge your order on your VISA, MasterCard, or Discover Card by filling in below

USE YOUR CREDIT CARD

IMPORTANT: Copy complete account number from your VISA card



My card expires:

IMPORTANT: Copy complete account number from your MasterCard



Copy Number above your name on MasterCard

My card expires:

IMPORTANT: Copy complete account number from your Discover Card



My card expires:

AUTHORIZED SIGNATURE

(Credit card order will not be processed without signature)

Prices are subject to change without notice.

Print or type your name and address clearly. This will be your mailing label.



A complete and correct order will save you days of waiting.

Name: _____
 Street: _____
 _____ Apt: _____
 City: _____
 State: _____ Zip: _____

Please make sure that both sides of this form have been filled out completely.

- Allow 4 weeks for delivery.
- All accessories are subject to availability.
- Prices are subject to change

United States and Canada Orders

To place your order by phone, have your Visa, MasterCard or Discover Card ready and call the toll-free number listed below between 8AM and 8PM (EST) Monday through Friday or between 9AM and 5PM (EST) Saturday.

Use this number only to place on order for accessory items listed on this order form.

1-800-338-0376

To place your order by mail, detach and mail the completed order form with credit card information, money order or check in US currency (made payable to Thomson Consumer Electronics, Inc.) to the following address:

**Video Accessories
 PO Box 8419
 Ronks, PA 17573**

INDEX

A

- Accessories 82
- Amplifier 76
- Antenna (ANT) 38
- Audio menu 44
- AUDIO OUTPUT 39
- Audio Output Volume & Speakers 44
- Audio Processor 44, 61
- Auto Channel Search 17, 47
- Auto Color 45
- Auto Tuning 25, 26, 48

B

- Back panel jacks 38
- Basic Picture Controls 45
- Batteries 5, 41
- Black Level 45
- Buttons
 - Front panel 40
 - Remote 36

C

- Cables 82
- Care and Cleaning 81
- CC 41
- CH CTRL button 58
- Chan # 47
- Chan Labels 47
- Channel Block 50
- Channel Directory 47, 60
- Channel Mapping 21, 54
- Channel Marker 41
- Channel menu 47
- Channels
 - DVD/VCR2 Channel 25, 48
 - SAT/CABLE Channel 26, 48
 - VCR1 Channel 48
- Closed Caption
 - Display 46, 62
 - Mode 46, 63
- Color 45
- Color Warmth 45
- Connections
 - Basic 4
 - Components 66
 - Foldout 4
 - Hints and tips 65
- Contrast 45
- Control Panels 11

E

- Enhanced SRS Stereo 44, 61
- Exit 60

F

- Fetch menu 60

- Fixed images 81
- Fixed output 39
- Fixed Output, Speakers Off 44
- Front panel buttons 40
- Front Panel Lockout 50, 60

I

- INFO button 64
- Inputs
 - Audio, video 38
 - INPUT 1,2 38

L

- L/MONO 38
- Labels 27, 47
- Language 16, 46

M

- Memory 47
- Menu Language 16, 46
- Menus 10
- Mono 44, 61
- MOVE buttons 58
- Mute 44

N

- Normal List 47

O

- On-screen Program Details 64
- One-Button Recording 57
- Outputs 39

P

- Parent Approved 50
- Parental Controls
 - Channel Block 50
 - Fetch menu 60
 - Front Panel Lockout 50
- Parental Controls menu 50
- Picture Control Presets 45
- Picture Quality menu 45
- PIP (Picture in Picture) 58
 - PIP Chan 41
- PIP button 58
- Point and Select 8
- Program details 64
- Programming the remote to control
 - components 30, 32, 33
- Projection TV, adjusting 46

R

- Remote Control
 - Programming 30
 - Remote batteries are low 41
 - using the 33
- RIGHT 38

S

- S-VIDEO 38
- SAP 41
- Schedule 49, 60
- Screen menu 46
- Second Audio Program (SAP) 44, 61
- Set
 - DVD/VCR2 Channel 25, 48
 - SAT/CABLE Channel 26, 48
 - VCR1 Channel 48
- Set Time 49
- Setup 16, 60
- Setup menu 51
- Sharpness 45
- Signal Type
 - Cable TV 47
 - UHF/VHF Antenna 47
- Sleep 41
- Sleep Timer 41, 49, 60
- SOUND button 61
- Sound Logic Stereo 44, 61
- SRS Stereo 44, 61
- Stereo 41, 44, 61
- Subwoofer 39, 76
- SWAP button 58

T

- Tape Deck 76
- Time
 - Current 41
 - Set Time 23
- Time menu 49
- Tint 45
- Tone Controls 44
- TV GUIDE Plus+ System 5, 14, 17–22, 51, 54–57
 - Channel Mapping 21, 54
 - IR Controllers 5
 - Next Menu 55
 - One-Button Recording 57
 - Scan Menu 55
 - Sort Menu 56
 - Surf Menu 54

V

- Variable output 39
- Variable Output, Speakers Off 44
- Variable Output, Speakers On 44
- VIDEO 38
- Video Noise Reduction 45



THOMSON CONSUMER ELECTRONICS

CREATING A GREENER FUTURE

At **Thomson Consumer Electronics** we are dedicated to the preservation of our natural heritage and to a healthy and safe way of life for current and future generations. This is a global effort which encompasses every THOMSON facility throughout the world.

We believe that clean air, clean water, a protected earth, and healthy people are not only practical and desirable goals, but achievable ones as well. Our Corporate Environmental, Health and Safety Charter acknowledges our commitment to protect these precious assets and provides a challenging vision and guideline for conducting our business.

Below are a few examples of **Thomson's** achievements in our efforts to preserve our natural resources.

THE EARTH

Thomson reclaims millions of pounds of hazardous waste annually, diverting it from landfills.

Thomson treats millions of pounds of waste water sludge annually and renders it non-hazardous.

Thomson recycles over 50 million pounds of non-hazardous material annually that otherwise would have been treated as trash, an overall recovery rate of 50%.

Thomson globally recycles millions of pounds of broken television picture tube glass annually through both internal and external reclaim processes.

THE AIR

Thomson has replaced solvent-based paints at many locations resulting in an 80% reduction in toxic air emissions for equivalent material used.

Thomson has eliminated the use of ozone-depleting substances at television manufacturing facilities around the world.

Thomson collects and returns over 1.5 million pounds of glass and furnace dust to the glass making process annually.

Thomson has launched worldwide energy savings programs which contribute to efforts to reduce air emissions from electrical generating facilities.

THE WATER

Thomson recovers over 2 million pounds of fine glass particles from process water each year and recycles them back into its glass furnaces.

Thomson's state-of-the-art waste water treatment plants filter out over 26 million pounds of solids from process water each year.

Thomson's U.S. glass factory recycles 2,500 gallons of water per minute and cleans 2.6 million gallons of water per day.

Thomson is researching new processes and is developing new manufacturing equipment and technologies to further reduce large volume water use.

Thomson has also increased its usage of recycled materials for packaging of our products. For example, in the U.S. and Mexico our television plants use recycled content in our television cartons and instruction booklets. The inks used for the print on cartons and instruction booklets are soy based. For a free brochure regarding **Thomson's** Environmental Health and Safety Programs, write to **Thomson Consumer Electronics'** address below, attention Environmental Programs: INH340.

Please do not send any products to the Indianapolis address listed in this manual or on the carton. This will only add delays in service for your product.

THOMSON CONSUMER ELECTRONICS
10330 North Meridian Street
Indianapolis, IN 46290

©1997 Thomson Consumer Electronics, Inc.
Trademark(s)® Registered
Marca(s) Registrada(s)
Printed in USA
TOCOM 15232180

The following materials were used in printing this publication:



50%
RECYCLED PAPER
MINIMUM 10% POST CONSUMER



not on list