

RCA SCENIUM



HDTV Monitor/DVD User's Guide

Important Information

WARNING

To reduce the risk of fire or electric shock, do not expose this product to rain or moisture. The apparatus shall not be exposed to dripping or splashing. No objects filled with liquids, such as vases, shall be placed on the apparatus.

CAUTION

THIS PRODUCT UTILIZES A LASER. USE OF CONTROLS OR ADJUSTMENTS OR PERFORMANCE OF PROCEDURES OTHER THAN THOSE SPECIFIED HEREIN MAY RESULT IN HAZARDOUS RADIATION EXPOSURE. DO NOT OPEN COVERS AND DO NOT REPAIR YOURSELF. REFER SERVICING TO QUALIFIED PERSONNEL.

Note:

This device is protected by U.S. patent numbers 4,631,603 and 4,577,216 and 4,819,098 and other intellectual property rights. The use of Macrovision's copy protection technology in the device must be authorized by Macrovision and is intended for home and other limited pay-per-view uses only, unless otherwise authorized in writing by Macrovision. Reverse engineering or disassembly is prohibited.

Note:

This DVD player is designed and manufactured to respond to the Region Management Information. If the Region number of a DVD disc does not correspond to the Region number of this DVD player, this DVD player cannot play the disc. The Region number for this DVD player is Region No 1.

**CLASS 1
LASER
PRODUCT**

CAUTION

RISK OF ELECTRIC SHOCK
DO NOT OPEN



This symbol indicates that this product incorporates double insulation between hazardous mains voltage and user accessible parts. When servicing use only identical replacement parts.

Caution: To reduce the risk of electric shock, do not remove cover (or back). No user serviceable parts inside. Refer servicing to qualified service personnel.



This symbol indicates "dangerous voltage" inside the product that presents a risk of electric shock or personal injury.



This symbol indicates important instructions accompanying the product.

Caution: To prevent electric shock, match wide blade of plug to wide slot, fully insert.

Refer to the identification/rating label located on the back panel of your product for its proper operating voltage.

FCC Regulations state that unauthorized changes or modifications to this equipment may void the user's authority to operate it.

Caution: Using video games or any external accessory with fixed images for extended periods of time can cause them to be permanently imprinted on the picture tube (or projection TV picture tubes). ALSO, some network/program logos, phone numbers, black borders (sides, top and bottom), etc. may cause similar damage. This damage is not covered by your warranty.

Cable TV Installer: This reminder is provided to call your attention to Article 820-40 of the National Electrical Code (Section 54 of the Canadian Electrical Code, Part 1) which provides guidelines for proper grounding and, in particular, specifies that the cable ground shall be connected to the grounding system of the building as close to the point of cable entry as practical.

Warning: Do not use the Freeze feature for an extended period of time. This can cause the image to be permanently imprinted on the picture tube. Such damage is not covered by your warranty. Press any button to unfreeze the picture at any time.

Product Registration

Please fill out the product registration card (packed separately) and return it immediately. For US customers: Your RCA Scenium Consumer Electronics product may also be registered at www.rcascenium.com/productregistration. Registering this product allows us to contact you if needed.

Product Information

Keep your sales receipt to obtain warranty parts and service and for proof of purchase. Attach it here and record the serial and model numbers in case you need them. These numbers are located on the product.

Model No. _____

Serial No. _____

Purchase Date: _____

Dealer/Address/Phone: _____

IMPORTANT SAFETY INSTRUCTIONS

1. Read these instructions.
2. Keep these instructions.
3. Heed all warnings.
4. Follow all instructions.
5. Do not use this apparatus near water.
6. Clean only with dry cloth.
7. Do not block any ventilation openings. Install in accordance with the manufacturer's instructions.
8. Do not install near any heat sources such as radiators, heat registers, stoves, or other apparatus (including amplifiers) that produce heat.
9. Do not defeat the safety purpose of the polarized or grounding-type plug. A polarized plug has two blades with one wider than the other. A grounding type plug has two blades and a third grounding prong. The wide blade or the third prong is provided for your safety. If the provided plug does not fit into your outlet, consult an electrician for replacement of the obsolete outlet.
10. Protect the power cord from being walked on or pinched particularly at plugs, convenience receptacles, and the point where they exit from the apparatus.
11. Only use attachments/accessories specified by the manufacturer.
12. Use only with the cart, stand, tripod, bracket, or table specified by the manufacturer, or sold with the apparatus. When a cart is used, use caution when moving the cart/apparatus combination to avoid injury from tip-over.
13. Unplug this apparatus during lightning storms or when unused for long periods of time.
14. Refer all servicing to qualified service personnel. Servicing is required when the apparatus has been damaged in any way, such as power-supply cord or plug is damaged, liquid has been spilled or objects have fallen into the apparatus, the apparatus has been exposed to rain or moisture, does not operate normally, or has been dropped.



If an outside antenna is connected to the TV receiver, be sure the antenna system is grounded so as to provide some protection against voltage surges and built up static charges. In the U.S. Section 810-21 of the National Electrical Code and in Canada, Part 1 of the Canadian Electrical Code provides information with respect to proper grounding of the antenna system. See the figure on the right for details.

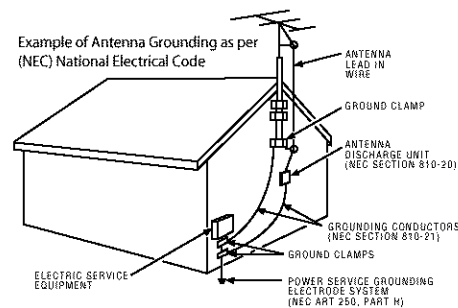

To assure adequate ventilation for this product, maintain a spacing of 4 inches from the top and sides of the TV receiver and 2 inches from the rear of the TV receiver and other surfaces.

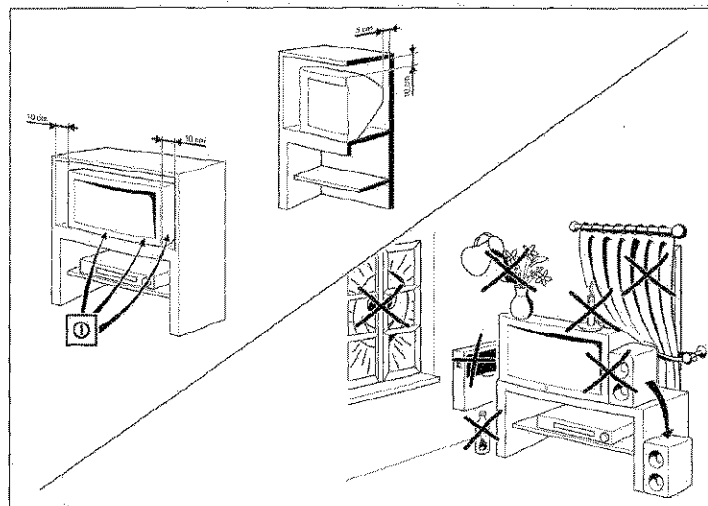

Introduction

Key Features Overview

Your TV/DVD is equipped with features that will add to your TV viewing experience. The following information summarizes a few of these features. Chapter 4 provides more information about the rest of the TV/DVD's features and how to use them.

Hi-Pix Picture Enhancement System

The Hi-Pix Picture Enhancement System incorporates two of RCA's most advanced technologies: TruScan Digital Reality and the AVR Picture Projection System. The result is the ultimate in true-to-life picture performance that provides the optimum picture resolution from each digital source connected to your TV/DVD (off-air, DVD, satellite, and/or cable).

TruScan Digital Reality

Picture performance starts with signal processing. TruScan Digital Reality intelligent signal processing recognizes incoming video signals and progressively converts them to achieve optimum digital picture performance. It enhances the picture quality and makes you feel as if you're close to the real thing. It also recognizes when original film sources have been modified and automatically converts the analog frame rate back to its original format to bring out the detail — a process commonly referred to as reverse 3:2 pulldown.

AVR Picture Projection System

The Accurate Visual Reality high definition picture projection system offers a brighter picture than conventional CRTs (cathode ray tubes). These tubes create brilliant, lifelike fidelity. The AVR 4 lens system is designed to complement the CRTs, providing accurate colors and razor sharp focus on every part of the screen.

DVI-HDTV Input

Lets you connect a component with a DVI (Digital Visual Interface) output. DVI provides an uncompressed, digital video interface developed for high-bandwidth digital connection. It supports the overlay of high-resolution graphics needed by some electronic program guide navigation and other interactive services. DVI, when combined with HDCP (High bandwidth Digital Content Protection) technology, creates a protected digital connection. The DVI-HDTV connection is designed to display either progressive scan (480p) or HDTV (1080i) signals at a bandwidth of up to 1.78 Gigabits per second.

SRS TruSurround XT™ and SRS Dialog Clarity™



TruSurround XT solves the problem of playing multichannel content over two speakers. It delivers a compelling, virtual surround sound experience through any internal television speakers. Dialog Clarity, a feature of TruSurround XT, makes dialog from the source material clearer.

MP3 Audio Disc Playback

Description: Your DVD player can play compatible MP3 audio files recorded on CD-R discs.

Requirements: The discs must be recorded on compatible equipment (Chapter 3 has details) and the DVD player must be on.

The On-Screen DVD Information Display

Description: The Info Display is an on-screen banner that provides access to certain features while you're playing a disc. Icons represent the different features supported by your TV/DVD when in DVD mode. By selecting different Info Display icons, you can access features including Repeat, Audio, Subtitles and Camera Angle.

Requirements: Put your TV/DVD in DVD mode and insert a disc into the disc tray. Once the disc starts playing, press INFO to view the Info Display.

TruSurround XT, Dialog Clarity, SRS and the (o) symbol are trademarks of SRS Labs, Inc.

TruSurround XT and Dialog Clarity technology is incorporated under license from SRS Labs, Inc.

Table of Contents

Important Information	2	Chapter 5: Using the DVD Menu	
Key Features Overview	2	The DVD's Menu System	37
Chapter 1: Connections & Setup		The Play/Resume Play Option	37
Things to Consider Before You Connect	4	The Play Mode Menu.....	37
Choose Your Connection	5	The Lock Menu	39
TV/DVD + HDTV Tuner + VCR.....	6	The Display Menu	41
TV/DVD + Satellite Receiver + VCR.....	8	The Sound Menu.....	41
TV/DVD + DVD + VCR	10	The Languages Menu	42
TV/DVD + A/V Receiver or Speakers.....	12	Chapter 6: Using the TV's Menu System	
The Front of Your TV/DVD.....	13	Sound Menu.....	43
Plug in the TV/DVD.....	14	Picture Menu	44
Put batteries in the remote	14	Channel Guide Menu.....	46
Turn on the TV/DVD.....	14	Time Menu.....	46
How to Use the Remote Control to Complete the Initial Setup.....	14	Parental Control Menu	46
Complete the Initial Setup	14	PIP Menu.....	46
		Setup Menu	47
Chapter 2: Using the Remote Control		Chapter 7: Information Displays	
The Buttons on the Remote Control.....	16	Using the Info Display	49
Programming the Remote	18	Using the Time Display	49
How to Use the Remote After You've Programmed It.	19	Selecting a Specific Track.....	49
The Learning Feature.....	20	Selecting a Specific Index.....	50
Volume Punchthrough.....	21	Selecting a Play Mode	50
Remote Control Codes.....	22	Using the Program Play Feature	50
		Editing a Playlist	51
Chapter 3: Playing DVDs		Using the Repeat Feature	51
Regional Coding.....	24	Changing the Audio Channel Output	52
Using Different Menus	24	Using IntroScan.....	52
Loading and Playing Discs.....	24	Chapter 8: Other Information	
Using a Disc Menu	25	Troubleshooting	53
Using the On-Screen Info Display	25	Explanation of Jacks	56
		FCC Information	58
Chapter 4: Using the TV's Features		Limited Warranty	59
Channel Banner.....	28	Accessory Information.....	60
Autotuning	28	Index	61
Parental Controls and V-Chip	30		
PIP (Picture-in-Picture) and POP (Picture-outside-Picture) Operation	36		

Connections & Setup

Things to Consider Before You Connect

Protect Against Power Surges

- Connect all components before you plug any of their power cords into the wall outlet.
- Turn off the TV/DVD and/or component before you connect or disconnect any cables.
- Make sure all antennas and cables are properly grounded. Refer to the Important Safety Instructions on page 1.

Protect Components from Overheating

- Don't block ventilation holes on any of the components. Arrange the components so that air can circulate freely.
- Don't stack components.
- If you place components in a stand, make sure you allow adequate ventilation.
- If you connect an audio receiver or amplifier, place it on the top shelf so the heated air from it won't flow around other components.

Position Cables Properly to Avoid Audio Interference

- Insert each cable firmly into the designated jack.
- If you place components above the TV/DVD, route all cables down the side of the back of the TV/DVD instead of straight down the middle of the TV/DVD.
- If your antenna uses 300-ohm twin lead cables, do not coil the cables. Also, keep the twin lead cables away from audio/video cables.

Important Stand and Base Safety Information

Choose the location for your TV/DVD carefully. Place the TV/DVD on a stand or base that is of adequate size and strength to prevent the TV/DVD from being accidentally tipped over, pushed off, or pulled off. This could cause personal injury and/or damage the TV/DVD. Refer to the Important Safety Instructions on page 1.

Use Indirect Light



Don't place the TV/DVD where sunlight or room lighting will be directed toward the screen. Use soft or indirect lighting.

Choose Your Connection

There are several ways to connect your TV/DVD. Please use the following chart to determine which connection is best for you. Proceed to the appropriate page and connect your TV/DVD.

Note for US customers: If you prefer, we can provide you with the name of an Authorized Service Representative who will visit your home for a fee to install your electronic entertainment system and to instruct you in its operation. For details about this service, call 1-888-206-3359.

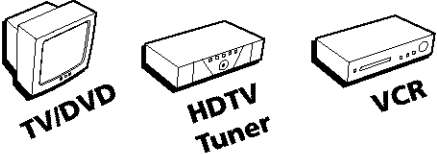
For additional assistance while using your RCA Scenium product, please visit www.rcascenium.com/customersupport.

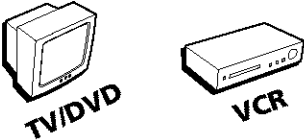
Components	Cables Needed	Connection Title	Go to...
 <p>TV/DVD HDTV Tuner VCR</p>	<p>Coaxial Audio/video Component video DVI-HDTV</p>	<p>TV/DVD + HDTV Tuner + VCR</p>	<p>page 6</p>
 <p>TV/DVD Satellite VCR</p>	<p>Coaxial Audio/video S-Video</p>	<p>TV/DVD + Satellite Receiver + VCR</p>	<p>page 8</p>
 <p>TV/DVD VCR</p>	<p>Coaxial Audio/video Component video</p>	<p>TV/DVD + VCR</p>	<p>page 10</p>

For general information on connecting an A/V receiver or speakers to your TV/DVD, go to page 12.

Cables Needed to Connect Components to Your TV/DVD

The pictures below show the cables needed for the connections represented in this book.

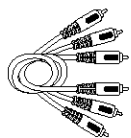

Audio/Video cables

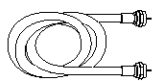

Coaxial cable

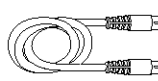

S-Video cable

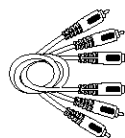

Component Video (Y•Pb•Pr) cables

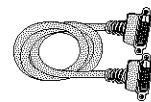

DVI-HDTV Cable

Connections & Setup

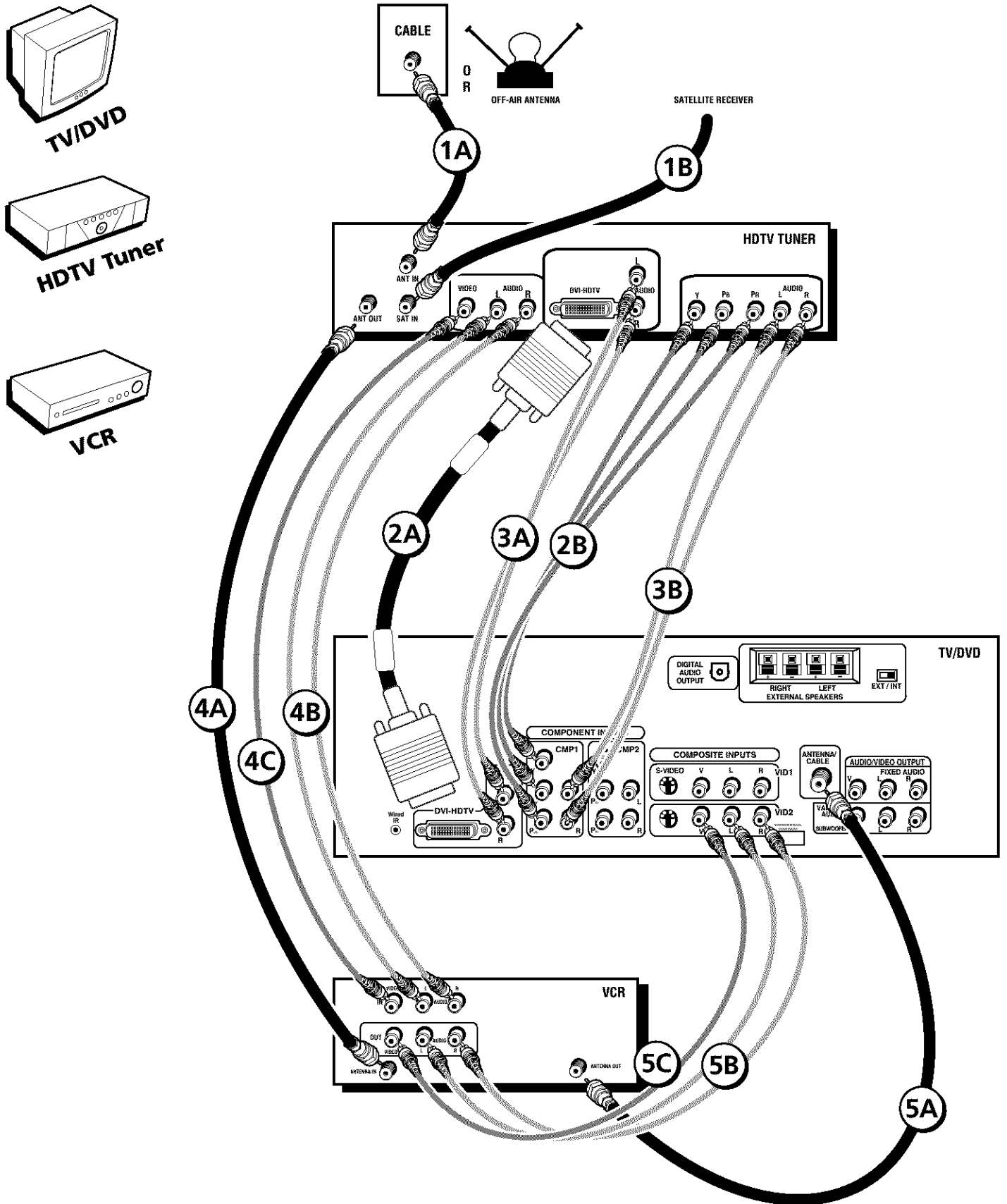

TV/DVD + HDTV Tuner + VCR

1. Make sure cable or antenna and/or satellite is connected to your VCR.

- A. Connect the coaxial cable from your cable outlet or antenna to the antenna input on the HDTV Tuner.
- B. Connect the satellite dish antenna to the satellite input on the HDTV Tuner.

2. Make the video connection between your HDTV Tuner and the TV/DVD.

A. Best Connection: DVI-HDTV

Connect a DVI-HDTV cable to the DVI-HDTV jack on the back of your HDTV Tuner. Connect the other end of the cable to the DVI-HDTV input on the back of TV/DVD.

– OR –

B. Very Good Connection: Connect three video grade cables to the CMP1 Y PB PR jacks on the back of the TV/DVD and to the Y PB PR jacks on the HDTV Tuner.

Notes: The DVI-HDTV and Y PB PR jacks send the digital cable signal to the TV/DVD in digital and analog formats, respectively.

3. Make the audio connection between your HDTV Tuner and the TV/DVD (to match your video connection).

A. If you used the DVI-HDTV jack:

Connect the audio (white and red) cables to the DVI-HDTV L and R audio jacks on the back of the TV/DVD and to the Audio Output jacks on the HDTV Tuner.

– OR –

B. If you used the Component Video jacks:

Connect the audio (white and red) cables to the CMP1 L and R audio jacks on the back of the TV/DVD and to the Audio Output jacks on the HDTV Tuner.

4. Connect your HDTV Tuner to your VCR.

- A. Connect a coaxial cable to the HDTV Tuner's antenna output and to VCR's antenna input.
- B. Connect the audio (white and red) cables to the Audio Output jacks on the HDTV Tuner and to the Audio Input jacks on the VCR.
- C. Connect the video cable to the Video Output jack on the HDTV Tuner and to the Video Input jack on the VCR.

5. Connect your VCR to your TV/DVD.

- A. Connect a coaxial cable to the VCR's antenna output and to the ANTENNA/CABLE Input jack on the TV/DVD.
- B. Connect the audio (white and red) cables to the VID2 L/MONO and R audio jacks on the back of the TV/DVD and to the Audio Output jacks on the VCR.
- C. Connect the video cable to the VID2 V (video) jack on the back of the TV/DVD and to the Video Output jack on the VCR.

Go to page 14

Connections & Setup

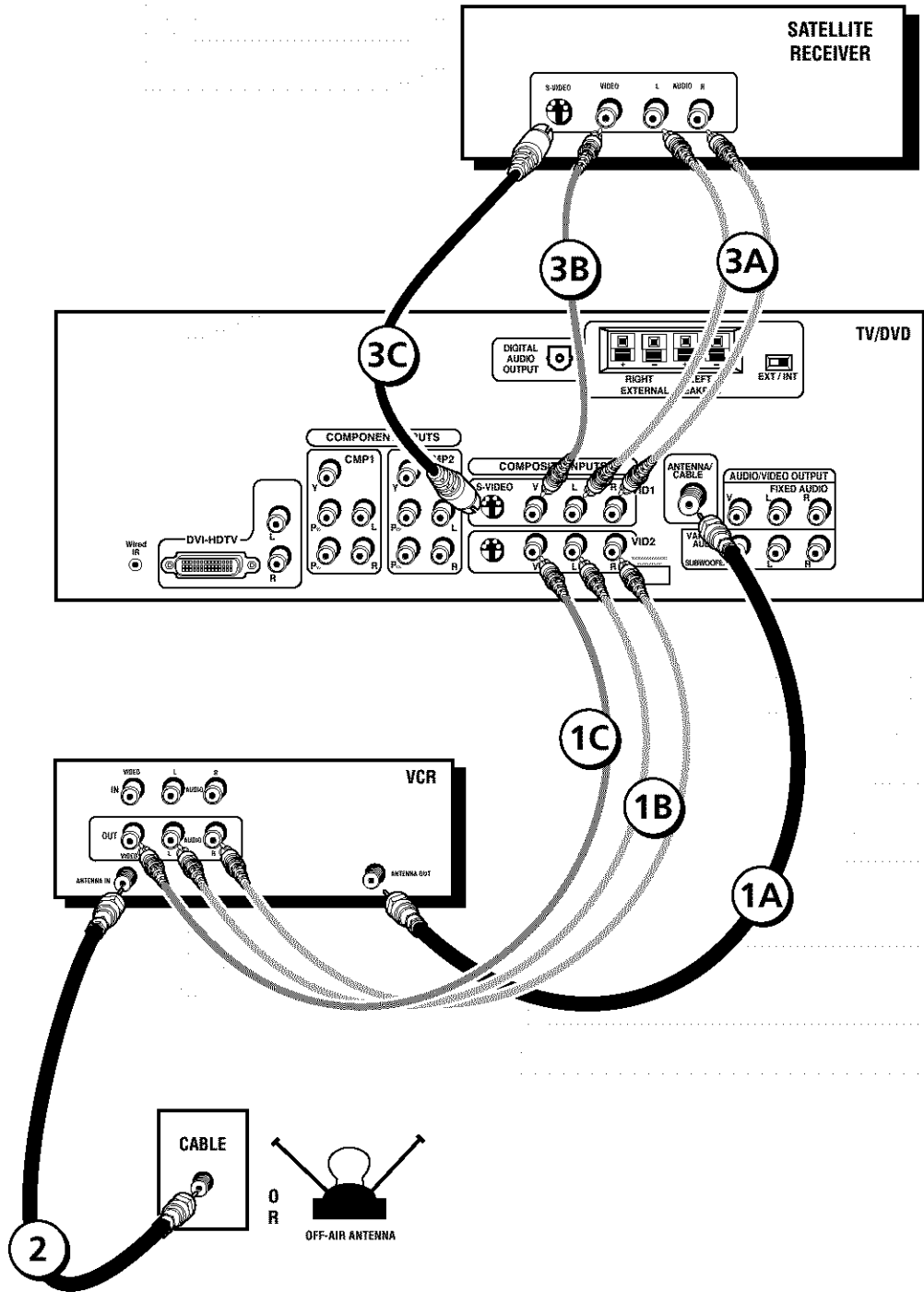
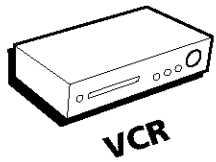
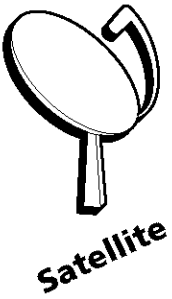
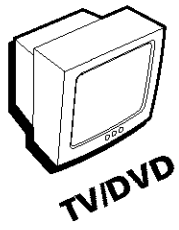

TV/DVD + Satellite Receiver + VCR

1. Connect your VCR to your TV/DVD.

- A. Connect a coaxial cable to the VCR's antenna output and to the ANTENNA/CABLE Input jack on the TV/DVD.
- B. Connect the audio (white and red) cables to the VID2 L/MONO and R Audio jacks on the back of the TV/DVD and to the Audio Output jacks on the VCR.
- C. Connect the video cable to the VID2 V (Video) jack on the back of the TV/DVD and to the Video Output jack on the VCR.

2. Make sure cable or antenna is connected to your VCR.

Connect the coaxial cable from your cable outlet or antenna to the antenna input on the VCR.

3. Connect your Satellite Receiver to your TV/DVD.

- A. Connect the audio (white and red) cables to the VID1 L/MONO and R Audio jacks on the back of the TV/DVD and to the Audio Output jacks on the Satellite Receiver.
- B. Connect the video cable to the VID1 V (Video) jack on the back of the TV/DVD and to the Video Output jack on the Satellite Receiver.
- C. If your Satellite Receiver has an S-Video jack, connect an S-Video cable (instead of the video cable in step B) to the S-VIDEO jack on the TV/DVD and to the S-VIDEO jack on the satellite receiver.

Go to page 14

Connections & Setup

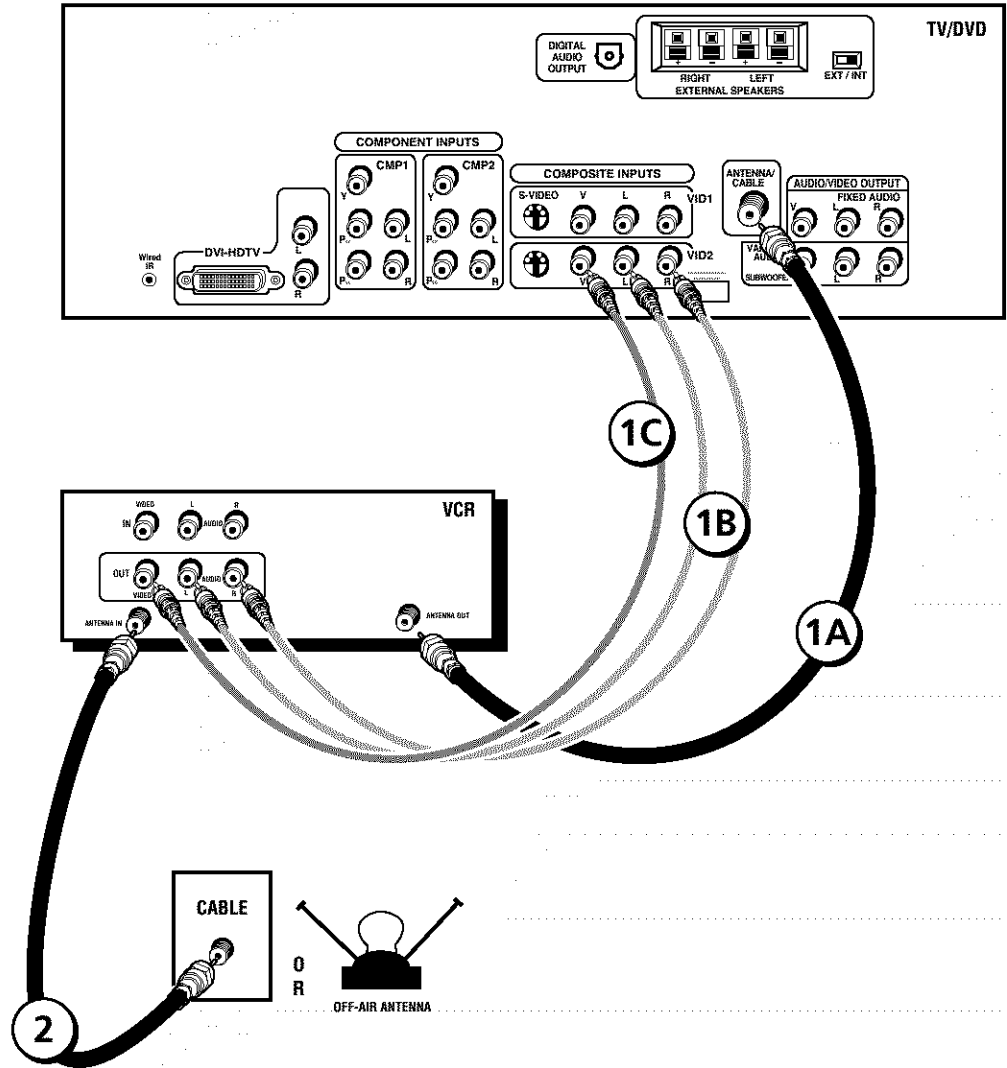
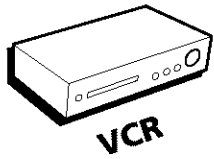
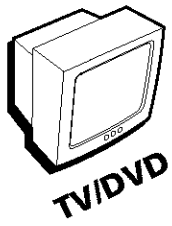

TV/DVD + DVD + VCR

1. Connect your VCR to your TV/DVD.

- A. Connect a coaxial cable to the VCR's antenna output and to the ANTENNA/CABLE Input jack on the TV/DVD.
- B. Connect the audio (white and red) cables to the VID2 L/MONO and R Audio jacks on the back of the TV/DVD and to the Audio Output jacks on the VCR.
- C. Connect the video cable to the VID2 V (Video) jack on the back of the TV/DVD and to the Video Output jack on the VCR.

2. Make sure cable or antenna is connected to your VCR.

Connect the coaxial cable from your cable outlet or antenna to the antenna input on the VCR.

Go to page 14

Connections & Setup

TV/DVD + A/V Receiver or Speakers

These are two different ways your TV/DVD uses a component to hear audio.

1. Connect audio cables to either the FIXED or VARIABLE AUDIO L and R OUTPUT jacks and to the Audio Inputs on the A/V receiver.

- FIXED provides fixed-level audio output from the TV/DVD. This audio output is ideal for connecting to an A/V receiver that has its own volume control.
- VARIABLE provides variable-level audio output. Volume levels can be controlled by the volume controls on the TV/DVD's front panel and remote control.

-OR-

2. Use speaker wire to connect the TV/DVD to external speakers.

- The EXT/INT switch beside the jacks let you turn the TV/DVD's internal speakers on or off. If you connect external speakers, slide the switch to EXT so the audio is sent to the external speakers only. Choosing INT sends the audio to the TV/DVD's speakers only.

Note: The external speaker rating is 8 ohms with 15 watts power handling capabilities.

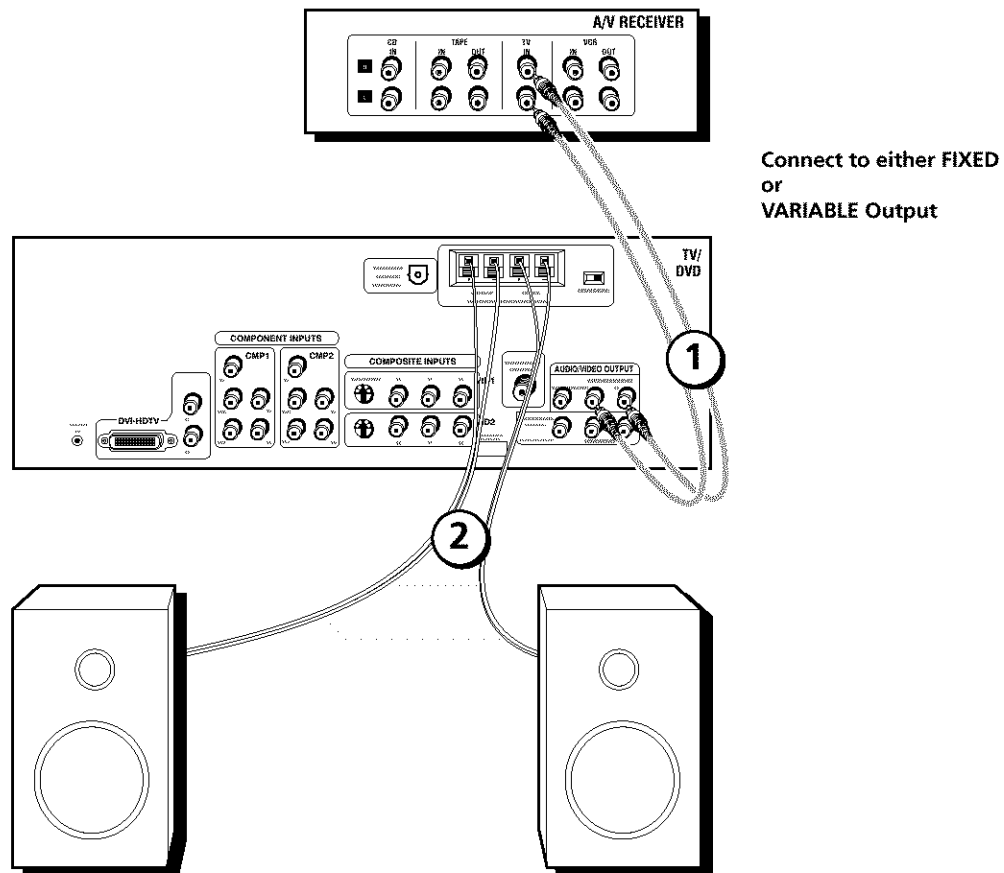

The Front of Your TV/DVD

Front Input Jacks

The TV/DVD has front inputs for convenience: one set of audio/video input jacks, an S-Video jack and a headphones jack. The jacks are ideal for using a video game console or a camcorder. Locate the jacks either on the front of the TV/DVD or on one of the sides. To access the component you connected to the front of the TV/DVD, press the INPUT button on your remote until *FRNT* appears on the screen.

Note: When connecting a component that uses a monaural cable, such as some camcorders, use the Left (mono) input jack to get sound from both speakers.

PHONES Allows you to connect headphones to listen to the sound coming from the TV/DVD. To adjust volume control of the headphones, press the VOL > or VOL < button (the volume display appears). Press the arrow up or down button (the headphone volume display appears), then press the right or left arrow button to adjust the headphone volume.

VIDEO (in) Receives video from another component such as a camcorder, video game console or VCR.

L/MONO and R AUDIO Receives audio from another component such as a camcorder, video game console or VCR.

S-VIDEO (in) Allows you to connect an S-Video cable from another component. Make sure you also connect audio cables from the component to the TV/DVD.

Note: Do not connect an S-Video and a regular video cable to the FRNT jacks at the same time.

Front Panel Buttons

If you cannot locate your remote, you can use the front panel buttons of your TV/DVD to operate many of the TV/DVD's features.

OPEN/CLOSE Press to open and close the disc tray.

STOP Stops DVD disc play.

PLAY Begins DVD disc play.

MENU/OK Brings up the TV Main menu. In the menu system, it selects highlighted items.

CH v Scans down through the current channel list. In the TV menu system, acts like down arrow button on the remote control and adjusts menu controls.

CH ^ Scans up through the channel list. In the TV menu system, acts like up arrow button on the remote control and adjusts menu controls.

VOL < Decreases the volume. In the TV menu system, acts like left arrow button on the remote control and adjusts menu controls.

VOL > Increases the volume. In the TV menu system, acts like right arrow button on the remote control and adjusts menu controls.

POWER Turns the TV/DVD on and off.

Connections & Setup

Plug in the TV/DVD

Plug the end of the power cord into a grounded wall outlet. Insert the plug completely into the outlet.

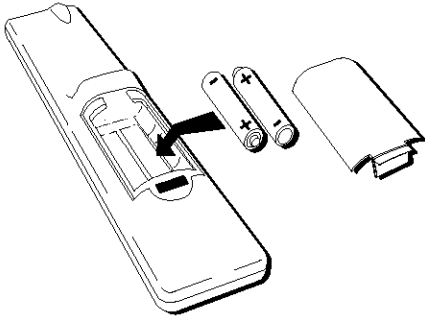

Put batteries in the remote

- Remove the battery compartment cover from the back of the remote by pushing the tab and lifting off the cover.
- Insert 2 “AA” fresh batteries. Make sure the polarities (+ and -) are aligned correctly.
- Replace the cover.

Turn on the TV/DVD

Press TV on the remote, or press POWER on the TV/DVD’s front panel.

Note: Pressing the TV button not only turns on the TV/DVD, but puts the remote into TV mode. “TV mode” means that the buttons on the remote control operate the TV’s functions.

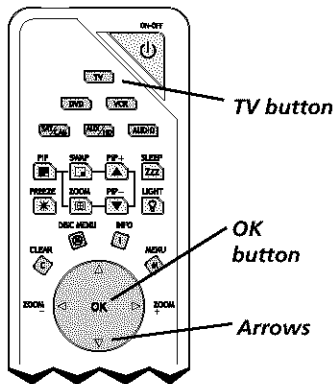

How to Use the Remote Control to Complete the Initial Setup

The technical term is “Navigation” – how you move through the on-screen menus. The theory is the same throughout the menu screens: highlight your choice and select it.

To highlight a menu item, press the arrow buttons on the remote to highlight one of the items listed on the screen. Use the up or down arrow button to move up or down. Use the right or left arrow button to move right or left.

To select the item that you’ve highlighted, press OK.

Note: Highlighted means that the menu item stands out from other menu items on the list (appears darker, brighter, or a different color).

Tip

To access the setup menus manually, press **MENU** and choose **SETUP**.

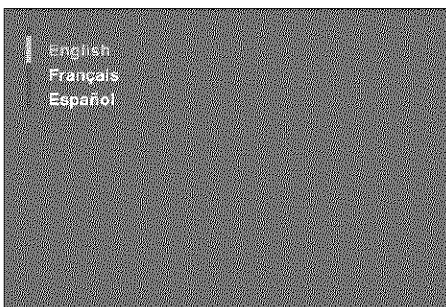

Complete the Initial Setup

The menu system in your TV/DVD allows the TV/DVD’s features to work properly. The first time you turn on your TV/DVD, the setup screens appear.

Set the Menu Language

The first part of the setup allows you to select your preferred language for the menu system.

If English is your preferred language, press OK. If you want to choose another language, press the down arrow button until that language is highlighted, and press OK.

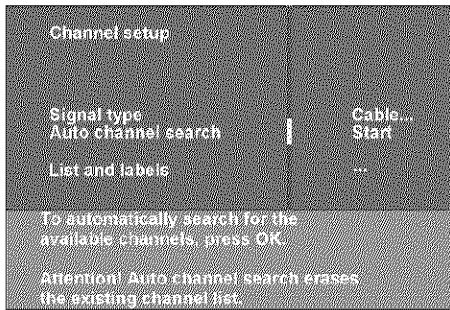

Complete Auto Channel Search

The next screen asks you to make sure you've connected the TV/DVD to a cable, satellite, or off-air signal. When you're sure that a signal is connected to your TV/DVD, press OK on your remote to go to the *Channel setup* screen.

In the *Channel setup* screen, you can launch the Auto channel search by pressing OK. The Auto channel search allows the TV/DVD to search for all channels viewable through your antenna or cable TV system. This is sometimes called *auto programming*. When the channel search is complete, press OK to access the *List & Labels* screen.

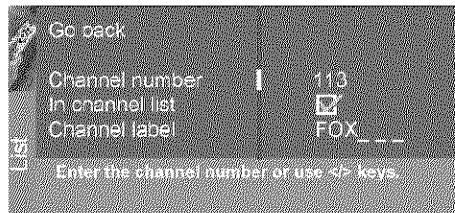

Changing Lists and Labels

The List & Labels part of the setup lets you edit your channel list and choose or create a personal six-character label for each channel.

Note: *Changing List and Labels can be time consuming. You can change these at a later time by accessing the Setup menu.*

1. Press the left or right arrow to scroll through the channels and choose the one you want to edit.
2. Press the down arrow to highlight the *In channel list* option. Press the left or right arrow button to add (the box is checked) or remove (the box is unchecked) the channel from the list.
3. Press the down arrow to highlight the *Channel label* option. Press the left or right arrow button to scroll through the available list of 25 most common labels. The last option in the list allows you to create your own six-character label for the channel (the first letter of the label is highlighted).
4. Press the 1 or 2 number button to change the first letter of the label.
5. Press the right arrow to highlight the second letter, then press the 1 or 2 number button to change the second letter, etc.
6. When you are finished creating your label, press OK. Select *Go back* to go to the *Auto Convergence* menu.

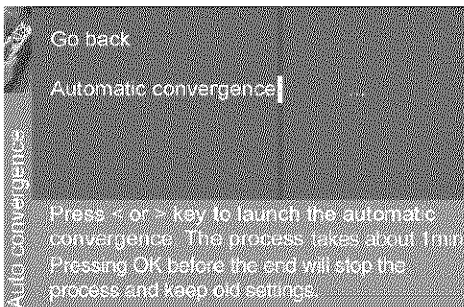

Auto Convergence

Your TV/DVD's picture tubes might have been disturbed during delivery or after you moved the TV/DVD, causing the color in your TV/DVD to be out of alignment. The colors adjust by starting auto convergence.

IMPORTANT: *Auto convergence works best once the TV/DVD has warmed up for at least an hour. If you've just unpacked your TV/DVD, it's a good idea to repeat the Auto convergence function when the TV/DVD's been running for at least an hour. See page 48 for more information about Auto convergence.*

1. Press OK to begin auto convergence.
2. When the auto convergence is complete, the *Red center convergence* menu appears. The cross in the middle of the screen should be yellow. If it is not, use the arrow buttons to move the red cross to overlap the green cross. Press OK when adjustments are complete.
3. The *Blue center convergence* menu appears with a cyan cross in the middle of the screen. If it is not, use the arrow buttons to move the blue cross to overlap the green cross. Press OK (the TV tunes to the last selected/available channel in the channel list).

Note:

If you're using an HD source (such as an HDTV tuner or HDTV satellite receiver) on the CMPNT or DVI input, you should run Auto convergence separately for that input as well. Tune to the input you're using for the HD source, then go to page 48 for information on Auto convergence.

You don't need to run Auto convergence separately for the internal DVD player – the procedure for the TV covers the internal DVD player as well.

Using the Remote Control

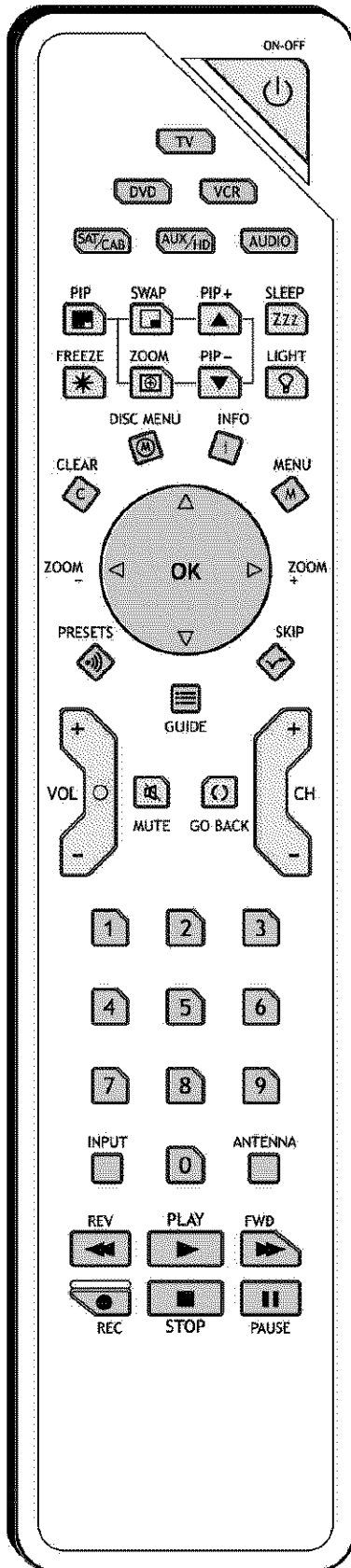

The Buttons on the Remote Control

(0-9) Number Buttons Enter channel numbers and time settings directly through the remote control.

To enter a one-digit channel, enter a zero first. To enter a two-digit channel, press the two digits. To enter a three-digit channel, press and hold the "1" button until "1" and two dashes (—) appear, then add the second two digits. Example: to tune to channel 123, press and hold 1 until "1—" appears, release the 1 button and then press 2 and 3.

ANTENNA In VCR mode (if programmed), this button works as a TV/VCR button for some VCRs. In SAT mode (if programmed), this button works as a TV/SAT button for some satellite receivers.

Arrows Used to highlight different items in the TV or DVD menu and to adjust the menu controls. The up and down arrows move the PIP window when no menus are on the screen. When watching TV without the PIP window or menu system in use, the left and right arrows (**ZOOM-** and **ZOOM+**) change the current format of the screen (4:3, Zoom 14:9, Zoom 16:9, Zoom 16:9 ^/v, Cinerama, regular mode 16:9). In DVD mode while playing a 4:3 disc, use the Zoom buttons in the reduced TV menu to change the Zoom mode.

AUDIO Places the remote in audio mode to operate a component (such as a CD player, audio receiver, amplifier/receiver) that you've programmed to work with this button.

AUX/HD Puts the remote in AUX/HD mode. As a default, this button controls some models of RCA HDTV Tuners. It can also be programmed to operate some brands of an additional remote-controllable components. The Autotuning feature for this button works *only* with HDTV tuners (see page 28 for more information on Autotuning).

CH + or CH - Scans up or down through the current channel list. Press once to change the channel up or down; press and hold to continue changing channels. In DVD mode while a disc is playing, CH+ advances to the next chapter; CH- goes to the preceding chapter.

CLEAR Removes any menu or display from the screen and returns you to normal viewing. Also exits PIP or POP if no menu is displayed.

DISC MENU In DVD mode while a disc is playing, brings up the current disc's menu (if available).

DVD Turns on the internal DVD player and puts the remote in DVD mode. Also displays the current DVD status.

FREEZE When watching TV, freezes the picture until you press any button on the remote to resume normal TV viewing. The FREEZE feature automatically times out after a short time. Please note that when you "unfreeze" you go back to live programming (skipping any programming that occurred during the freeze).

Note: The FREEZE feature does not work on signals from the DVI-HDTV, CMP1 or CMP2 inputs in progressive scan (480p) or HDTV (1080i) modes.

Do not use the Freeze feature for an extended period of time. This can cause the image to be permanently imprinted on the picture tube. Such damage is not covered by your warranty. Press any button to unfreeze the picture at any time.

GO BACK In TV mode, returns you to the previous channel. In DVD mode, returns to the previous screen.

GUIDE In TV mode, brings up the *Channel Guide* menu. In DVD mode, brings up the DVD guide (if available).

Using the Remote Control

Tip

The component button corresponding to the mode you're in flickers when the remote batteries are low and you press a button on the remote.

A warning message may also appear on the screen when you press a remote button and the batteries are low.

Tip

To turn off most RCA, GE, and Proscan components that are connected to the TV, press ON•OFF twice within two seconds.

This feature only works with most RCA, GE, and Proscan products.

Note:

The DVD, VCR, SAT/CAB, AUX/HD, and AUDIO buttons also turn on most RCA, GE, and Proscan products.

INFO In TV mode, makes the channel banner appear and disappear. In DVD mode, makes the info banner appear and disappear.

INPUT Accesses the available video input channels (VID1, VID2, FRNT, CMP1, CMP2 and DVI). Press the CH+ or CH- button to resume TV viewing.

LIGHT Press to illuminate the remote control's buttons (except for the component buttons). To conserve battery power, the light turns off after several seconds. Backlight won't activate if batteries are low, but blinks on and off quickly.

MENU In TV mode, makes the TV Main menu appear and disappear. In DVD mode, makes the reduced TV menu appear and disappear.

MUTE Reduces the TV's volume to its minimum level. Press again to restore the volume.

OK When in the menu system, selects highlighted items. When watching TV, freezes the picture until you press any button on the remote to resume normal TV viewing. Please note that when you "unfreeze" you go back to live programming (skipping any programming that occurred during the freeze).

ON•OFF When in TV mode, turns the TV on and off. If in another component mode (VCR, DVD, SAT/CAB, AUX/HD or AUDIO) and programmed, turns the component on and off.

PIP Press once to bring up the small picture-in-picture (PIP) window. Press again to bring up the picture-outside-picture (POP) windows. Press to remove POP. (See Chapter 4 for more information about using PIP.)

PIP + or PIP – When using PIP or POP, changes the channel in the PIP window.

PRESETS In TV mode, displays the Picture and Sound preset settings. Use the up and down arrow buttons to highlight either Picture or Sound settings. Use the left and right arrow buttons to change to a different Picture or Sound preset. In DVD mode while a disc is playing, displays the DVD Info Display with the Audio icon highlighted.

REC If programmed, starts recording TV programs if your TV/DVD is connected to a recording device (such as a VCR) if the remote is in the right mode to control that device.

REV, PLAY, FWD, STOP, PAUSE In DVD mode, these buttons provide reverse, play, fast forward, stop and pause the disc. If programmed, they also provide transport control for some remote-controllable VCRs, DVD players, tape decks, and CD players.

SAT/CAB Puts the remote in SAT/CAB mode and, if Autotuning is enabled, turns on the TV and tunes to the correct input channel.

SKIP In TV mode, press once before changing channels and the TV will wait 30 seconds before returning you to the original channel. Press repeatedly to add more time.

SLEEP Brings up the *Sleep timer* menu. Use the right and left arrow buttons on the remote control to increase or decrease the sleep timer in five minutes increments (up to a maximum of four hours).

SWAP When using PIP, swaps the main picture with the PIP window. When using POP, swaps the left and right pictures.

TV Turns on the TV and puts the remote in TV mode. Also displays the channel banner.

VCR Puts the remote in VCR mode and, if Autotuning is enabled, turns on the TV and tunes to the correct input channel.

VOL – or VOL + Decreases or increases the TV's volume.

ZOOM In PIP mode, changes the size of the PIP window.

Using the Remote Control

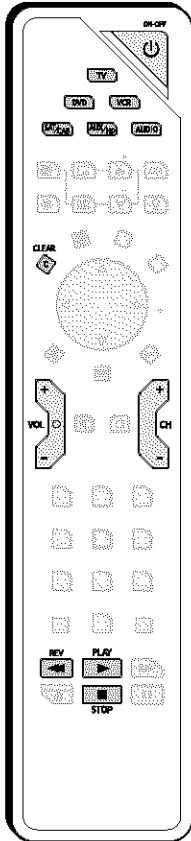

You'll use these buttons when you program the remote.

Important: The remote may not be compatible with all models of all brands of components. It also may not operate all functions of the remote that came with your component.

Important note for direct entry

You must continue pressing the component button while you enter the code.

Let's say you have a Zenith VCR. To program the universal remote to operate the VCR, you would:

Press and hold the VCR button while you enter the first code listed for Zenith in the VCR Codes column.

Release the VCR button. Press ON•OFF to see if the VCR responds. If it doesn't, follow the same steps, but enter the second code for Zenith VCRs instead of the first.

Programming the Remote to Operate Other Components

The universal remote can be programmed to operate most brands of remote-controllable components. The remote is already programmed to operate most RCA, GE, and Proscan components.

Also, the AUX/HD button can be programmed to operate most brands of an additional remote-controllable component (such as a VCR, DVD player, CD player, satellite receiver, cable box or audio receiver).

Note: The TV button can't be programmed on this remote.

IMPORTANT: Don't program the DVD button on this remote to control a different (external) DVD player unless you don't plan to use this remote with your internal DVD player. If you program the DVD button to control an external DVD player, then the remote won't control the internal DVD player.

Find Out If You Need to Program the Remote

To determine whether the universal remote needs to be programmed to operate one of the components connected to your TV, such as a VCR, do the following:

1. Turn on the component (in this example, a VCR).
2. Point the remote at the component.
3. Press the corresponding component button (in this example, the VCR button).
4. Press ON•OFF to see if the VCR responds. If the VCR doesn't respond, you need to program the remote to operate it.

Programming the Remote

There are two ways to program the remote control:

- direct entry
- automatic code search

Using Direct Entry

1. Turn on the component you want to operate (VCR, satellite receiver, etc.)
 2. Look up the brand and code number(s) for the component on the code list in this section.
 3. Press and hold the component button you want to program on the remote.
 4. Enter the 4-digit code from the remote control code list starting on page 22. If the component button flashes, you have either entered an invalid code or the button isn't programmable.
 5. Release the component button, point remote at component, and then press ON•OFF to see if the component responds to the command. If it doesn't, try pressing the component button and then ON•OFF again.
- If you get no response, repeat these steps using the next code listed for your brand, until the component responds to the remote commands.
 - If you try all the codes for your component brand and none work, try the automatic code search method. If automatic code search doesn't find the code, the remote is not compatible with your component.

Using the Remote Control

Tip

To stop the automatic code search without programming any components, press and hold CLEAR until the light in the component button turns off.

Using Automatic Code Search

If Direct Entry does not work for your component, try Auto Code Search. The following instructions can be used to program the remote to operate each of your components. If you want to stop the automatic code search without programming any of your components, press and hold CLEAR until the light in the component button turns off.

1. Turn on the component you want to operate (VCR, satellite receiver, etc.)
2. Press and hold the component button you want to program (VCR, DVD, etc.). While holding the component button, press and hold ON•OFF until the component button on the remote turns on, then release both buttons.
3. Point the remote at the component.
4. Press and release PLAY, then wait 5 seconds or until the component button stops flashing.

At this point the remote is searching for the correct code to program. If, after 5 seconds, the component you want to operate does not turn off, press PLAY again to tell the remote to search the next set of codes.

Continue pressing and releasing PLAY until the component turns off or you have searched through all of the codes. The component buttons flash when all codes have been searched, the component button turns off, and remote exits Automatic Code Search.

If the component you want to control *does* turn off:

1. Press and release REV, then wait 2 seconds. Repeat this step until the component turns back on.
2. To finish, press and hold STOP until the component button on the remote turns off.

How to Use the Remote After You've Programmed It

Because this universal remote can control several different components (TV, VCR, satellite receiver, etc.) it uses operational modes triggered by the component buttons. For example, if you want the remote to operate the TV, you would press the TV button to put the remote into TV mode before you could control the TV.

1. Press the appropriate component button (DVD, TV, VCR, SAT/CAB, AUX/HD, AUDIO) to set the remote to control the component.
2. Press ON•OFF to turn the component ON or OFF.
3. Use the remote buttons that apply to that component. The component button on your remote lights up when you press valid buttons while in that component's mode.

Notes:

- The remote may not be compatible with all brands and models of components. It also may not operate all functions of the remote that came with your component.
- If you keep pressing buttons and nothing happens, the remote is probably in the wrong mode. You must press the component button that matches the component you want to operate (i.e., if you want to operate the VCR, press VCR on the remote control to put the remote in VCR mode.)

Component Buttons

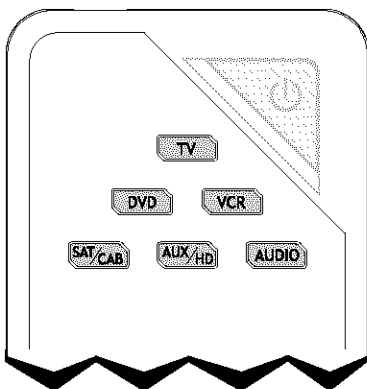

Note

Some of the remote's buttons might operate differently for other components, especially when you're using another component's menu system.

Using the Remote Control

The Learning Feature

Before using the learning feature, make sure this TV's remote control is programmed to control other components you have connected to the TV. Programming the remote control erases all learned commands for that component mode.

After you program the TV's remote control to operate the other component, the TV's remote provides most of the operations you need. However, there may be some functions on the component's original remote control that your TV's remote control doesn't have. For example, your DVD remote control might have a ZOOM button that enables you to enlarge the picture, but your TV/DVD remote doesn't have that button. The learning feature enables you to record the functionality of a specific button from the original remote control to one of the TV's remote control buttons.

Note: All learned functions for a mode can be erased if you program a different component to that mode.

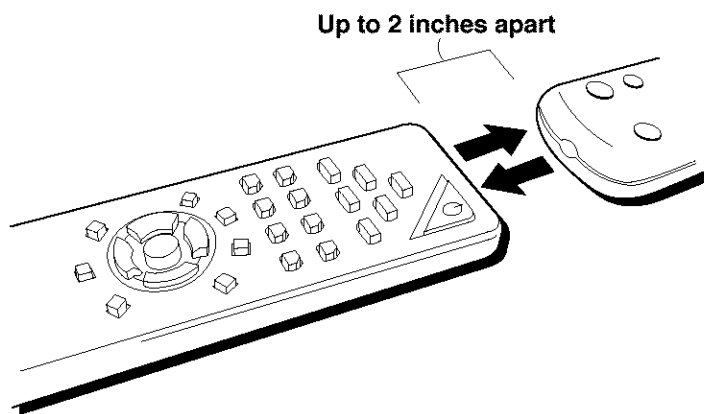

Adding a Learned Function

There are several things to consider before you begin the learning process:

- You can't record a learned function to the following buttons on the TV's remote control: component buttons (TV, VCR, DVD, AUX/HD, and AUDIO), the CLEAR button, and the LIGHT button.
- Before adding a Learned Function, you must program this TV's remote control to operate that component because programming the remote control erases all learned commands for that component mode.
- Do the learning process in low light areas because too much natural light or fluorescent light might cause the learning feature to fail because the remote control functions are recorded (learned) by sending infrared (IR) signals.
- The TV's remote and the original remote should be no more than 2 inches apart.
- In order to record (learn) a function from one remote to the other, you must make sure the Infrared (IR) transmitter of the original remote is facing the IR receiver on the top of the TV's remote (see illustration). To accomplish this, you may have to hold a remote in each hand instead of laying both on the table.
- The learned buttons are mode specific—if you add a button function from your DVD player's remote control, you must press the DVD button first before the learned function will work (in TV mode, the button where you've stored the learned function will continue to work as it always has).
 1. Press and hold the component button on the TV's remote that applies to the function you will be adding (DVD, VCR, SAT/CAB, AUDIO, or AUX/HD). The component button lights.
 2. On the TV/DVD remote, press and hold the RECORD button.
 3. Keep pressing both of the buttons (the component button and the RECORD button) until the component button light turns off, flashes, and turns off. Release both buttons.
 4. On the TV's remote control, press and release the button where you want to store the new function (the component button turns off and then back on).

Note: If you press an invalid button on the TV/DVD remote, one of the component button flashes 4 times to alert you. You'll have to repeat step 4.

Using the Remote Control

5. With the remote controls facing each other and no more than 2 inches apart, press and hold the button of the component's remote control that has the functionality you are recording to the TV's remote control. Keep pressing the button until the TV/DVD remote's component button light turns off and back on (the function has been saved to the TV/DVD remote). If all component buttons flash four times, then the function wasn't learned. You can try again starting with step 4.
6. The TV/DVD remote control remains in "learning mode" so you can continue adding functions to different buttons by repeating steps 4 and 5. Or, press CLEAR to exit learning mode.

Notes: If you want a new function on a button, you must record (learn) over it.

The amount of memory each learned function uses in the TV's remote control varies. If your TV/DVD remote is out of memory, the component button(s) light flashes 4 times and turn off, exiting you from the Learning mode.

Clearing a Learned Function

To delete a learned button function, use the procedure below.

1. Press and hold the component button (the component button lights). Then press and hold the CLEAR button for 3 seconds. Continue depressing both buttons (the component mode button flashes—turns on and off again).
2. Release the component and CLEAR buttons (the component button being programmed turns on). Remote is now in Clear learned function mode.
3. Press and release the button where learning is to be cleared. The component button blinks off then back on—the learned function was cleared successfully.
4. Repeat steps 1 through 3 until all buttons' learned functions have been cleared.

Note: If an invalid button is pressed, the component mode button(s) flashes 4 times and the selected component button stays on and remote remains in Clear Learned Function mode. Repeat step 3.

5. Press the CLEAR button and your TV/DVD remote returns to its original operation mode.

Deleting ALL Learned Functions

This procedure erases all learned functions in every component mode of the remote.

1. Press and hold the CLEAR button (the current component button lights). Then press and hold the ON•OFF button (component button light turns off for 3 seconds, flashes, turns on and off) while continuing to hold CLEAR.
2. Release both buttons (current component button turns on).
3. Press any component button to delete all learned functions in all modes. Remote is automatically exited from this mode.

Note: Pressing the CLEAR button will NOT delete all learned functions, but will exit the Delete mode.

Volume Punchthrough

You may find this feature helpful if you've connected your components to an audio/video receiver (A/V receiver) or amplifier, but you want to use the TV's remote control to operate the volume for a component that is connected to the audio/video receiver. An example follows.

Let's say you've connected your DVD player to your audio/video receiver. You've also programmed your TV/DVD remote control to operate your DVD player. Since the DVD player gets its volume through the audio/video receiver, you would have to bounce back and forth between two remote controls: the a/v receiver's remote to adjust the volume and the TV's remote control to operate the DVD player.

The Volume Punchthrough Feature eliminates the need for you to use two remote controls and saves a button press when you're using the TV/DVD remote to adjust the volume. In effect, you are telling the TV/DVD remote to retrieve and send volume commands from the A/V receiver whenever the TV/DVD remote is operating the DVD player (in DVD mode).

Continues on next page...

Using the Remote Control

Therefore, after you've successfully set up the Volume Punchthrough Feature, whenever the TV/DVD remote is in DVD mode (press the DVD button) and you want to adjust the volume, you only have to press the VOL + or VOL- buttons. Follow the instructions below to set up Volume Punchthrough.

IMPORTANT: First, you must program the **AUDIO** button on the TV's remote control to operate your audio receiver or amplifier. Go to page 18 for instructions. If you can't program this remote to operate your audio receiver, Volume Punchthrough won't work.

While setting up Volume Punchthrough, it's best to point the remote away from components.

1. Decide which mode the remote will be in when the volume from the audio receiver "punches through." The mode will be one of the component buttons (TV, DVD, SAT/CAB, VCR, or AUX/HD).
2. Press and hold the VOL- button. Keep pressing VOL- while you press and release the component button you chose in step 1 (TV, DVD, SAT/CAB, VCR or AUX/HD).
3. Then press and release the AUDIO button since the sound will be coming from the audio/video receiver. Release the VOL- button.
4. Now, test it by turning on your audio receiver or amplifier.
5. Turn on the component that is connected to the audio/video receiver or amplifier (a DVD player, for example).
6. Put the TV's remote in DVD mode by pressing the DVD button, and play a disc.
7. Press VOL+ or VOL-. The volume from the audio receiver should increase or decrease accordingly.

Deleting All Punchthrough Commands

To delete all programmed Volume Punchthrough settings and return the remote control back to the factory defaults (TV for all modes except AUDIO), press and hold the VOL- button (LED of the Volume Punchthrough component lights). While holding the VOL- button, enter the code 000, using the number buttons. All component LEDs turn on for 2 seconds and then turn off. The remote returns to the factory settings.

Note: If an invalid button is pressed, all component LEDs blink 4 times and turn off. At this point, you must start over.

Using the INPUT Button

Use the INPUT button to scroll through the available input channels and view components you have connected to the TV.

1. Press TV to place the remote in TV mode. Make sure the component you want to view is turned on.
2. Press INPUT until you reach the correct input channel.
3. To return to the channel you were previously watching on TV, press CH+ or CH- button.

Remote Control Codes

Audio Codes			
Programmable for the AUDIO and AUX/HD buttons.			
AUX/Dimensia/Lyra Wireless			
RCA	4004	Kenwood	4044, 4067, 4068
Audio Cassette			
GE	4006	Luxman	4069
RCA	4006	Marantz	4046
CD Players			
ADC	4055, 4056, 4066	MCS	4070
Aiwa	4049, 4057	Mitsubishi	4071, 4072
Akai	4058	NEC	4045
Denon	4060	Onkyo	4047
Emerson	4040	Panasonic	4188
Fisher	4041, 4063, 4064	Pioneer	4049
GE	4007, 4065	RCA	4007, 4050, 4062
Hitachi	4042	Sears	4059
JVC	4043	Sony	4051, 4061
		Technics	4052
		Toshiba	4073
		Yamaha	4053, 4054
		Phono	
		GE	4005
		RCA	4005
		Receiver/Tuner/AMP	
		Aiwa	4008, 4009, 4010, 4011, 4012, 4021
		Denon	4027
		GE	4003
		Harman Kardon	4020
		JBL	4020
		JVC	4013
		Kenwood	4014
		Onkyo	4022
		Optimus	4028
		Panasonic	4023, 4024
		RCA	4003, 4015, 4029, 4030
		Sherwood	4026
		Sony	4016, 4017, 4025
		Technics	4023, 4024
		Yamaha	4018, 4019
		HDTV Tuner Codes	
		Programmable for the AUX/HD button.	
		RCA	7000

Using the Remote Control

Cable Box Codes

Programmable for SAT/CAB and AUX/HD buttons.

ABC	5002, 5003, 5004, 5006, 5045
Archer	5008, 5009
Cableview	5007
Contec	5015
Eastern	5016
GE	5002, 5003
Gemini	5017, 5018
General Instruments	5003
Hamlin	5019, 5020, 5021, 5026, 5033
Hitachi	5003
Jerrold	5003, 5017, 5022, 5023, 5039, 5045
Magnavox	5024
Memorex	5026
Movie Time	5025
NEC	5005
NSC	5025
Oak	5015, 5027
Panasonic	5041, 5044
Philips	5011, 5012, 5013, 5014, 5018, 5024, 5028, 5029, 5030
Pioneer	5031, 5032
Proscan	5002, 5003
RCA	5007, 5040, 5042, 5044
Realistic	5009
Samsung	5032
Scientific Atlanta	5006, 5034, 5035, 5036
Signature	5003
Sprucer	5044
Standard Component	5037, 5038
Starcom	5017, 5045
Stargate	5017
Tocom	5004, 5022
United Cable	5045
Universal	5008, 5009, 5010
View Star	5015, 5024, 5025
Zenith	5043

DVD codes

Programmable for DVD and AUX/HD buttons.

DVD	
Aiwa	3010, 3021
Apex	3023, 3024
Broksonic	3027, 3075
Daewoo	3028
Denon	3029, 3030, 3031
Emerson	3032, 3033, 3076
Funai	3033
GE	3000, 3034, 3035
Go Video	3077
Hitachi	3009, 3067, 3068, 3069, 3070
JVC	3003, 3011, 3078
Kenwood	3071
Konka	3012, 3013
Koss	3085
Lasonic	3087
Magnavox	3004, 3036
Memorex	3037
Mintek	3038
Mitsubishi	3005
NAD	3032
Norcent	3039, 3040
Onkyo	3041
Oritron	3047
Panasonic	3014, 3042
Philips	3004, 3020
Pioneer	3006, 3043, 3044, 3045
Proscan	3000, 3046
Qwestar	3047
RCA	3000, 3002, 3048, 3079, 3086
Samsung	3072, 3073, 3074, 3080, 3081
Sansui	3049
Sanyo	3015, 3082
Sharp	3050, 3052, 3053
Sony	3007, 3016, 3017, 3054, 3055, 3056, 3083
Sylvania	3033
Teac	3057
Technics	3058
Toshiba	3008, 3018, 3059, 3060, 3061
Yamaha	3062, 3063, 3064
Zenith	3019, 3065, 3084

Portable DVD

Aiwa	3022
Audiovox	3025, 3026
Panasonic	3030
RCA	3066
Sharp	3051

DVD/VCR Combo Codes

DVD and AUX/HD buttons can use DVD codes;
VCR and AUX/HD buttons can use VCR codes

	DVD	VCR
Broksonic	3075	2075
Emerson	3076	2076
Go Video	3077	2077
JVC	3078	2078
RCA	3079	2079
Samsung	3080, 3081	2080, 2081
Sanyo	3082	2082
Sony	3083	2083
Zenith	3084	2084

PVR Codes

Programmable for the VCR and AUX/HD buttons.

PVR	
Replay	2086
Philips Tivo	2085

Home Theatre in a Box (DVD Receiver) Codes

AUDIO and AUX/HD buttons can use Audio codes;
DVD and AUX/HD buttons can use DVD codes

	Audio	DVD
JBL	4031	3088
JVC	4032	3089
Koss	4033	3090
Onkyo	4034	3091
Panasonic	4035	3092
Pioneer	4036	3093
RCA	4037	3094
Venturer	4038	3095

Satellite Receiver Codes

Programmable for SAT/CAB and AUX/HD buttons.

Alphastar	5064
Chapparral	5046, 5047
Dishnet	5063
Drake	5048, 5049
Echostar	5070
GE	5000, 5001, 5072
General Instruments	5050, 5051, 5052
Hitachi	5066, 5067
Hughes	5062, 5071
JVC	5065
Panasonic	5060
Philips	5068
Primestar	5061
Proscan	5000, 5001, 5072
RCA	5000, 5001, 5072
Realistic	5053
Sony	5058
STS1	5054
STS3	5055
STS4	5056
Toshiba	5057, 5059
Uniden	5069

VCR Codes

Programmable for VCR and AUX/HD buttons.

Admiral	2068
Aiko	2023
Aiwa	2022
Akai	2002, 2003, 2004, 2057, 2058, 2059
Audiovox	2010
Bell & Howell	2007
Broksonic	2008, 2021, 2075
Calix	2010
Canon	2017, 2018
Capchart	2016, 2056
Carver	2037
CCE	2023, 2036
Citizen	2009, 2010, 2011, 2012, 2013, 2014, 2015, 2023
Colortyme	2005
Craig	2009, 2010, 2019, 2036
Curtis-Mathes	2005, 2009, 2012
	2014, 2017, 2018, 2020, 2060, 2072

Daewoo	2011, 2013, 2015, 2021, 2022, 2023, 2056
Daytron	2056
Dimensia	2072
Electrohome	2010, 2024
Emerson	2002, 2008, 2010, 2011, 2017, 2020, 2021, 2022, 2024, 2025, 2026, 2027, 2028, 2039, 2059, 2061, 2067, 2069, 2076
Fisher	2007, 2019, 2029, 2030
Fuji	2003, 2017, 2062
Funai	2022
Garrard	2022
GE	2000, 2001, 2009, 2017, 2018, 2060, 2063, 2072
Gradiente	2022
Harman Kardon	2005
Harwood	2036
Hitachi	2033, 2034, 2035, 2053, 2057, 2063
JC Penney	2005, 2006, 2007, 2008, 2009, 2010, 2017, 2018, 2030, 2033, 2034, 2036, 2037, 2053
Jensen	2033, 2034, 2057
JVC	2005, 2006, 2007, 2014, 2057, 2064, 2078
Kenwood	2005, 2006, 2007, 2012, 2014, 2057, 2064
KLH	2036
Kodak	2010, 2017
LG	2010
Logik	2036
LXI	2010
Magnavox	2017, 2018, 2037, 2038, 2052, 2054, 2065
Marantz	2005, 2006, 2007, 2012, 2014, 2017, 2037
Matsushita	2017
Memorex	2007, 2009, 2010, 2017, 2019, 2022, 2052, 2068
MGA	2024, 2039, 2059
Minolta	2033, 2034, 2053
Mitsubishi	2024, 2033, 2034, 2039, 2040, 2041, 2059, 2064
Montgomery Ward	2068
Motorola	2017, 2068
MTC	2009
Multitech	2009, 2012, 2022, 2031, 2036
NEC	2005, 2006, 2007, 2012, 2014, 2057, 2064
Nikko	2010
Noblex	2009
Olympus	2017
Optimus	2010, 2068
Optonica	2047
Panasonic	2017, 2018, 2055, 2066
Pentax	2012, 2033, 2034, 2053, 2063
Pentax Research	2014
Philco	2017, 2018, 2037, 2038
Philips	2017, 2037, 2047, 2065
Pioneer	2006, 2033, 2042, 2064
Portland	2012, 2013, 2015, 2056
Proscan	2000, 2001, 2072
Quasar	2017, 2018, 2066
RCA	2000, 2001, 2002, 2009, 2017, 2033, 2034, 2043, 2044, 2045, 2053, 2060, 2063, 2066, 2070, 2072, 2073, 2079
Radio Shack	2010, 2047, 2068
Radioshack/Realistic	2007, 2009, 2010, 2017, 2018, 2019, 2022, 2024, 2029, 2047
Realistic	2007, 2009, 2010, 2011, 2017, 2018, 2019, 2022, 2024, 2029, 2047, 2068
Radix	2010
Ricoh	2071
Runco	2052
Samsung	2004, 2009, 2011, 2027, 2031, 2058, 2080, 2081
Sansui	2006, 2046, 2057, 2064
Sanyo	2007, 2009, 2019, 2082
Scott	2008, 2011, 2021, 2026, 2028, 2039, 2061
Sears	2007, 2010, 2017, 2019, 2029, 2030, 2033, 2034, 2053
Sharp	2013, 2024, 2047, 2048, 2068
Shintom	2003, 2034, 2036, 2049
Signature	2068
Singer	2017, 2036, 2071
Sony	2003, 2049, 2050, 2062, 2083
STS	2017, 2053
Sylvania	2017, 2018, 2022, 2037, 2038, 2039, 2065
Symphonic	2022
Tandy	2007
Tashiko	2010
Tatung	2057
TEAC	2022, 2057
Technics	2017, 2055
Teknika	2010, 2017, 2022, 2051
Toshiba	2011, 2029, 2030, 2033, 2039, 2059
Totevision	2009, 2010
Unitech	2009
Vector Research	2005, 2006, 2011, 2012
Video Concepts	2005, 2006, 2011, 2012, 2059
Wards	2009, 2010, 2011, 2017, 2019, 2022, 2024, 2033, 2034, 2036, 2047, 2053, 2061, 2068, 2070
XR-1000	2017, 2022, 2036
Yamaha	2005, 2006, 2007, 2014, 2057
Zenith	2003, 2049, 2052, 2062, 2071, 2084

Playing DVDs

Regional Coding

Both the TV/DVD unit and the discs are coded by region. These regional codes must match in order for the disc to play. If the codes don't match, the disc won't play. This unit's code is region 1.

Using Different Menus

Each disc is programmed with different features. There are three separate menu paths that you can use to access features:

- **The Disc menu** – The disc menu is part of each disc and is separate from the DVD's menu system. The contents of each disc menu vary according to how the disc was authored and what features are included. The disc menu is turned on and off (while the disc is playing) with the DISC MENU button on the remote.
- **The DVD's Info Display** – The Info Display appears as icons across the top of the screen when a disc is playing. It can only be accessed while you are playing a disc. It's turned on and off with the INFO button on the remote.
- **The DVD's menu system** – The DVD player's menu system is accessed only when a disc isn't playing. It appears when the STOP button is pressed.

A feature only works if the disc was programmed with that feature. If a menu item is "grayed out", that item isn't available.

In addition to the DVD menus, the TV/DVD offers an abbreviated TV Main Menu while you're using the DVD player. To access the picture, sound and image controls for the TV while using the internal DVD player, press the TV button on your remote.

Loading and Playing Discs

Your TV/DVD unit plays DVD discs, Video CD discs, Audio CD discs, MP3 discs and CD-R discs. Before you load a disc, make sure that it is compatible with the player. The following discs CANNOT be used with this player:

- Laserdiscs, CD-I, CD-ROM (computer-only discs), CD-RW, DVD-ROM, Discs recorded using other broadcast standards (i.e. PAL or SECAM)

To Load and Play a Disc

To put the TV/DVD in DVD mode and play a disc, press the DVD button on the remote control.

1. Press the OPEN/CLOSE button on the front of the TV/DVD. The disc tray opens.
2. Place a disc gently into the tray with the disc's label facing up (double-sided discs have content on both sides, so you can place either side up).
3. Press the OPEN/CLOSE or PLAY button. The disc tray closes.

The TV/DVD reads the disc's table of contents, and then one of three things happens depending on how the disc was programmed:

- The disc starts playing.
- The disc menu appears on the screen. One of the options will start disc play. Highlight that option and press OK on the remote.
- The DVD's main menu appears on the screen. Highlight the Play option and press OK on the remote.

When you stop playing a disc, the unit remembers where you stopped. When you start playing the disc again, the unit picks up where you left off unless the disc is removed, the unit is unplugged, or you pressed the STOP button twice.



This is an example of a one-sided disc.

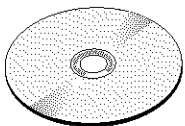

This is an example of a 2-sided disc. The title is in the center.

This product incorporates copyright protection technology that is protected by method claims of certain U.S. patents and other intellectual property rights owned by Macrovision Corporation and other rights owners. Use of this copyright protection technology must be authorized by Macrovision Corporation, and is intended for home use only unless otherwise authorized by Macrovision Corporation. Reverse engineering or disassembly is prohibited.

Using a Disc Menu

A disc is capable of having an on-screen menu that is separate from the DVD's menu system and on-screen Info Display. The disc menu might only contain a list of the titles and chapters, or it may allow you to change features such as language and playback settings. The content and operation of disc menus vary from disc to disc.

Using the On-Screen Info Display

The on-screen Info Display contains many playback features. To see the Info Display, press the INFO button on the remote while a disc is playing. The Info Display appears across the top of the screen. Each feature is illustrated with an icon. Use the left/right arrow buttons on the remote to move through the different icons in the Info Display.

When an icon is highlighted, use the up/down arrow buttons on the remote to scroll through the choices displayed in the text box under the icons.

Remember, you can only access the Info Display when you're playing a disc. Also, the Info Display features are only available if the disc was created with that particular feature (i.e., if you select the Subtitle icon, you won't be able to change the subtitle language unless the author of the disc created the disc with subtitles).

The invalid symbol  appears on the screen when you press a button that doesn't have any function. If one of the icons is "grayed out," that Info Display feature isn't available for the disc you're playing. To make the Info Display disappear from the screen, press INFO on the remote.

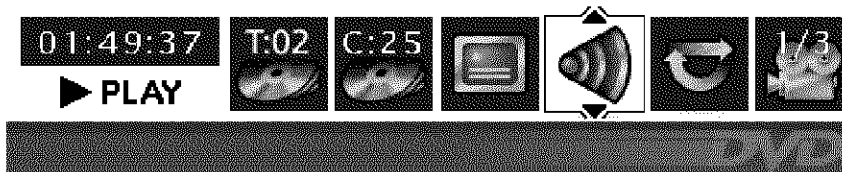

Note: For information about the Info Display for Audio CDs, Video CDs or MP3 files, go to page 49.

Time Display

This feature displays the audio/video time. For DVD discs, the time displayed refers to the current title time. For Audio CDs, it refers to the current track time.

For DVD video discs, the Time Display also acts as a Time Search feature. This lets you go to a particular scene in a movie by entering the time that scene is played. To use Time Search:

1. Press INFO on the remote to bring up the Info Display. Highlight the Time Display and enter the elapsed time of the scene you wish to go to. For example, enter 01:12:00 to go to the scene that plays at 1 hour and twelve minutes into the movie.
2. When you've entered the time, press OK on the remote.

Selecting a Title

Some discs contain more than one title. Each title is divided into chapters. To select a title:

1. While the disc is playing, press INFO on the remote to bring up the Info Display.
2. If the *Title* icon on the Info Display isn't highlighted, use the left/right arrow buttons to highlight it.
3. Use the number button(s) on the remote to enter the title number or press the up/down arrow buttons to go to the next/previous title.
4. Press OK on the remote when the title you want to play appears in the text window.

Note: Some discs only have one title.

Playing DVDs

Selecting a Chapter

Because DVD discs use digital technology, a title can be divided into individual chapters (similar to tracks on a CD). You can skip to a specific chapter by using the Chapter feature in the Info Display.

1. While a disc is playing, press INFO on the remote to bring up the Info Display.
2. Press the left/right arrow buttons to highlight the *Chapter* icon.
3. Use the number buttons on the remote to enter the number of the chapter you want to play or press the up/down arrow buttons to go to the next/previous title.
4. Press OK on the remote.

Notes: The Chapter feature won't work if the disc isn't formatted with separate chapters.

Press CH + or CH - on the remote to highlight the Chapter icon. Then press CH + to advance to the next chapter or CH - to go to the preceding chapter.



Selecting Subtitles

By default, subtitles are off. To turn subtitles on and change the Subtitle language while you're watching a DVD disc:

1. While the disc is playing, press INFO on the remote.
2. Press the left/right arrow buttons to highlight the *Subtitle* icon.
3. If subtitles are off, press OK to turn them on.
4. Use the up/down arrow buttons to scroll through the subtitle languages that are available on the disc. If subtitles aren't available, the text in the text box will read *Subtitles: Not Available*. If subtitles are available, the language currently showing in the text box is the active selection. The subtitles will be shown in that language.
5. To make the Info Display disappear, press the INFO button on the remote.

Notes: Subtitles are only available if the disc was created with subtitles.

Changing the subtitle language with the Info Display will only affect the disc currently being played. When the disc is removed or the unit is turned off, the subtitle language will revert to the language setting specified through the DVD's main menu. The subtitle language can also be changed through the DVD's main menu.

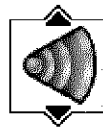

Changing the Audio Language

If the disc was created with different language tracks (recorded in different languages), you can use the Info Display to temporarily change the DVD's Audio Language setting.

1. While a disc is playing, press PRESETS on the remote. The current audio language appears in the text box below the row of icons.
2. Press the up/down arrow buttons to scroll through the audio languages available on the disc until the audio language you want to use appears in the text box. Audio will be played in that language.
3. To make the Info Display disappear, press the INFO button on the remote.

Notes: The language feature only works if the disc was created with multiple audio tracks.

When you choose an audio language from the Info Display, you only override the audio language setting in the DVD's main menu temporarily. The audio language can also be changed through the DVD's main menu.



Using the Repeat Feature

The default mode for the Repeat feature is Off. There are four Repeat options:

- Disc – repeats the disc that is playing
- Title – repeats the title that is playing
- Chapter – repeats the chapter that is playing
- A•B – Set the beginning (point A) and the end (point B) to make this part of the movie play repeatedly.

To Use Repeat:

1. While a disc is playing, press INFO on the remote to bring up the Info Display.
2. Highlight the Repeat icon. The text in the text box below the icons will read *Repeat Mode: Off*.
3. Press the up/down arrow buttons to scroll through the Repeat options until the Repeat option you want is displayed in the text box.
4. Press OK. The selected repeat option will loop repeatedly until you turn Repeat off. Repeat is turned off by completing steps 1 through 3 above, and selecting the Off option.

A•B Repeat

A•B Repeat lets you define a specific segment on the disc that you want to repeat. For example, you might like to watch the dogfight in the movie *Top Gun*. To watch this scene over and over:

1. Find the spot on the disc that is a few seconds *before* the beginning of the scene you want to repeat (this gives you time to access the Info Display and the Repeat feature).
2. Press INFO on the remote and select the Repeat icon from the Info Display.
3. Press the up/down arrow buttons until the A•B Repeat option is shown in the text box underneath the icons. The text box reads *Repeat Mode: A-B Press OK to Set A Point*.
4. At the beginning of the scene you want to repeat, press OK to set the A point.
5. When you get to the part of the disc that you want to be the end of the repeated segment (the B point), press OK. The segment will repeat until you turn Repeat off.
6. To make the Info Display disappear from the screen, press the INFO button on the remote.

How to Cancel Repeat

There are three ways to cancel Repeat:

- Press STOP twice.
- Go to the Repeat icon in the Info Display and select *Off*.
- Eject the disc.



Changing the Camera Angle

Some discs contain multiple angles of a particular scene or sequence. If the disc only has one angle, this feature won't work. When multiple angles are available, the Camera Angle icon appears in the upper right corner of the screen. To change the camera angle:

1. While a disc is playing, press INFO on the remote.
2. The Camera Angle icon will display the number of angles available. For example, if there are 3 different angles, the icon will read 1 of 3. This means angle 1 is currently being played.
3. The text box beneath the icons displays *Camera Angle: 1*. Use the up/down arrow buttons to scroll through the camera angle choices. The camera angle number displayed in the text window is automatically shown.
4. To make the Info Display disappear, press the INFO button on the remote.



Using the TV's Features

Channel Banner

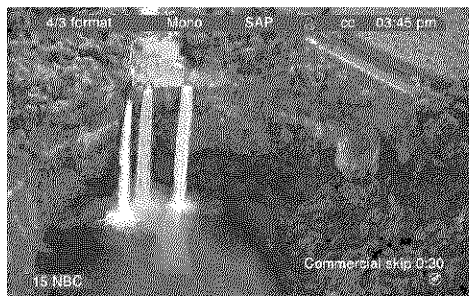
There are several indicators that might appear when you press the TV or INFO button on the remote. This display is called the Channel Banner. The following list describes the items on the Channel Banner screen (left to right and top to bottom).



Sample displays on a Channel Banner.

4/3 format	Current screen format.
Mono (or Stereo)	<i>Mono</i> appears when the current channel is broadcasting in mono. <i>Stereo</i> appears when the current channel is broadcasting in stereo.
SAP	The current channel is broadcasting SAP (Second Audio Program) information.
	Parental Controls are locked.
CC	Closed Captioning is available on the current channel.
03:45 pm	Current time.
15 NBC	Current channel and label assigned to the channel.
Commercial skip 0:30	Shows the time remaining on the commercial skip (SKIP) timer.
	Sound is muted.

Autotuning

The autotuning feature automatically tunes the TV to the correct video input channel for different components you have connected to your TV/DVD (like a VCR, HDTV Tuner, etc.) When you set up autotuning in the menu system you don't have to remember to change your TV to the VID1 input, for example, when you want to watch a tape on the VCR.

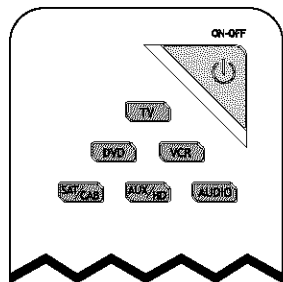

Your remote's component buttons

Why You Should Use the Autotuning Feature

With the autotuning feature, you can set up the TV to tune to the correct video input channel when you press the corresponding component button (VCR, SAT/CAB or AUX/HD).

How to Set Up the Autotuning Feature

The way you set up the autotuning feature in the TV's menu corresponds to the component buttons on the remote and the way you have each component connected to your TV. When you set up autotuning, you're telling the TV/DVD what channel/input to tune to when you press the VCR, SAT/CAB, AUX/HD or AUDIO button on the remote control.

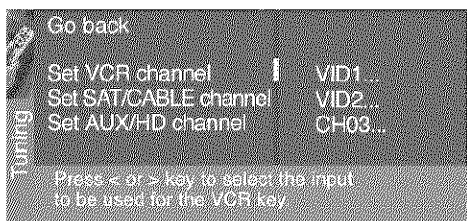
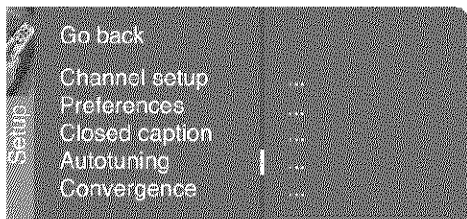

1. Press MENU (the MAIN MENU appears).
2. Highlight *Setup* and press OK on your remote control.
3. Highlight *Autotuning* and press OK.
4. Choose which component button you would like to set:

Set VCR Channel Lets you set up the channel the TV tunes to when you press the VCR button.

Set SAT/CABLE Channel Lets you set up the channel the TV tunes to when you press the SAT/CAB button.

Set AUX/HD Channel Lets you set up the channel the TV tunes to when you press the AUX/HD button.

5. Press the right arrow button to select the choice that matches the way you have the component connected to this TV, and press OK.

You can select from the following inputs or channels:

N/A Choose this if you don't have this particular component connected to the TV, or if you don't want the TV to automatically tune to the correct channel/input when you're using this component.

Channel 3 or 4 Component is connected to the CABLE/ANTENNA jack on the back of the TV, and you want the TV to tune to channel 3 when you press the corresponding button on the remote. Reminder: make sure the component's Channel 3/4 switch is set to channel 3.

VID1 or VID2 (Video Input) Component is connected to a VIDEO or S-Video jack on the back of the TV/DVD and you want the TV to tune to a VID input channel when you press the corresponding component button.

FRNT (Front Video Input) Component is connected to the VIDEO jack on the front of the TV/DVD and you want the TV to tune to the front VID input channel (FRNT) when you press the corresponding component button.

CMP1 or CMP2 (Component Video Input) Compatible component video source, such as an HDTV tuner or satellite receiver, is connected to the three COMPONENT VIDEO INPUT jacks (Y,PB,PR) on the back of the TV/DVD and you want the TV to tune to the component video input channel (CMP) when you press the corresponding component button.

DVI Component (such as an HDTV tuner) is connected to the DVI-HDCP jack on the back of the TV/DVD and you want the TV to tune to the DVI input channel when you press the corresponding component button.

Using the TV's Features

Note:

This section describes the Parental Control feature associated with TV broadcasts (cable, satellite and/or off-air). The Parental Control feature used with DVD discs is explained on page 39 (the Lock menu).

Parental Controls and V-Chip

The choices in the *US V-CHIP* and *Canada V-CHIP* menus involve software inside your TV (referred to as V-Chip) which allows you to block TV programs and movies based on violence, sex, or other content you may believe children should not view.

Once you block programs, you can unblock programs by entering a password.

By default, the software inside your TV is turned "off." For instructions to turn on V-Chip, go to page 35.

Note: Parental Control settings are not available for DVI, CMP1, or CMP2 inputs.

How V-Chip Works for USA and Canada

V-Chip reads the program's age-based rating (TV-MA, TV-14, etc.) and content themes [(Violence (V), Adult Language (L), etc.)]. If you have blocked the rating and/or content themes that the program contains, you will receive the message *This channel has not been approved for viewing. Change channel or press OK to enter password and temporarily deactivate the Parental Control.*

Broadcasters are not required to provide content themes, so programs received with no content themes will only be blocked if you block their age-based rating. You can also block out programs that have been given an Exempt rating, and programs that are considered unrated. The next several pages have tables showing the TV age-based ratings and content themes for the US and Canada.

US V-Chip TV Rating Limit

The V-Chip TV Rating Limit lets you decide which TV programs can and cannot be viewed.

To set TV programming limits:

1. Choose *Parental Control* from the MAIN MENU. If Parental Controls have previously been locked, you must enter your password.
2. Highlight and select *US V-Chip*. Then select *V-Chip TV Rating*.
3. Once you get to the *V-Chip TV rating limit* screen, use the arrow buttons and OK on your remote to change the status of a TV program rating or content theme from *View* to *Block*.
4. For TV rating limits to take effect, lock Parental Controls by accessing the *Lock parental controls* menu.

The following sections give you more details about how to change the status of TV program limits.

Note: If you forget your password, follow step one above to get to the password entry screen. Then press the VOL+ and CH+ buttons on the TV's front panel at the same time for at least 8 seconds. You will receive an on-screen message that Parental Controls have been unlocked once you've successfully reset the password.

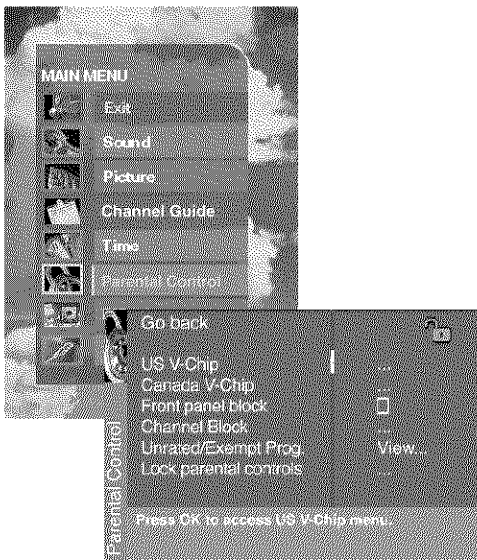

The V-Chip Rating Screen

The following is an example of where items are located within the Rating Limit screen.

Rating Status Field
Lets you select whether the status of the age-based rating limit to the left is View or Block.

Rating Field
Lets you select from a list of age-based ratings you can block or view.

Content Themes
Lists the content themes you can block or view.

Content Status Fields
Lets you select which content themes to view for the selected rating, and whether the status of the content theme is currently unlocked (🔓) or locked (🔒).

Rating Settings Area
Lets you see the current block/view state of age-based ratings and associated content. The View (🔓) settings are coded in green, and the Block (🔒) settings are coded in red.

Age-Based Rating	USA Description and Content Themes for Age-Based Ratings
TV-MA	Mature Audience Only. Specifically designed to be viewed by adults and may be unsuitable for children under 17. It contains one or more of the following content themes: crude indecent language (L), explicit sexual activity (S), or graphic violence (V).
TV-14	Parents Strongly Cautioned. Contains some material that many parents would find unsuitable for children under 14. Parents are strongly urged to exercise greater care in monitoring this program and are cautioned against letting children under the age of 14 watch unattended. This program contains one or more of the following content themes: intensely suggestive dialogue (D), strong coarse language (L), intense sexual situations (S), or intense violence (V).
TV-PG	Parental Guidance Suggested. Contains material that parents may find unsuitable for younger children. Many parents may want to watch it with their younger children. The program contains one or more of the following content themes: some suggestive dialogue (D), infrequent coarse language (L), some sexual situations (S), or moderate violence (V).
TV-G	General Audience. Most parents would find this program suitable for all ages. It contains little or no sexual dialogue (D) or situations (S), no strong language (L), and little or no violence (V).
TV-Y7	Directed to Children 7 years and older. Designed for children ages 7 and above. It may be more appropriate for children who have acquired the developmental skills needed to distinguish between make-believe and reality. Themes and elements in this program may include mild fantasy violence (FV) or comedic violence, or may frighten children under the age of 7.
TV-Y	All Children. Themes and elements in this program are designed for a young audience, including children from ages 2-6. It is not expected to frighten younger children.

Using the TV's Features

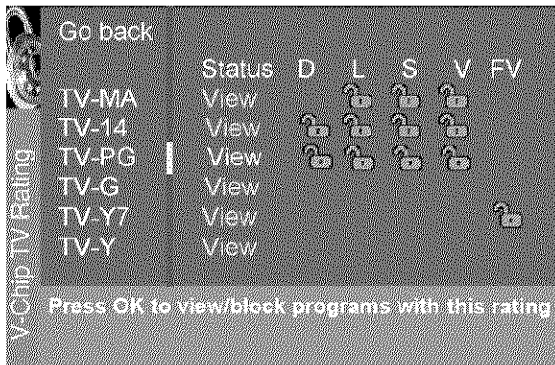

Blocking Age-Based Ratings

You can automatically block all program ratings above a specified age-based rating level.

To block programs with higher ratings:

1. Press the up or down arrow button to scroll to the rating corresponding with the lowest rating you do not want the child to watch.
2. Press the OK button to toggle between *View* and *Block*. The status for the rating listed to the left and all higher ratings automatically changes to Block (and).
3. Use the up/down arrow buttons to highlight *Go back* and press OK.
4. Select *Lock Parental Controls* from the *Parental Control* menu for rating limits to take effect.

Hierarchy of Age-Based Ratings	
TV-MA	Mature Audience Only
TV-14	Parents Strongly Cautioned
TV-PG	Parental Guidance Suggested
TV-G	General Audience
TV-Y7	Directed to Children 7 years and older
TV-Y	All Children

Viewing Age-Based Ratings

After you block age-based ratings, you can change some of the ratings back to *View*.

1. Use the up/down arrows to select the rating with a status of *Block*.
2. Press OK to select *View*.

Content Themes	
D	Sexually explicit dialogue
L	Adult language
S	Sexual situations
V	Violence
FV	Fantasy Violence

Blocking Specific Content Themes

You can block programs based on their content. (Content is represented by the D, L, S, V and FV on your screen.) When you block a content theme for a particular rating, you automatically block that content theme for higher rated programs as well.

To block program content:

1. Determine the content themes you want to block.
2. Press the down arrow button to scroll to the rating whose content theme you want to change.
3. Press the right arrow button to move the yellow highlight to a particular content theme status.
4. Press the OK button to change its status to . (In the example to the left, you block the language (L) corresponding with TV-14. The language for TV-MA is blocked as well.)

Notes: Broadcasters are not required to provide content themes or age-based ratings.

You must remember to lock Parental Controls for rating limits to take effect.

Tip

To change all V-Chip movie or TV ratings to *View*, press the 0 number button.

Viewing Specific Content Themes

If you block specific content themes, you have the option of going back and changing some of the them back to (📺) View:

1. Determine the content themes you want to change to (📺) View.
2. Press the down arrow button to scroll to the rating whose content theme you want to change, such as 📺 under language (L) corresponding with TV-14.
3. Press the right arrow button to move the yellow highlight to a particular content theme status.
4. Press the OK button to change the status back to 📺. Your child would then be able to watch programs with the TV-14 adult language content, but not programs with TV-MA language content.

Note: Only the content theme status corresponding to TV-14 (L) language changes to (V) View. Higher rated content themes, such as that for TV-MA language, do not change.

Canada V-Chip Ratings

Canadian TV V-Chip supports two different Canadian rating systems: English and French.

Rating	Canadian English V-Chip Rating System
18+	Adults. Programming intended for adults 18 and older. It may contain elements of violence, language, and sexual content which could make it unsuitable for viewers under 18. Violence Guidelines: May contain violence integral to the development of the plot, character or theme, intended for adult audiences. Other Content Guidelines: May contain graphic language and explicit portrayals of nudity and/or sex.
14+	Viewers 14 and over. Programming contains themes or content which may not be suitable for viewers under the age of 14. Parents are strongly cautioned to exercise discretion in permitting viewing by pre-teens and early teens. Violence Guidelines: May contain intense scenes of violence. Could deal with mature themes and societal issues in a realistic fashion. Other Content Guidelines: May contain scenes of nudity and/or sexual activity. There could be frequent use of profanity.
PG	Parental Guidance. Programming intended for a general audience but which may not be suitable for younger children (under the age of 8). Parents may consider some content inappropriate for unsupervised viewing by children aged 8-13. Violence Guidelines: Depictions of conflict and/or aggression will be limited and moderate; may include physical, fantasy, or supernatural violence. Other Content Guidelines: May contain infrequent mild profanity, or mildly suggestive language. Could also contain brief scenes of nudity.
G	General Audience. Programming considered acceptable for all ages groups. While not designed specifically for children, it is understood younger viewers may be part of the audience. Violence Guidelines: Will contain very little violence, either physical or verbal or emotional. Will be sensitive to themes which could frighten a younger child, will not depict realistic scenes of violence which minimize or gloss over the effects of violent acts. Other Content Guidelines: There may be some inoffensive slang, no profanity and no nudity.
C8+	Children 8 and older. Programming generally considered acceptable for children 8 years and over to watch on their own. Violence Guidelines: Violence will not be portrayed as the preferred, acceptable, or only way to resolve conflict or encourage children to imitate dangerous acts which they may see on television. Any realistic depictions of violence will be infrequent, discreet, of low intensity and will show the consequences of the acts. Other Content Guidelines: There will be no profanity, nudity or sexual content.
C	Children. Programming intended for children under age 8. Violence Guidelines: Careful attention is paid to themes which could threaten children's sense of security and well being. There will be no realistic scenes of violence. Depictions of aggressive behavior will be infrequent and limited to portrayals that are clearly imaginary, comedic or unrealistic in nature. Other Content Guidelines: There will be no offensive language, nudity or sexual content.

Using the TV's Features

Rating	Canadian French V-Chip Rating System
18 ans +	Adults. Programming is for adults only. This program contains sustained violence or extremely violent scenes.
16 ans +	Viewers 16 and over. Programming is not suitable for those under age 16. This program contains frequent scenes of violence or intensely violent scenes.
13 ans +	Viewers 13 and over. Programming may not be suitable for children under the age of 13. This program either contains several violent scenes or one or more scenes that are violent enough to affect them. Viewing in the company of an adult is therefore strongly recommended for children under the age of 13.
8 ans +	Viewers 8 and over. Not recommended for young children. This program is suitable for most audiences, but it contains mild or occasional violence that could upset young children. Viewing in the company of an adult is therefore recommended for young children (under the age of 8) who do not distinguish between reality and imagination. Programming generally considered acceptable for children 8 years and over to watch on their own. Violence Guidelines: Violence will not be portrayed as the preferred, acceptable, or only way to resolve conflict or encourage children to imitate dangerous acts which they may see on television. Any realistic depictions of violence will be infrequent, discreet, of low intensity and will show the consequences of the acts. Other Content Guidelines: There will be no profanity, nudity or sexual content.
G	General Audience. This program is suitable for audiences of all ages. It contains no violence, or any violence that it does contain is either minimal or is presented in a humorous manner, as a caricature, or in an unrealistic way.

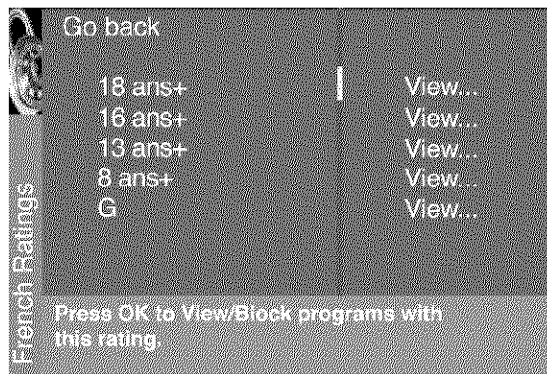
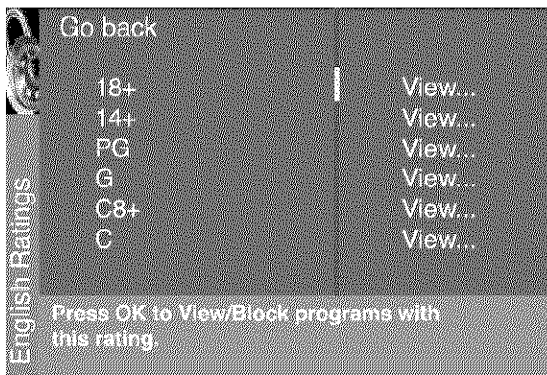

Blocking Canadian V-Chip Ratings

If you receive Canadian programs you can block Canadian English and French V-Chip by ratings only. When you block a particular rating, you automatically block the higher rated programs as well.

To block Canadian English and French program ratings:

1. Select *Canada V-Chip* from the *Parental Control* menu.
2. Highlight *English ratings* or *French ratings* and press OK.
3. Determine the rating you want to block.
4. Press the down arrow button to scroll to the rating you want to change.
5. Press the OK button to change its status to block (the lock icon appears and all ratings above the one you selected change to lock).

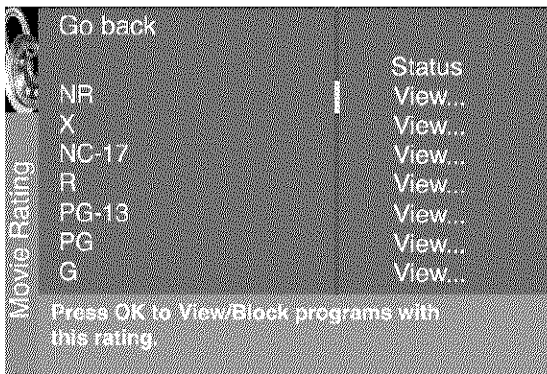

V-Chip Movie Rating Limit

Set movie rating limits by blocking movies rated above a specified level.

To access the Movie Rating Limit menu:

1. Press MENU on the remote control (the TV's *MAIN MENU* appears).
2. Select *Parental Control*.
3. Select *US V-Chip*.
4. Select *V-Chip movie rating*.

Blocking Movie Ratings

Once you are in the Movie Ratings menu, follow the same steps described for blocking TV ratings.

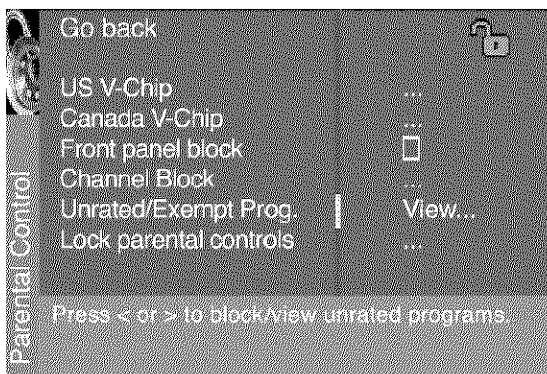

Blocking Unrated/Exempt Programs

The *Unrated/Exempt Prog.* option lets you decide if programs that the V-Chip recognizes as unrated can be viewed. Unrated TV programs may include news, sports, political, religious, local and weather programs, emergency bulletins, public announcements, and programs without ratings. The Exempt option applies to both USA and Canadian unrated programs and Canadian programs rated *E*.

View All unrated programs are available.

Block All unrated programs are not available.

Note: You must remember to lock *Parental Controls* for rating limits to take effect.

Press the down arrow to highlight *Unrated/Exempt Prog.* Then press the right arrow to toggle between *View* and *Block*.

Lock/Unlock Parental Controls

Selecting this option lets you lock and unlock parental controls settings using a password.

If you do not lock parental controls, none of the settings for V-Chip, Channel Block, or Front Panel Block will take effect.

If you forget your password, press the MENU button, then select *Parental Control* (the password entry screen appears). Simultaneously press and hold CH+ and VOL+ on the front panel for 8 seconds. Parental Controls unlock and the *Parental Control* menu appears. You can enter a new password by locking the Parental Controls again.

Front Panel Block

Selecting this option lets you block (disable) or unblock (enable) the TV's front panel. The remote still tunes to any channel. When using this as a Parental Control method, remove access to any remote that is capable of operating the television while you have the front panel blocked.

Don't forget to lock parental controls after you change the status. If you don't, the front panel block will not take effect.

Using the TV's Features



PIP example



POP example

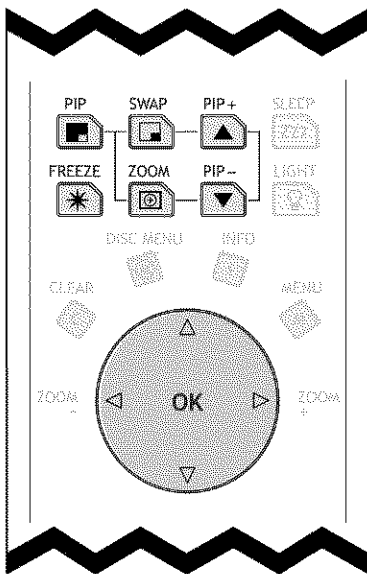

PIP (Picture-in-Picture) and POP (Picture-outside-Picture) Operation

The PIP (picture-in-picture) feature lets you display a second, smaller picture on top of the main picture. POP (picture-outside-picture) lets you display two windows side by side.

Note: PIP and POP are not available for DVI sources, component video sources (CMP1 or CMP2), or when you're using the internal DVD player.

PIP and POP Buttons

There are several remote buttons that control the way the PIP window works:

PIP Brings up the PIP window. Press again to bring up POP. Press again to remove the window.

Up and down arrow buttons Let you move the PIP window to different corners of the screen. Up arrow moves PIP counterclockwise; down arrow moves PIP clockwise.

Left and right arrow buttons Switches the main POP window, where the sound is coming from, with the other window.

SWAP Switches, or "swaps," the video from the PIP window with the main picture. Switches the main POP window, where the sound is coming from, with the other window.

PIP + and PIP - Lets you change channels in the PIP and right POP window.

ZOOM Changes the size of the PIP window.

The DVD's Menu System

The DVD's menu system is not the same as the disc menu or the Info Display. The DVD's main menu comes up when there is no disc playing. If you're playing a disc, press STOP on the remote control to stop playback and bring up the DVD's main menu.



The Play/Resume Play Option

To get to the DVD's main menu, press STOP on the remote control. The first item in the main menu is the *Play/Resume Play* option. If there isn't a disc in the TV/DVD, the option reads *Play* with the prompt *Insert Disc* to the right. If there is a disc in the TV/DVD and it was previously playing, the option reads *Resume Play* and the name of the disc is displayed on the right.

Any time you stop playback, you will be returned to the DVD's main menu, and the *Play* option will read *Resume Play*. To resume play, highlight the option and press OK, or press the PLAY button on the remote.

The Play Mode Menu

The DVD's *Play Mode* menu lets you choose different ways to play the disc. To see *Play Mode* menu options, a disc must be in the TV/DVD.

1. If the disc is playing, press STOP (the DVD's main menu appears).
2. Highlight the *Play Mode* menu option.
3. Press OK. The *Play Mode* menu items appear.
4. Highlight the desired option and press OK. *Program Play* will not work unless you have created a program list.

Selecting a Play Mode

The first three options in the *Play Mode* menu determine in what order the titles or tracks will play on a disc.

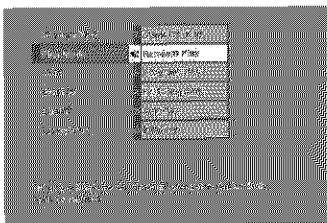

Standard Play: plays the disc's titles and chapters in their default order (i.e., chapter 1 of Title 1 plays first, then chapter 2 of Title 1, etc.)

Random Play: plays the chapters of each title in random order.

Program Play: Plays the chapters on the disc in the order you have programmed (you must select *Edit Program* and set up the order in which you want the tracks on the disc to play).

How to Create a Program

To use the *Program Play* option, you must create a program list to set the order in which you want titles and chapters on a DVD video disc to play. To create a program list for an Audio CD or MP3 go to Chapter 7.

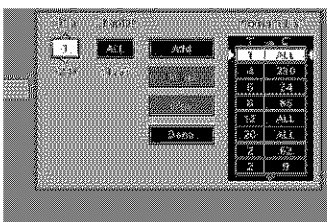

Creating a Program List for a DVD Video Disc

1. If the disc is playing, press STOP to stop playback (the DVD's main menu appears).
2. Highlight *Play Mode* and press OK (the *Play Mode* menu appears).
3. Highlight *Edit Program* and press OK (the *Edit Program* screen appears).
4. The *Title* box is highlighted. Use the up/down arrows or the number buttons on the remote to enter the title you want to play first. The title number you entered appears in the *Title* box. The number of chapters available appears under the *Chapter* box.

Continues on next page...

Using the DVD Menu

5. Highlight the *Chapter* box and use the up/down arrows or the number buttons on the remote to enter the chapter you want to play first and press OK. The highlight jumps to the *Add* button.
6. Press OK to add that chapter to the *Program List*. The highlight jumps back to the *Title* box so you can add more titles and/or chapters. Make sure the *Title* box is highlighted and enter your next title and/or chapter.
7. Continue adding titles/chapters as explained in steps 4-6 until your program is complete. To play the program, highlight *Play* and press OK. To save the program to play later, highlight *Done* and press OK. The program will be erased when you remove the disc from the TV/DVD.

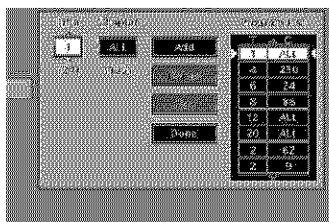

Editing a Program – Deleting Chapters

To delete chapters from the playlist:

1. If the disc is playing, press STOP to stop playback (the DVD's main menu appears).
2. Highlight *Play Mode* and press OK (the *Play Mode* menu appears).
3. Highlight *Edit Program* and press OK (the *Edit Program* screen appears).
4. Highlight the item in the playlist you want to delete.
5. Highlight *Delete*, and press OK.
6. When you're finished rearranging the playlist, highlight *Done* and press OK.

Editing a Program – Inserting Chapters

To insert chapters into the playlist:

1. If the disc is playing, press STOP to stop playback (the DVD's main menu appears).
2. Highlight *Play Mode* and press OK (the *Play Mode* menu appears).
3. Highlight *Edit Program* and press OK (the *Edit Program* screen appears).
4. Use the left/right arrow keys to move the highlight to the program list. Use the up/down arrow keys to mark the spot in the playlist where you want to insert a chapter (the inserted chapter will be placed *before* the highlighted chapter).
5. Highlight the *Chapter* box and use the up/down arrows or the number buttons on the remote to enter the chapter you want to play first.
6. Once you enter the number, the *Insert* box is highlighted. Press OK to insert the chapter in the playlist.
7. When you're finished rearranging the playlist, highlight *Done* and press OK.

AutoPlay

You can set the AutoPlay option to play your disc automatically after you close the disc tray.

1. From the DVD's main menu (in DVD mode, no disc playing) highlight the *Play Mode* option and press OK.
2. The Play Mode selections appear. Highlight the AutoPlay option and press OK to toggle the option on/off.
3. Press the left arrow button to return to the previous menu or press GO BACK to return to the main menu.

IntroScan

IntroScan plays the first 10 seconds of each track on an Audio CD or MP3 file. IntroScan will not repeat automatically. Once it has completed, the system will stop the disc and return to the main menu.

To use IntroScan when playing a CD or MP3:

1. Highlight *Play Mode* and press OK.
2. Highlight *IntroScan* and press OK to begin the function.
3. Press STOP to stop the IntroScan function.

The Lock Menu

The padlock icon is displayed on the DVD's main menu which shows whether your DVD is locked or unlocked.

 **Locked:** A password is needed in order to play discs that aren't included in the rating limits you have set. When the DVD is locked, no one can access the *Lock* Menu items without entering the password.

 **Unlocked:** A password isn't required to play discs.

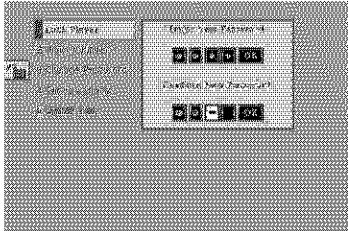

Locking Your DVD

1. If the disc is playing, press STOP (the DVD's main menu appears).
2. Highlight *Lock* and press OK (the *Lock* menu items appear).
3. Highlight *Lock Player* and press OK. The *Enter New Password* screen appears.
4. Press the number keys on the remote to enter the password you want to use (similar to entering your PIN when you use a bank machine).
5. After you've entered the last number in the password, press OK. *Confirm Password* appears.
6. Enter the numbers you entered the first time and press OK when you're finished.
7. Press the left arrow to return to the main menu.

Unlocking Your DVD

1. If the disc is playing, press STOP (the DVD's main menu appears).
2. Highlight *Lock* and press OK.
3. The *Enter Password* box appears. Enter your password (the *Lock* menu options appear).
4. Highlight *Unlock Player* and press OK. The locked icon changes to unlocked.

If you forget your password, simultaneously press and hold OPEN/CLOSE and the STOP on the TV/DVD's front panel for 8 seconds. Enter a new password via the *Lock* menu.

Changing Your Password

The DVD must be locked to change the password.

1. If the disc is playing, press STOP (the DVD's main menu appears).
2. Highlight *Lock* and press OK. *Enter Password* appears on the screen. Enter your password.
3. Highlight *Change Password* and press OK. *Enter New Password* appears.
4. Use the numbers on the remote to enter the new password you want to use and press OK. *Confirm Password* appears.
5. Press the number keys to enter the password again and press OK when you're finished.

Setting the Ratings Limits

The Ratings Limits feature is a rating limit system, sort of like movie ratings. It works with DVD discs that have been assigned a rating. This helps you control the types of DVDs that your family watches.

*Note: When in DVD mode, the TV/DVD alerts you when you try to play a movie with a rating that exceeds the limit you've set. Some discs include a rating override feature. When you play a disc with this feature, the message **Override Limit or Cancel Selection** appears on the screen. If you choose to override the rating limit, you will need to enter your password to begin playback.*

Using the DVD Menu

Changing to a Different Country's Rating System

Some countries use different rating systems. The default for this TV/DVD is the United States. You can change to a different country's rating system through the *Lock* menu.

1. If the disc is playing, press STOP (the DVD's main menu is displayed).
2. From the main menu, highlight the *Lock* option and press OK (the *Lock* menu appears).
3. Highlight *Ratings Limits* and press OK (the *Ratings Limits* menu appears).
4. Highlight *Country* and press OK (a list of countries appears).
5. Highlight the country you want to change to and press OK (the country you selected appears next to the *Country* menu).
6. Press the left arrow key to return to the main menu.

Rated Titles

The *Rated Titles* option lets you determine how your DVD will react to discs that contain movies that are rated (in the U.S.A., the Motion Pictures Association of America rates movies as G, PG, PG-13, etc.). You decide which ratings require a password and which ones don't. This system ranks the ratings 1 through 8 in order to accommodate different countries' rating systems (1 is considered a movie title with the least offensive material). In order for the Rating Level feature to work, the disc must be encoded with rating information. If the author of the disc did not encode rating information, then this feature will not work for that disc. When in DVD mode, the TV/DVD must be locked in order for it to enforce the settings in the *Ratings Limits* part of the *Lock* menu.

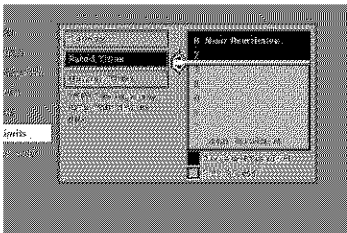

1. From the *Lock* menu, highlight *Ratings Limits* and press OK (the *Ratings Limits* menu is displayed).
2. Highlight *Rated Titles* and press OK (the 8-level rating limits list appears).
3. To change the rating limit, press the up or down arrow button.
 - The ratings that don't require a password (free access) appear under the bar, in the green part of the block.
 - The ratings that require a password appear above the bar, in the red part of the block.
4. When you have moved the bar to the desired setting, press OK. You're returned to the *Rated Titles* screen and the setting appears to the right of the *Rated Titles* option. For example, if you set 3 as the highest rating for Free Access (green), then the *Rated Titles* selection appears as 3 (that's the DVD's number for PG in the 8-level system) for the movie studio's rating. This means when the DVD is locked, it will require you to enter the password to play any discs that are rated higher than 3 (i.e., PG-13 or NC-17).
5. Press the left arrow button to return to the main screen.

Unrated Titles

Some titles (movies) aren't rated, but may contain material that is unsuitable for children. You decide how you want the *Ratings Limits* feature to handle these discs: free access or password required. To set the *Unrated Titles* option:



1. From the Lock Menu, highlight *Ratings Limits* and press OK.
2. Highlight *Unrated Titles* and press OK. The *Unrated Titles* options appear.
3. Use the up/down arrow buttons to highlight your choice: *Free Access* or *Password Required*. Press OK to select. Then, press the left arrow button to return to the previous screen. The option you chose is displayed next to the *Unrated Titles* option.
4. Press the left arrow key to return to the main menu.

Note: Many special features added to DVDs, such as the director's commentary, are also unrated.

System Test

There are several tests you can run from the System Test menu. If a problem is found, the text will appear in light gray.

1. Highlight *System Test* within the *Lock* menu.
2. Press OK to display the *System Test Results* screen.
3. Press the left arrow key to return to the main menu.

The Display Menu

The *Display* menu contains the settings that affect how disc content looks on your TV/DVD.

TV Image

The *TV Image* menu adjusts the way a movie appears on your TV/DVD.

1. From the DVD's main menu (in DVD mode, no disc playing), highlight *Display* and press OK (the *Display* options appear).
2. Highlight *TV Image*. Press OK. The *TV Image* options appear.

4 x 3 Letterbox – Choose this setting when receiving a 4:3 image with subtitles ON. You'll see the entire frame of the movie, but it will take up a smaller portion of the screen vertically to accommodate subtitles. The movie might appear with black bars at the top and bottom of the screen.

4 x 3 Standard – Choose this setting when receiving a 4:3 image and you want the on-screen appearance of the video to be a centered picture with black side panels (blank area) on the right and left sides. Most discs produced in a widescreen format can't be cropped in this fashion. This means the black bars appear at the top and bottom of the screen.

16 x 9 Standard – Choose this setting to view 16:9 formatted DVD's. Most DVD's will force the viewing to this mode. Also choose this if you want a 4:3 image to adjust horizontally to fill the 16:9 screen. Black side panels won't be added, and the image is vertically unaltered.

On-Screen Displays

This feature lets you select whether you want certain on-screen displays to appear on the screen. It contains three choices with check boxes next to them:

- **Information Display** – When turned on, displays time transport information when you're fast forwarding or reversing playback.
- **Angle Indicator** – When turned on, displays camera angle icon if more than one camera angle is available.
- **Scene Again™ Text** – When turned on, displays subtitles when you use the Scene Again™ feature.

The default is to show all on-screen displays. To turn one of the options on or off, highlight an option and press OK. This toggles the option on or off.

The Sound Menu

The *Sound* menu lets you select different sound settings to match the equipment you have connected to your unit.

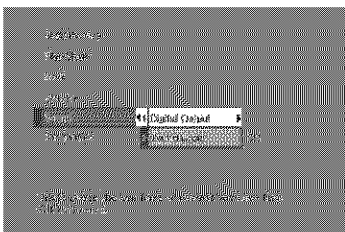

Digital Output

Digital output lets you choose which type of digital audio is output from your unit. If you've used an optical cable to connect a Dolby Pro Logic, Dolby Digital, or DTS receiver, you must adjust this setting. There are two options:

- **Dolby Digital**: Choose this setting if you connected a Dolby Digital receiver.
- **DTS**: Choose this setting if you connected a DTS receiver or decoder to your unit.

The default is Dolby Digital.

Using the DVD Menu

To change the digital output:

1. From the main menu, highlight and select the *Sound* option and press OK (the *Sound* menu is displayed).
2. Highlight the *Digital Output* option and press OK.
3. Highlight the desired output and press OK.
4. Press the left arrow key to return to the main menu.

Notes: If you set Digital Output to DTS, you must have your unit connected to a receiver or decoder with the DTS feature and the disc you play must support the DTS audio format. If you choose DTS and your receiver or decoder doesn't support DTS, you won't hear any audio.

Sound Logic

The Sound Logic feature compresses the dynamic range (quietest sound to loudest sound) of a disc's soundtrack. For example, action scenes might be very loud, while whispered dialog is quiet. The Sound Logic feature evens out the range of the volume by making loud sounds quieter and soft sounds louder. The Sound Logic option is a toggle, it can be turned on or off. The default setting is off.



To turn the Sound Logic feature on:

1. From the DVD's main menu, highlight *Sound* and press OK (the *Sound* menu appears).
2. Highlight the *Sound Logic* option and press OK.
3. Press the left arrow button to return to the main menu.

Note: The performance of the Sound Logic feature varies depending on the type of equipment you have connected to your TV/DVD and the audio format of the disc you're playing.

The Languages Menu

The *Languages* menu enables you to choose different language options for audio, subtitles, Disc Menu items and DVD main menu items. The default for all Language menu items is English.

Changing the Player Menus, Disc Menus, Audio or Subtitles Language Preferences

You can choose one of the languages for the text that appears within the on-screen menu system.

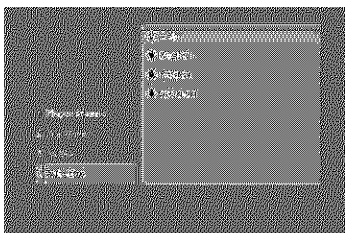

1. From the main menu, highlight and select the *Languages* option (the *Languages* menu is displayed).
2. Highlight the language option for the language you want to change and press OK (the language choices are displayed).
3. Highlight the language you want to use and press OK. The menu appears with your selection shown next to the language option.
4. Press the left arrow button or press GO BACK to return to the previous menu.

Notes: If you change the Player Menu Language, the entire DVD's menu system will be displayed in the selected language.

The option Original in the Audio Language menu is the language in which the audio was originally recorded.

Using the TV's Menu System

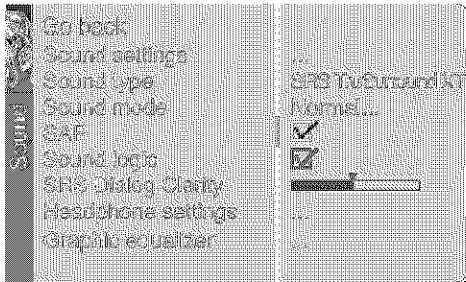

Sound Menu

The Sound menu lets you adjust audio output. To access the Sound menu, press MENU on the remote, and then select *Sound* from the main menu. The following audio items can be adjusted: *Sound settings*, *Sound type*, *Sound mode*, *SAP*, *Sound Logic*, *Headphone settings*, and *Graphic equalizer*.

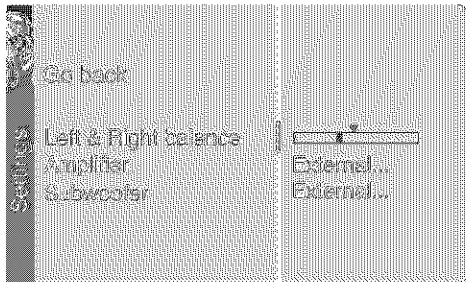

Sound settings The *Sound settings* submenu contains the following items:

Left & Right balance Use the left or right arrow to center the bar under the arrow to balance the left and right speakers.

Amplifier Use the left or right arrow button to select *External* (if your TV/DVD is using external amplifier only) or *Internal* (if your TV/DVD is using the speakers in the TV).

Subwoofer Set the TV's subwoofer to *External* if the TV/DVD is using an external subwoofer; or *None*.

Sound type Press the right arrow button to scroll through the available audio types, which control the way the sound comes through your speakers. The options available vary according to the input selected.

Mono (available for regular TV viewing only) Plays the sound in mono only. Use this setting when receiving broadcasts with weak stereo signals.

Stereo Splits the incoming stereo audio signal into left and right channels. Most TV programs and recorded materials have stereo audio. The word *Stereo* appears in the channel banner when you tune to a program that is broadcast in stereo.

Automatic (available for regular TV viewing only) Chooses the sound type according to the current signal.

Left and Right (available for audio/video inputs only) Isolates either the left or right channel of the incoming audio.

Sound Mode Press the right arrow button to scroll through the available audio modes, which provides special processing through your speakers (depending on the setting you chose as your *Sound type*).

Normal Does not give any special processing, simply provides the mono or stereo sound provided by the signal you're watching.

Wide Available only for mono signals. "Widens" sound from mono broadcasts and mono components connected to your TV/DVD for a fuller, more spacious sound.

Magic Available only for stereo signals. Gives a surround effect with more bass.

SRS TruSurround XT™ Available for stereo or multichannel input. Creates a virtual surround sound effect through any two-speaker playback system.

SRS Dialog Clarity™ Available only when the Sound Mode is *SRS TruSurround XT*. Makes dialog from the source material clearer when you're watching it on your TV/DVD.

Continues on next page...

Using the TV's Menu System

Second Audio Program (SAP) Plays the program's audio in a second language, if one is available. The letters "SAP" appear in the channel banner when you tune to a program that is broadcast with SAP information. SAP audio is broadcast in mono. SAP is also used to broadcast a program's audio with descriptions of the video for the visually impaired.

Sound logic Reduces the annoying blasts in volume during commercial breaks, and also amplifies softer sounds in program material. Eliminates the need to constantly adjust the volume.

Headphone settings Displays a choice list of available settings you can adjust: *Volume*, *Bass* and *Treble*. The *Headphone sound* option allows you to choose stereo, mono or automatic. These descriptions are same as for *Sound Type* (see on previous page).

Graphic equalizer Allows you to choose a specific preset through the Sound Preset option. Press the right arrow to cycle through the options: *Standard*, *Movie*, *Voice*, *Music*, *Flat*, *Videogame*, *Video camera* and *Personal*.

The Frequency range displays the different treble and bass bands set for each Sound Preset option. You can choose a band and make adjustments. When you make adjustments, the Sound Preset option automatically changes to *Personal*. Press the left or right arrow button to select the frequency (Bass 100Hz, Mid Bass 500Hz, Medium 1.5kHz, Mid Treble 5kHz, Treble 10kHz) you want to adjust. Then use the up or down arrow button to adjust the level.

To view the frequency range of another *Sound Preset* option, press the right or left arrow until no band is selected and *Frequency range* is highlighted. Then press the up arrow to highlight *Sound Preset*.

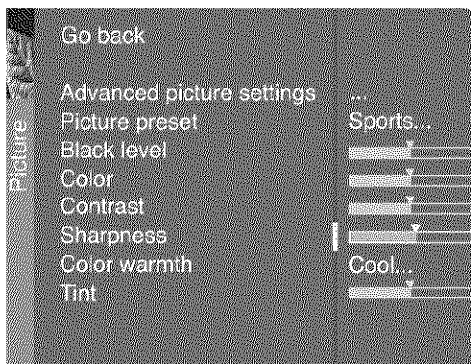
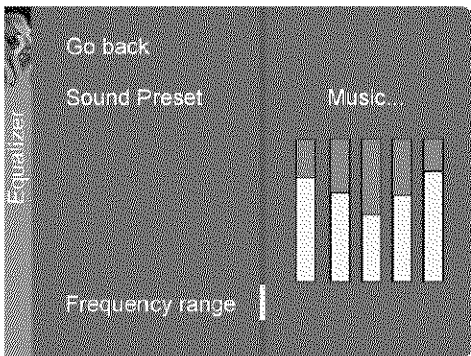

Picture Menu

The *Picture* menu contains menus and controls to configure the following video settings: *Advanced picture settings*, *Picture presets*, *Black level*, *Color*, *Contrast*, *Sharpness*, *Color Warmth*, and *Tint*. The Picture menu options apply to the video for the main TV and video input selections.



Advanced picture settings

Contrast expand You can adjust the contrast of the picture to suit the light of the room. Press the right arrow to choose which of the following best describes the lighting in the room: *Low*, *Medium* or *High*.

Scan Velocity Modulation Improves the sharpness of the picture by changing the speed of the cathode-ray tube's electron beam when it transitions between dark and light areas of the screen. Choose to have it on (box checked) or off (box unchecked), depending on your preference.

Using the TV's Menu System



Tip:

If the picture is switching screen formats abruptly during normal TV viewing, switch the *Autoformat* feature off.

Autoformat When enabled (box checked) the TV automatically detects the screen format the signal is sending for each channel, as well as input channels.

Video noise reduction Reduce picture “static” or any type of interference. This feature is especially useful for providing a clearer picture in weak analog signal conditions. Press the right arrow to choose between: *Off* for no noise reduction; *Minimum* for a softer, smoother picture that retains picture sharpness and detail; *Medium* for a slightly softer picture than the *Minimum* setting; *Maximum* for an even softer, smoother picture than the other settings (the picture detail is somewhat decreased).

Optimized still picture When enabled (box checked), enhances the picture specifically for still frames (for example, if you're watching a slideshow on your HDTV monitor, or if you've paused a frame of a DVD).

Auto Skin Tone When enabled (box checked), minimizes the flesh tone variations of the TV picture.

Film mode (3:2 Pulldown) Automatically detects video sources that were originally recorded on film (like most movies) and subsequently converted to a different format (for TV broadcast, for example). Film mode processes the converted signal so that it looks as close as possible to the original. Another name for this process is reverse 3:2 pulldown.

Advanced (recommended) enables the feature only when the TV detects that movie playback quality could be improved. *Advanced* is the default setting.

The *On* setting should only be used in rare circumstances when the TV is used solely with film-based sources (like DVDs on a non-progressive-scan player).

The *Off* setting turns off film mode upconversion. Try using this setting if you think the reverse 3:2 pulldown is causing distortions in your picture.

Note: *Autoformat* and *Video noise reduction* are available for *CMP1* and *CMP2* inputs only if the signal is 480i.

Picture Presets Displays a choice list that lets you select one of the preset picture settings: *Vibrant*, *Cinematic*, *Natural*, *Sports*, *Videogame*, *Video Camera* or *Personal*. Choose the setting that is best for your viewing environment. You can set a different picture preset for each input (including one for your regular TV channels).

Black Level Adjusts the brightness of the picture.

Color Adjusts the richness of the color.

Contrast Adjusts the difference between the light and dark areas of the picture.

Sharpness Adjusts the crispness of the edges in the picture.

Note: You can adjust sharpness for each channel and input. This is useful if the signal appears fuzzy.

Color Warmth Displays a choice list that lets you set one of three automatic color adjustments: *Cool* for a more blue palette of picture colors; *Normal*; or *Warm* for a more red palette of picture colors. The warm setting corresponds to the NTSC standard of 6500 K.

Tint Adjusts the balance between the red and green levels.

When you change any of these picture settings, the Picture Preset changes to *Personal*. Use the left or right arrow button to make adjustments. To return to the Picture menu, press the up or down arrow button.

Using the TV's Menu System

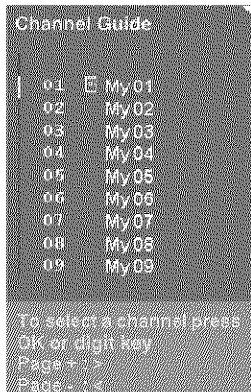

Channel Guide Menu

Allows you to view and select from the entire channel list and their labels. Press the GUIDE button to bring up the Channel Guide menu. Use the up or down arrow to scroll through the list. Press OK to select and tune to the highlighted channel. Press the last digit of one of the channels in the guide to tune to that channel and leave the Channel Guide on the screen.

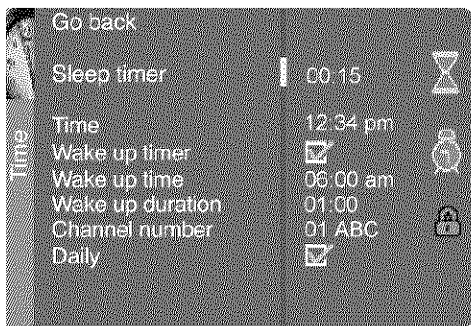

Time Menu

Sleep Timer Lets you set the TV/DVD to turn off after a given amount of time.

Time Lets you enter the current time. If it is eight o'clock, for example, you must first enter the number zero, then number eight. Use the OK button to choose between AM and PM.

Wake up timer Lets you set the TV/DVD to turn itself on. When you turn on Wake up timer, the following options appear:

Wake up time Lets you set the time you want the TV/DVD to turn itself on.

Wake up duration Lets you set how long you want the TV/DVD to stay on when it turns on.

Channel number Lets you select a specific channel the TV tunes to when the wake up timer is set.

Daily Lets you choose if you want the wake up timer to turn on daily.

Note: The Wake up timer is available only when the time has been set.

Parental Control Menu

The Parental Control Menu was explained in Chapter 4. Go to page 30 for more information.

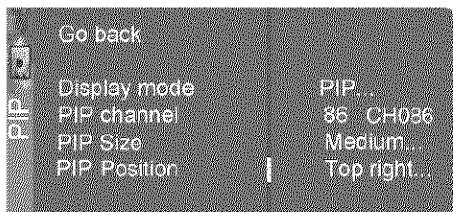

PIP Menu

Display Mode

Off No window is displayed.

PIP PIP window is displayed.

POP POP window is displayed.

PIP channel Allows you to choose the channel displayed in the PIP or main POP window. Scroll through channel list as well as the VID1, VID2 and FRNT input channels.

PIP size Allows you to choose the size of the PIP window: *Small*, *Medium* or *Large*.

PIP position Allows you to choose where the PIP window appears on the screen: *Top right*, *Top left*, *Bottom right* or *Bottom left*.

Note: Pip size and position are not available for POP.

Using the TV's Menu System

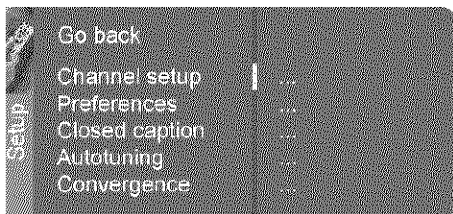

Note:

If Parental Controls are locked, you must enter your password to access the Setup menu.

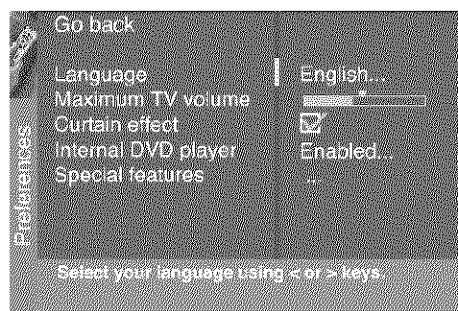

Short-term vs. Long-term Power Outages

The *Auto channel* and *Auto volume* settings don't take effect after short-term power outages (usually less than two to three minutes). The TV will turn back on at the same volume and channel as before the power outage.

The *Auto channel* and *Auto volume* settings take effect after power outages of several minutes or more.

Setup Menu

The Setup menu lets you configure the TV/DVD to fit its surroundings and your preferences. To access the *Setup* menu, press MENU on the remote, and then select *Setup* from the main menu.

Channel setup

Signal Type The TV chooses the signal type during the initial setup. If you change how you receive broadcasts through the antenna input, you must change the *Signal type* setting. Choose *Cable* if you are using cable or a cable box for TV signals. Choose *UHF/VHF Antenna* if you are using an off-air antenna for TV signals.

Auto channel search Searches for channels the signal is receiving. Go to page 15 for more information.

Auto channel update Searches for any new channels that are not in your channel list and adds them to the list.

List and labels Edit the channels in the list or choose labels for each channel. Go to page 15 for more information.

Preferences

Language Displays a choice list that lets you select your preferred language for the menus: *English*, *Español* or *Français*.

Maximum TV volume Allows you to set how high volume turns up when you press the VOL+ button. Highlight *Maximum volume*, then press and hold OK to hear the maximum volume. Make sure the volume has not been muted or turned down all the way.

Curtain effect Reveals the picture by "opening" it from the middle of the screen when the TV/DVD is switched on. Hides the picture by "closing" it from the sides when the TV/DVD is switched off.

Internal DVD player The internal DVD player can be enabled or disabled. If, for example, you're using the TV/DVD with an external DVD player, and you've programmed the remote to work with that player, then you can disable the internal DVD player so that it isn't activated by the buttons on your remote. Then you can use your TV remote with your external DVD player without the internal DVD player interfering. To enable or disable the internal DVD player, highlight *Internal DVD player*, then press the OK button for five seconds.

Special features The *Auto on* setting switches your TV/DVD on after a power outage; *Auto channel* tunes the TV to the channel you specify as the *Initial channel* when *Auto on* is enabled; *Auto volume* tunes the TV to the volume you set in *Initial volume* when *Auto on* is enabled.

Continues on next page...

Using the TV's Menu System

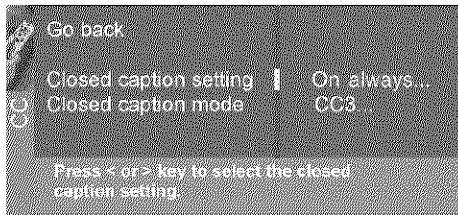

Closed Caption Many programs are encoded with closed-captioning information, which lets you display the audio portion of a program as text on the TV screen.

Closed captioning is not available on all channels at all times. Only specific programs encoded with closed-captioning information. When a program is closed captioned, *CC* is displayed in the channel banner. See Chapter 4 for more information about the channel banner. The closed caption options are:

Closed caption setting Lets you choose the way closed captioning information appears on the screen. The *Closed caption setting* does not effect the DVI-HDTV input.

Off No captioning information displayed.

On always Captioning information shown always, when available.

On when mute Displays captioning information, when available, whenever the TV's sound is muted by pressing the MUTE button. The captioning information is not displayed when the sound is not muted.

Closed-Caption Mode Displays a choice list that lets you choose which captioning mode is used for displaying captioning information. If you are unsure of the differences among the modes, you may prefer to leave the closed captioned mode set to CC1, which displays complete text of the program in the primary language in your area.

Autotuning Displays a choice list that lets you set up the TV to automatically tune to the correct input channel when you press a component button (VCR, DVD, AUX/HD or SAT/CABLE) on the remote. Go to Chapter 4 for details about the Autotuning feature.

Convergence The *Auto convergence* feature automatically adjusts the TV's tubes (this may take several minutes, after which you can make fine adjustments to the convergence settings); *Red convergence* displays the Red convergence screen, allowing you to use the arrow buttons to align the red and green images; *Blue convergence* displays the Blue convergence screen, allowing you to use the arrow buttons to align the blue and green images.

Using the Info Display

Your TV/DVD gives you many options when playing different types of discs. You can access these features through the on-screen Info Display.

To access the Info Display while a disc is playing, press INFO on the remote. The Info Display appears across the top of the screen. Each of the playback features is represented by an icon. To access a feature, use the arrow buttons on the remote to highlight the icon. Each feature that can be accessed from the On-Screen Info Display is described on the following pages. To clear the Info Display from the screen, press INFO on the remote control.

Note: The DVD Info Display is described on page 25.

Audio CD Info Display

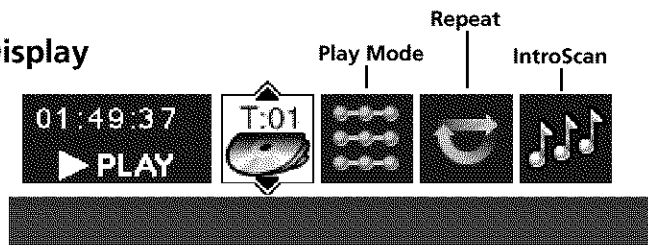

MP3 Info Display

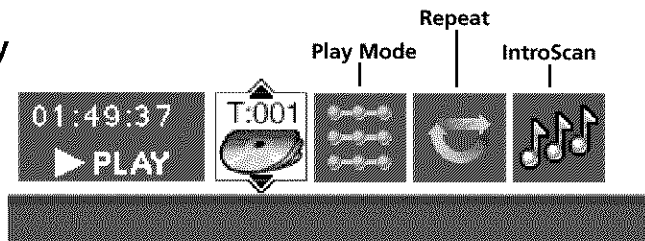

Video CD Info Display

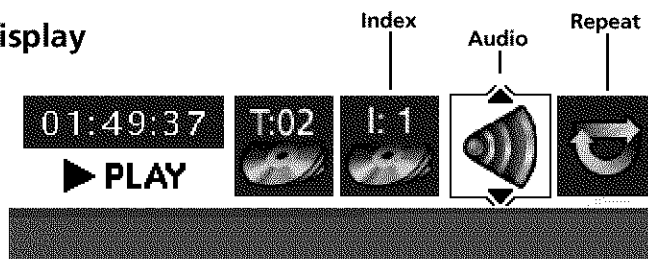

01:49:37

Using the Time Display

The Clock part of the Info Display shows the current disc time. To see the current disc time:

1. Press INFO on the remote (the Info Display appears).
2. Highlight the Clock icon. Press OK. The amount of time the track has played appears in the time window.
3. Press INFO to clear the screen.



Selecting a Specific Track

1. Press INFO on the remote.
2. Highlight the Track icon.
3. Use the number buttons on the remote to enter the track number you want to play, or use the up/down arrow buttons to scroll through the track numbers. You may need to press the OK button on the remote after you enter a single digit track number.

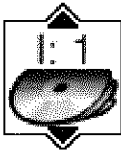

Selecting a Specific Index (Available only on Video CDs)

1. Press INFO on the remote.
2. Highlight the *Index* icon from the Info Display.
3. Use the number(s) on the remote to enter the index number you want to play, or use the up/down arrows to scroll through the index numbers. When a new index number is entered, that index will begin playing.

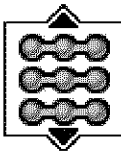

Selecting a Play Mode (Available only on Audio CDs and MP3s)

The Play Mode feature lets you set up the order in which you want the tracks on the disc to play. There are three options:

Standard: the tracks play in the order listed on the CD (starting with track 1). MP3 files are listed in the order they were recorded.

Random: the tracks on the disc play in random order.

Program: the tracks on the disc play in the order you've programmed. You must first create a program list in the *Play* menu of the DVD's main menu.

Switching between Standard and Random Play

Standard (the order listed on the disc) is the default setting for the DVD mode. To change the default setting:

1. Press INFO on the remote while a disc is playing. The Info Display appears.
2. Highlight the Play Mode icon. The current play mode appears in the text box underneath the icons. Press the up/down arrows to scroll through the choices until *Random* appears in the text box. The tracks on the disc will now play in random order.

Note: The TV/DVD defaults to Standard playback whenever you put a new disc into your TV/DVD.

Using the Program Play Feature

To use the Program Play feature, you must enter the order in which you want the tracks on the CD or MP3 to play by creating a program. This is done from the DVD's main menu.

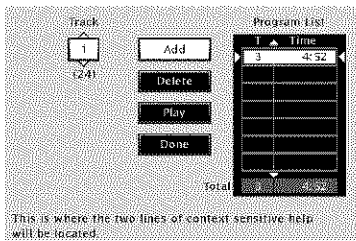

To edit a CD:

1. If the disc is playing, press STOP to stop playback (the DVD's main menu appears).
2. Highlight *Play Mode* and press OK (the *Play Mode* menu appears).
3. Highlight *Edit Program* and press OK (the *Edit Program* screen appears).
4. The *Track* box is highlighted. Use the numbers on the remote to enter the track you want to play first. The track number you entered appears in the *Track* box and the cursor highlights *Add*.
5. Press OK to add that track to the *Program List*. The cursor jumps to the next spot in the *Program List* section. Make sure the *Track* box is highlighted and enter your next track.
6. Continue adding tracks as explained in steps 4-5 until your program is complete. You can play your program by highlighting *Play* and pressing OK, or you can save the program by highlighting *Done* and pressing OK. If you save the program, you can select it from the Info Display. The program will be erased when you remove the disc or the TV/DVD is turned off.

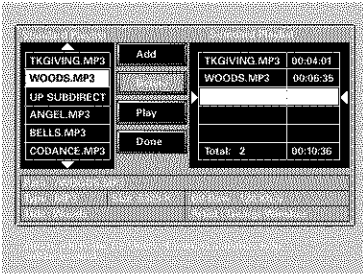

To edit an MP3 disc:

1. If the disc is playing, press STOP to stop playback (the DVD's main menu appears).
2. Highlight *Play Mode* and press OK (the *Play Mode* menu appears).
3. Highlight *Edit Program* and press OK (the *Edit Program* screen appears).
4. The *Standard Playlist* box is highlighted. Use the up/down arrow buttons on the remote to enter the track you want to play first.
5. Highlight *Add* to add that track to the *Program List* and press OK.
6. Continue adding tracks as explained in steps 4-5 until your program is complete. You can play your program by highlighting *Play* and pressing OK, or you can save the program by highlighting *Done* and pressing OK. If you save the program, you can select it from the Info Display. The program will be erased when you remove the disc or the TV/DVD is turned off.

Editing a Playlist

1. If the disc is playing, press STOP to stop playback. The DVD's main menu appears.
2. Highlight *Play Mode* and press OK (the *Play Mode* menu appears).
3. Highlight *Edit Program* and press OK (the *Edit Program* screen appears).
4. Highlight the item in the playlist you want to delete.
5. Highlight *Delete*, and press OK.
6. When you've rearranged the playlist and/or deleted all the tracks necessary, press OK.



Using the Repeat Feature

The default mode for the Repeat feature is Off. There are three Repeat options for Audio CDs:

- Disc – repeats the disc that is playing
- Track – repeats the track that is playing
- A•B – Set the beginning (point A) and the end (point B) to make this part of the CD play repeatedly.

To Use Repeat:

1. While a disc is playing, press INFO on the remote to bring up the Info Display.
2. Highlight the *Repeat* icon. The text in the text box below the icons will read *Repeat Mode: Off*.
3. Press the up/down arrows to scroll through the *Repeat* options until the option you want is displayed in the text box.
4. Press OK. The selected repeat option will loop repeatedly until you turn Repeat off. Repeat is turned off by completing steps 1 through 3 above, and selecting the *Off* option.

Information Displays

A•B Repeat (Available only on Audio CDs)

A•B Repeat lets you define a specific segment on the disc that you want to repeat:

1. Find the spot on the disc that is a few seconds **before** the beginning of the part you want to repeat (this gives you time to access the Info Display and the Repeat feature).
2. Press INFO on the remote and select the *Repeat* icon from the Info Display.
3. Press the up/down arrow buttons until the A•B Repeat option is shown in the text box underneath the icons. The text box reads *Repeat Mode: A-B Press OK to Set A Point*.
4. At the beginning of the part you want to repeat, press OK to set the A point.
5. When you get to the part of the disc that you want to be the end of the repeated segment (the B point), press OK. The segment will repeat until you turn Repeat off.
6. To make the Info Display disappear from the screen, press the INFO button on the remote.

How to Cancel Repeat

There are three ways to cancel Repeat:

- Press STOP twice.
- Go to the *Repeat* icon in the Info Display and select *Off*.
- Eject the disc.

Changing the Audio Channel Output (Available only on Video CDs)

If you are playing a stereo Video CD, you can change the channel output.

1. Press INFO on the remote to bring up the Info Display.
2. Highlight the *Audio Channel* icon on the Info Display.
3. The audio channel choices appear in the text box. Use the up/down arrow keys to scroll through the choices: *Stereo*, *Left*, *Right* or *Mono*. Whatever choice is displayed becomes the active choice.

Using IntroScan (Available only on Audio CDs and MP3s)

IntroScan plays the first ten seconds of each track on the CD. To use IntroScan:

1. Press INFO on the remote (the Info Display appears).
2. Highlight the *IntroScan* icon. Press OK. The first ten seconds of each track will play.
 - After IntroScan goes through all of the tracks, it stops.
 - If you want to stop IntroScan while it's in progress, press PLAY. The current track starts playing in its entirety.
 - You can also access IntroScan from the *Play Mode* menu in the DVD's main menu.

Troubleshooting

Most problems you encounter with your TV/DVD can be corrected by consulting the following troubleshooting list.

Note for US customers: If you prefer, we can provide you with the name of an Authorized Service Representative who will visit your home for a fee to install your electronic entertainment system and to instruct you in its operation. For details about this service, call 1-888-206-3359 or visit www.rcascenium.com.

DVD Problems

Player won't work

- Reset the TV/DVD by unplugging the AC power cord and plugging it back in.

Disc won't play

- Insert a disc with the label side facing up.
- Check the type of disc you put into the disc tray. This TV/DVD only plays DVD video discs, Video CDs, audio CDs and MP3s.
- If the disc is a DTS music CD, it requires a DTS decoder. If you have a DTS receiver hooked up to your TV/DVD and you are still not getting sound, make sure the sound is set correctly (see Chapter 5).
- Both the TV/DVD and the disc are coded by region. If the regional codes don't match, the disc can't be played. This TV/DVD is Region No. 1.

Play starts, but then stops immediately

- The disc is dirty. Clean it.
- Condensation has formed. Allow player to dry out.

No sound or distorted sound

- Make sure your TV/DVD is connected properly. Make sure all cables are securely inserted into the appropriate jacks.
- You may need to readjust the *Digital Output* settings from the *Sound* menu (see Chapter 5).
- Sound is muted during still, frame advance, or slow-motion play.
- If you connected an audio or audio/video receiver to your TV/DVD, make sure you chose the correct input setting on the receiver.

Can't advance through a movie

- You can't advance through the opening credits and warning information that appear at the beginning of movies because the disc is programmed to prohibit that action.

The icon appears on screen

- The feature or action cannot be completed at this time because:
 1. The disc's software restricts it.
 2. The disc's software doesn't support that feature (e.g., angles).
 3. The feature is not available at the moment.
 4. You've requested a title or chapter number that is out of range.

The picture is distorted

- The disc might be damaged. Try another disc.

Picture is distorted during forward and reverse scan

- It is normal for some distortion to appear while scanning.

A screen saver appears on the screen

- Your TV/DVD is equipped with a screen saver that appears on the screen after the DVD mode has been idle for several minutes. Press STOP or GO BACK on the remote to make the screen saver disappear from the screen and return to the DVD's main menu.

Subtitle and/or audio language is not the one selected from the initial setting

- If the subtitle and/or audio language does not exist on the disc, the initial settings will not be seen/heard. The disc's priority language is selected instead. Set the subtitle and/or audio language manually through the Info Display or the DVD's main menu.

The menu is displayed in a foreign language

- The Menu Language preference is set to that language. From the DVD's main menu, select the *Languages option* (In Spanish, shown as *Idiomas*; in French, as *Langues*). From the Languages menu, select the *Player Menus* option (In Spanish, shown as *Menús del Lector*; in French, as *Menus Lecteur*). Highlight the language you prefer and press OK.

No forward or reverse scan

- Some discs have sections that prohibit rapid scanning, or title and chapter skip.
- If you're trying to skip through the warning information and credits at the beginning of a movie, you won't be able to. This part of the movie is often programmed to prohibit skipping through it.

Continues on next page...

Other Information

Camera angle cannot be changed

- Some discs don't have the multi-camera angle system, and some discs only have it in certain parts of the movie.

Picture is too tall and thin

- Change the aspect ratio using the *TV Image* setting in the Display menu (see Chapter 5).

Picture is too short and wide

- Change the aspect ratio using the *TV Image* setting in the Display menu (see Chapter 5).

Cannot copy discs to video tape

- You can't record DVD discs onto videocassettes because the discs are encoded with anti-copy protection.

Full Version of Disc Does Not Play

- The DVD might be locked. To unlock, see Chapter 5.

Disc won't eject

- When you put a disc into the disc tray, it may take up to 15 seconds to read the disc. You won't be able to eject the disc during this time. Wait 15 seconds and try again.

I don't remember my password and I want to unlock the DVD

- If you forget your password, simultaneously press and hold OPEN/CLOSE and STOP on the TV/DVD's front panel for 3 seconds. Enter a new password via the *Lock* menu.

TV Problems

TV/DVD won't turn on

- Press the TV button.
- Make sure the TV/DVD is plugged in.
- Check the wall receptacle (or extension cord) to make sure it is "live" by plugging in something else.
- Something might be wrong with your remote control. Press the POWER button on the front of the TV/DVD. If the TV/DVD turns on, check the remote control solutions on the next page.
- The front panel controls may be locked (disabled). Use the remote control to unlock the front panel controls by selecting the *Front Panel Block* in the *Parental Control* menu and press OK to uncheck the box.
- The TV/DVD might be performing a periodic diagnostic check. Wait for a few minutes for the TV/DVD to turn on.

Buttons don't work

- If you're using the remote control, press the TV button first to make sure the remote is in TV mode.
- The front panel controls may be locked (disabled). Use the remote control to unlock the front panel controls by selecting the *Front Panel Block* in the *Parental Control* menu and press OK to uncheck the box.
- Unplug the TV/DVD for ten minutes and then plug it back in. Turn the TV/DVD on and try again.

TV/DVD turns off unexpectedly

- Sleep timer may have been activated. Go to page 46 for instructions.
- Electronic protection circuit may have been activated because of a power surge. Wait 30 seconds and then turn on again. If this happens frequently, the voltage in your house may be abnormally high or low.
- Unplug. Wait ten minutes. Plug in again.

TV/DVD turns on unexpectedly

- Wake up timer might have been activated. Go to page 46 for instructions.
- Auto on might have been activated. Go to page 47 for instructions.
- You might have pressed CH+, CH- or INPUT on the remote accidentally.

Blank screen

- Make sure the component connected to the TV/DVD is turned on.
- Try another channel.
- If you're trying to watch something that's playing on a component connected to the TV/DVD (like a VCR tape), press the TV button on the remote, then press INPUT until you get to the correct video input channel.

Can't select certain channel

- Make sure the remote control is in TV mode. Press the TV button and enter the channel number using the number buttons.
- Channel may be blocked or not approved in the *Parental Controls* menu.
- If using a VCR, check to make sure the TV/VCR button on the VCR is in the correct mode (press the TV/VCR button on your VCR).

No sound, picture okay

- Maybe the sound is muted. Try pressing the volume up button to restore sound.
- If using S-Video or Y, PB, PR, remember to also connect the component's left and right audio output jacks to the TV/DVD's L and R Audio Input jacks.
- If you're using the TV/DVD's internal speakers, make sure the INT/EXT switch on the back of the TV is put on "INT".
- The sound settings may not be set correctly. Go to page 43 for more information.

Noisy stereo reception

- May be a weak station. Use *Sound* menu to choose mono sound.

No picture, no sound but TV/DVD is on

- Maybe the cable/air function is set to the wrong position. Go to page 5 for detailed instructions.
- The channel might be blank — change channels.
- If you're watching your VCR and it's connected with coaxial cable to the CABLE/ANTENNA jack, tune the TV/DVD to channel 3 or 4 (whichever channel is selected on the 3/4 switch on the back of your VCR). Also check to make sure the TV/VCR button on the VCR is in the correct mode (press the TV/VCR button on your VCR).

Sound okay, picture poor

- Check antenna connections. Make sure all of the cables are firmly connected to the jacks.
- Try adjusting sharpness function to improve weak signals. Go to page 45 for more instructions.

Volume buttons not adjusting volume louder

- Check to make sure volume isn't limited by the maximum volume feature. Go to page 47 for more instructions.

Picture not moving

- You have activated the Freeze feature by pressing FREEZE or OK on the remote. Press any button to "unfreeze" the picture.

Black box appears on the screen

- Closed-captioning might be on. Check *Closed Caption* in the *Setup* menu. Go to page 48 for more instructions.

Freeze not working

- The freeze feature is not available for Component video (CMP1 or CMP2) or DVI inputs.

Low battery warning appears on screen

- Place new batteries in remote.

TV picture keeps switching between screen formats abruptly

- Switch the *Auto format* feature to *Off*. See page 45 for more information.

The Remote Control Doesn't Work

- Something might be between the remote and the remote sensor on the component. Make sure there is a clear path.
- Maybe the remote isn't aimed directly at the component (TV or VCR) that you're trying to operate.
- Maybe remote is not in TV Mode. Press the TV button so remote will control TV.
- Maybe batteries in remote are weak, dead, or installed incorrectly. Put new batteries in the remote. (Note, if you remove the batteries, you may have to reprogram the remote to operate other components.)
- Make sure there's nothing plugged into the WIRED IR jack on the TV/DVD's back panel. The remote that came with your TV/DVD won't work if anything is plugged into this jack.

Problems with V-Chip/Parental Controls

The rating limits don't work

- You must lock the settings. Go to the *MAIN MENU* (press MENU on your remote), select *Parental Control*, select *Lock Parental Controls*.

I don't remember my password and I want to unlock the TV

- If you forget your password, press MENU, then select *Parental Control* (the password entry screen appears). Simultaneously press and hold CH+ and VOL+ on the TV/DVD's front panel for 8 seconds. The Parental control menu appears on the screen, and you can re-enter a password via *Lock Parental Controls*.

The V-Chip won't let me watch a program even though it's not rated as violent.

- Maybe the movie was given an NR (Not Rated) status. After you block movie ratings, you must set *NR* to *View* separately in order to view movies with an NR rating.

Other Information

Explanation of Jacks (in alphabetical order)

This section describes the jacks you can use to make connections. There are several ways to connect components to your TV.



ANTENNA/CABLE Lets you connect a coaxial cable to receive the signal from the antenna, cable, cable box, or if using the examples on pages 5-11, a VCR.

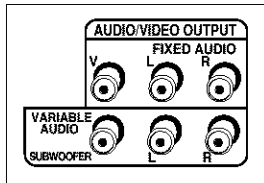

AUDIO/VIDEO OUTPUT Lets you connect an amplifier or audio receiver for improved sound quality or an external video monitor.

- **FIXED AUDIO L/R** Provides fixed-level audio output from the TV. This audio output is ideal for connecting an A/V receiver when you want to control the volume through the A/V receiver.
- **VARIABLE AUDIO** Provides variable-level audio output. Volume levels are controlled by the volume controls on the TV and remote control.
- **SUBWOOFER** Provides lower bass audio frequencies from the TV to a subwoofer.
Note: If you've connected a subwoofer, make sure you set the External Subwoofer option in the Sound menu. Go to page 43 for instructions.

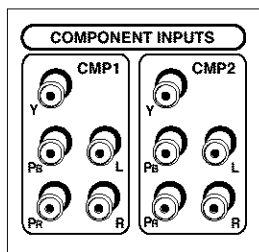

COMPONENT INPUTS Lets you connect a component video source, such as a VCR.

- **CMP1 Y PB PR (Component Video)** Provides optimum picture quality because the video is separated into three signals. Use three video-grade cables for the connection. When using CMP1 Y PB PR, make sure to connect left and right audio cables to the CMP1 L and R Audio Input jacks.
- **CMP1 L (Audio)** Provides left audio connection. The left audio connector is usually white.
- **CMP1 R (Audio)** Provides right audio connection. The right audio connector is usually red.
- **CMP2 Y PB PR, and L and R Audio** Allows you to connect a second component video source. Their description is the same as CMP1 above. When using CMP2 Y PB PR, make sure you connect the left and right audio cables to the CMP2 Audio jacks.

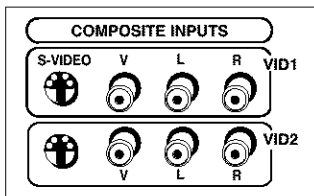

COMPOSITE INPUTS Lets you connect another component such as a VCR, DVD player, or laserdisc player. Its AUDIO jacks are the same as described for CMP1 above.

- **VID1 S-VIDEO** Provides better picture quality than the video jacks (VID1 and 2 Video) because the color part of the picture is separated from the black and white part of the picture. When using VID1 S-VIDEO, make sure to connect left and right audio cables to the VID1 L/MONO and R Audio Input jacks.
- **VID1 V (Video)** Provides composite video connection. The video connector is usually yellow.
- **VID2 S-VIDEO, V and L/MONO and R Audio** Allows you to connect a component such as a VCR, DVD player, or laserdisc player. Their description is the same as VID1 above.
Note: For each VID jack group (VID1 and VID2), you may connect either an S-Video or Video cable. Do not connect both at the same time in either of the VID jack groups.

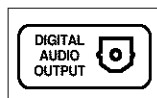

DIGITAL AUDIO OUTPUT Lets you connect a Dolby Digital receiver to your TV/DVD, if your receiver has an optical input. Use an optical cable (or SPDIF cable) to connect your TV/DVD to the receiver for theatre-quality sound. Go to page 41 for more information on digital audio.

Note: This TV/DVD's OPTICAL DIGITAL OUT jack fully complies with the international standard governing this type of jack (IEC958), and is designed for connection to a Dolby Digital (AC-3® or PCM) receiver or Dolby Digital (AC-3 or PCM) decoder. Older equipment, some of which is not fully compliant with IEC958, may not be compatible with the Dolby Digital bitstream. Such a connection using anything other than Dolby Digital AC-3 or PCM receiver or decoder could create a high noise level, causing damage to headphones or speakers.

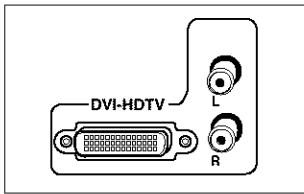

DVI-HDTV Input Lets you connect an HDTV Tuner with a DVI output.

- **DVI (Digital Visual Interface)** Provides an uncompressed, digital video interface developed for high-bandwidth digital connection. It supports the overlay of high-resolution graphics needed by some electronic program guide navigation and other interactive services. DVI, when combined with HDCP (High bandwidth Digital Content Protection) technology, creates a protected digital connection. The DVI-HDTV connection is designed to display either progressive scan (480p) or HDTV (1080i) signals at a bandwidth of up to 1.78 Gigabits per second.
- **L (Audio)** Provides left audio connection when using the DVI jack. The left audio connector is usually white.
- **R (Audio)** Provides right audio connection when using the DVI jack. The right audio connector is usually red.

Note: Remember to connect the left and right audio cables because the DVI cable carries only the picture signal, not the sound.

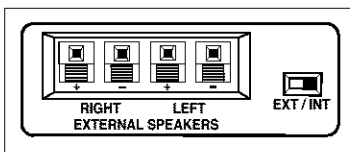

EXTERNAL SPEAKERS

- **Right and Left Speaker Terminals** Let you connect external left and right speakers to the TV to receive left and right sound.
- **EXT/INT (switch)** Lets you turn the TV's internal speakers on or off. EXT sends audio to external speakers only. INT sends audio to the TV's internal speakers only.



Wired IR This jack is for connecting a wired remote control system, which is primarily for professional installers. If you're using the remote that was included with your TV, don't plug anything into this jack.

Other Information

FCC Information

This equipment has been tested and found to comply with the limits for a Class B digital device, pursuant to Part 15 of the FCC Rules. These limits are designed to provide reasonable protection against harmful interference in a residential installation. This equipment generates, uses, and can radiate radio frequency energy and, if not installed and used in accordance with the instructions, may cause harmful interference to radio communications. However, there is no guarantee that interference will not occur in a particular installation. If this equipment does cause harmful interference to radio or television reception, which can be determined by turning the equipment off and on, the user is encouraged to try to correct the interference by one or more of the following measures:

- Reorient or relocate the receiving antenna.
- Increase the separation between the equipment and receiver.
- Connect the equipment into an outlet on a circuit different from that to which the receiver is connected.
- Consult the dealer or an experienced radio/TV technician for help.

This Class B digital apparatus complies with Canadian ICES-003.

Care and Cleaning

CAUTION: Turn OFF your TV/DVD before cleaning.

You can clean the TV/DVD as required, using a soft lint-free cloth. Be sure to occasionally dust the ventilation slots in the cabinet to help assure adequate ventilation.

The TV/DVD's screen may be cleaned with a soft, lint-free cloth as well. Take care not to scratch or mar the screen. If necessary, you may use a cloth dampened with warm water. Never use strong cleaning agents, such as ammonia-based cleaners, or abrasive powder. These types of cleaners will damage the TV/DVD.

While cleaning do not spray liquid directly on the screen, or allow liquid to run down the screen and inside the TV/DVD. Also, never place drinks or vases with water on top of the TV/DVD. This could increase the risk of fire or shock hazard or damage to the TV/DVD.

Caution: Using video games or any external accessory with fixed images for extended periods of time can cause them to be permanently imprinted on the picture tube (or projection TV picture tubes). ALSO, some network/program logos, phone numbers, etc. may cause similar damage. This damage is not covered by your warranty.

Handling Cautions

- Before connecting other components to this TV/DVD, be sure to turn all components off.
- Don't move the TV/DVD while a disc is being played. The disc may get scratched or broken, and the TV/DVD's internal parts may be damaged.
- Don't put any container filled with liquid or any small metal objects on the TV/DVD.
- Be careful not to put your hand into the disc tray.
- Don't place anything other than the disc in the disc tray.
- Exterior influences such as lightning and static electricity can affect normal operation of this player. If this occurs, turn the TV/DVD off and on again with the ON•OFF button, or disconnect and then reconnect the AC power cord to the AC power outlet. The TV/DVD will operate normally.
- Be sure to remove the disc and turn off the TV/DVD after use.

Formation of Condensation

- Due to sharp changes in temperature and humidity, condensation may form if warm air comes in contact with any cold parts inside the TV/DVD.
- When condensation forms inside the TV/DVD, it may not operate correctly. If this occurs, leave the TV/DVD at room temperature until the inside of the disc tray becomes dry and operational.
- If condensation forms on a disc, wipe the disc with a soft, dry cloth by moving the cloth from the center hole toward the outer edge.

SCENIUM by RCA HDTV Monitor/DVD Limited Warranty

What your warranty covers:

- Defects in materials or workmanship.

For how long after your purchase:

- One year from date of purchase for labor.
- One year from date of purchase for parts.
- Two years from date of purchase for the picture tube.

The warranty period for rental units begins with the first rental or 45 days from date of shipment to the rental firm, whichever comes first.

What we will do:

- Pay an Authorized Service Center the labor charges to repair your unit.
- Pay an Authorized Service Center for the new, or at our option, refurbished replacement parts and picture tube required to repair your unit.

How you get service:

- Call 1-866-SCENIUM and have your unit's date of purchase and model/serial number ready.
- A representative will troubleshoot your problem over the phone.
- If the representative determines that you should receive service, they will provide you with the name(s) of the Authorized Service Center in your area.
- Contact the Service Center and arrange for home or pick up, repair, and return service, provided that your unit is located within the geographic territory covered by an Authorized Service Center. If not, you must take your unit to the Service Center location at your own expense, or pay for the cost the Service Center may charge to transport your unit to and from your home.
- Proof of purchase in the form of a bill of sale or receipted invoice which is evidence that the product is within the warranty period must be presented to obtain warranty service. For rental firms, proof of first rental is also required.

What your warranty does not cover:

- Customer instruction. (Your Owner's Manual describes how to install, adjust, and operate your unit. Any additional information should be obtained from your dealer.)
- Installation and related adjustments.
- Damage resulting from non-approved installation methods.
- Signal reception problems not caused by your unit.
- Damage from misuse or neglect.
- Batteries.
- Images burnt onto the screen.
- A television that has been modified or incorporated into other products, or is used for institutional or other commercial purposes.
- A unit purchased or serviced outside the U.S.A.
- Acts of nature, such as but not limited to lightning damage.

Product Registration:

- Please complete and mail the Product Registration Card packed with your unit. It will make it easier to contact you should it ever be necessary. The return of the card is not required for warranty coverage.

Limitation of Warranty:

- **THE WARRANTY STATED ABOVE IS THE ONLY WARRANTY APPLICABLE TO THIS PRODUCT. ALL OTHER WARRANTIES, EXPRESS OR IMPLIED (INCLUDING ALL IMPLIED WARRANTIES OF MERCHANTABILITY OR FITNESS FOR A PARTICULAR PURPOSE) ARE HEREBY DISCLAIMED. NO VERBAL OR WRITTEN INFORMATION GIVEN BY THOMSON INC., ITS AGENTS OR EMPLOYEES SHALL CREATE A WARRANTY OR IN ANY WAY INCREASE THE SCOPE OF THIS WARRANTY.**
- **REPAIR OR REPLACEMENT AS PROVIDED UNDER THIS WARRANTY IS THE EXCLUSIVE REMEDY OF THE CONSUMER. THOMSON INC. SHALL NOT BE LIABLE FOR INCIDENTAL OR CONSEQUENTIAL DAMAGES RESULTING FROM THE USE OF THIS PRODUCT OR ARISING OUT OF ANY BREACH OF ANY EXPRESS OR IMPLIED WARRANTY ON THIS PRODUCT. THIS DISCLAIMER OF WARRANTIES AND LIMITED WARRANTY ARE GOVERNED BY THE LAWS OF THE STATE OF INDIANA. EXCEPT TO THE EXTENT PROHIBITED BY APPLICABLE LAW, ANY IMPLIED WARRANTY OF MERCHANTABILITY OR FITNESS FOR A PARTICULAR PURPOSE ON THIS PRODUCT IS LIMITED TO THE APPLICABLE WARRANTY PERIOD SET FORTH ABOVE.**

How State Law relates to warranty:

- Some states do not allow the exclusion nor limitation of incidental or consequential damages, or limitations on how long an implied warranty lasts, so the above limitations or exclusions may not apply to you.
- This warranty gives you specific legal rights, and you also may have other rights that vary from state to state.

If you purchased your unit outside the United States:

- This warranty does not apply. Contact your dealer for warranty information.

Service calls which do not involve defective materials or workmanship are not covered by this warranty. Costs of such service calls are the sole responsibility of the purchaser.

Other Information

Accessory Information

There are various accessories available to complement your HDTV Monitor. Prices are subject to change without notice. All accessories are subject to availability.

A shipping and handling fee will be charged upon ordering, and we are required by law to collect the appropriate sales tax for each individual state, county and locality to which the merchandise is being sent.

HOW TO ORDER

To place an order by phone, have your Visa, MasterCard or Discover Card ready and call the toll-free number listed below. Use this number only to place an order for accessory items.

1-800-338-0376

You can buy some accessories on-line at:

www.rca.com.

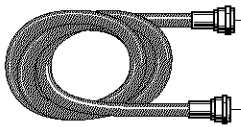

VH81 (3-ft), price: \$3.95
VH82 (6-ft), price: \$4.95

Screw-on Cable attaches to the round antenna connectors (called 75-ohm F-type) on the back of your VCR or TV. The ends screw onto the connectors for a secure connection.

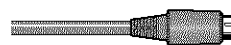

VH976 (6-ft.), price: \$7.95
VH913 (12-ft.), price: \$14.95

S-Video Cable has multi-pin connectors on each end for connecting S-Video components to your TV.

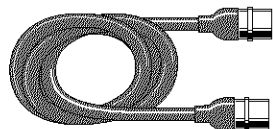

VH89 (6-ft.), price: \$5.95

Push-on antenna cable attaches to the round antenna connectors (called 75-ohm F-type). The ends push on for a quick connection.

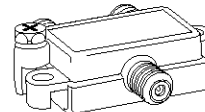

VH47, price: \$3.95

2-way Signal Splitter helps you connect to a second TV or VCR.

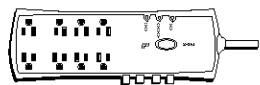

SCTV4000C,
price: \$49.95

Surge Protector provides eight outlets, coaxial and telephone line protection. Audible alarm for surge failure. \$100,000 Surge Equipment Guarantee.

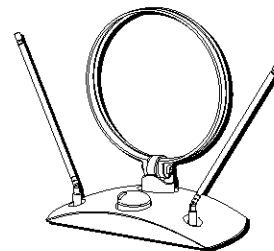

Amplified VHF/UHF/FM Antenna allows you to easily switch from the antenna signal to cable or satellite easily without disconnecting antenna.

ANT200, price: \$49.95

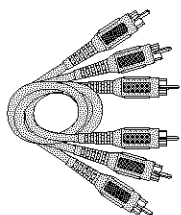

Gold-Tipped cable
DT6DC (6-ft), price: \$24.95
DT12DC (12-ft), price: \$34.95

Component Video Cables Triple cable used to connect a video source with Y, PR, PB jacks to the TV.

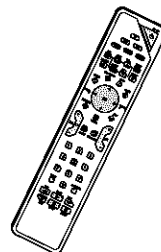

Remote Control This is the remote control that came packed with your TV. Replacements or spares can be ordered as needed.

261668, price: \$28.25



VH83 (6-ft., mono), price: \$5.95
VH84 (6-ft., stereo), price: \$9.95

Standard Audio/Video cable with RCA-type phono plugs.

A

A•B Repeat 27, 51
 Accessories 60
 Age-based ratings 32
 Amplifier 43
 Angle, camera 27
 Arrow buttons 16, 36
 Audio/Video
 cables 5, 60
 jacks 56, 57
 Audio CD
 creating a program 37
 playing 49
 Audio language 26
 Autoformat 45, 55
 Automatic code search 19
 AutoPlay menu 38
 Autotuning 28, 29, 48
 Auto channel search/update 47
 Auto convergence 48
 Auto on 47
 Auto skin tone 45
 AUX/HD button 16, 29

B

Balance 43
 Batteries 14
 Black level 45
 Buttons
 front panel 13
 remote control 16

C

Cables
 audio/video 5, 60
 coaxial 5, 60
 component video 5, 60
 S-Video 5, 60
 Camera angle 27
 Canadian V-Chip ratings 33, 34
 Care and cleaning 58
 Channel
 banner 28
 labels 15
 number 28
 search 15
 setup 47
 Channel Guide menu 46
 CLEAR button 16
 Closed captions 28, 48
 CMP1/CMP2 inputs 29
 Coaxial cable 5, 60
 Color warmth 45
 Commercial skip 17, 28
 Component buttons 17, 19,
 28, 48
 Component video cables 5
 Content themes 32, 33
 Contrast 45
 Contrast expand 44
 Convergence 48
 Curtain effect 47

D

Digital output 41
 Disc menu 25
 Display menu 41
 DVD
 button 16
 programming 37
 unrated titles 40
 DVI input 29

E

Edit Program menu 37
 Exempt programs 35
 EXT/INT switch 57
 External speakers 57

F

Film mode 45
 Fixed output 12
 Freeze 16, 55
 FRNT input 29
 Front panel
 block 35
 buttons 13
 inputs 13

H

Headphones 44

I

Info display 25, 49
 Inputs
 button 17, 22
 CMP1 and CMP2 29
 DVI 29
 FRNT 29
 VID1 and VID2 29
 Interactive setup 14
 INT Switch 57
 Invalid icon 25

J

Jacks 56
 ANTENNA/CABLE 29
 AUDIO R/L 56, 57
 component video 29, 56, 57
 DVI 29
 front 29
 S-VIDEO 29, 56
 video 29, 56

L

Language 14, 42, 47
 Learning feature
 adding a function 20
 clearing a function 21
 deleting all functions 21
 Lists and labels 15, 47
 Lock menu 39

M

Maximum TV volume 47
 Menu
 button 17
 channel guide 46
 display 41
 language 42, 47
 lock 39
 parental control 46
 picture 44, 45
 PIP 46
 play mode 37
 setup 47, 48
 sound 41, 44
 time 46
 Mute 17, 28

O

On-screen info display 25, 49
 ON•OFF button 17
 Optimized still picture 45

P

Parental control 28, 30
 lock/unlock 35
 menu 46
 problems 55
 Password 39, 55
 Picture menu 44
 Picture presets 45
 PIP (Picture-in-picture) 36
 button 17, 36
 channel 46
 menu 46
 Playback features
 audio language 26
 camera angle 27
 repeat 27, 51
 Play Mode menu
 program play 37
 random play 37
 standard play 37
 POP (Picture-outside-picture)
 17, 36, 46
 Preferences 47
 Program
 creating audio CD 37
 DVD disc 37
 editing 38

R

Rating limits 39
 problems 55
 Remote control
 backlight 17
 batteries 55
 buttons 17
 codes 22, 23
 learning feature 20
 problems 55
 programming 18
 replacement 60

use 19
 Repeat 27, 51
 Reverse 3:2 pulldown 45

S

S-Video
 cable 5, 60
 jack 29, 56
 SAT/CAB button 17, 29
 Scan velocity modulation 44
 Screen format 28, 45, 55
 Second audio program (SAP)
 28, 43
 Setup menu 47, 48
 Sharpness 45
 Signal type 47
 SKIP button 17, 28
 Sleep timer 17, 46
 Sound
 menu 44
 mode 43
 settings 43
 type 43
 Sound logic 44
 Sound menu 41
 Stereo 28, 43, 55
 Subwoofer 43
 SWAP button 17, 36

T

Time 28, 46
 Tint 45
 Title 25
 Troubleshooting 53, 55
 TV button 17
 TV Image menu 41
 TV problems 54

U

Unrated programs 35
 US V-Chip ratings 30, 31, 35

V

V-Chip 30, 31
 Canadian ratings 34
 movie rating limit 35
 problems 55
 US ratings 35
 Variable output 12, 56
 VCR
 Button 17, 29
 Video input jacks
 VID1/VID2 29
 Video noise reduction 45
 Volume punchthrough 21

W

Wake up timer 46

Z

ZOOM button 17, 36

Visit the RCA Scenium website at www.rcascenium.com

Please do not send any products to the Indianapolis address listed in this manual or on the carton. This will only add delays in service for your product.

**Thomson Inc.
10330 North Meridian Street
Indianapolis, IN 46290**

©2003 Thomson Inc.
Trademark(s)® Registered
Marca(s) Registrada(s)
Printed in USA
TOCOM 16266190

