

DIGITAL WIRELESS CAMERA AND LCD MONITOR SYSTEM

INSTRUCTION MANUAL



MODEL: CMD6537ML

CAMERA MODEL: CA650ML

MONITOR MODEL: M370ML

Overview

Video Monitor

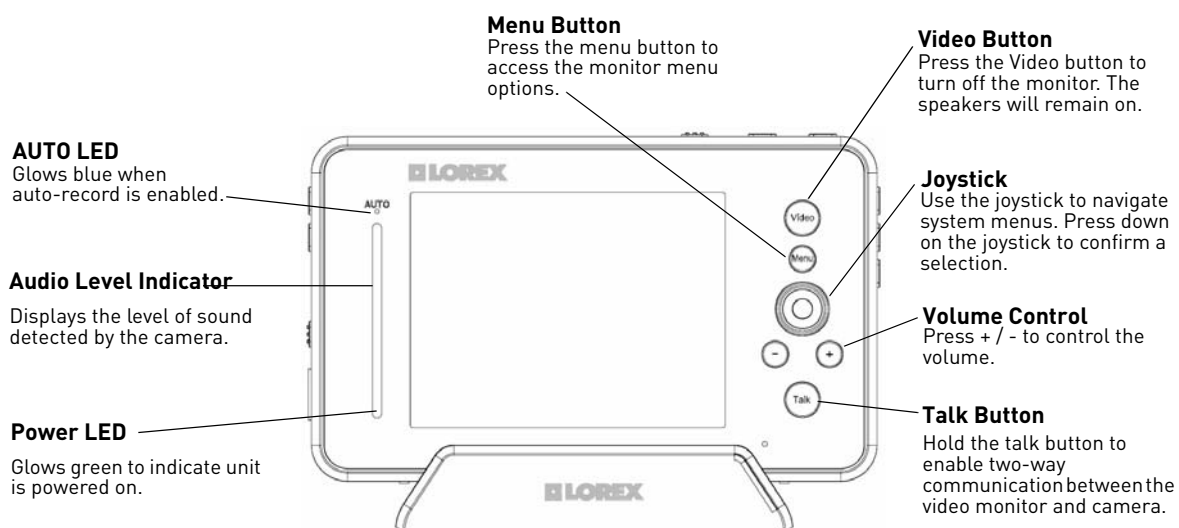
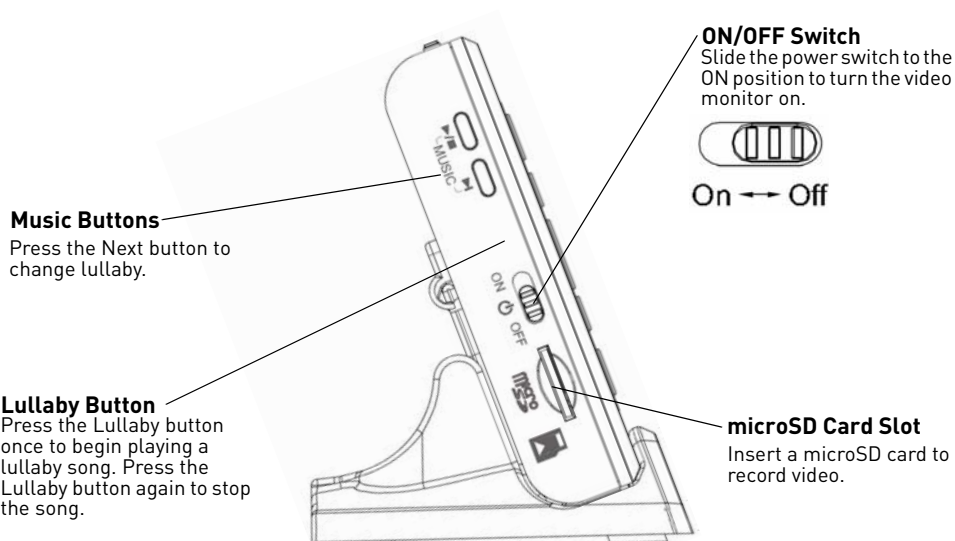

Video Monitor (continued)

Cam Button

Press the Cam button to switch between channels 1-4.

Sequence/ Quad Button

Press the Sequence/Quad button to view video in quad mode (4 screen split view), or in sequence view.

Power Port

Connect the power adapter labeled "For Monitor" into the power port.

Scan Button

Scans for cameras that detect sudden noises.

Micro USB

Connect a micro USB cable (included) between the video monitor and a computer to view video from your PC or remotely (setup required)

Charging LED Indicator

Glow red to indicate video monitor is charging.

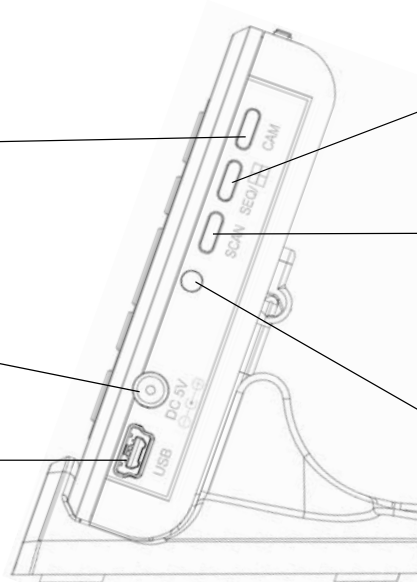

Antenna Switch

Slide the Antenna Switch towards the unlock position to reveal the antenna.

Speaker

Outputs sound received from the camera.

Power Port (DC5V)

Connect the power adapter labeled "For Monitor" to the charging cradle.

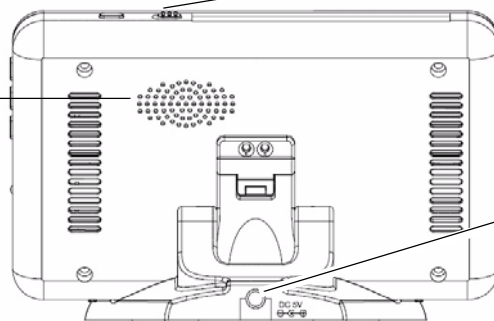

How to use the joystick in menus

The joystick allows you to navigate through the video monitor menus.

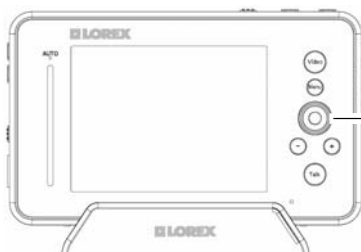

OK Button

Press down on the joystick to confirm a selection.





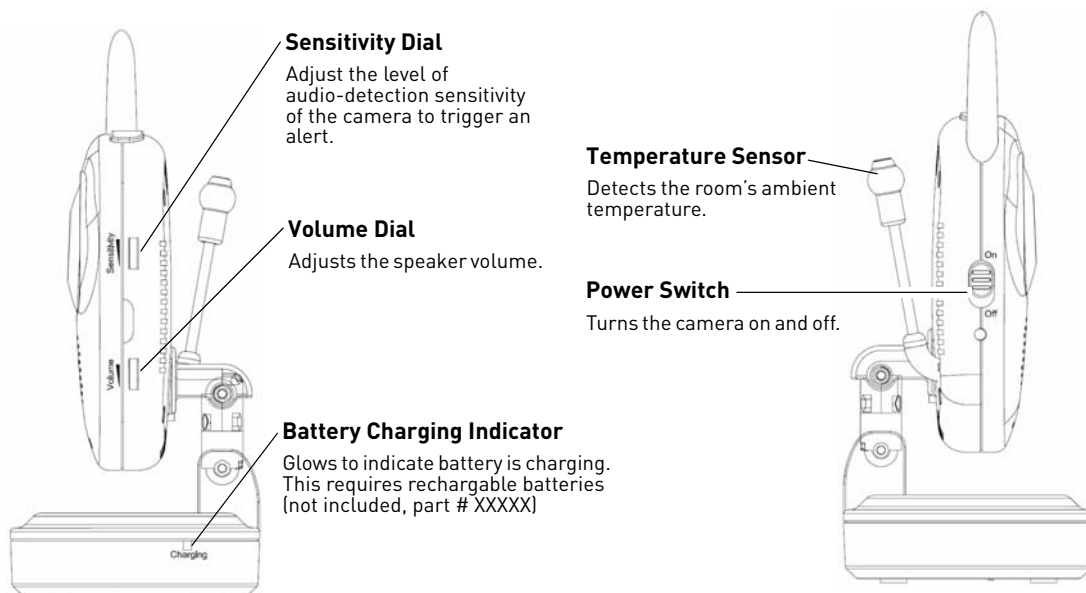
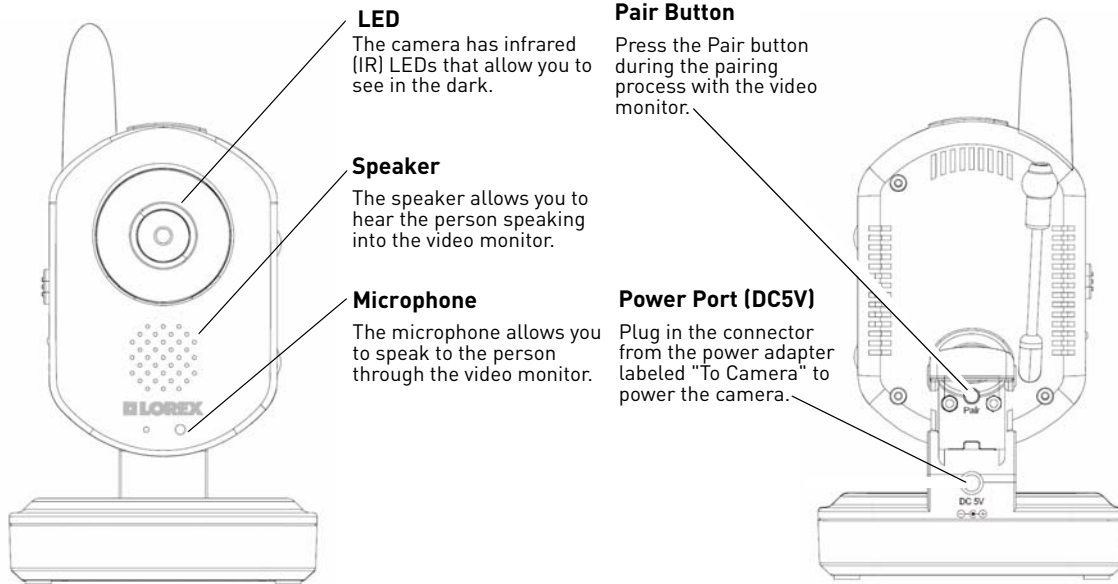









Press up, down, left, or right to navigate through the menus.

Camera Overview



OSD overview

The video monitor displays the following icons during normal use. The table below summarizes the video monitor icons, and what they mean.

Icon	Meaning
	No signal between the camera and video monitor.
	Full signal between the camera and video monitor.
	
	
	
	
	The camera night light is currently on.
	The video monitor battery is low.
	
	
	
	Auto recording is enabled.
	Manual recording is enabled.
	
	Two-way talk is enabled. You can now speak into the video monitor.

Have factory confirm which icons will be included, and what each icon means.

Basic Setup

Using the cable clips

Included are a bag of cable clips that allow you to manage the wires from the power adapters. **It is highly recommended that you use the cable clips keep the power cords out of reach from young children and infants.**

To use the cable clips, slide the wires in between the clips, then peel the protective film behind the clip. Stick the clip along the wall /table leg so that it is out of reach.

line art of cable clip from vince
- diagram with cable setup around baby
crib

Safety percautions?

Optional: Charging the camera

The camera base has a built-in battery compartment where you can install three AA batteries. This may be useful if you want to temporarily monitor an area with no power outlets.

To install batteries in the camera:

- 1 Unplug the power cord from the base of the camera.
- 2 Remove the battery cover.
- 3 Insert three AA batteries into the battery compartment and replace the battery cover.

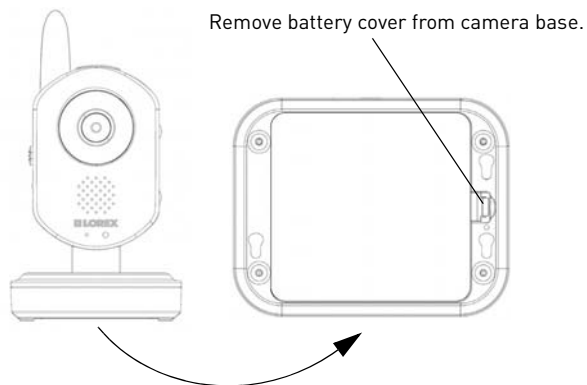

NOTE: You can insert rechargeable batteries into the camera base. Connect the power adapter into the camera base to charge the batteries. Charge the batteries for **4.5** hours for a full charge.

NOTE: To order rechargeable batteries, contact Lorex customer support at XXXXXXX and inquire about part number XXXXXX.

To charge the camera battery:

- 1 Insert 3 AA batteries into the battery compartment.
- 2 Plug the power adapter labeled "For Camera" into a power outlet.
- 3 Connect the end of the power adapter into the port labeled DC5V.

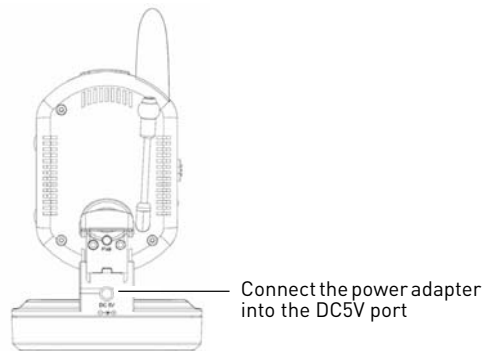

Charging the video monitor

The video monitor can be charged using the cradle, or directly through the DC5V port on the side of the video monitor. The batteries stop charging once it is full. You will not "over-charge" the batteries. **A full charge requires 4.5 hours.**

To charge the video monitor using the cradle:

- 1 Connect the power adapter labeled "To Monitor" to a power outlet.
- 2 Connect the end of the power adapter into the charging cradle.
- 3 Rest the video monitor on the charging cradle, ensuring the metal contacts touch.

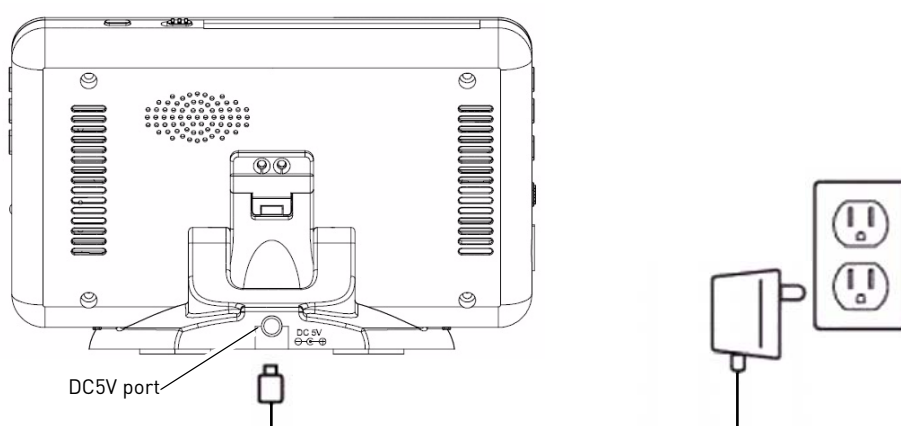

To charge the video monitor without the cradle:

- 1 Connect the power adapter labeled "To Monitor" to a power outlet.
- 2 Connect the end of the power adapter into the **DC5V** port on the video monitor.

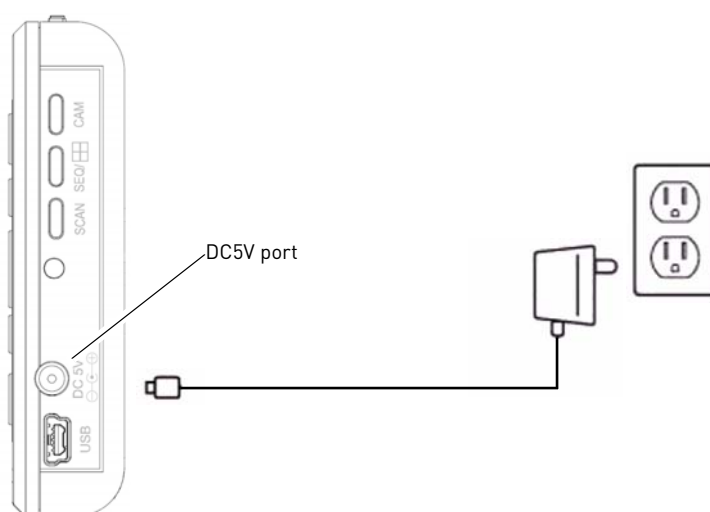

Viewing your camera

To view your camera:

- 1 Connect the camera and video monitor to a power source.
NOTE: The power adapters are labeled "For Camera" and "For Monitor"
- 2 Slide the power switch to the **ON** position on the camera and video monitor. The video monitor will automatically scan for cameras in range.

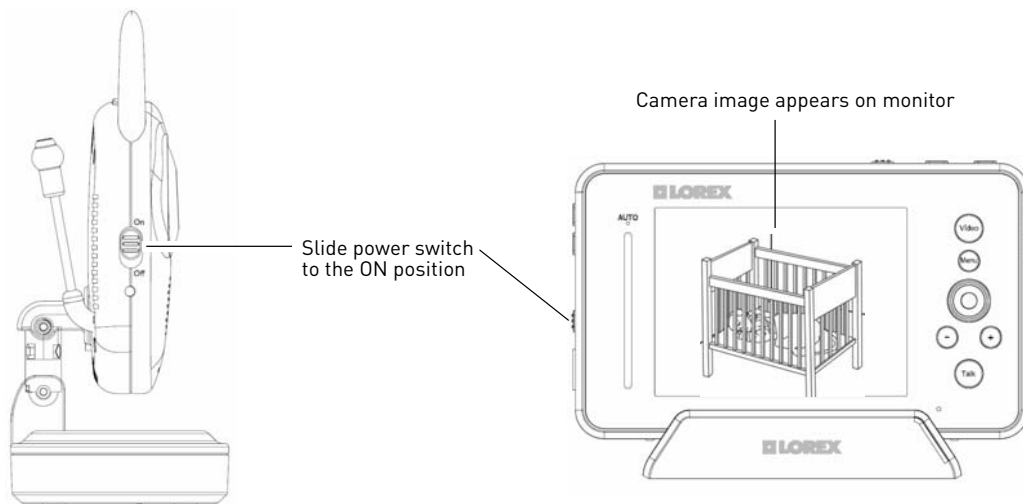

Testing your setup

It is recommended that you test your camera setup so that you get the best picture and sound quality from your video monitor.

Test the camera and video monitor reception:

- 1 Place the camera and video monitor in two different rooms.
- 2 Have one person monitor the signal strength on the video monitor.
- 3 Have a second person move the camera in different locations of the room. The person holding the video monitor can direct the person holding the camera, if the signal strength is low or high.

Test the camera volume level:

- 1 Place the camera and video monitor in two different rooms. Have a person in each room.
- 2 Have a person with the video monitor press and hold the **TALK** button to confirm the volume level from the camera. Adjust the volume dial on the camera as required.
- 3 The person holding the video monitor can determine if the camera needs to move to a different location of the room for better sound quality.

Camera Setup

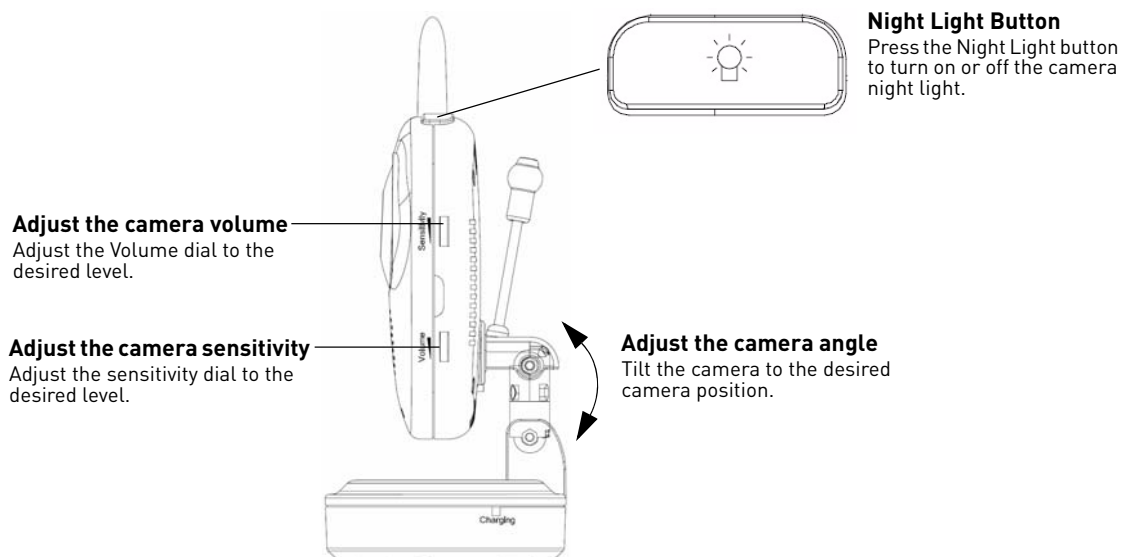

Adjusting the camera sensitivity

The camera's Sensitivity dial allows you to adjust how sensitive the camera is in detecting ambient sounds. For example, if the camera detects the sound of a baby crying, the video monitor beeps.

To adjust the camera's sensitivity level:

- Scroll the Sensitivity dial on the side of the camera towards the **+** symbol for increased sensitivity. Scroll the dial towards the **-** symbol for reduced sensitivity.

Adjusting the camera volume

The camera's speaker volume can be adjusted to the desired level. Scroll the dial towards the **+** symbol to increase the volume. Scroll the dial towards the **-** symbol to reduce the volume.

Turning on the camera night light

- Press the night light button on the top of the camera to turn the night light on or off. The night light button glows when the night light is on.

Monitor Setup

Unlocking the monitor antenna

The monitor has a built-in antenna that improves signal range. It is recommended that you extend antenna for optimal performance.

To unlock the monitor antenna:

- Slide the lock button to the right.

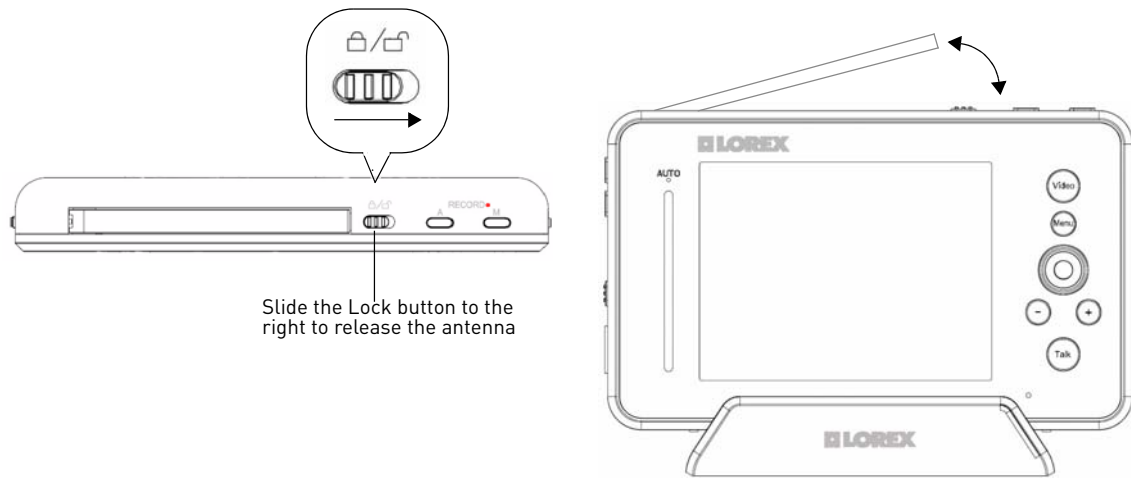

Reading the power indicator LED

The power indicator LED glows green when the monitor is powered on. When the monitor is turned off, or is out of batteries, the power indicator LED turns off.

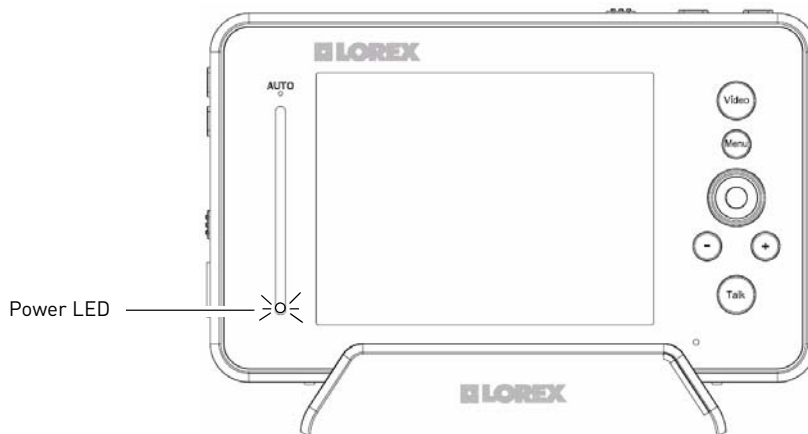

Pairing one camera

The camera included with the monitor has already been paired up with the video monitor. If for any reason your monitor and camera are not paired up, follow the directions below.

To pair a camera to the video monitor:

- 1 Place the camera and video monitor 12 inches apart. Turn on the camera and the video monitor.
- 2 Press the **Menu** button on the monitor, then select **Pairing** and press the **OK** button.
- 3 Select **Camera 1**, and press the **OK** button.
- 4 Press the **Pair** button behind the camera within 30 seconds.

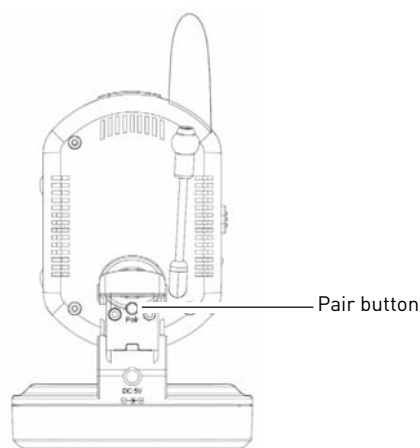

Pairing multiple cameras

You can add a maximum of four (4) wireless cameras to a video monitor (model # LW2401 AC1, LW2451 AC1).

To pair multiple wireless cameras to the video monitor:

- 1 Press the **Menu** button on the video monitor.
- 2 Select **Pairing** and then press the **OK** button.
- 3 Select the desired channel number you wish to pair (i.e. Channel 2) and press the **OK** button.

NOTE: Each camera must be assigned to a different channel.
- 4 Turn on the camera you wish to add, and then press the **Pair** button behind the camera within 30 seconds.
- 5 Repeat for the remaining cameras, selecting a different channel number (i.e. Channel 3) in the Pairing menu.

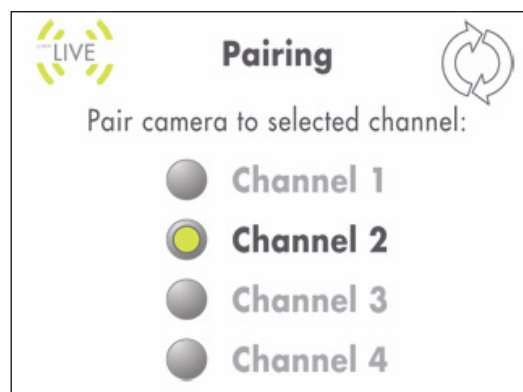

Viewing Multiple Cameras

You can view all of the connected cameras in quad view or sequence view. The video monitor supports a maximum of four cameras.

To view multiple cameras in quad view:

- Press the **SEQ/Quad** button on the video monitor.

To exit quad view:

- Press the SEQ/Quad button repeatedly to exit Quad mode.

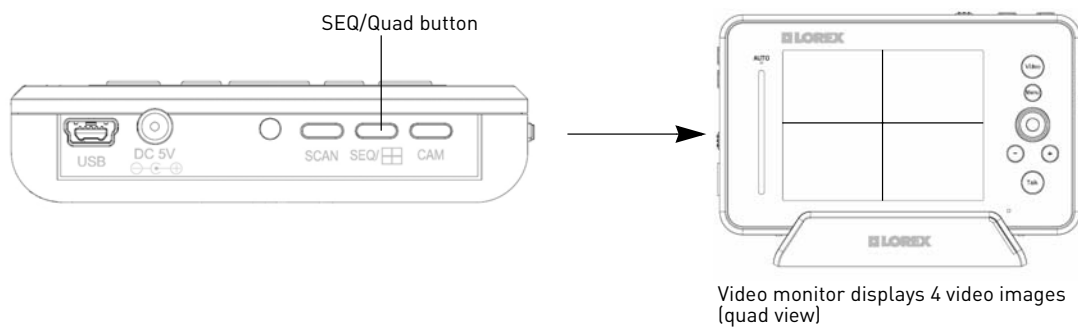

Sequence View

In sequence view, the monitor switches between the four channels every six seconds. For example, the monitor displays channel 1 for six seconds, then channel 2 for six seconds etc.

To enable Sequence view:

1

Using the talk function

The talk function allows you to speak into the video monitor, while the camera outputs your voice. The camera also has a built-in mic, which allows the person to speak into the camera.

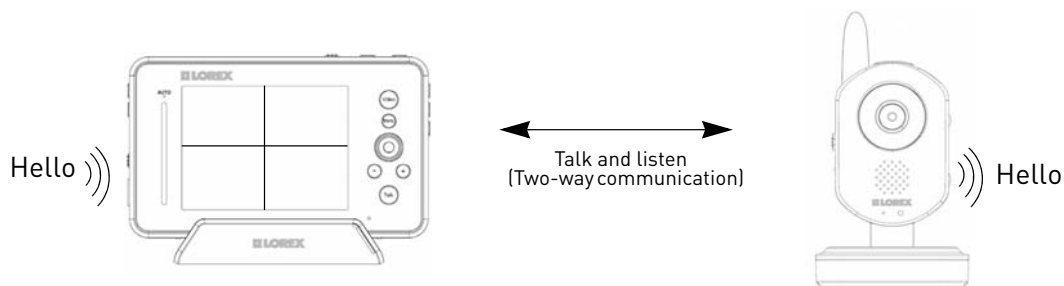

To use the talk function:

- 1 Adjust the Volume dial on the camera and video monitor to the desired level.
- 2 Press and hold the **Talk** button on the video monitor and begin speaking. Release the Talk button when you are finished.

NOTE: You must release the Talk button on the video monitor in order to listen to the audio from the camera.

Lullaby

The Lullaby feature allows the camera to play musical tunes.

To configure the lullaby feature:

- Press the **Lullaby** button to begin playing a lullaby on the camera.
- Press the **Next** button to change the tune.
- Press the **Lullaby** button to stop the lullaby.

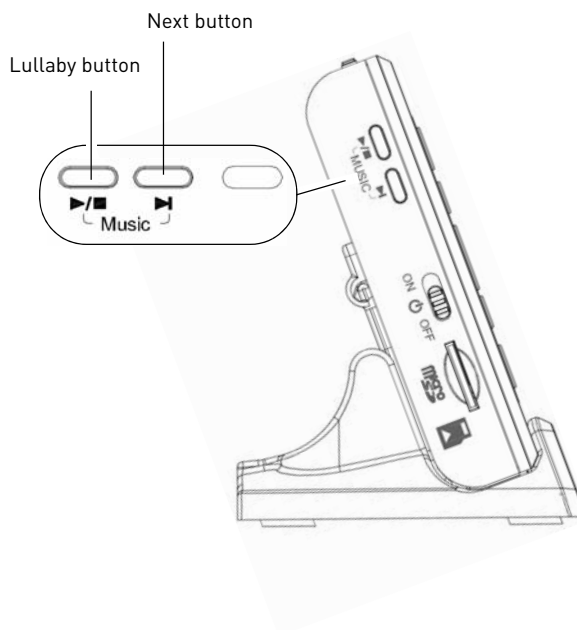

Using the Scan feature

The Scan feature temporarily turns off the video monitor, and waits for a camera to detect noise. Once a noise triggers the camera, the video monitor automatically turns on, and beeps to notify you.

To enable the Scan feature:

- Press the **Scan** button.

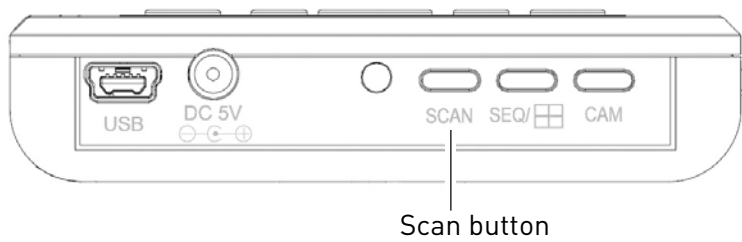

Recording

This system is capable of recording video on a microSD card. **A microSD card is included** so you can begin recording right away.

Use the table below to help you estimate recording times on various sizes of SD cards. Times are shown in hours, minutes, and seconds.

microSD Card Capacity	Recording Time (Hour:Minute:Second)
512 MB	1:20:22
1 GB	2:32:05
2GB	5:02:47
4GB	10:15:24
8GB	17:58:28
16 GB	34:54:25
32 GB	60:10:13

NOTE: Estimated recording times based on tests using Kingston brand SD cards. There may be a slight variatino when using different brands of memory.

Manual Recording & Auto Recording

Prerequisite:

- Insert a microSD card into the microSD slot in the video monitor.

NOTE: The video monitor supports microSD cards up to 32 GB (gigabytes).

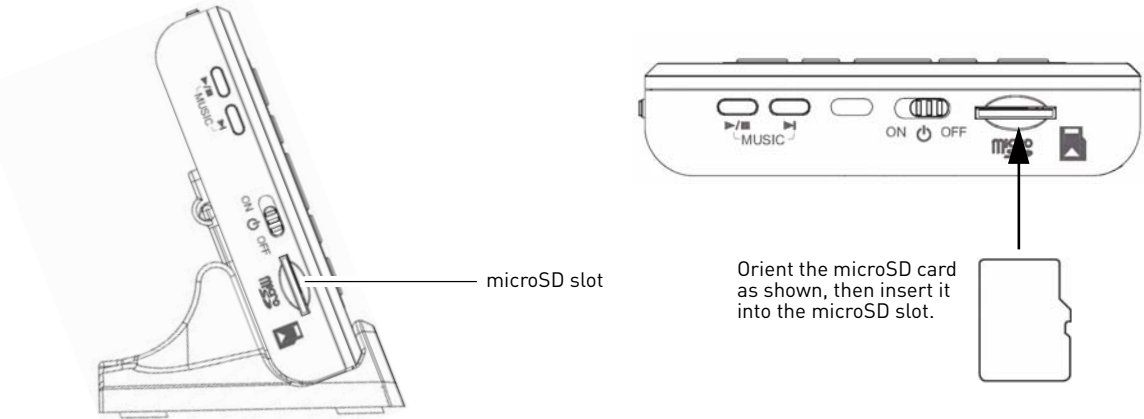

Manual Recording

Manual recording allows you to record video by pressing the record button on the video monitor. Manual recording may be useful if you want to quickly record an event to your video monitor while you are watching it.

To start manual recording:

- 1 Press the **M** button on top of the video monitor. The video monitor begins recording.

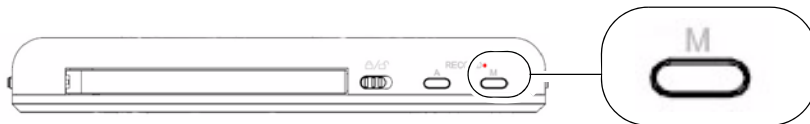

- 2 Press the **M** button again to stop recording.

- The file is saved and a  icon appears to indicate the recording has been saved.

Auto Recording

Auto Recording allows the video monitor to record only when the camera detects a sound. For example, if you are monitoring a sleeping baby, the video monitor will not record until the baby's cry triggers the camera.

Prerequisites:

- Adjust the sensitivity level on the Camera to the desired level.
The greater the sensitivity, the more sensitive the camera is to noise. This means that the slightest sound will cause the video monitor to record.

To enable Auto Recording:

- Press the **A** button on top of the video monitor. The video monitor turns off, and the AUTO LED glows blue. When the camera detects a sound, the video monitor begins to record.

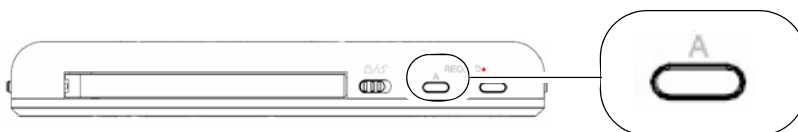

NOTE: By default, the video monitor records for X seconds after it detects sounds.

- how long does the video monitor record for after a noise? 5~30 seconds as set from the "Trigger Record" menu?

-max recording during auto recording is 10 consecutive minutes (if there is constant sound).

Viewing recorded files on the microSD memory card

There are two ways that you can view the recorded video files on the microSD memory card: through the video monitor, or on your computer.

To view video files through the video monitor:

- 1 Press the **OK** button on the video monitor (press down on the joystick). The File List menu opens.

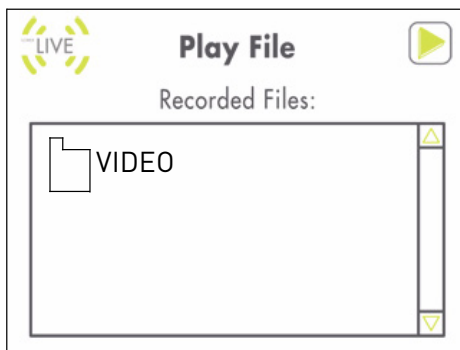

- 2 Press **OK** to open the VIDEO folder.
- 3 Select the desired folder and press the **OK** button.

NOTE: The folders are named by the year, month, and date. For example, a folder named **110204** means that the folder was created in 2011, February (02), on the 4th.

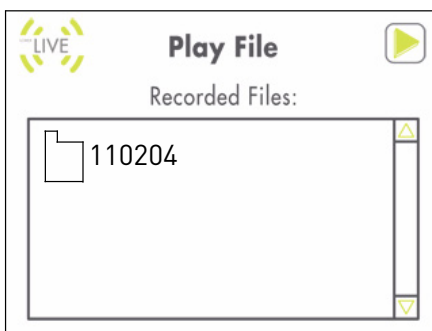

- 4 Select the desired video file you wish to view, and press the **OK** button to begin playback.

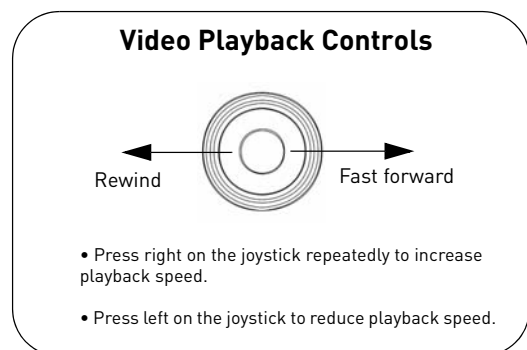
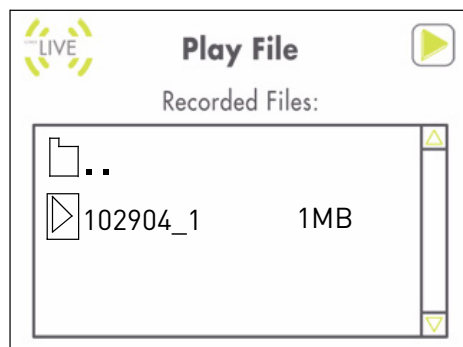

To view video files on your computer:

- 1 Press down on the microSD card with a small rigid object (i.e. finger nails) to remove the memory card.

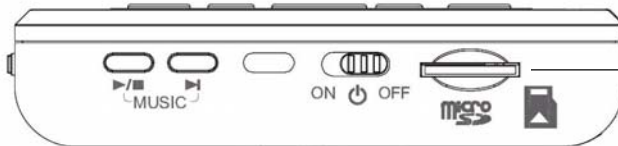

Push the microSD card to eject

- 2 Insert the microSD card into a memory card reader (not included).

NOTE: If required, use the included SD card adapters to convert the microSD card to SD/HCSD.

- 3 When the AutoPlay menu appears, click on "Browse Folders.."

- 4 Double-click the VIDEO folder, then select the desired sub-folder you want to open.

NOTE: The folders are named by the year, month, and date. For example, a folder named **110204** means that the folder was created in 20**11**, February (**02**), on the **4**th.

- 5 Double-click the desired video file to begin playback.

Configuring your video monitor

Enabling the Auto Mute feature

The Auto Mute feature eliminates white noise when monitoring a room. The Auto Mute feature works by muting the video monitor when the camera detects silence. Once the camera detects a sound, the video monitor begins to play sound again.

To enable Auto Mute:

- 1 Press the **Menu** button on the video monitor.
- 2 Select **Auto Mute** () and press **OK**.
- 3 Select **ON** to enable auto mute.
- 4 Press the **OK** button to save your settings.

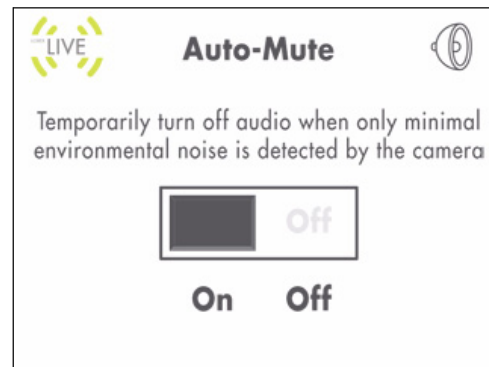

Enabling the Overwrite Feature

The Overwrite feature allows the video monitor to continuously record on the microSD card. When the microSD card is full, the video recordings begin to overwrite the first video entry (first in first out).

To enable the overwrite:

- 1 Press the **Menu** button on the video monitor.
- 2 Select **Record** () and press **OK**.
- 3 Select **File Overwrite** and press **OK**.
- 4 Select **Yes** and press the **OK** button to save your settings.

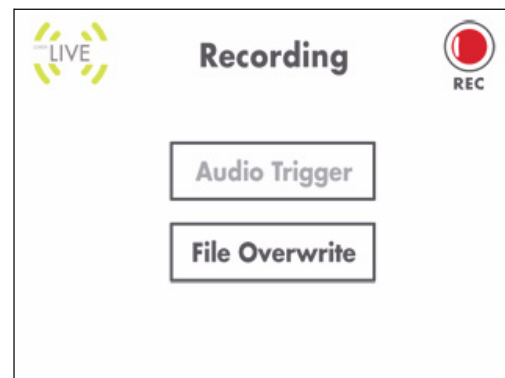

Changing the date and time

To adjust the video monitor's date and time:

- 1 Press the **Menu** button on the video monitor.
- 2 Select **Settings** () and then press the **OK** button.
- 3 Select **Date & Time** and then press the **OK** button.
- 4 Use the joystick to configure the Year, Month, and Date.
 - Press up/down on the joystick to adjust the values.
 - Press left/right to move between the year, month, and date.
- 5 Press the **OK** button to save your changes.

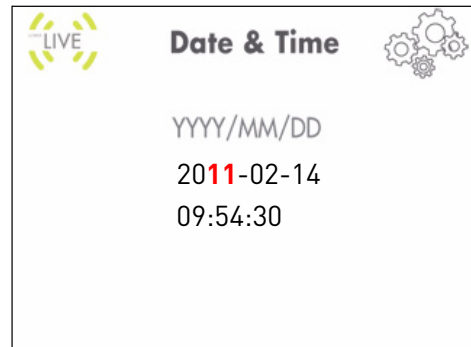

Adjusting the alarm volume

The video monitor 'beeps' when the camera detects motion (?). You can adjust the alarm volume.

To change the video alarm volume:

- 1 Press the **Menu** button on the video monitor.
- 2 Select **Settings** () and then press the **OK** button.
- 3 Select **Alarm Volume** and then press the **OK** button.
- 4 Press left and right on the joystick to adjust the alarm volume.
- 5 Press the **OK** button to save your settings.

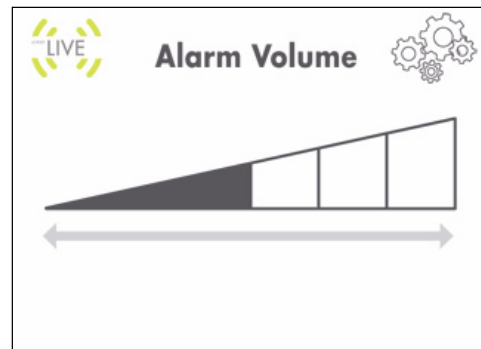

Adjusting the screen brightness

To adjust screen brightness:

- 1 Press the **Menu** button on the video monitor.
- 2 Select **Settings** () and then press the **OK** button.
- 3 Select Brightness and then press the **OK** button.
- 4 Press left and right on the joystick to adjust the screen brightness.
- 5 Press the **OK** button to save your settings.

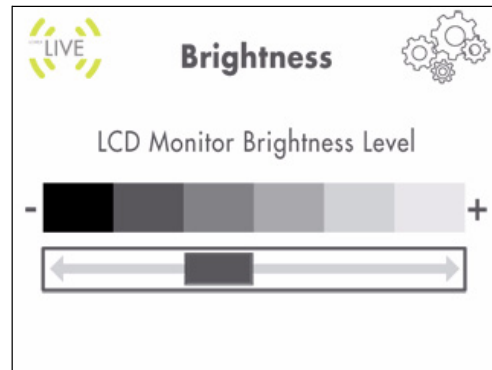

Adjusting the Timer settings

The timer feature allows the video monitor to beep after a set duration as a reminder tool.

To enable the Timer:

- 1 Press the **Menu** button on the video monitor.
- 2 Select **Settings** () and then press the **OK** button.
- 3 Select **Timer** and then press the **OK** button.
- 4 Select **ON** and then press the **OK** button.
- 5 Select **Repeat Interval** and press the **OK** button.
- 6 Enter the desired time that you want the set the timer at using the joystick. Press left / right to navigate the values. Press up/down to adjust the values.
- 7 Press the **OK** button to save your settings.



Screenshot of timer screen

Configuring the temperature alert range

The camera has a built-in temperature sensor. You can configure the video monitor to alert you through beeps, when the temperature falls above, or below a temperature range.

To configure the temperature alert range:

- 1 Press the **Menu** button on the video monitor.
- 2 Select **Settings** () and then press the **OK** button.
- 3 Select **Temp. Alert Range** and then press the **OK** button.
- 4 Using the Joystick, press Up/Down to change selection, left/right to adjust the values:
 - Beside Low Temperature, enter the lowest room temperature the camera should detect.
 - Beside High Temperature, enter the highest room temperature the camera should detect.
- 5 Select the **ON** button and then press the **OK** button on the joystick.

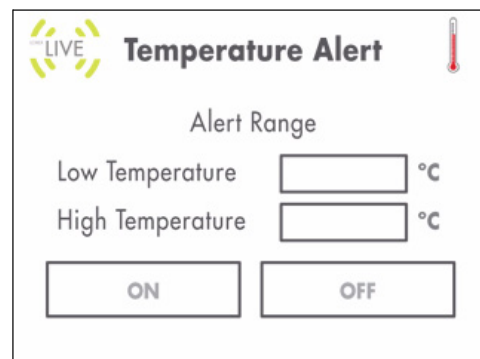

Adjusting the temperature unit of measurement

You can change the video monitor to display temperature in Fahrenheit (F) or Celsius (C).

To change the unit of measurement:

- 1 Press the **Menu** button on the video monitor.
- 2 Select **Settings** () and press the **OK** button.
- 3 Select **Temp. Display** and press the **OK** button.
- 4 Select either **C** for Celsius or **F** for Fahrenheit.
- 5 Press the **OK** button to save your settings.

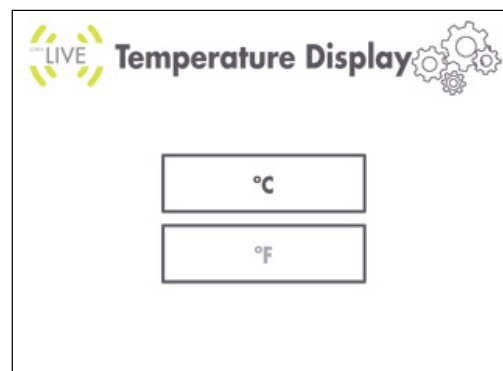

Erasing the memory card

Once you erase the memory card, the video will be deleted **permanently**.

To erase the memory card:

- 1 Press the **Menu** button on the video monitor.
- 2 Select **Settings** () and then press the **OK** button.
- 3 Select **Format memory** and then press the **OK** button.
- 4 Select **Yes** and then press the **OK** button to erase the memory card.
 - The message "Format OK" appears to confirm that the card has been erased.

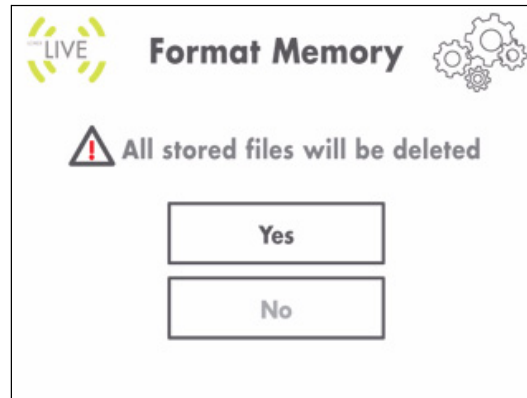

Restoring default settings

Restoring your video monitor settings reverts the settings you made to the factory settings.

To restore the video monitor factory defaults:

- 1 Press the **Menu** button on the video monitor.
- 2 Select **Settings** () and then press the **OK** button.
- 3 Select **Factory Reset** and then press the **OK** button.
- 4 Select **Yes**, and then press the **OK** button.



Viewing your cameras using Skype

Connecting to your video monitor through Skype is a convenient method to view your cameras from anywhere with an internet connection.

How it works

The laptop connects to the Skype server. The Skype server is connected to your computer. Your computer connects to the video monitor, which captures video from the camera.

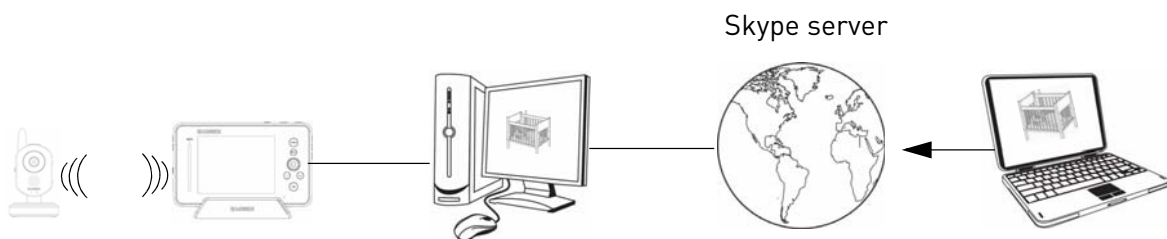

Prerequisites

- A PC (Macs currently not supported)
- High speed internet connection

Step 1 of 3: Installing the camera drivers

You will need to install the camera drivers located on the software CD (included).

To install the camera drivers:

- 1 Insert the software CD into the computer, and browse the contents on the CD.

- 2 Double-click the **USB Driver** folder, then double-click the USB Driver icon ().

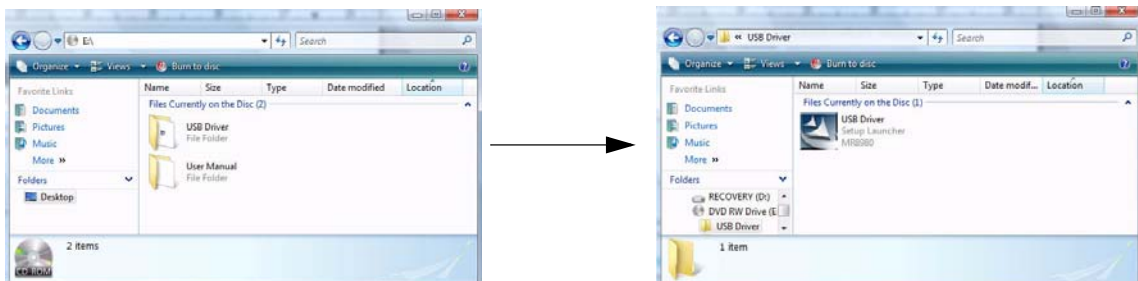

- 3 Follow the on-screen instructions to install the camera drivers.

Step 2 of 3: Creating a Skype account

A Skype account allows you to connect to your camera through using the Skype service. Skype is a service that allows users to make voice calls and video calls to anywhere in the world.

To create a Skype account:

- 1 Go to *www.skype.com*, and click on **Join Skype**.

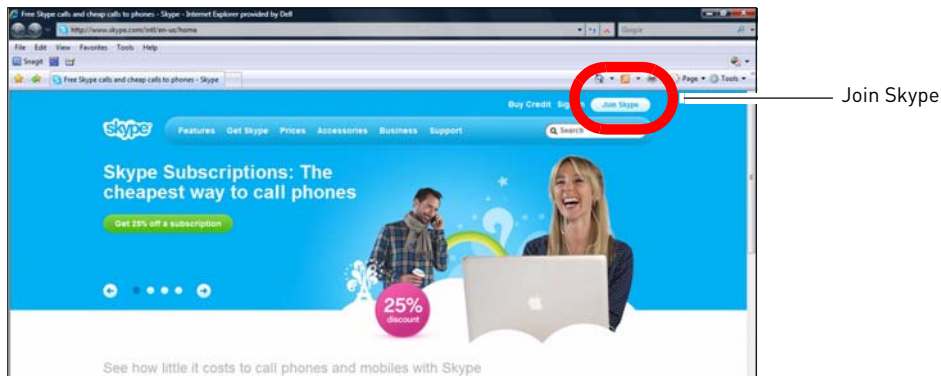

- 2 Click **Create Account**. Fill in the appropriate fields.

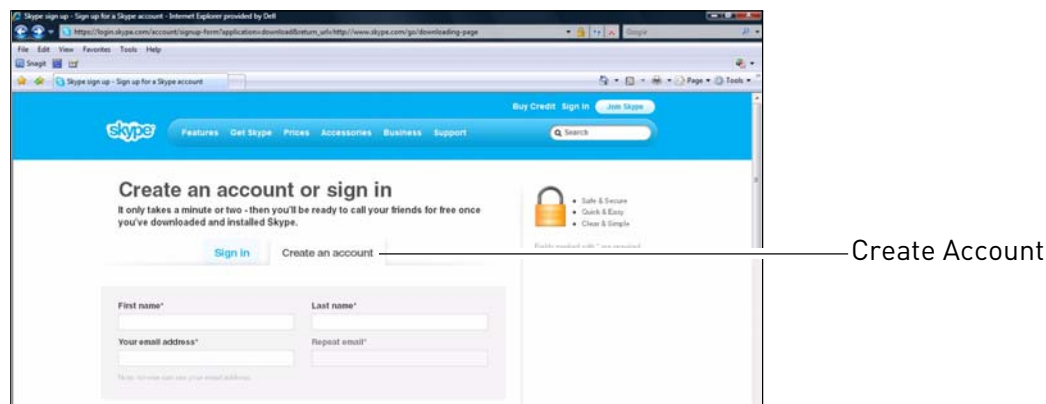

- 3 Click the **I Agree - Continue** button.



- 4 Follow the on-screen instructions to download and install Skype on your computer.



- 5 Repeat the process to make a second account. **You will need two accounts --- one for the camera, and one for yourself.**

Step 3 of 3: Connecting to your camera

Once you have created two Skype accounts, you are ready to connect to your camera.

Step 1: Connecting the video monitor to your computer

- 1 Connect the mini USB cable (included) to your video monitor and into the computer's USB port.

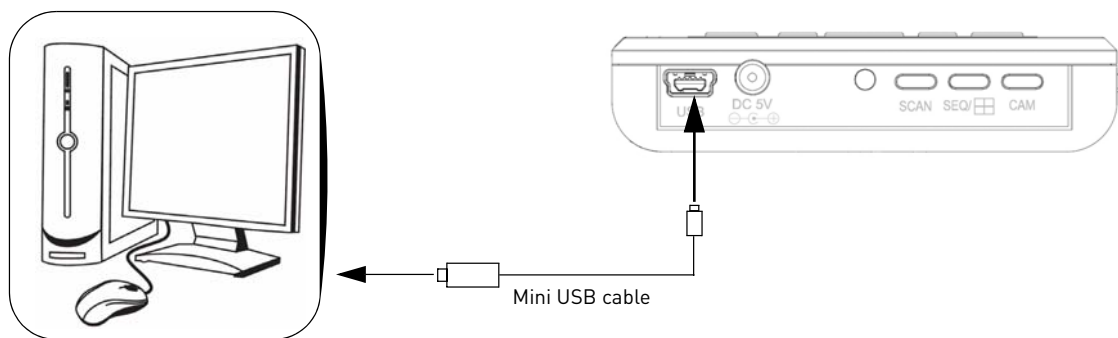

- 2 Turn on the video monitor and camera. The video monitor displays the following: "USB PC CAMERA MODE"

Step 2: Log in and configure your Skype account

- 1 Log in to your Skype account (for your camera) from the computer that is connected to your video monitor,
- 2 Click on **Tools**→**Options**.

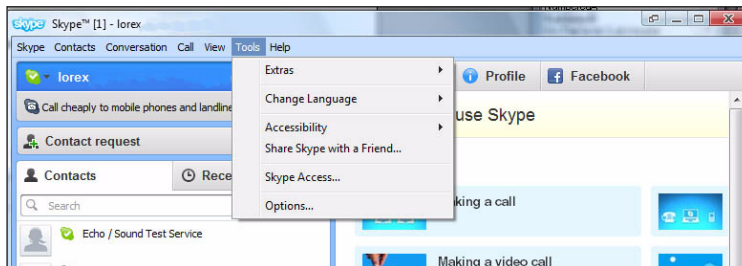

- 3 Click the **Calls** button ().
- 4 Select the "Answer incoming calls automatically" checkbox and the "Start my video automatically when I am in a call" check box.

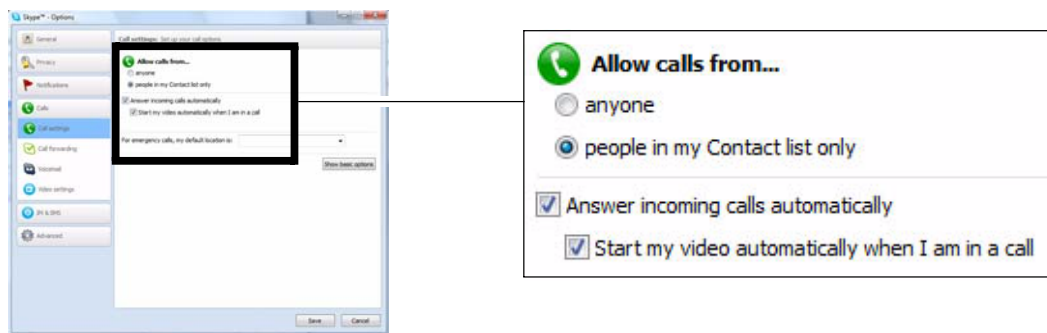

- 5 Click **Save**.

Step 3: Add your camera as a friend

This step requires you to log in to your personal Skype account from a different computer.

- 1 Log in to Skype using your personal account (this is different from your camera's account).
- 2 Click on **Contacts**→**Add a Contact**.
- 3 Beside the Skype Name field, enter the account name for your camera.

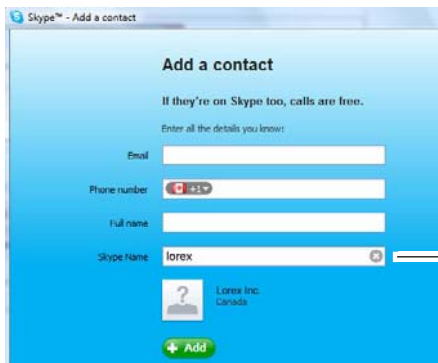

Enter the camera account name here

- 4 Click the **Add** button.

Step 4: Connect to your camera

After you have added your camera as a contact, you can connect to your camera.

To connect to your camera:

- From the contact list, right-click on your camera's account name, and click **Call**.
- The video call begins automatically.

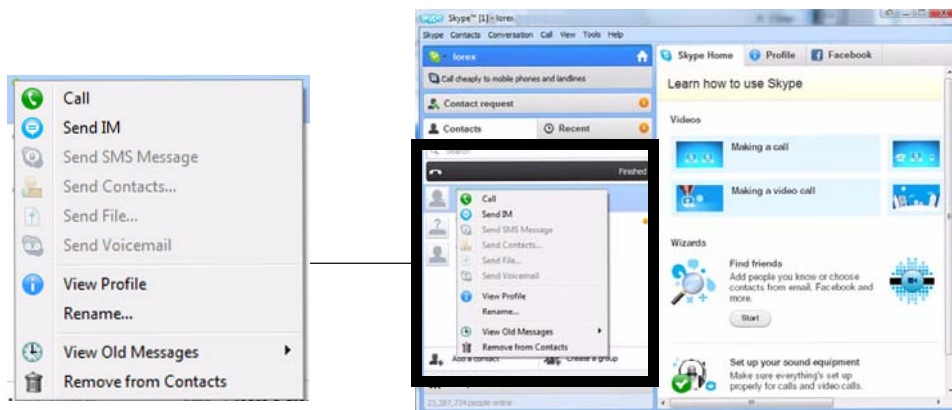

Changing the camera view

If you have more than one camera connected to your video monitor, you can specify which camera you want to connect to using Skype. You can only view one camera at a time. Viewing through Skype does not allow you to change cameras.

To change the camera view:

- 1 From your video monitor, press right on the joystick to change the camera number.
 - The camera number changes from "CAM 1" to "CAM 2".

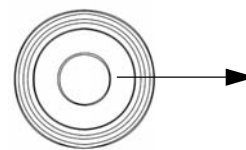

Press right on the joystick to change cameras.



Troubleshooting

Improving reception

No picture or sound on Monitor

Sound but no picture on monitor

picture but no sound

picture not clear

squealing

- get questions from summer infant handout

Tips on improving connection

FCC NOTICE:

This device complies with Part 15 of the FCC Rules. Operation is subject to the following two conditions: (1) this device may not cause harmful interference, and (2) this device must accept any interference received, including interference that may cause undesired operation.

FCC NOTE: THE MANUFACTURER IS NOT RESPONSIBLE FOR ANY RADIO OR TV INTERFERENCE CAUSED BY UNAUTHORIZED MODIFICATIONS TO THIS EQUIPMENT. SUCH MODIFICATIONS COULD VOID THE USER'S AUTHORITY TO OPERATE THE EQUIPMENT.

IC NOTE: LOW POWER DEVICES___RF Operation is subject to the following two conditions: (1) this device may not cause harmful interference and (2) this device must accept any interference, including interference that may cause undesired operation of the device." CLASS B OR A PRODUCTION This Class [B] digital apparatus complies with Canadian ICES-003.

CLASS B OR A PRODUCTION This Class [B] digital apparatus complies with Canadian ICES-003.

The antenna used for this transmitter must be installed to provide a separation distance of at least 20 cm from all persons and must not be co-located or operated in conjunction with any other antenna or transmitter.