

Portable Digital Wireless Baby Monitor UBR223 User's Guide

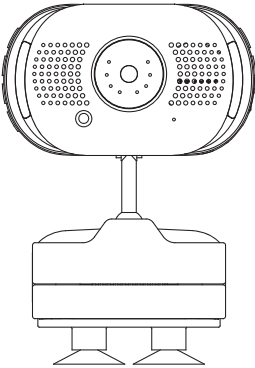

IMPORTANT SAFETY PRECAUTIONS

This manual contains important information about this product's operation. If you are installing this product for others, you must leave this manual or a copy with the end user.

When using your equipment, always follow basic safety precautions to reduce the risk of fire, electric shock and injury to persons, including the following:

- The camera is NOT weatherproof. It is an indoor camera
- To avoid any risk of electric shock from lightning, avoid handling any electronic devices (except battery-powered ones) during an electrical storm.
- Use only the power cord indicated in this manual.
- Never tug or pull on any power cord; be sure to leave some slack in the cord when placing your equipment, and always use the plug to unplug cord from the wall outlet.
- Never leave power cords where they can become crushed, cut, or frayed; when running power cords, avoid letting them rub against any sharp edges or lie across any high traffic areas where people might trip over them.
- Do not use the device if the adapter cords or plugs have been damaged, the monitor has been exposed to liquids, or the monitor/camera has been dropped or is damaged.





WARNING TO PARENTS AND OTHER USERS

Failure to follow these warnings and the assembly instructions could result in serious injury or death. This product is not designed or intended for use as a medical monitor, nor should this product be used as a substitution for medical or parental supervision. Always be sure that both the transmitter and receiver are working properly, and are within range of each other.

- STRANGULATION HAZARD. Keep the adapter cords out of the reach of children.
- WARNING: KEEP OUT OF THE REACH OF CHILDREN. This product is not a toy and is not intended for use by any children under the age of 13. If you are between the ages of 13 and 18, review these terms, conditions and safety warnings with your parents or guardian to make sure that you and your parent or guardian understand these terms, conditions, and safety warnings.
- Allow for proper ventilation when units are in use. Do not cover the camera or receiver with any object such as a blanket. Do not place it in a drawer or in any location which would muffle the sound or interfere with the normal flow of air.

SAVE THESE INSTRUCTIONS!

FOR BEST RESULTS

To avoid damage to your equipment, follow these simple precautions:

- Do not drop, puncture or disassemble any part of the equipment. There are no user-serviceable parts inside.
- Do not expose the equipment to high temperatures, and avoid leaving the equipment in direct sunlight for more than a few minutes. Heat can damage the case or electrical parts.
- Do not place heavy items on top of the equipment or expose the equipment to heavy pressure.
- Remove the power adapter during long periods between usages.
- Clean only with a dry cloth.

Failure to follow the instructions in this operating manual will void the warranty. Uniden assumes no liability for damages to property or injury to persons caused by improper handling or failure to comply with these safety instructions.

CONTENTS

OVERVIEW	5	VOX.....	25
FEATURES.....	5	CAMERA.....	26
Camera.....	5	Pair.....	26
Monitor	6	On/Off.....	27
USING THE MANUAL.....	6	POWER SAVE.....	28
GETTING STARTED.....	8	SPECIAL FEATURES.....	30
WHAT'S INCLUDED.....	8	ZOOM.....	30
MONITOR INSTALLATION.....	8	NIGHT LIGHT.....	30
CAMERA INSTALLATION.....	9	LULLABIES.....	30
Placement Considerations.....	9	USING THE INTERCOM.....	31
Wall Mount.....	9	CAMERA PAIRING.....	31
Suction Mount.....	10	MAINTAINING YOUR SYSTEM.....	32
Clip-Mount.....	10	MONITOR.....	32
Connect Power.....	10	CAMERA.....	32
BASIC OPERATION.....	11	SOLVING PROBLEMS.....	33
WIRELESS CAMERA.....	11	SPECIFICATIONS.....	34
WIRELESS MONITOR.....	13	GENERAL.....	34
LCD DISPLAY.....	15	CAMERA.....	34
USING THE UBR223.....	17	MONITOR.....	35
Viewing Modes.....	17	FCC Notices.....	35
Common Operations.....	18	FCC Compliance Information.....	35
SYSTEM MENU DESCRIPTIONS.....	19	RF Exposure Information.....	36
SYSTEM.....	19	IC Compliance Information.....	36
Date/Time.....	20	Radio Equipment Notice.....	36
Brightness.....	21		
Factory Reset.....	21		
Language.....	22		
Temperature Display Unit.....	22		
Temperature Alert Range.....	23		
ALERT.....	24		



OVERVIEW

FEATURES

- Digital wireless technology provides excellent image quality and clarity
- Interference free, secure, and private signal
- Up to 500 ft. transmission range

Maximum open space transmission range. The actual range varies depending on building materials and other obstructions in wireless signal path.

- Exceptional sound clarity
- Out of range notification
- Four lullaby selections
- Monitor/Camera-controlled night light
- System expandable up to 4 cameras (one camera included; additional cameras sold separately)
- Two-way audio communication
- Camera room temperature display on monitor; temperature range alert

Camera

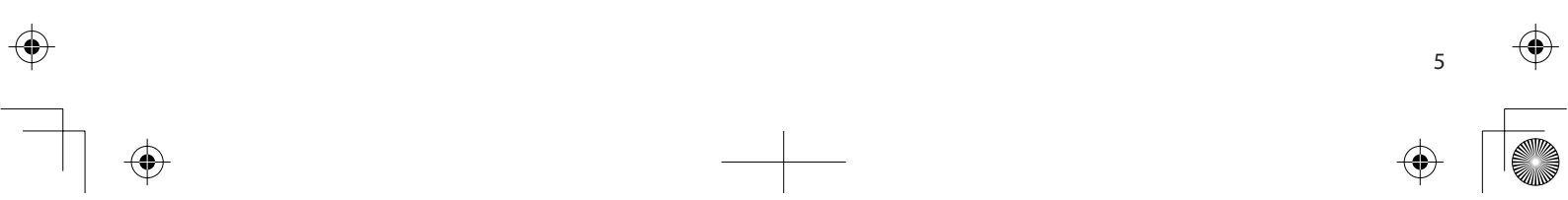
- VGA resolution camera
 - Built-in microphone
 - Night light control
 - Lullaby control
 - Built-in battery for true portable wireless operation
 - Night vision allows for low light viewing up to 15 feet / 4.5 meters
- 

IR illumination range of 15ft./4.5m under ideal conditions. Objects at or beyond this range may be partially or completely obscured, depending on the camera application.

Monitor

- 2.3" color LCD monitor with superior image quality
- Rechargeable lithium polymer battery for true portability
- Audio level indicator
- Intercom
- Room temperature display
- Remote night light control
- Remote lullaby control

***If any items are missing or damaged, contact our Customer Care Line immediately.
Never use damaged products!***

USING THE MANUAL

This manual is set up in eight sections:

- Overview. This general section lists the system's features. It also tells you how to use this manual.
- Getting Started. This section lists the hardware you should have in your box and how to set it up.
- Basic Operations. This section describes your equipment's function keys in detail. It also provides a list of basic operations in an abbreviated format, referencing screen details in the next section.
- UBR223 Screen Descriptions. Here you will find detailed descriptions of each screen and how it is used.
- Special Features. This section tells you about the UBR223 special features.



- **Maintaining Your System.** This section provides tips on how to keep your UBR223 hardware clean and in excellent working condition.
- **Solving Problems.** Troubleshooting tips are located here.
- **Specification.** This last section contains hardware and software specifications.



GETTING STARTED

WHAT'S INCLUDED

The system comes with the following components:

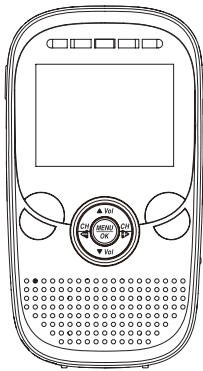

Digital Wireless Monitor (1)

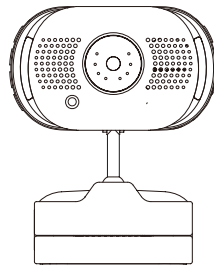

Digital Wireless Camera (1)

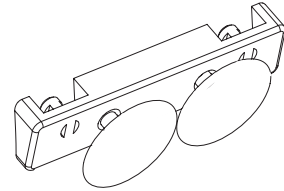

Suction Cup Adapter Bar (1)

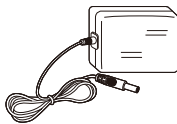

AC Power Adapter (2)

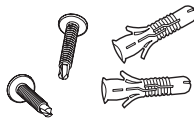

Screws and Anchors

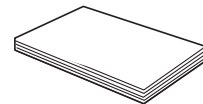

Owner's Manual

***If any items are missing or damaged, contact our Customer Care Line immediately.
Never use damaged products!***

MONITOR INSTALLATION

1. Place the monitor in a location with clear reception from your camera(s). Place it a minimum of 3 feet from the crib.
2. Plug the AC adapter power plug into the monitor's DC adapter input jack.

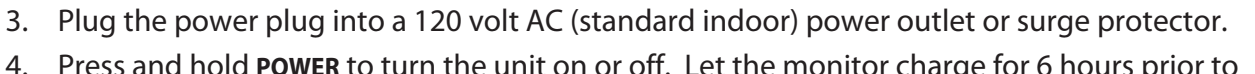
- 
- 
3. Plug the power plug into a 120 volt AC (standard indoor) power outlet or surge protector.
 4. Press and hold **POWER** to turn the unit on or off. Let the monitor charge for 6 hours prior to first time use so the built-in rechargeable monitor battery is fully charged. **DO NOT** remove the power cable from the monitor during the initial charge process. After the initial charge, recharge the monitor as needed.
 5. *Out of range* displays until you turn on the camera.

CAMERA INSTALLATION

The UBR223 camera and mounting clip are a complete unit. The UBR223 does come with a separate suction cup bar. With it installed, you can mount the camera on glass or smooth metallic surfaces.

Placement Considerations

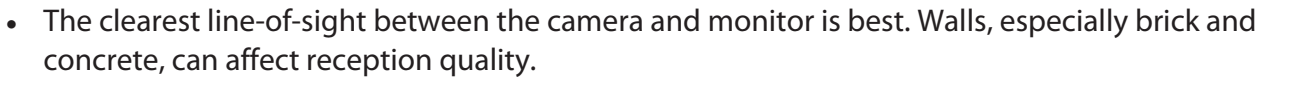
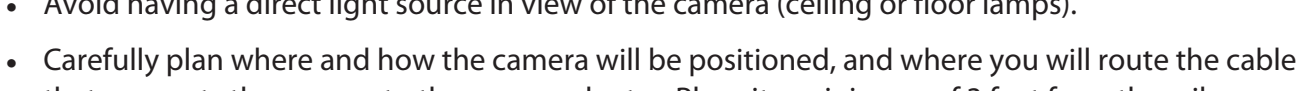
- 
- 
- The camera included with your monitor is **NOT** weatherproof; it is an indoor camera.
 - The clearest line-of-sight between the camera and monitor is best. Walls, especially brick and concrete, can affect reception quality.
 - Avoid having a direct light source in view of the camera (ceiling or floor lamps).
 - Carefully plan where and how the camera will be positioned, and where you will route the cable that connects the camera to the power adapter. Place it a minimum of 3 feet from the crib.
 - When you are positioning the camera, bring the monitor along; it's much easier to get the camera into the right position when you have the display handy. Check the image on the monitor before you install the camera.
 - *Out of range* displays when the camera is out of range.

You can install additional cameras (maximum of 4 cameras). When adding cameras that were not included in the original box, you will need to pair the cameras with the monitor. Refer to page 31.

Wall Mount

The UBR223 camera mounting clip has two slots that fit over screws to mount the unit on the wall.

1. Mark the position of the screw holes on the wall.
2. Drill holes and insert the anchors and screws provided.
Be sure to leave room for the mounting to fit over the screw heads.
3. Place the mounting over the installed screws and push it downwards, locking it into place.
4. Adjust the camera as needed.

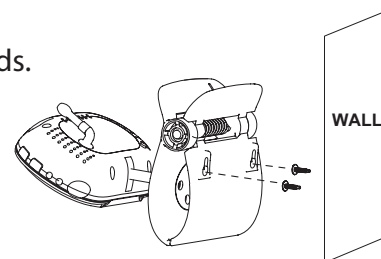

Suction Mount

1. Insert the suction base into the mounting clip as shown.
2. Firmly press the camera with the suction base attached onto glass or metallic surfaces.
3. Adjust the camera as needed.

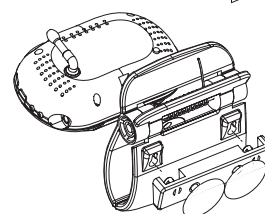

Clip-Mount

Clip the UBR223 on ledges and shelves.

1. Press the mounting clip as shown.
2. Place the unit over the mounting surface and release.
3. Adjust the camera as needed.

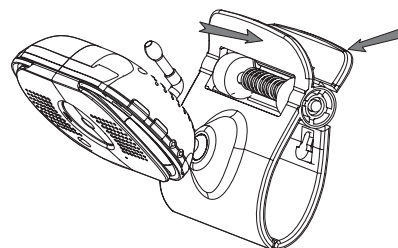

Connect Power

1. Insert the AC adapter power plug into the camera's DC adapter input jack.
2. Plug the other end into a 120 volt AC (standard indoor) power outlet or surge protector. The red charging LED turns on.
3. Press **Power**. The green power LED turns on and the monitor now displays camera video. If it doesn't, try reconnecting the AC adapter, making sure the power outlet isn't controlled by a wall switch.

BASIC OPERATION

WIRELESS CAMERA

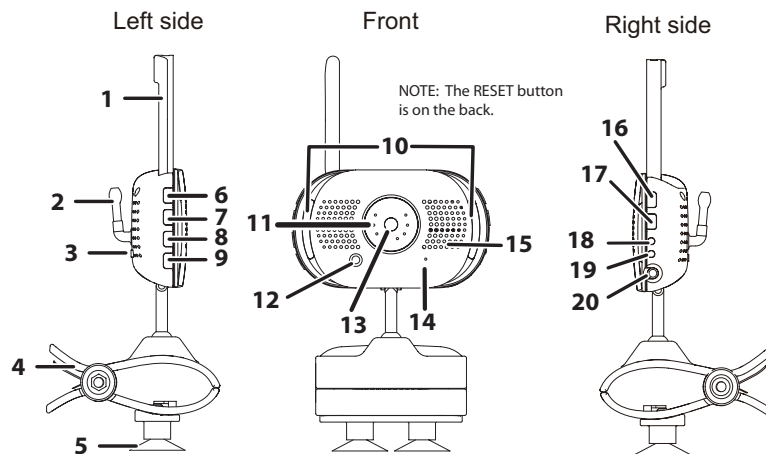

Item	What it is
1	Camera Antenna: Sends and receives signals to or from the monitor.
2	Temperature sensor: Detects temperature at camera side and displays it on the monitor LCD.
3	PAIR: Pairs the camera to the monitor.
4	Mounting Clip: This fastener can attach the camera to shelves or ledges.
5	Suction base: Attach to mount the camera on glass or metallic surfaces.
6	▲ Vol: Increase speaker volume.
7	▼ Vol: Decrease speaker volume.
8	LULLABY PLAY/STOP: Press this button to play lullabies. Press again to stop.
9	LULLABY SKIP: Press to play next lullaby.
10	LED night light bars.
11	IR LEDs (Covered): Infrared LEDs provide viewing in no/low light conditions.

Item	What it is
12	Light sensor: Measures light intensity on the camera side.
13	Lens: Camera lens.
14	Microphone: Receives sounds for the area near the camera, and transmits sound from the camera to the monitor.
15	Speaker: Produces the sound transmitted from the monitor.
16	POWER: Turns the camera ON or OFF.
17	NIGHT LIGHT: Press to turn the night light ON or OFF.
18	Charging LED: Red = Charging Green = Fully charged Off = Camera and power adapter are disconnected or power adapter is disconnected from power source.
19	Power LED: Green = Camera is turned on. Green (Blinking) = Battery is low.
20	DC 5V Power: Connects the DC 5V power adapter to the camera.

WIRELESS MONITOR

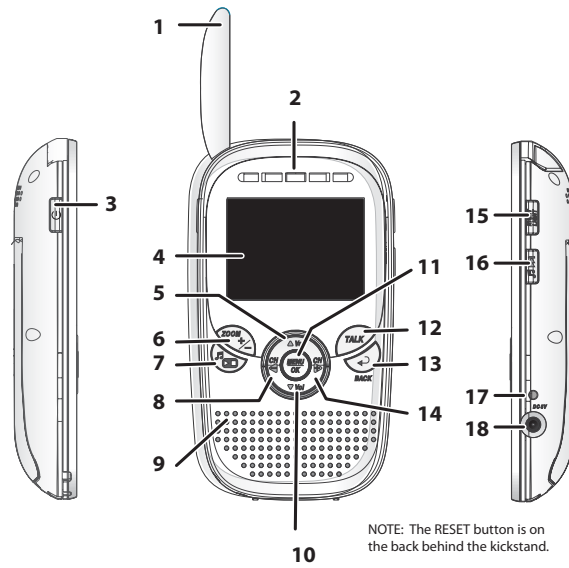







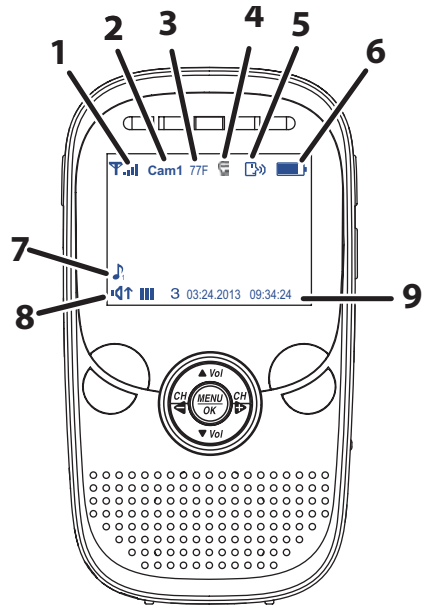















Item	What it is
1	Monitor Antenna: Sends & receives signals to or from the camera.
2	LED light bar.
3	POWER: Turns the camera on and off.
4	2.3 inch LCD screen.
5	▲ Vol: <ul style="list-style-type: none"> • Increase speaker volume. • In Menus: Scroll up. • In Lullaby: Increase volume. • In Zoom: Scroll up.
6	ZOOM: Displays the camera image in double size (see page 30).
7	LULLABY PLAY/STOP: Press this button to remotely play lullabies. Press again to stop.

Item	What it is
8	CH◀: <ul style="list-style-type: none"> • In Menus: Scroll left. • In Zoom: Scroll left. • In Live view: Switch between available cameras.
9	Microphone.
10	▼Vol: <ul style="list-style-type: none"> • Decrease speaker volume. • In Menus: Scroll down. • In Lullaby: decrease volume. • In Zoom: Scroll down.
11	MENU/OK: Select a menu option or accept a setting.
12	TALK: Activate Intercom function (see page 31).
13	BACK: In Menus: Back one level.
14	CH▶: <ul style="list-style-type: none"> • In Menus: Scroll right. • In Zoom: Scroll right. • In Live view: Switch between available cameras.
15	NIGHT LIGHT: Remotely turn the camera night light ON or OFF. <i>The monitor's night light function is only available when the camera is paired to the monitor.</i>
16	LULLABY SKIP: Skips to the next lullaby in the series.
17	Charge LED RED = Charging Green = Charging complete <i>If the monitor becomes unplugged from the adapter, this LED turns off.</i>
18	DC 5V Power: Connects the DC 5V power adapter to the monitor.

LCD DISPLAY



Item	Icon	What it is																		
1		<p>Signal Indicator (displays in full screen mode only). The number of bars in the signal indicator shows the strength of the signal received from the camera. One or no bars indicates the signal is poor, and 4 bars indicate a very strong signal.</p> <table border="1"> <thead> <tr> <th>Signal Strength</th> <th>Indicator</th> <th>Warning</th> </tr> </thead> <tbody> <tr> <td>Strong</td> <td></td> <td>None</td> </tr> <tr> <td>Good</td> <td></td> <td>None</td> </tr> <tr> <td>Fair</td> <td></td> <td>None</td> </tr> <tr> <td>Low</td> <td></td> <td>None</td> </tr> <tr> <td>No Signal</td> <td></td> <td>Out of Range</td> </tr> </tbody> </table>	Signal Strength	Indicator	Warning	Strong		None	Good		None	Fair		None	Low		None	No Signal		Out of Range
Signal Strength	Indicator	Warning																		
Strong		None																		
Good		None																		
Fair		None																		
Low		None																		
No Signal		Out of Range																		
2	Cam1	<p>Camera Indicator. indicates which camera is displaying. Press CH▶ or CH◀ on the monitor to switch between available cameras. It will cycle in the following order:</p> <p>CH▶ : CAM1—CAM2—CAM3—CAM4—QUAD—AUTO SCAN — CAM1</p> <p>CH◀ : CAM1—Auto SCAN—QUAD—CAM4—CAM3—CAM2—CAM1</p>																		
3	77F	Temperature indicator (displays in full screen mode only). Displays the temperature on the camera side.																		
4		Night light indicator (displays in full screen mode only). Displays when the night light is turned on. (See page 30)																		
5		Intercom (Talk). Displays in full screen mode only when you press and hold TALK on the monitor (see page 31).																		
6		Battery level. Indicates the amount of power left in the battery. The  icon displays when the battery is charging.																		

Item	Icon	What it is
7		Lullaby. Displays in full screen mode only when a lullaby is playing. The number indicates which melody is playing (see page 30). <ol style="list-style-type: none"> 1. Rock-a-Bye Baby 2. Twinkle Twinkle 3. Golden Slumbers 4. Ocean Sounds with Heartbeat
8		Volume indicator. Displays when ▲Vol or ▼Vol is pressed on the monitor.
9		Date and Time (displays in full screen mode only). Displays the time as set through the monitor. 01.02.2013 12:26:00 = month.day.year hour:minute:second

If you press ZOOM, X2 displays where the Volume Indicator (item 8) is on the graphic. The zoomed image displays as the background image.

USING THE UBR223

Viewing Modes

Live view displays live images from the cameras in the following modes:

- Quad mode: Monitor displays video from all cameras on a single screen in 4 quadrants. Any channel that does not have a camera is blank.
- Single mode: Monitor displays video from one camera at a time.
- Scan mode: Monitor displays video from one camera at a time, but cycles through all cameras one by one.

Use **CH▶** or **CH◀** to cycle through these modes.

Your system comes with a single camera; therefore, it only displays in Single mode in Live view or a single quadrant in Quad view.

Common Operations

To...	Do This...
Change between quad view, single view, and scan for Live view	Press CH▶ to cycle through the Live modes in the following order: CAM1—CAM2—CAM3—CAM4—QUAD—AUTO Scan — CAM1
Check the temperature	The temperature displays on the monitor screen when the camera is in full screen mode. See page 22.
Turn on the night light	Press NIGHT LIGHT on the side of the camera (page 11) or on the monitor (page 13). See page 30 for details.
Set the date and time	See page 20.
Set the room temperature range for the temperature alert	See page 23.
Use the Lullaby function	See page 30.
Adjust UBR223 volume	Press ▲Vol (increase volume) or ▼Vol (decrease volume) on either the camera or the monitor.
Use the Intercom	<ol style="list-style-type: none">1. Press and hold TALK on the monitor.2. Speak into the microphone.3. Release to hear reply.

SYSTEM MENU DESCRIPTIONS

Press **MENU/OK** to access system menus. Use the navigating buttons to navigate up (**▲Vol**), down (**▼Vol**), left (**CH◀**), and right (**CH▶**) in the menus, then press **MENU/OK** to confirm a setting. Use **CH▶** or **CH◀** to focus on the 5 different system menu selections on the clothesline.

- System
- Power Save
- Camera
- VOX
- Alert

SYSTEM

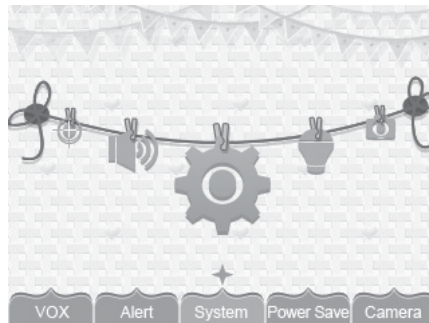

Move the focus to the System option and press **MENU/OK** to access the six System options:

- Date/Time
- Brightness
- Factory Reset
- Language

- Temp. display unit
- Temp. alert range

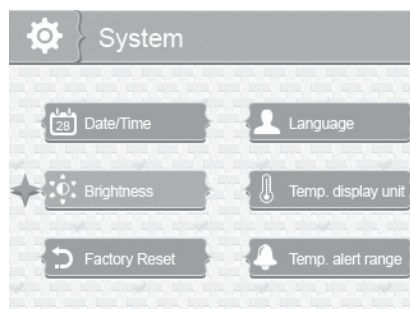

Date/Time

This option allows you to set the system date and time. The display format is Month.Day.Year Hour:Minute (Default = 01.02.2013 12:26)

1. From the *System* menu, select *Date/Time* and press **MENU/OK**. The *Date/Time* screen displays.

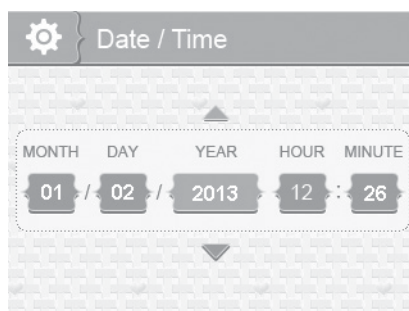

2. Press **▲Vol** or **▼Vol** to increase/decrease the number for that setting.
3. Press **CH▶** or **CH◀** to save the current setting and move to the next setting.
4. Press **MENU/OK** to save the completed date and time setting and return to the main System options.

Brightness

This option allows you to adjust the brightness level for each camera. (Default = 3)

1. From the *System* menu, select *Brightness* and press **MENU/OK**. The *Brightness* screen displays.

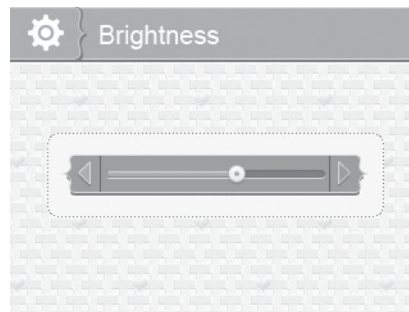

2. Press **CH▶** or **CH◀** to increase or decrease the brightness level (6 levels).
3. Press **MENU/OK** to save the setting and return to the main *System* options. The new brightness level displays the next time you are in Live view.

Factory Reset

This option allows you to restore your system to factory settings. (Default = No)

1. From the *System* menu, select *Factory Reset* and press **MENU/OK**. The *Factory Reset* screen displays.



2. Press **▲Vol** or **▼Vol** to select or cancel a reset to factory defaults.

3. Press **MENU/OK** to save the setting and return to the main System options.

Camera pairing settings and Date/Time setting will NOT be affected by a reset. Cameras will remain paired with the monitor.

Language

This option allows you to select the system's display language from English, Español, or Français. (Default = English)

1. From the *System* menu, select *Language* and press **MENU/OK**. The *Language* screen displays.

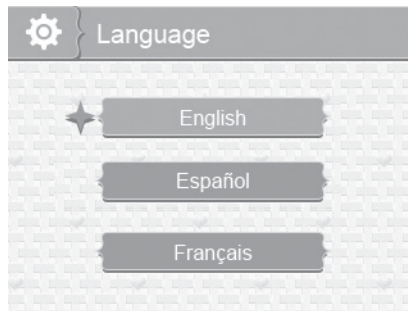

2. Press **▲Vol** or **▼Vol** to select a language.
3. Press **MENU/OK** to save the setting and return to the main System options.

Temperature Display Unit

This option allows you to set the temperature to display in Celsius (C) or Farenheit (F). (Default = F)

1. From the *System* menu, select *Temp. display unit* and press **MENU/OK**. The *Temp. display unit* screen displays.

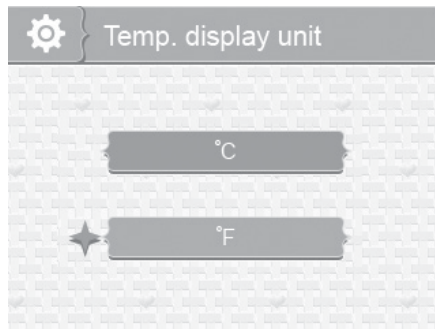

2. Press **▲Vol** or **▼Vol** to select °C or °F.
3. Press **MENU/OK** to save the setting and return to the main System options.

Temperature Alert Range

Your UBR223 measures the ambient room temperature where the camera is. If the temperature falls outside of a preset range, the system alerts you. *Temp. alert range* lets you set that range. [Default = Low Temperature: 61 °F ; High Temperature; 77 °F; Off]

1. From the *System* menu, select *Temp. alert range* and press **MENU/OK**. The *Temp. alert range* screen displays.

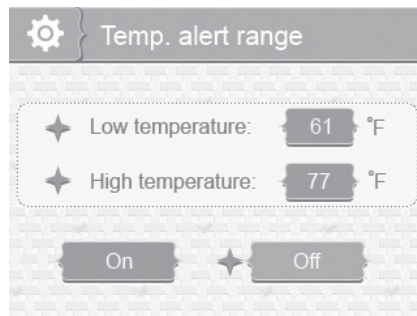

2. Press **CH▶** or **CH◀** to select *Low temperature* or *High temperature*.
3. Press **▲Vol** or **▼Vol** to increase or decrease the temperature value.
4. After setting the temperature range, press **CH▶** or **CH◀** to select the *On/Off* row.

5. Press **CH▶** or **CH◀** to toggle between *On* (Enable) or *Off* (disable). Either button will work.
6. Press **MENU/OK** to save the settings and return to the main System options.

ALERT

Temperatures out of range or a camera out of range triggers alerts. This option allows you to set the alert volume. There are 6 levels available. [Default = Zero (Mute)]

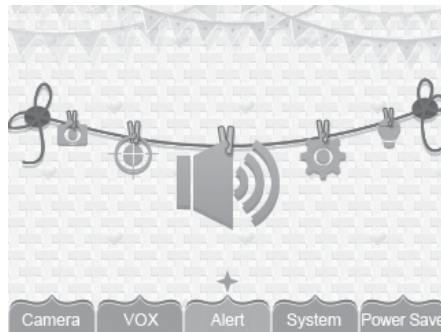

1. From the main menu selections, select *Alert* and press **MENU/OK**. The *Alert* screen displays.

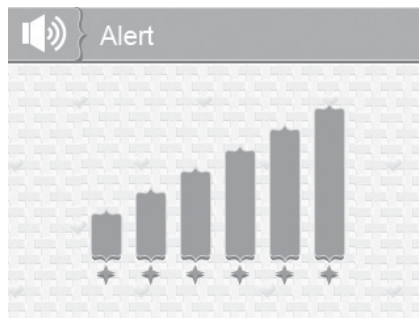

2. Press **CH▶** or **CH◀** to adjust the volume.
3. Press **MENU/OK** to save the selection and return to the main menu selections.

VOX

This option allows you to set the sound sensitivity for the camera. (Default = High)



1. From the main menu selections, select *VOX* and press **MENU/OK**. The *VOX* sensitivity screen displays.

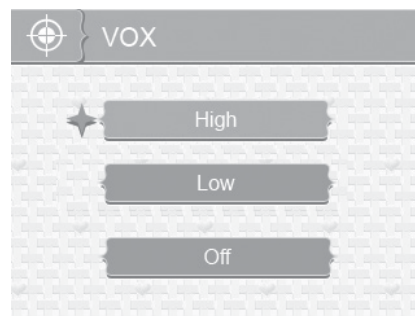

2. Press **▲Vol** or **▼Vol** to select a level (*High, Low, or Off*).
3. Press **MENU/OK** to save the selection and return to the main menu selections.

CAMERA

This option allows you to pair the monitor with cameras (up to 4 cameras supported) or to turn on/off an individual camera. The cameras are still powered on but no longer visible to the monitor.



1. From the main menu selections, select *Camera* and press **MENU/OK**.
2. The *Camera* options screen displays. Two options display: *Pair* and *On/Off*.

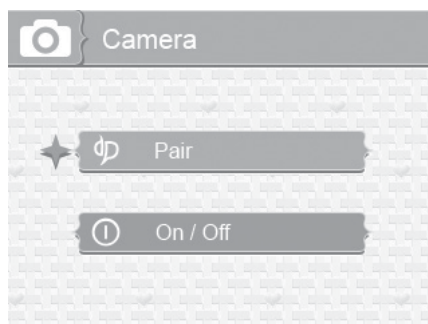

Pair

Pairing allows you to introduce additional cameras to the monitor. The monitor can then recognize and display video from them. The camera that comes with this system is already paired.

Before pairing additional cameras, be sure they are powered and turned on. See page 10.

1. Select *Pair* from the *Camera* options screen. The camera selection screen displays.



2. Press **▲Vol** or **▼Vol** to select the camera you want to pair, then press **MENU/OK**. The monitor prompts you to press **PAIR** on the back of the camera within 30 seconds.
3. Press **PAIR** on the back of the camera within 30 seconds.
4. That camera's video displays on the monitor when pairing is successful.

Pair the cameras to the monitor before mounting them.

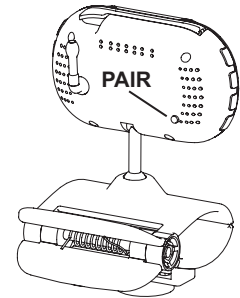

On/Off

This option allows you to turn individual cameras on/off so their video is not visible through the monitor. (Default = Camera 1 - On; Cameras 2 - 4 - Off)

1. Select *On / Off* from the *Camera* options screen. The *On / Off* screen displays.

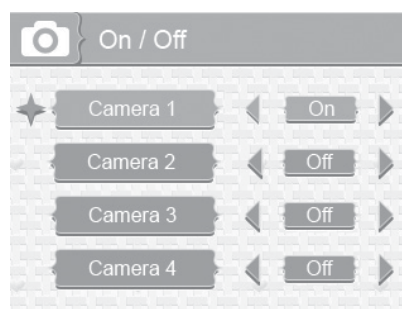

2. Press **▲Vol** or **▼Vol** to select a camera.
3. Press **CH▶** or **CH◀** to toggle between *On* and *Off* for that camera. Either button will work.
4. Press **▲Vol** or **▼Vol** to select another camera.
5. Press **MENU/OK** to accept that setting and return to the *Camera* options screen.

POWER SAVE

Activating the Power Save feature turns off the LCD after two minutes of inactivity. This option allows you to enable or disable this function. (Default = On)

Voice Activation (VOX) will turn the LCD back on. Be sure that VOX is activated, however (see page 25). If VOX is deactivated, press any button on the monitor to turn the LCD back on. Even with the LCD off, the LED light bar is still active.

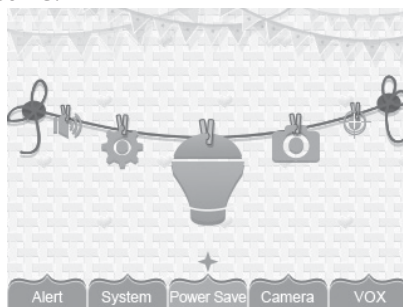

1. From the main menu selections, select *Power Save* and press **MENU/OK**. The *Power Save* screen displays.

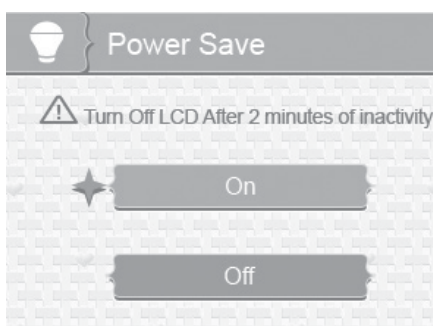



2. Press **▲Vol** or **▼Vol** to toggle between turning the Power Save feature on or off.
3. Press **MENU/OK** to accept that setting and return to the main menu selections.





SPECIAL FEATURES



ZOOM

ZOOM displays the camera image in double size. Press **▲Vol**, **▼Vol**, **CH▶**, or **CH◀** to see the parts of the image not displayed on the LCD screen. Press **ZOOM** again to return to normal view.

NIGHT LIGHT

You can control the UBR223 night light using the **NIGHT LIGHT** button on the right side of either the monitor or the camera. However, if you want to control it from the monitor, you must place that camera in full screen mode.

1. To turn the night light on from the monitor, place the night light camera in full screen mode.
2. Press **NIGHT LIGHT** on the side of the monitor or the camera. The camera's night light turns on and a night light icon displays on the monitor.
3. Press **NIGHT LIGHT** again to turn it off.



LULLABIES



Your system comes with four preprogrammed lullabies:

- Rock-a-Bye Baby
- Twinkle, Twinkle Little Star
- Golden Slumbers
- Ocean Sounds with Heartbeat

You can control the lullabies from either the monitor or the camera. However, if you want to control them from the monitor, the camera you want to play them through must be in full screen mode.

The system plays all lullabies and then repeats until you turn off the feature.

1. To control the lullabies from the monitor, decide which camera you want to play lullabies and make it the full screen live view camera.

2. Press **LULLABY PLAY/STOP** on the monitor or camera. The system plays all lullabies and then repeats until you turn off the feature (press **LULLABY PLAY/STOP** again.)
3. Press **LULLABY SKIP** to skip to the next lullaby.
4. Press **▲Vol** and **▼Vol** on the monitor or camera to adjust the volume. Press **▼Vol** all the way down on the monitor to mute the lullaby playing through the monitor.

USING THE INTERCOM

The Intercom feature lets you talk to whomever is within camera range.

1. Decide which camera you want to establish an intercom link with, and make it the full screen live view camera.
2. Press and hold **TALK** the monitor.
3. Speak clearly into the microphone.
4. Release **TALK** to listen to the response.

CAMERA PAIRING

The system comes with one camera that has already been paired. It will communicate with the monitor when it is powered on.

The pairing function lets you add up to 3 additional cameras to your system. It also lets you re-pair your first camera if needed.

Pair the cameras to the monitor before mounting the cameras.

1. Verify that the monitor is powered on (see page 10).
2. Install and power on the accessory cameras according to the procedures beginning on page 8.
3. Pair the accessory cameras according to the procedures on page 26.
4. Once the camera has been paired, it will be immediately viewable on the monitor.



MAINTAINING YOUR SYSTEM



MONITOR

As you use your monitor, keep the screen clean by wiping it with a microfiber cloth to remove fingerprints, dust, etc.

CAMERA

When dust and grime builds up on the camera lens and glass, it affects the camera's "vision." Use a microfiber cloth to regularly clean the camera(s) or when night vision video is cloudy or unclear.

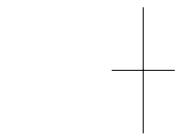
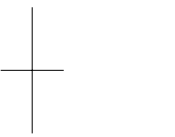

SOLVING PROBLEMS

If you have problems with the system, there is often a quick and simple solution. Please try the following:

If	Try
There is no picture from the camera	<ul style="list-style-type: none">• checking all connections to the camera. Make sure the adapter is plugged in.• making sure that the cameras and monitor are both ON.• making sure that the camera is in range of the monitor.
The picture is dropping	<ul style="list-style-type: none">• moving the camera closer to the monitor.• repositioning the camera, monitor or both to improve the reception.• adjusting the monitor and camera antennas to vertical position.
There are audio problems	<ul style="list-style-type: none">• making sure that there is sound within range of the camera microphone.• moving the camera or monitor farther apart if the unit emits a loud screeching noise (feedback).
The picture has become choppy	<p>The picture may become choppy when experiencing a lower frame rate. Try:</p> <ul style="list-style-type: none">• moving the camera closer to the monitor.• removing obstructions between the monitor and camera.• adjusting the monitor and camera antennas to vertical position.
The monitor picture has frozen	<p>Use a blunt object like an unbent paper clip to press RESET and reset the monitor. The monitor turns off. Press POWER to turn it back on again.</p>
There is an irregular beeping coming from the monitor	<p>That is the Alert tone. Go to the Alert screen to turn the alert volume down or off (see page 24).</p>

SPECIFICATIONS

GENERAL

	Camera	Monitor
Operating Frequency Range	2.400 ~ 2.4835GHz	
TX Power	15dBm	NA
RX Sensitivity	NA	-81dBm
Type of Spread Spectrum Used	FHSS	
Type of Modulation Used	GFSK	
Communication Range	500ft. Line of Sight	

CAMERA

Image Sensor Type

Manufacturer/ Model # 1/6.5" Color CMOS Image sensor

Effective Pixel	640 x 480
Image Processing	MJPEG
Lens	3.0mm / F2.8
Exposure	Auto
White Balance	Auto
Power Requirement	5.0VDC +/-5%
Power Consumption	150mA Max (IR OFF) 730mA Max (IR ON) 440mA Max (Charging)
Operating Temperature Range	14° F ~ 104° F (-10° C ~ 40° C)
Operating Humidity Range	Within 80% RH
RoHS Compliance	Yes
Housing Material	Plastic

MONITOR

Display Size/Type	2.3" TFT LCD
Resolution	320 x 240
Power Requirement	5.0VDC +/-5%
Power Consumption	130mA Max (Normal) 570mA Max (Charging)
Operating Temperature Range	14° F ~ 104° F (-10° C ~ 40° C)
Operating Humidity Range	Within 85% RH
RoHS Compliance	Yes
Battery Life	4.5 hours
Housing Material	Plastic

FCC Notices

FCC Compliance Information

Part 15 Compliance Statement

This device complies with Part 15 of the FCC Rules. Operation is subjected to the following two conditions: (1) this device may not cause harmful interference, and (2) this device must accept any interference received, including interference that may cause undesired operation. Privacy of communication may not be ensured when using this device.

This equipment has been tested and found to comply with limits for a Class B digital device, pursuant to Part 15 of the FCC rules and ETSI (EN) 300328. These limits are designed to provide reasonable protection against harmful interference in residential installations. This equipment generates, uses, and can radiate radio frequency energy, and if not installed and used in accordance with the instructions, may cause harmful interference to radio communications.

However, there is no guarantee that interference will not occur in a particular installation. If this equipment does cause interference to radio or television equipment reception, which can be determined by turning the equipment off and on, the user is encouraged to try to correct the interference by one or more of the following measures:

- Reorient or relocate the receiving antenna.
- Move the equipment away from the monitor.
- Plug the equipment into an outlet on a circuit different from that to which the monitor is connected.
- Consult the dealer or an experienced radio/television technician for additional suggestions.

CAUTION! Any changes or modifications to this equipment not expressly approved by the party responsible for compliance could void your authority to operate the equipment.



RF Exposure Information

The antenna used for this transmitter must be installed to provide a separation distance of at least 20 cm (7.9") from all persons and must not be collocated or operating in conjunction with any other antenna or transmitter.

IC Compliance Information

Radio Equipment Notice

The term "IC:" before the radio certification number only signifies that Industry Canada technical specifications were met. Operation is subject to the following two conditions: (1) this device may not cause interference, and (2) this device must accept any interference, including interference that may cause undesired operation of the device. "Privacy of communications may not be ensured when using this device".



